



UNITED
NATIONS

EP

UNEP/MED WG.509/43



**Mediterranean
Action Plan**
Barcelona
Convention

30 December 2021
English Only

Meeting of the MED POL Focal Points

Teleconference, 27-28 May and 6-7 October 2021

Report of the Meeting

For environmental and cost-saving reasons, this document is printed in a limited number. Delegates are kindly requested to bring their copies to meetings and not to request additional copies.

Table of Contents

	Pages
1. Report of the Meeting	1-19
2. Annex I List of Participants	1-11
3. Annex II Agenda of the Meeting	1-2
4. Annex III Conclusions and Recommendations	1-5

Report of the Meeting

Introduction

1. In accordance with the United Nations Environment Programme/Mediterranean Action Plan (UNEP/MAP), Programme of Work 2020-2021 adopted by the 21st Ordinary Meeting of the Contracting Parties to the Barcelona Convention and its Protocols (Napoli, Italy, 2-5 December 2019), the UNEP/MAP Secretariat organized the MED POL Focal Points Meeting via videoconference in two parts: Part I convened with an initial session on 27-28 May and a resumed session on 9 July 2021. Part II of the meeting was held on 6-7 October 2021. The 5-day duration of this two-part meeting was deemed to be required to address all agenda items for its smooth running.

2. The objective of the MED POL Focal Points Meeting was to review the progress on the implementation of PoW activities carried out during the 2020-2021 biennium, and the status of implementation of the pollution-related Protocols of the Barcelona Convention including its monitoring and assessment aspects which are under the MED POL Programme responsibility. This includes the updated annexes of the LBS and Dumping Protocols; the three Regional Plans for Wastewater Treatment, Sewage Sludge Management and the Updated Marine Litter Management Plan; the Mid-Term evaluation of the Implementation of the National Action Plans; implementation of IMAP for Pollution and Litter cluster including harmonization and standardization of IMAP pollution cluster monitoring, and cross-cutting issues related to integration and aggregation rules for IMAP Ecological Objectives 5, 9 and 10, as well as assessment criteria for contaminants, nutrients and marine litter. The Meeting is also planned to review several technical guidelines to support the sound marine pollution assessment of levels and loads addressing both LBS and Dumping Protocols-related activities.

3. Part I of the MED POL Focal Points Meeting, including the initial session on 27 and 28 May and the resumed session on 9 July, cover agenda items which will be submitted to the MAP Focal Points and ECAP Coordination Group Meetings. Part II of the meeting held on 6 and 7 October 2021 addresses all remaining agenda items.

Participation

4. The Meeting was attended by representatives from the following Contracting Parties: Albania, Algeria, Bosnia and Herzegovina, Croatia, Cyprus, Egypt, European Union, France, Greece, Israel,¹ Italy, Lebanon, Libya, Malta, Monaco, Montenegro, Morocco, Slovenia, Spain, Tunisia and Turkey. The United Nations Environment Programme (UNEP), including the Mediterranean Action Plan/Barcelona Convention Secretariat (UNEP/MAP) were also represented, along with the following Mediterranean Action Plan Components: the Mediterranean Pollution Assessment and Control Programme (MED POL); the Specially Protected Areas Regionally Activity Center (SPA/RAC); the Regional Activity Centre for Sustainable Consumption and Production (SCP/RAC); and Plan Bleu Regional Activity Centre. The Meeting was also attended by the Secretariat of the Basel, Rotterdam and Stockholm Conventions (BRS); the Regional Organization for Conservation of the Environment of the Red Sea & Gulf of Aden (PERSGA); the International Maritime Organization (IMO); the International Atomic Energy Commission (IAEA); the Economic and Social Commission for Western Asia (ESCWA); UNEP Regional Office for Western Asia (UNEP/ROWA); the Secretariat of the Pacific Regional Environment Programme (SPREP); and the European Environment Agency (EEA).

5. The following non-governmental organizations and other institutions were represented: the Hellenic Centre for Marine Research/ Institute of Oceanography (HCMR); the Mediterranean Information office for Environment, Culture and Sustainable Development (MIO-ECSDE); the

¹ Israel was not present in the resumed session on 9th of July 2021

International Union for Conservation of Nature (IUCN); PlasticsEurope; the World Wide Fund For Nature (WWF Mediterranean); the Hellenic Marine Environment Protection Association (HELMEPA); the Centre International de Droit Comparé de l'Environnement (CIDCE); the Egyptian Sustainable Development Forum (ESDF); the Egyptian Youth Ambassadors; Grid-Arendal; and the “association de la continuité des générations” (ACG).

6. The full list of participants is attached as Annex I to the present report.

Agenda item 1: Opening of the Meeting

7. The initial session of the meeting was opened at 10:00 AM (EST) on 27 May 2021 by the Deputy Coordinator of the United Nations Environment Programme/ Mediterranean Action Plan - Barcelona Convention, Ms. Tatjana Hema. She provided a summary overview of work undertaken by MED POL in the biennium 2021-2022; explaining the importance of externally funded projects that are based on, and complement, activities in the Programme of Work for this biennium. She stressed the support provided to the Contracting Parties including technical meetings convened and related documents produced, explaining at the same time the institutional and decision-making process of relevance to the Meeting for approval of these documents. She provided information on the decisions under preparation by MED POL, noting the updated annexes to the LBS and Dumping Protocols and the three Regional Plans, planned for submission to COP 22 for adoption. Mr. Mohamad Kayyal, MED POL Programme Management Officer, gave a brief overview of the documents to be discussed under each agenda item, and introduced the MED POL team who will deliver the presentations of each of these documents.

8. The resumed session of Part I of the Meeting convened on 9 July at 10:00 AM. It was opened by the Chair of the Meeting, Ms. Marta Martinez-Gil Pardo de Vera. She gave a brief recap of decisions reached in the initial session. She also highlighted the remaining agenda items to be addressed during the resumed session. The MED POL Programme Management Officer provided an overview of remaining documents to be discussed during this resumed session and related agenda items.

9. Part II of the meeting convened on 6 and 7 October at 10:00 AM. The Meeting was opened by the Chair, Ms. Marta Martinez-Gil Pardo de Vera. She presented an overview of remaining agenda items not covered in Part I of the meeting. The MED POL Programme Management Officer explained the scope of documents to be addressed focusing on the monitoring guidelines/protocols for IMAP Common Indicators; the common methodologies on estimation techniques for the National Baseline Budget (NBB) of pollutants; assessments for the preparation of three new regional plans for the biennium 2022-2023; and methodologies and techniques for the assessment and monitoring of adverse impacts of dumping activities.

Agenda item 2: Election of Officers

a) Election of Officers

10. Subject to Rule 20 of the rules of procedure mentioned at para. 2(a) for meetings and conferences of the Contracting Parties, the Meeting elected one (1) President, three (3) Vice Presidents and one (1) Rapporteur from among the participants, as follows:

Chair:	Ms. Marta Martinez-Gil Pardo de Vera, Spain
Vice-Chair:	Mr. Mohamed Elbouch, Morocco
Vice-Chair:	Mr. Konstantinos Antoniadis, Cyprus
Vice-Chair:	Ms. Klodiana Marika, Albania
Rapporteur:	Ms. Marwa El Mokdad, Lebanon

Agenda item 3: Organizational matters and adoption of the agenda*a) Rules of Procedure for the Meeting*

11. The Rules of Procedure for Meetings and Conferences of the Contracting Parties to the Convention for the Protection of the Marine Environment and the Coastal Region of the Mediterranean and its Protocols was applied mutatis mutandis to the present meeting (UNEP/IG.43/6, Annex XI).

b) Adoption of the Provisional Agenda

12. Subject to Rule 14 of the Rules of Procedure mentioned at para. 2(a), the proposed agenda appearing in document UNEP/MED WG.509/1 and annotated in document UNEP/MED WG.509/2 was reviewed during the initial session on 27 May 2021. Turkey raised observation to Working Document UNEP/MED WG.509/10 and Information Document UNEP/MED WG.509/Inf.14 requesting their withdrawal from the list of documents of the meeting. The Meeting requested clarifications regarding the issues of concern in both documents. Turkey pointed out to the issue of certain maps which contain information to which they do object, in addition to the use of some terms and reference material. Further to this clarification, the Meeting agreed for the Secretariat to amend working document UNEP/MED WG.509/10; withdraw information document UNEP/MED WG.509/Inf.14 from the list of documents; and prepare an updated list of documents and revised annotated agenda. The Secretariat distributed the aforementioned documents in the same session after the first break. The Meeting adopted the revised annotated agenda as appended in Annex II to the present document.

13. During the resumed session on 9 July, a Contracting Party requested clarifications on the reason why document UNEP/MED WG.509/Inf.14 was withdrawn in the initial session. The Coordinator taking the floor recalled the discussion held during the first session of the meeting noting that this decision was taken during the adoption of the agenda. The Coordinator also acknowledged that the report of the meeting will provide information on this issue. The Chair reiterated also that this decision was made in the initial session on 27 May to withdraw document UNEP/MED WG.509/Inf.14 from the list of documents.

c) Organization of Work

14. The discussions were held in plenary sessions for the entire meeting. Three sessions were planned daily from 10:00 to 12:00, 13:00 to 15:00, and 15:30-17:30, with two mid-day breaks.

15. Simultaneous interpretation in English and French was available for all sessions. All documentation was available in English and French. Participants were encouraged to download the documentation onto their computers in advance of the session. The meeting was recorded for future reference.

16. The Meeting addressed in the “initial session” of Part I of the Meeting on 27 and 28 May agenda items: 1, 2, 3, 5, 6 as well as 9 as detailed in Annex II. For the “resumed session” on 9 July, the Meeting covered agenda items 7 and 8 followed by agenda item 4. During Part II of the Meeting on 6 and 7 October, remaining agenda items 12 through 15 were discussed.

17. At the end of each session of Part I and Part II of the meeting, the meeting addressed agenda items “any other business” and the agenda items “conclusions and recommendations”, respectively.

18. Conclusions and recommendations of the MED POL Focal Points Meeting as adopted are appended in Annex III to this document.

Agenda item 4: Progress achieved regarding implementation of the Programme of Work 2020-2021 related to Land-Based Pollution and Governance Themes

19. Agenda item 4 was discussed in the resumed session on 9 July 2021. Under this agenda item, the Secretariat presented document UNEP/MED WG.509/3 “Progress Achieved regarding the Implementation of the Programme of Work 2020-2021 related to Land Based Pollution and Governance Themes.” Presentation provided key highlights to work undertaken for preparation of the three Regional Plans on Urban Wastewater, Sewage Sludge and Marine Litter, as well as the assessment of implementation costs and socioeconomic benefits, and the three assessments of current practices in the agriculture and aquaculture sectors, as well as urban storm water management as background documents for preparation of related Regional Plans in biennium 2022-2023.

20. The Secretariat also presented work undertaken to update the annexes of the LBS and Dumping Protocols, and the indicator-based midterm evaluation of the implementation of National Action Plans (NAPs) 2015-2020, as well as an overview of technical guidelines aiming to complement the NBB/PRTR Methodology for 5th Cycle of NBB. Highlights were also provided for two complementary documents on “Compendium of Best Practices on Implementation of Dumping Protocol,” and Common methodologies and techniques for the assessment and monitoring of adverse impacts of dumping activities.

21. The Secretariat gave a brief overview of efforts undertaken for ensuring coordinated implementation of IMAP Pollution and Marine Litter Cluster on regional and national levels; work progress for reinforcing the generation and reporting of new quality-assured national monitoring data to IMAP Info System including interlaboratory comparison and assessment of the capacities of national laboratories and monitoring guidelines/protocols for IMAP Common Indicators 13, 14, 17, 18, 20 and 23; as well as progress achieved towards GES thematic assessment products for EOs 5, 9 and 10.

22. Finally, the Secretariat provided an overview of coordination efforts and joint activities with other regional and global organizations as well as participation in meetings and working groups; contribution to implementation of externally funded projects including the GEF funded “Mediterranean Sea Programme (MedProgramme); and EU-funded projects IMAP-MPA, EcAp-MED III and Marine Litter MED II.

23. The Meeting congratulated the Secretariat on progress made for implementation of the Programme of Work. The Meeting acknowledged the work undertaken by MED POL and achievements made during the biennium 2020-2021, particularly with regards to the development/updating of the Regional Plans, updating of the annexes of the LBS and Dumping Protocols, as well as work under IMAP Pollution and Marine Litter Cluster.

24. The Meeting’s final conclusions related to this agenda item are presented in Annex III of this report.

Agenda item 5(a): Update of the Annexes of the Land-Based Sources (LBS) Protocol

25. Agenda item 5(a) was presented in the initial session on 27 May 2021. Under this agenda item, the Deputy Coordinator presented document UNEP/MED WG.509/4 “Proposals for Updating the Annexes to the LBS Protocol” to the Meeting for their consideration and review. She explained the amendments agreed during the Working Group Meeting of the Designated Experts (10 December 2020), including proposals for taking into account the Ecosystem Approach with the aim to achieve and/or maintain Good Environmental Status (GES), as well as other global and regional developments under the Stockholm Convention; the Marine Strategy Framework Directive; and the Pollution Release and Transfer Register (PRTR). She underlined the work undertaken with SCP/RAC which included additions on the subjects of circular economy approaches in production processes taking into

account the scope of the application of the LBS Protocol as well as further elaborations of BAT and BEP definitions.

26. The Contracting Parties acknowledged the importance of the additional sources of pollution which have potential impairment to marine ecosystem such as noise, artificial light and others which were updated in Annex II. The participants discussed and agreed on the definitions of BAT and BEP proposed by the Deputy Coordinator; also pointing out the importance of incorporating the concepts of eco-design and eco-innovation into Annex IV. The meeting participants concurred with the proposed amendments and agreed to submit the Annexes of the LBS Protocol to the MAP Focal Points.

27. The conclusions and recommendations under this agenda item are presented in Annex III of this report.

Agenda item 5(b): Update of the Annex of the Protocol for the Prevention and Elimination of Pollution of the Mediterranean Sea by Dumping from Ships and Aircraft or Incineration at Sea

28. Agenda item 5(b) was presented in the initial session on 27 May 2021. Under this agenda item, the Deputy Coordinator presented document UNEP/MED WG.509/5 “Proposals for Updating the Annex to the Dumping Protocol” to the Meeting for their consideration and review. She explained the amendments considered and agreed during the Working Group Meeting of Designated Experts (09 February 2021), which are based on the 1996 London Dumping Protocol and related developments under the Marine Strategy Framework Directive (MSFD), as well as application of the ecosystem approach.

29. The Contracting Parties took note of work done and concurred with the proposed amendments by the Deputy Coordinator. No further technical comments were proposed. The meeting participants approved the amendments to update the “Annex of the Protocol for the Prevention and Elimination of Pollution of the Mediterranean Sea by Dumping from Ships and Aircraft or Incineration at Sea” and recommended submission to the MAP Focal Points.

30. The conclusions and recommendations under this agenda item are presented in Annex III of this report.

Agenda item 6(a): Review of the Regional Plan on Urban Wastewater Treatment

31. Agenda item 6(a) was presented in the initial session on 27 May 2021. Under this agenda item, the Deputy Coordinator presented document UNEP/MED WG.509/6 “Regional Plan on Urban Wastewater Treatment.” During her presentation, she highlighted progress made during the second working group meeting held back-to-back with this MED POL Focal Points Meeting. She emphasized issues pending which were placed in brackets to be resolved during this meeting. She indicated that the aim of discussions is to approve the Regional Plan for submission to the MAP Focal Points.

32. Concerning Article 1 (Definition of Terms), one meeting participant raised a point regarding the need to use composite samples for measuring ELVs. The Deputy Coordinator indicated that the use of these samples is not conditional. The meeting participants agreed to delete this reference clause.

33. With regards to Article V (Measures) which covers four principal topics: (i) collection and treatment of urban wastewater, (ii) reclamation and reuse of wastewater, (iii) industrial wastewater discharge; and (iv) monitoring, and further to the Deputy Coordinator’s overview of proposed updates:

- a. Further to postponing discussions to the MED POL Focal Points Meeting by the 2nd Working Group regarding the deadline dates of 2025 and 2035 for providing agglomerations with collecting systems for urban wastewater, the Contracting Parties did not concur on the proposed dates either, pointing to the political implications of this

decision. Israel inquired about the underlying reasons for justifying these dates, proposing also the date of 2030. The Meeting requested to postpone decision on the deadline dates for the consideration of the MAP Focal Points Meeting in September 2021.

- b. Further to unsuccessful discussions by the Meeting of the 2nd Working Group to agree on the date for adoption of the emission limit values and its proposal to postpone discussions to the MED POL Focal Points Meeting, the Contracting Parties did not concur on the proposed date either. A number of Contracting Parties raised some concerns indicating that 2023 is too early a date to meet. At the conclusion of discussions, the Meeting requested to postpone decision on the proposed date for the consideration of the MAP Focal Points Meeting.
- c. Further to the request of the Meeting of the 2nd Working Group, the Deputy Coordinator presented its proposal for alternative limit values for BOD, total nitrogen, arsenic, residual chlorine, COD, pH, phenol and total hydrocarbons as part of the emission limit values included in Appendix I.A (the 2nd Working Group Meeting agreed to the remaining ELVs in Appendix I.A). The Contracting Parties agreed to the proposed alternative values including 0.5 mg/l for Copper requested by Malta. A number of Contracting Parties enquired about the nature and scope of a risk-based assessment which was specified as a footnote in the Appendix. The Deputy Coordinator indicated that this aspect will be addressed in the technical guidelines currently under preparation to assist in the implementation of the Regional Plan.
- d. The Contracting Parties agreed with the alternative emission limit values for reuse of reclaimed wastewater for agriculture (Appendix I.B) as proposed by the Deputy Coordinator further to the request of the Meeting of the 2nd Working Group.
- e. Concerning emission limit values for discharge of industrial wastewater into collecting systems and WWTPs as stipulated in Appendix I.C, Israel enquired about limit ratio of COD to BOD. The Deputy Coordinator explained that the upper limit for COD to BOD ratio would ensure that no chemical treatment is needed. Turkey sought clarifications about applicability of ELVs to small industries, particularly with regards to heavy metals. The Deputy Coordinator indicated that the Contracting Parties may increase the ELVs for small industries discharging to the collecting system when (i) the plant uses BAT; and (ii) the effects of the discharged effluent on the collecting system and the WWTP are negligible. This justification was appended to the first footnote of Table 3 in Appendix I.C. The Contracting Parties agreed with the proposed ELVs.
- f. In line with the request of the Meeting of the 2nd Working Group to consider the dates of 2030 and 2035 for ensuring that wastewater discharges meet adopted ELVs, the Contracting Parties did not concur/agree on the proposed dates. Italy, Spain, Malta and France raised a “study reservation” on the two clauses dealing with discharges from agglomerations between 2000 and 15,000 p.e. and over 15,000 p.e. indicating that a formal response will be sent to the Secretariat for further consideration and discussion during the MAP Focal Points Meeting.
- g. Reference to the request of the 2nd Working Group Meeting to discuss the deadline dates of 2025 for adopting emission limit values by competent authorities for industrial wastewater and 2035 for implementing the adopted ELVs for discharges to collecting systems and urban wastewater treatment plants by the MED POL Focal Points Meeting, the Contracting Parties did not reach consensus on both issues either. The Meeting proposed postponing discussions on these deadline dates for the consideration of the MAP Focal Points Meeting.

34. The conclusions and recommendations under this agenda item are presented in Annex III of this report.

Agenda item 6(b): Review of the Regional Plan on Sewage Sludge Management

35. Agenda item 6(b) was presented in the initial session on 27-28 May 2021. Under this agenda item, the Deputy Coordinator presented document UNEP/MED WG.509/7 “Regional Plan on Sewage Sludge Management” which was updated further to comments provided by the 2nd Working Group Meeting for their consideration and review. She described proposals made which are incorporated in this updated version. She emphasized remaining issues placed in brackets by the 2nd Working Group Meeting that need to be addressed by the MED POL Focal Points Meeting. She indicated that the aim of discussions is to approve the Regional Plan for submission to the MAP Focal Points.

36. Concerning Article V (Measures), and with regard to:

- a. Treatment of sewage sludge: the Focal Points agreed to add “cement industry” sector to the list of specific uses of treated sludge.
- b. The Focal Points concurred on introducing two Classes (A and B) for land application of sludge for agricultural use. The Focal Points further agreed on a legally binding date of 2025 for setting Class ‘A’ sewage sludge with limit values for pathogen contents for biosolids as indicated in Table 1 of the Regional Plan. Regarding Class ‘B’, the Focal Points agreed to set this Class with specifications as per Table 1, where appropriate.
- c. Italy requested that the specifications for Faecal Coliforms be expanded to include also *Escherichia coli*. Taking into consideration the “EU regulation 2019/1009 of 5 June 2019 laying down rules on the making available on the market of EU fertilising products,” the Deputy Coordinator proposed the requested ELVs for *Escherichia coli* with a limit value of 1000 MPN/g DM for Class A and 200,000 MPN/g DM for Class B. The Focal Points agreed to both limit values, which were added in parentheses in Table 1. In this regard, Turkey noted that only Class B sludge is regulated in Turkey which meets the ELV for Faecal Coliforms of 2,000,000 MPN/g DM (similar to the Regional Plan); however, use of Class B sludge includes, in addition to prescribed uses in the Regional Plan, production of fruit trees and vegetables whose fruit or leaves do not touch the ground. Turkey requested additional time to discuss the matter further with national experts before reverting back to the Secretariat with its response. Accordingly, the requirement for adoption of Classes A and B, including the proposed deadline of 2025, is placed in square brackets for the consideration of the Meeting of the MAP Focal Points in September 2021.
- d. Regarding ELVs for concentrations of heavy metals in biosolids and soil (Tables 2 and 3), and further to postponing decision by the 2nd Working Group, the Focal Points agreed to set a legally binding date for adopting these ELVs in 2025 at the latest.
- e. Further to the consideration of the 2nd Working Group, the Focal Points agreed on the “applicable measures” as well as the legally binding “deadline of 2035” for establishment of required infrastructure for sewage sludge use for agricultural land applications and/or for energy/nutrient recovery.
- f. Concerning monitoring of quality of sewage sludge, the Deputy Coordinator provided a proposal whereby the Contracting Parties shall take measures to ensure monitoring of the quality of sewage sludge in the WWTP or after treatment outside the WWTP, whereby the Contracting Parties shall select the adequate monitoring programmes as indicated in Table 4 on the frequency of monitoring. The Contracting Parties agreed with the proposed clause and corresponding Table 4.

37. The conclusions and recommendations under this agenda item are presented in Annex III of this report.

Agenda item 6(c): Review of the Updated Regional Plan on Marine Litter Management in the Mediterranean

38. Agenda item 6(c) was presented in the initial session on 28 May 2021. Under this agenda item, the Deputy Coordinator introduced document UNEP/MED WG.509/8 “Updated Regional Plan on Marine Litter Management in the Mediterranean.” During her presentation, the Deputy Coordinator highlighted the fact that the updates for the Regional Plan have been undertaken by GRID-Arendal, designated as an official UNEP Centre which collaborates with the United Nations Environment Programme and other partners. She updated the MED POL Focal Points on the outcome of the 2nd Working Group Meeting summarizing changes introduced and focusing on remaining issues to be resolved mainly related to marine litter prevention measures.

39. Concerning Article 3 (Definition of Terms), the Focal Points accepted the definitions proposed by the Deputy Coordinator and/or Countries as a basis for the final definitions, with some modifications for microplastics, fishing gear, extended producers’ responsibility, and circular economy. One Contracting Party proposed an alternative definition for marine litter monitoring. The Focal Points agreed with this proposal. Malta proposed three additional definitions on “plastics,” “lightweight plastic carrier bag” and “waste”. The Deputy Coordinator indicated that it would disseminate the proposed definitions to the MED POL Focal Points, and if all respondents agree on proposed definitions with no modifications or objections within a period of 3 days, then the three definitions will be included under Article 3. All Focal Points agreed with this course of action.

40. Concerning Article 7 (Integration of Marine Litter Measures into the LBS National Action Plans), the Focal Points requested to delete the word “improve” from point (d) listed under the outline for the LBS NAPs whereby measures and targets are set to increase plastic waste collection and recycling. The Meeting concurred with this modification.

41. Regarding Article 9 (Prevention of Marine Litter), the Focal Points provided the following comments:

- a. Concerning economic instruments, one Contracting Party corrected the label for “Deposits and Refund System”.
- b. With regard to circular economy for plastics, and further to discussions held during the 2nd Working Group Meeting, the Focal Points agreed to the date of 2025 to be applied for prevention measures aiming to achieve a circular economy for plastics. They further agreed further to discussions held during the 2nd Working Group Meeting with the proposal of the Deputy Coordinator to delete the measures requiring the need to put in place a system to identify sources of plastic litter and also to identify/phase out single-use plastic products of concern. On the other hand, the Focal Points agreed to add clauses on the consideration of the list of Single Use Plastic items presented in Annex I to the Regional Plan; identification of single-use plastic products which are most found and cause impacts on the marine environment; as well as implementing sound measures to phase out consumption and production; setting of targets to phase out production and use of nonreusable, non-recyclable, and non-compostable plastic products; and endeavoring to substitute plastics.
- c. In reference to Land-based sources, and further to discussions of the 2nd Working Group, the Focal Points agreed to the proposal of the Deputy Coordinator to take into consideration the occurrence and extent of marine litter accumulations in order to assess their impacts.

42. Concerning Article 10, the Focal Points requested from the Secretariat to provide in a footnote examples for reference campaigns in relation to International Coastal Cleanup Campaigns and Programmes. However, the Focal Points did not reach agreement on the establishment by 2030 of ALDFG removal and recycling programmes, postponing discussions to the MAP Focal Points Meeting.

43. Regarding Article 16, the Focal Points agreed to add “co-responsibility of all stakeholders” to the enhancement of public awareness and education for the marine litter issue.

44. Finally, with regard to the Annex I providing the “List of Single Use Plastic (SUP) Items,” and further to discussions held by the 2nd Working Group, the Focal Points agreed to include in the Regional Plan the “Mediterranean Priority List of SUPs per Group of Items” which are listed in the Regional Guidelines to tackle single use plastic products in the Mediterranean (UNEP/MAP SCP/RAC 2021). Concerning Annex II providing a “List of Chemical Additives of Concern Used in Plastic Production,” the Focal Points agreed to include this annex in the Regional Plan based on the list of persistent organic pollutants (POPs) used as additives in plastics and listed in Annex A (elimination) and Annex B (restriction) to the Stockholm Convention as of 2021.

45. The conclusions and recommendations under this agenda item are presented in Annex III of this report.

Agenda item 7: Indicator-based midterm evaluation of the implementation of National Action Plans/Programme of Measures (2015-2020)

46. Agenda item 7 was presented in the resumed session on 9 July 2021. Under this agenda item, the Mr. Erol Cavus, MED POL Programme Officer presented the Working Document UNEP/MED WG.509/9 “Indicator-based midterm evaluation of the implementation of National Action Plans/Programme of Measures (2015-2020).” He noted that COP19 urged the Focal Points to report on the implementation of the NAPs in the framework of Article 13 of the LBS Protocol and requested the Secretariat (MED POL Programme) to undertake in 2020 an indicator-based midterm evaluation of the NAPs’ implementation based on the existing reporting system and in close collaboration with the Contracting Parties. He indicated that the midterm evaluation report was reviewed by the Meeting on “National Baseline Budget Methodologies, Assessments of new Regional Plans and Evaluation of National Action Plans under the LBS Protocol” (videoconference 22-23 April 2021) which recommended its submission, with some modifications, to the MED POL Focal Points meeting.

47. Turkey commented on information document UNEP/MED WG.509/Inf.19 “Rational and Approach for Preparing the Indicator-based midterm evaluation of the implementation of National Action Plans/Programme of Measures (2015-2020)” noting that the graphical presentation of percentage plastics is not clear. The Secretariat indicated that related information will be reviewed and clarified. The Meeting approved the document UNEP/MED WG.509/9 and recommended its submission to the Meeting of the MAP Focal Points as well as to COP 22 as “information document.”

48. The conclusions and recommendations under this agenda item are presented in Annex III of this report.

Agenda item 8(a): Integration and Aggregation Rules for Monitoring and Assessment of (IMAP Pollution and Marine Litter Cluster

49. Agenda item 8(a) was presented in the resumed session on 9 July 2021. Under this agenda item, Ms. Jelena Knezevic, MEDPOL Monitoring and Assessment Officer, presented the Working document UNEP/MED WG.509/10/rev.2 “Integration and Aggregation Rules for Monitoring and Assessment of IMAP Pollution and Marine Litter Cluster.” She explained the proposals elaborated in this document with regards to strengthening IMAP Pollution and Marine Litter implementation at national level; integration and aggregation rules for monitoring and assessment for IMAP Pollution and Marine Litter Cluster; elaboration of the scales of assessment by proposing upgraded aggregation scheme for the areas of assessment for EOs 5, 9 and 10 within the nested approach; and the rules for integration of assessments within the nested approach for IMAP Pollution and Marine Litter Cluster. She also presented the results of different case studies regarding testing of the NEAT tool application in order to explain its possible application for GES assessment of Ecological Objectives of IMAP Pollution Cluster. She also provided an explanation regarding the changes undertaken in line with

comments and conclusions of the Meeting of the CorMon on Pollution Monitoring. The Secretariat also explained that the revised document contains a disclaimer as well as some adjustment to the terms used throughout the document in order to avoid any possible confusion.

50. Following the opening of the discussion by the Chair, Turkey provided specific comments. These included identifying countries for which monitoring efforts under IMAP are extended to offshore areas (Para 11) and deleting the “geographical scale” (Para 19). Turkey also proposed an adjustment to the disclaimer proposed by the Secretariat. It also commented on the need to consider assessment areas defined by the Contracting Parties within implementation of MSFD (Para 22); deleting reference to “nested” scales approach (Para 23); removing “natura sites” from the GIS based layers (Para 25 as well as Table 6); deleting criteria (v) related to taking into account administrative boundaries of the Contracting Parties (Para 27); deleting the term “small areas” (Para 33); replacing national parts with Countries (Para 38); simplifying Paragraph 39; using the term “particular assessment area” and not “MRU” (Para 42); explaining the meaning of GES Decision Rule in Paragraph 45 as well as deleting the following “recommended by the EU MSFD (SWD (2020) 62 final)”; adding to the list of abbreviations the acronyms “ECs” and “ERL” (Para 49); and deleting the sentence “NEAT was firstly developed to assess biodiversity status of marine waters under the MSFD and since then has been used to assess different ecosystem components and geographical areas” (Para 53).

51. Following the discussion, there were a number of disagreements by some Contracting Parties on the points raised. Further to these comments the Chair recommended to capture the reservations of Turkey for consideration by the Secretariat at a later stage. The MAP Legal Officer confirmed that the disclaimer as amended by Turkey is correct from a legal perspective. The Coordinator indicated that the Secretariat would verify the content of the amended disclaimer with the UNEP Headquarter

52. Following the discussions, the Coordinator indicated the need to adhere to the scope of the Barcelona Convention, noting that IMAP is providing new challenges that we were not fully prepared for, and there is a need to learn how to handle them all together. The Coordinator further clarified that this is an evolving document. She also recommended testing of the proposed methodology on national or regional level so we can assess if there is a need for adjustment. Once the methodology is validated, it will be introduced for use in the 2023 MED-QSR. The Coordinator following a valid proposal by a Contracting Party enquired whether it would be more appropriate for this document to be sent to the CorMon for review in order to also allow time for the three other remaining documents under this agenda item for this session of the MED POL Focal Points Meeting Part I to be addressed.

53. Several interventions were made by a number of Contracting Parties on whether the document should be reviewed by the CorMon or go to the EcAp Coordination Group Meeting for its consideration. The Meeting finally agreed to send the document back for the consideration of the CorMon.

54. The conclusions and recommendations under this agenda item are presented in Annex III of this report.

Agenda item 8(b): Updated Baseline Values and Proposal for Threshold Values for IMAP Common Indicator 22

55. Agenda item 8(b) was presented in the resumed session on 9 July 2021. Under this agenda item, Mr. Christos Ioakeimidis, Marine Litter Expert, presented Working Document UNEP/MED WG.509/11 “Updated Baseline Values and Proposal for Threshold Values for IMAP Common Indicator 22,” as well as the relevant proposal for an updated Baseline Value (BV) of 369 items/100m and a Threshold Value (TV) of 130 items/100m for IMAP Common Indicator 22 at regional level.

56. The Meeting reviewed the document UNEP/MED WG.509/11; endorsed the proposed values; and recommended their submission to the upcoming 8th Meeting of EcAp Coordination Group for

approval. The Meeting requested the Secretariat to incorporate the respective values into the upgraded Regional Plan on Marine Litter Management in the Mediterranean, to be submitted for approval to the upcoming COP22 (UNEP/MED IG.25/12, Draft Decision 25/9, Antalya, December 2021).

57. In this regard, the Secretariat brought to the attention of the Contracting Parties the urgent need to submit datasets for IMAP Common Indicator 23 (i.e. seafloor macro-litter and floating micro-plastics) the soonest possible, in line with the IMAP Info System modules, to order to conduct a similar exercise. The Meeting expressed its support to the Secretariat to further advance the relevant work aimed at progressing towards updating the Baseline Value as well as proposing a Threshold Value for IMAP Common Indicator 23.

58. The conclusions and recommendations under this agenda item are presented in Annex III of this report

Agenda item 8(c): Background (Assessment) Concentrations (BC/BAC) for Common Indicator 17 and Upgraded Approach for Environmental Assessment Criteria (EAC) for IMAP Common Indicators 17, 18 and 20

59. Agenda item 8(c) was presented in the resumed session on 9 July 2021. Under this agenda item, the MED POL Monitoring and Assessment Officer presented Working Document UNEP/MED WG.509/12 “Background (Assessment) Concentrations (BC/BAC) for Common Indicator 17 and Upgraded Approach for Environmental Assessment Criteria (EAC) for IMAP Common Indicators 17, 18 and 20.” She introduced the new upgraded regional and sub-regional Mediterranean BC and BAC values for CI17; a proposal of the criteria for IMAP CI20, as well as an approach to upgrade the Mediterranean EACs. She furthermore explained that the data used for developing updated assessment criteria were collected in the IMAP Pilot Info System during its testing phase, and in particular after launching a formal call for reporting of monitoring data in June 2020, along with the monitoring data stored in MED POL database that have not been previously used for calculation of the assessment criteria applied in the 2017 and 2019 assessments. She also provided an explanation of the changes undertaken in line with comments and conclusions of the Meeting of CorMon on Pollution Monitoring.

60. The Meeting reviewed the document UNEP/MED WG.509/12 and recommended its submission to the upcoming 8th Meeting of EcAp Coordination Group for approval.

61. The conclusions and recommendations under this agenda item are presented in Annex III of this report

Agenda item 8(d): Assessment Criteria Methodology for IMAP Common Indicator 13: Pilot Application in Adriatic Sub-region

62. Agenda item 8(d) was presented in the resumed session on 9 July 2021. Under this agenda item, the MED POL Monitoring and Assessment Officer presented Working Document UNEP/MED WG.509/13 “Assessment Criteria Methodology for IMAP Common Indicator 13: Pilot Application in Adriatic Sub-region.” She explained that further to findings of data availability for setting the assessment criteria for nutrients, this working document elaborates possible uses of the various tools and methods for setting the reference conditions and boundary values for Dissolved Inorganic Nitrogen (DIN) and Total Phosphorous (TP) including a methodological approach developed for the Adriatic Sea; and Best Practice Guide for nutrients toolkit (JRC) and FAN/FLU index (Spain) in relevant sub-areas. She also provided an explanation of the changes undertaken in line with comments and conclusions of the Meeting of CorMon on Pollution Monitoring.

63. The Meeting reviewed the document UNEP/MED WG.509/13 and recommended its submission to the upcoming 8th Meeting of EcAp Coordination Group for approval.

64. The conclusions and recommendations under this agenda item are presented in Annex III of this report.

Agenda item 9: MED POL Programme of Work 2022-2023

65. Agenda item 9 was presented in the initial session on 28 May 2021. Under this agenda item, the Secretariat introduced document UNEP/MED WG.509/14 “MED POL Programme of Work 2022-2023 proposal for submission to the MAP Focal Points Meeting.” In his presentation, the MED POL Programme Management Officer provided an overview of the key three thematic programmes in which MED POL is involved: “Towards a Pollution and Litter Free Mediterranean Sea and Coast Embracing Circular Economy; Governance; and Together towards a Shared Knowledge and Foresight of the Mediterranean Sea and Coast” focusing on work under the three pollution-related protocols and IMAP. He explained the key deliverables and tasks to be undertaken by MED POL under each programme, along with links and foreseen collaboration during implementation with other MAP components. He also explained how MED POL PoW 2022-2023 will lead to fulfillment of the MTS for MAP for the upcoming period. He also provided insights about foreseen work with external partners in the framework of GEF and EU supported projects in the area of pollution reduction and prevention and marine litter management.

66. The Focal Points pointed out that the PoW was an ambitious proposal. They highlighted the need for allocating sufficient resources for its proper and timely delivery. A number of Contracting Parties expressed the need for prioritization of activities focusing first on those related to the QSR, followed by operationalizing the implementation of the new Regional Plans, and finally securing support for the national monitoring programmes to generate the required monitoring data. The Deputy Coordinator indicated that important resources, financial and human, for a considerable number of the proposed activities will be made available through external projects, particularly the GEF-funded MedProgramme and the EU-funded ML MED II Project and ECAP MED III Project. She also noted that the Secretariat is aiming to strengthen the MED POL team with an additional programme assistant position and requested from the MED POL Focal Points to inform their corresponding MAP Focal Points on the need to further strengthen the MED POL team to effectively deliver its mandate and the related POW activities.

67. Specific comments were also provided by a number of Contracting Parties. Israel requested that the PoW includes an activity for development of a monitoring protocol for microplastics originating from WWTPs. Montenegro requested that the PoW addresses the disposal of obsolete chemicals, particularly Mercury and PCB. Turkey requested clear linkage between the MTS and SDG targets. The Secretariat informed the Meeting that the development of a Protocol on monitoring of microplastics is foreseen in the 2022-2023 biennium and is planned for implementation under the EU-funded ML MED II project. With regard to the request of Montenegro, the Secretariat will assess the possibility of addressing its request through the MedProgramme. Concerning the inter-relation between MTS and SDGs, the Secretariat indicated that this will be addressed in the final version of the MTS document noting that the outputs of the PoW are derived from the MTS.

68. The Meeting congratulated the Secretariat on the Programme of Work and approved the submission of the proposed MED POL activities to the MAP Focal Points Meeting.

Agenda item 12: Harmonization and standardization of IMAP Pollution Cluster Monitoring²

- a) *Monitoring Guidelines/Protocols for IMAP Common Indicators 13, 14, 17, 18, 20 and 23.*

² Agenda items 10 and 11 for Part I are presented at the end of the Report of the Meeting for its three sessions

- b) *Monitoring Guidelines/Protocols for Analytical Quality Assurance and Reporting Monitoring Data for IMAP Common Indicators 13, 14, 17, 18 and 20.*
- c) *Monitoring Guidelines/Protocols for Floating Microplastics.*

69. The MED POL Programme Monitoring and Assessment Officer, Ms. Jelena Knezevic, presented Working Documents UNEP/MED WG.509/15 to WG.509/33 under agenda items 12(a) and 12(b) providing the Monitoring Guidelines/Protocols for IMAP Common Indicators 13, 14, 17, 18 and 20 as well as their Analytical Quality Assurance and Reporting. The MED POL Associate Project Management Officer for Marine Litter, Mr. Christos Ioakeimidis presented Working Document UNEP/MED WG.509/34 under agenda item 12(c) providing the Monitoring Guidelines/Protocols for IMAP Common Indicator 23 for Floating Microplastics.

70. The Contracting Parties expressed their appreciation of the comprehensive compendium of the Monitoring guidelines for IMAP Common Indicators 13, 14, 17, 18, 20 and 23 aiming to strengthen substantial knowledge for the implementation of the standardized and harmonized IMAP Pollution Cluster monitoring practices and increasing comparability of the national monitoring programmes, while conveying their expectation that these protocols/guidelines will provide much needed support to national IMAP competent laboratories in their endeavors to deliver quality-assured data for the future assessments in the Mediterranean, especially to the ongoing preparation of the 2023 MED QSR.

71. The Contracting Parties further expressed their satisfaction of the work undertaken by the Secretariat-MED POL Programme in collaboration with the International Atomic Energy Agency – Marine Environmental Studies Laboratory (IAEA/MESL) and support of distinguished scientists and experts representing the Contracting Parties.

72. The Contracting Parties took note and agreed with the explanation provided by the Secretariat regarding further work that will be undertaken in collaboration with IAEA/MESL in order to provide optimal design of the Monitoring Guidelines for their practical use by the technical personnel of national IMAP competent laboratories.

73. Finally, the Meeting thanked the Secretariat for its efforts to consistently and thoroughly address the technical proposals provided by national representatives during and immediately after the Integrated Meetings of the Ecosystem Approach Correspondence Groups on IMAP Implementation (CORMONs) in December 2020 and April 2021.

Monitoring Guidelines/Protocols for sampling; sample preservation and transportation of hydrographic physical and chemical parameters

74. The Secretariat presented Working Documents UNEP/MED WG.509/15 to WG.509/20 providing the Monitoring Guidelines/Protocols for sampling; sample preservation and transportation; as well as sample preparation and analysis of hydrographic physical and chemical parameters; key nutrients in seawater (i.e., nitrogen, phosphorous, silica compounds and Chlorophyll *a*) related to IMAP Common Indicators 13 and 14.

75. Further to discussions by the meeting participants, the Contracting Parties agreed to the monitoring methodologies and practices related to IMAP Common Indicators 13 and 14 and approved the Meeting documents UNEP/MED WG.509/15 to 509/20 for their use by the IMAP competent laboratories in order to ensure the representativeness and accuracy of the analytical results related to IMAP Pollution Cluster, including for the preparation of the 2023 MED QSR.

Monitoring Guidelines/Protocols for sampling; sample preservation and transportation of heavy and trace elements and organic contaminants in sediment and biotas

76. The Secretariat presented Working Documents UNEP/MED WG.509/21 to 509/26 providing the Monitoring Guidelines/Protocols for sampling; sample preservation and transportation; as well as sample preparation and analysis of heavy and trace elements and organic contaminants in sediment and biota related to IMAP Common Indicator 17, as well as in seawater as non-mandatory matrix.

77. The Contracting Parties agreed on the monitoring methodologies and practices related to IMAP Common Indicator 17 and approved the Meeting documents UNEP/MED WG.509/21 to 509/26 for their use by the IMAP competent laboratories in order to ensure the representativeness and accuracy of the analytical results related to IMAP Pollution Cluster, including for the preparation of the 2023 MED QSR.

Monitoring Guidelines/Protocols for sampling, sample preparation and biomarkers analysis

78. The Secretariat presented Working Documents UNEP/MED WG.509/27 to 509/29 providing the Monitoring Guidelines/Protocols for sampling, sample preparation and biomarkers analysis, i.e., Lysosomal membrane stability (LMS), Micronuclei (MNI) frequency, Acetylcholinesterase (AChE) activity and Stress on Stress (SoS) of Marine Molluscs (such as *Mytilus* sp.) and Fish (such as *Mullus barbatus*) related to IMAP Common Indicator 18.

79. With regard to Working Document UNEP/MED WG.509/27, one meeting participant took the floor to elaborate the written proposals shared with the Secretariat after formal submission of the document on 1st September 2020 proposing the following aspects to be further addressed by: a) amending paragraph 20 with the recommendation that a specific common testing of the period of transportation should be exercised between the Parties; b) introducing a few precisions in paragraph 35 as follows: i) separation of dry soft tissue mass from dry shell mass with “;” instead of “/” and adding level of evaluation of the results along with the unit of measure i.e., 0.1 g for dry soft tissue mass and dry shell mass; ii) specifying that dry weight in equation for calculation of Condition Index (CInd) refers to dry soft tissue weight and adding level of evaluation of the result along with the unit of measure i.e., 0.1 g for dry weight and 0.1 cm³ for internal shell volume; c) introducing a few precisions in paragraph 60 as follows: i) precisising that weight refers to total weight for fish biometrics; ii) replacing weight with body eviscerated weight in equation for calculation of the Fulton’s condition factor; iii) replacing in equation for measurement of GSI total body weigh with eviscerated weight and precisising that eviscerated weight corresponds to the total weight without all internal organs (stomach, liver, gonad, intestine); iv) replacing in equation for measurement of Liver Somatic Index (LSI or HSI) total body weigh with eviscerated weight and deleting “stomach content - liver weight”; v) adding new footnote that refers to Martinez-Gomez et al., 2012.

80. The Secretariat proposed adding an aspect related to precision in paragraph 10 further to its amendment previously undertaken following the request of one participant during the Meeting of CorMon on Pollution Monitoring (26-28 April). A precision “at least of” was added along with a related footnote explaining that a period of 30 days is best for collecting data related to the analysis of biomarkers only; adding that if samples are also taken for chemical analysis, a period of at least 60 days should be ensured, along with providing information on gonad development.

81. Following on the expression of support of another participant to such proposed amendments of paragraphs 10, 20, 35 and 60, the Contracting Parties agreed on the monitoring methodologies and practices elaborated for sampling and sample preservation of Marine Molluscs (such as *Mytilus* sp.) and Fish (such as *Mullus barbatus*) for IMAP Common Indicator 18 and approved the meeting document UNEP/MED WG.509/27, as amended in UNEP/MED WG.509/43/L.3/Add.1 during the discussion, for its use by the IMAP competent laboratories in order to ensure the representativeness and accuracy of the analytical results related to IMAP Pollution Cluster, including for the preparation of the 2023 MED QSR.

82. Regarding Working Document UNEP/MED WG.509/28, one meeting participant took the floor to elaborate the written proposals shared with the Secretariat after formal submission of the document on 1st September 2020, proposing to add an aspect on precision in paragraph 42 that the first inspection corresponds to time ‘0’ in Table 1. The Contracting Parties approved the document UNEP/MED WG.509/28 for biomarkers analysis, i.e., Lysosomal membrane stability (LMS), as amended in UNEP/MED WG.509/43/L.3/Add.2 during the discussion, for their use by the IMAP

competent laboratories in order to ensure the representativeness and accuracy of the analytical results related to IMAP Pollution Cluster, including for the preparation of the 2023 MED QSR.

83. Finally, with regard to Working Document UNEP/MED WG.509/29, one meeting participant elaborated written proposals shared with the Secretariat after formal submission of the document on 1st September 2020, proposing to add: a) an aspect on precision in paragraph 59 whereby the temperature of incubation and reaction must be kept at room or controlled temperature, such as +20°C; and b) including a correction in the denominator of equation for calculation of AChE activity along with an explanation of parameters included in the equation as provided in paragraph 59.

84. Following on the expression of support of another participant to the proposed amendments, the Contracting Parties agreed on the monitoring methodologies and practices elaborated for biomarkers analysis, i.e., Micronuclei (MNI) frequency, Acetylcholinesterase (AChE) activity and Stress on Stress (SoS) of Marine Molluscs (such as *Mytilus* sp.) and Fish (such as *Mullus barbatus*) related to IMAP Common Indicator 18 and approved the document UNEP/MED WG.509/29, as amended in UNEP/MED WG.509/43/L.3/Add.3 during the discussion, for their use by the IMAP competent laboratories in order to ensure the representativeness and accuracy of the analytical results related to IMAP Pollution Cluster, including for the preparation of the 2023 MED QSR.

Monitoring Guidelines/Protocols for sampling; sample preservation and transportation of heavy and trace elements and organic contaminants in sea food

85. The Secretariat presented Working Documents UNEP/MED WG.509/30 to 509/31 providing the Monitoring Guidelines/Protocols for sampling, sample preservation and transportation; as well as sample preparation and analysis of heavy and trace elements and organic contaminants in sea food related to IMAP Common Indicator 20.

86. Further to discussions, the Contracting Parties agreed on the monitoring methodologies and practices related to IMAP Common Indicator 20 and approved the Meeting documents UNEP/MED WG.509/30 to 509/31 for their use by the IMAP competent laboratories in order to ensure the representativeness and accuracy of the analytical results related to IMAP Pollution Cluster, including for the preparation of the 2023 MED QSR.

Procedures for Analytical Quality Assurance and Reporting of Monitoring Data

87. The Secretariat presented Working Documents UNEP/MED WG.509/32 to 509/33 providing the procedures for Analytical Quality Assurance and Reporting of Monitoring Data aimed at ensuring the representativeness and accuracy of the analytical results for generation and reporting of quality-assured monitoring data.

88. Further to requesting the Secretariat - INFO/RAC to finalize Data Standards (DSs) and Data Dictionaries (DDs) for IMAP Common Indicators 18 and 20 for their integration in the IMAP Info System in line with the proposals elaborated in Annex IV of the document UNEP/MED WG.509/33, which was shared with the 8th Meeting of EcAp Coordination Group, the Contracting Parties approved the Meeting documents UNEP/MED WG.509/32 and WG.509/33 for their use by the IMAP competent laboratories in order to move forward the implementation of standardized and harmonized IMAP monitoring practices.

Monitoring Guidelines/Protocols for Floating Microplastics

89. The Secretariat presented Working Document UNEP/MED WG.509/34 providing the Monitoring Guidelines/Protocols for Floating Microplastics that extracts from the most commonly applied methodologies for monitoring floating microplastics and presents the basic methodological elements for monitoring floating microplastics in the Mediterranean in line with IMAP requirements. The Secretariat explained that the aim of this protocol is to guide technical personnel of the IMAP competent laboratories on the implementation of standardized and harmonized monitoring practices related to IMAP EO10 (Marine Litter) Common Indicator 23 (Floating Microplastics).

90. The Contracting Parties agreed on the Monitoring Guidelines/Protocols for Floating Microplastics and approved the Working Document UNEP/MED WG.509/34 for their use by the IMAP competent laboratories in order to ensure the representativeness and accuracy of the analytical results for generation and reporting of quality-assured monitoring data related to IMAP Marine Litter Cluster (Ecological Objective 10, Common Indicator 23), including for the preparation of the 2023 MED QSR.

91. The conclusions and recommendations under this agenda item are presented in Annex III of this report.

Agenda item 13: Common methodologies on estimation techniques for the National Baseline Budget (NBB) of pollutants related to:

- a) *Non-point source releases from agriculture.*
- b) *Point source releases from aquaculture.*
- c) *Non-point source releases from catchment runoffs.*

92. The MED POL Programme Pollution Control Officer, Mr. Erol Cavus, presented Working Documents UNEP/MED WG.509/35 to WG.509/37 providing guidelines on common methodologies on estimation techniques for the National Baseline Budget (NBB) of pollutants related to non-point source releases from agriculture; point source releases from aquaculture; and non-point source releases from catchment runoffs. He briefed meeting participants on the comments received and outcomes of the Expert Meeting which discussed these guidelines in April 2021.

93. Under agenda item 13(a), the Secretariat introduced Working Document UNEP/MED WG.509/35: "Guidelines on estimation techniques and applied methodologies for non-point source releases from agriculture," explaining the scope of the updated NBB Guidelines aiming to support the Contracting Parties to report their pollutants' releases originating from non-point sources from agriculture and providing detailed overview of estimation techniques and approaches of emissions and releases of pollutants from specific non-point agricultural sources.

94. The Focal Points agreed on the Guidelines on estimation techniques and applied methodologies for non-point source releases from agriculture and approved the Working Document UNEP/MED WG.509/35 for their use to report their pollutants' releases originating from non-point source releases from agriculture.

95. Under agenda item 13(b), the Secretariat introduced Working Document UNEP/MED WG.509/37: "Guidelines on estimation techniques and applied methodologies for point source releases from aquaculture," providing information on estimation of releases of Total Nitrogen, Total Phosphorus, Total Organic Carbon (BOD, or COD) and some heavy metals (Cu and Zn and their compounds) originating from the aquaculture sector. The Secretariat emphasized few aspects addressed by the Guidelines including the importance of feed content for the estimation of the releases of TN, TP, TOC as well as the issue of unintentional releases of pesticides, POPs and microliter via fish feeds, noting that there were no agreed estimation techniques for these releases.

96. The Focal Points agreed on the Guidelines on estimation techniques and applied methodologies for point source releases from aquaculture and approved the Working Document

UNEP/MED WG.509/36 for their use to report their pollutants' releases originating from point source releases from aquaculture.

97. Under agenda item 13(c), the Secretariat introduced Working Document UNEP/MED WG.509/38: "Guideline on estimation techniques and applied methodologies for non-point source releases from catchment runoffs". The Secretariat explained the scope of the document by providing specific information on estimation of releases of nutrients, organic carbon and veterinary antibiotics and pharmaceuticals from catchment runoff.

98. The Focal Points agreed on the Guidelines on estimation techniques and applied methodologies for non-point source releases from catchment runoffs and approved the Working Document UNEP/MED WG.509/37 for their use to report their pollutants' releases originating from non-point source releases from catchment runoff.

99. The conclusions and recommendations under this agenda item are presented in Annex III of this report.

Agenda item 14: Review of assessments for development of three new Regional Plans in accordance with Article 15 of the LBS Protocol for the biennium 2022-2023 on:

- a) *Agricultural practices and discharged pollutants reaching the Mediterranean marine environment.*
- b) *Aquaculture practices in the Mediterranean and their impact on the marine environment.*
- c) *State of urban storm water management in the Mediterranean.*

100. The MED POL Programme Management Officer, Mr. Mohamad Kayyal, presented Working Documents UNEP/MED WG.509/38 to WG.509/40 providing the outcomes of the assessments carried out in the current biennium to examine and document agricultural practices and discharged pollutants reaching the Mediterranean; aquaculture practices and their impact on the Mediterranean marine environment, in cooperation with Plan Bleu Regional Activity Centre; and state of urban storm water management in the Mediterranean. He stressed the aim of these assessments to provide up-to-date data and information for elaborating the three new Regional Plans on Agriculture Management, Aquaculture Management and Urban Storm Water Management to be developed in the 2022-2023 biennium. As such, he stressed the background nature of these documents stressing that any information based on these assessments which will be incorporated in the clauses of the Regional Plans will be subject to examination and re-evaluation by the expert groups to be designated by the Contracting Parties as part of the preparation process of these Regional Plans.

101. During his presentation of the three assessments under agenda items 14(a), 14(b) and 14(c), the MED POL Programme Management Officer briefed meeting participants on the comments received by the Expert Group Meeting held in April 2021. He illustrated the amendments made in response to the raised comments for each of the three assessments. He also provided answers to comments posed by the meeting participants, in particular, to one participant who inquired about comments provided on the assessment on aquaculture practices (UNEP/MED WG.509/39) which were sent to the Secretariat in the "Draft" Meeting Report of the Experts Meeting held in April 2021 (included as Information Document UNEP/MED WG.509/Inf.19). He confirmed that the Secretariat would address this comment promptly in the "Final" Expert Group Meeting Report to be disseminated to the MED POL Focal Points.

102. Further to discussions, the Meeting introduced specific data and information in document WG.509/39, as appended in Document WG.509/43/L.3 related to Bluefin Tuna farming in the Mediterranean.

103. The Focal Points recommended using the three assessment documents for further elaborating the new Regional Plans on Agriculture, Aquaculture, and Urban Storm Water Management in the Mediterranean as stipulated in the conclusions and recommendations under this agenda item in Annex III of this report.

Agenda item 15: Methodologies and techniques for the assessment and monitoring of adverse impacts of dumping activities.

104. Under agenda item 15, the MED POL Programme Pollution Control Officer introduced the Working Document UNEP/MED WG.509/41 on the “common methodologies and techniques for the assessment and monitoring of adverse impacts of dumping activities.” He presented related methodologies and techniques addressing both monitoring of dredging operations from harbors, ports, navigation channels and infrastructure projects, as well as of dredged material disposal sites. He briefed meeting participants on the comments received and outcomes of the Expert Meeting which reviewed this document in April 2021 as stipulated in the draft Information Document UNEP/MED WG.509/Inf.20.

105. Under the same agenda item, the MED POL Programme Pollution Control Officer introduced Working Document UNEP/MED WG.509/42 “Compendium of Best Environmental Practices” aiming to mainstream regional and global good practices under the LC/LP, Baltic Marine Environment Protection Commission (HELCOM), and the Commission on Protecting and Conserving North-East Atlantic and its resources (OSPAR), as well as relevant information found in guidelines published by other international organizations, with a particular focus on management of dredged materials. He elaborated on the document’s linkage to findings of the questionnaire, which was sent to the Contracting Parties, based on which this compendium was prepared as stipulated in Information Document UNEP/MED WG.509/Inf.14. He also briefed meeting participants on the comments received and outcomes of the Expert Meeting which examined this document in April 2021 as stipulated in the UNEP/MED WG.509/Inf.20.

106. The conclusions and recommendations under this agenda item are presented in Annex III of this report.

Agenda items 10 and 16: Any other business (Part I and Part II)

107. Under this agenda item (Part I), the Secretariat presented a brief summary the main findings of the document “Cost estimates for the implementation of the key measures of the Regional Plans for wastewater treatment, sewage sludge and marine litter management with evaluation of related socio-economic benefits” (UNEP/MED WG.509/Inf.7). The MED POL Focal Points were invited to provide their feedback on the approaches used in the study; findings and recommendations as outlined in the document. The Meeting participants agreed to submit the cost assessment study as an information document to the MAP Focal Points Meeting and COP22.

108. During the resumed session of Part I, the Focal Points bid farewell to the MED POL Focal Point from Slovenia, Ms. Valentina Turk. The Coordinator expressed her appreciation for the involvement of Ms. Turk with UNEP/MAP and especially her contributions in the field of monitoring and assessment. The Meeting wished Ms. Turk success in her future professional endeavors.

109. No issues were raised for this agenda item during Part II of the Meeting.

Agenda items 11 and 17: Conclusions and recommendations (Part I and Part II)

110. The Meeting reviewed, commented on, and approved the draft Conclusions and Recommendations reports for both parts of the Meeting as amended and attached to the present report in Annex III including their corresponding appendices, revised as appropriate, by the Meeting.

Agenda item 18: Closure of Meeting

111. Further to expressing the usual courtesies, the Chair concluded the meeting expressing special thanks and sincere appreciation to all participants for their commitment during the three sessions of the Meeting in 27-28 May, 9 July and 6-7 October 2021.

112. The Chair closed the MED POL Focal Points Meeting at 16:00 on Thursday 7 October 2021.

Annex I
List of Participants

**REPRESENTATIVES OF THE CONTRACTING PARTIES / REPRESENTANTS DES
PARTIES CONTRACTANTES**

Albania

Ms. Klodiana Marika,
Director, Ministry of Tourism and Environment

Ms. Ledjana Bojaxhi,
Head of sector
Ministry of Tourism and Environment

Mr. Elson Thana,
Expert in the Department of Maritime Transport Policies at Ministry
of Infrastructure and Energy

Algeria

Mme. Souad Boustila,
Ingenieur en environnement chez Ministere de l'environnement

Bosnia and Herzegovina

Ms. Selma Cengic,
Executive Director · Hydro Engineering Institute Sarajevo (HEIS)

Ms. Senida Dzajic –
Researcher, Hydro Engineering Institute Sarajevo (HEIS)

Croatia

Ms. Barbara Skevin Ivosevic,
Senior Advisor. Ministry of Environmental and Nature Protection

Ms. Jasmina Antolic,
Ministry of Environmental and Nature Protection

Ms. Nela Palarić,
Head of Service for Licences and transboundary movement of
Waste, Ministry of Economy and Sustainable development

Mr. Pero Tutman,
Scientific advisor, Institute of Oceanography and Fisheries

Ms. Marija Šikoronja,
Hrvatske vode (Croatian water)

Cyprus

Mr. Konstantinos Antoniadis,
Department of Fisheries and Marine Research

Ms. Antonia Achilleos,
Department of Environment, Limassol

Egypt

Mr. Sameh Ayoub,
MEDPOL Focal Point, Egyptian Environmental Affairs Agency

Soha Shabaka,
National Institute of Oceanography and Fisheries

European Union

Mr. Georg Hanke,
European Commission Joint Research Centre. Directorate D,
Sustainable Resources Water and Marine Resources Unit

France

Mme. Emmanuelle Thiesse,
Chargée de mission pollutions et fonds marins, Ministère de la
transition écologique

Mr. Francois Galgani,
IFREMER / EU mission board member (Healthy Ocean)

Greece

Ms. Maria Gini,
Head of the Division of Protection and Water Resources
Management, Ministry of Environment and Energy

Israel

Mr. Rani Amir,
Director MCED, Ministry of Environmental Protection

Mr. Frederic Arzoine,
Ministry of Environmental Protection

Ms. Maisa Inibtawi,
Marine Pollution Prevention Coordinator - Land-Based Sources,
Ministry of Environmental Protection

Italy

Ms. Cecilia Silvestri,

The Italian Institute for Environmental Protection and Research
(ISPRA)

Mr. Cristian Mugnai,
The Italian Institute for Environmental Protection and Research
(ISPRA)

Ms. Daniela Berto,
The Italian Institute for Environmental Protection and Research
(ISPRA)

Ms. Erika Magaletti,
The Italian Institute for Environmental Protection and Research
(ISPRA)

Mr. Francesco Mundo,
The Italian Institute for Environmental Protection and Research
(ISPRA)

Ms. Ginevra Moltedo,
The Italian Institute for Environmental Protection and Research
(ISPRA)

Mr. Marco Matiddi,
The Italian Institute for Environmental Protection and Research
(ISPRA)

Ms. Nicoletta Calace,
The Italian Institute for Environmental Protection and Research
(ISPRA)

Ms. Silvana Salvati,
The Italian Institute for Environmental Protection and Research
(ISPRA)

Lebanon

Ms. Marwa El Mokdad,
Environmental Engineer, Ministry of Environment

Mr. Najib Abi Chedid,
Environmental Expert, Ministry of Environment

Libya

Mr. Meftah El Madni,
Ministry of Environment, Tripoli

Malta

Ms. Tamara Micallef,
Environment and Resources Authority

Monaco

Mr. Philippe Antognelli,
Head of Section, Direction de l'Environnement

Montenegro

Ms. Ana Misurovic,
Environment Protection Agency

Ms. Ivana Mitrovic,
Advisor, Environment Protection Agency

Ms. Ivana Stojanovic,
Head of Division for Integrated management of Marine and Land
Ecosystems, Ministry of Ecology, Spatial Planning and Urbanism,

Mr. Novica Mijovic,
Port State Control Officer, Ministry of Capital Investment

Mr. Obrad Djokovic,
Port State Control Officer, Ministry of Capital Investments

Mr. Sergej Vujosevic,
Ministry of capital investment, Bar

Ms. Snežana Didanović,
Ministry of Ecology, Spatial Planning and Urbanism, Podgorica

Morocco

Mr. Abdelkader Ajir,
Chef de Service, Ministère de l'Environnement

Mme. Btissm El Menouar,
Département de l'Environnement, Rabat

Mme. Lalla Khadija Ghedda,
Chef de Service Etude de Pollution des Ressources en Eau - ONEE

Mme. Malika EL Bayoudi,
Cadre Administrateur, Représentant du Ministère de l'Energie, des
Mines et de l'Environnement, Département de l'Environnement

Mr. Mohammed EL Bouch
Directeur, Département de l'Environnement

Mr. Moulay Lahcen Ouahidi,
Laboratoire National des Etudes et de Surveillance de la Pollution
(LNESE) relevant du Secrétariat d'Etat chargé du Développement
Durable

Mme. Mounia Hamdaoui,
Engineer, Ministry of Energy, Mines and Environment

Mme. Naoual Zoubair,
Ministère de l'Énergie, des Mines et de l'Environnement-
Département de l'Environnement

Slovenia

Ms. Klara Jarni,
Institute for Water of the Republic of Slovenia, Ljubljana

Mr. Mitja Bricelj,
Ministry of the Environment and Spatial Planning

Mr. Uros Robic,
Institute for water of the Republic of Slovenia

Ms. Valentina Turk,
National Institute of Biology

Spain

Ms. Conchita Marcuello,
Ministry for ecological transition and demographic challenge

Ms. Marta Martinez-Gil Pardo de Vera,
Ministry for ecological transition and demographic challenge

Tunisia

Mme. Inès Houarbi Ben Salah,
Expert contrôleur chef, Otedd/anpe

Ms. Marwa Douma,
Agence de Protection et d'Aménagement du Littoral

Noureddine Zaaboub,
National Institute of Marine Sciences and Technology

Mr. Samir Khedhira,
Expert contrôleur général, Agence Nationale de Protection de
l'Environnement (ANPE)

Mr. Yassine Marzougui,
Agence Nationale de Protection de l'environnement

Turkey

Mme. Asli Topalak,
Ministry of Environment and Urbanization

Ms. Aysin Turpanci,
Legal Expert, Ministry of Environment and Urbanization

Mr. Erman Cetin,
Head of Department for Maritime Affairs, Ministry of Foreign
Affairs

Mr. Ahmet Kideys,
Expert in Marine Biology & Fisheries

Ms. Beyza Ozturanli,
Expert in public Law

M. Kerem Noyan,
Ministry of Environment and Urbanization

Ms. Ozlem Ozer,
Environmental expert, Ministry of Environment and Urbanization

Ms. Bahar özöğüt,
Ministry of Environment and Urbanization

Ms. Gülsevım Şener,
Engineer, Ministry of Environment and Urbanization

**REPRESENTATIVES OF UNITED NATIONS SPECIALIZED AGENCIES
REPRESENTANTS DES INSTITUTIONS SPECIALISEES DES NATIONS UNIES**

**Plan Bleu Regional Activity
Center**

Ms. Lina Tode,
Deputy Director

**Sustainable Consumption and
Production Regional Activity
Center (SCP/RAC)**

Mr. Enrique de Villamore Martin,
Director

Ms. Magali Outters,
Team Leader Policy Area,

Mr. Pedro Fernandez Bautista,
Project manager

**Secretariat of the Basel,
Rotterdam and Stockholm
Conventions (BRS)**

Ms. Kei Ohno Woodall,
Programme Officer,

**Specially Protected Areas
Regional Activity Center
(SPA/RAC)**

Mme. Lobna Ben Nakhla,
Programme Officer

Mr. Mehdi Aissi,
Programme Officer

**International Maritime
Organization (IMO)**

Mr. Andrew Birchenough,
Technical Officer

Mr. Frederik Haag
Head, Office of the LC/LP and Ocean Affairs

**Economic and Social Commission
for Western Asia (ESCWA)**

Mr. Rami Sabella
Programme Management Officer

Ms. Lara Geadah,
Associate Coordination Officer

Ms. Sarah Daniel,
Consultant at Food and Environment Policies Section, Climate.
Change and Natural Resources Sustainability Cluster

UNEP/ROWA

Ms. Etaf Chehade
Programme Officer, Ecosystems Subprogramme

Mr. Iyngararasan Mylvakanam
Programme Officer

UNEP/MAP

Ms. Tatjana Hema,
MAP Coordinator

Mr. Mohamad Kayyal,
MEDPOL Programme Management Officer

Ms. Jelena Knezevic,
MEDPOL Monitoring and Assessment Officer

Mr. Erol Cavus,
MEDPOL Pollution Control Officer

Mr. Christos Ioakeimidis
Associate Project Management Officer

Ms. Renta Fleck
UN Volunteer and expert in Marine Litter

UNEP/MAP Experts

Ms. Alma Bako
Expert

Ms. Alexandra Drizo
Expert

Mr. Jorge Reuven Tarchitzky
Expert

Ms. Lihie Iuclea
Expert

Ms. Marina Markovic
Expert

Ms. Nurit Kress
Expert

Mr. Robert Precali
Expert

Mr. Chris Vivian
Expert

**REPRESENTATIVES OF INTERGOVERNMENTAL
ORGANIZATIONS/REPRESENTANTS DES ORGANISATIONS
INTERGOUVERNEMENTALES**

**European Environment Agency
(EEA)**

Ms. Cécile Roddier-Quefelec,
Ocean Governance, Mediterranean Regional Cooperation

**International Atomic Energy
Commission (IAEA)**

Mr. Aldo Viarengo,
Scientific adviser

**Secretariat of the Pacific Regional
Environment Programme
(SPREP)**

Mme. Julie Pillet,
Technical Waste project Coordinator

**Regional Organization for
Conservation of the Environment
of the Red Sea & Gulf of Aden
(PERSGA)**

Mr. Maher Amer,
Regional Coordinator of Biodiversity & MPAs Program

**NON-GOVERNMENTAL ORGANIZATIONS
ORGANISATIONS NON-GOUVERNEMENTALES**

**Association de la continuité des
générations (ACG)**

Mme. Sana Taktak,
Présidente

**Centre International de Droit
Comparé de l'Environnement
(CIDCE)**

Josiane Yazbeck,
Chercheur en Droit de l'Environnement / Conseillère Juridique en
Gestion des Risques et Développement Durable

**Egyptian Sustainable Development
Forum (ESDF)**

Mr. Ahmed Zaref,
Egyptian Sustainable Development Forum

Egyptian Youth Ambassadors

Ms. Ghada Ahmadein,
Programme Assistant

GRID-Arendal

Mr. Thomas Maes,
Senior scientist

**Hellenic Centre for Marine
Research/ Institute of
Oceanography (HCMR)**

Ms. Kalliopi Pagou,
Research Director

Ms. Christina Zeri,
Marine expert

Ms. Helen Kaberi,
Researcher

**Hellenic Marine Environment
Protection Association
(HELMEPA)**

Mr. Constantinos Triantafillou,
Head of strategy & development

**International Union for
Conservation of Nature
(IUCN)**

María Del Malr Otero,
Marine Biodiversity & Blue Economy Manager

**Mediterranean Information Office
for Environment, Culture and
Sustainable Development
(MIO-ECSDE)**

Ms. Anastasia Roniotes,
Head Officer,

Ms. Thomais Vlachogianni,
Senior Programme/Policy Officer, Athens

PlasticsEurope

Ms. Anne Gaelle Collot,
Senior Manager Circularity

Ms. Marzia Scopelliti,
Project Officer

WWF-Mediterranean

Camille Loth,
Policy Manager

Annex II
Agenda of the Meeting

- Agenda item 1:** Opening of the Meeting.
- Agenda item 2:** Election of Officers.
- Agenda item 3:** Organizational Matters and Adoption of the Agenda.
- Agenda item 4:** Progress achieved regarding implementation of the Programme of Work 2020-2021 related to Land-Based Pollution and Governance Themes.
- Agenda item 5:** Updates of the annexes of the pollution-related protocols:
- a) Land-Based Sources (LBS) Protocol.
 - b) Protocol for the Prevention and Elimination of Pollution of the Mediterranean Sea by Dumping from Ships and Aircraft or Incineration at Sea.
- Agenda item 6:** Review of the new/upgraded Regional Plans in accordance with Article 15 of the LBS Protocol on:
- a) Urban Wastewater Treatment.
 - b) Sewage Sludge Management.
 - c) Marine Litter Management in the Mediterranean.
- Agenda item 7:** Indicator-based midterm evaluation of the implementation of National Action Plans/Programme of Measures (2015-2020).
- Agenda item 8:** Cross-Cutting Issues - The Integration and Aggregation Rules for IMAP Ecological Objectives 5, 9 and 10 and Assessment Criteria for Contaminants, Nutrients and Marine Litter:
- a) Integration and Aggregation Rules for Monitoring and Assessment of (IMAP Pollution and Marine Litter Cluster.
 - b) Updated Baseline Values and Proposal for Threshold Values for IMAP Common Indicator 22.
 - c) Background (Assessment) Concentrations (BC/BAC) for Common Indicator 17 and Upgraded Approach for Environmental Assessment Criteria (EAC) for IMAP Common Indicators 17, 18 and 20.
 - d) Assessment Criteria Methodology for IMAP Common Indicator 13: Pilot Application in Adriatic Sub-region.
- Agenda item 9:** MED POL Programme of Work 2022-2023.
- Agenda item 10:** Any other business (*in relation to agenda items 1 to 9*).
- Agenda item 11:** Conclusions and recommendations (*in relation to agenda items 1 to 9*).
- Agenda item 12:** Harmonization and standardization of IMAP Pollution Cluster Monitoring:
- d) Monitoring Guidelines/Protocols for IMAP Common Indicators 13, 14, 17, 18, 20 and 23.
 - e) Monitoring Guidelines/Protocols for Analytical Quality Assurance and Reporting Monitoring Data for IMAP Common Indicators 13, 14, 17, 18 and 20.
 - f) Monitoring Guidelines/Protocols for Floating Microplastics.

Agenda item 13: Common methodologies on estimation techniques for the National Baseline Budget (NBB) of pollutants related to:

- a) Non-point source releases from agriculture.
- b) Point source releases from aquaculture.
- c) Non-point source releases from catchment runoffs.

Agenda item 14: Review of assessments for development of three new Regional Plans in accordance with Article 15 of the LBS Protocol for the biennium 2022-2023 on:

- a) Agricultural practices and discharged pollutants reaching the Mediterranean marine environment.
- b) Aquaculture practices in the Mediterranean and their impact on the marine environment.
- c) State of urban storm water management in the Mediterranean.

Agenda item 15: Methodologies and techniques for the assessment and monitoring of adverse impacts of dumping activities.

Agenda item 16: Any other business (*in relation to agenda items 12 to 15*)

Agenda item 17: Conclusions and recommendations (*in relation to agenda items 12 to 15*)

Agenda item 18: Closure of the Meeting

Annex III
Conclusions and Recommendations

Conclusions and Recommendations of the Initial Session of Part I of the Meeting of the MED POL Focal Points, 27-28 May 2021

On 27 and 28 May 2021, the First Session of the Meeting of the MED POL Focal Points was held by videoconference. The meeting was organized by UNEP/MAP Secretariat (MED POL Programme). Further to its deliberations, the Meeting reached the following conclusions:

1. The Meeting reviewed the draft amendments to the Annexes to the LBS Protocol and recommended the final draft revised version as contained in Appendix I to these conclusions for submission to the Meeting of the MAP Focal Points for their consideration.
2. The Meeting reviewed the draft amendments of the Annex to the Dumping Protocol and recommended the final draft revised version as contained in Appendix II to these conclusions for submission to the Meeting of the MAP Focal Points for their consideration.
3. The Meeting reviewed the Draft Regional Plan on Urban Wastewater Treatment in the Framework of Article 15 of the LBS Protocol and recommended the final draft revised version as contained in Appendix III to these conclusions for submission to the Meeting of the MAP Focal Points for their consideration.
4. The Meeting reviewed the Draft Regional Plan on Sewage Sludge Management in the Framework of Article 15 of the LBS Protocol and recommended the final draft revised version as contained in Appendix IV to these conclusions for submission to the Meeting of the MAP Focal Points for their consideration.
5. The Meeting reviewed the Draft Updated Regional Plan on Marine Litter Management in the Mediterranean in the Framework of Article 15 of the LBS Protocol and recommended the final draft revised version as contained in Appendix V to these conclusions for submission to the Meeting of the MAP Focal Points for their consideration.
6. The Meeting reviewed the proposed Programme of Work for the new biennium 2022-2023 and recommended the final draft revised version as contained in Appendix VI to these conclusions for integration into the MAP Programme of Work. The Meeting highlighted the need to prioritize the activities, particularly contribution to the delivery of the QSR pollution and litter cluster; and operationalizing of the implementation of the Regional Plans measures as well as their effectiveness, as well as implementation of the national IMAPs.
7. The Meeting requested the Secretariat to rationalize the number of meetings to enhance the effectiveness of the work and requested the Secretariat to consider additional resources to support MED POL work.
8. The Meeting requested the Secretariat to organize a “resumed session” of Part I of the MED POL Focal Points Meeting to review agenda items that could not be addressed due to time constraints at the present session. The Secretariat confirmed that the resumed session will be held on 9 July 2021.

Conclusions and Recommendations of the Resumed Session of Part I of the Meeting of the MED POL Focal Points, 9 July 2021

On 9 July 2021, the “resumed session” of the First Part of the Meeting of the MED POL Focal Points was held by videoconference. The meeting was organized by UNEP/MAP Secretariat (MED POL Programme) and focused on agenda items not covered during the First Session of the Meeting that convened on 27 and 28 May 2021. Further to its deliberations, the Meeting reached the following conclusions:

9. Further to its review of Working Document UNEP/MED WG.509/9 “Indicator-based midterm evaluation of the implementation of National Action Plans/Programme of Measures (2015-2020),” the Meeting took note of progress achieved by the Contracting Parties to the Barcelona Convention in the implementation of the National Action Plans for the years 2015-2020, as well as the gaps identified in the evaluation report. The Meeting requested the Secretariat (MEDPOL) to continue supporting the Contracting Parties for implementation of the National Action Plans and to consider bridging the gaps highlighted in the conclusions of the evaluation. The Meeting confirmed the fulfillment of the mandate given to the Secretariat to undertake the evaluation as stipulated in Decision IG.22/8 (COP 19, Athens, Greece, 9-12 February 2016), and recommended submission of Document UNEP/MED WG.509/9 to the MAP Focal Points Meeting in September 2021.

10. The Meeting reviewed Working Document UNEP/MED WG.509/10/rev.2 “Integration and Aggregation Rules for Monitoring and Assessment of IMAP Pollution and Marine Litter Cluster.” The Meeting appreciated the work quality and in-depth analysis undertaken by the Secretariat to develop the proposed integration and aggregation methodology. The Meeting did not reach consensus on the document, and although some Contracting Parties (Croatia, Bosnia and Herzegovina, Montenegro, Greece) were in favor of submitting the document to the EcAP Coordination Group, the Meeting recommended that the document be returned to the CorMon for further clarifications from technical and scientific considerations with a view to avoid possible confusion with the scope/mandate of the Barcelona Convention and its Protocols. The Meeting also requested the Secretariat to include in the report of the meeting information on the reasons why the First Session of the MED POL Focal Points Meeting decided to remove document WG.509/inf14 from the list of documents.

11. The Meeting reviewed Working Document UNEP/MED WG.509/11 “Updated Baseline Values and Proposal for Threshold Values for IMAP Common Indicator 22.” The Meeting thanked the Secretariat for updating the Baseline Values (BV) and proposing Threshold Values (TV) further to a commonly agreed methodology. The Meeting recommended submission of Document UNEP/MED WG.509/11 to the 8th EcAp Coordination Group Meeting in September 2021 for its consideration. The Meeting equally recommended the submission of the updated Baseline Values (BV) and proposed Threshold Values (TV) for adoption by COP22.

12. The Meeting reviewed Working Document UNEP/MED WG.509/12 “Background (Assessment) Concentrations (BC/BAC) for Common Indicator 17 and Upgraded Approach for Environmental Assessment Criteria (EAC) for IMAP Common Indicators 17, 18 and 20.” The Meeting appreciated the work undertaken by the Secretariat and recommended submission of Document UNEP/MED WG.509/12 to the 8th EcAp Coordination Group Meeting in September 2021 for its consideration.

13. The Meeting reviewed Working Document UNEP/MED WG.509/13 “Assessment Criteria Methodology for IMAP Common Indicator 13: Pilot Application in Adriatic Subregion.” The Meeting took note and thanked the Secretariat of the work undertaken and recommended submission of Document UNEP/MED WG.509/13 to the 8th EcAp Coordination Group Meeting in September 2021 for its consideration.

14. Further to presentation of Working Document UNEP/MED WG.509/3 “Progress achieved regarding implementation of the Programme of Work 2020-2021 related to Land-Based Pollution and Governance Themes,” the Meeting acknowledged the progress achieved and appreciated the work undertaken by MED POL and the Contracting Parties to achieve the planned outputs as mandated in the PoW for the biennium 2020-2021.

Conclusions and Recommendations of Part II of the Meeting of the MED POL Focal Points, 6-7 October 2021

On 6 and 7 October 2021, the Meeting of the MED POL Focal Points – Part II was held by videoconference. The meeting was organized by UNEP/MAP Secretariat (MED POL Programme).

15. Further to its deliberations, the Meeting reached the following conclusions:

15.1 Monitoring Guidelines/Protocols for IMAP Common Indicators 13, 14, 17, 18, 20 and 23

- a) The Meeting acknowledged the excellent work undertaken by the Secretariat – MED POL in collaboration with the International Atomic Energy Agency – Marine Environmental Studies Laboratory (IAEA/MESL) and with the support of the distinguished scientists and experts representing the Contracting Parties towards strengthening the substantial knowledge for the implementation of the standardized and harmonized IMAP Pollution Cluster monitoring practices and increasing the comparability of the national monitoring programmes. The Meeting expressed an appreciation for their efforts made to consistently and thoroughly address the technical proposals provided during and immediately after the Integrated Meetings of the Ecosystem Approach Correspondence Groups on IMAP Implementation (CORMONs) (Videoconference, 1-3 Dec. 2020) and the Meeting of CorMon on Pollution Monitoring (Videoconference, 26-28 April 2021).
- b) The Meeting agreed on the monitoring methodologies and practices recommended for sampling; sample preservation and transportation; as well as sample preparation and analysis of hydrographic physical and chemical parameters, key nutrients in seawater (i.e., nitrogen, phosphorous, silica compounds) and Chlorophyll *a* related to IMAP Common Indicators 13 and 14, and approved the Meeting documents UNEP/MED WG.509/15 to 509/20 for their use by the IMAP competent laboratories in order to ensure the representativeness and accuracy of the analytical results related to IMAP Pollution Cluster, including for the preparation of the 2023 MED QSR.
- c) The Meeting agreed on the monitoring methodologies and practices elaborated for sampling; sample preservation and transportation; as well as sample preparation and analysis of heavy and trace elements and organic contaminants in sediment and biota related to IMAP Common Indicator 17, as well as in seawater as non-mandatory matrix, and approved the Meeting documents UNEP/MED WG.509/21 to 509/26 for their use by the IMAP competent laboratories in order to ensure the representativeness and accuracy of the analytical results related to IMAP Pollution Cluster, including for the preparation of the 2023 MED QSR.
- d) The Meeting agreed on the monitoring methodologies and practices elaborated for sampling, sample preparation and biomarkers analysis, i.e. Lysosomal membrane stability (LMS), Micronuclei (MNi) frequency, Acetylcholinesterase (AChE) activity and Stress on Stress (SoS) of Marine Molluscs (such as *Mytilus* sp.) and Fish (such as *Mullus barbatus*) related to IMAP Common Indicator 18 and approved the Meeting documents UNEP/MED WG.509/27, WG.509/28 and WG.509/29, as amended during the discussion, as presented in WG.509/43/L.3, for their use by the IMAP competent laboratories in order to ensure the representativeness and accuracy of the analytical results related to IMAP Pollution Cluster, including for the preparation of the 2023 MED QSR.
- e) The Meeting agreed on the monitoring methodologies and practices elaborated for sampling, sample preservation and transportation; as well as sample preparation and analysis of heavy and trace elements and organic contaminants in sea food related to IMAP Common Indicator 20 and approved the Meeting documents UNEP/MED WG.509/30 and WG.509/31 for their use by the IMAP competent laboratories in order to ensure the representativeness and

accuracy of the analytical results related to IMAP Pollution Cluster, including for the preparation of the 2023 MED QSR.

- f) The Meeting agreed on the procedures for Analytical Quality Assurance and Reporting of Monitoring Data elaborated in respective protocols in order to ensure the representativeness and accuracy of the analytical results for generation and reporting of quality-assured monitoring data and approved the Meeting documents UNEP/MED WG.509/32 and WG.509/33 for their use by the IMAP competent laboratories in order to move forward the implementation of standardized and harmonized IMAP monitoring practices.
- g) The Meeting requested the Secretariat - INFO/RAC to finalize Data Standards (DSs) and Data Dictionaries (DDs) for IMAP Common Indicators 18 and 20 for their integration in the IMAP Info System by taking into account the proposals elaborated in Annex IV of the Meeting document UNEP/MED WG.509/33 and shared with the 8th Meeting of the EcAp Coordination Group further to the technical requests provided during the Meeting of CorMon on Pollution Monitoring (26-28 April 2021), in order to support reporting of monitoring data for IMAP CIs 18 and 20 for preparation of the 2023 MED QSR.
- h) The Meeting agreed on the Monitoring Guidelines/Protocols for Floating Microplastics and approved the Meeting Document UNEP/MED WG.509/34, as presented in WG.509/43/L.3, for its use by the IMAP competent laboratories in order to ensure the representativeness and accuracy of the analytical results related to IMAP Marine Litter Cluster (Ecological Objective 10, Common Indicator 23), including for the preparation of the 2023 MED QSR.
- i) The Meeting acknowledged that the scope and purpose of the document (i.e. to focus explicitly on microplastics) is in line with the IMAP Common Indicator 23. The Meeting took note that micro-litter is not comprising only of microplastics and that additional material can be found floating in the water column. The Meeting recommended to the Secretariat to consult on this matter with experts representing the Contracting Parties at the next CORMON Marine Litter Meeting in 2022 in order to explore, as need be, the ways of incorporating additional micro-litter categories in document UNEP/MED WG.509/34.
- j) The Meeting took note of further work of the Secretariat that will be undertaken in collaboration with IAEA/MESL in order to provide optimal design of the Monitoring Guidelines for their practical use by the technical personnel of national IMAP competent laboratories.
- k) The Meeting expressed an expectation that the Monitoring guidelines prepared for IMAP Common Indicators 13, 14, 17, 18, 20 and 22 will provide great support to national IMAP competent laboratories in their endeavors to deliver quality-assured data for the future assessments in the Mediterranean, especially to the ongoing preparation of the 2023-MED QSR.

15.2 Common methodologies on estimation techniques for the National Baseline Budget (NBB) of pollutants

- a) The Meeting appreciated the work undertaken by the Secretariat for preparation of the Guidelines on estimation techniques and applied methodologies for non-point source releases from agriculture and from catchment runoffs corresponding to Meeting documents UNEP/MED WG.509/35 and WG.509/37, respectively. The Meeting approved the documents and recommended the use of the aforementioned Guidelines for the preparation of the 5th Cycle of NBB update for the biennium 2024-2025, including for the preparation of the Final Indicator-Based Evaluation of NAP Implementation.
- b) The Meeting appreciated the work undertaken by the Secretariat for preparation of the Guideline on estimation techniques and applied methodologies for point source releases

from aquaculture as iterated in Meeting document UNEP/MED WG.509/36. The Meeting approved the document and recommended the use of the aforementioned Guideline for the preparation of the 5th Cycle of NBB update for the biennium 2024-2025. The Meeting further recommended its use to plan the collection of data for assessment of pressures and development of an indicator on nutrient releases from the aquaculture sector.

15.3 Review of assessments for development of three new Regional Plans in the biennium 2022-2023 on agricultural, aquaculture, and urban storm water management

- a) The Meeting appreciated the work undertaken by the Secretariat for preparation of the assessments on (i) agricultural practices and discharged pollutants reaching the Mediterranean marine environment; (ii) aquaculture practices in the Mediterranean and their impact on the marine environment, in cooperation with Plan Bleu Regional Activity Centre; and (iii) state of urban storm water management in the Mediterranean, as iterated in meeting documents UNEP/MED WG.509/38, WG.509/39 and WG.509/40. The Meeting took note of the assessments' findings and introduced specific data and information in document WG.509/39, as presented in WG.509/43/L.3, related to Bluefin Tuna farming in the Mediterranean. The Meeting recommended using the three assessment documents for further elaborating the new Regional Plans on Agriculture, Aquaculture, and Urban Storm Water Management.

15.4 Methodologies and techniques for the assessment and monitoring of adverse impacts of dumping activities

- a) The Meeting agreed on the methodologies and techniques for the assessment and monitoring of adverse impacts of dumping activities included in Meeting Document UNEP/MED WG.509/41. The Meeting appreciated the close collaboration with IMO LC/LP (London Convention/London Protocol) to develop the aforementioned methodologies and techniques and approved their use for the assessment and monitoring of adverse impacts of dumping activities, as well as to facilitate the reporting obligations of the Contracting Parties with the aim of achieving more compatible and comparable data under the Dumping Protocol.
- b) The Meeting reviewed the Compendium of Best Practices for implementation of the Dumping Protocol as iterated in Meeting Document UNEP/MED WG.509/42. The Meeting appreciated the work undertaken by the Secretariat showcasing examples for monitoring of dredging and disposal operations and approved the submission of the document for publication.

Appendix 1

Proposals for Updating the Annexes to the LBS Protocol

LAND-BASED SOURCES (LBS) PROTOCOL
ANNEX I: ELEMENTS TO BE TAKEN INTO ACCOUNT IN THE PREPARATION OF
ACTION PLANS, PROGRAMMES AND MEASURES FOR THE ELIMINATION OF
POLLUTION FROM LAND-BASED SOURCES AND ACTIVITIES³

This annex contains elements which will be taken into account in the preparation of action plans, programmes and measures for the elimination of pollution from land-based sources and activities referred to in articles 5, 7 and 15 of this Protocol.

Such action plans, programmes and measures will aim to cover the sectors of activity listed in section A and also cover the groups of substances enumerated in section C, selected on the basis of the characteristics listed in section B of the present annex.

Priorities for action should be established by the Parties, on the basis of the relative importance of their impact on public health, the environment and socio-economic and cultural conditions. Such programmes should cover point sources, diffuse sources and atmospheric deposition.

In preparing action plans, programmes and measures, the Parties, in conformity with the Global Programme of Action for the Protection of the Marine Environment from Land-based Activities, adopted in Washington, D.C. in 1995, will give priority to substances that are toxic, persistent and liable to bioaccumulate, in particular to persistent organic pollutants (POPs), as well as to wastewater treatment and management.

A. SECTORS OF ACTIVITY

The following sectors of activity (not listed in order of priority) will be primarily considered when setting priorities for the preparation of action plans, programmes and measures for the elimination of the pollution from land-based sources and activities:

1. Energy production;
2. Fertilizer production;
3. Production and formulation of biocides;
4. The pharmaceutical industry;
5. Petroleum refining;
6. The paper, paper-pulp and wood production and processing industry;
7. Cement production;
8. The tanning and dressing industry including leather dyeing and finishing;
9. The metal industry including thermal processes in the metallurgical industry;
10. Mining and quarrying;
11. The shipbuilding and repairing industry;
12. Harbour operations;
13. The textile industry including textile pre-treatment, dyeing and finishing;
14. The electronic industry;
15. The recycling industry;
16. Other sectors of the organic chemical industry;
17. Other sectors of the inorganic chemical industry;
18. Tourism and leisure activities and infrastructure, including cruise shipping;
19. Agriculture;
20. Animal husbandry including animal slaughterhouses and animal by-products industries;
21. Food processing;
22. Aquaculture and fishing;
23. Treatment and disposal of hazardous wastes;
24. Treatment and disposal of urban wastewater;

³ Gray highlighted text reflects changes introduced to update the annex

25. Management, including treatment and disposal, of urban solid waste;
26. Disposal of sewage sludge;
27. The waste management industry;
28. Incineration of waste and management of its residues;
29. Works which cause physical alteration of the natural state of the coastline including physical restructuring of rivers, coastline or seabed (water management);
30. Transport;
31. Construction;
32. Water collection and supply including desalination of seawater.
33. Mixed industrial zones including at least one of the above sectors.

B. CHARACTERISTICS OF SUBSTANCES IN THE ENVIRONMENT

For the preparation of action plans, programmes and measures, the Parties should take into account the characteristics listed below:

1. Persistence;
2. Toxicity or other noxious properties (e.g. carcinogenicity, mutagenicity, teratogenicity);
3. Bioaccumulation;
4. Radioactivity;
5. The ratio between observed concentrations and no observed effect concentrations (NOEC);
6. The risk of eutrophication of anthropogenic origin;
7. Health effects and risks;
8. Transboundary significance;
9. The risk of undesirable changes in the marine ecosystem and irreversibility or durability of effects, in particular:
 - a) adverse impacts on species composition and spatial and temporal variation per species/population, including distribution, abundance, and/or biomass, fecundity, survival and mortality/injury rates and behavior
 - b) adverse impacts on habitats characteristics;
10. Interference with the sustainable exploitation of living resources or with other legitimate uses of the sea;
11. Effects on the taste and/or smell of marine products for human consumption;
12. Effects on the smell, colour, transparency or other characteristics of seawater;
13. Distribution pattern (i.e. quantities involved, use patterns and probability of reaching the marine environment);
14. Potential for long-range environmental transport.

C. CATEGORIES OF SUBSTANCES

The following categories of substances and sources of pollution will serve as guidance in the preparation of action plans, programmes and measures:

1. Organohalogen compounds and substances which may form such compounds in the marine environment. Priority will be given to Aldrin, Chlordane, DDT, Dieldrin, Dioxins and Furans, Endrin, Heptachlor, Hexachlorobenzene, Mirex, PCBs, Toxaphene; Polychlorinated Biphenyls (PCBs), Polychlorinated dibenzodioxins (PCDDs), Polychlorinated dibenzofurans (PCDFs), endosulfan and its related isomers, hexachlorocyclohexane, Diethylhexylphthalate (DEHP), Chlordecone, Hexabromobiphenyl, Hexabromodiphenyl ether and heptabromodiphenyl ether, Lindane, Pentachlorobenzene, Tetrabromodiphenyl ether and pentabromodiphenyl ether, Perfluorooctane sulfonic acid and its salts, and perfluorooctane sulfonyl fluoride, hexabromocyclododecane (HBCD), hexachlorobutadiene, pentachlorophenol and its salts and esters, and polychlorinated naphthalenes;
2. Total suspended particulates, total Volatile Organic Compounds (VOC), Nitrogen oxides, NH₃, sulfur oxide;
3. Organophosphorus compounds and silicon substances which may form such compounds in the marine environment;
4. Organotin compounds and substances which may form such compounds in the marine environment;

5. Polycyclic aromatic hydrocarbons;
6. Heavy metals and their compounds. Priority given to chromium, cadmium, lead, mercury, nickel, organic tin compounds, organic mercury compounds and organic lead compounds;
7. Used lubricating oils;
8. Radioactive substances, including their wastes, when their discharges do not comply with the principles of radiation protection as defined by the competent international organizations, taking into account the protection of the marine environment;
9. Biocides and their derivatives;
10. Pathogenic microorganisms;
11. Crude oils and hydrocarbons of petroleum origin;
12. Cyanides and fluorides;
13. Non-biodegradable detergents and other nonbiodegradable surface-active substances;
14. Compounds of nitrogen and phosphorus and other substances which may cause eutrophication, including biodegradable substances expressed as Biological Oxygen Demand (BOD) or Chemical Oxygen Demand (COD) or Total Organic Carbon (TOC), Total Nitrogen and Total Phosphorus;
15. Litter (any persistent manufactured or processed solid material which is discarded, disposed of, or abandoned in the marine and coastal environment) including plastics, microplastic and micro-sized litter;
16. Thermal discharges and input of other forms of energy;
17. Acid or alkaline compounds which may impair the quality of water;
18. Non-toxic substances that have an adverse effect on the oxygen content of the marine environment;
19. Non-toxic substances that may interfere with any legitimate use of the sea;
20. Non-toxic substances that may have adverse effects on the physical or chemical characteristics of seawater.
21. Brine;
22. Phenolic compounds, brominated flame retardants, polycyclic aromatic hydrocarbons and short chain chlorinated paraffins;
23. Chemicals used for the preservation and/or treatment of wood, timber, wood pulp, cellulose, paper, hides and textiles.

ANNEX II: ELEMENTS TO BE TAKEN INTO ACCOUNT IN THE ISSUE OF THE AUTHORIZATIONS FOR DISCHARGES OF WASTES

With a view to the issue of an authorization for the discharges of wastes containing substances referred to in article 6 to this Protocol, particular account will be taken, as the case may be, of the following factors:

A. CHARACTERISTICS AND COMPOSITION OF THE DISCHARGES

1. Type and size of point or diffuse source (e.g. industrial process).
2. Type of discharges (e.g. origin, average composition).
3. State of waste (e.g. solid, liquid, sludge, slurry).
4. Total amount (volume discharged, e.g. per year).
5. Discharge pattern (continuous, intermittent, seasonally variable, etc.).
6. Concentrations with respect to relevant constituents of substances listed in annex I and of other substances as appropriate.
7. Physical, chemical and biochemical properties of the waste discharges.

B. CHARACTERISTICS OF DISCHARGE CONSTITUENTS WITH RESPECT TO THEIR HARMFULNESS

1. Persistence (physical, chemical, biological) in the marine environment.
2. Toxicity and other harmful effects.
3. Accumulation in biological materials or sediments.
4. Biochemical transformation producing harmful compounds.

5. Adverse effects on the oxygen content and balance.
6. Susceptibility to physical, chemical and biochemical changes and interaction in the aquatic environment with other sea-water constituents which may produce harmful biological or other effects on any of the uses listed in section E below.
7. All other characteristics as listed in annex I, section B.

C. CHARACTERISTICS OF DISCHARGE SITE AND RECEIVING ENVIRONMENT

1. Hydrographic, meteorological, geological and topographical characteristics of the coastal area.
2. Location and type of the discharge (outfall, canal outlet, etc.) and its relation to other areas (such as amenity areas, spawning, nursery, and fishing areas, shellfish grounds) and other discharges.
3. Initial dilution achieved at the point of discharge into the receiving environment.
4. Dispersion characteristics such as effects of currents, tides and wind on horizontal transport and vertical mixing.
5. Receiving water characteristics with respect to physical, chemical, biological and ecological conditions in the discharge area, as well as the ecosystem functions and processes, in particular temperature, hydrology, bathymetry, turbidity, transparency, sound, salinity, nutrients, organic carbon, chlorophyll, dissolved gases, acidity (pH), links between species of marine birds, mammals, reptiles, fish and cephalopods and habitats, pelagic-benthic community shifts and productivity.
6. Capacity of the receiving marine environment to receive waste discharges without undesirable effects.

D. AVAILABILITY OF WASTE TECHNOLOGIES

The methods of waste reduction and discharge for industrial effluents as well as domestic sewage should be selected taking into account the availability and feasibility of:

- (a) Alternative treatment processes;
- (b) Re-use or elimination methods;
- (c) On-land disposal alternatives;
- (d) Appropriate low-waste technologies.

E. POTENTIAL IMPAIRMENT OF MARINE ECOSYSTEMS AND SEA-WATER USES

1. Effects on human health through pollution impact on:
 - (a) Edible marine organisms extraction and cultivation of living resources;
 - (b) Bathing waters;
 - (c) Aesthetics including color and odor;
2. Effects on marine ecosystems including food webs, in particular living resources, endangered species and critical habitats including from:
 - (a) Noise
 - (b) Artificial light
 - (c) Acidification
 - (d) Hydrographic changes
3. Physical restructuring of rivers, coastline or seabed
4. Effects on other legitimate uses of the sea.

ANNEX III: CONDITIONS OF APPLICATION TO POLLUTION TRANSPORTED THROUGH THE ATMOSPHERE

This annex defines the conditions of application of this Protocol to pollution from land-based sources transported by the atmosphere in terms of Article 4.1(b) are the following:

1. This Protocol shall apply to polluting discharges into the atmosphere under the following conditions:
 - (a) the discharged substance is or could be transported to the Mediterranean Sea Area under prevailing meteorological conditions;

(b) the input of the substance into the Mediterranean Sea Area is hazardous for the environment in relation to the quantities of the same substance reaching the Area by other means.

2. This Protocol shall also apply to polluting discharges into the atmosphere affecting the Mediterranean Sea Area from land-based sources within the territories of the Parties and from fixed manmade offshore structures, subject to the provisions of article 4.2 of this Protocol.

3. In the case of pollution of the Mediterranean Sea Area from land-based sources through the atmosphere, the provisions of articles 5 and 6 of this Protocol shall apply progressively to appropriate substances and sources listed in annex I to this Protocol as will be agreed by the Parties.

4. Subject to the conditions specified in paragraph 1 of this annex, the provisions of Article 7.1 of this Protocol shall also apply to:

(a) discharges - quantity and rate - of substances emitted to the atmosphere, on the basis of the information available to the Contracting Parties concerning the location and distribution of air pollution sources;

(b) the content of hazardous substances in fuel and raw materials;

(c) the efficiency of air pollution control technologies and more efficient manufacturing and fuel burning processes;

(d) the application of hazardous substances in agriculture and forestry.

5. The provisions of annex II to this Protocol shall apply to pollution through the atmosphere whenever appropriate. Air pollution monitoring and modelling using acceptable common emission factors and methodologies shall be carried out in the assessment of atmospheric deposition of substances, as well as in the compilation of inventories of quantities and rates of pollutant emissions into the atmosphere from land-based sources.

6. All Articles, including parts thereof to this Protocol not mentioned in paragraphs 1 to 5 above shall apply equally to pollution from land-based sources transported by the atmosphere wherever applicable and subject to the conditions specified in paragraph 1 of this Annex.

ANNEX IV :CRITERIA FOR THE DEFINITION OF BEST AVAILABLE TECHNIQUESAND BEST ENVIRONMENTAL PRACTICE

A. BEST AVAILABLE TECHNIQUES

1. The use of the best available techniques shall aim at preventing or minimizing the environmental impacts along all stages of life cycle of products and keeping as long as possible the value of products, materials and resources in the economy, minimizing the generation of waste.

2. The term “best available techniques” means the latest stage of development (state of the art) of processes, of facilities or of methods of operation which indicate the practical suitability of a particular measure for preventing and, where is not practicable, reducing discharges, emissions and waste. In determining whether a set of processes, facilities and methods of operation constitute the best available techniques in general or individual cases, special consideration shall be given to:

(a) comparable processes, facilities or methods of operation which have recently been successfully tried out;

(b) technological advances and changes in scientific knowledge and understanding;

(c) the economic feasibility of such techniques;

(d) time limits for installation in both new and existing plants;

(e) the nature, effects and volume of the discharges and emissions concerned;

(f) the commissioning dates for new or existing installations;

(g) the consumption and nature of raw materials used in the process and its energy efficiency;

(h) the need to prevent or reduce the overall impact of the releases to the environment and the risks to it;

(i) the need to prevent accidents and to minimize their consequences for the environment;

(j) the need to ensure occupational health and safety at workplaces.

(k) the need to use non-toxic substances in view of facilitating non-toxic waste streams to facilitate recovery and recycling

(l) the need to keep material and products in use as long as possible

3. It therefore follows that what is “best available techniques” for a particular process will change with time in the light of technological advances, economic and social factors, as well as changes in scientific knowledge and understanding.

4. If the reduction of discharges and emissions resulting from the use of best available techniques does not lead to environmentally acceptable results, additional measures have to be applied.

5. “Techniques” include both the technology used and the way in which the installation is designed, built, maintained, operated and dismantled.

B. BEST ENVIRONMENTAL PRACTICE

6. The term “best environmental practice” means the application of the most appropriate combination of environmental control measures and strategies to prevent and control pollution, to design out waste and pollution, to keep products and material in use and to regenerate natural systems. In making a selection for individual cases, at least the following graduated range of measures should be considered:

- (a) the provision of information and education to the public and to users about the environmental consequences of choice of particular activities and choice of products, their use and ultimate disposal;
- (b) the development and application of codes of good environmental practice, which cover all aspects of the activity in the product’s life;
- (c) the mandatory application of labels informing users of environmental risks related to a product, its use and ultimate disposal;
- (d) saving resources, including energy;
- (e) making collection and disposal systems as well as reuse centres available to the public;
- (f) avoiding the use of hazardous substances or products and the generation of hazardous waste;
- (g) establishing processes (i.e., industrial symbiosis) by which wastes, or by-products of an industry or industrial process become the raw materials for another
- (h) the application of economic instruments to activities, products or groups of products;
- (i) establishing a system of licensing, involving a range of restrictions or a ban;
- (j) the use of eco-labels, eco-design and eco-innovation to identify products proven to be environmentally sound;
- (k) establishing collaboration along the value chain in order to ensure that the origin and value of raw materials remain traceable when closing the loop;

7. In determining what combination of measures constitute best environmental practice, in general or individual cases, particular consideration should be given to:

- (a) the environmental hazard of the product and its production, use and ultimate disposal;
- (b) the substitution by less polluting activities or substances;
- (c) the scale of use;
- (d) the potential environmental benefit or penalty of substitute materials or activities;
- (e) advances and changes in scientific knowledge and understanding;
- (f) time limits for implementation;
- (g) social and economic implications;
- (h) the potential for keeping material and resources in use (e.g., through product services systems)

8. It therefore follows that best environmental practice for a particular source will change with time in the light of technological advances, economic and social factors, as well as changes in scientific knowledge and understanding.

9. If the reduction of inputs resulting from the use of best environmental practice does not lead to environmentally acceptable results, additional measures have to be applied and best environmental practice redefined.

C. GENERAL PREVENTION MEASURES RELATING TO BEST AVAILABLE TECHNIQUES AND BEST ENVIRONMENTAL PRACTICES

10. Priority should be given to the application of BAT and implementation of BEP to the sectors and categories of substances listed in Annex.

Appendix 2

Proposals for Updating the Annex to the Dumping Protocol

DUMPING PROTOCOL TO THE BARCELONA CONVENTION⁴

ANNEX

The factors to be considered in establishing criteria governing the issue of permits for the dumping of matter at sea taking into account Article 6 include:

A. CHARACTERISTICS AND COMPOSITION OF THE MATTER

1. Total amount and average compositions of matter dumped (e.g. per year).
2. Origin and form (e.g. solid, sludge, liquid, or gaseous within the matter, e.g. gases in sediments, or any mixture of these forms).
3. Properties: physical (e.g. solubility and density), chemical and biochemical (e.g. oxygen demand, nutrients) and biological (e.g. presence of viruses, bacteria, yeasts, parasites, invasive species).
4. Toxicity including but not limited to, trace metals, organohalogens, organosilicons, biocides (e.g. TBT), petroleum hydrocarbons, or other toxic substances, and as their mixtures.
5. Persistence: physical, chemical and biological.
6. Accumulation and biotransformation in biological materials and sediments including but not limited to, trace metals, organohalogens, organosilicons, biocides (e.g. TBT) or other toxic substances.
7. Susceptibility to physical, chemical, and biochemical changes and interaction in the aquatic environment with other dissolved organic and inorganic materials.
8. Probability of production of taints or other changes reducing marketability of resources (fish, shellfish, etc.)
9. Presence of marine litter/debris (e.g. plastic materials, micro-litter, etc.).

B. CHARACTERISTICS OF DUMPING SITE AND METHOD OF DEPOSIT

1. Location of the dumping site (e.g. coordinates, depth and distance from the coast), location/distance in relation to other amenities, values and other uses of the sea in the areas under consideration (e.g. amenity areas, spawning, nursery and fishing areas, marine protected areas and exploitable resources).
2. Rate of disposal per specific period (e.g. quantity per day, per week, per month).
3. Methods of packaging and containment, if any.
4. Initial dilution achieved by proposed method of release, particularly the speed of the ship.
5. Physical, chemical and biological characteristics of the water-column and the seabed, including:
 - a) Dispersal characteristics (e.g. effects of currents, tides and wind on horizontal transport and vertical mixing).
 - b) Water characteristics, physical, chemical and biological (e.g. temperature, pH, salinity, turbidity, transparency, stratification, oxygen indices of pollution-dissolved oxygen (DO), chemical oxygen demand (COD), biochemical oxygen demand (BOD5), nitrogen present in organic and mineral form, including suspended matter, other dissolved gases, organic carbon, other nutrients (phosphate and silicate) and productivity).
 - c) Bottom characteristics (e.g. substrate, topography/morphology, geochemical and geological characteristics and biological productivity).
 - d) Levels of underwater noise, particularly in relation to sensitive resources (e.g. cetaceans and pinnipeds, etc.)
6. Existence and effects of other dumpings which have been made in the dumping area (e.g. heavy metal background reading and organic carbon content).
7. Assessment of the constituent fluxes associated with dumping in relation to existing fluxes of substances in the marine environment.
8. Consideration of the physical characteristics of the waste proposed for disposal in relation to the site characteristics and waste assessment.

⁴ Gray highlighted text reflects changes introduced to update the annex

9. Assessment of potential effects of dumping in the selected site(s) using, *inter alia*, modelling tools and cumulative effects of other activities in the same maritime sector, taking into consideration C.1, C.2 and C.3 under “Section C: General Considerations and Conditions”.

10. When issuing a permit for dumping, the Contracting Parties shall endeavour to determine whether an adequate scientific basis exist for assessing the consequences of such dumping in the area concerned, in accordance with the foregoing provisions and taking into account seasonal variations. If it is accepted that a permit can be issued, then a suitable field monitoring programme may be developed/implemented, where appropriate.

C. GENERAL CONSIDERATIONS AND CONDITIONS

1. Possible effects on amenities (e.g. presence of floating or stranded material, turbidity, objectionable odor, discoloration and foaming).

2. Possible effects on marine life, fish and shellfish culture, fish stocks and fisheries, seaweed harvesting and culture, as well as effect on local communities living near islands or near marine protected areas.

3. Possible effects on other uses of the sea (e.g. impairment of water quality for industrial use, such as desalination plants, underwater corrosion of structures, interference with ship operations from floating materials, interference with fishing, mariculture, or navigation through deposit of waste or solid objects on the sea floor and protection of areas of special importance for scientific or conservation purposes).

4. Consideration of possible waste reduction/prevention techniques at source including: a) product reformulation; b) clean production technologies; c) process modification; d) input substitution; e) and on-site, closed-loop recycling.

5. Consideration of the following hierarchy of waste or other matter management options: re-use; off-site recycling; destruction of hazardous constituents; treatment to reduce or remove the hazardous constituents; disposal on land and in water.

6. The practical availability of alternative land-based methods of treatment, disposal or elimination or of treatment to render the matter less harmful for sea dumping.

7. Economic and operational feasibility.

Appendix 3

Regional Plan on Urban Wastewater Treatment in the Framework of Article 15 of the LBS Protocol

ARTICLE I

Definition of Terms

For the purpose of this Regional Plan for Urban Wastewater Treatment; hereinafter referred to as the "Regional Plan":

- a) "Agglomeration" means an area where the population and/or economic activities are sufficiently concentrated for urban wastewater to be collected and conducted to an urban wastewater treatment plant or to a final discharge point;
- b) "Appropriate treatment" means treatment of urban wastewater by any process and/or disposal system which after discharge allows the receiving waters to meet the relevant quality objectives;
- c) "Aquifer" is an underground rock formation or sedimentary deposit porous enough to hold water that can be used to supply wells;
- d) "Aquifer recharge" is the process of water infiltration by rainfall or other surface water into the ground. Groundwater recharge or deep percolation is a hydrologic process, whereby water moves downward from surface water to groundwater;
- e) "Best Available Techniques (BAT)" as defined in Annex IV for the Land-Based Source and Activities (LBS) Protocol;
- f) "Best Environmental Practice (BEP)" as defined in Annex IV for the Land-Based Source and Activities (LBS) Protocol;
- g) "Biochemical Oxygen Demand (BOD5)" Amount of oxygen needed for the biochemical oxidation of the organic matter to carbon dioxide in 5 days;
- h) "Collecting system" means a system of conduits which collects and conducts urban wastewater;
- i) "Contaminants of Emerging Concern (CEC)" include several types of chemicals: persistent organic pollutants (POPs), pharmaceuticals and personal care products (PPCPs), including a wide suite of human prescribed drugs, veterinary medicines such as antimicrobials, antibiotics, anti-fungal, growth promoters and hormones; endocrine-disrupting chemicals (EDCs), including synthetic estrogens and androgens, nanomaterials such as carbon nanotubes or nano-scale particulate titanium dioxide, of which little is known about either their environmental fate or effects;
- j) "Domestic wastewater" means wastewater from residential settlements and services which originates predominantly from the human metabolism and from household activities;
- k) "Emission Limit Value (ELV)" means the maximum allowable concentration of a pollutant in an effluent discharged to the environment;
- l) "Good Environmental Status": Concentrations of nutrients in the euphotic layer are in line with prevailing physiographic, geographic and climate conditions;
- m) "Industrial wastewater" means any wastewater which is discharged from premises used for carrying on any trade or industry, other than domestic wastewater and run-off rainwater;
- n) "Managed aquifer recharge (MAR)" is defined as the intentional recharge of water to aquifers for subsequent recovery or environmental benefit;
- o) "One (1) population equivalent (p.e.)" means the organic biodegradable load having a five-day biochemical oxygen demand (BOD5) of 60 grams of oxygen per day. For the purpose of this regional plan, the load expressed in p.e. shall be calculated on the basis of the maximum

average weekly load entering the treatment plant during the year, excluding unusual situations such as those due to heavy rain;

- p) "Primary treatment" means treatment of urban wastewater by a physical and/or chemical process involving settlement of suspended solids, or other processes in which the BOD5 of the incoming wastewater is reduced by at least 20 percent before discharge and the total suspended solids of the incoming wastewater are reduced by at least 50 percent;
- q) "Reclaimed water" urban wastewater that has been treated to meet specific water quality criteria with the intent of being used for a range of beneficial purposes;
- r) "Secondary treatment" means treatment of urban wastewater by a process generally involving biological treatment with a secondary settlement or other process so that the treatment results in a minimum reduction of the initial load of 70 to 90 percent of BOD5;
- s) "Tertiary treatment" means treatment of urban wastewater by processes generally involving physical, chemical, biological and other procedures so that the treatment results in reduction of phosphorus and nitrogen, as well as disinfection;
- t) "Urban wastewater" means the domestic wastewater or the mixture of domestic wastewater with industrial wastewater and/or run-off rainwater;
- u) "WEFE" means Water – Energy – Food – Ecosystem Nexus;
- v) "Wastewater Treatment Plant (WWTP)" means systems used to treat urban wastewater using physical, chemical and/or biological techniques.

ARTICLE II

Scope and Objective

1. The area to which the Regional Plan applies is the area defined in accordance with Article 3 of the LBS Protocol, consisting of the Mediterranean Sea Area as defined in Article 1 of the Convention; the hydrologic basin of the Mediterranean Sea Area; waters on the landward side of the baselines from which the breadth of the territorial sea is measured and extending, in the case of watercourses, up to the freshwater limit; brackish waters, coastal salt waters including marshes and coastal lagoons; and ground waters communicating with the Mediterranean Sea.
2. The Regional Plan shall apply to the collection, treatment, reuse and discharge of urban wastewaters and the pre-treatment and discharge of industrial wastewater from certain industrial sectors.
3. The objective of the Regional Plan on Urban Wastewater Treatment is to protect the coastal and marine environment and human health from the adverse effects of the above mentioned wastewater direct and or indirect discharges, in particular regarding adverse effects on the oxygen content of the coastal and marine environment and eutrophication phenomena as well as promote resource water and energy efficiency.

ARTICLE III

Preservation of Rights

4. The provisions of this Regional Plan shall be without prejudice to stricter provisions respecting the management of urban wastewater treatment plants contained in other existing or future national, regional or international instruments or programs.

ARTICLE IV Guiding Principles

5. The Regional Plan measures are formulated to ensure the application of the following principles:
 - i. Effective reclamation and reuse of treated wastewater is promoted as a means for water resource conservation and efficiency to effectively address regional water scarcity;
 - ii. Wastewater collection and treatment systems incorporate aspects related to climate change impacts in the design and operation phases, including extreme hydrological patterns and their impact on influent wastewater;
 - iii. Wastewater treatment processes promote energy efficiency and water savings, and integrate renewable energy alternatives to the extent possible in accordance with BAT and BEP;
 - iv. Industrial wastewater is treated to the extent possible on site. Industrial wastewater entering collecting systems and WWTPs are subject to pre-treatment, if necessary, in order to (a) protect the collecting systems and the treatment plant; (b) ensure that the operation of the WWTP and the treatment of the sludge are not impeded; and (c) ensure that discharge effluents do not adversely affect the Mediterranean marine environment, particularly for priority substances, contaminants of emerging concern which are harmful to the receiving waters and cannot be treated in urban WWTPs;
 - v. For the purpose of this Regional Plan, WEFE nexus is incorporated into the design phase of WWTPs with the aim to promote energy efficiency and reuse of reclaimed wastewater;
 - vi. Selection of treatment technologies takes into consideration investment and operational costs of the treatment technology and the ability to pay by beneficiaries in order to ensure sustainable and reliable quality-treated wastewater.

ARTICLE V Measures

I. Collection and treatment of urban wastewater

6. The Contracting Parties shall ensure that all agglomerations are provided with collecting systems for urban wastewater as follows:
 - i. [At the latest by 2025] for those with a population equivalent (p.e.) of more than 15,000;
 - ii. [At the latest by 2035 [2030]] for those with a population equivalent (p.e.) between 2000 and 15,000.
7. The Contracting Parties shall set emission limit values for discharge of treated effluents from WWTPs upon implementation of necessary measures. To this aim, the Contracting Parties shall adopt at the latest by [2025] the emission limit values as provided for in Annex I for the following categories:
 - i. Discharge of effluents from urban wastewater treatment plants to the environment (Annex I.A).
 - ii. Reuse of reclaimed wastewater for agriculture irrigation Annex I.B).
 - iii. Discharge of industrial wastewater into collecting systems and urban wastewater treatment plants (Annex I.C).
8. The Contracting Parties may approve stricter emission limit values than those provided in Appendix I considering the characteristics of receiving/recipient environment.

9. The Contracting Parties shall ensure that prior to discharge, treated wastewater from urban WWTPs meets the following requirements [by 2035 [2030] at the latest]:⁵
 - i. All discharges from agglomerations attributed to a population size of more than 15,000 p.e. are subject to the extent possible to tertiary treatment provided that the Good Environmental Status (GES) of the recipient environment is maintained.
 - ii. All discharges from agglomerations attributed to a population size of between 2000 and 15,000 p.e. are subject to the extent possible to secondary treatment provided that the Good Environmental Status (GES) of the recipient environment is maintained.
10. The Contracting Parties shall promote to the extent possible nature-based solutions for small agglomerations of less than 2000 p.e. with a focus on constructed wetlands where applicable.
11. The Contracting Parties shall ensure that urban wastewater treatment plants, built to comply with the requirements of Articles 7 and 8, are designed, constructed, operated and maintained to ensure sufficient performance under normal local climatic conditions.
12. The Contracting Parties shall ensure that WWTPs are designed to account for:
 - i. Seasonal variations of loads including from touristic activities;
 - ii. Volume and characteristics of the local municipal wastewater; and
 - iii. Limitation of pollution of receiving water (taking into consideration, inter alia, Contaminants of Emerging Concern).
13. The Contracting Parties shall implement measures for:
 - i. Segregating collecting systems for storm water and municipal wastewater, if technically and economically feasible;
 - ii. Preventing or if not possible minimizing sewage and wastewater treatment plants' overflow due to rainwater penetration and flooding;
 - iii. Addressing impacts of points of discharge of treated wastewater so as to minimize effects on receiving waters;
 - iv. Adopting tools for conservation of surface water runoff in built environment; and
 - v. Reducing pollutant loads and litter in storm water runoff from municipal and industrial sources.

II. Reclamation and reuse of wastewater

14. The Contracting Parties shall promote the reuse of reclaimed wastewater. To this aim, the Contracting Parties shall:

⁵ Study reservation by Italy, Spain, Malta and France to be clarified by the MAP Focal points Meeting. France indicates that "it is not coherent to talk about "population" and then to express it in terms of "population equivalents". France proposes in an email communicated to the Secretariat on 30 June 2021 rewriting of this paragraph as follows:

The Contracting Parties shall ensure that prior to discharge, treated wastewater from urban WWTPs meets the following requirements [by 2035 [2030] at the latest]:

- i. All discharges from agglomerations over than 15,000 p.e. are subject to the extent possible to tertiary treatment provided that the Good Environmental Status (GES) of the recipient environment is maintained.
- ii. All discharges from agglomerations of size of between 2000 and 15,000 p.e. are subject to the extent possible to secondary treatment provided that the Good Environmental Status (GES) of the recipient environment is maintained.

- i. Ensure that treatment technologies and additional treatments for reclaimed wastewater meet the emission limit values for reuse of reclaimed wastewater as provided for in Annex I.B.
- ii. Implement wastewater reuse systems that include, inter alia:
 - a) Storage and distribution systems for reuse of reclaimed wastewater effluents in agriculture;
 - b) Recharge methods in case of managed aquifer recharge strictly complying with Annex II Guiding Principles.

III. Industrial wastewater discharge

15. By [2025 at the latest], the Contracting Parties shall ensure that the competent authority or appropriate body adopt emission limit values appropriate to the nature of industry discharging industrial effluents to collecting systems connected to urban WWTPs.
16. By [2035 at the latest], the Contracting Parties shall ensure that industrial wastewater discharged into collecting systems and urban WWTPs shall meet, as a minimum, the emission limit values set in Annex I.C.

IV. Monitoring

17. The Contracting Parties shall take measures to ensure regular monitoring in accordance with general elements and monitoring frequencies requirements as provided in Appendix III of the Regional Plan:
 - i. Discharges from urban wastewater treatment plants to verify compliance with the requirements.
 - ii. Receiving waters subject to discharges from urban wastewater treatment plants.
 - iii. Quality of reclaimed wastewater discharged from treatment plants for beneficial use.
 - iv. Discharged industrial effluents to collecting systems including substances harmful to receiving waters, sewerage networks and urban wastewater treatment plants.

ARTICLE VI

Technical Assistance, Transfer of Technology and Capacity Building

18. For the purpose of facilitating the effective implementation of Article V of this Regional Plan, the Contracting Parties collaborate to implement, exchange and share best practices directly or with the support of the Secretariat including BAT, BEP, sustainable consumption and production, circular economy, resource efficiency, WEF Nexus in the design, construction, operation and maintenance of the urban wastewater treatment plants in the context of Integrated Water Resources Management. To this aim, the Contracting Parties also collaborate in preparing and implementing common technical guidelines.

ARTICLE VII

Timetable for Implementation

19. The Contracting Parties shall implement the measures included in this Regional Plan as per the timelines associated with these measures.

ARTICLE VIII
Reporting

20. The Contracting Parties shall report on implementation of measures stipulated in this Regional Plan in line with the reporting requirement and timelines provided in Article 26 of the Convention and Article 13, paragraph 2(d) of the LBS Protocol.

ARTICLE IX
Entry into Force

21. The present Regional Plan shall enter into force and become binding on the 180th day following the day of notification by the Secretariat in accordance with Article 15, paragraphs 3 and 4, of the LBS Protocol.

ANNEX I.A: Emission Limit Values for discharge of effluents from urban wastewater treatment plants to the environment

Table 1: Emission limit values for discharge of urban wastewater effluents to the environment *

Parameter	Unit	Emission limit values
BOD₅	mg/L	25
Total phosphorous	mg/L	2
Total Nitrogen	mg/L	40
Arsenic (As)	mg/L	0.5
Cadmium (Cd)	mg/L	0.025
Chlorine residual	mg/L	0.3
Chromium (Cr)	mg/L	0.25
COD	mg/L	125
Copper (Cu)	mg/L	0.5
Cyanide	mg/L	0.01
Lead (Pb)	mg/L	0.04
Mercury (Hg)	mg/L	0.0025
Mineral Oil	mg/L	1.5
Nickel	mg/L	0.25
pH	pH unit	6 to 9
Phenol	mg/L	0.15
Total Suspended Solids (TSS)	mg/L	30
Zinc	mg/L	1
Total Hydrocarbons	mg/L	10

* Different emission limit values, including for other parameters, may be adopted further to a risk-based assessment provided that there is no negative impact on the recipient environment

Emission limit values (ELVs) for other emerging pollutants may be set considering the following factors:

- Setting thresholds for toxicity of effluent streams discharged to the environment to prevent toxicity to aquatic organisms;
- Determination of the minimum percentage of biodegradability of the effluent streams (at least 80%) to achieve minimum accumulation in the ecosystem and losses of habitats and biodiversity; and
- Identification of potential microplastic sources and adoption of related policy and methodology further to state of the art on related research on this topic.

ANNEX I.B: Emission limit values for reuse of reclaimed wastewater for agriculture irrigation

Classes definitions for reclaimed wastewater for reuse in agriculture irrigation:

Class A – **All food crops**, including crops eaten raw when reclaimed wastewater comes into direct contact with edible parts of the crop, and irrigation of root crops.

Class B - **Processed food crops**: crops which are intended for human consumption not to be eaten raw but after a treatment process and **Non-food crops**: crops which are not intended for human consumption.

Table 2: Emission limit values for reclaimed wastewater use in agricultural irrigation according to Class definition

Parameter	Limit values for reclaimed water quality class for effluent reuse in agricultural irrigation *	
	Class A	Class B
BOD5	≤10 mg/L	25 mg/L or reduction of the influent load of 70% to 90%.
COD**	100 mg/L	125 mg/L
Escherichia coli	≤10 cfu/100 ml	≤100 cfu/100 ml
Fecal Coli	≤10 cfu/100ml or below detection limit	≤100 cfu/100ml
Intestinal nematodes (helminth eggs)	≤1 egg/l	≤1 egg/l
Legionella spp	≤1,000 cfu/l	≤1,000 cfu/l
Total Suspended Solids (TSS)	≤10 mg/L	35 mg/L or reduction of influent load of 90%.
Turbidity	≤5 NTU	None
Parameters applicable to both Classes (A and B)		
Total Nitrogen	25	
Total phosphorous	5	
Sodium - Na	150	
Chlorides - Cl	250	
Boron - B	0.5	
Heavy metals		
Cadmium - Cd	0.01	
Chromium - Cr	0.1	
Copper - Cu	0.2	
Mercury - Hg	0.002	
Nickel - Ni	0.2	
Lead - Pb	0.1	
Zinc - Zn	0.5	
pH	6.5-8.5	
Additional heavy metals		
Aluminium - Al	1 to 5	
Arsenic - As	0.1	
Beryllium - Be	0.1	
Cobalt - Co	0.05	
Iron - Fe	2	
Lithium - Li	2.5	
Manganese - Mn	0.2	

Parameter	Limit values for reclaimed water quality class for effluent reuse in agricultural irrigation *	
	Class A	Class B
Molibdenum - Mo	0.01	
Selenium - Se	0.02	
Vanadium - V	0.1	

* Different emission limit values, including for different parameters, may be adopted further to a risk-based assessment provided that the total loads do not affect the recipient environment and human health

ANNEX I.C: Emission limit values for discharge of industrial wastewater into collecting systems and urban wastewater treatment plants

Industrial wastewater entering collecting systems and urban wastewater treatment plants shall be subject to pre-treatment as required in order to:

- Protect the health of staff working in collecting systems and treatment plants.
- Ensure that collecting systems, WWTP and associated equipment are not damaged.
- Ensure that the operation of the WWTP and the treatment of sludge are not impeded.
- Ensure that discharges from the treatment plants do not adversely affect the environment or prevent receiving water from complying with other regulatory requirements.
- Ensure that sludge can be treated and disposed of safely in an environmentally acceptable manner.

Table 3: Emission limit values (ELV) for industries to discharge their effluents to collecting systems and Urban WWTPs which will not damage wastewater treatment processes and does not affect the recipient environment

Parameter	Unit	Limit values for effluent discharge *
Aluminium - Al	mg/L	25
BOD5	mg/L	COD concentration not to exceed four times BOD concentration
Fluoride – F	mg/L	6
Sodium - Na	mg/L	230
Phenols	mg/L	3
Total O&G	mg/L	250
Arsenic - As	mg/L	0.1
Benzene	mg/L	0.05
Beryllium - Be	mg/L	0.5
Cadmium - Cd	mg/L	0.1
Chloride - Cl	mg/L	430
Chlorine	mg/L	0.5
Chromium - Cr	mg/L	0.5
Cobalt - Co	mg/L	1
COD	mg/L	2000
Copper - Cu	mg/L	0.5 to 1
Cyanide	mg/L	0.2 to 0.5
AOX	mg/L	1
Lead - Pb	mg/L	0.5
Lithium - Li	mg/L	0.3
Manganese - Mn	mg/L	1
Mercury - Hg	mg/L	0.05
Mineral Oil	mg/L	20
Molybdenum - Mo	mg/L	0.15

Parameter	Unit	Limit values for effluent discharge *
Nickel - Ni	mg/L	0.5
Total phosphorous - (TP)	mg/L	30
pH	units	6.0-10.0
Polyphenols	mg/L	100
Selenium - Se	mg/L	0.05
Total Dissolved Solids (TDS)	mg/L	3,500
Temp	C°	40° Celsius
Tin - Sn	mg/L	2
Total Nitrogen - (TN)**	mg/L	15-30
Total Hydrocarbons	mg/L	20
Toxicity to fish eggs (Tegg)		2
Total Suspended Solids (TSS)	mg/L	1000
Vanadium - V	mg/L	0.5
Volatile halogenated hydrocarbons (VHHC)	mg/L	0.1***
Zinc - Zn	mg/L	3

* The adoption and implementation of the ELVs shall respond to the respective industries. Different emission limit values, including for different parameters, may be adopted further to a risk-based assessment also in line with national regulations and procedures in collaboration with the operators of treatment plants. ELV may be increased for small industries discharging to the collecting system when (i) the plant uses BAT and (ii) the effects of the discharged effluent on the collecting system and the WWTP are negligible.

** Total nitrogen as the sum of ammonia nitrogen, nitrite nitrogen and nitrate nitrogen

*** Volatile halogenated hydrocarbons - sum of trichloroethene, tetrachloroethene, 1,1,1-trichloroethane, dichloromethane - calculated as chlorine

ANNEX II: Guiding principles on reuse of reclaimed wastewater for aquifer recharge

Managed aquifer recharge (MAR) is defined as the intentional recharge of water to aquifers for subsequent recovery or environmental benefit. The purposes for undertaking managed aquifer recharge are as follows:

- Establish saltwater intrusion barriers in coastal aquifers.
- Provide storage for the recharged water for subsequent retrieval and reuse.
- Maintain groundwater dependent terrestrial and aquatic ecosystems.
- Dilute saline or polluted aquifers.
- Control or prevent ground subsidence.

Recharge methods:

1. **Surface spreading** – a method of recharge whereby the water moves from the land surface to the aquifer by infiltration and percolation through the vadose zone. When used as a recharge method, adverse effects to the soil and related dependent ecosystems should be avoided.
2. **Direct injection** – a method of directly pumping/ injecting water into the groundwater zone. Direct discharges of pollutants into groundwater is not allowed.

Risk assessment:

Health and environmental risk assessment is needed to define minimum quality requirements. The assessment will address appropriate health protection; provision of public confidence in reuse practices; avoiding adverse effects on groundwater, soils and related dependent ecosystems. The overall levels of health protection should be comparable for different water-related exposures (i.e. drinking water, and reclaimed water for irrigation of food crops).

ANNEX III: Monitoring frequencies of pollutants discharged directly to the environment; or destined for reuse in agriculture; or discharged from industrial facilities to collecting systems

Monitoring the treated effluents discharge from urban WWTPs is used to determine compliance with emission limit values for discharge to the environment; to reuse in agriculture irrigation; or for aquifer recharge (Annex I.A, Annex I.B, Annex I.C).

Monitoring frequencies need to be sufficient to characterize the effluent quality and to detect events of noncompliance, considering the need for data and, as appropriate, the potential cost. Monitoring frequency should be determined on a case-by-case basis, consider the variability of the concentration of various parameters. A highly variable discharge should require more frequent monitoring than a discharge that is relatively consistent over time (particularly in terms of flow and pollutant concentration).

Frequency requirements may be reduced based on a demonstration of excellent performance. Facilities can demonstrate good performance by meeting a set of compliance and enforcement criteria and demonstrating their ability to discharge pollutants below the necessary levels consistently.

The sampling frequency for monitoring of the discharge effluents may be defined to the extent possible as per the tables below:

Table 4: Recommended sampling frequency for treated effluents at the point of discharge

Parameter	Monitoring Frequency		Grab / Composite sample
	Large UWWTP (more than 5,000 p.e.)	Small UWWTP (less than 5,000 p.e.)	
Heavy metals	Once a quarter	Once a year	Composite sample
EC + pH	Continuous monitoring	Once a month	Grab samples
BOD, COD	Once a week	Once a month	Composite sample
Turbidity	Once a week	Once a month	Grab samples
TSS	Every two weeks	Once a month	Composite sample
Nutrients (N, P, K)	Once a week	Once a month	Composite sample
Pathogens	Every two weeks	Once a month	Grab samples
Mineral Oil, Phenol, Total Hydrocarbons	Once a month	Once a month	Grab samples

Table 5: Minimum frequency for reclaimed wastewater monitoring for agricultural irrigation

Parameter	Monitoring Frequency for reclaimed wastewater quality classes	
	Class A	Class B
BOD	Once a week	Once a month
TSS	Once a week	Once a month
Turbidity	Continuous	Once a month
Escherichia coli	Once a week	Twice a month
Legionella spp (when applicable)	Once a week	Once a week
Intestinal nematodes (when applicable)	Twice a month or frequency determined according to the number of eggs in wastewater	
Heavy metals	Once a quarter	Once a year
EC and pH	Continuous monitoring	Once a month
Nutrients (N, P, K)	Once a week	Once a month

Table 6: Recommended sampling frequency per year for industrial wastewater at the point of discharge to the collecting systems and urban WWTP

No.	Industrial Activities	Sampling frequency (*)
1	Wastewater containing mineral oil	4 Once every three months
2	Domestic and communal wastewater (function halls, restaurants, shopping malls, hotels etc.)	4 Once every three months
3	Food Sector - Animal and vegetable products	4 Once every three months
4	Food Sector - Meat industry & Fish processing	4 Once every three months
5	Textile sector - manufacturing and finishing	4 Once every three months
6	Metals production and processing	6 Once every two months
7	Laundry Facilities	4 Once every three months
8	Gas stations	4 Once every three months
9	Agriculture: chicken farms, pig farms, fish farms, etc.	4 Once every three months
10	Leather production, fur processing, leather fibreboard manufacturing	4 Once every three months
11	Waste and wastewater management	Waste – 4 Once every three months Hazardous waste – 6 Once every two months
12	Production of printing blocks, publications and graphic-arts products	4 Once every three months
13	Chemical industry including chemicals, pharmaceuticals, fertilizers, pesticides, detergents, solvents, petrochemicals, Cosmetic, plastic etc.	Water consumption: - less than 5,000 m ³ /year – 6 once every two months - higher than 5,000 m ³ /year – 12; once per a year
14	Hospitals	4 Once every three months

* The sampling rate should reflect the fluctuation of the effluent

Appendix 4

**Regional Plan on Sewage Sludge Management
in the Framework of Article 15 of the LBS Protocol**

ARTICLE I

Definition of Terms

For the purpose of this Regional Plan for the Sewage Sludge Management; hereinafter referred to as the "Regional Plan":

- (a) "Anaerobic digestion" is the biological conversion of organic matter to biogas and residual solids at temperatures between 20°C and about 40°C, typically 37°C with a mean residence time of 15 to 30 days (Mesophilic) or that takes place between 49°C and 57°C (thermophilic);
- (b) "Best Available Techniques (BAT)" as defined in Annex IV for the Land-Based Source and Activities (LBS) Protocol;
- (c) "Best Environmental Practice (BEP)" as defined in Annex IV for the Land-Based Source and Activities (LBS) Protocol;
- (d) "Biosolids" are organic-based materials from industrial or municipal wastewater sludge and their derived products, in the form of solids, semisolids, semi-liquids (pasty), and liquids which have been treated to meet specific standards, guidelines or requirements;
- (e) "Collecting system" means a system of conduits which collects and conducts urban wastewater;
- (f) "Composting" is the natural aerobic biological process, carried out under controlled conditions, which converts organic material into a stable humus-like product;
- (g) "Domestic wastewater" means wastewater from residential settlements and services which originates predominantly from the human metabolism and from household activities;
- (h) "Industrial wastewater" means any wastewater which is discharged from premises used for carrying on any trade or industry, other than domestic wastewater and run-off rainwater;
- (i) "Primary sludge" is sludge from primary settling tanks, typically grayish and slimy in nature, and, in most of the cases, has an extremely offensive odor. Primary sludge can be readily digested under suitable conditions of operation;
- (j) "Primary treatment" means treatment of urban wastewater by a physical and/or chemical process involving settlement of suspended solids, or other processes in which the BOD₅ of the incoming wastewater is reduced by at least 20 percent before discharge and the total suspended solids of the incoming wastewater are reduced by at least 50 percent;
- (k) "Secondary sludge (activated sludge)" is the sludge particles produced in raw or settled wastewater by the growth of organisms in aeration tanks in the presence of dissolved oxygen. The term activated comes from the fact that the particles are teeming with bacteria, fungi, and protozoa. Activated sludge is different from primary sludge in that the sludge particles contain many living organisms which can feed on the incoming wastewater;
- (l) "Secondary treatment" means treatment of urban wastewater by a process generally involving biological treatment with a secondary settlement or other process so that the treatment results in a minimum reduction of the initial load of 70 to 90 percent of BOD₅;
- (m) "Sludge incineration (waste to energy)" is a two-step process involving drying and combustion after a preceding dewatering process, such as filters, drying beds, or centrifuges;
- (n) "Tertiary treatment" means treatment of urban wastewater by processes generally involving physical, chemical, biological and other procedures so that the treatment results in reduction of phosphorus and nitrogen, as well as disinfection;
- (o) "Urban wastewater" means the domestic wastewater or the mixture of domestic wastewater with industrial wastewater and/or run-off rainwater;
- (p) "Wastewater Treatment Plant (WWTP)" means systems used to treat urban wastewater using physical, chemical and/or biological techniques.

ARTICLE II

Scope and Objective

1. The area to which the Regional Plan applies is the area defined in accordance with Article 3 of the LBS Protocol, consisting of the Mediterranean Sea Area as defined in Article 1 of the Convention; the hydrologic basin of the Mediterranean Sea Area; waters on the landward side of the baselines from which the breadth of the territorial sea is measured and extending, in the case of watercourses, up to the freshwater limit; brackish waters, coastal salt waters including marshes and coastal lagoons; and ground waters communicating with the Mediterranean Sea.
2. The Regional Plan shall apply to the treatment, disposal and use of sewage sludge from Urban Wastewater Treatment Plants.
3. The objective of the Regional Plan is to ensure effective reuse of beneficial substances and exploitation of energy potential of sewage sludge, while preventing harmful effects on human health and the environment.

ARTICLE III

Preservation of Rights

4. The provisions of this Regional Plan shall be without prejudice to stricter provisions respecting the management of sewage sludge from urban wastewater treatment plants contained in other existing or future national, regional or international instruments or programs.

ARTICLE IV

Guiding Principles

5. The Regional Plan measures are formulated to ensure the application of the following principles:
 - i. Sewage sludge shall meet the required quality criteria suitable for its intended use or disposal;
 - ii. Management alternatives are prioritized for beneficial use of sewage sludge in agricultural land applications in order to minimize landfilling and adverse environmental effects;
 - iii. Since sewage sludge can have valuable agronomic properties reducing dependence on fertilizers, its application is encouraged in agriculture subject to adequate treatment and quality standards for human health and environment protection.
 - iv. Sewage sludge can be used in other applications such as forests, mine reclamation sites, and other disturbed lands, parks, and golf courses, subject to adequate treatment and quality standards for human health and environment protection;
 - v. Use of sewage sludge does not impair the quality of the soil and of agricultural products;
 - vi. Use of sewage sludge in agriculture is regulated in such a way as to prevent harmful effects on soil, water bodies, vegetation, animals and humans;
 - vii. Sewage sludge may be used as an alternative fuel; energy production; and for incineration and co-incineration and other proven applications.

ARTICLE V

Measures

- I. Treatment of sewage sludge
6. The Contracting Parties shall ensure that all required sludge treatment processes are carried out in line with common agreed guidelines, in order to obtain treated sludge of quality suitable for their specific use in, inter alia:

- i. Agricultural land application as a fertilizer or for land reclamation;
- ii. Energy recovery; and
- iii. Cement industry.

II. Agricultural use

7. For the application of sludge under specific conditions of land application, the Contracting Parties shall apply adequate treatment to limit pathogen contents in biosolids destined for agricultural applications. To this aim, the Contracting Parties shall set classes for sludge with limit values for pathogen contents for biosolids to ensure that use would not affect human health and the environment. The following two “biosolids classes” and corresponding limit values for pathogen content for biosolids are considered. **[By 2025 at the latest, the Contracting Parties shall adopt Class A. Class B may be adopted where appropriate:]**
 - i. Class ‘A’ biosolids suitable for use as fertilizer for agricultural crops having met the pathogen reduction requirements set in Table 1 by treatment processes that include a suitable combination of composting, heat drying, heat treatment, thermophilic anaerobic digestion, beta or gamma ray irradiation and pasteurization, or any other equivalent treatment technologies.
 - ii. Class ‘B’ biosolids suitable for use as fertilizer for non-food crops having met the pathogen reduction requirements set in Table 1 by treatment processes that include a suitable combination of aerobic digestion, composting, anaerobic digestion, lime stabilization and air drying, or any other equivalent treatment technologies.

Table 1: Limit values for pathogen content for biosolids classes				
Class	Faecal Coliforms (<i>Escherichia coli</i>)	Salmonella sp.	Enterovirus*	Helminths ova*
Class A	< 1000 MPN/g DM (<i>< 1000 MPN/g DM</i>)	< 3 MPN/4 g DM	1 PFU/4 g DM**	1 viable/4 g DM
Class B	< 2,000,000 MPN/g DM*** (<i>< 200,000 MPN/g DM</i>)			

* These parameters may be included based on specific local conditions, and if monitored, lower frequencies may apply.

** PFU: Plaque Forming Unit

** MPN: Most Probable Number; DM: Dry Matter

*** Geometric mean of seven samples

8. The Contracting Parties shall apply adequate treatment to limit concentrations of heavy metals in biosolids destined for agricultural applications. To this aim, the Contracting Parties shall adopt limit values for heavy metals to ensure that use would not affect human health and the environment. The following limit values for heavy metals in biosolids (Table 2) and heavy metals in soil (Table 3) shall be adopted at the latest by 2025.

Table 2: Limit values for concentration of heavy metals in biosolids (mg.kg ⁻¹ DS) *							
Range**	Cadmium	Chromium	Copper	Mercury	Nickel	Lead	Zinc
Lower	20	1000	1000	16	300	750	2500
Upper	40	1500	1750	25	400	1200	4000

* Different emission limit values, including for other parameters, may be adopted further to a risk-based assessment if there is no negative impact on the recipient environment.

** To be defined based on local conditions including soil pH.

Table 3: Limit values for concentrations of heavy metals in soil to which biosolids is applied (mg.kg⁻¹ DS) *

Range**	Cadmium	Chromium	Copper	Mercury	Nickel	Lead	Zinc
Lower	1	100	50	1	30	50	150
Upper	3	150	140	1.5	75	300	300

* Different emission limit values, including for other parameters, may be adopted further to a risk-based assessment if there is no negative impact on the recipient environment

** To be defined based on local conditions including soil pH

9. The Contracting Parties shall specify the conditions for use of sludge in its different states (stabilized, treated, untreated) taking into consideration the proximity of sludge application to various types of human activities and civil structure facilities/natural features. To this aim, the Contracting Parties agree to formulate a common guideline.
10. In the event that limit values set in Tables 1 to 3 cannot be met, the Contracting Parties shall apply alternative means to agricultural use including incineration and regulated landfilling ensuring in both cases, that there is no negative impact on the environment (particularly for water sources) and human health, and that disposal of sewage sludge in coastal areas is prohibited.
11. The Contracting Parties shall apply adequate treatment processes to reduce volatile organic compounds and diminish possible odor emissions in the different stages of sludge treatment, transport and application in agriculture and other suitable uses.

III. Sewage sludge use and energy/nutrient recovery

12. The Contracting Parties shall establish the required infrastructure for the implementation of the requirements of the applicable measures of this Regional Plan with regards to the use for agricultural land applications and/or for energy/nutrient recovery at the latest by 2035.

IV. Considerations for reducing impacts of climate change

13. The Contracting Parties shall reduce energy costs and increase water savings during treatment by using BAT and applying BEP including the use of alternative and renewable energy sources based on advanced technologies such as anaerobic digestion, pyrolysis/gasification, mass burning and other technologies.
14. The Contracting Parties shall implement technologies targeting energy efficient treatment of sludge such as pretreatment of sludge, solar drying, bio-drying, composting, etc.
15. The Contracting Parties shall promote implementation of adaptation measures for climate change protection including:
 - i. Taking advantage of the biosolids as an important source of nutrients and organic matter;
 - ii. Using biosolids as soil amendment to combat desertification; improve infiltration of water (precipitation or irrigation water); ensure better drainage in high rainfall areas; and decrease surface water runoff;
 - iii. Increasing on-site carbon sequestration potential.

V. Monitoring

16. The Contracting Parties shall take measures to ensure monitoring of the quality of sewage sludge in the WWTP or after treatment outside the WWTP, whichever constitutes the last treatment process before use, with the aim of determining sludge class as provided for in Article IV of this Regional Plan, and accordingly, to select the adequate monitoring programmes to the extent possible as indicated in Table [4] on the frequency of monitoring for pollutants, pathogen

densities, and vector attraction reduction in sewage sludge. To this aim, the Contracting Parties collaborate to formulate common agreed technical guidelines on routine monitoring of treated sewage sludge.

Table 4: Frequency of monitoring for pollutants, pathogen densities, and vector attraction reduction in Sewage Sludge		
Amount of biosolids [Dry matter] Tons per 365-day period	Tons per day	Frequency
> 0 to < 290	> 0 to < 0.80	Once per year
≥ 290 to < 1,500	≥ 0.80 to < 4.10	Once per quarter (4 times per year)
≥ 1,500 to < 15,000	≥ 4.10 to < 41	Once per 60 days (6 times per year)
≥ 15,000	≥ 41	Once per month (12 times per year)

ARTICLE VI

Technical Assistance, Transfer of Technology and Capacity Building

17. For the purpose of facilitating the effective implementation of the measures and monitoring obligations under Article V of this Regional Plan, the Contracting Parties are urged to consider the techniques provided for in this Plan and to exchange and share best practices directly or with the support of the Secretariat including BAT, BEP, sustainable consumption and production, circular economy, resource efficiency, WEF Nexus in the design, construction, operation and maintenance of the urban wastewater treatment plants.

ARTICLE VII

Timetable for Implementation

18. The Contracting Parties shall implement the measures included in this Regional Plan as per the timelines associated with these measures.

ARTICLE VIII

Reporting

19. The Contracting Parties shall report on implementation of measures stipulated in this Regional Plan in line with the reporting requirement and timelines provided in Article 26 of the Convention and Article 13, paragraph 2(d) of the LBS Protocol.

ARTICLE IX

Entry into Force

20. The present Regional Plan shall enter into force and become binding on the 180th day following the day of notification by the Secretariat in accordance with Article 15, paragraphs 3 and 4, of the LBS Protocol.

Appendix 5

**Draft Updated Regional Plan for Marine Litter Management
in the Mediterranean in the Framework of Article 15 of the LBS Protocol**

Part I – General provisions⁶

ARTICLE 1

Rationale for the Regional Plan

1. Marine litter may have significant implications for the marine and coastal environment at a global level. These impacts are environmental, economic, health and safety and cultural, rooted in our prevailing production and consumption patterns. The problem originates mostly from land-based activities and sea-based activities, as well as lack of governmental financial resources, general lack of understanding of the public's co-responsibility, and the optimisation of the application of legal enforcement systems could limit pollution.
2. The rationale for the preparation of this Regional Plan is to improve the quality of the marine and coastal environment in accordance with the provisions of the LBS Protocol and to achieve the goals set by the decisions of the 17th meeting of the Contracting Parties in 2012, Decision IG.20/4: "Implementing MAP ecosystem approach roadmap: Mediterranean Ecological and Operational Objectives, Indicators and Timetable for implementing the ecosystem approach roadmap" and Decision IG 20/10: "Adoption of the Strategic Framework for Marine Litter management," at the considerable lower cost than with the no action scenario.

ARTICLE 2

Area and Scope of Application

3. The area to which this Regional Plan applies is the area defined in Article 3 of the LBS Protocol paragraphs (a), (c) and (d).⁷ The Regional Plan shall apply to discharges referred to in Article 4(a)⁸ of the LBS Protocol and any operational discharge from ships, platforms and other man-made structures at sea.

ARTICLE 3

Definition of Terms

4. For the purpose of this Regional Plan:
 - a) *Abandoned, lost or otherwise discarded fishing gear or parts thereof (ALDFG) or Derelict fishing gear (DFG)* are the collective terms for commercial and recreational fishing gear or

⁶ *Text highlighted in gray reflects the updates undertaken to the Regional Plan compared to the 2013 version.*

⁷ Article 3 of the LBS Protocol: Protocol Area:

The area to which this Protocol applies (hereinafter referred to as the "Protocol Area") shall be:

- (a) The Mediterranean Sea Area as defined in article 1 of the Convention.*
- (c) Waters on the landward side of the baselines from which the breadth of the territorial sea is measured and extending, in the case of watercourses, up to the freshwater limit.*
- (d) Brackish waters, coastal saltwater including marshes and coastal lagoons, and ground waters communicating with the Mediterranean Sea.*

⁸ Article 4 of the LBS Protocol Application:

This Protocol shall apply: (a) To discharges originating from land-based point and diffuse sources and activities within the territories of the Contracting Parties that may affect directly or indirectly the Mediterranean Sea Area. These discharges shall include those which reach the Mediterranean Area, as defined in article 3(a), (c) and (d) of this Protocol, through coastal disposals, rivers, outfalls, canals, or other watercourses, including ground water flow, or through run-off and disposal under the seabed with access from land.

aquaculture-related items that have been abandoned, lost or otherwise discarded into the marine environment;

- b) *Barcelona Convention* means the Convention for the Protection of the Marine Environment and the Coastal Region of the Mediterranean, 1995 hereinafter referred to as the Barcelona Convention;
- c) *Best Available Techniques (BAT)* as defined in Annex IV for the Land-Based Source and Activities (LBS) Protocol;
- d) *Best Environmental Practice (BEP)* as defined in Annex IV for the Land-Based Source and Activities (LBS) Protocol;
- e) *Circular economy*, an approach contributing to Sustainable Consumption and Production patterns, refers to a system where products, materials and resources maintain their value and use in the economy, for as long as possible, thus minimizing waste by sharing, leasing, reusing, repairing, refurbishing, remanufacturing and recycling, instead of throw-away or take-make-dispose models;
- f) *Extended Producer Responsibility* means a set of measures taken by Contracting Parties to ensure that producers of products bear financial responsibility or financial and organisational responsibility for the management of the waste stage of a product's life cycle;
- g) *Fishing gear* means any item or piece of equipment that is used in fishing or aquaculture to target, capture or rear marine biological resources or that is floating on the sea surface, and is deployed with the objective of attracting and capturing or of rearing such marine biological resources;
- h) *Garbage* includes all kinds of food, domestic and operational waste, all plastics, cargo residues, incinerator ashes, cooking oil, fishing gear, and animal carcasses generated during the normal operation of the ship and liable to be disposed of continuously or periodically. Garbage does not include fresh fish and parts thereof generated as a result of fishing activities undertaken during the voyage, or as a result of aquaculture activities;
- i) *LBS National Action Plan* means the national action plans containing measures and timetables for their implementation developed by the Contracting Parties in accordance with Article 5 of the LBS Protocol as endorsed by the 14th and 19th meetings of the Contracting Parties with the view to implement the Strategic Action Programme (SAP-MED) to combat land-based sources in the Mediterranean adopted by the Contracting Parties in 1997 and UNEP/MAP's ecosystem approach-based ecological objectives on pollution and litter;
- j) *LBS Protocol* means the Protocol for the Protection of the Mediterranean Sea against Pollution from Land-Based Sources and Activities, 1996, hereinafter referred to as the LBS Protocol;
- k) *Leakage* means unintentional disposal of wastes into the marine environment;
- l) *Lightweight plastic carrier bag* means a plastic carrier bag with a wall thickness below 50 microns;⁹
- m) *Marine litter*, regardless of the size, means any persistent, manufactured or processed solid material, discarded, disposed of, or abandoned in the marine and coastal environment;
- n) *Marine Litter monitoring* the long term, standardized measurement, observation and assessment of litter on beaches, in the water column including the sea surface and the seabed and in biota in order to determine litter types, quantities, sources and pathways and assess the effectiveness of measures and whether GES has been achieved by comparing with established baseline and threshold values;
- o) *Micro litter* means the fraction of marine litter of less than 5 mm in size with a further division into *Large Micro Particles* (1-5 mm) and *Small Micro Particles* (<1 mm);
- p) *Microplastics*, most commonly defined as manmade solid particles composed of mixtures of polymers and functional additives, smaller than 5 mm;

- q) *Plastic* means a material consisting of a polymer, to which additives or other substances may have been added, and which can function as a main structural component of final products, with the exception of natural polymers that have not been chemically modified;⁹
- r) *Primary microplastics* are tiny particles designed for direct commercial use (such as cosmetics, detergents and paints components), or for indirect use (such as pre-production pellets);
- s) *Secondary microplastics* means the fraction of microplastics in the marine environment which results from the breakdown of larger plastic items into numerous tiny fragments due to mechanical forces and/or photochemical processes, as well as from other degradation sources such as water bottles, fibres in wastewater from washing clothes and particles of rubber lost from tyres due to normal wear;
- t) *Single Use Plastics (SUPs)*: means an item or product that is made wholly or partly from plastic and that is not conceived; designed or placed on the market to accomplish, within its life span, multiple trips or rotations by being returned to a producer for refill or re-used for the same purpose for which it was conceived;
- u) *Waste* means substances or objects which are disposed of or are intended to be disposed of or are required to be disposed of by the provisions of national law.⁹

ARTICLE 4

Objectives and Principles

Objectives

- 5. The main objectives of the Regional Plan are to:
 - a) Prevent and reduce to the minimum marine litter pollution in the Mediterranean and its impact on ecosystem services, habitats, species (in particular the endangered species), public health and safety, as well as reduction of the socioeconomic costs it causes;
 - b) Remove to the extent possible already existent marine litter by using environmentally sound methods;
 - c) Ensure that the management of marine litter in the Mediterranean is performed in accordance with accepted international standards and approaches as well as those of relevant regional organizations and as appropriate in harmony with programmes and measures applied in other seas;
 - d) Enhance knowledge and understanding on marine litter and its impacts;
 - e) Support Contracting Parties in the development, implementation, and coordination of programmes for litter reduction, including National Action Plans (NAPs).

Principles

- 6. In implementing the Regional Plan, the Contracting Parties shall be guided by:
 - a) *Integration* by virtue of which marine litter management shall be an integral part of the solid waste management and other relevant strategies;
 - b) *Prevention* by virtue of which any marine litter management measure should aim at addressing the prevention of marine litter generation at the source;

⁹ Definition proposed by Malta and agreed by the Contracting Parties in email correspondences received by the Secretariat with no modifications or objections

- c) *Precautionary principle* by virtue of which where there are threats of serious or irreversible damage, lack of full scientific certainty shall not be used as a reason for postponing cost-effective measures to prevent environmental degradation;
- d) *Polluter-pays principle* by virtue of which the costs of pollution prevention, control and reduction measures are to be borne by the polluter, with due regard to the public interest;
- e) *Ecosystem-based approach* by virtue of which the cumulative effects of marine litter on marine and coastal ecosystem, habitats and species with other contaminants and substances that are present in the marine environment should be fully taken into account;
- f) *Public participation and stakeholder involvement*;
- g) *Sustainable Consumption and Production* by virtue of which current unsustainable patterns of consumption and production must be transformed to sustainable ones that decouple human development from environmental degradation, in particular through the use of systemic approaches addressing environmental impacts along the entire value chain, including circular economy.

ARTICLE 5

Preservation of Rights

- 7. The provisions of this Regional Plan shall be without prejudice to stricter provisions respecting marine litter management measures contained in other existing national, regional or international instruments or programmes.

Part II – Measures and Operational Targets

ARTICLE 6

Coherence and Integration of Measures

- 8. The Contracting Parties shall make best effort that the measures provided for in Articles 7 to 10 are implemented, as specified in the respective articles, in a coherent manner to achieve good environmental status and relevant targets on marine litter. Various actors shall be involved in the development and implementation of agreed measures as provided for in Article 17.

ARTICLE 7

Integration of marine litter measures into the LBS National Action Plans (LBS NAPs)

- 9. The Contracting Parties in accordance with Article 5 of the LBS Protocol shall elaborate and implement, individually or jointly, as appropriate, national and regional action plans and programmes, containing measures and timetables for their implementation. In doing so, the Contracting Parties shall consider updating periodically the LBS NAPs to integrate marine litter in accordance with the provisions of this Regional Plan and other means to perform their obligations.
- 10. The LBS National Action Plan shall include:
 - a) Development and implementation of appropriate policy, legal instruments and institutional arrangements, including adequate management plans for solid waste also including those originating from sewer and storm water systems, which shall incorporate marine litter prevention and reduction measures

- b) Monitoring and assessment programmes for marine litter;
- c) Measures and targets to prevent and reduce marine litter;
- d) Measures and targets to increase plastic waste collection and recycling;
- e) Programmes of removal and environmentally sound disposal of existing marine litter according to the national legislation about management of this kind of waste; and
- f) Awareness raising and education programmes.

ARTICLE 8

Legal and Institutional Aspects

11. For the purpose of implementing the Regional Plan, the Contracting Parties shall adopt, as appropriate, the necessary legislation and/or establish adequate institutional arrangements to ensure efficient marine litter including plastic waste and microplastics reduction and the prevention of its generation. To this aim the Contracting Parties shall endeavor to ensure:
 - a) Institutional coordination, where necessary, among the relevant national policy bodies and relevant regional organizations and programmes, in order to promote integration;
 - b) Close coordination and collaboration between national, regional and local authorities in the field of marine litter management;
12. By the year 2028, at the latest, the Contracting Parties shall take adequate regulatory measures to integrate the informal sector¹⁰ into regulated waste collection and recycling schemes;
13. By the year 2025, the Contracting Parties shall establish, as appropriate, a regulatory framework for compostable plastics to be integrated into national waste management policies;
14. The Contracting Parties shall give due consideration to the implementation of the relevant related provisions of the Protocols¹¹ of the Barcelona Convention affecting marine litter management to enhance efficiency, synergies and maximize the results.

ARTICLE 9

Prevention of Marine Litter

15. In conformity with the objectives and principles of the Regional Plan the Contracting Parties shall:

¹⁰ Informal recycling sector (IRS) refers to individuals or community enterprises who are involved in the recovery of material and waste management activities which are not necessarily sponsored, financed, recognized, supported, organized, or acknowledged by the formal solid waste authorities.

¹¹ Specifically in the framework of the Protocol Concerning Cooperation in Preventing Pollution from Ships and, in Cases of Emergency, Combating Pollution of the Mediterranean Sea, 2002 (Port reception facilities); Protocol for the Prevention and Elimination of Pollution of the Mediterranean Sea by Dumping from Ships and Aircraft or Incineration at Sea, 1995 (waste dumping prohibition); Protocol concerning Specially Protected Areas and Biological Diversity in the Mediterranean, 1995 (Regional Plans to protect endangered species; establishment of SPA and SPAMIs); Protocol for the Protection of the Mediterranean Sea against Pollution Resulting from Exploration and Exploitation of the Continental Shelf and the Seabed and its Subsoil, 1994 (prohibition of the disposal of garbage from offshore installations); and the Protocol on the Prevention of Pollution of the Mediterranean Sea by Transboundary Movement of Hazardous Wastes and their Disposal, 1996.

15.1 Apply to the extent possible instruments needed to regulate and prevent marine litter pollution including plastic waste from land-based and sea-based sources, in particular the implementation of **economic instruments**, bans and design requirements:

- a) Extended Producer Responsibility;
- b) Safe/formal markets for recycled plastics that incentivize the collection of plastic waste and, hence, reduce marine litter generation;
- c) Fiscal and economic incentives or other equally effective measures (e.g. market restrictions) to promote the phasing out, of light weight plastic carrier bags and other single-use plastic items which are most found and cause the most impact on the marine and coastal environment;
- d) Innovative business practices to prevent plastic waste generation in line with the Extended Producer Responsibility approach by:
 - i. Establishment of Deposit/Refund System for expandable polystyrene boxes in the commercial and recreational fishing and aquaculture sectors.
 - ii. Establishment of Deposit/Refund System for food and beverage packaging, prioritizing when possible their reuse and recycling including deposit refund systems for bottles, containers and cans (e.g. glass, plastic and aluminium).
- e) Best practices to create incentives for:
 - i. Fishing vessels to retrieve derelict fishing gear, collect other items of marine litter, and deliver it to port reception facilities;
 - ii. Delivering waste in port reception facilities such as the non-special fee system.

15.2 Apply by the year 2025, prevention measures aiming to achieve, to the extent possible, a **circular economy for plastics**:

- a) Regulate the use of primary microplastics, as appropriate, by promoting voluntary commitments (e.g. certification schemes) or other actions (e.g. legal instruments);
- b) Implement Sustainable Procurement Policies prioritizing the phase out of single-use plastic products and promoting reuse options. To this aim, the Contracting Parties may consider the list of Single Use Plastic items presented in Annex I to the regional Plan;
- c) Establish voluntary agreements with retailers and supermarkets to set an objective of reduction of light weight plastic carrier bags consumption as well as selling dry food or cleaning products in bulk and refill special and reusable containers;
- d) Establish procedures and manufacturing methodologies together with the plastic industry in order to minimize the decomposition characteristics of plastic and reduce microplastic;
- e) Identify single-use plastic products which are most found and cause impacts on the marine environment and implement sound measures to phase out consumption and production and minimise the risk to end up in the marine environment. To this aim, the Contracting Parties may consider the list of Single Use Plastic items presented in Annex I to the Regional Plan;
- f) Set targets to phase out production and use of nonreusable, non-recyclable, and non-compostable plastic products;
- g) Take adequate measures to increase the reuse and recycling of plastics toward total plastic products;
- h) Phase-out chemical additives used in plastic products, that may have serious and often irreversible effects on human health and the environment, and in particular those chemicals already listed under the Stockholm Convention contained as annex II of this Regional Plan;

- i) Promote the use of recycled plastics and disincentivize the use of plastic, resins and additives which hinder products recyclability;
- j) Endeavor to substitute plastics causing substantial impacts on the marine environment with materials with net positive impacts verified by life cycle assessment;
- k) Implement standards for product labelling (including on packaging) to provide consumers with clear and reliable information on sustainable choices;
- l) Establish dedicated collection and recycling schemes supported by Extended Producer Responsibility approach for end-of-life products;
- m) Implement measures to minimize the amount of marine litter associated with fishing/aquaculture;
- n) Scale-up and replicate sustainable models providing solutions to reduce single-use plastic products consumption;

15.3 Land-based Sources

- a) By the year 2025, base urban solid waste management on reduction at source, applying the following waste hierarchy as a priority order in waste prevention and management legislation and policy: prevention, preparing for re-use, recycling, other recovery, e.g. energy recovery and environmentally sound disposal;
- b) By the year 2019, implement adequate waste reducing/reusing/recycling measures in order to reduce the fraction of plastic packaging waste that goes to landfill or incineration without energy recovery;
- c) Take the necessary measures by the year 2020 to close to the extent possible the existing illegal dump sites on land in the area of the application of this Regional Plan;
- d) Take the necessary measures by 2027 to identify and, to the extent possible, restore and contain, the coastal landfills that are a source of marine litter;
- e) Apply in accordance with national and regional legislation enforcement measures to combat dumping, littering on the beach, illegal sewage disposal from land sources in the sea, the coastal zone and rivers in the area of the application of this Regional Plan;
- f) Taking into consideration the occurrence and extent of marine litter accumulations, identify and assess by the year 2025, impacts of these accumulations in upstream regions of rivers and their tributaries, and apply measures to prevent or reduce their leakage into the Mediterranean, particularly during flood seasons and other extreme weather events;
- g) Apply enforcement measures to prevent, reduce and sanction illegal dumping and illegal littering in accordance with national and regional legislation, in particular on coastal zones and rivers in the area of the application of the Regional Plan;

15.4 Sea-based Sources

- h) In accordance with Article 14 of the Prevention and Emergency Protocol, explore and implement by 2017, to the extent possible, ways and means to charge reasonable cost for the use of port reception facilities or when applicable, apply No-Special-Fee system. The Contracting Parties shall also take the necessary steps to provide ships using their ports with updated information relevant to the obligations arising from Annex V of MARPOL Convention and from their legislation applicable in the field;
- i) Implement targeted measures by 2025 aiming at preventing and reducing marine litter impact in Marine Protected Areas (MPAs) and Specially Protected Areas of Mediterranean Importance (SPAMIs);

- j) Explore and implement to the extent possible by the year 2017 “Gear marking to indicate ownership” concept and “reduced fishing catches through the use of environmental neutral upon degradation of nets, pots and traps concept,” in consultation with the competent international and regional organizations in the fishing sector;
- k) Apply by the year 2020 the cost-effective measures to prevent any marine littering from dredging activities taking into account the relevant guidelines adopted in the framework of Dumping Protocol of the Barcelona Convention;
- l) Take the necessary measures to ensure that cruise ships flying their flag or entering their ports implement the procedures for minimizing, collecting, storing, processing and disposing of garbage;
- m) Take the necessary measures to promote best practices to prevent plastic waste and particularly single use plastic products in tourism and leisure activities including cruise shipping, including through regional cooperation;
- n) Implement measures on prevention, response and remediation regarding litter from maritime accidents, including containers lost at sea.

ARTICLE 10

Removing Existing Marine Litter and its Environmentally Sound Disposal

- 16 The Contracting Parties shall, where it is environmentally sound and cost effective, remove existing accumulated litter, subject to Environmental Impact Assessment procedure, in particular from Marine Protected Areas (MPAs) and Specially Protected Areas of Mediterranean Importance (SPAMI) and litter impacting endangered species listed in Annexes II and III of the SPA and Biodiversity Protocol. To this aim the Contracting Parties undertake to explore and implement to the extent possible the following measures by the year 2019. To this aim the Contracting Parties undertake to explore and implement to the extent possible the following measures by the year 2019:
- a) Identify, in collaboration with relevant stakeholders, accumulations/hotspots of marine litter at sea and implement, as appropriate, national programmes on their regular removal and sound disposal;
 - b) Implement National Marine Litter Cleanup Campaigns on a regular basis and evaluate their effectiveness;
 - c) Implement Cleanup Campaigns on a regular basis driven by beach; concessionaries/ managers/ local authorities, including outside the touristic season;
 - d) Participate in International Coastal Cleanup Campaigns and Programmes;¹²
 - e) Apply as appropriate ‘Adopt-a-Beach’ or similar practices and enhance public participation role with regard to marine litter management;
 - f) Apply Fishing for Litter in an environmentally sound manner, based on agreed guidelines and best practice, in consultation with the competent international and regional organizations and in partnership with fishermen and ensure adequate collection, sorting, recycling and/or environmentally sound disposal of the fished litter;
 - g) Charge reasonable costs for the use of port reception facilities or, when applicable apply No-Special-Fee system, in consultation with competent international and regional organizations,

¹² e.g. International Coastal Clean-Up Day; the Ocean Day; etc.

when using port reception facilities for implementing the measures provided for in Article 10.

- 17 The Contracting Parties shall explore and implement to the extent possible by the year 2017 the “Fishing for Litter” environmentally sound practices to facilitate clean-up of the floating litter and the seabed from marine litter caught incidentally and/or generated by fishing vessels in their regular activities including derelict fishing gear. [To this aim, the Contracting Parties shall establish, to the extent possible [and as appropriate] by the year 2030, ALDFG removal and recycling programmes].
- 18 The Contracting Parties shall explore and implement to the extent possible by the year 2025, targeted activities for the localization and retrieval, and where possible, reuse or recycling of derelict fishing gear including through new environmentally sustainable technologies.

Part III – Assessment

ARTICLE 11

Assessment of Marine Litter in the Mediterranean

- 19 The Contracting Parties shall assess in the framework of ecosystem approach the state of marine litter, the impact of marine litter on the marine and coastal environment and human health, as well as the socio-economic aspects of marine litter management based on coordinated and, if possible, common agreed methodologies, national monitoring programmes and surveys.
- 20 The Secretariat shall prepare the assessment of marine litter in the Mediterranean every six years using results of the national monitoring programmes and applied measures with the view to address priority issues and major information and data gaps, using all other available relevant regional and international data and where appropriate responses by the Contracting Parties to specific marine litter related questionnaires prepared by the Secretariat.
- 21 The first Assessment of the state of marine litter in the Mediterranean based on the existing information shall be submitted to the meeting of the Contracting Parties two years after entry into force of the Regional Plan.

ARTICLE 12

Mediterranean Marine Litter Monitoring Programme

- 22 Based on ecosystem approach ecological objectives and integrated monitoring programme, and in synergy with the relevant international and regional guidelines and documents, the Contracting Parties, on the basis of the proposals of the Secretariat, shall:
 - a) Prepare the Regional Marine Litter Monitoring Programme, as part of the **Integrated Monitoring and Assessment Programme (IMAP)**;
 - b) Establish in the year 2016 the Regional Data Base on Marine Litter which should be compatible with other regional or overarching databases;
 - c) Establish by the year 2014 Expert Group on Regional Marine Litter Monitoring Programme, in the framework of the implementation of the Ecosystem Approach.
- 23 For the purpose of this Regional Plan and in compliance with the monitoring obligations under Article 12 of the Barcelona Convention and Article 8 of the LBS Protocol, the Contracting Parties shall design by the year 2017 National Monitoring Programme on Marine Litter.
- 24 The National Monitoring Programmes should address:

- a) The need for harmonization and consistency with the integrated regional monitoring programme based on ecosystem approach and consistency with other regional seas;
 - b) Aspects related to monitoring litter originating from riverine inputs;
 - c) The need for litter monitoring in high sensitivity areas (endangered species, key habitats, etc.), and in Specially Protected Areas in the Mediterranean (SPAMIs).
- 25 To this aim, the Secretariat shall prepare, in collaboration with the relevant regional organizations, by the year 2014 the Guidelines for the preparation of the National Marine Litter Monitoring Programmes.

Part IV – Support to Implementation

ARTICLE 13

Research Topics and Scientific Cooperation

- 26 The Contracting Parties agree to cooperate, with support from the Secretariat, with competent international and regional organizations and relevant scientific institutions, on marine litter issues that due to their complexity require further research.

ARTICLE 14

Specific Guidelines

- 27 The Secretariat in cooperation with relevant international and regional organizations, shall prepare specific guidelines, taking into account where appropriate existing guidelines, to support and facilitate the implementation of measures provided for in articles 9 and 10 of the Regional Plan. Subject to availability of external funds such guidelines shall be published in different Mediterranean region languages.

ARTICLE 15

Technical Assistance

- 28 For the purpose of facilitating the implementation of the measures and monitoring obligations as provided for in Articles 7 to 10 and 12 of the Regional Plan, technical assistance, transfer of knowhow and technology shall be provided, including capacity building, by the Secretariat to the Contracting Parties in need of assistance.

ARTICLE 16

Enhancement of Public Awareness and Education

- 29 Due to the nature of the marine litter management issue, enhancement of public awareness and education, and co-responsibility of all stakeholders are very important components of the marine litter management.
- 30 To this aim the Contracting Parties shall undertake to the extent possible, where appropriate, in synergy with existing initiatives in the field of education for sustainable development and environment, and in partnership with civil society, public awareness and education activities, with adequate duration and follow up, with regard to marine litter management including activities related to prevention and promotion of sustainable consumption and production.

ARTICLE 17**Major groups and Stakeholder Participation**

- 31 For the effective implementation of the Regional Plan, the Contracting Parties shall encourage appropriate involvement of, and partnerships with, various stakeholders including local authorities, civil society, private sector (producers, garbage collection and treatment companies, etc.) and other stakeholders as appropriate:
- a) Regional, National and local authorities;
 - b) Maritime sector;
 - c) Tourism sector;
 - d) Fisheries and Aquaculture;
 - e) Agriculture;
 - f) Industry; and
 - g) Civil society.

ARTICLE 18**Regional and International Cooperation**

- 32 For the purpose of facilitating the implementation of the Regional Plan the Secretariat shall establish institutional cooperation with various relevant regional and global institutions and initiatives.
- 33 The Contracting Parties shall cooperate directly or with the assistance of the Secretariat or the competent international and regional organizations to address transboundary marine litter cases.

ARTICLE 19**Reporting**

- 34 In conformity with Article 26 of the Barcelona Convention and Article 13, paragraph 2(d), of the LBS Protocol the Contracting Parties shall report on a biennial basis on the implementation of this Regional Plan, in particular the implementation of the above measures, their effectiveness and difficulties encountered and data resulting from monitoring programme as provided for in Article 12 of this Regional Plan.
- 35 The Contracting Parties shall review biennially the status of implementation of the Regional Plan upon its entry into force, on the basis of the regional report prepared by the Secretariat.

Part V – Final Provisions**ARTICLE 20****Implementation Timetable**

- 36 The Contracting Parties shall implement this Regional Plan, in particular the above measures according to the timetables indicated in the respective Articles of the Regional Plan.

ARTICLE 21**Entry into Force**

- 37 The present Regional Plan shall enter into force and become binding on the 180th day following the day of notification by the Secretariat in accordance with Article 15, paragraphs 3 and 4, of the LBS Protocol.

ARTICLE 22

Enforcement of Measures

- 38 The Contracting Parties shall take the necessary actions to enforce the measures in accordance with their national regulations.

ANNEX I: List of Single Use Plastic (SUP) Items

*Mediterranean priority list of SUPs per group of items**

Group of items	Items
Packaging	Bags
Smoking-related	Cigarette filters
Food and beverage packaging	Drink bottles, caps and lids
	Crisp packets and sweet wrappers
On-the-go food and beverage packaging	Cutlery, plates and trays
	Straws and stirrers
	Drinks cups and cup lids
	Food containers including fast food packaging
WC flushed items	Sanitary applications, including cotton buds, wet wipes and sanitary towels
Personal protective equipment	Masks and gloves

* Source of information: *Regional Guidelines to tackle single use plastic products in the Mediterranean (UNEP/MAP SCP/RAC 2021)*

Annex II: List of Chemical Additives of Concern Used in Plastic Production

List of persistent organic pollutants (POPs) used as additives in plastics and listed in Annex A (elimination) and Annex B (restriction) to the Stockholm Convention as of 2021.¹³

Annex A:

- Decabromodiphenyl ether (commercial mixture, c-decaBDE).
- Hexabromobiphenyl.
- Hexabromocyclododecane (HBCDD).
- Hexabromodiphenyl ether and heptabromodiphenyl ether (commercial octabromodiphenyl ether).
- Tetrabromodiphenyl ether and pentabromodiphenyl ether (commercial pentabromodiphenyl ether).
- Short-chained chlorinated paraffins (SCCPs).
- Perfluorooctanoic acid (PFOA), its salts and PFOA-related compounds.
- Polychlorinated biphenyls (PCB).
- Polychlorinated naphthalenes.

Annex B:

- Perfluorooctane sulfonic acid (PFOS), its salts and perfluorooctane sulfonyl fluoride (PFOSF)

List of additives used in plastics and identified as substance of concern in the information document of the 2019 Meetings of the conferences of the Parties to the Basel, Rotterdam and Stockholm conventions (UNEP/POPS/COP.9/INF/28/Add.1 - Plastic and toxic additives, and the circular economy: the role of the Basel and Stockholm Conventions) and main sectors concerned:

1. Substances of concern:

- **Flame-retardants:** polybrominated diphenyl ethers (PBDEs) including commercial pentabromodiphenyl ether (tetraBDE and pentaBDE), commercial octabromodiphenyl ether (hexaBDE and heptaBDE), decabromodiphenyl ether (decaBDE); decabromodiphenylethane (DBDPE); tetrabromobisphenol A (TBBPA); phosphorous flame retardants (e.g. tris(2-chloroethyl)phosphate (TCEP) and tris(2-chlorisopropyl) phosphate (TCPP); short-, medium- and long- chain chlorinated paraffins (SCCPs, MCCPs, LCCPs); boric acid; hexabromocyclododecane (HBCDD); Dechloranes in all its forms (e.g. Dechlorane 602, Dechlorane 603, Dechlorane 604 and Dechlorane Plus); hexabromobiphenyl (HBB); 1,2-bis(2,4,6-tribromophenoxy) ethane (BTBPE); hexabromobenzene (HBBz).
- **Perfluorinated chemicals:** perfluorooctane sulfonic acid (PFOS), its salts and perfluorooctane sulfonyl fluoride (PFOSF), perfluorohexane sulfonic acid (PFHxS), its salts and PFHxS-related compounds, perfluorooctanoic acid (PFOA), its salts and PFOA-related compounds.
- **Phthalates:** phthalic acid esters (phthalates); di(2-ethylexyl) phthalate (DEHP); diisononyl phthalate (DiNP); diisodecyl phthalate (DiDP); di(2-Propyl Heptyl) phthalate (DPHP).
- **Bisphenols:** bisphenol A; 4-tertiary-octylphenol; bisphenol B; bisphenol F; and bisphenol S.
- **Nonylphenols:** nonylphenols (NP); nonylphenol ethoxylates (NPE).

¹³ As of 2021 - New additives are under revision by the POPs Review Committee, for inclusion under the Stockholm Convention: Dechlorane Plus (flame retardant) and UV-328 (antioxidant). Likewise, the POPs Review Committee recommended to list PFHxS, its salts and PFHxS-related compounds under Annex A to the Stockholm Convention (Elimination).

2. Polymers and their additives are extensively used in the following categories of consumer products:

- Children's products.
- Packaging: food and beverage contact materials.
- Electrical and electronic equipment (EEE) and related waste (WEEE/E-waste).
- Textile, upholstery and furniture.
- Construction sector.

Appendix 6

Updated Baseline Values and Proposal for Threshold Values for IMAP Common Indicator 22

1. Objective

1. The objective of the present document is to elaborate/formulate/update marine litter assessment criteria at regional and sub-regional levels, taking into account recent developments on the national and regional levels concerning marine litter monitoring and assessment, and most importantly the outcomes of implementation of the Integrated Monitoring and Assessment Program of the Mediterranean Sea and Coast and Related Assessment Criteria (IMAP). This document includes a proposal for updated the Baseline Values (BV) for IMAP Common Indicator 22 (CI22) (beach macro-litter), to replace those agreed in 2016 (Decision IG.22/10 – Annex III), as well as to establish Threshold Values (TV) for IMAP CI22 underpinning comparable and compatibly assessment criteria at regional and sub-regional levels.

2. Conceptual Approach, Definition and Estimation of Marine Litter Baseline and Threshold Values

2.1 Baseline Values

2. After the adoption of the Regional Plan on Marine Litter Management in the Mediterranean in 2013 (Decision IG.21/7), UNEP/MAP adopted in 2016 the Marine Litter Baseline Values (Decision IG.22/10 – Annex II) against which the implementation of the Regional Plan programs of measures could be assessed. These baseline value would enable the establishment of Marine Litter Environment Reduction Targets (Decision IG.22/10), as well as assessing whether Good Environmental Status (GES) is met. They also provide guidance on the way forward for the effective marine litter management in the region.

3. Definition of Baseline Values: According to definition provided by the UNEP/MAP Informal Online Group on Marine in 2015¹⁴, “*A baseline is a description of environmental state at a specific point against which subsequent values of state are compared. It may refer to a specified level of an impact or a pressure and act as a reference against which limit can be set or trends for the assessment of GES. Baselines can be derived from reference conditions, initial assessment values, the present state or a potential/predicted issue.*”

4. The Joint Research Centre (JRC) of the European Commission (EC), introduced a similar definition: “*A baseline value for marine litter refers to the information related to marine litter abundance that can be used as reference point in time in order to test the achievement of quantitative litter reduction goals (JRC, 2019).*”

5. In the framework of the Ecosystem Approach (EcAp), UNEP/MAP adopted in 2016 a series of Baseline Values for marine litter based on a thorough analysis of existing marine litter data and information, taking into consideration the IMAP marine litter-related indicators 22, 23 and 24. This analysis was conducted by the UNEP/MAP Informal Online Group on Marine Litter in 2014-2015 and was considered and approved by the Meeting of the Integrated Monitoring Correspondence Group in 2015 (Athens, Greece, 30 March – 1 April 2015).

6. Baseline values will and can be used at different organizational levels for evaluating the compliance with reduction goals, and thus their setting is crucial in the entire process for reducing marine litter.

2.2 Threshold Values

¹⁴ UNEP/MED WG.411/Inf.10: First Report of the Informal Online Group on Marine Litter. Meeting of the Integrated Monitoring and Assessment Group (Athens, Greece, 30 March – 1 April 2015).

7. Definition of Threshold Values: The New GES Decision (2017/848) of the European Commission (EC) provides a definition for the Threshold Values for marine litter: “*Threshold value means a value or range of values that allows for an assessment of the quality level achieved for a particular criterion, thereby contributing to the assessment of the extent to which good environmental status is being achieved.*”

8. For the determination of Threshold Values (TV), pristine or next to pristine areas/ environments should be considered. Due to the ubiquity of plastic in the marine environment worldwide, it is very difficult to define/find a pristine area, which for some experts does not even exist (Matiddi M. et Al., 2019).

9. The European Union (EU) Marine Strategy Framework Directive (MSFD) Technical Group on Marine Litter (TGML) proposes a threshold value, not based on evidence of ecological harm, which cannot be assessed in practice. Rather, it considers that there is some degree of freedom to establish a threshold value and an assessment method which shows a good level of ambition, is feasible (e.g. by selecting a low percentile value; percentile 1 and percentile 5), practical, and robust to apply (e.g. using the low percentile threshold value and the median assessment value). In that respect, a lower threshold value results in a lower residual risk of ecological harm (Willem van Loon et al. 2019).

10. For the determination of the baseline and threshold values in the Mediterranean, UNEP/MAP has embarked on the IMAP implementation, establishing and implementing national monitoring programmes for marine litter across the Mediterranean. Relevant data sets deriving from national monitoring programmes will be gradually available during the 2020-2021 biennium. These programmes are expected to support the process for achieving GES with quality controlled and quality assured data.

3. Data Sets and Data Management

11. Marine litter Baseline and Threshold Values are strongly linked and associated with data availability and data quality. Data should be acquired through harmonized monitoring methodologies in order to provide comparable data. This continues to be a challenge, though much progress has been made in the framework of IMAP, whereby data are streamlined through the development of relevant information standards (i.e. Data Standards (DS) and Data Dictionaries (DD)) for the pollution and marine litter indicators, as well as the finalization of the IMAP InfoSystem.

12. Quantitative data necessary to assess abundance, trends and distribution of marine litter are required in order to put in place and implement targeted and effective prevention and reduction measures for marine litter in the Mediterranean. While monitoring of marine litter has been ongoing for several years, it is not yet possible to get a comprehensive overview and thus to analyze the abundance of marine litter; distribution; categories; and trends in different spatial scales from local areas throughout the Mediterranean Sea. In that regard, there is still a need to further harmonize data collection methods, protocols and their analysis at all levels (e.g. categories, units, etc.).

13. The following information and data are required in order to establish marine litter baseline values:

- Ideally, data collected using the same, or a comparable, monitoring protocol;
- Data with sufficient spatial coverage;
- Data with sufficient temporal coverage;
- Data with sufficient “fit-for-purpose” quality;
- Agreement on a procedure for data clean-up; and
- Agreement on a baseline calculation method.

14. Moreover, it is crucial to agree on several variables related to data management and treatment (JRC, 2019), which include the following:

- The time period from which data is used for the calculation of baselines;
- The temporal aggregation of data;
- The spatial aggregation of data; and
- The mathematical procedure used for baseline calculation.

15. Guidance elements, to further strengthen data submission via corresponding data flows, as well as how these can be used for the determination of baseline and threshold values for marine litter are provided under Annex I to the present document.

4. Methodological Approach to determine Baseline and Threshold Values on Marine Litter at Regional and Sub-Regional Levels in the Mediterranean

16. For the definition of baseline and threshold values for each common IMAP marine litter indicator (i.e. beaches, sea bottom and water column), the data used correspond to data collected from Contracting Parties to the Barcelona Convention between 2016 and 2018 deriving from monitoring programmes, projects and initiatives, after taking into consideration the comparability of the submitted data sets. The selection of the 2016-2018 period is due to the availability of full years data in a significant number of countries compared to previous years in which data availability was rather limited.

17. Considering all available information from Contracting Parties, all steps have been undertaken in close collaboration with, scientific community and other sources from the literature. The discussion and set-up of baseline values has also taken into consideration the ongoing discussions on marine litter monitoring, top-litter item identification and establishment of threshold values (i.e. JRC, 2019).

4.1 IMAP Candidate Indicator 22: Beach Marine Litter

18. For IMAP Common Indicator 22 (beach marine litter), thirteen (13) Countries have contributed with data for the present exercise. The set of data resulting from different surveys and initiatives were based on protocols with several differences. Therefore, the datasets were homogenized towards ensuring comparability, before performing the statistical analysis. Under the present exercise, it is presumed that data provided by the respective Focal Points have undergone thorough quality checks and do not contain erroneous data.

19. All the surveys have been collected in a database in accordance with the templates proposed by UNEP/MAP in accordance with monitoring programs on marine litter in the Mediterranean (UNEP/MAP, 2017). The extreme values that have been observed (outliers) were retained in the datasets and were checked and verified case by case. The number of surveys conducted in each country and the year when it was undertaken for beach marine litter (IMAP CI22) are presented in Table 1.

Table 1: Number of surveys by country (beach litter)

Sub-regions ¹⁵	Country	Surveys	Years	Sources
WM	Algeria	111	2018	SWIM H2020 Support Mechanism
	France	88	2016, 2017, 2018	MED POL Focal Point France
	Italy	162	2016, 2017, 2018	MEDPOL Focal Point Italy

¹⁵ Western Mediterranean (WM); Central Mediterranean (CM); Adriatic Sea (AS); Eastern Mediterranean (EM)

Sub-regions ¹⁵	Country	Surveys	Years	Sources
	Malta	24	2017, 2018	MED POL Focal point Malta
	Morocco	16	2018	MED POL Focal point Morocco
	Spain	139	2016, 2017, 2018	MED POL Focal Point Spain
CM	Greece	3	2018	MED POL Focal Point Greece
	Italy	66	2016, 2017, 2018	MED POL Focal Point Italy
	Libya	12	2018	MED POL Adopt-a-Beach Pilots in Libya
AD	Italy	132	2016, 2017, 2018	MED POL Focal Point Italy
	Slovenia	16	2017	MED POL Focal Point Slovenia
	Montenegro	4	2018	MED POL Adopt-a-Beach Pilots in Montenegro
	Albania	4	2018	MED POL Adopt-a-Beach Pilots in Albania
	Croatia	6	2017, 2018	MED POL Focal Point Croatia
EM	Cyprus	31	2016, 2018	EMODnet
	Israel	8	2017, 2018	MED POL Focal Point Israel

5. Determination of Baseline and Threshold Values

5.1 IMAP Candidate Indicator 22: Beach Marine Litter

20. For each country and subregion, the basic statistical values have been calculated together with average and median values corresponding to the total amounts of marine litter found in each survey by year and then by country as illustrated in Table 4. The beach litter data distribution is shown in Fig. 1.

Table 4: Descriptive statistics parameters by country

Country	Average	Standard Deviation	Median
Albania	757	375	681
Algeria	782	587	625
Croatia	936	928	768
Cyprus	339	409	218
France	893	1513	436
Greece	1502	1501	708
Israel	157	154	128
Italy	762	872	475
Libya	2206	1185	2002
Malta	204	237	127
Montenegro	1440	1372	968
Morocco	1744	1398	1327
Slovenia	374	273	328
Spain	306	367	167
Total average	924	832	659

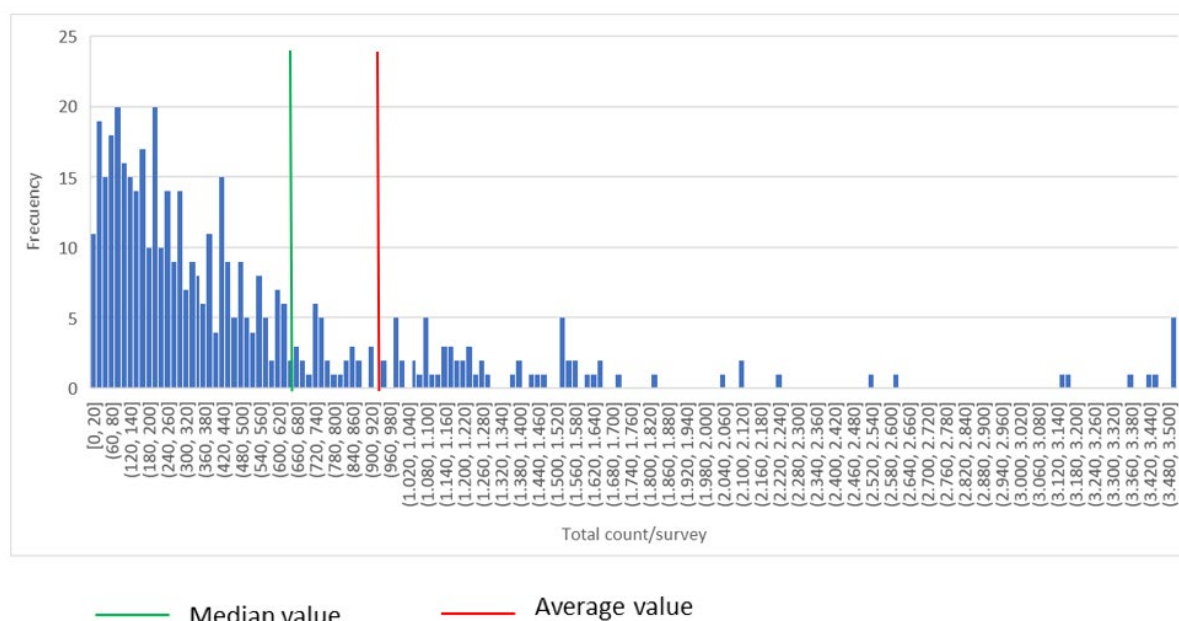

Figure 1: Beach litter data distribution

21. As can be seen, non-symmetrical distributions are predominant in the marine litter count (Table 4 and Figure 1). Further examination of data presented in both Figure 5 and Table 2 indicate that the standard deviation is very high, even greater than the average for some countries, and at the level of the Mediterranean, it gives a very wide range of average values (i.e. Spain: average 306 items/100 m; standard deviation 367 items/100 m, Table 4). The graphic representation under Figure 1 shows that the data distribution for IMAP CI22 (beach marine litter) is very irregular; and thus, **the median value is the most representative**. In fact, the median value is considered a better measure of the central location of a value than the average value in the case of a non-symmetric distribution (Baggelaar, Paul K. and Van der Meulen Eit C.J., 2014; Willem van Loon et al., 2019). This is due to the reason that, the median value is not sensitive to extreme values (Willem van Loon et al. 2019). For example, the median beach litter abundance values of France (Table 4) are much more comparable with other countries' median abundance values than the average values. Extreme values may sometimes occur, e.g. due to a storm event or an accidental loss of litter at sea. For all countries, the use of the median value will make the assessment insensitive to these occasional extreme values (Willem van Loon et al. 2019).

22. The best spatial coverage is considered to be the combination of "Country" and "Sub-region" (i.e. Country-SubRegion) (JRC, 2019). The Top-X calculation was conducted for each consecutive year for the period 2016-2018 (i.e. 2016, 2017 and 2018), and for each Country-SubRegion (e.g. IT-AD, IT-CM, IT-WM, etc.).

23. The Mediterranean Top-X marine litter items list that contributed to the 80th percentile of the total recorded items for the period 2016-2018 for each Country-SubRegion are presented in Table 5 (Baggelaar, Paul K. and Van der Meulen Eit C.J., 2015). The Top-X and Top-10 marine litter lists per country can be found under Annex II to this document.

Table 5: Relative and cumulative frequency of marine litter in the Mediterranean (Top 10 and Top X)¹⁶

	UNEP Code	Item name	Relative Frequency. ¹⁷	Cumulative Frequency
Mediterranean Top-10 Marine Litter	G76	Plastic/polystyrene pieces 2.5 cm > < 50 cm	0,16504423	0,16504423
	G27	Cigarette butts and filters	0,12921627	0,2942605
	G21/G24	Plastic caps and lids (including rings from bottle caps/lids)	0,08743357	0,38169407
	G95	Cotton bud sticks	0,05249481	0,43418888
	G7/G8	Drink bottles	0,04973091	0,48391979
	G30/G31	Crisps packets/sweets wrappers/Lolly sticks	0,03998183	0,52390162
	G124	Other plastic/polystyrene items (identifiable) including fragments	0,03299665	0,55689827
	G50	String and cord (diameter less than 1 cm)	0,02712216	0,58402043
	G208a	Glass fragments >2.5cm	0,02302928	0,60704971
	G200	Bottles (including identifiable fragments)	0,02032637	0,62737608
Mediterranean Top-X (80%) Marine Litter Items	G73	Foam sponge items (i.e. matrices, sponge, etc.)	0,01956879	0,64694487
	G34/G35	Cutlery, plates and trays / Straws and stirrers	0,01892997	0,66587484
	G3	Shopping bags incl. pieces	0,0179509	0,68382574
	G10	Food containers incl. fast food containers	0,01342144	0,69724718
	G33	Cups and cup lids	0,01306833	0,71031551
	G204	Construction material (brick, cement, pipes)	0,01288535	0,72320086
	G152	Cigarette packets	0,01184849	0,73504935
	G67	Sheets, industrial packaging, plastic sheeting excluding agriculture and greenhouse sheeting	0,01109412	0,74614347
	G4	Small plastic bags, e.g. freezer bags incl. pieces	0,01085015	0,75699362
	G175	Cans (beverage)	0,01072495	0,76771857
	G54	Nets and pieces of net > 50 cm	0,01030122	0,77801979
	G158	Other paper items (including non-recognizable fragments)	0,01023381	0,7882536
	G145	Other textiles (including pieces of cloths, rags, etc.)	0,01013108	0,79838468

24. The Mediterranean Top-X list includes 23 items (from G76 to G145) and represents approximately 80% of the information collected, while the Top-10 list only represents 63% of the information (Table 5).

25. The parameter used in the analysis (median) was defined and a weighing factor was applied. The weighing factor has been calculated as the percentage of the length of the coast corresponding to each country within its subregion and within the entire Mediterranean coast (JRC, 2019) (Table 6).

26. Accordingly, it was found that the data provided by the Contracting Parties represent 60% of the total length of the Mediterranean coastline. The analysis must take into account a weighting factor

¹⁶ The Relative and cumulative frequency for the full UNEP/MAP list for beach marine litter items is presented under Annex III.

¹⁷ Objects with relative frequencies <0.01 are excluded from the Top X (Baggelaar, Paul K. and Van der Meulen Eit C.J., 2015).

based on the length of coast of each country in each subregion, and of each subregion in the total Mediterranean coast to increase spatial representativeness. This approach significantly increased the data representativeness as illustrated in Table 6.

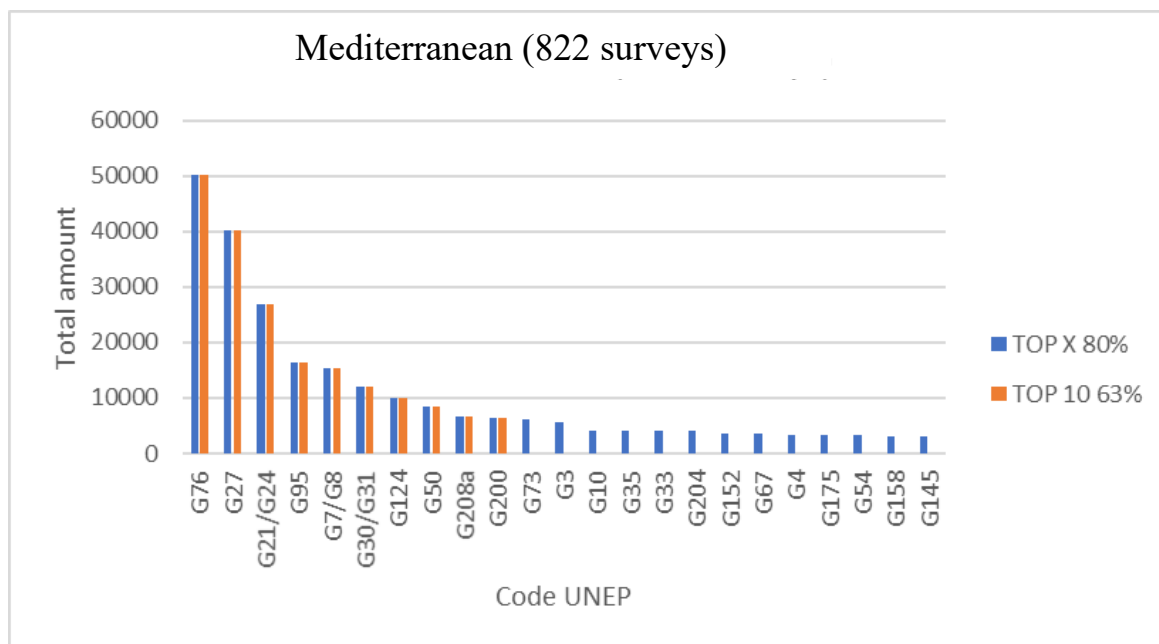

Figure 2: Top-X vs. TOP-10 marine litter items per Mediterranean (Table 6)

Table 6: Percentage of the Mediterranean coast by country (World Resources Institute, 2016)

Mediterranean Sub-region	% Coast Length	Country Code	% subregion coast length
WM	29	DZ	14
		ES	27
		FR	15
		IT	20
		MA	5
		MT	2
		TN	17
CM	12	AL	2
		GR	42
		IT	15
		LY	43
AD	34	AL	4
		BA	0,4
		HR	44
		SI	0,6
		IT	50
		ME	1
EM	25	CY	7
		EG	11
		GR	30
		IL	2
		LB	3

		TR	47
--	--	----	----

27. This methodology was applied to 100% of the data obtained to determine the baseline that will be compared to the values previously proposed (UNEP/MAP, 2016). Further to the above analysis, the baseline values for beach marine litter were calculated as depicted in Table 7:

Table 7: Median by sub-region and Mediterranean

Mediterranean Sub-regions	Median (item/100m)
	100% data set
WM	384
CM	338
AD	547
EM	205
Mediterranean Sea AVERAGE	369

28. Hence, for **IMAP Common Indicator 22 (beach marine litter), the proposed, updated Baseline Value for the Mediterranean is 369 item/100 m** (Table 8). The beach litter baseline proposed by 19th Ordinary Meeting of the Contracting Parties to the Convention for the Protection of the Marine Environment and the Coastal Region of the Mediterranean and its Protocols (Athens, Greece, 9-12 February 2016) was 450-1400 items/100 m.

29. To calculate the threshold value, it was proceeded with the estimation of the 15th percentile of the baseline results (Willem van Loon, David Fleet and Georg Hanke, 2019). Against which to compare the state of beach marine litter in the Mediterranean, following the marine litter descriptor aim.

30. In order to give each sub-region an equal contribution, it is proposed to give each an equal weight while calculating the corresponding threshold value/s in accordance with the 15th percentile as shown in Table 8. This method will prevent data of one or more countries with many surveys or with extremely high or low total abundance values from dominating the threshold value (Van Loon et al, 2019).

31. As can be inferred from Table 8 (Q15), for **IMAP Common Indicator 22 (beach marine litter), the proposed Threshold Value is 130¹⁸ items/100 m**.

Table 8: Percentile calculation

Sub regions	Q15 (items/100m)
	100% data set
WM	87
CM	135
AD	225
EM	73

¹⁸ The proposal of a Threshold Value is a strategic decision. The value 177 items/100m corresponds to the average value for the Mediterranean.

Total average	130
----------------------	------------

32. In order to reach achieve GES, a reduction percentage should be applied in order to give overall information about the reduction level that should be applied on the baseline value in order to comply with the proposed/calculated Threshold Value. The reduction percentage is calculated as per Van Loon et al. (2019) as follows:

$$\text{Reduction Percentage} = ((\text{median} - \text{TV}) / \text{median}) \times 100$$

33. Accordingly, it is found that the reduction percentage between the proposed Baseline Values and the proposed Threshold Value for the Mediterranean is approximately 65%

6 Proposal for Updated Baseline Values and Establishment of Threshold Values for Marine Litter

34. Based on the datasets that were made available to UNEP/MAP and its MED POL Programme and the relevant analysis elaborated to the present document a proposal for updated Baseline Values and Threshold Values, at this stage can be considered only for IMAP Common Indicator 22 (beach macro-litter). Those proposals are presented hereunder under Table 12.

Table 11: 2016 (Agreed) and 2019 (Proposed/Updated) Baseline Values; Proposed Threshold Values; and percentage reduction in baseline values to achieve GES.

IMAP Indicators	Categories of Marine Litter	BV-2016	Proposed BV-2021	Proposed TV-2021
CI22	Beach Marine Litter	450-1400 items/100m	369 items/100m	130 items/100m

Annex I: List of References

- Baggelaar, Paul K. and Van der Meulen Eit C.J. “Evaluation and fine-tuning of a procedure for statistical analysis of beach litter data” (2014).
- Baggelaar, Paul K. and Van der Meulen Eit C.J., “Litter Analyst 2.0, User Manual”. OSPAR Comision (2015).
- Cheshire, A.C., Adler, E., Barbière, J., Cohen, Y., Evans, S., Jarayabhand, S., Jetic, L., Jung, R.T., Kinsey, S., Kusui, E.T., Lavine, I., Manyara, P., Oosterbaan, L., Pereira, M.A., Sheavly, S., Tkalin, A., Varadarajan, S., Wenneker, B., Westphalen, G. (2009). UNEP/IOC Guidelines on Survey and Monitoring of Marine Litter. UNEP Regional Seas Reports and Studies, No. 186; IOC Technical Series No. 83: xii + 120 pp.
- Ioakeimidis, C., Galgani, F., and Papatheodorou, G. “Occurrence of Marine Litter in the Marine Environment: A World Panorama of Floating and Seafloor Plastics”. Springer International Publishing AG 2017.
- JRC within the MSFD Technical Group on Marine Litter in close collaboration with EU Member States. “Marine Beach Litter Baselines. Scenario analysis of a pan-European 2012-2016 beach litter dataset” . Luxembourg: Publications Office of the European Union, 2019.
- Marcus Schulz a, Dennis J.J. Walvoort b, Jon Barry c, David M. Fleet d, Willem M.G.M. Van Loon. “Baseline and power analyses for the assessment of beach litter reductions in the European OSPAR region”. Environmental Pollution 248. Pp 555-564. (2019)
- Matiddi, M., deLucia, G.A., Silvestri, C., Darmon, G., Tomás, J., Pham, C.K., Camedda, A., Vandeperre, F., Claro, F., Kaska, Y., Kaberi, H., Revuelta, O., Piermarini, R., Daffina, R., Pisapia, M., Genta, D., Sözbilen, D., Bradai, M.N., Rodríguez, Y., Gambaiani, D., Tsangaris, C., Chaieb, O., Moussier, J., Loza, A.L., Miaud, C., , I.c. “Data Collection on Marine Litter Ingestion in Sea Turtles and Thresholds for Good Environmental Status”. J. Vis. Exp. (147), e59466, doi:10.3791/59466 (2019).
- Public enterprise for coastal zone management of Montenegro. “Adopt a Beach, FINAL PROGRESS REPORT” (2019).
- R Core Team (2018). R: A language and environment for statistical computing. R Foundation for Statistical Computing, Vienna, Austria. URL <https://www.R-project.org/>.
- UNEP. “Integrated Monitoring and Assessment Guidance”. 19th Ordinary Meeting of the Contracting Parties to the Convention for the Protection of the Marine Environment and the Coastal Region of the Mediterranean and its Protocols. Athens, Greece, 9-12 February 2016.
- UNEP. “Meeting of the Ecosystem Approach Correspondence Group on Pollution Monitoring”. Podgorica, Montenegro, 2-3 April 2019.
- Urban Research Institute (Albania) “Marine Litter Management, Adopt a Beach, 2019 Final Report”. (2019)
- Van Loon, W., Fleet, D., Hanke, G., Werner, S., Barry, J., Eriksson J., Gräwe, D., Kinsey, S., Schulz, M., Vlachogianni, Th., Press, M. and Blidberg, E. “Proposal towards a SMART Threshold Value for Beach Litter”. MLWG UE 2019 (Draft).

Annex II: Guidance elements, to further strengthen data submission and corresponding data flow for marine litter, for the determination of baseline and threshold values

1 Field guides and litter identification tools are important elements which ensure sampling consistency throughout the region. Guides should be developed in local languages and address cultural aspects.

2 Under UNEP/MAP IMAP framework, the most comprehensive document for data collection is provided through the “Integrated Monitoring and Assessment Guidance” (UNEP, 2016) where the sampling and data collection methodologies are detailed for different environments under study. The aforementioned document addresses the following survey categories:

- A. Beach litter surveys.
- B. Benthic litter surveys, which include:
 - a. Observations made by divers, submersibles or camera tows.
 - b. Collection of litter via benthic trawls.
- C. Floating litter surveys, which include:
 - a. Observations made from ship or aerial based platforms.
 - b. Collection of litter via surface trawls.

3 During the 2019 Meetings of the MED POL Focal Points (Istanbul, Turkey, 29-31 May 2019), and 7th EcAp Coordination Group (Athens, Greece, 9 September 2019), Data Standards (DS) and Data Dictionaries (DD) for marine litter IMAP Common Indicators were agreed based on the work of CorMon on Marine Litter (Podgorica, Montenegro, 4-5 April 2019), including a detailed list of parameters and relevant elements that should be recorded during the monitoring surveys. Based on these parameters, single forms in excel format were recommended for reporting of marine litter data in different environments (e.g. beach, seafloor, floating, etc.). The forms are to include relevant information for subsequent data analysis (e.g. country, sub-region, location, survey date, etc.). The following steps are recommended for the submission and analysis of relevant data for marine litter items in a coherent and coordinated manner:

4 Step 1: Development of Datasets

5 Contracting Parties’ Focal Points should send a file in excel format annually with data corresponding to each survey category.

6 The file name should have the following labeling:

Sub-regionCode_CountryCode_Year (yyyy)

7 Step 2: Statistical analysis (beach macrolitter, seafloor macrolitter and floating macrolitter)

8 The collected marine litter data and relevant excel sheets are subsequently developed in R-Language¹⁹ with which data files are read and analyzed. Accordingly, a final report is generated.

9 For the exercise elaborated under the present document, the 2016-2018 datasets were consolidated in R-Language in “.csv” format under schematic representation shown in Figure 1:

¹⁹ Statistical programme

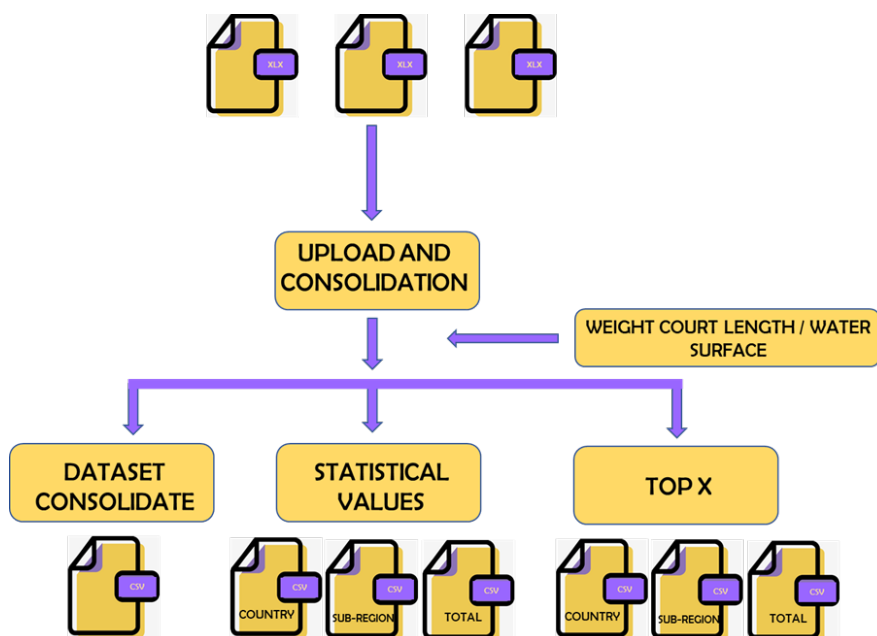

Figure 1: Schematic representation of the methodological approach for the collection of the available datasets and the statistical treatment of the data.

10 Step 3: Calculation of Baseline and Threshold Values

- A. Baseline Values: The schematic representation of the methodological approach for the calculation of baseline values based on median approach are depicted in Figure 2.

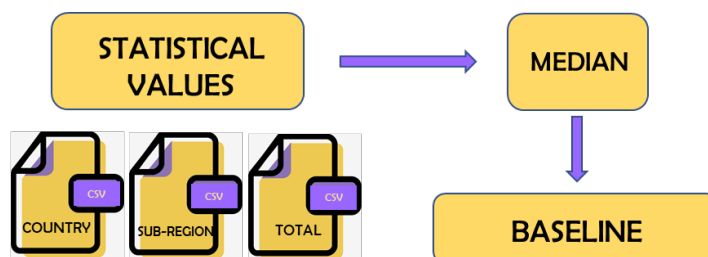

Figure 2: Schematic representation of the methodological approach for the calculation of baseline values.

- B. Threshold Values: There is some freedom to establish a threshold value and an assessment method which shows a good level of ambition and is considered feasible and realistic. Here we show one possibility based on the 15Q) (Figure 3).

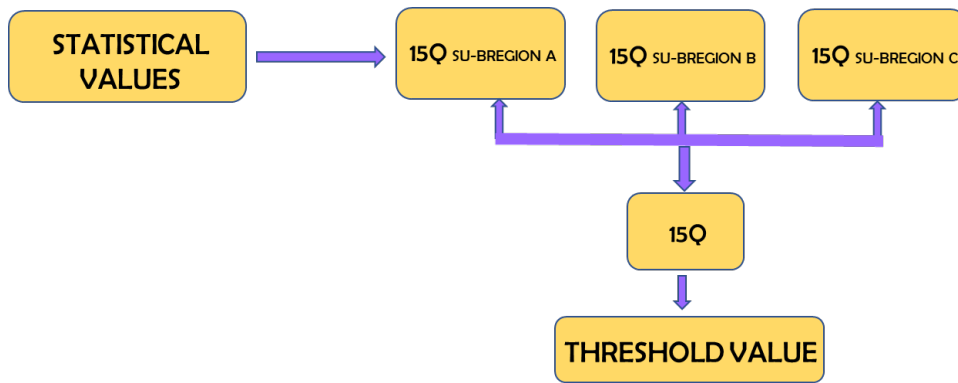
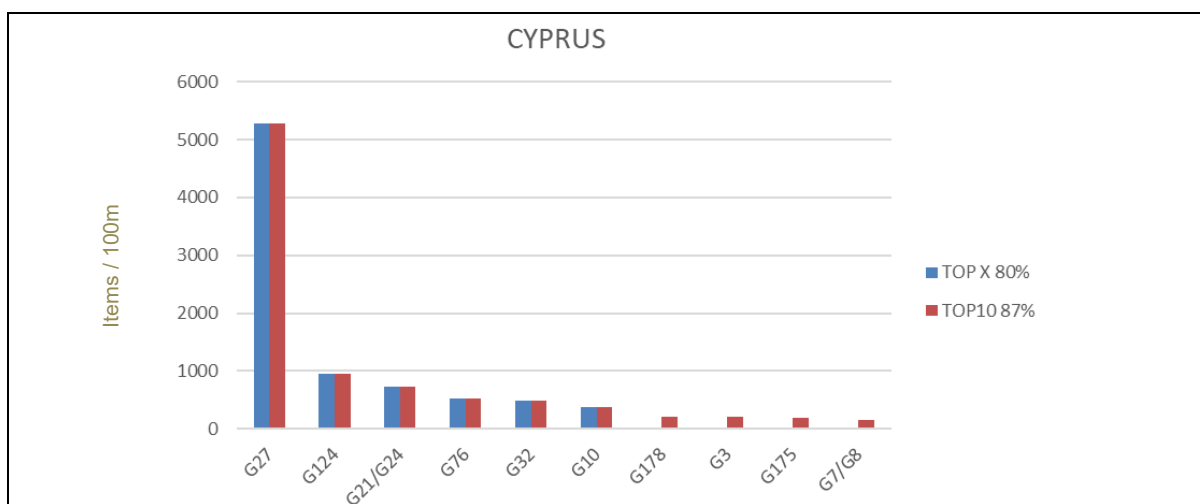
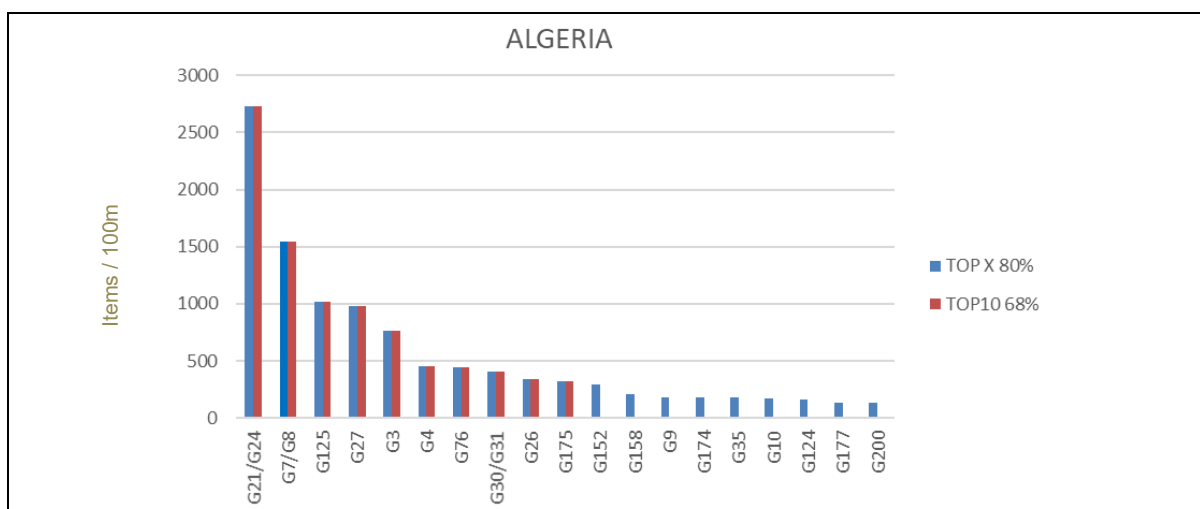
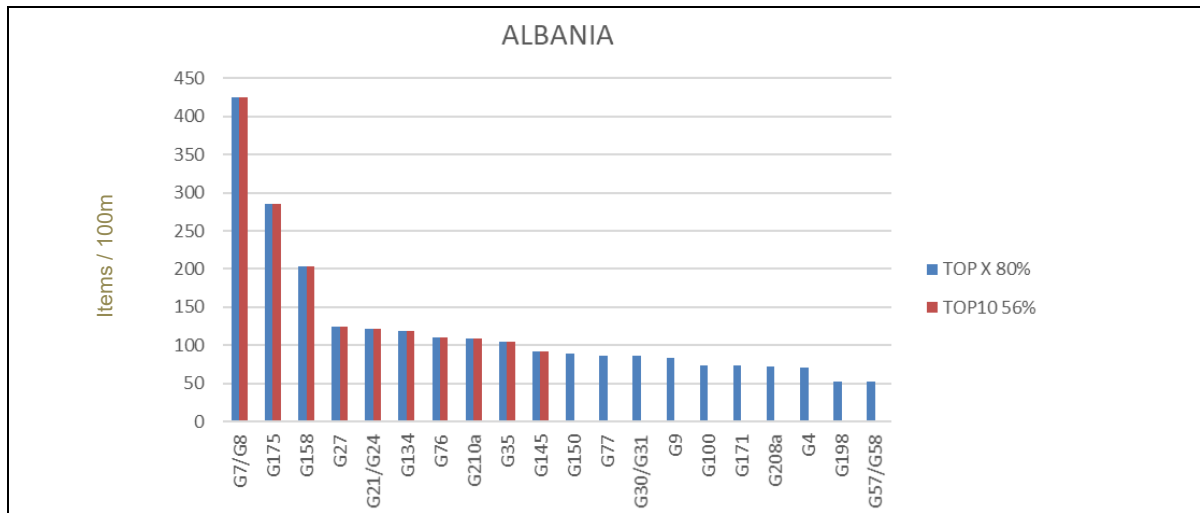
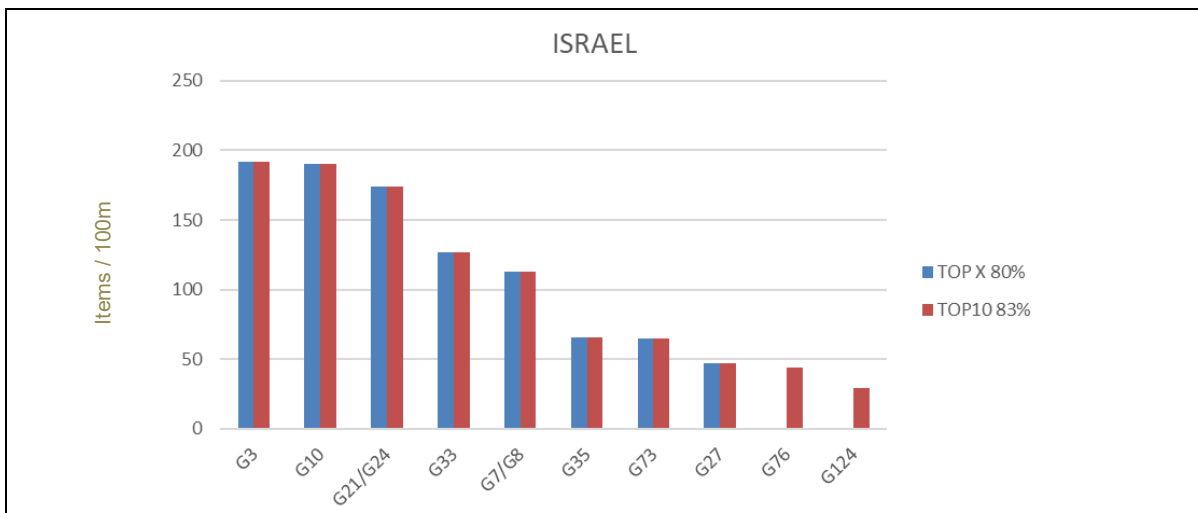
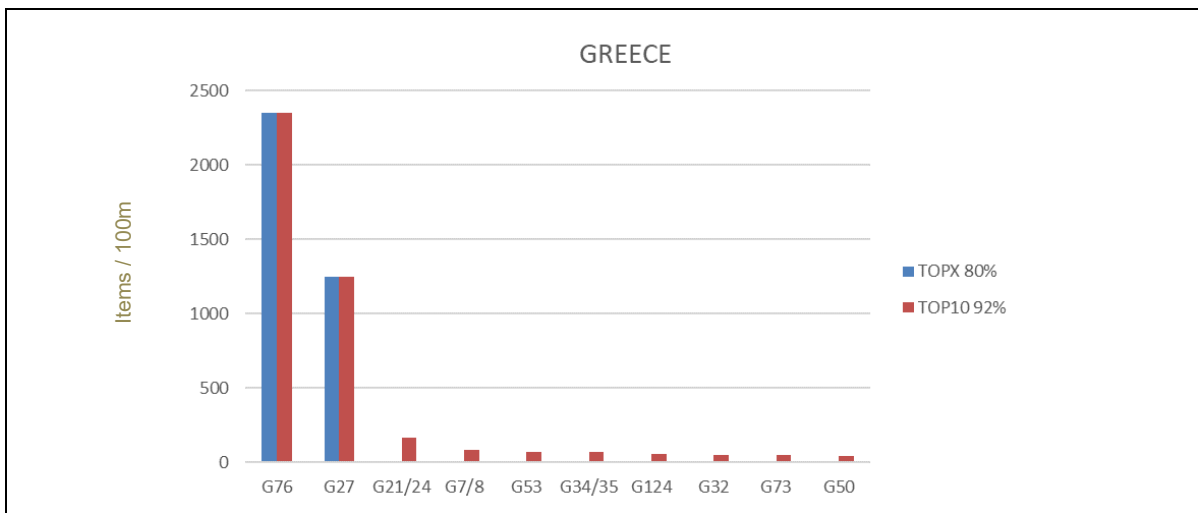
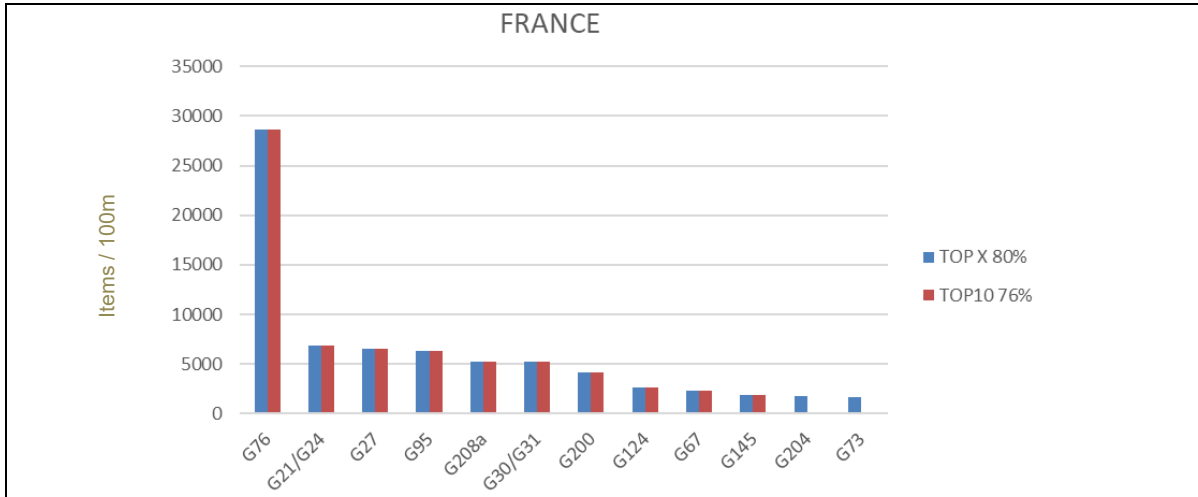
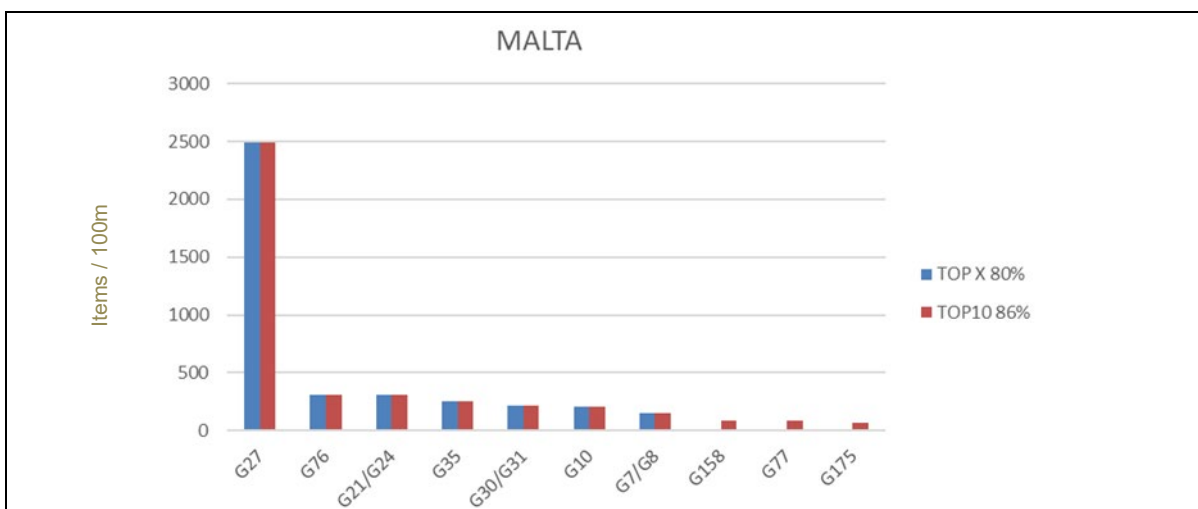
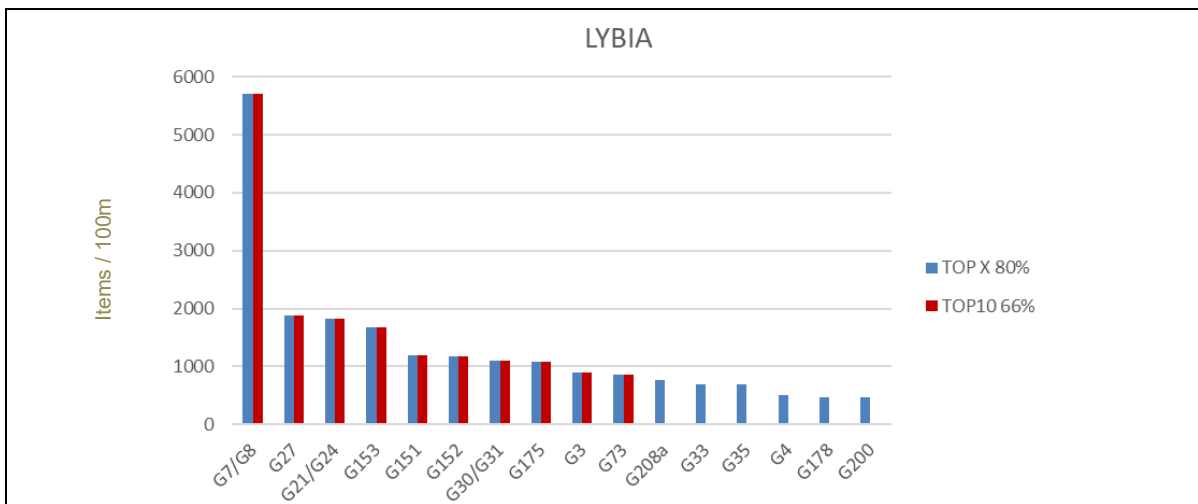
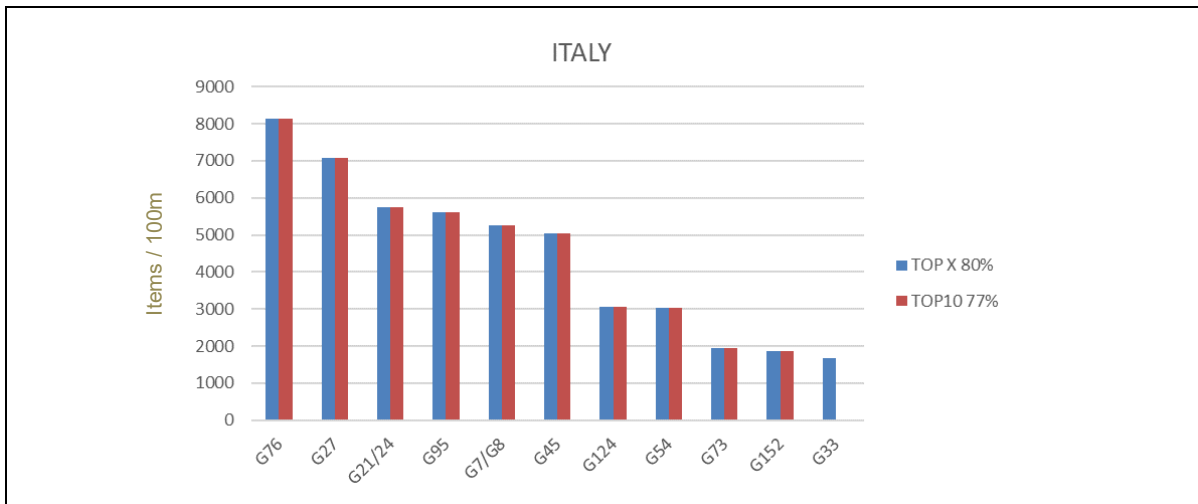

Figure 3: Schematic representation of the methodological approach for the calculation of threshold values.

Annex III: Top-X vs. TOP-10 marine litter items per different Country contributing with the data to the current exercise for updating the Baseline Values and proposing Threshold Values for Beach Marine Litter







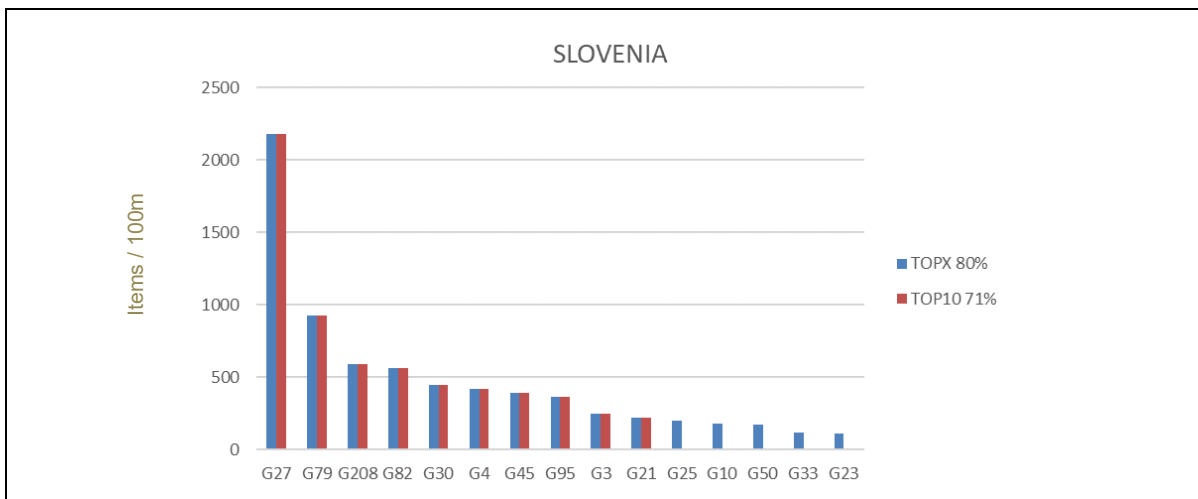
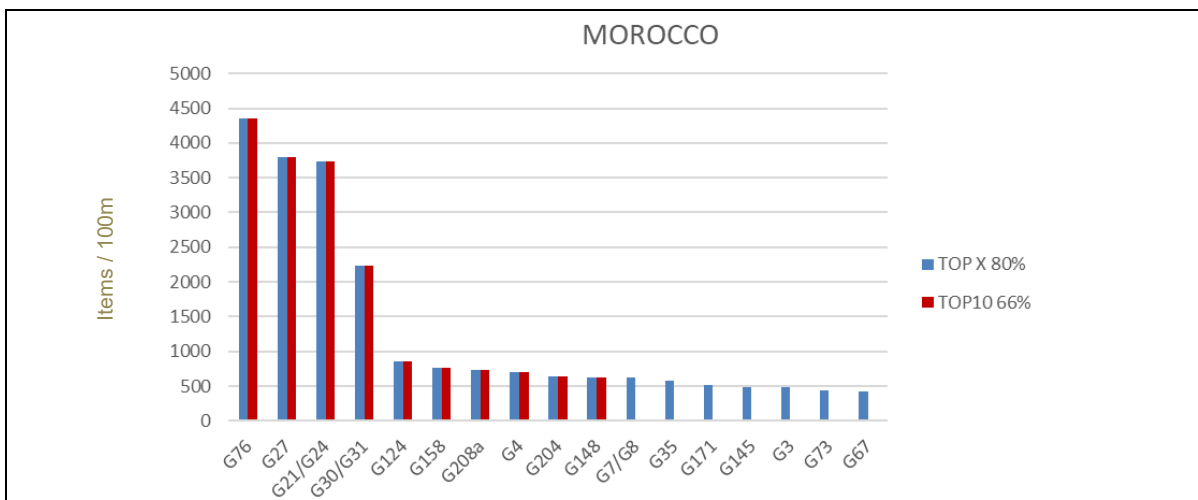
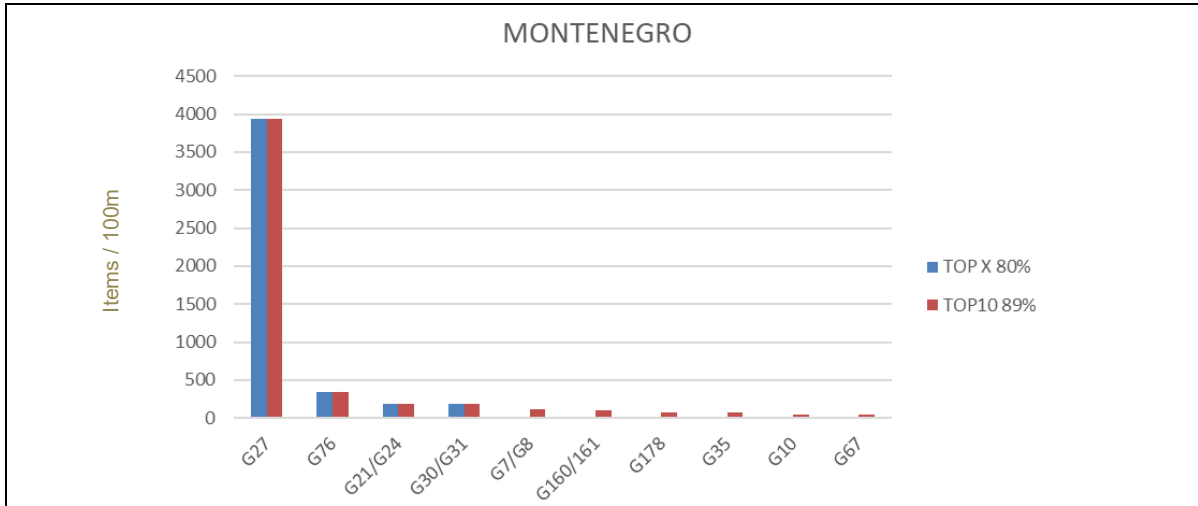

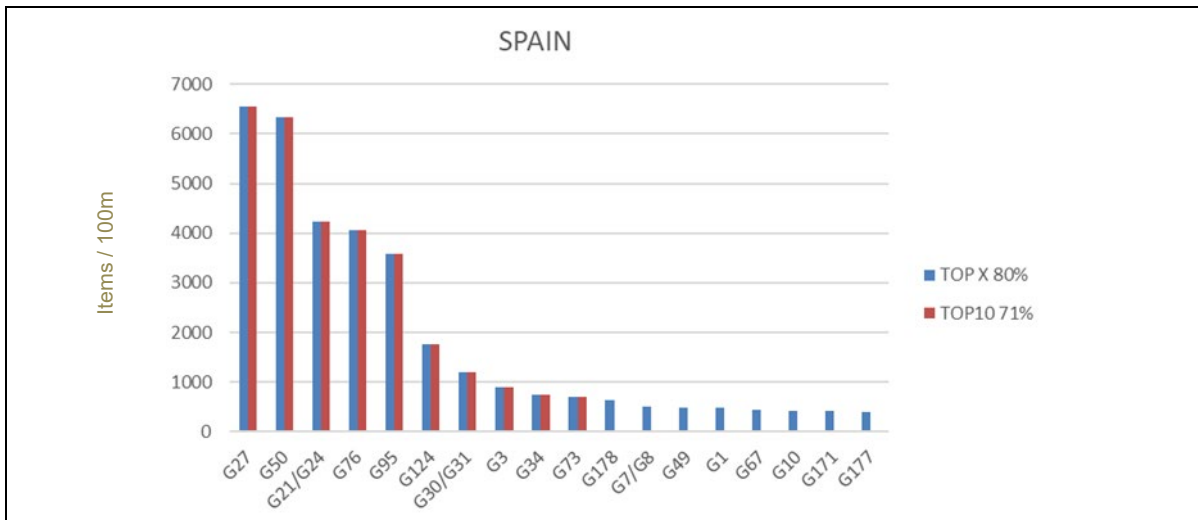

Annex IV: Relative and Cumulative Frequency for the Full UNEP/MAP List for Beach Marine Litter Items

	UNEP Code	Item name	Relative Frequency.	Cumulative Frequency
Mediterranean Top-10 Marine Litter	G76	Plastic/polystyrene pieces 2.5 cm > < 50 cm	0,16504423	0,16504423
	G27	Cigarette butts and filters	0,12921627	0,2942605
	G21/G24	Plastic caps and lids (including rings from bottle caps/lids)	0,08743357	0,38169407
	G95	Cotton bud sticks	0,05249481	0,43418888
	G7/G8	Drink bottles	0,04973091	0,48391979
	G30/G31	Crisps packets/sweets wrappers/Lolly sticks	0,03998183	0,52390162
	G124	Other plastic/polystyrene items (identifiable) including fragments	0,03299665	0,55689827
	G50	String and cord (diameter less than 1 cm)	0,02712216	0,58402043
	G208a	Glass fragments >2.5cm	0,02302928	0,60704971
	G200	Bottles (including identifiable fragments)	0,02032637	0,62737608
Mediterranean Top-X (80%) Marine Litter Items	G73	Foam sponge items (i.e. matrices, sponge, etc.)	0,01956879	0,64694487
	G34/G35	Cutlery, plates and trays / Straws and stirrers	0,01892997	0,66587484
	G3	Shopping bags incl. pieces	0,0179509	0,68382574
	G10	Food containers incl. fast food containers	0,01342144	0,69724718
	G33	Cups and cup lids	0,01306833	0,71031551
	G204	Construction material (brick, cement, pipes)	0,01288535	0,72320086
	G152	Cigarette packets	0,01184849	0,73504935
	G67	Sheets, industrial packaging, plastic sheeting excluding agriculture and greenhouse sheeting	0,01109412	0,74614347
	G4	Small plastic bags, e.g. freezer bags incl. pieces	0,01085015	0,75699362
	G175	Cans (beverage)	0,01072495	0,76771857
	G54	Nets and pieces of net > 50 cm	0,01030122	0,77801979
	G158	Other paper items (including non-recognizable fragments)	0,01023381	0,7882536
	G145	Other textiles (including pieces of cloths, rags, etc.)	0,01013108	0,79838468
	G26	Cigarette lighters	0,00905249	0,80743717
	G178	Bottle caps, lids & pull tabs	0,00897545	0,81641262
	G13	Other bottles, drums and containers	0,00709112	0,82350374
	G77	Plastic/polystyrene pieces > 50 cm	0,00704297	0,83054671
	G153	Cups, food trays, food wrappers, drink containers	0,00675406	0,83730077
	G171	Other wood < 50 cm	0,00615056	0,84345133
	G151	Cartons/Tetrapack (non-milk)	0,00594190	0,84939323
G9	Cleaner bottles & containers	0,00591301	0,85530624	
G32	Toys and party poppers	0,00583276	0,861139	
G177	Foil wrappers, aluminium foil	0,00575571	0,86689471	
G125	Balloons, balloon ribbons, strings, plastic valves and balloon sticks	0,00531593	0,87221064	
G148	Cardboard (boxes & fragments)	0,00468675	0,87689739	
G49	Rope (diameter more than 1cm)	0,00462576	0,88152315	
G100	Medical/Pharmaceuticals containers/tubes	0,00446204	0,88598519	
G70	Shotgun cartridges	0,00432722	0,89031241	

	UNEP Code	Item name	Relative Frequency.	Cumulative Frequency
	G45	Mesh bags (e.g. mussels nets, net sacks, oyster nets including pieces and plastic stoppers from mussel lines)	0,00406720	0,89437961
	G134	Other rubber pieces	0,00397411	0,89835372
	G198	Other metal pieces < 50 cm	0,00394201	0,90229573
	G53	Nets and pieces of net < 50 cm	0,00384249	0,90613822
	G11	Beach use related cosmetic bottles and containers, e.g. Sun blocks	0,00370125	0,90983947
	G137	Clothing / rags (clothing, hats, towels)	0,00368841	0,91352788
	G66	Strapping bands	0,00360816	0,91713604
	G71	Shoes and sandals made of artificial polymeric material	0,00327751	0,92041355
	G59	Fishing line/(tangled and not tangled)	0,00288267	0,92329622
	G96	Sanitary towels/panty liners/backing strips	0,00287946	0,92617568
	G5	The part that remains from rip-off plastic bags	0,00279279	0,92896847
	G28	Pens and pen lids	0,00269970	0,93166817
	G208b	Ceramic fragments >2.5cm	0,00263549	0,93430366
	G159	Corks	0,00261302	0,93691668
	G160/G161	Pallets / Processed timber	0,00262586	0,93954254
	G176	Cans (food)	0,00246536	0,9420079
	G199	Other metal pieces > 50 cm	0,00244931	0,94445721
	G1	4/6-pack yokes, six-pack rings	0,00237869	0,9468359
	G150	Cartons/Tetrapack Milk	0,00215719	0,94899309
	G191	Wire, wire mesh, barbed wire	0,00212830	0,95112139
	G210a	Other glass items	0,00209299	0,95321438
	G172	Other wood > 50 cm	0,00200310	0,95521748
	G98	Diapers/nappies	0,00199668	0,95721416
	G174	Aerosol/Spray cans industry	0,00193809	0,95915225
	G133	Condoms (incl. packaging)	0,00190359	0,96105584
	G128	Tyres and belts	0,00184581	0,96290165
	G144	Tampons and tampon applicators	0,00183297	0,96473462
	G68	Fibre glass items and fragments	0,00182655	0,96656117
	G60	Light sticks (tubes with fluid) incl. Packaging	0,00182334	0,96838451
	G165	Ice-cream sticks, chip forks, chopsticks, toothpicks	0,00178161	0,97016612
	G56	Tangled nets/cord	0,00173988	0,971906
	G147	Paper bags	0,00156974	0,97347574
	G99	Syringes/needles	0,00149912	0,97497486
	G138	Shoes and sandals (e.g. Leather, cloth)	0,00148307	0,97645793
	G57/G58	Fish boxes	0,00131293	0,97777086
	G202	Light bulbs	0,00121663	0,97898749
	G18	Crates and containers / baskets (excluding fish boxes)	0,00120700	0,98019449
	G211	Other medical items (swabs, bandaging, adhesive plaster etc.)	0,00119095	0,98138544
	G37	Mesh bags (e.g. vegetables, fruits and other products) excluding aquaculture mesh bags	0,00105933	0,98244477
	G154	Newspapers & magazines	0,00098229	0,98342706
	G141	Carpet & Furnishing	0,00089883	0,98432589
	G44	Octopus pots	0,00087957	0,98520546

	UNEP Code	Item name	Relative Frequency.	Cumulative Frequency
	G19	Vehicle parts (made of artificial polymer or fiber glass	0,00083142	0,98603688
	G91	Biomass holder from sewage treatment plants and aquaculture	0,00082179	0,98685867
	G14	Engine oil bottles & containers <50 cm	0,00079932	0,98765799
	G16	Jerry cans (square plastic containers with handle)	0,00079932	0,98845731
	G166	Paint brushes	0,00078327	0,98924058
	G62/G63	Buoys (e.g. marking fishing gear, shipping routes, mooring boats etc.)	0,00078327	0,99002385
	G65	Buckets	0,00069980	0,99072365
		Other sanitary waste	0,00066128	0,99138493
	G29	Combs/hairbrushes/sunglasses	0,00063239	0,99201732
	G17	Injection gun containers (including nozzles)	0,00061955	0,99263687
	G186	Industrial scrap	0,00060671	0,99324358
	G97	Toilet fresheners	0,00058103	0,99382461
	G101	Dog faeces bag	0,00049115	0,99431576
	G162	Crates and containers / baskets (not fish boxes)	0,00045583	0,99477159
	G43	Tags (fishing and industry)	0,00038521	0,9951568
	G15	Engine oil bottles & containers >50 cm	0,00037558	0,99553238
	G40	Gloves (washing up)	0,00036916	0,99590154
	G23	Plastic caps and lids (including rings from bottle caps/lids)	0,00033706	0,9962386
	G187	Drums and barrels (e.g. oil, chemicals)	0,00033385	0,99657245
	G36	Heavy duty sacks (e.g. fertilizer or animal feed sacks	0,00031780	0,99689025
	G182	Fishing related (weights, sinkers, lures, hooks)	0,00030175	0,997192
	G47	Plastic sheeting from mussel culture (Tahitians)	0,00028891	0,99748091
	G41	Gloves (industrial/professional rubber gloves)	0,00027286	0,99775377
	G210b	Other ceramic/pottery items	0,00027286	0,99802663
	G69	Hard hats/Helmets	0,00026965	0,99829628
	G140	Sacking (hessian)	0,00022792	0,99852420
	G164	Fish boxes	0,00019582	0,99872002
	G42	Crab/lobster pots and tops	0,00019582	0,99891584
	G127	Rubber boots	0,00018619	0,99910203
	G180	Appliances (refrigerators, washers, etc.)	0,00018298	0,99928501
	G190	Paint tins	0,00015730	0,99944231
	G46	Oyster trays (round from oyster cultures)	0,00011235	0,99967985
	G213	Paraffin/Wax	0,00010112	0,99978097
	G179	Disposable BBQ's	9,63E-05	0,99987727
	G207	Octopus pots	4,82E-05	0,99992547
	G184	Lobster/crab pots	3,85E-05	0,99996397
	G163	Crab/lobster pots	3,60E-05	1

Appendix 7

**Background (Assessment) Concentrations (BC/BAC) for Common Indicator 17
and Upgraded Approach for Environmental Assessment Criteria (EAC)
for IMAP Common Indicators 17, 18 and 20**

1 Introduction

1. The criteria established by Decisions IG.22/7 (COP 19)²⁰ and IG. 23/6 (COP 20)²¹ are reviewed in Section 2 of present document, whereas Section 3 provides an in-depth analysis of the data available for present upgrade of the assessment criteria. New upgraded regional and sub-regional Mediterranean BC and BAC values for CI17, as well as a proposal of the criteria for IMAP CI20 are presented in Section 4. This section also proposes an approach to upgrade the Mediterranean EACs.

2. The data used for developing updated assessment criteria were collected in the IMAP Pilot Info System during its testing phase, and in particular after launching a formal call for reporting of monitoring data in June 2020, as well as monitoring data stored in MEDPOL database that have not been previously used for calculation of the assessment criteria applied in the 2017 and 2019 assessments. It also took into account data from EU data center (European Marine Observation and Data Network - EMODnet), as a reliable external data source, as well as data collected from the scientific literature. A detailed compilation of the available new data is given in Section 3.

2 The assessment criteria for IMAP Common Indicators 17 and 18

3. Deriving and setting up criteria to determine environmental status is not an easy task. It gets more complicated going from the local to sub-regional and regional assessments. While there are many methodologies to derive criteria, the first step is aimed at defining the background or reference conditions from which to measure/determine the status and trends. In the framework of UNEP/MAP (UNEP/MAP 2016, 2019), the background concentration (BC) is defined as “The concentration of a contaminant at a “pristine” or “remote” site based on contemporary or historical data”. The BC of anthropogenic (man-made) substance was defined as zero.-The same definitions are used by OSPAR and the Marine Strategy Framework Directive (MSFD) based on the Water Framework Directive (WFD) (Tornero et al. 2019)²².

4. In line with these definitions, the BC determination is the first step of the derivation of indicators that are defined as the measure, index or model used to estimate the current state and future trends, along with thresholds for possible management action.

2.1 Methodology for background concentration (BC) determination

5. Several methods can be used to derive BC values for natural occurring elements/substances in different environmental matrices (i.e. sediment and biota)²³. Briefly, they include using global average concentrations; pre-industrial age data; current data from pristine sites; data from monitoring programmes, whereas known polluted sites are excluded.

2.2 The methodology for the determination of Background concentration (BC) used by UNEP/MAP

6. The BCs were derived using data from sediment cores compiled from the scientific literature (UNEP/MAP 2011) and data from the MEDPOL database (UNEP/MAP 2011, 2016, 2019). A complete explanation of the used methodologies is given in these documents, as well as in UNEP/MAP WG.492/Inf.11 submitted for consideration of present Meeting.

2.2.1 Trace Metals (Cd, Hg and Pb) in sediments

7. The approved BCs for Trace Metals (TM) in sediments are summarized in Table 1. Briefly, in 2016, the first step was to choose the stations to be considered as reference at a country level. For each country, each parameter was grouped by year and the years without temporal trend chosen. Next, the parameters were grouped by stations and the overall median value computed. Stations where the 75th percentile of the data were below the overall median were chosen as reference stations. Data of the

²⁰ UNEP/MAP (2015). Decision IG.22/7 on Integrated Monitoring and Assessment Programme of the Mediterranean Sea and Coast and Related Assessment Criteria (Annex II), (COP 19, 2015).

²¹ UNEP/MAP (2017). Decision IG.23/6 on Mediterranean Quality Status Report (COP20, 2017).

²² Additional definitions for BC can be found in the literature and are explained in UNEP/MAP WG.492/Inf 11 submitted for information to present meeting.

²³ See document UNEP/MAP WG.492/Inf 11.

reference stations were aggregated for the whole Mediterranean Sea and the MedBC computed as the median value of all reference stations. In 2019, BC values were computed in a similar way for 3 out of the 4 Mediterranean sub-regions²⁴: Western Mediterranean (WMS), Adriatic Sea (ADR) and Aegean-Levantine Seas (AEL)²⁵. No data were available to calculate BC for the Central Mediterranean (CEN). It was recommended to normalize the concentrations to AI (5%) concentrations²⁶.

Table 1. Background concentrations (BC) and Background assessment concentrations (BAC) calculated for trace metals (TM) in sediments for the Mediterranean Sea and sub-regions in 2011 and 2019. The table also presents the MedBAC and MedEAC values agreed upon in Decisions IG.22/7 and IG.23/6. Concentrations are given in µg/kg dry wt, as requested by IMAP²⁷.

TM	Decisions IG.22/7 and IG.23/6 (COP 19 and COP 20)			UNEP/MAP (2011)		UNEP/MAP (2019)			
	MedBAC	MedBAC	MedEAC*	Med BC	Med BC	Med BC	BC	BC	BC
	IG.22/7	IG.23/6	IG.23/6	Sed cores	Surf Sed	Ref Stn	WMS	ADR	AEL
Cd	150	127.5	1200	100	20	85	91.2	92.3	56
Hg	45	79.5	150	30	10	53	60	106.8	31.2
Pb	30000	25425	46700	20000	2310	16950	20465	13932	4920

* ERL (Effects Range Low, Long et al. 1995, idem OSPAR values). Sediment (Sed); Surficial (Surf); Reference stations (Ref Stn); Western Mediterranean (WMS); Adriatic (ADR) Aegean; Levantine Sea (AEL). No data were available to set up BCs for the Central Mediterranean (CEN).

8. Further to this work, present document (Section 4) provides updated BC and BAC values for TM in sediments. They were calculated by using the new data and the same methodologies as applied in 2016 and 2019

2.2.2 Naturally occurring organic compounds (PAHs) in sediment

9. MedBC values for PAHs in sediments are summarized in Table 2. The BCs were computed based on data derived from sediment cores compiled from the scientific literature, as well as data available in MEDPOL database (UNEP/MAP 2011). Normalization of organic compounds concentrations to total organic carbon (TOC) (2.5%) was recommended.

Table 2. Background concentrations (BC) calculated for PAHs in sediments for the Mediterranean Sea in 2011. The table also presents the MedEAC values agreed upon in Decisions IG.22/7 and IG.23/6. Concentrations are given in µg/kg dry wt, as requested by IMAP.

PAH compounds	Decisions (COP 19 and COP 20)	UNEP/MAP (2011)	
	EAC* IG.22/7 and IG.23/6	BC Sed cores	BC Sur sed
Naphthalene (N)		4	
Acenaphthylene (ACY)		0.5	1.05
Acenaphthene (ACE)		0.38	0.45
Fluorene (F)		0.75	0.33
Phenanthrene (P)	240	4.55	3.95

²⁴Although sub-regional values for the BCs in sediment were proposed, an updated 2019 assessment used the ones calculated in 2016, awaiting further confirmation of sub-regional values when new reference datasets will be available, whilst for mussels the proposed sub-regional values of BCs were exercised.

²⁵The Mediterranean sub-regions and subareas are initially proposed according to availability of database sources for calculation of the assessment criteria (UNEP/DEPI/MED WG.427/Inf.3; UNEP/MED WG.463/8; UNEP/MED WG.467/7).

²⁶Normalization should be used with care, and only if field data support that normalization is valid for the area. An explanation on normalization practice for monitoring of IMAP Common Indicator 17 is provided in Monitoring (Guidelines/Protocols for Sample Preparation and Analysis for sediments (UNEP/MAP WG.482/12) and biota (UNEP/MAP WG.482/14)).

²⁷UNEP/MED WG.467/5. IMAP Guidance Factsheets: Update for Common Indicators 13, 14, 17, 18, 20 and 21: New proposal for candidate indicators 26 and 27; UNEP/MED WG.467/8. Data Standards and Data Dictionaries for Common Indicators related to Pollution and Marine Litter.

PAH compounds	Decisions (COP 19 and COP 20)	UNEP/MAP (2011)	
	EAC* IG.22/7 and IG.23/6	BC Sed cores	BC Sur sed
Anthracene (A)	85	0.8	1.56
Fluoranthene (FL)	600	5.6	6.7
Pyrene (PY)	665	10.28	2.1
Benzo[a]anthracene (BaA)	261	3.45	1.28
Chrysene (C)	384	1.3	6.64
Benzo(b)fluoranthene (BbF)		1.1	8.32
Benzo(k)fluoranthene (BkF)		0.53	6.03
Benzo[a]pyrene (BaP)	430	2.55	3.71
Benzo[g,h,i]perylene (GHI)		1.25	3.25
Dibenzo[a,h]anthracene (DA)	63.4	0.18	1.37
Indeno[1,2,3,c,d]pyrene (ID)		1.7	4.49

* ERL. ERL for Naphthalene (160 µg/kg dw) and Total PAHs (4022 µg/kg dw) were derived by Long et al., 1995, but they do not appear in the COPs decisions

10. Further to this work, present document (Section 4) provides updated BC and BAC values for PAHs in sediment. They were calculated by using the new data and the same methodologies as applied in 2016 and 2019 for trace metals.

2.2.3 Naturally occurring trace metals (Cd, Hg and Pb) and organic compounds (PAHs) in biota²⁸

11. Unlike the sediments, there are no values of the pristine, pre-industrial concentrations of naturally occurring compounds in biota. In 2011, the BC concentrations were computed based on the whole MEDPOL database (excluding known polluted stations), as the median of the lower 5% of the data. In 2016 and 2019, the BC concentrations were computed as for trace metals in sediments, based on the data sets from the selected reference stations. The calculated BC values for TM are presented in Table 3 for mussel and fish. The calculated BCs for PAHs in mussel are presented in Table 4. It should be emphasized that BC concentrations are species specific as well as tissue specific (i.e. natural concentrations in muscle are different from the natural concentrations in liver). In addition, BC concentration may depend on age of the specimens, with length and weight usually used as a proxy to age²⁹.

Table 3. Background concentrations (BC) calculated for trace metals in mussel and fish for the Mediterranean Sea and sub-regions in 2016 and 2019. The table also present the MedBAC and MedEAC values agreed upon in Decisions IG.22/7 and IG.23/6. Concentrations are given in the units requested by IMAP.

TM	Decisions (COP 19 and COP 20)			UNEP/MAP (2019)			
	MedBAC	MedBAC	#MedEAC	BC	BC	BC	BC
	IG.22/7	IG.23/6	IG.23/6	Med	WMS	ADR	AEL
Mussel soft tissue (<i>Mytilus galloprovincialis</i>), µg/kg dry wt							
Cd	1088	1095	5000	730	660.5	782	942
Hg	188	173.2	2500	115.5	109.4	126	110
Pb	3800	2313	7500	1542	1585	1381	2300
Fish muscle (<i>Mullus barbatus</i>) µg/kg wet wt							
Cd	16**	*3.7	50	*3.7			
Hg	600**	101.2	1000	50.6	68	150.5	44.6
Pb	359**	*31	300	*31	38		20

* Most values below detection limit, ** Concentrations in µg/kg dry wt as given in Decision IG. 22/7. # EACs are the ECs, the maximum levels for certain contaminants in foodstuffs based on European policy (EC/EU 1881/2006, 1259/2011)

²⁸ The mussel *Mytilus galloprovincialis* (MG) and the fish *Mullus barbatus* (MB), the agreed mandatory species for monitoring

²⁹ See document UNEP/MAP WG.492/Inf 11

UNEP/MED WG.509/43

Annex III

Appendix 7

Page 4

Directives and amendments 488/2014 and 1005/2015). Western Mediterranean (WMS); Adriatic (ADR) Aegean; Levantine Sea (AEL). No data were available to set up BCs for the Central Mediterranean (CEN)

Table 4. Background concentrations (BC) calculated for PAHs in mussel (*Mytilus galloprovincialis*) soft tissue for the Mediterranean Sea and sub-regions in 2016 and 2019. The table also present the MedBAC and EAC values agreed upon in Decisions IG.22/7 and IG.23/6. Concentrations are given in µg/kg dry wt, as requested by IMAP.

PAH compounds	Decisions (COP 19 and COP 20)		UNEP/MAP (2019)			
	MedBAC	EAC*	BC	BC	BC	BC
	IG.23/6	IG.22/7 and IG.23/6	Med	WMS	ADR	AEL
Naphthalene			(2.4) #	2.24		2.80
Acenaphthylene			(0.6) #			
Acenaphthene			(0.6) #			
Fluorene	2.5		1.0	0.96	1.07	0.60
Phenanthrene	17.8	1700	7.1	4.93	9.04	7.55
Anthracene	1.2	290	0.5	0.52	0.38	0.30
Fluoranthene	7.4	110	3.0	3.38	2.03	6.60
Pyrene	5.0	100	2.0	3.02	0.85	5.90
Benzo[a]anthracene	1.9	80	0.8	1.20	0.53	1.60
Chrysene	2.4		1.0	1.24	0.27	5.20
Benzo(b)fluoranthene						
Benzo(k)fluoranthene	1.4	260	0.6	1.27	0.29	1.50
Benzo[a]pyrene	1.2	600	0.5	0.60	0.32	0.70
Benzo[g,h,i]perylene	2.3	110	0.9	0.90		1.20
Dibenzo[a,h]anthracene	1.3		0.5	0.53		
Indeno[1,2,3,c,d]pyrene	2.9		1.2	1.23		0.90

* EC, maximum levels for certain contaminants in foodstuffs based on European policy (EC/EU 1881/2006, 1259/2011 Directives and amendments 488/2014 and 1005/2015). # most data below detection limit. In red, sub-regional BC values higher than MedBAC (MedBAC= 1.5 MedBC, see Section 2.3.1)

12. Further to this work, present document (Section 4) provides updated BC and BAC values for TM in biota and PAHs in mussel. They were calculated using the new data and the same methodologies as applied in 2016 and 2019.

2.2.4 Synthetic substances (non-naturally occurring) in sediments and biota

13. The BC of any anthropogenic (man-made) substance is defined as zero. However, analytically, it is impossible to measure a concentration that equals zero. Therefore, the BC determination is based on the detection limits of the methods used and its uncertainty (precision and accuracy), as determined from CRMs (Certified reference materials) and proficiency testing. IMAP addresses organochlorinated compounds (PCBs and pesticides) as detailed in Table 5. This table summarizes the EAC values for the Mediterranean, agreed upon in Decisions IG.22/7 (COP19) and IG.23/6 (COP20). No BC nor LC (Low concentrations) were calculated for the Mediterranean in 2016 nor in 2019 (UNEP/MAP, 2016, 2019).

Table 5. EAC values for organochlorinated contaminants in sediments, in mussel (*Mytilus galloprovincialis*) soft tissue and muscle tissue in fish (*Mullus barbatus*) to be used in the Mediterranean Sea. The values were agreed upon in Decisions IG.22/7 and IG.23/6 and follow OSPAR's recommendations. Concentrations are given in the units requested by IMAP.

	Sediments		Mussel	Fish
	EAC* IG.22/7(µg/kg dw)	MedEAC* IG.23/6(µg/kg dw)	EAC IG.22/7 and IG.23/6 (µg/kg dw)	EAC IG.22/7 and IG.23/6 (µg/kg lipid)
PCBs				
CB28		1.7	3.2	64
CB52		2.7	5.4	108
CB101		3	6	120
CB118		0.6	1.2	24
CB138		7.9	15.8	316
CB153		40	80	1600
CB156				
CB180		12	24	480
Sum 7 PCBs	11.5			
Pesticides				
γ-HCH (Lindane)	3		1.45	11 µg/kg ww
DDE(p,p')	2.2		5-50	
Hexachlorobenzene	20			
Dieldrin	2		5-50	

* ERL (Effects Range Low, Long et al. 1995, idem OSPAR values).

14. Further to this work, present document (Section 4) shows that the data were not sufficient to provide BC and BAC values for organochlorinated contaminants in sediment and biota.

2.3 The methodologies for thresholds` determination used by UNEP/MAP

15. UNEP/MAP has adopted the threshold assessment methodology, based on the “traffic light” approach, by defining 2 values to classify 3 environmental categories: 1) good (acceptable, not different from BC); 2) above background but with low risk for environment and biota population, or below dietary limits for fish and sea food concerning human health; and 3) unacceptable. The two values defined were i) the Background Assessment Concentration (BAC) (or T_0) and ii) the Environmental Assessment Criteria (EAC) for TM and organic contaminants in sediments and biota, or EC for TM and organic contaminants in biota, (or T_1). The above Tables 1-5 tabulate the values of BAC and EAC adopted or proposed to be used for the assessment of the quality status of the Mediterranean Sea (IMAP Decisions 22/7 (COP 19) and 23/6 (COP 20)).

2.3.1 Background Assessment Concentration (BAC) determination

16. BAC are the concentrations below which no deterioration of the environment can be expected. Observed concentrations are said to be near BC if the mean concentration is statistically significantly below BAC. For calculation of BAC values from BC concentrations UNEP/MAP adopted the methodology that corresponds to the OSPAR methodology. The BAC values were computed as the BC concentration multiplied by a factor that was determined based on the uncertainty (precision and accuracy) of the determinations. The multiplication factors were as follows: MedBAC=1.5 x MedBC (for mussel and sediment matrices); MedBAC=2.0 x MedBC (fish).

17. The MedBAC values endorsed in Decisions IG.22/7 and IG.23/6 are as follows: MedBAC for TM in sediments, mussel and fish (Tables 1,3) and PAHs in mussel (Table 4). In 2019, the same methodology was used to propose derivation of specific sub-regional MedBAC values.

18. Further to work undertaken in 2019, this document proposes updated regional and sub-regional BAC values for the Mediterranean, using the same methodology as in 2019. The proposed values are presented in Section 4.

2.3.2 Environmental Assessment Criteria (EAC) determination

19. EAC values are the concentrations above which significant adverse effect to the environment or to human health are most likely to occur. Conversely, EAC values are defined as the concentrations below which it is unlikely that unexpected or unacceptable biological effects will occur in exposed marine species. Due to that fact that it was not possible to develop EAC for MED at that time, it was agreed to use the criteria developed by OSPAR and NOAA/USEPA (ERL values) (Long et al. 1995), as the EAC values for the Mediterranean. The EAC values agreed in Decisions IG.22/7 and IG.23/6 are as follows: EAC values for TM, PAHs and organochlorinated contaminants (PCBs and pesticides) are provided for sediments in Tables 1, 2 and 5; TM and organochlorinated contaminants are provided for mussel and fish in Tables 3 and 5 and PAHs are provided for mussel in Table 4.

20. A proposal of a new methodology to derive EAC values specific for the Mediterranean Sea is described in Section 4.

2.3.3 European Union regulations (EC)

21. The EAC values for TM and PAHs in biota as endorsed by Decisions IG.22/7 and IG.23/6 (Table 3) are the concentrations in fish and seafood recommended as dietary limits for human consumption concerning human health (EC). EC values are derived from the following EU Directives regulating maximum levels for certain contaminants in foodstuffs: EC/EU 1881/2006, 1259/2011, 488/2014 and 1005/2015. Section 4.3 gives more details about EC values. It should be mentioned that these values were set up to protect human health and may be too lenient to protect the environment.

22. A proposal of new methodology to derive EAC values for the Mediterranean Sea is described in Section 4.

2.4 The assessment criteria for IMAP Common Indicator 18

23. By Decisions IG.22/7 and IG. 23/6, the Contracting Parties endorsed BAC and EAC values for the following biomarkers for the mussel (*Mytilus galloprovincialis*): Acetylcholinesterase activity (AChE), Metallothioneins (MT), Micronuclei frequency (MN), Lysosomal membrane stability (LMS-NRR and LMS-LP methods) and Stress on Stress (SoS). These values are indicative and serve as the initial assessment criteria.

24. Presently there are no new data that can be used to update the biomarkers' assessment criteria. Therefore, they were not addressed in Section 4. More information on biomarkers and related criteria derivation is given in UNEP/MAP WG.492/Inf 11.

3 Survey of relevant data not used previously neither for preparation of the Mediterranean Quality Status Report (2017 MED QSR) nor for the State of Environment and Development Report (2019 SoED)

25. New relevant data not used previously neither for the 2017 MED QSR nor for update of the assessment for EO9 within preparation of the 2019 SoED were collected from the following 4 data sources:

1. New data from IMAP Pilot Info System that include national monitoring data uploaded in the system during its testing phase, and in particular after launching formal call for reporting of data in June 2020.
2. New data from the MEDPOL Database not used previously for calculation of assessment criteria;
3. The EU data center (European Marine Observation and Data Network - EMODnet);
4. Published papers collected from the scientific literature.

26. Details of the available data from these sources are given below.

3.1 IMAP Pilot Info System and MEDPOL Database

27. Tables 6 and 7 provide a detailed examination of the new available data sorted by matrix, country and sampling year. The datasets used in the 2017 and 2019 assessments are given in UNEP/MAP WG.492/inf 11.

28. It can be seen that the IMAP and MEDPOL data included only TM and organic contaminants in sediment and biota (CI17). No new data were available for biomarkers (CI18). New biomarker data were not available also for assessments that contributed to 2019 SoED.

Table 6: An overview of available new data from IMAP Pilot Info System. The numbers next to the years are the number of observations for each parameter, sorted by country and sampling year. The number of below detection limit (BDL) observations is given in parenthesis.

Trace metals	Species	Year	Cd	Hg	Pb
Bivalve/mollusc					
Lebanon	<i>Patella sp.</i>	2019	16 (0)	16 (0)	16 (0)
Morocco	<i>Callista chione</i>	2016	10 (0)	10 (0)	10 (0)
		2017	10 (0)	10 (0)	10 (0)
		2018	5 (0)	5 (0)	5 (0)
Slovenia	<i>M. galloprovincialis</i>	2018	3 (0)	3 (0)	3 (0)
		2019	3 (0)	3 (0)	3 (0)
Fish					
Croatia	<i>Conger conger</i>	2012	4 (4)	4 (0)	4 (0)
Lebanon	<i>Diplodus sargus</i>	2019	11 (0)	11 (0)	11 (0)
	<i>Euthynnus alletratus</i>	2019	15 (0)	15 (0)	15 (0)
	<i>Mullus barbatus</i>	2019	14 (0)	14 (0)	14 (0)
Sediment					
Cyprus		2013	2 (0)	2 (2)	2 (0)
		2014	4 (1)	4 (4)	4 (3)
		2015	3 (0)	3 (3)	3 (1)
		2016	2 (0)	2 (2)	2 (0)
		2017	7 (0)	7 (6)	7 (0)
		2018	4 (1)	4 (4)	4 (1)
Morocco		2016	11 (9)	0	11 (4)
		2017	11 (1)	11(11)	11 (7)
		2018	11 (0)	11(11)	11(1)
Slovenia		2019	1(1)	1(0)	1(0)

PAHs and Organochlorinated contaminants										
Bivalves/mollus	Species	Year	Total PAH	Total PCB	HCB*	CB101	CB138	CB153	CB180	CB52
Lebanon	<i>Patella sp</i>	2019	15 (0)	15 (8)						
Morocco	<i>C.chione</i>	2016			7 (0)	1 (0)	7 (0)	7 (0)	5 (0)	0
		2017			7(0)	0	2(0)	3 (0)	7(0)	0
		2018			5 (0)	5 (0)	6 (0)	5 (0)	6 (0)	1
Slovenia	<i>M. galloprovincialis</i>	2019	3 (3)							
Fish					HCB*	Dieldrin	Aldrin	DDE(p, p')	DDT(p, p')	DDD(p, p')

PAHs and Organochlorinated contaminants										
Bivalves/mollus	Species	Year	Total PAH	Total PCB	HCB*	CB101	CB138	CB153	CB180	CB52
Croatia	<i>C. conger</i>	2012			4 (3)	8 (2)	8 (8)	8 (0)	8 (0)	8 (0)
Lebanon	<i>D.sargus</i>	2019	3 (0)	3 (0)						
	<i>E.. alletratus</i>	2019	10 (0)	13 (0)						
	<i>M. barbatus</i>	2019	6 (0)	3 (0)						
Sediment										
Lebanon		2019	19 (0)	19 (9)						
Slovenia		2019	1 (1)	1 (1)	1 (1)					

* HCB- Hexachlorobenzene

Table 7: New data available in MEDPOL Database. The numbers next to the years are the number of observations for each parameter, sorted by country and sampling year. The number of below detection limit (BDL) observations is given in parenthesis.

	Species ³⁰	Year	Cd	Hg	Pb	Total PAHs	Hydrocarbons
Bivalves							
Israel	<i>MC</i>	2017	2 (0)	2 (0)	0		
Montenegro	<i>MG</i>	2018	8	8	8	9 (5)	
Slovenia	<i>MG</i>	2017	3 (0)	3 (0)	3 (0)		
Tunisia	<i>ML</i>	2014	0	3 (0)	0		
	<i>RD</i>	2014	0	11(0)	0		
Fish							
Israel	<i>DS</i>	2017	13(12)	13(0)	0		
	<i>LM</i>	2017	28(27)	28 (0)	0		
	<i>SR</i>	2017	11(12)	11 (0)	0		
	<i>SRB</i>	2017	10(10)	10 (0)	0		
	<i>DS</i>	2018	9 (4)	9 (0)	0		
	<i>SRB</i>	2018	10 (10)	10 (0)	0		
SEDIMENT							
Israel		2017	14 (0)	14 (0)	14(0)		
Montenegro		2018	6 (0)	6 (0)	6 (0)	5 (0)	5 (5)
Slovenia		2013				7 (0)	
		2014				6 (0)	
		2015				6 (0)	
		2016				7* (0)	
		2018				1* (0)	
Tunisia		2014	9 (9)	9 (0)	9 (9)		6 (0)

* data for 16 individual PAHs.

³⁰MC – *M. corralina*, MG – *M. galloprovincialis*, RD - *R.ruditapes*, , DS - *D. sargus*, LM - *L. mormyrus*, SR- *S. rivulatus*, SRB-S. *rubrum*.

3.2 Data from the EU data center (European Marine Observation and Data Network - EMODnet)

29. Data from EMODnet used to complement data available in IMAP Pilot Info System and MEDPOL Database are summarized in Table 8.

Table 8. Data from EMODnet used for present update of BC/BAC values, complementing data available in IMAP Pilot Info System and MEDPOL Database. “n” is the number of observations.

Country	Year	Matrix	n	Parameters available*
France	2016	S	33	Cd, Hg, Pb
Croatia	2016	S	35	Cd, Hg, Pb
Italy	2016	S	5	Cd, Hg, Pb
France	2017	B (MG)	3	Cd, Hg, Pb
Italy	2015-2018	B (MG)	61	Cd, Hg, Pb
France	2016	S	29	PAHs, PCBs, Pesticides
Italy	2015-2016	S	5	PAHs, Pesticides
France	2017	B (MG)	2	PAHs, PCBs
Italy	2016-2017	B (MG)	18	PAHs
Italy	2017	B (MG)	2-33	Pesticides

* Not all parameters available for all samples. S-Sediment, B-Biota, MG- *M. galloprovincialis*

3.3 Data from the scientific literature

30. Below Table 9 lists the available scientific papers used in the preparation of this document. It is important to note that the papers are usually limited in scope, both spatially and temporally. Moreover, they usually include contaminated and reference sites, so care should be taken when utilizing the data for BC calculation or verification. The search was geared towards finding recent data, from samples collected since 2012, and towards data from the southern Mediterranean countries. Detailed elaboration of relevant scientific literature is provided in UNEP/MAP WG.492/inf 11 (Annex 2).

Table 9. Data available from the scientific literature. The characterization of information provided in table is as follows: Data – all data could be retrieved from the paper; BC – paper specifies the background concentrations; Statistics – only statistics of the data are given (i.e. mean, standard deviation)

Country	Sampling year	Matrix	Parameter	Data	Reference
Algeria	2015	S	Cd, Pb	Statistics, BC	(Ahmed et al. 2018)
Algeria	2014	B (MG)	Cd, Pb	Statistics	(Benali et al. 2017)
			PCB, PAH	Data*	
Egypt	ng	S	Cd, Pb	range	(El Baz and Khalil 2018)
France	2014	B (MG)	Hg	Data*	(Briant et al. 2017)
Greece	2016-2018	S	Pb	Data*	(Karageorgis et al. 2020)
Italy	2012	B (Fish)	Hg	Data**	(Bonsignore et al. 2015)
Lebanon	2017	S, B (mollusc)	Cd, Hg, Pb	Statistics	(Ghosn et al. 2020b)
Lebanon	2017	B (fish)	Cd, Hg, Pb	Statistics	(Ghosn et al. 2020a)
Morocco	2016	B (MG)	Cd, Pb	Statistics	(Azizi et al. 2016)
Spain	2011,2012, 2015	S	Cd, Hg, Pb	BC	(Martínez-Guijarro et al. 2019)
Tunisia	2011	B	Cd, Hg, Pb	Statistics	(Rabaoui et al. 2014)
Tunisia	2016	S	Cd, Pb	Statistics, BC	(Naifar et al. 2018)
Tunisia	2018-2019	S, B	Org. contam.	Data*	(Jebara et al. 2021)

S-Sediment, B-Biota, ng- not given; *- data used for present update of BC/BAC values; **- data not used since were related to polluted sites

3.4 Examination of the new data

31. The new data available were examined and used for BC and BAC's calculation, as appropriate. The computed values were then compared with the environmental criteria for the Mediterranean Sea as endorsed in Decision 23/6 (COP 20). Those are presented in section 4.

32. Data were very limited, therefore data from different years were aggregated per country and outliers identified (using box plots) and not considered in the calculation of the median values. When needed, data were transformed to the concentration units requested by IMAP. It should be mentioned that sediment data were not normalized.

33. In addition, for biota, it was not always clear if the concentrations were reported in dry or wet weight. When not specified, it was assumed that the data were reported to IMAP Info System/MEDPOL database as requested by IMAP.

34. This comparison was undertaken in order to confirm data relevance for computing the updated BC and BAC values (Section 4). An in-depth examination of the data is presented in UNEP/MAP WG.492/inf 11 (Annex 3).

4 Critical examination of recommended environmental criteria and proposals for their update

35. In line with Decision 22/7 (COP 19), the assessment criteria for the Mediterranean Sea should follow the "traffic light" system for both contaminant concentrations and biological responses where two thresholds and three status categories are defined. As explained above, the two values defined were the Background Assessment Concentration (BAC) (T_0) and the Environmental Assessment Criteria (EAC) or EC values (T_1), (see Section 2).

4.1 Updated BC and BAC values for IMAP CI 17

36. The new data presented and critically analyzed above in Section 3 were used to calculate BC values for the sub-regional areas of the Mediterranean and for the whole Mediterranean Sea using the same methodology as initially applied in 2016/2017 and replicated in 2019 (see detail explanation in Section 2). BAC values are calculated by multiplying the BCs by a factor, as follows: MedBAC=1.5 x MedBC (for mussel and sediment matrices); MedBAC=2.0 x MedBC (fish). When most of the data originated from one sub-region, and there were significant differences among them, the BC values were calculated for the sub-region(s) only.

37. Tables 10-12 present the new updated BC and BAC values. The tables include also the values of the assessment criteria as endorsed in Decision 23/6 (COP 20), as well as their values updated in 2019.

Table 10. BC and BAC values for trace metals in sediments, calculated from the new data. The table shows also the previously endorsed/updated values. Concentrations are given in $\mu\text{g}/\text{kg}$ dry wt, as requested by IMAP. The number of data points (n) taken to calculate the BCs appear below the values.

BCs							
TM	Med (cores)	Med (surf)	Med	WMS	ADR	CEN	AEL
	2011 ³¹		2019				
Cd	100	20	85	91.2	92.3		56
Hg	30	10	53	60	106.8		31.2
Pb	20000	2310	16950	20465	13932		4920
Proposed new updated BC values (2021)							
Cd			116	115	166		113

³¹ The values calculated in 2011 are shown for comparison. The values were calculated from data compiled from the scientific literature (UNEP/MAP 2011) and need no recalculation

<i>n</i>			135	56	41		38
Hg			32.6	25.0	54.1	2-69*	50.3
<i>n</i>			113	33	37	6	37
Pb			15900	12000	27066		17700
<i>n</i>			229	58	44		127
BACs							
		IG.23/6	Med	WMS	ADR	CEN	AEL
		2017	2019				
Cd		127.5	127.5	136.8	138.5		84.0
Hg		79.5	79.5	90.0	160		46.8
Pb		25425	25425	30698	20898		7380
Proposed new updated BAC values (2021)							
Cd			158	173	249		169
Hg			49.2	37.5	81.2		75.5
Pb			24269	18000	40599		26550

38. It can be seen that the updated regional Mediterranean BC values for Cd and Hg are very similar to the ones calculated in 2011 from sediment cores while value for Pb is lower. Comparison to the BCs values updated in 2019 shows that presently updated regional BC values for Cd is higher, Hg is lower and Pb slightly lower (4%). Comparison of the sub-regional BC values calculated in 2019 and 2021 shows differences as well. Possible reasons for these differences could be due to different sediment mineralogical composition and the location of the sampling stations. In addition, for the regional BC values, an unbalanced number of data points among the sub-regions taken for the calculation, possibly gives an unproportionate weight.

Table 11. BC and BAC values for PAHs in sediments, calculated from the new data. The table presents also the previously endorsed/updated values. Concentrations are given in mg/kg dry wt, as requested by IMAP. The number of data points (*n*) taken to calculate the BCs appear to the right of the values. No data were available for the AEL sub-region.

PAH compounds	UNEP/MAP (2011)		Proposed new updated BC values (2021)							
	BC, Sed cores	BC, Sur sed	Med	<i>n</i>	WMS	<i>n</i>	ADR	<i>n</i>	CEN	<i>n</i>
Naphthalene	4		8.0	36	8.8	29	2.0	5	2.5	2
Acenaphthylene	0.5	1.05	0.4	34	0	29	1.5	4	0.4	5
Acenaphthene	0.38	0.45	4.7	29	4.7	29	11.5	8		
Fluorene	0.75	0.33	7.5	41	7.5	29	6.0	3	0.4	5
Phenanthrene	4.55	3.95	16.8	42	22.5	29	15.0	7	0.8	5
Anthracene	0.8	1.56	3.4	40	5.0	29	8.5	6	0.7	7
Fluoranthene	5.6	6.7	22.1	43	32.2	29	12.0	13	2.0	2
Pyrene	10.28	2.1	15.9	42	22.4	29	12.5	8	0.4	5
Benzo[a]anthracene	3.45	1.28	19.1	37	20.9	29	23.0	13		
Chrysene	1.3	6.64	25.0	37	37.6	29	6.0	3	1.6	5
Benzo(b)fluoranthene	1.1	8.32	12.8	44	9.3	29	9.6	13	50	2
Benzo(k)fluoranthene	0.53	6.03	8.4	44	7.8	29	19.5	8	27	2
Benzo[a]pyrene	2.55	3.71	2.4	42	2.6	29	17.6	13	1.8	7
Benzo[g,h,i]perylene	1.25	3.25	6.9	44	5.0	29	9.0	8	100	2
Dibenzo[a,h]anthracene	0.18	1.37	0	37	0	29	7.0	12		
Indeno[1,2,3,c,d]pyrene	1.7	4.49	1.0	44	0	29	12.5	8	2.0	2
Total PAHs			165	71	166	29	218	32	6.6	7
PAH compounds	IG.23/6 (2017)		Proposed new updated BAC values (2021)							
	MedBAC		Med		WMS		ADR		CEN	
Naphthalene			12		13		3		3.8	
Acenaphthylene			0.6		0		2.3		0.6	
Acenaphthene			7.1		7.1		17		0	
Fluorene	2.5		11		11		9		0.6	
Phenanthrene	17.8		25		34		23		1.2	

PAH compounds	UNEP/MAP (2011)		Proposed new updated BC values (2021)							
	BC, Sed cores	BC, Surf sed	Med	n	WMS	n	ADR	n	CEN	n
Anthracene	1.2		5.1		7.5		13		1.1	
Fluoranthene	7.4		33		48		18		3	
Pyrene	5.0		24		34		19		0.6	
Benzo[a]anthracene	1.9		29		31		35		0	
Chrysene	2.4		38		56		9.0		2.4	
Benzo(b)fluoranthene			19		14		14		75	
Benzo(k)fluoranthene	1.4		13		12		29		41	
Benzo[a]pyrene	1.2		3.6		3.9		26		2.7	
Benzo[g,h,i]perylene	2.3		10		7.5		14		150	
Dibenzo[a,h]anthracene	1.3		0		0		11		0	
Indeno[1,2,3,c,d]pyrene	2.9		1.5		0		19		3	
Total PAHs			248		249		327		9.9	

39. Concentrations of PAH compounds in the sediments were available for 29 - 44 data points, while for Total PAHs, 71 data points were available. The calculated BC values for some of the compounds were higher than the BC concentrations measured in sediment cores and surficial sediments of the Mediterranean Sea in 2011, while for other compounds they were similar. This could be due to the limited number of datapoints used for the calculation both in 2011 and 2021. Therefore, it is proposed to use presently updated values of BC/BAC for preparation of input assessments for 2023 MED QSR, along with further update of the assessment criteria if more data will be reported by the CPS³². Moreover, it is recommended to add the concentration of Total PAHs to the list of parameters.

Table 12. BC and BAC values for trace metals in mussel (*M. galloprovincialis*) and BC values for trace metals in other biota species calculated from the new data³³. The table presents also the previously endorsed/updated values. The units of concentrations are given as requested by IMAP. The number of data points (n) taken to calculate the values appear below the values.

BCs						
TM		Med	WMS	ADR	CEN	AEL
Mussel soft tissue (<i>M. galloprovincialis</i>), µg/kg dry wt						
2019						
Cd		730	660.5	782		942
Hg		115.5	109.4	126		110
Pb		1542	1585	1381		2300
TM		Proposed new updated BC values (2021)				
Cd		490	1010	88	77.8	>
n		51	30	17	4	
Hg		83	118	43	12.3	>
n		110	53	49	8	
Pb		1090	1245	100	250	>
n		51	30	17	4	
BACs						
	Med	Med	WMS	ADR	CEN	AEL
TM	IG.23/6 (2017)	2019				
Cd	1095	1095	991	1173		1413
Hg	173.2	173.2	164.1	189		165

³² The values for a few of the compounds in Table 11 are 0, meaning that the concentrations measured were BDL. Paragraph 46 below addresses the topic of BDL concentrations.

³³ BAC values were calculated just for *M. galloprovincialis*. Data for the other mandatory species (*M. barbatus*) were not enough to calculate Med BACs. To calculate BACs from the BCs the following factors should be applied: BAC=1.5 x BC (mussel); BAC=2.0 x BC (fish).

BCs						
TM		Med	WMS	ADR	CEN	AEL
Pb	2313	2313	2378	2072		3450
Proposed new updated BAC values (2021)						
Cd		735	1515	132	117	>
Hg		124	177	64.5	18.5	>
Pb		1635	1868	150	375	>

BCs						
TM		Med	WMS	ADR	CEN	AEL
Bivalves, soft tissue (various species) ³⁴ µg/kg dry wt, calculated in 2021						
Cd			0.65			
<i>n</i>			25			
Hg			0.15		41.5	
<i>n</i>			25		14	
Pb			1.65			
<i>n</i>			25			
Fish muscle (<i>Mullus barbatus</i>) µg/kg wet wt, calculated in 2019						
Cd	*3.7#	*3.7				
Hg	101.2#	50.6	68	150.5		44.6
Pb	*31#	*31	38			20
Fish muscle (<i>Mullus barbatus</i>) µg/kg wet wt, calculated in 2021						
Cd						2.5
<i>n</i>						39
Hg						29.2
<i>n</i>						60
Pb						13.5
<i>n</i>						39
Fish muscle (various species) ³⁵ µg/kg wet wt, calculated in 2021						
Cd		0.38		51.8		0.31
<i>n</i>		37		4		33
Hg		32.2		20.1	340^	33.4
<i>n</i>		110		4	20	106
Pb				224		0.46
<i>n</i>				3		22

#MedBAC in Decision IG.23/6; * Most values BDL; ^ questionable values, may be related to hot spot stations, therefore not taken for the calculation of regional MedBC; > it is recommendation to use the values calculated in 2019.

40. The regional MedBC values for Cd, Hg and Pb in *M. galloprovincialis* calculated in 2021 were lower than those calculated in 2019. The subregional BCs for the WMS and the ADR were also different: WMS BC for Cd was higher and for Pb lower in 2021 compared to 2019, while WMS BC for Hg was similar. In the Adriatic the BC concentrations were much lower in 2021 than in 2019: ADR BC for Cd and Pb decreased by about one order of magnitude, while for Hg it was about 3 times lower. The differences in the Adriatic could be due to different locations of the sampling stations and to a temporal decrease. However, the most important point is the differences in concentrations between the WMS and the other sub-regions. The BC concentrations in the WMS were much higher for all three trace metals. Therefore, it is recommended to use the sub-regional BCs for *M. galloprovincialis*. Since new data were not available in the AEL to update BC/BAC values for *M. galloprovincialis*, it is recommended to use the values calculated in 2019. Comparison of BC concentrations calculated in 2021 for Cd and Pb in *M. barbatus* from the AEL to the BCs in Decision IG23/6 showed that they are

³⁴ *C. chione* in the WMS, *ML* and *R.ruditapes* in the CEN, *M.corralina* in the AEL. See section 4.

³⁵ *S. pilchardus*, *B. boops*, *T. trachurus*, *S. sphyraena*, *D. annularis*, *P. acarne*, *P. erythrinus*, *M. barbatus*, *M. surmuletus*, *S. notata*, *S. scrofa*, *C. conger*, *D. sargus*, *L. mormyrus*, *S. rivulatus*, *S. rubrum*. See Section 3.

low and similar. Calculated Hg concentrations calculated in 2021 were lower than the concentration in Decision IG23/6

41. The mussel *M. galloprovincialis* and the fish *M. barbatus* are agreed as IMAP mandatory species. However, they may not be always found in all the areas of the Mediterranean Sea. Therefore, the addition of other (mandatory area specific) species to the monitoring program is recommended for further consideration. The species should be chosen based on their presence in the sub-regions, and relevance as pollution indicators, what will allow a better environmental assessment. Data from different species are presented in Table 12. It should be noted that the concentrations measured are specific to each species and comparison should be made within the same species (see Section 2). It may be useful to consider in the future an upgrade of IMAP in order to include larger number of species. BC concentrations of organochlorinated contaminants (PCBs and pesticides) in sediments and biota were not calculated either in 2011, 2016 or in 2019. The availability of new data is not sufficient to calculate BC values for these contaminants (see section 3).

42. For determination of BC values for CI17, the following key findings can be provided:

- For some parameters there is a marked difference among the Mediterranean sub-regions. Therefore, it is proposed in those cases (i.e. Pb in sediments, Cd and Pb in *M. galloprovincialis*, sum of PAHs in sediments), to consider using the sub-regional Mediterranean Sea assessment criteria.
- A statistical treatment of BDL data should be agreed upon. It is recognized that the different BDLs make it hard to use half of the BDL concentration for these values. However, it is not reasonable not to take BDL values into consideration.
- An in-depth examination of more data points, that need to be reported by CPs, should be performed in particular when large differences were observed between the BC values calculated in 2016 and in 2021. This is true for TM in sediment and biota in all sub-regions. The examination should include, among others, characterization of the stations used (hot spot, reference, other), analytical methodology, normalization, temporal trends.
- For the other parameters, such as PAHs in biota, and organochlorinated contaminants in sediment and biota, new additional data are needed to recalculate the BCs. Before new data availability will allow their recalculation, present values remain valid for preparing assessment inputs for the 2023 QSR.

4.2 An upgraded approach for updating EAC values for IMAP CI 17

43. As explained above (see Section 2), the EAC values endorsed for use in the Mediterranean Sea were NOAAs ERLs (for TM, PAH and pesticides in sediments) and the ECs from EU Directives to protect human health (for TM and organic contaminants in biota). They may be too lenient if the goal is to achieve and maintain GES where the contaminants cause no significant impact on coastal and marine ecosystems. However, EAC values cannot be updated based on existing monitoring data. It needs a very specific in-depth research of the ecotoxicological and environmental scientific literature.

44. Therefore, the methodology detailed in European Commission Guidance Document (2018) and in Long et al. (1995) is recommended for the update of Mediterranean EAC values. It includes a thorough examination of the scientific literature conducted to study where data on no effect or adverse biological effects are given in conjunction with chemical data in the environment and in the biota at the same site and time. Those include but are not limited to sediment toxicity tests, aquatic toxicity tests in conjunction with equilibrium partitioning (EqP) and field and mesocosm studies. The data should be assembled into a detailed database and analyzed, as well as the extent of the effect determined. The emphasis should be given to Mediterranean biota species.

45. Upgrade of the EAC values for Mediterranean Sea as recommended above is a long-term task that needs a dedicated, very specific, scientific research.

4.3 Proposal of new EAC values for IMAP CI 20

46. Proposal of the EAC values for IMAP CI 20 related to actual levels of contaminants that have been detected and number of contaminants which have exceeded maximum regulatory levels in commonly consumed sea food is based on a survey of existing sources, including Directives of EU related to the maximum permitted levels for contaminants in fish and seafood for the protection of human health. Table 13 details the concentrations cited at different sources for TM (Cd, Hg and Pb) and for organic contaminants (PCBs, dioxin).

47. From Table 13 it is possible to see that the criteria are taxa specific (fish, mussel, crustacean), as well as species specific. For example, maximum allowable Hg concentration in fish muscle is 0.5 mg/kg ww, excluding listed species such as bonito, marlin, halibut, mullet species, among others, in which the maximum allowable Hg concentration in the muscle is 1.0 mg/kg ww (see EC/EU Directive 1881/2006).

48. In addition, Decision IG.23/6 details the indicative regional EAC values for PAHs in mussels (*Mytilus galloprovincialis*) and for organic contaminants in mussel (*Mytilus galloprovincialis*) and fish (*Mullus barbatus*) that are considered biota matrix of IMAP Common Indicator 17. These values are given in Tables 4 and 5. As these values were set up to protect human health, they may be too lenient to protect the environment (see paragraph 22). However, since the values are based on the maximum levels for certain contaminants in foodstuffs as provided in EC/EU Directives 1881/2006, 1259/2011 and amendments 488/2014 and 1005/2015, they are proposed to be also used for IMAP CI 20.

Table 13. Compilation of maximum levels for trace metals in fish and seafood for the protection of human health³⁶. The concentrations are presented in mg/kg ww.

Source	matrix	Cd	Hg	Pb
		mg/kg ww		
NOAA (see countries below)	fish	0.2	0.5-1	1.5-2
	canned fish (*tuna)		1*	2.5, 5*
	mollusc	2	0.5	2.5
	finfish	0.1		0.5
EU 1881/2006 directive and 488/2014 and 1005/2015 amendments	fish muscle	0.05-0.25	0.5-1	0.3
	cephalopods	1		0.3
	crustaceans	0.5	0.5	0.5
	bivalve mollusc	1		1.5
CODEX Alimentarius (2019)	mollusc, cephalopod	0.05-2		
	fish			0.3
	fish- species dependent		1.2-1.7*	
#MedEAC IG.23/6	Mussel	1	0.5	1.5
	fish	0.05	1	0.3
OSPAR 2017	All species - biota	1	0.5	1.5
Minimum		0.05	0.5	0.01
Maximum		2	1.7	2.5

* methyl-mercury, # Concentrations recalculated in mg/kg wet wt

49. The maximum levels of organic contaminants in fish and seafood for the protection of human health are as follows: NOAA, 0.5 and 2 PCB (mg/kg ww) in fish and other seafood, respectively; EU Directive 1881/2006, 2-5 and 6 (mg/kg ww) of benzo(a)pyrene and 12-30 and 35 (mg/kg ww) for the

³⁶ The following sources are used in Table 13 and paragraph 52:

NOAA (National Oceanic and Atmospheric Administration) tabulation of the export requirements by country for fish and seafood (among others) (<https://www.fisheries.noaa.gov/export-requirements-country-and-jurisdiction-f>). Requirements by Australia, Brazil, Chile, China and Ecuador for trace metals;

EU directives for maximum levels for certain contaminants in foodstuffs (EC/EU 1881/2006, 1259/2011 Directives and amendments 488/2014 and 1005/2015);

CODEX Alimentarius international food standards, guidelines and codes of practice. Joint FAO/WHO Food Standards Programme.

sum of benzo(a)- pyrene, benz(a)anthracene, benzo(b)fluoranthene and chrysene in smoked fish muscle and on smoked bivalve mollusc, respectively; EU Directive 1259/2011 – 3.5 pg/g ww for the sum of dioxins in fish muscle and liver and in eel muscle; 6.5, 10 and 20 pg/g ww for the sum of dioxins and dioxin like PCBs in fish muscle, in eel muscle and in fish liver, respectively; and 75, 300 and 200 ng/g of the sum of PCB28, PCB52, PCB101, PCB138, PCB153 and PCB180 in fish muscle, in eel muscle and in fish liver, respectively. As for TM, the maximum allowable concentrations are taxa specific.

50. The values as established by above EU Directives are submitted for consideration to present meeting in order to guide the Secretariat and the Parties on their application as EAC values for IMAP CI 20. These values are in the low and mid-range of criteria used around the world and has the advantage to be consistent with regulations of EU. Their consistent application across the region is necessary. It should also be highlighted that these values were agreed at EU level also considering the ecosystem characteristics of Mediterranean Sea.

4.4 The way forward

51. As indicated in this document the work on the assessment criteria is a long way that requires very good quality of data and long time series. There is good progress in the last ten years in developing the assessment criteria, whereby better progress for BC/BAC has been achieved than for EAC. There is room to further reflect on how to upgrade work for calculation of Mediterranean EAC values for IMAP CIs 17 and 18, including by creating a database of scientific literature, as a long-term task, with support of the Online Working Group (OWG) for Contaminants (EO9), in order to complement real-time monitoring data to be reported from the Contracting Parties into IMAP Pilot Info System.

52. Scientific and expert contribution of the OWG for Contaminants is necessary to ensure analysis of the proposed updated sub-regional and regional BC and BAC values, against the new data that are expected to be provided by the members of the OWG or all the Contracting Parties in the IMAP Info System.

53. The criteria presently used for IMAP assessments are single parameter criteria. Each parameter is analysed separately to decide if the concentration is above or below the threshold. In view of the preparation of the assessment inputs for 2023 MED QSR, it is recommended to aggregate thresholds, that would better describe the environmental status and be a step towards determination of the overall environmental status. To that effect the NEAT and CHASE+ approaches should be considered, taking also into account their additional merit to achieve consistency with the EU MSs (see UNEP/MED WG.492/Inf. 11).

References

- Ahmed, I., Mostefa, B., Bernard, A. and Olivier, R. (2018) Levels and ecological risk assessment of heavy metals in surface sediments of fishing grounds along Algerian coast. *Marine Pollution Bulletin* 136, 322-333.
- Anon (2019) Contaminants in Europe's Seas. Moving towards a clean, non-toxic marine environment. EEA Report No 25/2018.
- Azizi, G., M. Layachi, M. Akodad, D. R. Yáñez-Ruiz, A. I. Martín-García, M. Baghour, A. Mesfioui, A. Skalli, and A. Moumen. (2018). Seasonal variations of heavy metals content in mussels (*Mytilus galloprovincialis*) from Cala Iris offshore (Northern Morocco). *Marine Pollution Bulletin* 137, 688-694.
- Benali, I., Boutiba, Z., Grandjean, D., de Alencastro, L.F., Rouane-Hacene, O. and Chèvre, N. (2017) Spatial distribution and biological effects of trace metals (Cu, Zn, Pb, Cd) and organic micropollutants (PCBs, PAHs) in mussels *Mytilus galloprovincialis* along the Algerian west coast. *Marine Pollution Bulletin* 115(1), 539-550.
- Bonsignore, M., Tamburrino, S., Oliveri, E., Marchetti, A., Durante, C., Berni, A., Quinci, E. and Sprovieri, M. (2015) Tracing mercury pathways in Augusta Bay (southern Italy) by total concentration and isotope determination. *Environmental Pollution* 205, 178-185.
- Briant, N., Chouvelon, T., Martinez, L., Brach-Papa, C., Chiffolleau, J.F., Savoye, N., Sonke, J. and Knoery, J. (2017) Spatial and temporal distribution of mercury and methylmercury in bivalves from the French coastline. *Marine Pollution Bulletin* 114(2), 1096-1102.
- El Baz, S.M. and Khalil, M.M. (2018) Assessment of trace metals contamination in the coastal sediments of the Egyptian Mediterranean coast. *Journal of African Earth Sciences* 143, 195-200.
- European Commission, E. (2018) Guidance Document No: 27. Technical Guidance For Deriving Environmental Quality Standards.
- Ghosn, M., Mahfouz, C., Chekri, R., Khalaf, G., Guérin, T., Jitaru, P. and Amara, R. (2020a) Seasonal and Spatial Variability of Trace Elements in Livers and Muscles of Three Fish Species from the Eastern Mediterranean. *Environmental Science and Pollution Research* 27(11), 12428-12438.
- Ghosn, M., Mahfouz, C., Chekri, R., Ouddane, B., Khalaf, G., Guérin, T., Amara, R. and Jitaru, P. (2020b) Assessment of trace element contamination and bioaccumulation in algae (*Ulva lactuca*), bivalves (*Spondylus spinosus*) and shrimps (*Marsupenaeus japonicus*) from the Lebanese coast. *Regional Studies in Marine Science* 39, 101478.
- Jebara, A., Lo Turco, V., Potorti, A.G., Bartolomeo, G., Ben Mansour, H. and Di Bella, G. (2021) Organic pollutants in marine samples from Tunisian coast: Occurrence and associated human health risks. *Environmental Pollution* 271, 116266.
- Karageorgis, A.P., Botsou, F., Kaberi, H. and Iliakis, S. (2020) Geochemistry of major and trace elements in surface sediments of the Saronikos Gulf (Greece): Assessment of contamination between 1999 and 2018. *Science of the Total Environment* 717, 137046.
- Long, E., Macdonald, D., Smith, S. and Calder, F. (1995) Incidence of adverse biological effects within ranges of chemical concentrations in marine and estuarine sediments. *Environmental Management* 19(1), 81-97.
- Martínez-Guijarro, R., Paches, M., Romero, I. and Aguado, D. (2019) Enrichment and contamination level of trace metals in the Mediterranean marine sediments of Spain. *Science of the Total Environment* 693, 133566.

- Naifar, I., Pereira, F., Zmemla, R., Bouaziz, M., Elleuch, B. and Garcia, D. (2018) Spatial distribution and contamination assessment of heavy metals in marine sediments of the southern coast of Sfax, Gabes Gulf, Tunisia. *Marine Pollution Bulletin* 131, 53-62.
- OSPAR 2017. <https://oap.ospar.org/en/ospar-assessments/intermediate-assessment-2017/pressures-human-activities/contaminants/>
- OSPAR (2008) Co-ordinated Environmental Monitoring Programme (CEMP) Assessment Manual for contaminants in sediment and biota. OSPAR Commission No. 379/2008.
- Pavlidou, A., Simboura, N., Pagou, K., Assimakopoulou, G., Gerakaris, V., Hatzianestis, I., Panayotidis, P., Pantazi, M., Papadopoulou, N., Reizopoulou, S., Smith, C., Triantaphyllou, M., Uyarra, M.C., Varkitzi, I.,
- Rabaoui, L., Balti, R., Zrelli, R. and Tlig-Zouari, S. (2014) Assessment of heavy metals pollution in the gulf of Gabes (Tunisia) using four mollusk species. *Mediterranean Marine Science*, 15(1), pp.. 15(1), 45-58.
- Tornero, V., Hanke, G. and Contaminants, M.E.N.o. (2019) Marine chemical contaminants – support to the harmonization of MSFD D8 methodological standards: Matrices and threshold values/reference levels for relevant substances. EUR 29570 EN, Publications Office of the European Union.
- UNEP/MAP (2011). UNEP(DEPI)/MED WG365/Inf.8. Development of assessment criteria for hazardous substances in the Mediterranean.
- UNEP/MAP (2016). UNEP(DEPI)/MED WG.427/Inf.3. Background to the Assessment Criteria for Hazardous Substances and Biological Markers in the Mediterranean Sea Basin and its Regional Scales.
- UNEP/MAP (2019). (UNEP/MED WG.463/Inf.6.). Updated Thematic Assessments of the Eutrophication and Contaminants Status in the Mediterranean Marine Environment, as a Contribution to the 2019 State of Environment and Development Report (SoED).

Appendix 8

Assessment Criteria Methodology for IMAP Common Indicator 13: Pilot Application in Adriatic Sub-region

Introduction

Eutrophication is a process driven by enrichment of water by nutrients, especially compounds of nitrogen and/or phosphorus, leading to: increased growth, primary production and biomass of algae; changes in the balance of nutrients causing changes to the balance of organisms; and water quality degradation (IMAP, 2017³⁷). Seawaters depending on nutrients loading and phytoplankton growth are classified according to their level of eutrophication. Low nutrient/phytoplankton levels characterize oligotrophic areas, whilst water enriched in nutrients is characterized as mesotrophic and water rich in nutrients and algal biomass is characterized as eutrophic.

Good environmental status (GES) with regard to eutrophication is achieved when the biological community remains well-balanced and retains all necessary functions in the absence of undesirable disturbance associated with eutrophication (e.g. excessive algal blooms, low dissolved oxygen, declines in sea-grasses, kills of benthic organisms and/or fish) and/or where there are no nutrient-related impacts on sustainable use of ecosystem goods and services. Specifically, for IMAP Common Indicator 13 related to key nutrients in water column GES is achieved when concentrations of nutrients in the euphotic layer are in line with prevailing physiographic, geographic and climate conditions.

Coastal waters (CWs) are among the most highly impacted ecosystems in the world presenting inherently high variability over both spatial and temporal scales (Reyjol et al., 2014³⁸). In those environments, the greatest impacts of increasing nutrient concentrations have been observed at sites with restricted water exchange, resulting in phytoplankton and macroalgal blooms (Tett et al., 2003³⁹; Teichberg et al., 2010⁴⁰).

A significant amount of research has been done in developing and intercalibrating biological indicators to assess impact of eutrophication in coastal waters (Borja et al., 2013⁴¹). Phytoplankton is the most suitable for assessing eutrophication due to direct response to nutrient conditions (Devlin et al., 2007⁴²). However, less attention has been directed to linking ecological status to management actions and establishing meaningful and consistent nutrient criteria to support achievement of GES (Hering et al., 2015⁴³).

The European experience is relevant in the field. A comparison of nutrient boundaries set for the Water Framework Directive (WFD) and the Marine Strategy Framework Directive (MSFD) in transitional, coastal and marine waters across EU Member States (Dworak et al., 2016⁴⁴) revealed a huge variability in nutrient concentrations boundaries, but also in other relevant aspects such as the nutrient parameters and metrics used, the time of year assessed, the reference conditions established. It also revealed that often MSs' boundary values of nutrient concentrations do not follow relevant Regional Seas Conventions (RSCs) nutrient standards.

³⁷ IMAP (2017). Integrated Monitoring and Assessment Programme of the Mediterranean Sea and Coast and Related Assessment Criteria UNEP, Athens, 52 pp.

³⁸ Reyjol, Y., Argillier, C., Bonne, W., Borja, A., Buijse, A. D., Cardoso, A. C., et al. (2014). Assessing the ecological status in the context of the European water framework directive: where do we go now?. *Sci. Total Environ.* 497, 332–344.

³⁹ Tett, P., Gilpin, L., Svendsen, H., Erlandsson, C. P., Larsson, U., Kratzer, S., et al. (2003). Eutrophication and some European waters of restricted exchange. *Cont. Shelf Res.* 23, 1635–1671.

⁴⁰ Teichberg, M., Fox, S. E., Olsen, Y. S., Valiela, I., Martinetto, P., and Iribarne, O. (2010). Eutrophication and macroalgal blooms in temperate and tropical coastal waters: nutrient enrichment experiments with *Ulva* spp. *Global Change Biol.* 16, 2624–2637.

⁴¹ Borja, A., Elliott, M., Henriksen, P., and Marb, N. (2013). Transitional and coastal waters ecological status assessment: advances and challenges resulting from implementing the European water framework directive. *Hydrobiologia* 704, 213–229.

⁴² Devlin, M., Best, M., Coates, D., Bresnan, E., O'Boyle, S., Park, R., et al. (2007). Establishing boundary classes for the classification of UK marine waters using phytoplankton communities. *Mar. Pollut. Bull.* 55, 91–103.

⁴³ Hering, D., Borja, A., Carstensen, J., Carvalho, L., Elliott, M., and Feld, C. K. (2010). The European water framework directive at the age of 10: a critical review of the achievements with recommendations for the future. *Sci. Total Environ.* 408, 4007–4019.

⁴⁴ Dworak, T., Berglund, M., Haider, S., Leujak, W. and Claussen, U. (2016). A comparison of European nutrient boundaries for transitional, coastal and marine waters. Working Group on ecological Status ECOSTAT.

The possible implications of the wide variations in the nutrient concentration boundaries need to be understood in the context of establishing appropriate nutrient boundaries to achieve GES. A Best Practice Guide (BPG, Phillips et al., 2018⁴⁵) has been elaborated in this context. Its purpose is to help in achieving GES in surface waters. It complements previous guidance on eutrophication assessment (EC, 2009⁴⁶) by providing more targeted advice on how to link nutrient concentrations in surface waters to specific policy objectives. The new guide includes a tool kit to facilitate the application of the different statistical approaches proposed to establish the nutrients' targets.

The statistical approaches proposed in the BPG in coastal and transitional waters focus on the pressure-response relationships found between the nutrients and phytoplankton. Most of the EU MSs use the concentration of Chlorophyll *a* (Chl *a*) as a proxy measure for phytoplankton biomass within intercalibration, whereas most of the indicators of other sub-elements (phytoplankton composition and blooms) have not yet been intercalibrated (Garmendia et al., 2013⁴⁷). This corresponds to monitoring of IMAP Common Indicator 13 (i.e. concentration of key nutrients in water column) and Common Indicator 14 (i.e. concentration of Chl *a*) that does not define the criteria/sub-indicators related to the harmful algal bloom; photic limit (transparency) of the water column; relative abundance or depth distribution of macrophyte communities; as well as the species composition and relative abundance of macrofaunal communities, as mandatory parameters within IMAP implementation.

Nitrogen or phosphorus limitation

All sub-indicators/parameters related to IMAP CIs 13 and 14 are monitored or have been defined for regular monitoring within implementation of recently prepared national IMAP Pollution Cluster monitoring programmes. The temporal scales are well harmonized among Parties. Only two Parties have already defined the scales according to the type of waters and the rest will do so during the 1st implementation phase.

However, in the Mediterranean region there are many differences in the nutrients' parameters assessed, the assessment period (summer, year-round, i.e. annual), and in the statistic used (mean, median or 90th percentile) within assessment of the conditions of saline waters. These differences can be also observed within the four marine ecoregions defined by the MSFD and even between transitional, coastal and marine waters at national levels (Dworak et al., 2016).

In general nitrogen, rather than phosphorus, is considered to be the most likely limiting nutrient in many temperate coastal waters (Tsirtsis, 1995⁴⁸). However, for the Mediterranean area it is the opposite and can be summarised as presented here-below.

In the Mediterranean phosphorus is often the limiting nutrient (Lazzari et al., 2016⁴⁹; Thingstad et al., 2005⁵⁰), although it is closely followed by nitrogen in this limiting role (Estrada, 1996⁵¹). The dissolved nitrogen to phosphorus ratio in the Mediterranean has been reported at about 21 to 23 in the

⁴⁵ Phillips G, Kelly M, Teixeira H, Salas F, Free G, Leujak W, Pitt Ja, Lyche Solheim A, Varbiro G, Poikane S, (2018) Best practice for establishing nutrient concentrations to support good ecological status, EUR 29329 EN, Publications Office of the European Union, Luxembourg

⁴⁶ European Commission [EC] (2009). Guidance Document on Eutrophication Assessment in the Context of European Water Policies. Common Implementation Strategy Guidance Document No. 23. Luxembourg: Office for Official Publications of the European Union.

⁴⁷ Garmendia, M., Borja, Á, Franco, J., and Revilla, M. (2013). Phytoplankton composition indicators for the assessment of eutrophication in marine waters: present state and challenges within the European directives. *Mar. Pollut. Bull.* 66, 7–16.

⁴⁸ Tsirtis, G.E. (1995). A simulation model for the description of a eutrophic system with emphasis on the microbial processes. *Water Science and Technology* 32: 189 -196.

⁴⁹ Lazzari, P., Solidoro, C., Salon, S. and Bolon, G. (2016). Spatial variability of phosphate and nitrate in the Mediterranean Sea: a modeling approach. *Deep Sea Research Part 1: Oceanographic Research Papers* 108: 39-52.

⁵⁰ Thingstad, T.F., Krom, M.D., Mantoura, R.F.C., Flaten, G.A.F., Groom, S., Herut, B., Kress, N., Law, C.S., Pasternak, A., Pitta, P., Psarra, S., Rassoulzadegan, F., Tanaka, T., Tselepidis, A., Wassmann, P., Woodward, E. M. S., Wexels Riser, C., Zodiatis, G. and Zohary T. (2005). Nature of phosphorus limitation in the ultraoligotrophic Eastern Mediterranean. *Science (New York)* 309: 1 068-1 071.

⁵¹ Estrada, M. (1996). Primary production in the Northwestern Mediterranean. *Sci. Mar.* 60, 55–64.

western part (Bethoux et al., 1992⁵²), and even higher in the eastern basin (Krom et al., 1991⁵³), which is quite different from the ratio of 16 found in the global ocean (Tyrrell, 1999⁵⁴).

This has been proved by the model-based reconstruction of inorganic phosphate and nitrate distributions presented by Lazzari et al. (2016). The model demonstrated that when nutrient limitation occurs, in the vast majority of cases, phosphorus is the limiting nutrient, with the notable exception of the Alboran Sea, which is mainly nitrogen limited, and the southwest basin, in which both nitrogen and phosphorus can limit plankton growth. Ramirez et al. (2005⁵⁵) showed nitrogen-limitation in the upper layers (first 20 m) of the north-west Alboran Sea during the winter, summer and autumn while Dafner et al. (2003⁵⁶) suggested phosphorus limitation in the Strait of Gibraltar area. However, phosphorus limitation in the upper layers of this area is not due to very low phosphorus concentrations but rather to a very high Nitrogen:Phosphorus (N:P) ratio in the area east of Gibraltar, caused by the upwelling of deep Mediterranean waters. The Adriatic Sea is mostly phosphorus-limited (Rinaldi, 2014⁵⁷). Along the coast of the northern and central Adriatic Sea, 90 % of the overall chlorophyll *a* variability is explained by Total Phosphorous (TP) (Giovanardi et al., 2018⁵⁸). The high N:P ratios in the Adriatic Sea (>50) demonstrate that nitrogen does not limit algal growth. The Po River has a major effect on the whole Adriatic basin, determining patterns of both spatial and temporal variation.

Total or inorganic dissolved fraction, assessment period and statistics

During phytoplankton blooms, dissolved inorganic nutrients in surface layers may be almost completely consumed, leading to nutrient limitation at periods of peak of biological activity. This results in large seasonal variability of nutrients' concentrations. For this reason, Dissolved Inorganic Nitrogen (DIN) and Dissolved Inorganic Phosphorus (DIP) are usually measured and assessed when biological activity is lowest.

Total Nitrogen (TN) and Total Phosphorus (TP), which include all forms of nitrogen and phosphorus compounds, are also important parameters that should be assessed in addition to the dissolved nutrients, as it is already common practice for example by HELCOM and in Swedish, Finnish and Estonian coastal waters (HELCOM, 2009⁵⁹). Adding total nutrients alongside inorganic nutrients, as core indicators, strengthens the link from nutrient concentrations in the sea to nutrient enrichment. These parameters may also allow consideration of climate change in the eutrophication assessment since higher temperatures will lead to year-round phytoplankton proliferation and/or possible changes in zooplankton communities.

In addition, there are other considerations that are not directly linked to setting of nutrients' thresholds but that are nevertheless important. Total nutrients are essential for determining nutrient budgets (i.e. an estimation of how much nutrient enters and leaves an area). Such budgets have particular

⁵² Bethoux, J.P., Morin, P., Madec, C. and Gentili, B. (1992). Phosphorus and nitrogen behaviour in the Mediterranean Sea. *Deep-Sea Res* 39: 1 641-1 654.

⁵³ Krom, M. D., Kress, N., and Benner, S. (1991). Phosphorus limitation of primary productivity in the eastern Mediterranean Sea. *Limnol. Oceanogr.* 36, 424–432.

⁵⁴ Tyrrell, T. (1999). The relative influences of nitrogen and phosphorus on oceanic primary production. *Nature (London)* 400: 525-531.

⁵⁵ Ramirez, T., Cortés, D., Mercado, J.M., Vargas-Yáñez, M., Sebastián, M., Liger, E. (2005). Seasonal dynamics of inorganic nutrients and phytoplankton biomass in the NW Alboran Sea Estuar. *Coast. Shelf Sci.*, 65 (4), pp. 654-670.

⁵⁶ Dafner, E.V., Boscolo, R. and Bryden, H.L. (2003). The N:Si:P molar ratio in the Strait of Gibraltar. *Geophysical Research Letters* 30: 1 506-1 509.

⁵⁷ Rinaldi, A. (2014). Fioriture algali In Adriatico. Il bacino padano-adriatico tra sviluppo e scienza (Algal blooms in the Adriatic. The Padano-Adriatic basin between development and science) Editrice La Mandragora.

⁵⁸ Giovanardi, F., Francé, J., Mozetič, P., Precali, R. (2018). Development of ecological classification criteria for the Biological Quality Element phytoplankton for Adriatic and Tyrrhenian coastal waters by means of chlorophyll *a* (2000/60/EC WFD). *Ecological Indicators*. 93. 316-332.

⁵⁹ Helcom (2009). Eutrophication in the Baltic Sea — An integrated thematic assessment of the effects of nutrient enrichment and eutrophication in the Baltic Sea region. *Baltic Sea Environment Proceedings* No 115B.

importance in coastal and marine waters that are influenced by transboundary nutrients` transport and receive nutrients` inputs from other countries.

Furthermore, total nutrients are also essential parameters for establishing nutrient reduction targets. This means that monitoring and assessing both total and dissolved nutrients forms is necessary for good understanding of the trend in nutrients` concentrations in the marine environment. However, within present monitoring of eutrophication, both within implementation of IMAP and MSFD, the measurement of all total (TN, TP) and dissolved (ammonia, nitrite, nitrate, orthophosphate, orthosilicate) forms are requested, in order to allow the calculation of all aggregated form as DIN and DIP.

To enable a consistent management approach, it is important to ensure a consistency between transitional, coastal and marine waters, at least within a region or subregion, in relation to monitoring and assessment of nutrients` parameters.

A final consideration is the choice of statistical measures used to aggregate nutrients` samples from a chosen assessment period in order to determine the concentrations of monitored parameter/indicator. Most of the Regional Seas Conventions use mean concentrations to ensure cross-comparisons. However, there might be cases where using the median is more robust, since it is less influenced by outliers. The choice of the appropriate statistics depends very much upon sampling size and quality of monitoring.

Since statistical distributions of chlorophyll *a* and nutrients tend towards log-normality, the parameter that better estimates the value around which central clustering occurs, is represented by the geometric mean, i.e. the arithmetic mean of log-data reconverted into numbers. The normalization of the data distributions by means of log transformation stabilizes the variance, with a standard deviation (sd) practically constant in the case of decimal log-transformation (Giovanardi and Tromellini, 1992⁶⁰). These statistical properties indicate that the use of the annual geometric mean of data as the metric for setting the assessment criteria in Mediterranean is appropriate statistical measure.

Further to above considerations and given limited data availability as presented here-below, present document paves the way for calculation of the reference conditions and boundary values for Dissolved Inorganic Nitrogen (DIN) and Total Phosphorous (TP).

Data availability

The elaboration of data availability for calculation of the assessment criteria for DIN and TP includes the following 3 sources:

- 1) New data from IMAP Pilot Info System that include national monitoring data reported during its testing phase, and in particular after launching formal call for data reporting in June 2020;
- 2) All monitoring data from MEDPOL Database (i.e. data reported before 2012 that were uploaded into MEDPOL Database along with data reported to MEDPOL outside MEDPOL Database in the format of old metadata templates in period 2013-2019) that are in the process of their migration into IMAP Pilot Info System;
- 3) The EU data center (European Marine Observation and Data Network - EMODnet).

IMAP Pilot Info System and MEDPOL Database

A summary of both data reported both to IMAP Pilot Info System and MEDPOL Database are presented in Table 1.

⁶⁰ Giovanardi, F., Tromellini, E., 1992. An empirical dispersion model for total phosphorus in a coastal area: the Po River-Adriatic system. *Sci. Total Environ. Supplement* 201–210.

Table 1: Datasets from IMAP Pilot Info System and MEDPOL Database available for calculation of the assessment criteria for DIN and TP. The datasets used in the 2017 and 2019 assessments are given for comparison.

Country	Data reported to MEDPOL Database	Data reported to IMAP Pilot Info system*	
		Validated	Not validated
Albania	2005-2006	-	
Algeria	2012	-	
Bosnia and Hercegovina	2006-2008	2013-2020	
Croatia	2009, 2011-2014	-	
Cyprus	1999-2015	-	2016-2019
Egypt	2009-2010; 2012;2015	-	
France	2009-2012;2013; 2016		
Greece	1999-2000, 2004-2006	-	
Israel	2001-2013; 2015	2018-2019	
Italy	-	-	
Libya	-	-	
Malta	-	-	
Monaco	-	-	
Montenegro	2008-2012; 2014-2015; 2016-2017	-	2018-2019
Morocco	2006-2008; 2013-2015	-	
Syria	2007	-	
Slovenia	1999-2013, 2015-2016	2017-2019	
Spain	-	2019	
Tunisia	2002-2014	-	
Turkey	2005-2009, 2011, 2013-2015	-	

*Both validated and not validated data have been used for assessing sources for calculation of the assessment criteria for DIN and TP, given temporary not validated status may be assigned to data due to certain technical issues in IMAP Info System

It can be concluded that data available for calculation of the assessment criteria (i.e. reference conditions (RCs) and boundary values) for both DIN and TP are insufficient. Namely, for calculation of the RCs and boundary values as a minimum the following datasets need to be provided: three continuous years of monitoring with a minimum monthly frequency for Water types I and II and bimonthly to seasonal for Type III. It should also be noted that other supporting parameters (i.e. temperature, salinity and dissolved oxygen) need to be available for defining the water typology,

Data available in the EU data center (European Marine Observation and Data Network - EMODnet)

Given scarcity of data reported into IMAP Pilot Info System and MEDPOL Database, data availability in EMODnet has also been explored (Table 2). However, it must be noted that EMODnet data are limited only to Croatia, France, Greece, Israel, Italy, Montenegro, Spain, Tunisia and Turkey. There is also different format of EMODnet data compared to data reported into IMAP Pilot Info System. Therefore, a significant further work is needed to correlate and aggregate two data sources.

Table 2: Datasets for Chlorophyll *a* and nutrients available at EMODnet, for period 2015-2020.

Country	Total available data	Unrestricted
Croatia	429	-
France	2344	493
Greece	229	-
Israel	29	29

Italy	2156	1247
Montenegro	146	-
Spain	244	-
Tunisia	29	-
Turkey	726	180

In line with above elaborated data availability, the following Mediterranean sub-regions/sub-areas may be indicated for calculation of the reference conditions and boundary values for DIN and TP: Adriatic, North Western Mediterranean Sea, Tyrrhenian Sea, Aegean Sea and Levantine Sea. They are proposed also considering the areas that were initially proposed for calculation of the assessment criteria for contaminants⁶¹. This can be considered the initial phase for establishing reference conditions and boundary values for nutrients, whereas the values can be proposed for entire Mediterranean upon data reporting from CPs that will fill present data gaps.

Online Working Group for EO5 needs to substantively contribute to increased data availability and statistical calculation of data in above indicated areas.

The calculation of the assessment criteria for DIN and TP in Adriatic Sub-region

The scientific experience related to eutrophication in Adriatic Sea is huge and relay on the problems derived from the eutrophic pressure connected with the Po River watershed where live around 16 000 000 inhabitants. Near the scientific experience also a huge data set exists that enabled development of TRIX (Vollenweider et al., 1998⁶²), an index for the assessment of the eutrophication, and a regional approach for development of classification criteria based on Chlorophyll *a* within IMAP (Giovanardi et al, 2018).

This ensures further development of a harmonized approach to the definition of reference conditions and boundary values for DIN and TP based on the relationship between pressure and responses. To that effect the necessary steps are presented here below, whilst detail elaboration of this approach is provided in UNEP/MED WG.492/Inf.12 submitted for information of present Meeting.

Water typology

The Water typology is very important for further development of classification schemes of a certain area. The major coastal water types and related criteria in the Mediterranean were defined following on their inter calibration, that was applicable for phytoplankton only, as provided in Decision IG.22/7 on IMAP (COP 19, 2016⁶³).

The water typology, a parameter having a robust numerical basis, can describe the dynamic behaviour of a coastal system. The assessment criteria are built per Water types that are mainly focused on hydrological parameters and characterization of water bodies' dynamics and circulation/ They are based on the introduction of density, the static stability parameter (derived from temperature and salinity values in the water column) for characterising of water bodies.

The first step in setting reference conditions and boundary values for an area i.e. Adriatic Sea sub-region is to identify present Water types and to attribute the data related to the density or salinity boundaries (Table 3).

⁶¹ The Mediterranean sub-regions and subareas are initially proposed according to availability of database sources for calculation of the assessment criteria for contaminants (UNEP(DEPI)/MED WG.427/Inf.3; UNEP/MED WG.463/8; UNEP/MED WG.467/7).

⁶² Vollenweider, R.A., F. Giovanardi, G. Montanari, A. Rinaldi, (1998). Characterization of the Trophic Conditions of Marine Coastal Waters. *Environmetrics*, 9, 329-357.

⁶³ COP 19. (2016). Decision IG.22/7 - Integrated Monitoring and Assessment Programme (IMAP) of the Mediterranean Sea and Coast and Related Assessment Criteria. COP19, Athens, Greece. United Nations Environment Programme, Mediterranean Action Plan, Athens.

Table 3. Major coastal water types relevant for Adriatic Sea with density and salinity boundaries

	Type I	Type IIA, IIA Adriatic	Type IIIW
σ_t (density)	<25	25<d<27	>27
S (salinity)	<34.5	34.5<S<37.5	>37.5

Reference condition

Reference Conditions (RCs) represent “a description of the biological quality elements that exist, or would exist, at high status”. That is, with no, or very minor disturbance from human activities. The objective of setting reference conditions’ standards is to enable the assessment of ecological quality against these standards (WFD CIS Guidance Document No. 5 (2003⁶⁴)).

An acceptable approach is to use a comprehensive pressure indicator that is able to address the potential transport of nutrients (natural loads plus anthropogenic loads) from the mainland to the sea, and that also measure, albeit roughly, this transport verifying the eventual absence of pressures of some importance exerted by human activities. For this purpose, use of dilution factor is considered as it was the case when the RCs for the Adriatic and Tyrrhenian Sea were developed (Giovanardi *et al.*, 2018).

The dilution factor is formulated as follows: $F_{dil} = [(S-s)/S] * 100$, where S = open sea salinity, s = measured salinity at a given coastal sampling point (Giovanardi and Vollenweider, 2004⁶⁵).

The role of the F_{dil} factor in assigning the chlorophyll *a* RCs is depicted in Figure 1.

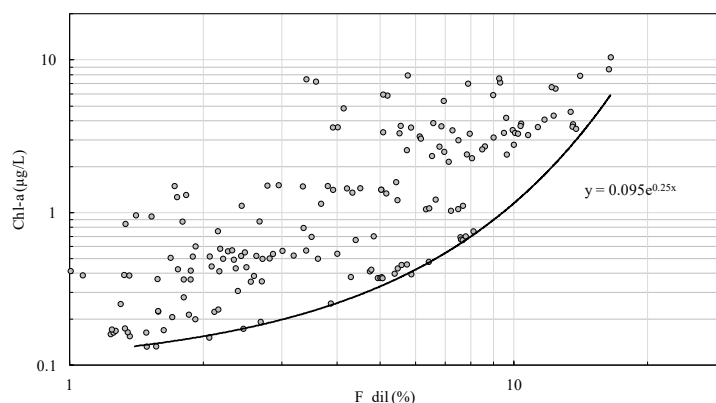

Figure 1. Scatter plot of annual *G_means* of chlorophyll *a* (Chl-a) against the dilution factor (F_{dil}) for Types I and II A. The curve marks the boundary of the lower limit of chlorophyll *a* reference conditions values (RCs). Original Figure from Giovanardi *et al.*, 2018.

This separation line can be interpreted as the threshold between natural and anthropogenic pressures. It is assumed that the nutrient loads, either natural or generated by minor human activities, determine a response of the coastal systems that is well-represented by concentrations of chlorophyll *a* lying on the curve (Figure 1). Thus, the assessment of RCs does not derive from theoretical considerations or expert judgments but refers to real situations occurring along the Adriatic coast.

The same approach cannot be used for the nutrients, given the dilution factor represents an integrated measure of the nutrient’s pressures to the ecosystem. However, defining the reference conditions for chlorophyll *a* for different water types, precedes to setting of the reference conditions for nutrients,

⁶⁴ WFD CIS Guidance Document No. 5 (2003) Transitional and Coastal Waters Typology, Reference Conditions and Classification Systems.

⁶⁵ Giovanardi, F., Vollenweider, R.A., (2004). Trophic conditions of marine coastal waters: experience in applying the Trophic Index TRIx to two areas of the Adriatic and Tyrrhenian seas. *J. Limnology* 63, 199–218.

whilst the nutrients RCs will be derived from the pressure to effects relationship as presented here-below.

In order to define more accurately chlorophyll *a* RCs for each water type, the data corresponding to individual Adriatic types were considered separately. Then it was possible to plot the curves separately for all types (Figure 2), which represent the RCs for each type.

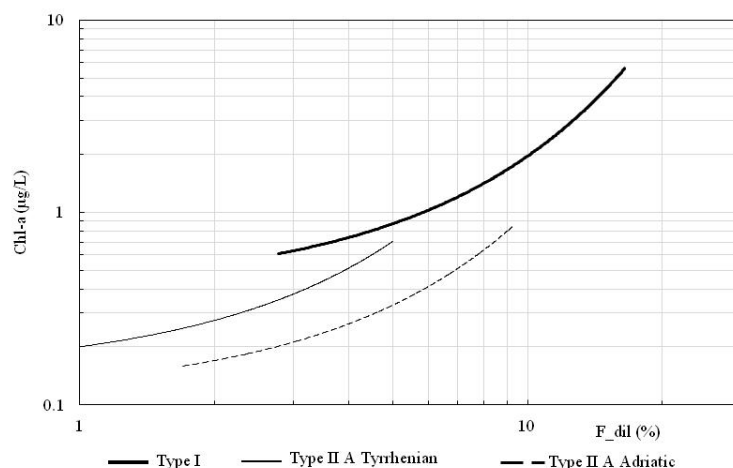

Figure 2. Reference conditions for chlorophyll *a* (Chl *a*) corresponding to different water types, depending on the gradient of the dilution factor (F_{dil}). Original Figure from Giovanardi *et al.*, 2018.

The best functional relationships between chlorophyll *a* RC and F_{dil} were always exponential. The equations describing these relationships have been used to derive a unique chlorophyll *a* RCs per water types corresponding to the mean value of F_{dil} . Table 4 summarizes the results.

Table 4. Summary table for BQE phytoplankton reference conditions (RC) based on chlorophyll *a*.

Type	Functional relationships	F_{dil} (%) <i>Mean value</i>	RC - Chl- <i>a</i> (µg/L) as <i>G Mean</i>
Type I	$y = 0.388 e^{0.162x}$	7.9	1.40
Type II A Adriatic	$y = 0.109 e^{0.221x}$	4.96	0.33

Pressure to effect relationship

Defining pressure to effect relationship is critical for nutrients RCs setting. Furthermore, a complete understanding of the functional relationship which links pressures to ecological effects result at the end with the programmes and measure as the final goal of the assessment process. To define the pressure to effect relationship, there is a need to apply relevant statistical analyses.

First the sensitivity of the selected metrics to different pressure indicators, with multiple regression analysis with linear models (LMs), was performed. By means of this stepwise regression technique, the variations of chlorophyll *a* concentration were tested against the pressure indicators available in dataset for Adriatic Sea (i.e. nutrient concentrations, oxygen saturation, dilution factor and Secchi depth). Annual geometric means of the parameters were used for this analysis.

The statistical analyses were performed using statistical packages offered by the program R and the exact statistical procedure is explained in UNEP/MED WG.492/Inf.12⁶⁶ submitted for information of present meeting.

Data processing involved the use of techniques of regression analysis provided by the package *stats*. For Type I among all the possible combinations, the stepwise regression technique provided the following linear model:

$$lm(\text{formula} = \text{Chl-a} \sim F_dil + aD_O + TP + DIN, \text{data} = \text{Type_I})$$

The fitted linear model explains 89% of the total chlorophyll *a* variability and the maximum weight in determining this variability accounts to TP.

For Type II A coastal water the linear model provided by the stepwise regression technique was:

$$lm(\text{formula} = \text{Chl-a} \sim F_dil + TP, \text{data} = \text{Type_II A})$$

The linear model is quite simple. Only two regressors were chosen with a largely dominant weight of TP over the weight of *F_dil* and the amount of chlorophyll *a* variability explained by this model is 78%. As TP accounts for the maximum weight in determining the variability of chlorophyll *a*, for both Type I and Type II A Adriatic, this parameter can be considered as the most eligible indicator of the pressure gradient. In this case the phosphorus pool in the water column (TP) can be considered as an internal measure of external phosphorus enrichment.

The above calculated relationships showed that chlorophyll *a* sensitivity, considered as the response of coastal systems to the availability of nutrients in terms of phytoplankton biomass production, is largely controlled by total phosphorus, which can therefore assume the role of the main pressure indicator.

The important regression equations used subsequently for the construction of the ecological classification criteria are summarized in Table 5.

Table 5. List of functional relationships of interest per water types. For each regression equation, the sample size N and the R-squared values are provided.

Functional link	Type I	Type II A Adriatic
1. TP vs TRIX	$[TP] = \exp [(TRIX - 6.064)/1.349]$ N = 15	$[TP] = \exp [(TRIX - 6.148)/1.583]$ N = 52
2. Chl-a vs TP	$[Chl-a] = 10.591 [TP]^{1.237}$ N = 15; $R^2 = 0.835$; $P = 4.45 \cdot 10^{-6}$	$[Chl-a] = 3.978 [TP]^{1.347}$ N = 52; $R^2 = 0.896$; $P = 2.2 \cdot 10^{-16}$

The nature of these relationships is almost always *log-log* type, which provides the highest degree of correlation. The equations in row 1 were obtained from the inverse relationship between the TRIX index and its component TP. For Type I and II A Adriatic these equations were prepared separately per water type, using the same data as those used to assess the functional relationships between TP and chlorophyll *a*. Finally, equations in row 2 exploit the relationship between TP and chlorophyll *a*, with the aim of fixing the limits among the ecological quality classes of the classification criterion, both for RCs and boundaries values.

The DIN was not elaborated further as the stepwise regression (i.e. the linear models) showed that it is not explaining the variability of the chlorophyll *a* and precise boundaries for DIN cannot be set.

Boundaries setting

With the definition of nutrients' RCs for Type I and Type II A coastal waters and the unveiling of their pressure-impact relationships, all the necessary tools are provided for defining the classification

⁶⁶ UNEP/MED WG.492/Inf.12. Analysis of the Methodologies Available for Establishment of the Assessment Criteria for IMAP Common Indicator 13.

criteria for Biological Quality Element (BQE) phytoplankton in Adriatic coastal waters. Given the Trophic Index (TRIX, Vollenveider et al, 1998) was developed first for the northern Adriatic and its ecological use is well known, it was used as an internal scale in setting the boundaries.

The first step was to calculate the RCs for type I and Type II Adriatic from the functional relationship between Chl_a and TP (Table 5, row 2) and resulting in 0,19 µmol/L and 0,16 µmol/L, respectively.

The next in setting the boundaries was the definition of the most important boundary i.e. the Good/Moderate (G/M) boundary, which delimits the need for taking measures in case of good ecological status failure. Firstly, the boundary was set for TP, as it appeared to be the best pressure indicator for phytoplankton as explained above. The G/M boundary for TP was calculated using the equations in row 1 of Table 5, at the corresponding TRIX boundary between Good and Mediocre Trophic Status (TRIX = 5; Giovanardi et al, 2018), which matches the transition from mesotrophic to eutrophic conditions in the coastal ecosystem.

This boundary was used for Type II A Adriatic Sea giving the values of 0.48 µmol/L. For Type I, the value of TRIX for deriving the G/M boundary was increased to 5.25, in order to take into account the nutrient loads originating from natural sources carried by the Po River into the Adriatic Sea, presumably in not negligible amounts. In this way, the G/M boundary for TP was set at 0.55 µmol/L for Type I. In the same manner all boundaries' values for Types I and II A Adriatic were calculated (Tables 6 and 7).

The identified P/B boundaries refer to "virtual" conditions, since it was not possible to detect real situations related to ecological class "Bad" in any of the datasets analysed in this work. TP concentrations characterizing "Bad" ecological class have been extrapolated from the functional relationships extended to the area of the diagrams not actually covered by observations. It is impossible to predict how coastal systems would behave with such high concentrations of phosphorus, especially since annual averages need to be determined. Therefore, this class is considered as indicative, but not strictly necessary for proper ecological classification of the BQE phytoplankton based on TP concentration.

Table 6. Reference conditions and boundaries of ecological quality classes for BQE phytoplankton expressed by different parameters for Type I coastal waters.

Boundaries	TRIX	Chl-a annual <i>G Mean</i>	TP annual <i>G Mean</i>
		µg/L	µmol/L
Reference Conditions	-	1.40	0.19
H/G	4.25	2.0	0.26
G/M	5.25	5.0	0.55
M/P	6.25	12.6	1.15
P/B	7	25.0	2.00

Table 7. Reference conditions and boundaries of ecological quality classes for BQE phytoplankton expressed by different parameters for Type II A Adriatic coastal waters.

Boundaries	TRIX	Chl-a annual <i>G Mean</i>	TP annual <i>G Mean</i>
		µg/L	µmol/L
Reference Conditions	-	0.33	0,16
H/G	4	0.64	0.26
G/M	5	1.5	0.48
M/P	6	3.5	0.91
P/B	7	8.2	1.71

Type III W Adriatic

Following the same approach used for Type I and II A waters, overall *G* means of nutrients' concentrations were related to the dilution factor for Type III W. No correlation was found for DIN

($R^2=0.05$; $P=0.303$), while for the TP the relationship was even inverse to the one expected (Giovanardi et al, 2018). Additionally, overall values of G_{mean} of chlorophyll *a* range from around 0.1 to around 0.4 $\mu\text{g/L}$. Since the ecological classification scheme consists of 5 ecological quality classes, the discrimination limit between two contiguous chlorophyll *a* annual G_{mean} values would not be suitable for proper and safe classification (Giovanardi et al, 2018). For that reason, a single threshold value is therefore proposed for Type III W coastal waters that is the H/G value for Type IIA Adriatic of 0,26 $\mu\text{mol/L}$.

Other suggested methodologies for boundaries setting

The Best Practice Guide (BPG, Nutrient boundaries definition toolkit, JRC)

The document “*Best practice for establishing nutrient concentrations to support good ecological status*” is developed by the Joint Research Centre (JRC), the European Commission’s science and knowledge service (Phillips et al, 2018). The purpose of the document is to help EU MSs achieve good ecological status (GES) in surface waters. It complements the Common Implementation Strategy (CIS) Guidance document on eutrophication assessment in the context of European water policies (EC, 2009) by providing advice on how to link nutrient concentrations in surface waters to specific policy objectives. It can be used to check existing boundaries’ values or to develop new ones. The guidance is supported by a toolkit in the form of an Excel workbook and a series of scripts which can be run using R, an open-source language widely used for statistical analysis and graphical presentation (R Development Core Team, 2016⁶⁷). The toolkit provides the full R code, together with a series of examples which can be used to explore the methods.

This toolkit includes different statistical approaches to derive nutrients’ boundaries, as elaborated here-below.

Univariate linear regression: Assuming a linear relationship between the ecological quality ratio (EQR) and nutrients, three regression types are implemented: two ordinary least squares OLS linear regressions between EQR and log nutrients concentration, where each variable is alternatively treated like the independent variable (because none of our two variables in practice can be considered to be free of error); and a third, type II regression, the ranged major axis (RMA) regression. The predicted range of nutrients’ threshold values are then determined from the range of results obtained from these regressions’ parameters.

Logistic regression: This approach treats ecological status as a categorical variable where a logistic model is fitted between categorical data using a binary response, “biology moderate or worse” = 1 or “biology good or better” = 0 and log of nutrient. Nutrient concentrations are determined where the probability of being moderate or worse was 0.5. In the case that additional pressures, other than nutrients, are suspected, a nutrient concentration value was determined at a probability of 0.75 instead of 0.5.

Categorical methods: Nutrient concentrations associated with a particular ecological status class could also be expressed as a distribution from which an upper quantile might be chosen to indicate a nutrient concentration above which good status was very unlikely to be achieved, or a lower quantile below which good status was very likely to be achieved (average of upper and lower quartiles of adjacent classes), so long as nutrients are the main driver of status. The average of the median of adjacent classes and the upper 75th percentile distribution are two additional categorical approaches tested.

Minimisation of mismatch of classification: Estimates the nutrient threshold value that minimizes the mismatch between status (good or better and moderate or worse) for the ecological and the supporting element.

⁶⁷ R Development Core Team (2006). R: A language and environment for statistical computing. R Foundation for Statistical Computing, Vienna, Austria.

Linear quantile regression: Useful alternative when the nutrient-biology interactions are confounded by other stressors, or environmental factors, leading to wedge-shape, or inverted-wedge, type of distributions. In such cases, the quantile regression allows different rates of change in the response variable to be predicted along the upper (in the presence of stressors) or lower (in the presence of mitigating environmental factors) quantiles of the distribution of the data (Cade and Noon, 2003⁶⁸). Detailed information about the methods included in the toolkit is provided in the Guidance (Phillips et al., 2018).

Experience of Spain in establishment of nutrient boundary values for coastal waters of Catalonia

The FAN (Phosphate-Ammonium-Nitrite) and FLU (FLUviality) indices method assesses the physicochemical state of coastal waters and allows nutrient boundary values to support GES to be established. This method is based on a distinctly different process to establish these values than those described in this document. Rather than using nutrient and BQE data simultaneously, it assesses the physicochemical state of coastal waters and then it relates this to the BQE. Nutrients' boundary values are then established from this relationship. This approach considers several dissolved inorganic nutrients concentrations and their stoichiometry at the same time rather than focusing on a single nutrient, as is the case when applying the toolkit.

The FAN and FLU indices method was developed using the physicochemical database of the Catalan Coastal Water Monitoring Programme. The data are representative of the north-west Mediterranean and comprise 20,102 records from 268 sampling stations collected between 1994 and 2014. A factorial analysis performed with this database revealed that the main pressures impacting coastal waters are *continental influences* (CI), which are related to gradients of dissolved inorganic nutrients, and freshwater content (inverse of salinity). An assessment of the physicochemical state of coastal waters based on the CI yielded results nearly equivalent (correlation of 0.93) to those obtained with the Trophic Index (TRIX) of Vollenweider et al. (1998). A further rotation applied to the factorial analysis revealed that CI is divided into two distinct gradients: levels of dissolved inorganic ammonium, phosphate, and nitrite define a gradient of urban influences while levels of dissolved inorganic silicate, and nitrate as well as the freshwater content, represent a gradient of freshwater influences or fluviality. The former is considered to reflect urban influences and the latter natural continental pressures on coastal waters (although freshwater influences are partly related to nitrate enrichment from agricultural sources).

These gradients of urban and freshwater influences were the basis for development of the FAN and FLU indices. The FAN index is scaled into five categories of water quality (high, good, moderate, poor and bad) and the FLU index into five categories of fluviality (very low, low, medium, high, and very high). The combined results provide a final assessment of the CI reaching coastal waters (urban, fluvial, mixed, or none) and, therefore, an assessment of their physicochemical state. The indices can be applied using data from inshore (0-200 m from the shore) or offshore (> 200 m from the shore) waters or both. The procedure, equations, and boundaries to apply the FAN and FLU indices together with detailed information on the method are available in Flo (2017⁶⁹).

Elaboration of the assessment criteria i.e. reference conditions and boundary values for DIN and TP

Although setting of the assessment criteria for nutrients, transparency and oxygen was recognized as a minimum to address needs identified in 2017 Mediterranean Quality Status Report, data availability

⁶⁸ Cade, B.S. and Noon, B.R. (2003). A gentle introduction to quantile regression for ecologists. *Frontiers in Ecology and the Environment* 1: 412-420.

⁶⁹ Flo, E. (2017). Opening the black box of coastal inshore waters in the NW Mediterranean Sea: environmental quality tools and assessment. PhD. 372 pages.

indicates that setting of RCs and boundary values is possible for DIN and TP only, and even for them in several sub-areas, but not at regional Mediterranean level.

To that effect the following datasets need to be provided as a minimum requirement: three continuous year of monitoring with a minimum monthly frequency for Water Type I; bimonthly frequency for Water Type II although preferable monthly; and seasonal frequency for Water Type III.

Further to analysis of monitoring data availability, the most suitable methods for setting the assessment criteria are recognized for each sub-area (Table 8). As explained above, data availability survey also indicates that data with unrestricted use from EMODnet may be used to supplement data sets available in IMAP Pilot Info System/MEDPOL.

Table 8. The Mediterranean sub-regions/subareas⁷⁰, where setting of the assessment criteria for DIN and TP is found possible in line with availability of monitoring data, along with relevant methods for setting of the boundary values.

Sub-regions	Sub-division (e.g. subareas/seas)	Availability of data (IMAP database + EMODNet)	Boundary setting method considered
Western Mediterranean Sea (WMS)	Alboran Sea (ALBS)	CPs contribution needed; data availability is restricted only to the northern part (Spain)	FAN/FLU, BPG toolkit
	North Western Mediterranean Sea (NWMS)	Probably sufficient; CPs should further improve data availability	Methodology for Adriatic sub-region, BPG toolkit
	Tyrrhenian Sea (TYRS)		Methodology for Adriatic sub-region
	Western Mediterranean Islands and Archipelago (WMIA)	Insufficient data	-
Adriatic Sea (ADR)	North Adriatic (NADR) Middle Adriatic (MADR) South Adriatic (SADR)	Probably sufficient data available; Adriatic Sea needs to be considered as a whole; CPs should further improve data availability;	Methodology for Adriatic sub-region
Central Mediterranean (CEN)	Central Mediterranean (CEN) Ionian Sea (IONS)	Insufficient data	-
Aegean and Levantine Seas (AEL)	Aegean Sea (AEGS) Levantine (LEVS)	Probably sufficient data available for the northern part, only; CPs should improve data availability	BPG Toolkit, Methodology for Adriatic sub-region

The Online Working Group (OWG) on eutrophication needs to support present work through data collection, elaboration and application of the methods for setting boundary values including relevant statistical approaches.

The setting of RCs and boundary values for DIN and TP is the essential step in supporting application of present assessment criteria for chlorophyll *a*, as established by Decisions IG.22/7. The G/M threshold for DIN and TP is the most important boundary which delimits the need for taking measures

⁷⁰ (UNEP(DEPI)/MED WG.427/Inf.3)

in case of GES failure. The development of the boundary values for the full scale of the relationship between pressures and effects will also allow monitoring of mitigation measures.

Within the scope of present IMAP implementation, development of the assessment criteria for transparency and dissolved oxygen is premature mainly due to the fact that elements of the measurements presently unrelated to primary production (Fleming-Lehtinen, 2016⁷¹) cannot be clearly identified. That is particularly true for shallow and coastal areas that are the most of our interest.

This proposal for setting the assessment criteria for DIN and TP within implementation of IMAP CI 13 corresponds well with the most recent findings related to EU WFD and MSFD implementation (Salas Herrero et al, 2020⁷²). These findings refer to comparison between the information reported by EU MSs to WISE on the standards for general physico-chemical quality elements, including nutrients and the information on methodologies used to assess eutrophication in coastal waters in accordance with MSFD, with the methodological standards agreed and used for the assessment of the elements for eutrophication criteria (i.e. nutrient conditions, transparency, and dissolved oxygen) at regional sea level.

⁷¹Fleming-Lehtinen, V. (2016). Secchi depth in the Baltic Sea – an indicator of eutrophication. University of Helsinki, Faculty of Biological and Environmental Sciences, Helsinki. 42 pages.

⁷² Salas Herrero, F., Araújo, R., Claussen, U., Leujak, W., Boughaba, J., Dellsaea, J., Somma, F., Poikane, S. (2020). Physico-chemical supporting elements in coastal waters: Links between Water and Marine Strategy Framework Directives and Regional Sea Conventions. EUR 30383 EN, Publications Office of the European Union, Luxembourg.

References

- Bethoux, J.P., Morin, P., Madec, C. and Gentili, B. (1992). Phosphorus and nitrogen behaviour in the Mediterranean Sea. *Deep-Sea Res* 39: 1 641-1 654.
- Borja, A., Elliott, M., Henriksen, P., and Marb, N. (2013). Transitional and coastal waters ecological status assessment: advances and challenges resulting from implementing the European water framework directive. *Hydrobiologia* 704, 213–229. doi: 10.1007/s10750-012-1276-9
- Cade, B.S. and Noon, B.R. (2003). A gentle introduction to quantile regression for ecologists. *Frontiers in Ecology and the Environment* 1: 412-420.
- Dafner, E.V., Boscolo, R. and Bryden, H.L. (2003). The N:Si:P molar ratio in the Strait of Gibraltar. *Geophysical Research Letters* 30: 1 506-1 509.
- COP 19. (2016). Decision IG.22/7 - Integrated Monitoring and Assessment Programme (IMAP) of the Mediterranean Sea and Coast and Related Assessment Criteria. COP19, Athens, Greece. United Nations Environment Programme, Mediterranean Action Plan, Athens.
- Devlin, M., Best, M., Coates, D., Bresnan, E., O'Boyle, S., Park, R., et al. (2007). Establishing boundary classes for the classification of UK marine waters using phytoplankton communities. *Mar. Pollut. Bull.* 55, 91–103. doi: 10.1016/j.marpolbul.2006.09.018
- Dworak, T., Berglund, M., Haider, S., Leujak, W. and Claussen, U. (2016). A comparison of European nutrient boundaries for transitional, coastal and marine waters. Working Group on ecological Status ECOSTAT.
- European Commission [EC] (2009). Guidance Document on Eutrophication Assessment in the Context of European Water Policies. Common Implementation Strategy Guidance Document No. 23. Luxembourg: Office for Official Publications of the European Union.
- Estrada, M. (1996). Primary production in the Northwestern Mediterranean. *Sci. Mar.* 60, 55–64.
- Fleming-Lehtinen, V. (2016). Secchi depth in the Baltic Sea – an indicator of eutrophication. University of Helsinki, Faculty of Biological and Environmental Sciences, Helsinki. 42 pages.
- Flo, E. (2017). Opening the black box of coastal inshore waters in the NW Mediterranean Sea: environmental quality tools and assessment. PhD. 372 pages. <https://www.tdx.cat/handle/10803/461378> (date accessed: 2.10.2018)
- Garmendia, M., Borja, Á, Franco, J., and Revilla, M. (2013). Phytoplankton composition indicators for the assessment of eutrophication in marine waters: present state and challenges within the European directives. *Mar. Pollut. Bull.* 66, 7–16. doi: 10.1016/j.marpolbul.2012.10.005
- Giovanardi, F., Francé, J., Mozetič, P., Precali, R. (2018). Development of ecological classification criteria for the Biological Quality Element phytoplankton for Adriatic and Tyrrhenian coastal waters by means of chlorophyll a (2000/60/EC WFD). *Ecological Indicators*. 93. 316-332. doi: 10.1016/j.ecolind.2018.05.015.
- Giovanardi, F., Tromellini, E., (1992). An empirical dispersion model for total phosphorus in a coastal area: the Po River-Adriatic system. *Sci. Total Environ. Supplement* 201–210. doi:10.1016/B978-0444-9990-3.50022-5.
- Giovanardi, F., Vollenweider, R.A., (2004). Trophic conditions of marine coastal waters: experience in applying the Trophic Index TRIX to two areas of the Adriatic and Tyrrhenian seas. *J. Limnology* 63, 199–218. doi: 10.4081/jlimnol.2004.199.
- Helcom (2009). Eutrophication in the Baltic Sea — An integrated thematic assessment of the effects of nutrient enrichment and eutrophication in the Baltic Sea region. *Baltic Sea Environment Proceedings* No 115B.
- Hering, D., Borja, A., Carstensen, J., Carvalho, L., Elliott, M., and Feld, C. K. (2010). The European water framework directive at the age of 10: a critical review of the achievements with recommendations for the future. *Sci. Total Environ.* 408, 4007–4019.

- IMAP (2017). Integrated Monitoring and Assessment Programme of the Mediterranean Sea and Coast and Related Assessment Criteria UNEP, Athens, 52 pp.
- Krom, M. D., Kress, N., and Benner, S. (1991). Phosphorus limitation of primary productivity in the eastern mediterranean sea. *Limnol. Oceanogr.* 36, 424–432. doi: 10.4319/lo.1991.36.3.0424
- Lazzari, P., Solidoro, C., Salon, S. and Bolon, G. (2016). Spatial variability of phosphate and nitrate in the Mediterranean Sea: a modeling approach. *Deep Sea Research Part 1: Oceanographic Research Papers* 108: 39-52. doi: 10.1016/j.dsr.2015.12.006
- Phillips G, Kelly M, Teixeira H, Salas F, Free G, Leujak W, Pitt Ja, Lyche Solheim A, Varbiro G, Poikane S, (2018) Best practice for establishing nutrient concentrations to support good ecological status, EUR 29329 EN, Publications Office of the European Union, Luxembourg, ISBN 978-92-79-92906-9, doi:10.2760/84425, JRC112667.
- R Development Core Team (2006). R: A language and environment for statistical computing. R Foundation for Statistical Computing, Vienna, Austria. ISBN 3-900051-07-0.
<http://www.R-project.org>
- Ramírez. T., Cortés, D., Mercado, J.M., Vargas-Yáñez, M., Sebastián, M. Liger, E. (2005), Seasonal dynamics of inorganic nutrients and phytoplankton biomass in the NW Alboran Sea Estuar. *Coast. Shelf Sci.*, 65 (4), pp. 654-670, 10.1016/j.ecss.2005.07.012
- Reyjol, Y., Argillier, C., Bonne, W., Borja, A., Buijse, A. D., Cardoso, A. C., et al. (2014). Assessing the ecological status in the context of the European water framework directive: where do we go now? *Sci. Total Environ.* 497, 332–344. doi: 10.1016/j.scitotenv.2014.07.119
- Rinaldi, A. (2014). Fiorituri algali In Adriatico. Il bacino padano-adriatico tra sviluppo e scienza (Algal blooms in the Adriatic. The Padano-Adriatic basin between development and science) Editrice La Mandragora.
- Salas Herrero, F., Araújo, R., Claussen, U., Leujak, W., Boughaba, J., Dellsaea, J., Somma, F., Poikane, S. (2020). Physico-chemical supporting elements in coastal waters: Links between Water and Marine Strategy Framework Directives and Regional Sea Conventions. EUR 30383 EN, Publications Office of the European Union, Luxembourg. ISBN 978-92-76-22418-1, doi:10.2760/444388, JRC121759.
- Tett, P., Gilpin, L., Svendsen, H., Erlandsson, C. P., Larsson, U., Kratzer, S., et al. (2003). Eutrophication and some European waters of restricted exchange. *Cont. Shelf Res.* 23, 1635–1671. doi: 10.1016/j.csr.2003.06.013
- Teichberg, M., Fox, S. E., Olsen, Y. S., Valiela, I., Martinetto, P., and Iribarne, O. (2010). Eutrophication and macroalgal blooms in temperate and tropical coastal waters: nutrient enrichment experiments with *Ulva* spp. *Global Change Biol.* 16, 2624–2637.
- Thingstad, T.F., Krom, M.D., Mantoura, R.F.C., Flaten, G.A.F., Groom, S., Herut, B., Kress, N., Law, C.S., Pasternak, A., Pitta, P., Psarra, S., Rassoulzadegan, F., Tanaka, T., Tselepides, A., Wassmann, P., Woodward, E. M. S., Wexels Riser, C., Zodiatis, G. and Zohary T. (2005). Nature of phosphorus limitation in the ultraoligotrophic Eastern Mediterranean. *Science (New York)* 309: 1 068-1 071.
- Tsirtis, G.E. (1995). A simulation model for the description of a eutrophic system with emphasis on the microbial processes. *Water Science and Technology* 32: 189 -196.
- Tyrrell, T. (1999). The relative influences of nitrogen and phosphorus on oceanic primary production. *Nature (London)* 400: 525-531.
- UNEP/MED WG.492/Inf.12. Analysis of the Methodologies Available for Establishment of the Assessment Criteria for IMAP Common Indicator 13.
- Vollenweider, R.A., F. Giovanardi, G. Montanari, A. Rinaldi, (1998). Characterization of the Trophic Conditions of Marine Coastal Waters. *Environmetrics*, 9, 329-357.COP
- WFD CIS Guidance Document No. 5 (2003) Transitional and Coastal Waters Typology, Reference Conditions and Classification Systems.

Appendix 9

Programme of Work for Biennium 2022-2023

Rationale for the Proposed Programme of Work 2022-2023

1. Decision IG.24/14 “Programme of Work and Budget 2020-2021”, adopted by the 21st Meeting of the Contracting Parties (COP21) in December 2019, in Naples, Italy, mandates the Secretariat to prepare, in consultation with the Bureau, for consideration and approval by COP22, a result-based Programme of Work (PoW) and Budget for 2022-2023, explaining the key principles and assumptions on which it is based and taking into account the progress achieved during the implementation of the 2020-2021 Programme of Work, and in full alignment with the MTS. The new MTS is built around 7 Programmes. MED POL will contribute to Programme 1, 5,6 and 7 as explained below.

Thematic Programme 1: Towards a Pollution and Litter Free Mediterranean Sea and Coast Embracing Circular Economy

2. More specifically, the proposed 2022-2023 PoW envisages:
 - a) Boosting the implementation of the Regional Plan on Marine Litter management through national, subregional and regional actions, with a particular focus on plastics;
 - b) Implementation of Regional Plans addressing priority pollutants and sectors, including through development of regional standards and guidance;
 - c) Developing new Regional Plans for the management of pollutants’ releases from Agriculture, Aquaculture and Storm Water;
 - d) Updating guidelines and strengthening national capacities for the implementation of the Dumping Protocol;
 - e) Undertaking pilot actions to prevent, eliminate and dispose in an environmentally sound manner obsolete chemicals;
 - f) Strengthening the capacity of individual coastal states to respond efficiently to marine pollution incidents; improving pollution event follow-up and enhancing the level of enforcement and the prosecution of discharge offenders;
 - g) Supporting public and private actors in preventing marine litter and toxic chemicals, addressing the circular economy approach;
 - h) Developing and implementing the One Health approach in the Mediterranean in relation to pollution links with human health;
 - i) Supporting the creation and development of circular economy businesses in key sectors of activity which are main sources of pollution;

Foundational Programme 5: Governance

3. With regards to MED POL contribution to this Programme the following activities are proposed:
 - a) Supporting national efforts for further progressing on the ratification of the Pollution related Protocols to the Barcelona Convention;
 - b) Reinforcing Contracting Parties’ capacities on enforcement of, compliance with, and reporting on legally binding provisions of the MAP Barcelona Convention framework; with a particular focus on Pollution related Protocols;
 - c) Contribute to the evaluation of the implementation of the Ecosystem Approach Roadmap and IMAP, and elaborating a new/updated Roadmap as appropriate;
 - d) Contribute to the strengthening SPI networks with a focus on IMAP;
 - e) Strengthening partnerships with MEA of relevance, Global and regional networks in the scope of the application of the Pollution related protocols of the Barcelona Convention as well as of Regional Plans adopted in the framework of Article 15 of the PBS Protocol;

- f) Expand and strengthen the Marine Litter Regional Platform in close collaboration with European Regional Seas and GPML of the UNEP/GPA
- g) Promoting gender mainstreaming into MED POL operations and activities.

Enabling Programme 6: Together towards a Shared Knowledge and Foresight of the Mediterranean Sea and Coast

4. With regards to MED POL contribution to this Programme the following activities are proposed:

- a) Delivering a data-based 2023 Mediterranean Quality Status Report in line with its implementation Roadmap adopted by COP 21 (Decision IG. 24/4); for EO 5,9 and 10 including GES integrated assessment aspects
- b) Further developing IMAP for the Pollution and Litter clusters (developing or upgrading monitoring and assessment criteria for IMAP common indicators (CIs), establishing scales of assessment, and defining integration and aggregation rules, Data Standards (DSs) and Data Dictionaries (DDs) etc.);
- c) Implementing IMAP at national and as appropriate sub-regional level; deliver quality assured data, organize proficiency exercises to enhance national capacities in delivering and reporting quality assured data;
- d) Completing and maintaining the IMAP Info System for all IMAP Common Indicators and ensuring full implementation of the InfoMAP Spatial Data Infrastructure (InfoMAPNode), including coordination with relevant Regional Organizations Infosystems and databases; for the Pollution and Litter Cluster

Enabling Programme 7: For Informed and Consistent Advocacy, Awareness, Education and Communication

5. With regards to MED POL contribution to this Programme the following activities are proposed:

- a) Producing and disseminating communication material, i.e. press releases, news items, articles, videos, brochures, web series, social media products etc. and organizing outreach events; based on the deliverables of MED POL work.

b) MTS Programme 1. Towards a pollution and litter free Mediterranean Sea and Coast embracing circular economy

Main activity (means of implementation)	Expected deliverable	Lead Component	Other Component(s)	Partners	SDG Targets	MTF/External Resources/Both
Outcome 1.1. Strategies and Action plan addressing marine litter and plastics developed and implemented through comprehensive, coherent and collaborative approaches						
<p>1.1.1. Undertake national, subregional, regional actions to boost the implementation of the Marine Litter Regional Plan in the Mediterranean</p> <p>(in-house expertise, consultancy, regional/ sub-regional meetings, regional platform, pilots and national capacity building)</p>	<p>a) Pilot actions implemented in at least 14 sites in 6 countries on fishing for litter, adopt a beach, waste management at ports measures through the application of common MAP Regional Adopted Guidelines.</p>	MED POL	SCP/RAC, REMPEC	EU funded Water and Environment Support (WES) Project, EU funded EPPA, GIZ,	12.4; 12.5; 14.1	MTF and EU funded ML MED II
	<p>b) Best practices shared at national, regional/subregional level, including with local authorities, on the effective implementation of Marine Litter Regional Plan, addressing improving separate waste collection/ transportation systems, combating marine and coastal pollution from open dumpsites, cost-benefit dimension of measures implementation and promoting zero waste initiative.</p>			UNEP GPA, OSPAR, Black Sea Commission, GPML		
	<p>c) Membership to the Regional Platform for Marine Litter in the Mediterranean expanded.</p>	CU, MED POL	MED POL	SCP/RAC, REMPEC, SPA/RAC	ML MED Regional Platform (over 20 regional and global actors), Plastic Partnership (Basel Convention), GIZ,	12.4; 12.5; 14.1
<p>d) Joint Work Plan of the members of the Regional Platform agreed annually and implemented; at least two joint activities implemented with Partners.</p>						

Main activity (means of implementation)	Expected deliverable	Lead Component	Other Component(s)	Partners	SDG Targets	MTF/External Resources/Both
<p>1.1.1. Undertake national, subregional, regional actions to boost the implementation of the Marine Litter Regional Plan in the Mediterranean</p> <p>(in-house expertise, consultancy, regional/ sub-regional meetings, regional platform, pilots and national capacity building)</p>				WES, EPPA		
	<p>e) Technical support provided to CPs, which so request, to implement the IMO Action Plan to address marine plastic litter from ships and the related provisions of the Regional Plan on Marine Litter Management in the Mediterranean, where appropriate.</p> <p>f) Relevant activities of the IMO-FAO-Norway GloLitter Partnerships Project facilitated in the Mediterranean, as appropriate.</p> <p>g) Synergies between the amended Regional Plan on Marine Litter Management in the Mediterranean and the IMO Action Plan/Strategy to address marine plastic litter from ships, as well as other relevant plans or initiatives, maintained and strengthened.</p>	REMPEC, CU	MED POL	IMO, FAO, GFCM, EBRD	12.4; 12.5; 14.1	External resources
<p>1.1.3. Implement and scale up a robust policy framework to reduce and prevent plastic use</p> <p>(in-house expertise, consultancy, cooperation agreements, regional meetings/webinars)</p>	<p>a) National cooperation agreements between public and private stakeholders to prevent plastic pollution and reduce plastic waste in 2 countries; guidance provided.</p>			TBD	12.1; 12.4; 12.5; 14.1	MTF
	<p>b) Legal and technical support provided to public authorities to strengthen policy framework to reduce plastic use, addressing in particular Single Use Plastic Products.</p>					DG ENV (Marine Litter Med II) + DG NEAR (WES) + MTF
	<p>c) Sharing existing solutions and good practices to prevent plastic use and pollution by applying eco-innovation, life cycle thinking (including eco-design).</p>	SCP/RAC	MED POL, CU		MTF	
	<p>d) 3 webinars on solutions to prevent plastic pollution.</p>					

Main activity (means of implementation)	Expected deliverable	Lead Component	Other Component(s)	Partners	SDG Targets	MTF/External Resources/Both
	e) 20 Food services located in coastal areas supported to implement measures to reduce food and beverage packaging ending-up as Marine Litter.					External resources expected from IMELS
1.1.4. Enhance stakeholders 'capacity, in particular public authorities, to prevent plastic and microplastic pollution (in house expertise, consultancy, national and regional trainings)	a) 1 regional training on microplastics organized. b) 3 national trainings on EPR/SUPs/solutions to prevent ML organized.	SCP/RAC	MEDPOL, PAP/RAC	TBD	12.4 ;12.5; 12.a; 14.1	DG NEAR (WES) + DG ENV (Marine Litter Med II) + MTF
	c) 1 training programme on ML prevention targeting coastal municipalities organized and good practices shared.					MTF
Outcome 1.2. A holistic and efficient response to land and sea-based pollution, [as a part of overall Ecosystem Approach for Mediterranean policy] (chemicals, contaminants, eutrophication, noise, oil and emerging pollution) for a sustainable Mediterranean coastal and marine ecosystem is implemented						
1.2.1. Develop new regulatory measures in line with article 15 of the LBS Protocol for priority sectors as provided for in the Decision IG.24/10 (in house expertise, consultancy, consultation, regional meetings)	a) Regional Plan on Agriculture and Aquaculture.	MED POL, CU	Plan Bleu, SCP/RAC	(WES) Project	6.3; 12.4; 14.1	MTF
	b) Regional Plan on Storm Water management.					
	c) State of Play Report on pre-treatment of industrial effluents standards for industries discharging into urban wastewater collection systems prepared.					

Main activity (means of implementation)	Expected deliverable	Lead Component	Other Component(s)	Partners	SDG Targets	MTF/External Resources/Both
1.2.2. Take national and regional actions including enabling investments, to implement Regional Plans on WasteWater and Sludge Management (in-house expertise, consultancy, national trainings/capacity building activities, regional meeting)	a) Preparatory studies on investment potential for wastewater treatment/collection network projects addressing NAP hotspots in three countries (Egypt and Lebanon) or completed (Tunisia).	CU, MED POL	SCP/RAC	GEF, European Investment Bank, UNEP, GPA	5.c; 6.5; 6.6; 6.a; 12.4; 13.1; 14.1	GEF
	b) Capacity building programs for national water and sanitation agencies/companies initiated (Egypt and Lebanon) or completed (Tunisia)					
	c) Action plans for gender mainstreaming in the wastewater sector initiated (Egypt, Lebanon and Tunisia).					
	d) Regional standards for urban wastewater treatment and sewage sludge management developed including wastewater reuse, and energy efficiency and monitoring protocol for microplastics in wastewater.	MED POL	GEF, European Investment Bank, UNEP, GPA	External (MedProgramme)		
e) Best practices shared.						
1.2.3. Promote sustainable Desalination Sector in the Mediterranean (in-house expertise, consultancy, publication, regional meeting)	a) State of play of Desalination in the Mediterranean made available through maps or publication. b) Recommendations elaborated in a decision support tool to assist sustainable investment decision-making & dissemination of the tool through participation in events.	Plan Bleu	MED POL	MedProgramme, AFD, UNIDO	6.3; 6.a; 12.4; 14.1	MTF, External funds

Main activity (means of implementation)	Expected deliverable	Lead Component	Other Component(s)	Partners	SDG Targets	MTF/External Resources/Both
	<p>c) Regional standards on desalination technologies.</p> <p>d) Best practices to minimize environmental impact of desalination compiled and shared.</p>	MED POL	Plan Bleu			
<p>1.2.4. Enhance the implementation of MED POL reporting tools developed to assess pollution loads from land based sources and activities</p> <p>(in-house expertise, consultancy, regional meeting)</p>	<p>a) PRTR/NBB Guidelines implemented and data reported including diffuse sources.</p> <p>b) Pollution trends assessed at national and sub-regional/regional levels.</p> <p>c) Best practices shared at regional level to exchange knowledge on reporting (PRTR, NBB , NAP/H2020 indicators).</p>	MED POL	CU	EEA, UNECE, OECD, EPPA	9.4; 12.4; 14.1	MTF
<p>1.2.5. Undertake national and regional action to enhance the implementation of the Dumping Protocol</p> <p>(in-house expertise, consultancy, regional meeting)</p>	<p>a) Best practices shared to support the implementation of Dumping Protocol Guidelines adopted by COP 21 (Artificial reefs).</p> <p>b) Guidelines on dumping of uncontaminated inert materials updated in synergy with the IMO London Protocol.</p>	MED POL	CU	LC/LP, IMO, IMPEL	12.4; 14.1	MTF
<p>1.2.6. Undertake pilot actions to prevent, eliminate and dispose in a environmentally sound</p>	<p>c) Training activities to engage the private sectors in using alternatives to toxic chemicals organized in 3 counties.</p>		MEDPOL			GEF (MedProgramme)

Main activity (means of implementation)	Expected deliverable	Lead Component	Other Component(s)	Partners	SDG Targets	MTF/External Resources/Both
<p>manner obsolete chemicals.</p> <p>(in-house expertise, consultancy, national trainings/capacity building activities, field visits, regional meeting)</p>	<p>d) 500 tons of PCBs in Algeria and Lebanon collected and disposed; PCBs inventory in Algeria, Morocco, Tunisia, Albania, Bosnia and Herzegovina, and Montenegro) updated.</p>	MED POL	CU, SCP/RAC	MedProgramme, Stockholm Convention, Minamata Convention, UNEP Chemicals		GEF (MedProgramme)
	<p>e) EMP for mercury stocks in Algeria, B&H, Morocco and Tunisia; 50 tons of Mercury in Algeria, B&H, Morocco and Tunisia collected and disposed.</p>					
	<p>f) Best practices for management of obsolete/in stock chemicals (focus on PCBs, POPs, mercury), including on compliance and enforcement shared.</p> <p>g) Capacity building provided to relevant national authorities with a focus on inspectorate bodies.</p>					
<p>1.2.7. Strengthen and implement national frameworks to regulate/ban the use of POPs/toxic chemicals</p> <p>(in-house expertise, consultancy)</p>	<p>a) Support provided to 3 countries to regulate/ban the use of POPs/toxic chemicals.</p> <p>b) Mechanisms developed to accompany companies in phasing out certain chemicals.</p>	SCP/RAC	MED POL	MedProgramme	12.1; 12.a; 14.1	GEF (MedProgramme)

Main activity (means of implementation)	Expected deliverable	Lead Component	Other Component(s)	Partners	SDG Targets	MTF/External Resources/Both
1.2.8. Increase access to information on chemicals in products (in-house expertise, consultancy, national trainings, public webinars, awareness raising)	a) Facility, hub, awareness campaigns to increase knowledge on chemicals in products in cooperation with companies and citizens associations.	SCP/RAC	MEDPOL	SwitchMED II, UNIDO, MehMED Network, University of Girona	12.8	BRS Secretariat (only for Master module)+ MTF
	b) Master module on toxic chemicals in plastics prepared and delivered in 3 countries.					MTF
	c) Interactive web platform to raise awareness on chemicals in plastic products prepared.					BRS Secretariat (only for 2 Webinars)+ MTF
	d) 3 public webinars on strategies to prevent chemicals in products organized.					
Outcome 1.3. Systemic approaches for Circular Economy as well as Sustainable Consumption and Production incorporated into key sectors of activity which are main sources of pollution						
1.3.1. Promote SCP/Circular economy approaches in key sectors of LBS Protocol (in-house expertise, consultancy)	a) Circular economy approach for biowaste implemented in one country.	SCP/RAC	MED POL	SwitcMed	12.1; 12.a	MTF Funding required
Outcome 1.4. One Health approach developed and implemented, linking human and ecosystems health with pollution reduction and prevention, taking into account lessons learnt from the COVID-19 pandemic						

Main activity (means of implementation)	Expected deliverable	Lead Component	Other Component(s)	Partners	SDG Targets	MTF/External Resources/Both
<p>1.4.1. Develop and implement a one-health approach for the Mediterranean, in partnership with WHO and FAO (2022/2023)</p> <p>(in-house expertise, consultancy, regional conference)</p>	<p>a) Comparative assessment of impact of environmental factors on health in the Mediterranean region conducted through literature review.</p> <p>b) A Med-wide conference on One-Health approach for the Mediterranean; Conference report published and disseminated.</p>	Plan Bleu	All MAP Components	WHO, FAO, UNEP, UNESCO, One Health High-Level Expert Council	3.9; 14.1; 14.2	MTF
<p>1.4.2. Implement the agreed Med SOx ECA Road Map (Decision IG.24/8), and explore the possible designation of the Mediterranean Sea, as a whole, as an Emission Control Area for nitrogen oxides</p> <p>(in-house expertise, consultancy, national workshops, regional meeting)</p>	<p>a) Technical support and capacity building provided to CPs, which so request, to ratify and effectively implement MARPOL Annex VI.</p>	REMPEC	CU, MED POL, PB/RAC	IMO	3.9; 12.4; 14.1	MTF
	<p>b) Joint and coordinated proposal for the designation of the proposed Med SOx ECA submitted to the IMO, and discussions at MEPC facilitated, as appropriate.</p> <p>c) Mediterranean Action Plan (MAP) nitrogen oxides (NOx) Emission Control Area (ECA)(s) Technical Committee of Experts established</p>			IMO		MTF
	<p>d) Terms of Reference for a specific Technical and Feasibility Study to assess the relevant existing studies and gather further knowledge on the possible designation of the Mediterranean Sea, as a whole, as an Emission Control Area for nitrogen oxides, developed and validated by the NOx ECA(s) Technical Committee of Experts.</p>	REMPEC		IMO, HELCOM, OSPAR, Bonn Agreement		MTF

d) MTS Foundational Programme 5: Governance

Main activity (means of implementation)	Expected deliverable	Lead Component	Other Component(s)	Partners	SDG Targets	MTF/External Resources/Both
Outcome 5.1. Effective Implementation and Enforcement by the Contracting Parties of the Barcelona Convention, its Protocols, MAP Policies, including Ecosystem Approach related COP decisions, the MSSD and Programmes of Measures achieved at regional and national levels						
5.1.1. Strengthen Contracting Parties action to comply with legally binding obligations under Barcelona Convention and its Protocols (in-house expertise, consultancy, technical national assistance, regional meeting)	d) Contracting Parties develop national policies, legislation and mechanisms for the implementation and enforcement of the BC Protocols. e) Technical assistance to CPs to develop national policies, regulatory frameworks and which are consistent with the BC and its Protocols is provided.	CU	MAP Components, (MEDPOL, PAP/RAC SPA RAC, REMPEC)	MEAs, UNEP	All SDG 14 Targets especially 14.2 and 14.c; 16.3; 17.14	Both
Outcome 5.2. Systemic strengthening and effective functioning and delivery of MAP decision-making and advisory bodies ensured, and efficiency enhanced with new digital approaches						
5.2.1. Deliver successfully COP 23 of MAP Barcelona Convention (in-house expertise, Host Country Agreement, conference services, venue, side events, travel arrangements)	a) COP 23 Declaration, Decisions including the PoW 2024-2025 reviewed and adopted, recommendations of the Compliance Committee and the MCSA reviewed. b) Progress achieved during the biennium 2022-2023 reviewed and acknowledged.	CU	MED POL, RACs	Host country, CPs, MAP Partners	All SDG 14 targets especially 14.c; 16.3; 17.14; to a lesser extent SDGs 6, 12, 13	Both

Main activity (means of implementation)	Expected deliverable	Lead Component	Other Component(s)	Partners	SDG Targets	MTF/External Resources/Both
	<p>c) Status of implementation of the Convention and its Protocols reviewed.</p> <p>d) MAP visibility and outreach enhanced.</p>					
<p>5.2.4. Organize Compliance Committee Meetings</p> <p>(in-house expertise, conference services, travel arrangements)</p>	<p>a) 2 Compliance Committee Meetings successfully convened; Non-compliance situations addressed and brought to the attention of COP 23.</p> <p>b) Interactions and possible joint sessions with Compliance Committees of other MEAs held.</p> <p>c) Compliance Procedures and Mechanisms further developed with additional elements to maximise their effective use and impacts.</p>	CU, Compliance Committee	MEDPOL, RACS	Compliance Committees under relevant MEA	All SDG 14 targets especially 14.c; 16.3; 17.14; to a lesser extent SDGs 6, 12, 13	MTF
<p>Outcome 5.3. Policy coherence and complementarity ensured among relevant work at global, regional and national levels and among MAP-Barcelona Convention system's policy and regulatory instruments</p>						
<p>5.3.3. Strengthen cooperation for joint reporting under the BC and its Protocols</p> <p>(in-house expertise, national trainings, twinning's)</p>	<p>a) Mechanisms for promoting mutual supportiveness with other relevant international instruments when it comes to reporting developed.</p> <p>b) Support for reporting provided at national level (e.g. e-reporting modules, twinning approach).</p>	CU	RACs, MEDPOL	MEAs	All SDG 14 targets especially 14.c; 16.3; 17.14; to a lesser extent SDGs 6, 12, 13	Both

Main activity (means of implementation)	Expected deliverable	Lead Component	Other Component(s)	Partners	SDG Targets	MTF/External Resources/Both
Outcome 5.4. Enhanced partnerships and multi-stakeholder engagement, including with the private sector and science policy interface						
5.4.1. Promote dialogue and enhanced engagement of global and regional organizations and partners (in-house expertise, partnerships, bilateral cooperation, private sector engagement)	a) Leading role of MAP further defined and strengthened in existing and new areas.	CU	RACs, MEDPOL	International and regional organizations, private sector/donors, UNEP, MEAs, CPs	17,17	Both
	b) New areas of cooperation identified and added to existing bilateral cooperation agendas: Focus GFCM, UfM, Biodiversity related organizations, Marine Litter.					
	c) Cooperation with new partner institutions, including from private sector, initiated.					
5.4.2. Strengthen participation and contribution of civil society and private sector to the work of MAP BC system (in-house expertise, support attendance in MAP meetings, round tables)	a) MAP Policy on Partnerships updated including an Engagement mechanism/strategy for Civil Society Organisations.	CU	RACs, MEDPOL	MAP Partners, NGOs, CPs	17,17	Both
	b) New MAP Partners added and existing MAP Partners renewed; Enhanced engagement of MAP Partners in policy development and implementation.					
	c) Annual round table discussions held (back-to-back with other meetings).					

Main activity (means of implementation)	Expected deliverable	Lead Component	Other Component(s)	Partners	SDG Targets	MTF/External Resources/Both
<p>5.4.3. Strengthen SPI networks and enhance partnership with scientific institutions to support MAP Barcelona Convention system</p> <p>(in-house expertise, consultancy, pilot action(s), national thematic events/workshops)</p>	<p>b) Partnership Agreement signed with scientific Institutions to support integrated assessment of GES.</p> <p>c) SPI platform set up to support IMAP implementation at national and regional levels.</p>	CU	All MAP Components, IMAP Task Force	Scientific institutions; UNESCO; IOC; CNR		
	<p>d) National thematic IMAP SPI networks/hubs established in two countries.</p>	Plan Bleu, CU	All MAP Components, IMAP Task Force			
	<p>e) Joint Work Plan 2022-2027 between EEA and UNEP/MAP implemented (main areas of cooperation: Building strengthened knowledge base; Responding to political priorities; Supporting digital transformation; Ensuring coordinated networking, communication and stakeholder interaction).</p>	CU	INFO/RAC, MED POL, Plan Bleu, PAP/RAC	EEA, EIONET, ETC, H2020, DG NEAR		Both
<p>Outcome 5.5. Coordinated approaches implemented to strengthen public institution capacities for the implementation of the Barcelona Convention and its Protocols</p>						
<p>5.5.1. Strengthening national governance frameworks for the BC and its Protocols</p> <p>(in-house expertise, partnerships)</p>	<p>a) Short courses designed and organized linked to the implementation and enforcement of the BC and its Protocols in universities and other academic institutions.</p>	CU	MEDPOL, RACs	MEAS, UNEP, Academic institutions, InforMea	All SDG 14 targets especially 14.c; 16.3; 17.14	Both

e) MTS Enabling Programme 6: Together towards a shared knowledge and foresight of the Mediterranean Sea and coast

Main activity (means of implementation)	Expected deliverable	Lead Component	Other Component(s)	Partners	SDG Targets	MTF/External Resources/Both
Outcome 6.1. Inclusive and participatory foresight activities conducted at regional and national and local levels, with associated capacity-building						
<p>6.1.2. Prepare the Transboundary diagnostic analysis for the Mediterranean Sea</p> <p>(in-house expertise, consultancy)</p>	<p>a) Methodology of the Transboundary diagnostic analysis elaborated; priority transboundary problems identified for the Mediterranean Sea; socio-economic characteristics assessed.</p>	CU, MEDPOL	CU, IMAP Task Force (including SPA/RAC, Plan Bleu, INFO/RAC)	National IMAP competent laboratories / authorities; relevant national and international scientific institutions; EU MSFD technical bodies;	14.a	GEF MED Programme: Child Project 1.1.
Outcome 6.2. Science-based IMAP, foresight and other assessments and assessment tools for strengthened science-policy interface and decision making						
<p>6.2.1. Strengthen the implementation of national IMAP-based monitoring programmes for all clusters and deliver quality assured data</p> <p>(in-house expertise, consultancy, IMAP TF, national assistance and trainings)</p>	<p>d) Technical and financial support provided to support pollution and litter cluster of IMAP to at least 7 countries to ensure delivery of quality assured data, as well as their reporting using the IMAP Info System.</p>	MEDPOL				

Main activity (means of implementation)	Expected deliverable	Lead Component	Other Component(s)	Partners	SDG Targets	MTF/External Resources/Both
<p>6.2.2. Upgrade the assessment component of IMAP including possible integrated assessment for all IMAP clusters: Focus Assessment criteria and thresholds (CI 1, 2, 6, 13, 14, 16, 17, 21, 22, 23)</p> <p>(in-house expertise, consultancy, IMAP TF, CORMONs)</p>	<p>g) Updated/new scales of monitoring and assessment proposed for mandatory Common Indicators as applicable (EO 5,9, 10).</p> <p>h) GIS atlas prepared for scales of monitoring and scales of assessment to be integrated into IMAP Info System.</p> <p>i) IMAP methodology on integrated assessments adjusted and further developed.</p> <p>j) Proposals to upgrade IMAP discussed by CORMONs Pollution and Litter and ECAP CG meeting.</p> <p>k) Further progress on assessment criteria and thresholds for IMAP Common Indicators 13, 14, 17, 18, 22 and 23, if possible also at sub-regional level, based on data availability.</p>	MED POL				
<p>6.2.4. Deliver 2023 MED Quality Status Report (QSR)(in house expertise, thematic assessments, consultations with partners, GIS maps, IMAP TF, CORMONs)</p>	<p>b) Thematic assessments for Ecological Objectives 5, 9 and 10 contributing to 2023 MED QSR whilst progressing towards integration among these 3 EOs and as appropriate with other Ecological Objectives 1, 7 and 8 of IMAP Biodiversity, Coast and Hydrography Cluster, as appropriate and feasible; CORMON Meeting held annually.</p>	MED POL, CORMON Pollution and Litter				

Main activity (means of implementation)	Expected deliverable	Lead Component	Other Component(s)	Partners	SDG Targets	MTF/External Resources/Both
	e) Elaboration and spatial data analysis of monitoring data aggregated by MAP components for the purposes of 2023 MED QSR.	INFO/RAC	CU, MAP Components	UNEP-GRID, UNIGE	All SDG 14 targets especially 14.a 12.8	MTF
Outcome 6.3. [IMAP implementation and] Environment and Development Observation provide updated and quality assured data in support of decision-making by Contracting Parties and assessment of GES.						
<p>6.3.1. Strengthen national capacities to apply harmonized and standardized monitoring and assessment practices related to pollution and marine litter in line with IMAP</p> <p>(in-house expertise, consultancy, field survey, national laboratories, training, IMAP TF)</p>	<p>a) National MED POL/ IMAP laboratories supported to apply good laboratory practices for monitoring of contaminants in biota and sediment, as well as for biomarkers if feasible, through organization of the proficiency tests (PT) and related Training Courses.</p> <p>b) Proposal prepared for inter-calibration proficiency testing and training courses for eutrophication (nutrients and chlorophyll-a) in seawater.</p>	MEDPOL	CU, IMAP Task Force	IAEA;National IMAP competent authorities; Scientific institutions; bodies EU MSFD	14.1; 14.a	Both
<p>6.3.4. Ensure effective operation of the NBB reporting system</p> <p>(in-house expertise, national technical assistance and trainings)</p>	d) Relationship with the PRTR and EU Registry component implemented, and assessment functions strengthened at regional, subregional, national and river basin scale.	MED POL		EEA		MTF

Main activity (means of implementation)	Expected deliverable	Lead Component	Other Component(s)	Partners	SDG Targets	MTF/External Resources/Both
6.3.6. Complete and maintain IMAP Info System with all IMAP Common Indicators fully implemented for the CPs to upload their monitoring data	b) Data Standards (DSs) and Data Dictionaries (DDs) developed for IMAP Common Indicators (all the remaining ones: part of them with the support of the EcAp MED III Project).	CU	MED POL, SPA/RAC, PAP/RAC			Both
	c) Quality control on data formats and data coherence upgraded and developed for IMAP Cis (all the remaining: part of them with the support of the EcAp MED III Project).		MED POL, SPA/RAC, PAP/RAC			Both
	d) Dedicated assistance and support trainings to CPs to organize, upload, validate and release monitoring data in 2022 and 2023. Creating and sharing tutorials on the IMAP site to help CPs in workflow processes.		MED POL, SPA/RAC, PAP/RAC			Both
6.3.12. Develop monitoring protocols and guidelines (in-house expertise, consultancy)	a) Monitoring Guidance/Protocols prepared for IMAP CI23 (seafloor macro-litter, beach macro-litter; as well as for floating macro-litter, beach micro-litter, and seafloor micro-litter), as well as for Candidate Indicator 24, as feasible due to availability of relevant scientific inputs.	MED POL			14.1	
	b) Guidelines for monitoring microplastics deriving from WWTP and riverine inputs of marine litter are prepared.	MED POL	SCP/RAC			ML MED II

Main activity (means of implementation)	Expected deliverable	Lead Component	Other Component(s)	Partners	SDG Targets	MTF/External Resources/Both
<p>6.3.13. Expand and improve the monitoring and forecasting capacities in the marine environment through integrating networks of observing and forecasting systems (oceanographic observatories) across the Mediterranean Sea (in-house expertise, consultancy, trainings and working meetings)</p>	<p>a) Priority needs and actions agreed to strengthen reliable and cost-effective monitoring and GES assessment related to IMAP Pollution Cluster, including use of best available knowledge and technologies within science-policy interface, thereby also contributing to the Implementation Plan of UN Decade on Ocean Science.</p>	<p>MEDPOL</p>	<p>CU, SPA/RAC, PAP/RAC, IMAP Task Force</p>	<p>Scientific institutions; UNESCO; IOC; CNR</p>	<p>14.1 ; 14.a</p>	
	<p>c) Possible application of modeling and forecasting techniques and tools explored, as available and appropriate.</p>	<p>MED POL</p>	<p>IMAP Task Force</p>		<p>14.2 ; 14.a</p>	<p>MTF</p>

g) MTS Enabling Programme 7: For informed and consistent advocacy, awareness, education and communication

Main activity (means of implementation)	Expected deliverable	Lead Component	Other Component(s)	Partners	SDG Targets	MTF/External Resources/Both
Outcome 7.2. Citizen and general public awareness and outreach raised through citizen science and digital campaigns						
<p>7.2.3. Enhance public awareness and outreach on key MAP topics</p> <p>(in-house expertise, external expertise, Communication TF, digital campaigns, web platforms, outreach events, publications, IT services)</p>	<p>a) Digital Campaign for enhancing knowledge of Pollution (i.e web page; interactive story; burning issues; story map; Infographics; Twitter cards; Video; articles and interviews; "focus in" section in MED News).</p>	INFO/RAC	MED POL CU and MAP Components		crosscutting especially SDG 14 Targets	MTF
	<p>b) Highlight progress on key pollution issues tackled by MED POL 4 News articles on progress in implementation, including on websites and in MAP Newsletter.</p>	MED POL				
	<p>i) Support efforts towards a pollution free Mediterranean [Sea and Coast] embracing circular economy. Digital publication highlighting Circular Economy approaches incorporated into key sectors that are main sources of pollution - Global partnerships to prevent pollution: Regional and National Plastics Pacts.</p>	SCP/RAC	CU and MAP Components			MTF
	<p>Engaging general public on circular economy products and services and sustainable lifestyle, positioning the "Switchers" with specific awareness activities: i) The Switchers Community Communication and Marketing Plan 2022-2023; ii) "We are the Switchers" dissemination campaign, iii) Digital campaign on "Sustainable Fashion"iv) campaign on SCP/circular practices among consumers on marine litter.</p>	SCP/RAC	CU and MAP Components			MTF

Main activity (means of implementation)	Expected deliverable	Lead Component	Other Component(s)	Partners	SDG Targets	MTF/External Resources/Both
7.2.4 Enhance public awareness and outreach for specific targets (MAP Partners, Civil Society and students)(in-house expertise, external expertise, Communication TF)	a) MAP Partners contribution to Digital Campaigns, dissemination and social media participation promoted.	INFO/RAC	MAP Components			MTF
	b) Web APP for Citizen Science developed and implemented specifically for different targets (citizens, scientists, students).	SCP/RAC	CU and MAP Components			MTF
7.2.5. Co-create and implement education and awareness programmes also in cooperation with academic institutions, focusing on marine and coastal issues, with the aim to promote education on sustainable development. (in-house expertise, external expertise, Communicatio TF, partnership Agreements)	c) Video Contest and Photo Contest on the key topics of the biennium.	SCP/RAC	CU and MAP Components			MTF
	a) Education and awareness programmes on biodiversity conservation co-created and implemented in collaboration with CSOs within at least 2 SPAMIs.	SPA/RAC	CU and other MAP component as relevant	CSOs, national & local authorities, private sector		Both (MTF+external funds to be identified : ENI CBC MED (ENSERES project), IMELS) 7.2.1. Both MTF + external funds to be identified : ENI CBC MED (ENSERES project), IMELS) MTF

Main activity (means of implementation)	Expected deliverable	Lead Component	Other Component(s)	Partners	SDG Targets	MTF/External Resources/Both
<p>7.2.5. Co-create and implement education and awareness programmes also in cooperation with academic institutions, focusing on marine and coastal issues, with the aim to promote education on sustainable development.</p> <p>(in-house expertise, external expertise, Communicatio TF, partnership Agreements)</p>	<p>b) At least 6 MoU signed with CSOs to develop education and awareness actions within SPAMIs.</p>	<p>SPA/RAC</p>	<p>CU and other MAP component as relevant</p>	<p>Relevant SPAMI managers, CSOs, national & local authorities, private sector</p>	<p>4.7; 14.2; 14.5</p>	<p>Both (MTF+external funds to be identified : ENI CBC MED (ENSERES project), IMELS) 7.2.1. Both MTF + external funds to be identified : ENI CBC MED (ENSERES project), IMELS) MTF</p>
	<p>c) Further establish/extend educational activities and promote educational programmes in cooperation with academic institutions, focusing on marine and coastal issues, with the aim to promote education on sustainable development. Partnership agreements with educational institutions established.</p>	<p>CU</p>	<p>CU and other MAP component as relevant</p>			

Appendix 10

Monitoring Guidelines/Protocols for sampling and sample preservation of seawater for the analysis of C13 and C14: concentration of key nutrients and chlorophyll *a*

Introduction

1. In the Monitoring Guidelines for sampling and sample preservation of seawater for the analysis of CI13 and C14: concentration of key nutrients and chlorophyll *a*, the protocols for sampling and sample preservation for salinity, nutrients and chlorophyll *a* are elaborated. Sampling and sample preservation are an important step within the monitoring process of the marine environment. Through proper sampling and sample preservation assessment of GES regarding Ecological Objective 5 related to eutrophication as presented in detail in the IMAP Guidance Factsheets (UNEP/MAP, 2019)⁷³ will be allowed and maintained.

The IMAP Protocols elaborated within this Monitoring Guidelines for sampling and sample preservation of seawater for the analysis of CI13 and C14 regarding concentration of key nutrients and chlorophyll *a* provides detail guidance on the necessary equipment, procedures and identify weak points all endorsed through important notes and possible problems. However, they are not intended to be analytical training manuals, but guidelines for Mediterranean laboratories.

This Monitoring Guidelines builds upon the UNEP/MAP Integrated Monitoring and Assessment Programme (IMAP) respectively IMAP Guidance Fact Sheets for IMAP Common Indicators 13 and 14 (UNEP/MAP, 2019); standardized protocols (UNEP/MAP, 2019a)⁷⁴ and Data Quality Assurance schemes (UNEP/MAP, 2019b)⁷⁵ in order to allow the comparability of the data and build of regional assessment schemes. They also take into account previous Sampling and Analysis Techniques for the Eutrophication Monitoring Strategy of MED POL (UNEP/MAP/MED POL, 2005)⁷⁶, however providing detail procedures that are of relevance for IMAP implementation. With the details of the protocols for sampling and sample preservation the needs of the measurements both in off-shore areas and in narrow coastal areas are addressed.

The below flow diagram informs on the category of this Monitoring Guidelines related to sampling and sample preservation for nutrients and chlorophyll *a* within the structure of all Monitoring guidelines prepared for IMAP Common Indicators 13, 14, 17, 18 and 20.

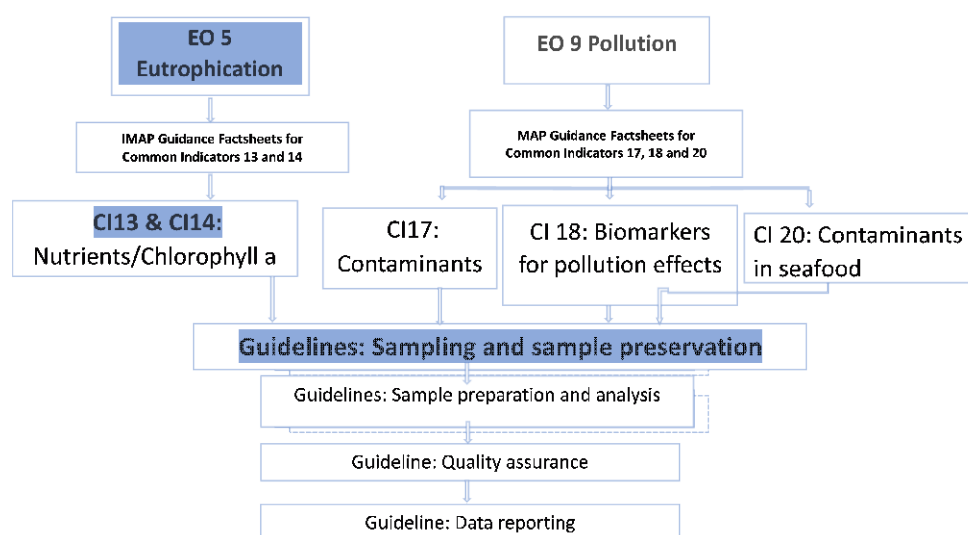

Flow Diagram: Monitoring Guidelines for IMAP Ecological Objective 5 and 9.

⁷³ (UNEP/MAP, 2019), UNEP/MED WG.467/5. IMAP Guidance Factsheets: Update for Common Indicators 13, 14, 17, 18, 20 and 21: New proposal for candidate indicators 26 and 27.

⁷⁴ (UNEP/MAP, 2019a), UNEP/MED WG.463/6. Monitoring Protocols for IMAP Common Indicators related to pollution.

⁷⁵ (UNEP/MAP, 2019b), UNEP/MED WG.467/10. Schemes for Quality Assurance and Control of Data related to Pollution

⁷⁶ (UNEP/MAP/MED POL), 2005. Sampling and Analysis Techniques for the Eutrophication Monitoring Strategy of MED POL. MAP Technical Reports Series No. 163. UNEP/MAP, Athens, 46 pp.

Technical note for the sampling of seawater for the determination of hydrographic parameter and the measurement of concentration of key nutrients and chlorophyll *a*

Sampling is an important step within the monitoring process of the marine environment. Although significant efforts have been made in designing procedures for analytical measurements, very little attention has been given to the sampling. Historically, analytical scientists have primarily been concerned with measurements made in the laboratory, and the process of sampling has been conducted by different people, who often even work in different organizations. The analytical scientist's knowledge of the sampling process is therefore sometimes very limited.

Sampling could be defined as a process of selecting a portion of material small enough in volume to be transported conveniently and handled in the laboratory, while still accurately representing the part of the environment sampled. The main difficulties in sampling are representativeness and integrity. Many people think that the analysis starts when the sample arrives in the laboratory. However, sampling is an integral part of the analytical process and sampling is its starting point. Sampling is so important that, in some cases, it represents the main contribution to the error of the whole analytical process.

Sampling should always start by defining the purpose of the measurement (Stoeppler, 1997⁷⁷). If the different stages are under the responsibility of different people, there needs to be good communication between all parties involved. Sampling planners and analytical scientists need to optimize the whole measurement procedure, including the sampling step. The sampling plan should be written as a protocol that includes the following aspects:

- when, where and how to collect samples;
- sampling equipment, including its maintenance and calibration;
- sample containers, including cleaning, addition of stabilizers and storage;
- sample-treatment procedures (e.g., handling prior to measurements);
- sub-sampling procedures; and
- sample record-keeping (e.g., labelling, recording information, auxiliary information, and chain-of-custody requirements).

Sampling frequency is therefore an important factor in terms of representativeness. Low sampling frequency could underestimate the occasional presence of samples with high analyte concentration. Sampling frequency is subject to a number of factors, e.g., transportation, access to the sampling site, the availability of test organisms, and financial constraints.

Under this Technical Note, this Monitoring Guidelines provides the following IMAP Protocols for the sampling of seawater for the determination of hydrographic parameter and the measurement of concentration of key nutrients and chlorophyll *a*:

- Protocol for the use of a single water sampler attached to a line;
- Protocol for the use of a water sampler attached to a rosette.

Protocol for the use of a single water sampler attached to a line

a. Principle of work

The measurement of salinity and oxygen, nutrients and chlorophyll *a* requires the collection of water samples from various depths. This essential task is achieved with "water bottles". The first water bottle was developed by Fritjof Nansen, the Nansen bottle. It consists of a metal cylinder with two rotating closing mechanisms at both ends. The bottle is attached to a wire. When the bottle is lowered to the desired depth it is open at both ends, so the water flows through it freely. At the depth where the water sample is to be taken the upper end of the bottle disconnects from the wire and the bottle is turned

⁷⁷ M. Stoeppler (Ed.), 1997. Sampling and Sample Preparation: Practical Guide for Analytical Chemists, Springer Verlag, Berlin, Germany.

upside down. This closes the end valves and traps the sample, which can then be brought to the surface.

In an "oceanographic cast" several bottles are attached at intervals on a thin wire and lowered into the sea. When the bottles have reached the desired depth, a metal weight ("messenger") is dropped down the wire to trigger the turning mechanism of the uppermost bottle. The same mechanism releases a new messenger from the bottle; that messenger now travels down the wire to release the second bottle, and so on until the last bottle is reached.

The Nansen bottle has now widely been displaced by the Niskin bottle. Based on Nansen's idea, it incorporates two major modifications. Its cylinder is made from plastic, which eliminates chemical reaction between the bottle and the sample that may interfere with the measurement of tracers. Its closing mechanism no longer requires a turning over of the bottle; the top and bottom valves are held open by strings and closed by an elastic band. Because the Niskin bottle is fixed on the wire at two points instead of one (as is the case with the Nansen bottle) it makes it easier to increase its sample volume. Niskin bottles of different sizes are used for sample collection. Nansen and Niskin bottles are used on conjunction with reversing thermometers.

b. Procedure

When the oceanographic cast is lowered to the desired depth, enough time to adapt to the sampling environment must be provided. It is mainly related to the measurement of temperature as the thermometers have to equalize with the local temperature. For digital reversing thermometers 2 minutes is required and 10 minutes for the mercury ones.

After the cast is fired (messenger released) the necessary time to all bottles are closed must be waited.

After the recovery of the bottles, usually they must be put on a sampler holder that provide easy sampling of the content and are not exposed to the direct sunlight, to minimize the heat exchange.

If sampled, the first step is to read the temperature.

The next sub-sampling protocol is maintained:

- i) Dissolved oxygen and pH samples using tygon tubing;
- ii) Salinity;
- iii) then in the order nitrite, other nutrients; and
- iv) chlorophyll *a*.

The contamination sources must be avoided:

- i) Contamination from the sampling equipment, ship and on-board activities should be avoided while sampling is undertaken. Some details are provided with single parameter.
- ii) Sampling bottles should be cleaned with dilute HCL acid and washed with pure water and always be kept closed when not in use.

Protocol for the use of a water sampler attached to a rosette

a. Principle of work

A rosette sampler is made of an assembly of 6 to 36 sampling bottles. Each bottle is a volume that range from a minimum value of 1.2 L to a maximum value of 30 L. All of them constitutes the rosette sampler and are clustered around a cylinder situated in the centre of the assembly where there is a sensing the CTD. The apparatus is attached to a wire rope. A winch on board of the boat unroll the rope during descent and roll up it during the ascent (i.e. at the end of the samples collection). During operations in the ocean, a rosette sampler can approach the seabed at a distance from 1 to 5 m, depending on the particular sea conditions. The opening of each sampling bottle can be automatic (by reaching a certain depth) or manual (by operator, remotely).

b. Procedure

The rosette and CTD is a unique instrument and as many protocols for CTD measurements (WOCE 1991⁷⁸, UNESCO 1994⁷⁹, UNESCO, 1988⁸⁰) are available and starting from what is suggested by these protocols and taking into account the field experience the protocol as provided hereunder is preferable.

The manufacturer's recommendations on preparations of the CTD and rosette sampler must be followed. If the CTD has not been used for a long time, e.g. the first cast of the cruise, problems with bottles leaking may occur since the O-rings for the bottle's caps are dehydrated. If this is known to happen, it can be prevented by rinsing and filling all bottles with freshwater for at least 1 hour before sampling.

When the CTD is on deck, the CTD pressure is started in the system and temperature is noted in the logbook.

The CTD must be lowered below the sea surface for at least 1 minute before starting the measurements. This gives time for all sensors to acclimatize and air bubbles have time to be flushed out by the pump.

The CTD is brought back to the surface and the measurement of the profile is started. If the sea state is rough, it is recommended to start the downcast from a few meters below the sea surface to prevent bubbles from breaking waves entering the sensors.

Care must be taken to keep the lowering speed as constant as possible, and around 0.5 m s⁻¹. If an Active Heave Compensation (AHC) system is available, a slower speed (0.3 m s⁻¹) can be used.

The CTD as close to the bottom as possible is lowered, though without risking bottom contact. The bottom depth and all the other information required by the CTD log or monitoring protocol are noted.

The rosette bottles should preferably be fired at selected standard depths during the up-cast in order to obtain an undisturbed CTD profile during the down-cast and undisturbed water samples on the way up. If the winch is maneuvered manually between each sampling depth, attention must be paid to approach the set depth as gentle as possible to reduce the disturbance of the water profile. This is especially important in stratified waters.

At each sampling depth the sampling bottles should have time to acclimatize and the effect of dragging water from deeper depth should be avoided. Wait at least 1 minute before the sampling bottles to be fired. If the CTD values still are not stable wait another 3 minutes before firing. If the bottles are equipped with reference sensors do not forget to wait the appropriate time for the sensors to measure after firing the bottle.

However, if the CTD and rosette is equipped and prepared for free-flow sampling bottles, it can be configured to fire water samples on predefined standard depths during the down-cast. Note that samples near the surface should be collected during up-cast to avoid trapping air bubbles mixed into the water by breaking waves and turbulence when the CTD is lowered.

When the CTD is back on deck, the pressure and temperature in the CTD log are noted. The pressure value must be approximately the same as that read before the cast; differences are due to thermal and mechanical hysteresis of the pressure sensor. Deck pressure as offsets to correct pressure is not used. Deck pressure should only be used as consistency check against laboratory measured historical drift.

⁷⁸ WOCE, 1991. WOCE Operational Manual WHPO 91-1, WOCE Report No68/. (<http://whpo.ucsd.edu/manuals.html>).

⁷⁹ UNESCO, 1994. Protocols for Joint Global Flux Study (JGOFS) Core Measurements. Manual and Guide, 29: 1-181.

⁸⁰ UNESCO, 1988. The acquisition, calibration and analysis of CTD data. A report of SCOR Working Group 51. UNESCO Technical Papers in Marine Science, 54: 1-59.

If there is any leakage or malfunction to the CTD, water sampler or water bottles it must be reported. Questionable sensor readouts should also be noted. All events happened during the cast also must be noted. Manufacturer's instructions for cleaning the CTD after each cast must be followed.

Between casts and after the cruise, the CTD and rosette in a way to prevent contamination must be stored.

c. Procedure after CTD/ rosette recovery

After the recovery, the CTD / rosette assembly must be put in a place not exposed to the direct sunlight or covered, to minimize the heat exchange.

The next sub-sampling protocol needs to be maintained:

- i) Dissolved oxygen and pH samples using tygon tubing;
- ii) Salinity, where sampled for control;
- iii) Then in the order nitrite, other nutrients, and
- iv) chlorophyll.

The contamination sources must be avoided:

- i) Contamination from the sampling equipment, ship and on- board activities should be avoided while sampling is undertaken. Some details are provided with single parameter.
- ii) Sampling bottles should be cleaned with dilute HCL acid and washed with pure water and always be kept closed when not in use.

Technical note for the sample preservation of seawater for the determination of hydrographic parameter and the measurement of concentration of key nutrients and chlorophyll *a*

Apart from representativeness, one of the main difficulties in sampling is the preservation of the sample. The initial composition of the sample must be maintained from sampling through to analysis. If this is not the case, the final conclusions will not reflect the initial situation. For all of that, handling and storage of collected samples is of a great importance during sampling.

Proper preservation practices must be followed. Samples requiring preservation should be preserved as soon as possible after collection to maintain the integrity of the sample. Complete and certain preservation of samples, regardless of source, is a practical impossibility. Regardless of the sample nature, complete stability for every constituent can never be fully attained. At best, sample preservation only slows the biological and chemical changes that inevitably continue after the sample is collected. Methods of preservation are intended to retard biological action, retard hydrolysis of chemical compounds and complexes, and reduce volatility of constituents. Preservation methods are limited to pH control, chemical addition, amber or opaque bottles, filtration, refrigeration, and freezing.

9. Under this Technical Note, this Monitoring Guidelines provides the following IMAP Protocols for the sample preservation of seawater for the determination of hydrographic parameter and the measurement of concentration of key nutrients and chlorophyll *a*:

- Protocol for the sample preservation of seawater for the determination of salinity;
- Protocol for the sample preservation of seawater for the determination of concentration of nutrients;
- Protocol for the sample preservation of seawater for the determination of concentration of chlorophyll *a*.

Protocol for the sample preservation of seawater for the determination of salinity

a. Equipment

The equipment for the sample preservation of seawater for the determination of salinity include:

- i) Niskin bottles arranged on cable or on a multiple sampler (rosette);

- ii) Glass bottles with perfect sealing caps from 120-250 ml (the necessary volume depends on the salinometer in use). To avoid leaks and evaporation, the use of glass bottles with cap and undercap is recommended.

b. *Procedure*

The sample bottle must be carefully rinsed (at least three times), using the same water as the sample.

The bottle must be filled up to the base of the neck, thus leaving enough space for the eventual thermal expansion of the water.

The cap, the screwing area and the neck of the bottle must be thoroughly rinsed and dried to avoid the formation of salt crystals that could precipitate and dissolve in the sample upon reopening in the laboratory.

The cap and undercap must be thoroughly tightened to avoid evaporation between the time of collection and analysis in the laboratory.

c. *Storage of samples*

For best results it is preferred to analyse the samples as soon as possible and only when their temperature is in equilibrium with that of the laboratory. Thermal equilibrium is typically achieved in 4-5 hours, but it can be accelerated by ensuring a good flow of air around the bottles or by immersing them in a water bath (Stalcup, 1991⁸¹). However, if kept at room temperature in bottles well capped, the samples remain unaltered for a few weeks, unless the variations of conductivity due to changes in pH, which can also cause changes in the salinity value to the second decimal place (Grasshoff, 1983)⁸². The tightness and chemical inertia of the bottles are factors determinants for a good conservation of the samples.

d. *Important notes*

It is advisable to write down the position number on the bottle that collects the sample Niskin bottle on the sampler. This will aid in the sampling phase and will minimize the possibility of collecting the sample on the wrong Niskin.

During the collection of the sample, to avoid contamination, attention must be paid to the water surface dripping from the external parts of the sampler. The same care should be taken in case of rain.

Undercaps should be changed every 2-3 years or when deformations occur.

Protocol for the sample preservation of seawater for the determination of concentration of nutrients

The concentrations of nutrients and other bioactive elements are liable to change due to the activity of microorganisms naturally present in seawater. Therefore, as a rule, samples should not be exposed unnecessarily to light and analysed within a few hours after collection.

Nevertheless, it is sometimes necessary to postpone the analysis for some hours or days because of rough weather or shortage of personnel and laboratory space. There is ample literature on this subject (eg., Kirkwood, 1992⁸³, 1996⁸⁴; Dore et al., 1996)⁸⁵ indicating that no single universal preservation regime will satisfy all requirements. For example, glass containers are not suitable if silicate is to be

⁸¹ Stalcup M.C., 1991. Salinity measurements. In: WOCE Operational Manual WHPO 91-1, WOCE Report No 68 (<http://whpo.ucsd.edu/manuals.html>).

⁸² Grasshoff, K., 1983. Determination of salinity. In: Grasshoff K., Ehrhardt M., Kremling K. (eds), *Methods of Seawater Analysis*, Verlag Chemie; Weinheim: 31-60.

⁸³ Kirkwood, D.S., 1992. *Mar. Chem.*, 38, 151.

⁸⁴ Kirkwood, D.S., 1996. *Nutrients: Practical notes on their determination in seawater*. Copenhagen: ICES Tech. Mar. Environ. Sci., 17, 25 pp.

⁸⁵ Dore, J.E., Houlihan, T., Hebel, D.V., Tien, G., Tupas, L., Karl, D.M. (1996), *Mar. Chem.*, 53, 173.

determined; in different seasons samples from the same location may contain microorganisms of different species and concentrations, so that a given preservation regime could be effective in spring but not in fall. The following two approaches to preservation are: refrigeration and poisoning.

Freezing (to -20 °C) is the method of choice of many scientists if nutrient samples have to be stored for several weeks or even months (e.g., Macdonald and McLaughlin, 1982⁸⁶; Macdonald et al., 1986⁸⁷; Kremling and Wenck, 1986⁸⁸; Chapman and Mostert, 1990⁸⁹; Kirkwood, 1996). If the samples are visibly turbid, they should be filtered as soon as possible after sampling. Subsamples should be placed in carefully cleaned bottles and frozen, stored and thawed in an upright position. For storage, hard-glass bottles with Teflon-lined screw caps should be used or, preferably, high density polyethylene, polycarbonate or polypropylene bottles. For silicate samples only plastic bottles are recommended. The bottles should only be filled to 2/3 of their volume to prevent squeezing of the liquid through the screw caps during the freezing process. If possible, 'quick-freezing' in liquid nitrogen or in a dry ice-methane slurry (to -20°C within about 20 min) is recommended. The best practice suggests that nutrient samples can be stored for no longer than a month prior to analysis (ISO 5667-3:2012)⁹⁰

The factors that affect the alteration of the samples can be mechanical, physical, chemical, biological and systematic. These drawbacks can be partially overcome by using the following measures:

- i. the sample can be stored in disposable scintillation type vials, in high density polyethylene, with a cap suitable for ensuring perfect closure. Polyethylene has the advantage of being resistant to chemical agents and thermal variations, it has a greater mechanical resistance and, from experimental tests, it has been shown that it does not yield and does not absorb substances;
- ii. the biological problem can be partially alleviated when the sample is filtered using syringes equipped with swinnex containing glass fiber filters with a pore size <1 µm previously rinsed with plenty of DDW and then, from time to time, with the water of the sample itself;
- iii. a single vial is used to determine the concentration of the nutrient to be analysed;
- iv. the containers must be washed with 10% HCl, then rinsed with DDW and finally with the sample itself;
- v. the sample must be taken directly from the sampling bottle and stored in the dark at a temperature of +4 °C if it is analysed within 24 hours. If the sample is not analysed within this period, it must be frozen at a temperature of -20 °C, taking care to leave the vial upright;
- vi. the vial should be filled no more than 3/4 of the volume.

This approach, with contained samples volumes, is more suited when samples are used with an automated analytical method.

Especially on small oceanographic vessels, in order to avoid contamination of the seawater sample with exhaust gas, it is advisable to sample directly from the spout of the water sampler using a 50 mL syringe. In this case, the syringe should be equipped with a Swinnex and two-way taps to facilitate washing of the syringe. The distribution of samples in scintillation vials for storage can be done in the ship's laboratories/environments not contaminated by exhaust gas.

The advantage of the scintillation vials, in addition to the practicality of organizing the vials themselves in specially designed supports, is in the speed of freezing, which is still considered the best conservation procedure. Some operators have verified that the use of vials previously used reduces the

⁸⁶ Macdonald, R.W., McLaughlin, F.A. (1982), *Water Res*, 16,95.

⁸⁷ Macdonald, R.W., McLaughlin, E.A., Wong, C.S. (1986), *Limnol. Oceanogr.*, 31, 1139.

⁸⁸ Kremling, K., Wenck, A. (1986), *Meeresforschung*, 31,69.

⁸⁹ Chapman, P., Mostert, S. A. (1990), *S. Afr J. Mar. Sci.*, 9,239.

⁹⁰ ISO 5667-3:2012 Water quality — Sampling. Part 3: Preservation and handling of water samples.

possibility of contamination. Others rinse the vials with a diluted solution of HCl (0.1 M) and allow the vials to dry upside down. In summary, a reliable procedure is to use containers, even new ones, but previously protected from dust or other possible contamination, which must be washed several times with the sample and not completely filled in order to prevent the expansion of the liquid during freezing forcing the frost out of the container.

a. Specific details of sample collection and preservation

The specific details of sample collection preservation are taken from the Reference manual for sampling and analysis techniques for the eutrophication monitoring strategy of MEDPOL (UNEP/MAP/MED POL, 2005) with minor enhancement.

a.1. *Orthophosphate - P*

Water samples for phosphate analysis should be collected in stoppered glass or “aged” polyethylene bottles of 50 to 100 ml volume directly from the outlet tube of the in-line filter used to collect suspended particulates. The samples are stored in a cool dark place until the analysis can be performed. For phosphate, the analysis should be commenced as soon as possible, preferably within half an hour, certainly before 2 hours and only glass bottles should be used for intermediate storage of the samples. The samples should not be stored in new polyethylene or polyvinylchloride containers since phosphate has been shown to disappear rapidly in these containers. Therefore, aged high-density polyethylene bottles or other plastic e.g. polycarbonate may be satisfactory but all sample containers should be thoroughly tested before use. Once collected, samples should be stored out of the light in a refrigerator until required for the analysis.

The addition of acid to unfiltered samples cannot be recommended since this cause hydrolysis of any polyphosphates and release of phosphate from plankton and bacteria. The addition of all the reagents of the analytical procedure to the sample and postponement of the photometric measurement is also not possible, since arsenic and silicate will also react and cause erroneous phosphate readings.

Summarizing, the storage of samples for the analysis of dissolved phosphate for more than one hour should be avoided.

a.2. *Ammonium - N*

Samples for ammonium analysis should only be taken and stored in tightly sealed seawater-aged glass or high-density polyethylene bottles, which should only be used for the analysis of ammonia. Filtration of samples should also be avoided, if possible, because it is nearly impossible to obtain filters free of ammonium. Waters with high turbidity frequently contain high concentrations of ammonia and may therefore be diluted before the analysis (the residual turbidity may then be compensated by subtraction of the absorbance of the appropriately diluted sample without addition of reagents).

Ammonium is a nutrient compound, which rapidly undergoes biological conversion, i.e., oxidation into nitrite and nitrate and fixation as amino-bound nitrogen in organisms. The analysis of ammonia should be commenced without delay after sampling. Chemical methods for preservation have been proved unsatisfactory because of the fact that organisms rapidly release ammonia. It is therefore strongly recommended that the ammonia reagents be added within one hour after sampling.

a.3. *Nitrite - N*

Nitrite is an intermediate compound, which occurs if ammonia is oxidized or nitrate is reduced. The presence of higher amounts of nitrite ($> 1.5 \mu\text{mol L}^{-1}$) signifies the presence of high bacterial activity in the seawater sample. Storage of samples for nitrite analysis can therefore not be recommended. Chemical preservation (e.g. addition of chloroform) also seems to be unsatisfactory. In turbid waters a filtration step is necessary. Therefore, the sub-sample for nitrite determination directly from the outlet of the in-line filter described above in a 100 - 150 ml glass container must be collected. The nitrite reagents should, if possible, be added to the sample within one hour. Intermediate storage of the sample in glass bottles in a refrigerator for up to 3 hours causes, in most cases, no significant changes in the nitrite content, if the original ammonia level is low ($< 0.07 \mu\text{mol L}^{-1}$). Samples should be stored in tightly sealed glass or polyethylene bottles only. Sulphide ions have been reported to interfere with

the determination of nitrite and, thus, when hydrogen sulphide is suspected to be present in a sample, the gas should be expelled with nitrogen after the addition of the acid sulphanilamide reagent (Grasshoff et al., 1983).

a.4. Nitrate - N

Nitrate is the final oxidation product of nitrogen compounds. Changes of the original nitrate content of a seawater sample can, therefore, only result from oxidation of ammonia and of nitrite or from adsorption of nitrate to the material of the sample container. Adsorption of nitrate into particles seems to be insignificant since the analytical procedure liberates any nitrate, which may be adsorbed. For reasons yet unknown, the nitrate content of a sample decreases rapidly if stored in polyethylene bottles, and at a level of $1.4 \mu\text{mol L}^{-1}$ about half of the nitrate disappears within seven days after storage at room temperature. This indicates that only glass or "aged" high-density polyethylene bottles with tight screw caps (preferably with Teflon liners) should be used.

If larger plastic bottles are used for sub-sampling for all nutrient analysis, the amount needed for nitrate should be transferred into a glass or "aged" high-density polyethylene bottle within one hour after the sampling. The analysis should not be delayed for more than 5 hours. In this case the samples should be stored in a refrigerator. If longer storage is unavoidable, the sample should be quickly frozen to $-20 \text{ }^{\circ}\text{C}$ after the addition of the ammonium chloride buffer solution (Grasshoff et al., 1983).

a.5. Silicate - Si

It is obvious that glass bottles should not be used for storage and analysis of seawater samples for reactive silicate. The sub-sampling for silicate analysis should be performed with plastic bottles (made of polyethylene or polypropylene). A few days storage of the sample in the dark in a refrigerator does not lead to significant changes in the silicate content. However, during seasons of high productivity, do not store them for longer than a day. Polymerization of orthosilicate during storage of frozen samples has been reported from fresh water samples but does not occur in seawater. If kept frozen, it is recommended to thaw the sample gradually at room temperature for at least 24 hours. However, as with all nutrients immediate analysis of sample is the preferred option.

The best procedure for storage and preservation of fresh-water samples seems to be the acidification of the sample with sulfuric acid to a pH of 2.5 and storage in tightly sealed, seawater-aged, high density polyethylene bottles in the dark at about $4 \text{ }^{\circ}\text{C}$. However, as with all nutrients immediate analysis of the sample is the preferred option.

Protocol for the sample preservation of seawater for the determination of concentration of chlorophyll *a*

a. Equipment and reagents

The equipment for the sample preservation of seawater for the determination of concentration of chlorophyll *a* include:

- i) Dark plastic bottles, 1 L (coastal waters) - 5 L (open sea)
- ii) Plankton net with $250 \mu\text{m}$ mesh
- iii) Plastic funnel suitable for bottles
- iv) Filtration apparatus (for filters with 25 or 47 mm diameter)
- v) Vacuum pump and trap
- vi) 25 or 47 mm Whatman GF/F fiberglass filters (recommended)
- vii) 10 ml calibrated centrifuge tubes
- viii) Freezer or fridge
- ix) Automatic sprayer or pipette for acetone
- x) 1 L graduated cylinders

xi) Funnel for filtration and filter paper

xii) Acetone, ppa [(CH₃)₂CO]

xiii) Anhydrous sodium carbonate [Na₂CO₃]

xiv) Neutralized acetone: pure anhydrous sodium carbonate to the pure acetone (ppa) is added and shaken vigorously. After at least 24 hours, the acetone is filtered through paper and transferred to the hermetically sealed bottle or bottle.

b. Sampling

Water sample from the sampling bottles to the dark plastic bottles, through the net with 250 µm mesh, must be transferred and stored in a cool place, away from sunlight. The prefiltration of the sample is intended to retain zooplankton and fragments of macroalgae possibly present (Strickland and Parsons, 1968⁹¹; Lenz and Fritsche, 1980⁹²).

c. Filtration procedure

Glass fibre filters, Whatman GF/F, are the most suitable for use and filtration must be carried out within a short time from the collection (max 1-2 hours), especially when the samples have been collected in eutrophic environments. The fiberglass filter is less prone to clogging and is cheaper than the synthetic membrane filter and are also used for their high retention capacity, ease of homogenization and versatility.

If the purpose is to estimate precise dimensional fractions of the particulate, filters based on synthetic membranes (polycarbonate) instead of glass fibre filters can be used. These filters, with an enucleation impression, have the advantage of having calibrated pores and therefore guarantee a very precise separation of the particles according to size. However, some disadvantages must be noted, such as the very low retention capacity, much slower filtration flow, making it necessary to distribute the sample on more filters if the sensitivity of the method want to be increased.

The filter is placed in the appropriate housing of the filtration apparatus, wetted and the vacuum pump with slight depression started, to allow it to uniformly adhere to the support.

Using a graduated cylinder, between 0.5 and 5 L of sample are poured into the funnel of the filtration system.

The vacuum pump is started, providing that the pressure difference between the lower and upper part of the filter does not exceed -25 KPa (about 150 mm Hg), to avoid breaking the plant cells with the consequent loss of pigments.

At the end of the filtration the filter the pump is kept running for a few seconds to avoid that a part of the material is lost. The amount of water to be filtered is related to the concentration of pigments (in the open sea where concentrations of chlorophyll *a* to about 1 µg L⁻¹ are generally measured about 3 L of sea water must be filtered while in coastal waters, 0.5 - 1 L may be sufficient).

As previously mentioned, algae suspensions must be filtered with a very small pressure difference between the two sides of the filter to minimize cell breakage.

The use of filtration supports that have a valve for the escape of air, not to limit the filtering surface due to the presence of air bubbles and that are tightened with the rotation of a ring nut independent of the upper face of the support, is advisable. Tearing the filter during assembly or disassembly of the support thus will be avoided.

d. Storage of samples

⁹¹ Strickland Ld., Parsons T.R., 1968. A practical handbook of sea-water analysis. Bull. Fish. Res. Board Can., 167, 1-312.

⁹² Lenz J., Fritsche P., 1980. The estimation of chlorophyll *a* in water samples: a comparative study on retention in a glass-fibre and membrane filter and on the reliability of two storage methods. Arch. Hydrobiol. Beih., 14: 46-51.

The conservation of the samples is a critical point of the analytical procedure, which can determine the onset of degradation processes of the chlorophylls that lead to their underestimation (Rai and Marker, 1982)⁹³. Consequently, to perform the extraction and analysis of chlorophyll pigments immediately after filtering the sample is always preferable.

However, if this is not possible, immediately after filtration the filter is placed in a centrifuge tube with hermetic seal and a known volume of neutralized pure acetone is added to completely submerge the filter (approximately 5 ml). The test tube is then kept in the dark at -20 °C (or in any case at temperatures between -20 and +4 °C), paying particular attention to the tightness of the closure.

Storing the filtered material for a period of time that lasts from a few days to several weeks can have a negative effect, leading to the degradation of chlorophyll pigments (Yanagi and Koyama, 1971⁹⁴; Blasco, 1973⁹⁵; Neveux, 1979⁹⁶; Lenz and Fritsche, 1980; Lazzara et al., 1990⁹⁷; Mantoura et al., 2005⁹⁸).

Alternative methods of storing the filters have been used, which however are not recommended, such as storing at -20 °C after freezing the damp or dried filters (Panella and Magazzù, 1978⁹⁹) or the drying and freezing technique (freeze-drying) which does not give satisfactory conservation results according to Lenz and Fritsche (1980).

The conservation of chlorophyll *a* in microalgae samples collected on a filter has so far been the subject of a very limited number of studies, if the diffusion of the practice of conserving filters, even for prolonged periods (Mantoura et al., 2005) is to be considered. Almost all of the studies date back to before the 1980s, do not concern separate analyses of the extracted pigments and often present contrasting results (Marker et al., 1980)¹⁰⁰ so that no freezing practice can be recommended.

In conclusion, immediate measurements on the extracts is advisable to be carried out or, in the impossibility, the conservation of the filter immersed in pure acetone at -20 °C or better at -80 °C only for periods of less than a month, or of wet filter frozen in air (between -20 °C and -80 °C) but only for periods shorter than the week.

⁹³ Rai H., Marker A.F.M., 1982. The measurements of photosynthetic pigments in freshwaters and standardization of methods. *Arch. Hydrobiol. Beih.*, 16: 1-130.

⁹⁴ Yanagi K, Koyama T., 1971. Thin layer chromatographic method for determining plant pigments in marine particulated matter, and ecological significance of the results. *Geochem. J.*, 5: 23-37.

⁹⁵ Blasco D., 1973. Estudio de las variaciones de la relacion fluorescencia in vivo chl a, y su aplicacion en ocea- nografia. Influencia de la limitacion de diferentes nutrientes, efecto del dia y noche y dependencia de la especie estudiada. *Inv. Pesq.*, 37: 533-536.

⁹⁶ Neveux J., 1979. Pigments chlorophylliens. In: Jacques G. (ed), *Phytoplankton, Biomasse, Production, Numeration et Culture*. Edition du Castellet, Perpignan: 1-107.

⁹⁷ Lazzara L., Bianchi F., Falcucci M., Hull V., Modigh M., Ribera D'alcalà M., 1990. Pigmenti clorofilliani. In: Innamorati M., Ferrari I., Marino D., Ribera d'Alcalà M. (eds), *Metodi nell'ecologia del plancton marino*. Nova Thalassia, LINT, Trieste: 207-223.

⁹⁸ Mantoura R.F.C., Wright S.W., Barlow R.G., Cummings D.E., 2005 Filtration and storage of pigments from microalgae. In: Jeffery S.W., Mantoura R.F.C., Wright S.W. (eds), *Phytoplankton pigments in ocea- nography: guidelines to modern methods*. 2nd ed. SCOR UNESCO, Paris: 283-305.

⁹⁹ Panella S., Magazzù G., 1978. Analisi dei pigmenti fitoplanctonici. In: Magazzù G. (ed.), *Metodi per lo studio del plancton e della produzione primaria*. Edizioni GM: 19-33.

¹⁰⁰ Marker A.F.H., Nusch E.A., Rai H., Riemann B., 1980. The measurement of photosynthetic pigments in fresh waters and standardization of methods: conclusions and recommendations. *Arch. Hydrobiol. Beih. Ergebn. Limnol.*, 14: 91-106.

References

- UNEP/MAP/MED POL, 2005. Sampling and Analysis Techniques for the Eutrophication Monitoring Strategy of MED POL. MAP Technical Reports Series No. 163. UNEP/MAP, Athens, 46 pp.
- UNEP/MAP, 2019. UNEP/MED WG.467/5. IMAP Guidance Factsheets: Update for Common Indicators 13, 14, 17, 18, 20 and 21: New proposal for candidate indicators 26 and 27.
- UNEP/MAP, 2019a. UNEP/MED WG.463/6. Monitoring Protocols for IMAP Common Indicators related to pollution.
- UNEP/MAP, 2019b. UNEP/MED WG.463/10. Schemes for Quality Assurance and Control of Data related to Pollution.

Salinity

- Grasshoff, K., 1983. Determination of salinity. In: Grasshoff K., Ehrhardt M., Kremling K. (eds), *Methods of Seawater Analysis*, Verlag Chemie; Weinheim: 31-60.
- Stalcup M.C., 1991. Salinity measurements. In: WOCE Operational Manual WHPO 91-1, WOCE Report No 68 (<http://whpo.ucsd.edu/manuals.html>).

Key nutrients

- Chapman, P., Mostert, S. A. (1990), *S. Afr J. Mar. Sci.*, 9,239.
- Dore, J.E., Houlihan, T., Hebel, D.V., Tien, G., Tupas, L., Karl, D.M. (1996), *Mar. Chem.*, 53, 173.
- ISO 5667-3:2012 Water quality — Sampling. Part 3: Preservation and handling of water samples.
- Kirkwood, D.S., 1992. *Mar. Chem.*, 38,151.
- Kirkwood, D.S., 1996. Nutrients: Practical notes on their determination in seawater. Copenhagen: ICES Tech. Mar. Environ. Sci., 17,25 pp.
- Kremling, K., Wenck, A. (1986), *Meeresforschung*, 31,69.
- Macdonald, R.W., McLaughlin, F.A. (1982), *Water Res*, 16,95.
- Macdonald, R.W., McLaughlin, EA., Wong, C.S. (1986), *Limnol. Oceanogr.*, 31, 1139.

Chlorophyll *a*

- Blasco D., 1973. Estudio de las variaciones de la relacion fluorescencia in vivo chl a, y su aplicacion en ocea- nografia. Influencia de la limitacion de diferentes nutrientes, efecto del dia y noche y dependencia de la especie estudiada. *Inv. Pesq.*, 37: 533-536.
- Lazzara L., Bianchi F., Falcucci M., Hull V., Modigh M., Ribera D'alcalà M., 1990. Pigmenti clorofilliani. In: Innamorati M., Ferrari I., Marino D., Ribera d'Alcalà M. (eds), *Metodi nell'ecologia del plancton marino*. Nova Thalassia, LINT, Trieste: 207-223.
- Lenz J., Fritsche P., 1980. The estimation of chlorophyll a in water samples: a comparative study on retention in a glass-fibre and membrane filter and on the reliability of two storage methods. *Arch. Hydrobiol. Beih.*, 14: 46-51.
- Mantoura R.F.C., Wright S.W., Barlow R.G., Cummings D.E., 2005 Filtration and storage of pigments from microalgae. In: Jeffery S.W., Mantoura R.F.C., Wright S.W. (eds), *Phytoplankton pigments in ocea- nography: guidelines to modern methods*. 2nd ed. SCOR UNESCO, Paris: 283-305.

- Marker A.F.H., Nusch E.A., Rai H., Riemann B., 1980. The measurement of photosynthetic pigments in fresh waters and standardization of methods: conclusions and recommendations. Arch. Hydrobiol. Beih. Ergebn. Limnol., 14: 91–106.
- Neveux J., 1979. Pigments chlorophylliens. In: Jacques G. (ed), *Phytoplankton, Biomasse, Production, Numeration et Culture*. Edition du Castellet, Perpignan: 1-107.
- Panella S., Magazzù G., 1978. Analisi dei pigmenti fitoplanctonici. In: Magazzù G. (ed.), *Metodi per lo studio del plancton e della produzione primaria*. Edizioni GM: 19-33.
- Rai H., Marker A.F.M., 1982. The measurements of photosynthetic pigments in freshwaters and standardization of methods. Arch. Hydrobiol. Beih., 16: 1-130.
- Strickland Ld., Parsons T.R., 1968. A practical handbook of sea-water analysis. Bull. Fish. Res. Board Can., 167, 1-312.
- Yanagi K., Koyama T., 1971. Thin layer chromatographic method for determining plant pigments in marine particulated matter, and ecological significance of the results. *Geochem. J.*, 5: 23-37.

Appendix 11

Monitoring Guidelines/Protocols for Determination of Hydrographic Physical Parameters

1. Introduction

1. In this Guideline for Determination of Hydrographic Physical Parameters the supporting parameters temperature, salinity and transparency are presented. Temperature and salinity are essential in the basic calculation of other parameters as are dissolved oxygen and pH. On the other hand, they also serve as proxy for the definition of the water typology important tool in the water classification scheme on which the assessment of GES is based on as presented in detail in the IMAP Guidance Factsheets (UNEP/MAP, 2019)¹⁰¹.

The IMAP Protocols elaborated within this Monitoring Guidelines for Determination of Hydrographic Physical Parameters provide detail guidance on the necessary equipment, chemical reagents, analytical procedures along with appropriate methodologies for measurement of the core hydrography physical supporting parameters, calculations, data transformation if necessary and identify weak points, including important specific notes and elaborated possible problems. However, they are not intended to be analytical training manuals, but guidelines for Mediterranean laboratories, which should be tested and accordingly modified, if need be, in order to validate their final results.

This Monitoring Guidelines builds upon the UNEP/MAP Integrated Monitoring and Assessment Programme (IMAP) respectively IMAP Guidance Fact Sheets for IMAP Common Indicators 13 and 14 (UNEP/MAP, 2019); standardized protocols (UNEP/MAP, 2019a)¹⁰² and Data Quality Assurance schemes (UNEP/MAP, 2019b)¹⁰³ in order to allow the comparability of the data and build of regional assessment schemes. They also take into account previous Sampling and Analysis Techniques for the Eutrophication Monitoring Strategy of MED POL (UNEP/MAP/MED POL, 2005)¹⁰⁴, however providing detail procedures that are of relevance for IMAP implementation. With the details of the protocols for hydrographic chemical parameters, the needs of the measurements both in offshore areas and in narrow coastal areas are addressed.

In the Subchapters “Symbol, units and precision” at the end of each Protocol, for all parameters described in it, the symbol and unit suggested by the International System of Units (SI) are presented. The expected accuracy, precision and where possible the Limit of Detection (LOD) are also presented. The Method identifiers are also presented as it is provided in the Library P01 of the British Oceanographic Data Centre (BODC) Parameter Usage Vocabulary respectively included in Data Dictionaries and Data Standards for eutrophication built in IMAP Pilot Info System.

The below flow diagram informs on the category of this Monitoring Guideline related to determination of hydrographic physical parameters within the structure of all Monitoring Guidelines prepared for IMAP Common Indicators 13, 14, 17, 18 and 20.

¹⁰¹ (UNEP/MAP, 2019), UNEP/MED WG.467/5. IMAP Guidance Factsheets: Update for Common Indicators 13, 14, 17, 18, 20 and 21: New proposal for candidate indicators 26 and 27

¹⁰² (UNEP/MAP, 2019a), UNEP/MED WG.463/6. Monitoring Protocols for IMAP Common Indicators related to Pollution.

¹⁰³ (UNEP/MAP, 2019b), UNEP/MED WG.467/10. Schemes for Quality Assurance and Control of Data related to Pollution

¹⁰⁴ (UNEP/MAP/MED POL), 2005. Sampling and Analysis Techniques for the Eutrophication Monitoring Strategy of MED POL. MAP Technical Reports Series No. 163. UNEP/MAP, Athens, 46 pp.

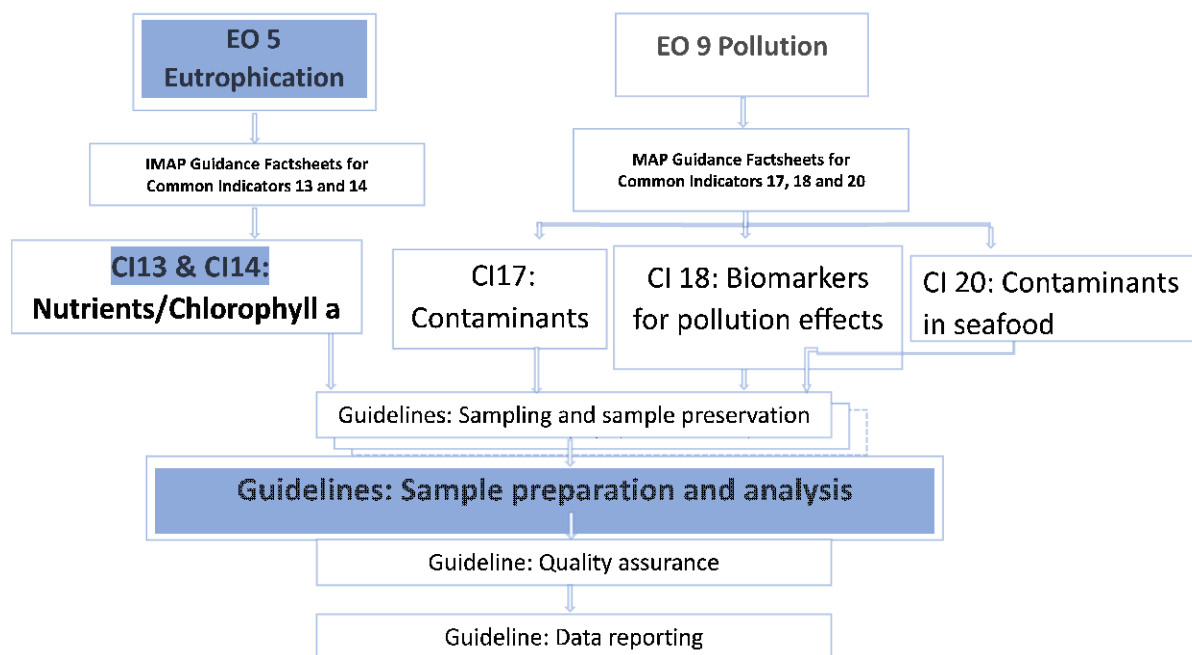

Flow Diagram: Monitoring Guidelines for IMAP Ecological Objectives 5 and 9

2. Technical note for determination of temperature and salinity of seawater

Temperature is the property that regulates the transfer of thermal energy or heat between two bodies: the heat flow is directed from the warmer body to the colder one until thermal equilibrium is reached. Temperature measuring instruments are based on this basic principle. The temperature, together with salinity, is useful for identifying the mass of water sampled and for calculating, using an equation of state, the density and other derived quantities. This parameter also has effects on biological systems and in general on the chemical-physical balances in the marine environment, including the solubility of gases (e.g. oxygen solubility) and pH.

Prior to January 1, 1990, the temperature was expressed in the International Practical Temperature Scale of 1968 (ITS-68). The 1990 International Temperature Scale (ITS-90) was subsequently adopted, which currently represents the best approximation of the thermodynamic temperature (T). In oceanography the convention is to measure the temperature on the Celsius (t) scale, whose unit is °C and with $t = T - 273.15$. The conversion between the old scale (t_{68}) and the new one (t_{90}) is given by the formula (Saunders, 1990)¹⁰⁵:

$$t_{68} = 1.00024 t_{90}$$

Salinity is a measure of the content of dissolved materials in sea water. Together with the temperature it is a parameter of fundamental importance for identifying the mass of water sampled and for calculating the density (using an equation of state) and other derived quantities. It affects other parameters such as dissolved oxygen and has effects on many biological and chemical processes and systems in the marine environment.

¹⁰⁵ Saunders, P., 1990. The International Temperature Scale of 1990, ITS-90. Woce Newsletter, 10, IOS, Wormley, UK.

Absolute salinity (SA) is defined as the ratio between the total mass of materials dissolved in sea water and the total mass of water. SA is very difficult if not impossible to measure directly, because it would be necessary to fully know the composition of sea water. Therefore, in practice, an approximate definition is given, the measurement of which is more easily achievable.

The first practical definition of salinity is that given in 1899 by the International Commission for the study of the oceans led by Prof. Martin Knudsen which established that salinity is the residual mass of salt (measured in grams) per kilogram of sea water, when all the carbonates have been transformed into oxides, the bromides and iodides replaced by chlorides and all the organic substance has been oxidized (Forch et al., 1902)¹⁰⁶. Since the various components contribute to salinity according to a practically constant ratio and the main component, chloride, is easy to accurately measure by a simple chemical analysis (titration), for a long time the salinity of seawater has been determined indirectly by measuring the mass of chlorides dissolved in the water and using empirical relationships (Forch et al., 1902; Wooster et al., 1969)¹⁰⁷.

The definition of salinity was revised when a technique was developed to be able to determine it from water conductivity measurements. In 1978, the JPOTS (UNESCO, 1981)¹⁰⁸ introduced the Practical Salinity Scale (PSS-78), which defines the practical salinity as a function of the ratio K_{15} between the electrical conductivity of a sample of sea water at temperature $t_{68} = 15\text{ }^{\circ}\text{C}$ (defined in the IPTS-68 temperature scale) and at the pressure of a standard atmosphere (101325 Pa in the SI, corresponding to 1013.15 millibar), and that of a solution of potassium chloride (KCl), in which the molar fraction of KCl is 0.0324356, under the same conditions of temperature and pressure. A $K_{15} = 1$ corresponds to a practical salinity of 35.

At $15\text{ }^{\circ}\text{C}$, the standard solution of KCl has an electrical conductivity which is equivalent to that of a North Atlantic seawater sample with chlorinity of 19.3740 at the same temperature. This fact guarantees:

- a certain continuity between the salinity measurements in the Practical Scale and the previous ones, which were largely based precisely on the measurement of chlorinity;
- the use of sea water with $K_{15} \gg 1$ as a secondary standard for the routine calibration of instruments for measuring salinity.

Practical salinity is a dimensionless quantity, whose order of magnitude coincides with that of Knudsen's definition. Although it is an adopted practice, it is technically wrong to use the abbreviation "psu" (practical salinity units), and this practice should be absolutely avoided. This quantity enters into all the algorithms that are currently in use for calculating the thermodynamic properties of sea water (UNESCO, 1983)¹⁰⁹ and is also the one that is stored in databases.

Under this Technical Note, the Monitoring Guidelines for Determination of Hydrographic Physical Parameters elaborates the three following Protocols:

- Protocol for determination of temperature and salinity using CTD;
- Protocols for the determination of temperature using reversing thermometers;
- Protocol for sample preparation and analysis of salinity using bench salinometer.

¹⁰⁶ Forch C., Knudsen M., Sorensen S.P.L., 1902. Berichte über die Konstantenbestimmungen zur Aufstellung der hydrographischen Tabellen. Kgl. Danske Vidensk Selsk. Skrifter, 6 Raekke Naturvidensk, Mathem. Afd., 12: 1-151.

¹⁰⁷ Wooster W.S., Lee A.J., Dietrich G., 1969. Redefinition of salinity. Deep-Sea Res., 16: 321-322.

¹⁰⁸ UNESCO, 1981. The practical salinity scale 1978 and the international equation of seawater 1980. UNESCO Technical Papers in Marine Science, 36: 1-25.

¹⁰⁹ UNESCO, 1983. Algorithms for computation of fundamental properties of seawater. UNESCO Technical Papers in Marine Science, 44: 1-53.

2.1 Protocol for determination of temperature and salinity using CTD

The multiparameter probe, the only device with which the simultaneous and *in situ* measurement of temperature, salinity, pressure and any other bio-chemical parameters of interest are allowed. Multiparameter probes for oceanographic measurements have been in use since the middle of the last century. The central unit that incorporates and manages the sensors that measure the quantities of interest is their main part. The probes for the measurement of physical parameters at sea are commonly called CTD, an acronym that summarizes the three basic physical parameters measured (C = Conductivity, T = Temperature, D = Depth, i.e. conductivity, temperature and depth). In reality, CTD probes do not measure depth directly, but provide an indirect measure of it by detecting pressure. CTD probes have a dual use, as profilers, when they are dropped along the water column from the surface to the bottom or to a desired intermediate depth, or as fixed-point sampling instruments (as happens when they are installed on a buoy or on an instrumented anchor). In the first case, the measurement of a vertical profile of the parameters and in the second one a time series at a precise point in space are collected. The vertical resolution of the profile and the temporal resolution are related on the sampling frequency of the instrument.

To check the correct functioning of a CTD system during an oceanographic campaign, it is useful to make comparisons by collecting water samples with a sampler connected to the system, to be analysed with a salinometer and by carrying out temperature measurements using reversing thermometers mounted on the sampler. The pressure values measured by the sensor of the CTD system can be compared with those provided by an independent pressure sensor.

a. Equipment

CTD: preferably be equipped with dual sensors for salinity and temperature, to prevent loss of data and provide a first instance of quality control. For stratified waters CTDs should preferably have a sampling rate of 12 Hz or higher. A CTD equipped with a rosette for water samplers is preferred to individual sampling flasks clamped to a wire. It is recommended that the CTD is mounted vertically within the frame of the rosette frame to avoid fouling of sensors by debris or bubbles and promote free flow of water.

Reversing thermometers, mounted on the rosette frame or on samplers from which reference data for temperature is obtained.

Sampling bottles attached to the CTD-rosette or attached on a line from which reference samples for bench salinometers are obtained.

b. Procedure

Many protocols for CTD measurements (WOCE 1991¹¹⁰, UNESCO 1994¹¹¹, UNESCO, 1988¹¹²) are available. Starting from what is suggested by these protocols and taking into account the field experience the following protocol is preferable:

The manufacturer's recommendations on preparations of the CTD and rosette sampler must be followed. If the CTD has not been used for a long time, e.g. the first cast of the cruise, problems with bottles leaking may occur since the O-rings for the bottle's caps are dehydrated. If this is known to

¹¹⁰ WOCE, 1991. WOCE Operational Manual WHPO 91-1, WOCE Report No68/. (<http://whpo.ucsd.edu/manuals.html>).

¹¹¹ UNESCO, 1994. Protocols for Joint Global Flux Study (JGOFS) Core Measurements. Manual and Guide, 29: 1-181.

¹¹² UNESCO, 1988. The acquisition, calibration and analysis of CTD data. A report of SCOR Working Group 51. UNESCO Technical Papers in Marine Science, 54: 1-59.

happen, it can be prevented by rinsing and filling all bottles with freshwater for at least 1 hour before sampling.

When the CTD is on deck the system is started and the CTD pressure and temperature in the logbook noted.

The CTD must be lowered below the sea surface for at least 1 minute before starting the measurements. This gives time for all sensors to acclimatize and air bubbles have time to be flushed out by the pump.

The CTD is brought back to the surface and the measurement of the profile started. If the sea state is rough it is recommended to start the downcast from a few meters below the sea surface to prevent bubbles from breaking waves entering the sensors.

Care must be taken to keep the lowering speed as constant as possible, and around 0.5 m s^{-1} . If an Active Heave Compensation (AHC) system is available, a slower speed (0.3 m s^{-1}) can be used.

The CTD as close to the bottom as possible is lowered, though without risking bottom contact. The bottom depth and all the other information required by the CTD log or monitoring protocol are noted.

The rosette bottles should preferably be fired at selected standard depths during the up-cast in order to obtain an undisturbed CTD profile during the down-cast and undisturbed water samples on the way up. If the winch is maneuvered manually between each sampling depth, attention must be paid to approach the set depth as gentle as possible to reduce the disturbance of the water profile. This is especially important in stratified waters.

At each sampling depth the sampling bottles should have time to acclimatize and the effect of dragging water from deeper depth should be avoided. Wait at least 1 minute before the sampling bottles to be fired. If the CTD values still are not stable wait another 3 minutes before firing. If the bottles are equipped with reference sensors do not forget to wait the appropriate time for the sensors to measure after firing the bottle.

However, if the CTD and rosette is equipped and prepared for free-flow sampling bottles, it can be configured to fire water samples on predefined standard depths during the down-cast. Note that samples near the surface should be collected during up-cast to avoid trapping air bubbles mixed into the water by breaking waves and turbulence when the CTD is lowered.

When the CTD is back on deck, the pressure and temperature in the CTD log are noted. The pressure value must be approximately the same as that read before the cast; differences are due to thermal and mechanical hysteresis of the pressure sensor. Deck pressure as offsets to correct pressure is not used. Deck pressure should only be used as consistency check against laboratory measured historical drift.

If there is any leakage or malfunction to the CTD, water sampler or water bottles it must be reported. Questionable sensor readouts should also be noted. All events happened during the cast also must be noted. Manufacturer's instructions for cleaning the CTD after each cast must be followed.

Between casts and after the cruise; the CTD and rosette in a way to prevent contamination must be stored. All sensors should be treated and stored according to the manufacture's recommendations.

Reference data for temperature is obtained from reversing thermometers, mounted on the rosette frame.

CTD-rosette or line; It is recommended that reference samples are collected in triplicates. For general requirements for sampling, preservation, handling, transport and storage of water samples, chapter

1.2.1. Protocol for the sample preservation of seawater for the determination of salinity must be consulted.

c. Symbol, units and precision

For the parameters described in this protocol, the symbols and units suggested by the International System of Units (SI), as well as the expected accuracy, along with the Method identifiers as provided in the Library P01 of BODC Parameter Usage Vocabulary are provided as follows:

Depth:

Symbol: *z* **Unit:** m

Precision: Pressure sensor: ± 0,01 m

Method identifier: SDN:P01::DEPHPR01 Depth (spatial coordinate) relative to water surface in the water body by profiling pressure sensor and conversion to seawater depth using UNESCO algorithm

Temperature:

Symbol: *t* **Unit:** °C (degree Centigrade)

Precision: Temperature sensor: ± 0,01 °C

Method identifier: SDN:P01::TEMPCC01 Temperature of the water body by CTD and verification against independent measurements

Salinity:

Symbol: *S* **Unit:** -

Precision: Conductivity sensor: ± 0,01

Method identifier: SDN:P01::PSALCC01 Practical salinity of the water body by CTD and computation using UNESCO 1983 algorithm and calibration against independent measurements

2.2 Protocols for the determination of temperature using reversing thermometers

2.2.1 Digital electronic reversing thermometers

The digital reversing electronic thermometer can perform the same functions as the mercury one, but with higher precision. Having the same dimensions of the mercury one it enters the housings provided for this type of thermometer. In this thermometer the temperature is measured by a platinum thermometer similar to the sensors used on the CTD probes. The advantages are that it does not use mercury, it covers a larger range of measurement, reading is easier because it is provided in digital form reducing the risk of loss of data, it is robust and easy to use.

a. Procedure

The thermometers are placed in the special thermometer holders with which the sampling bottles are equipped. In thermometer holders without a locking mechanism, the thermometers must be locked using para or neoprene rubber cylinders, usually supplied with thermometer holders, which cushion any mechanical shocks.

With the thermometer holder armed, a small magnet (supplied with the thermometer or common) is slid three times along the major axis of the thermometer, until on the display shows written "Samp"; in this way the thermometer is set in reversing mode. For information, the "Cont" mode is used to display the instantaneous temperature measured in real time by the thermometer, while the "Hold" mode displays the temperature data recorded after reversing the thermometer, while it was in "Samp" mode.

The bottles with the thermometers must be kept at the programmed depths for the time necessary to reach the balance with the surrounding medium. The time required for digital thermometers is about 30 seconds. Then the command to close is send the bottle and to reverse the thermometer and wait at least ten seconds after the closing confirmation signal before changing deep or to retrieve the bottle.

Once the bottles are brought back to the surface, sliding the long magnet once along the major axis of the thermometer, the temperature value will appear on the display for a few seconds recorded by the thermometer during the reversal.

The data are written in a form, reporting the serial number for each thermometer.

2.2.2 Mercury reversing thermometers

Mercury reversing thermometers consist of a main and a secondary thermometer, coupled in a glass container that protects them from mechanical changes induced by the water pressure. The main thermometer has a relatively large mercury tank that communicates, by means of a serpentine strangled in one point (called "break-off point") with a thin capillary ending with a small widening which constitutes a secondary tank. When the thermometer is in a straight position, at the desired depth, the mercury contained in the main tank changes volume according to the external temperature and occupies part of the thin capillary. When the thermometer overturn, due to the considerable surface tension, the mercury contained in the capillary breaks in the coil at the height of the choke and separates from the rest. The amount of mercury that separated, collected in the secondary tank and in part of the capillary, indicates the water temperature at the time of reversing. The auxiliary thermometer, mounted next to the reversing thermometer, is used to measure the ambient temperature, once the thermometer is brought back to the surface. **NOTE:** The use of mercury is prohibited except in exceptional cases.

a. Procedure

The thermometers are placed in the special thermometer holders with which the sampling bottles are equipped. In thermometer holders without a locking mechanism, the thermometers must be locked using para or neoprene rubber cylinders, usually supplied with thermometer holders, which cushion any mechanical shock.

The bottles with the thermometers are kept at the programmed depths for the time necessary to reach balance with the surrounding medium. The time required for mercury thermometers is 5-10 minutes. The reversing of the thermometer is then triggered.

The bottles are then returned to the surface and placed on a special support, making sure that are not directly affected by the sun, possibly covering them with a wet towel to avoid large fluctuations in temperature.

Once the balance between the temperature of the thermometers and the ambient temperature has been reached, using the appropriate eyepiece, the water temperature is read on the main thermometer (t'') with accuracy to one hundredth of a degree or higher in relation to the characteristics of the scale.

Similarly, on the auxiliary thermometer, the air temperature (t'_a) is read with tenth degree precision. The eye must be in level with the upper part of the mercury column, to avoid errors due to refraction.

The data are written in a form, reporting the serial number for each thermometer.

b. Calculations

The reading provided by the thermometer, for the error caused by the capillary imperfections must be corrected proceeding as indicated in the calibration certificate that accompanies the thermometer. In the certificate, for temperature ranges of 5 °C, the correction to be made to the value read on the thermometer to obtain the real temperature value, or the value of the actual temperature at a given temperature value read, is reported. The temperature value read on the thermometer will probably not exactly match those indicated on the certificate, therefore first must be calculated the correction to be made to this value by applying a simple linear relationship between read values and real values. From the manufacturer's tables the values t''_{inf} and t''_{sup} within which the reading (t'') is included and the corresponding correct values t'_{inf} and t'_{sup} , are read and the correct temperatures for the main thermometer t' and for the auxiliary thermometer t'_a calculated from the following equations:

$$t' = t'_{inf} + (t'' - t''_{inf}) (t'_{sup} - t'_{inf}) / (t''_{sup} - t''_{inf})$$

$$t'_a = t'_{a,inf} + (t''_a - t''_{a,inf}) (t'_{a,sup} - t'_{a,inf}) / (t''_{a,sup} - t''_{a,inf})$$

t' and t'_a are inserted in the following equation:

$$c = (V_0 + t') / (t' - t'_a) / [K - \frac{1}{2} (t' - t'_a) - (V_0 + t')]$$

where:

c = correction to be made,

K = inverse of the thermal expansion coefficient of the glass with which the thermometer is built.

V_0 = volume of mercury at 0 °C expressed as °C (=the degree volume).

The values of K and V_0 are obtained from the calibration certificate.

The water temperature *in situ* is calculated from the formula:

$$t_w = t' + c$$

c. Important notes related to both types of reversing thermometers

All reversing thermometers, regardless of type, must be calibrated with a reference thermometer at least once a year. The reference thermometers must in turn be properly calibrated. Calibration must take place in thermostated baths.

Mercury thermometers must be treated gently, avoiding sharp strokes as they can cause microfractures in the capillary compromising its functioning; digital electronic thermometers are less delicate, but like all electronic instruments, they must be treated with care.

For mercury thermometers, if mercury does not return to the tank, avoid the common practice of gently tap the thermometer, because this causes small damages to the capillary. The reunification must be produced by forcing the expansion of mercury with a heat source.

The main malfunction that mercury thermometers may face concerns the possibility that during the reversal the mercury contained in the capillary will break at a height other than the "break-off point". This can happen due to the presence of bubbles formed by residual gas remained inside the thermometer during construction. This gas should remain confined at the upper end of the

thermometer, in the secondary tank, but it can happen that a bubble penetrates the column of mercury, causing it to break in the wrong place. To avoid the problem, the thermometers must be stored and transported in a vertical position (with the main tank down) and handled gently.

d. Symbol, units and precision:

For the parameter described in this protocol, the symbol and unit suggested by the International System of Units (SI), as well as the expected accuracy, along with the Method identifiers as provided in the Library P01 of BODC Parameter Usage Vocabulary are provided as follows:

Symbol: <i>t</i>	Unit: °C (degree Centigrade)
Precision:	Mercury reversing thermometer: ± 0,01 °C
	Digital electronic thermometer: Accuracy: ±0,0001 °C
Method identifier: SDN:P01:: TEMPRTNX	Temperature of the water body by reversing thermometer
	SDN:P01:: TEMPR601 Temperature (IPTS-68) of the water body by reversing thermometer
	SDN:P01:: TEMPR901 Temperature (ITS-90) of the water body by reversing thermometer

2.3 Protocols for sample preparation and analysis of salinity using bench salinometer

a. Equipment

The equipment for for sample preparation and analysis of salinity include: i) a laboratory salinometer; ii) IAPSO standard water bottles.

b. General analytical procedure:

b.1 Preparation

The salinometer must be turned on well in advance (at least two hours before the analysis), to stabilize the operation of its electrical parts and, when present, the temperature of the thermostatic bath.

Two bottles of standard water and the samples must be bring in the vicinity of the salinometer with which the measurement is carried out and allow a certain period of time to pass until they reach the same temperature.

b.2 Standardization

The measuring cell must be rinsed at least ten times with sea water with a salinity of about 35. There are bottles of water with these characteristics on the market, alternatively the standard water residues used in previous operations can be used.

The standard water bottles must be shaken carefully and gently to homogenize their contents, avoiding the formation of bubbles.

The standard water bottle must be opened and inserted into the salinometer sampling device.

The measuring cell must be rinsed at least four or five times with standard water.

The measuring cell is then filled with standard water and the salinometer standardized according to the procedure indicated by the manufacturer.

At least two or three measurements of the same standard water must be carried out, unloading and filling the cell each time and checking that the salinity value read after standardization coincides with the salinity value indicated on the standard bottle. If the value does not match, the standardization procedure with a new bottle of standard water must be repeated.

b.3 Measurement

With repeated overturning of the bottle the sample is homogenize avoiding too vigorous shaking not to allow the formation of air bubbles.

The measuring cell must be rinsed with the sample at least four or five times.

The measuring cell is filled with the sample and the outputs read.

The measuring cell is unloaded and filled again with the sample for new reading.

The operation referred to in the previous point is repeated until the difference between two consecutive readings is not less than the level of precision declared by the manufacturer of the instrument.

c. Calculations:

Having determined the conductivity ratio, R_t , between the sample and the standard water at temperature t_{68} (expressed on the IPTS-68 scale), the practical salinity is calculated according to the following equation, valid in the interval for S [2,42] (UNESCO, 1983):

$$S = a_0 + a_1R_t^{1/2} + a_2R_t + a_3R_t^{3/2} + a_4R_t^2 + a_5R_t^{5/2} + \Delta S$$

where

$$\Delta S = (b_0 + b_1R_t^{1/2} + b_2R_t + b_3R_t^{3/2} + b_4R_t^2 + b_5R_t^{5/2}) \cdot (t_{68} - 15) / [1 + k(t_{68} - 15)]$$

t_{68} is expressed in °C. The temperature in the ITS-90 scale is converted in t_{68} with the equation,

$$t_{68} = 1.00024 \cdot t_{90}.$$

The values of constants are listed below:

$a_0 =$	0,0080	$b_0 =$	0,0005	$k =$	0,0162
$a_1 =$	-0,1692	$b_1 =$	-0,0056		
$a_2 =$	25,3851	$b_2 =$	-0,0066		
$a_3 =$	14,0941	$b_3 =$	-0,0375		
$a_4 =$	-7,0261	$b_4 =$	0,0636		
$a_5 =$	2,7081	$b_5 =$	-0,0144		

d. Important notes

Depending on the salinometer in use for the measurement, the procedure indicated may require some modification. It is recommended to check it, following the instructions in the instrument's instruction manual.

The formation of air bubbles in the sample during the pouring or mixing of the sample itself must be avoided. If this happens, the problem can be solved emptying and refilling the cell.

In the presence of deposits and / or air bubbles on the internal components of the measuring cell during use, washing attempts by pumping soapy water or weakly acid solutions into the cell must be avoided, because in addition to the possibility of being ineffective in solving the problem, can have a negative effect on factory calibration and instrument standardization. In the case, the cell must be repeatedly rinsed with deionized water. If the problem persists, the cell can be removed carefully, disassembled and cleaned as indicated in the instrument's instruction manual.

It is recommended to repeat the standardization procedure at least once a day with which the stability of the measuring apparatus electronics is maintained. If variations in the standardization values is observed, it is advisable to check the quality of the standard water bottle in use by repeating the operation with a new bottle. If the variations persist, it may be that the salinometer needs maintenance and needs to be sent to the service company.

The exposure to the air of standard water must be minimized.

For each sample, the time taken to obtain a valid measurement must be limited to the minimum time necessary as the minimum number of readings, avoiding that the volume used falls below the minimum necessary for the analysis.

The use of standard water bottles from the same batch for the same campaign is recommended, otherwise it is necessary to take into account the differences between batches as described by Mantyla (1987)¹¹³ to correct the final salinities. In addition, if the bottles are older than two or three years, it is recommended to compare them with fresher standards to highlight any changes in conductivity due to aging.

e. Symbol, units and precision

For the parameter described in this protocol, the symbol and unit suggested by the International System of Units (SI), as well as the expected accuracy, along with a Method identifier as provided in the Library P01 of BODC Parameter Usage Vocabulary are provided as follows:

Salinity:

Symbol: *S*

Unit: -

Precision:

Conductivity sensor: $\pm 0,01$

Method identifier:

SDN: P01::PSALBSTX Practical salinity of the water body by bench salinometer and computation using UNESCO 1983 algorithm

¹¹³ Mantyla, A.W., 1987. Standard seawater comparison. J. Phys. Oceanogr., 17: 543-548.

3. Technical note for measuring Secchi depth

Water transparency serves as an index for the trophic state of a water body. It reflects eutrophication through changes in the phytoplankton abundance; increase in the ambient nutrient status in the water leads to higher phytoplankton biomass that diminishes the propagation of light in the water. Water transparency is approached by Secchi depth (Cialdi and Secchi 1865¹¹⁴, Whipple 1899¹¹⁵). Secchi depth is influenced by dissolved and/or colloidal inorganic and organic substances as well as total suspended solids and resident seston. It is thus affected by substances unrelated to eutrophication as well.

Secchi depth relates to primary production by being a proxy for the thickness of the euphotic zone wherein the large bulk of the gross production takes place. In principle, the euphotic depth is twice Secchi depth, but this relation varies largely in practice (French et al., 1982)¹¹⁶.

Under this Technical Note, the Monitoring Guidelines for Determination of Hydrographic Physical Parameters elaborate the IMAP Protocol for measuring Secchi depth.

3.1 Protocol for measuring Secchi depth

The methodology is based on the ISO 7027-2:2019¹¹⁷ standard.

a. Equipment:

Testing disk (Secchi disk). A white disk with a diameter of 30 cm. The disk should weigh at least 1.7 kg to descend quickly and not be affected by horizontal water movements. Should the disk be lighter, an additional weight can be fastened to the down-facing side of the disk. As the observed Secchi depth tends to increase with the diameter of the disk (Aas et al., 2014)¹¹⁸, the disks of other sizes are not advised to be used.

Measuring tape/rope of non-elastic material. Depth¹¹⁹ recognition:

- colour-coded marks at 10 cm intervals. The upper side of the disk equals 0 cm. Half and full meters should be marked to be easily distinguishable.
- depth indicator of a winch.

Weight for waters with currents, fixed in the middle of the down-facing side of the disk.

Optional devices for suppression of reflections, e.g., polarized glasses for the observer.

¹¹⁴ Cialdi, M. and Secchi, P. A., 1865., Sur la transparence de la mer. Comptes Rendu de l'Académie des Sciences 61: 100–104.

¹¹⁵ Whipple, George C., 1899., The microscopy of drinking-water. New York: John Wiley & Sons. pp. 73-75.

¹¹⁶ French RH, Cooper JJ, Vigg S., 1982., Secchi disc relationships. Water Resources Bulletin 18: 121-123.

¹¹⁷ ISO 7027-2:2019 Water quality — Determination of turbidity — Part 2: Semi-quantitative methods for the assessment of transparency of waters.

¹¹⁸ Aas, E., Høkedal, J., Sørensen, K., 2014., Secchi depth in the Oslofjord–Skagerrak area: theory, experiments and relationships to other quantities. Ocean Science 10: 177–199.

¹¹⁹ Secchi depth measurement is dependent on the observer's eyesight, and any aids for vision tend to increase Secchi depth, which should be considered, e.g., in the context of long-term data series.

b. Measuring:

The observer should try to ensure that the measuring rope stays in an as upright position as possible. Deviations from the upright position stem from water currents and waves as well as ship's movement and thruster operation.

The Secchi depth is measured on the shaded side of the ship to avoid direct sunlight reflections from the water surface. However, the observer must consider the source of error in the shaded side that occurs whenever the Secchi depth stretches beyond the shade of the ship. In this case, the disk is suddenly lighted by the sun and a higher reading will be attained.

Enough time must be allowed (preferably 2 min) when looking at the disc near its extinction point for the eyes to completely adapt to the prevailing luminance level. The disc must be lowered further until it is no longer visible. The achieved depth is to be read and written down. After that, the disc is lowered by another 0.5 m. Then, during a slow elevation, the disc becomes visible as a greenish-bluish spot. The achieved depth is to be read and written down. It is recommended to repeat the test two times as a minimum. The Secchi depth is the arithmetic average of all readings.

The precision of a Secchi measurement depends on the turbidity of the water. In the waters of high turbidity, the precision can approach 0.1 m under calm seas. In clearer waters, the precision ranges from 0.2 to 0.5 m, depending on actual conditions (e.g., waving or sun glitter).

c. Important notes

Secchi depth determination is sensitive to weather conditions:

- *Waving:* Optimally, Secchi depth should be measured when the sea is relatively calm. Waving introduces a source of error in the Secchi measurement by worsening the overall visibility, and waves > 0.5 m in height obscure the identification of the actual surface. The length reading of the rope at the surface should be judged to be an average of the extreme values due to waving. The determination of Secchi depth is not meaningful in high seas.
- *Sunlight:* Secchi depth should be determined to avoid direct sunlight reflections from the water surface. Sun glitter decreases the Secchi depth estimation irrespective of optical properties of water; on the average by 12% (Aas et al., 2014).

The length markings of the rope should be checked and made clearer annually. The rope should be changed whenever it stretches > 5%.

d. Symbol, units and precision

For the parameter described in this protocol, the symbol and unit suggested by the International System of Units (SI), as well as the expected accuracy, along with a Method identifier as provided in the Library P01 of BODC Parameter Usage Vocabulary are provided as follows:

Symbol: z_{SD} **Unit:** m

Precision: 0.2-0.5 m

Method identifier: SDN:P01::SECCSDNX Visibility in the water body by Secchi disk

References

- UNEP/MAP/MED POL, 2005. Sampling and Analysis Techniques for the Eutrophication Monitoring Strategy of MED POL. MAP Technical Reports Series No. 163. UNEP/MAP, Athens, 46 pp.
- UNEP/MAP, 2019. UNEP/MED WG.467/5. IMAP Guidance Factsheets: Update for Common Indicators 13, 14, 17, 18, 20 and 21: New proposal for candidate indicators 26 and 27.
- UNEP/MAP, 2019a. UNEP/MED WG.463/6. Monitoring Protocols for IMAP Common Indicators related to pollution.
- UNEP/MAP, 2019b. UNEP/MED WG.463/10. Schemes for Quality Assurance and Control of Data related to Pollution.

Temperature and Salinity

- Forch C., Knudsen M., Sorensen S.P.L., 1902. Berichte über die Konstantenbestimmungen zur Aufstellung der hydrographischen Tabellen. Kgl. Danske Vidensk Selsk. Skrifter, 6 Raekke Naturvidensk, Mathem. Afd., 12: 1-151.
- Mantyla, A.W., 1987. Standard seawater comparison. J. Phys. Oceanogr., 17: 543-548.
- Saunders, P., 1990. The International Temperature Scale of 1990, ITS-90. Woce Newsletter, 10, IOS, Wormley, UK.
- Stalcup, M.C., 1991. Salinity measurements. In: WOCE Operational Manual WHPO 91-1, WOCE Report No 68 (<http://whpo.ucsd.edu/manuals.html>).
- UNESCO, 1981. The practical salinity scale 1978 and the international equation of seawater 1980. UNESCO Technical Papers in Marine Science, 36: 1-25.
- UNESCO, 1983. Algorithms for computation of fundamental properties of seawater. UNESCO Technical Papers in Marine Science, 44: 1-53.
- UNESCO, 1988. The acquisition, calibration and analysis of CTD data. A report of SCOR Working Group 51. UNESCO Technical Papers in Marine Science, 54: 1-59.
- UNESCO, 1994. Protocols for Joint Global Flux Study (JGOFS) Core Measurements. Manual and Guide, 29: 1-181.
- WOCE, 1991. WOCE Operational Manual WHPO 91-1, WOCE Report No68/. (<http://whpo.ucsd.edu/manuals.html>).

- Wooster W.S., Lee A.J., Dietrich G., 1969. Redefinition of salinity. Deep-Sea Res., 16: 321–322.

Secchi depth

- Aas, E., Høkedal, J., Sørensen, K., 2014., Secchi depth in the Oslofjord–Skagerrak area: theory, experiments and relationships to other quantities. Ocean Science 10: 177–199.
- Cialdi, M. and Secchi, P. A., 1865., Sur la transparence de la mer. Comptes Rendu de l'Académie des Sciences 61: 100–104.
- French RH, Cooper JJ, Vigg S., 1982., Secchi disc relationships. Water Resources Bulletin 18: 121-123.
- ISO 7027-2:2019 Water quality — Determination of turbidity — Part 2: Semi-quantitative methods for the assessment of transparency of waters
- Whipple, George C., 1899., The microscopy of drinking-water. New York: John Wiley & Sons. pp. 73-75.

Appendix 12

Monitoring Guidelines/Protocols for Determination of Hydrographic Chemical Parameters

1. Introduction

1. In this Monitoring Guidelines for Determination of Hydrographic Chemical Parameters the supporting chemical parameters dissolved oxygen and pH are elaborated. Dissolved oxygen (DO) is an essential component which determines the water quality and trophodynamics of an aquatic system. On the other hand, the pH today is important mainly due to the acidification process: when CO₂ is absorbed by seawater, a series of chemical reactions occur resulting in the increased concentration of hydrogen ions (pH). This process has far reaching implications for the ocean and the creatures that live there.

The IMAP Protocols elaborated within this Monitoring Guidelines for Determination of Hydrographic Chemical Parameters provide detail guidance on the necessary equipment, chemical reagents, analytical procedures along with appropriate methodologies for measurement of the core hydrography chemical supporting parameters, calculations, data transformation if necessary and identify weak points, including important specific notes and elaborated possible problems. However, they are not intended to be analytical training manuals, but guidelines for Mediterranean laboratories, which should be tested and accordingly modified, if need be, in order to validate their final results.

This Monitoring Guidelines builds upon the UNEP/MAP Integrated Monitoring and Assessment Programme (IMAP) respectively IMAP Guidance Fact Sheets for IMAP Common Indicators 13 and 14 (UNEP/MAP, 2019)¹²⁰; standardized protocols (UNEP/MAP, 2019a)¹²¹ and Data Quality Assurance schemes (UNEP/MAP, 2019b)¹²² in order to allow the comparability of the data and build of regional assessment schemes. They also take into account previous Sampling and Analysis Techniques for the Eutrophication Monitoring Strategy of MED POL (UNEP/MAP/MED POL, 2005)¹²³, however providing detail procedures that are of relevance for IMAP implementation. With the details of the protocols for hydrographic chemical parameters, the needs of the measurements both in offshore areas and in narrow coastal area are addressed.

In the Subchapters “Symbol, units and precision” at the end of each Protocol, for all parameters described in it, the symbol and unit suggested by the International System of Units (SI) are presented. The expected accuracy, precision and where possible the Limit of Detection (LOD) are also presented. A Method identifier is also presented as it is provided in the Library P01 of the British Oceanographic Data Centre (BODC) Parameter Usage Vocabulary respectively included in Data Dictionaries and Data Standards for eutrophication built in IMAP Pilot Info System.

The below flow diagram informs on the category of this Monitoring Guidelines related to determination of hydrographic chemical parameters within the structure of all Monitoring guidelines prepared for IMAP Common Indicators 13, 14, 17, 18 and 20.

¹²⁰ (UNEP/MAP, 2019), UNEP/MED WG.467/5. IMAP Guidance Factsheets: Update for Common Indicators 13, 14, 17, 18, 20 and 21: New proposal for candidate indicators 26 and 27.

¹²¹ (UNEP/MAP, 2019a), UNEP/MED WG.463/6. Monitoring Protocols for IMAP Common Indicators related to pollution.

¹²² (UNEP/MAP, 2019b), UNEP/MED WG.467/10. Schemes for Quality Assurance and Control of Data related to Pollution

¹²³ UNEP/MAP/MED POL, 2005. Sampling and Analysis Techniques for the Eutrophication Monitoring Strategy of MED POL. MAP Technical Reports Series No. 163. UNEP/MAP, Athens, 46 pp.

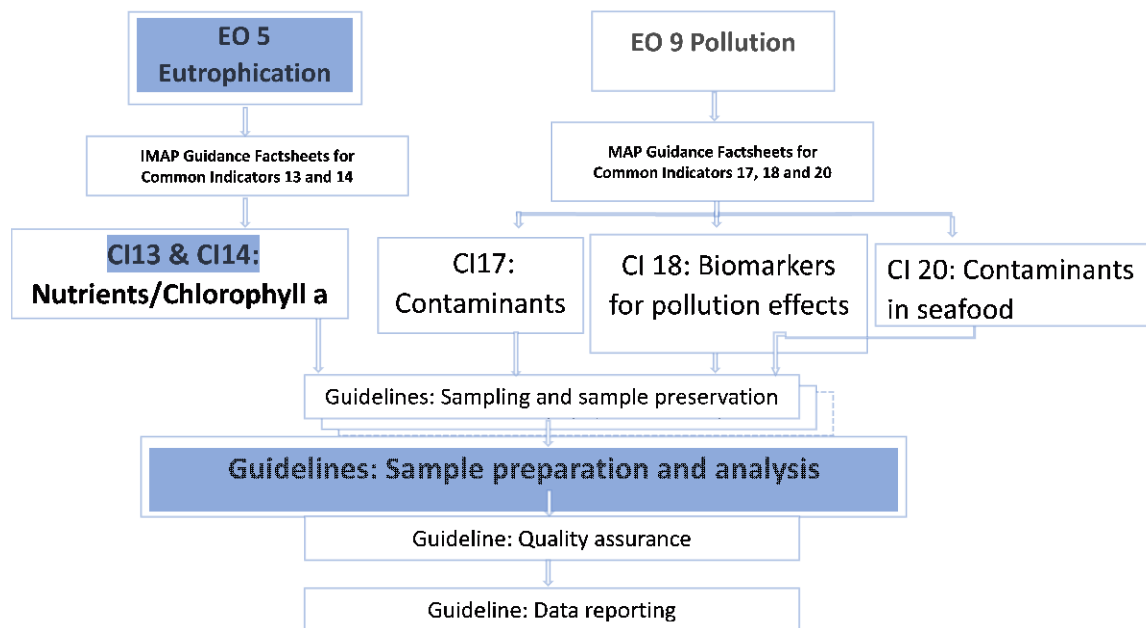

Flow Diagram: Monitoring Guidelines for IMAP Ecological Objectives 5 and 9

2. Technical note for measuring dissolved oxygen

The concentration of dissolved oxygen (DO) present in sea water depends on physico-chemical factors that determine the solubility of the gas and on biological activities (photosynthesis and respiration). Knowing temperature and salinity of the water, it is possible to trace the concentration of the theoretical dissolved oxygen which does not consider the processes of organic production and consumption. The positive (over-saturation) or negative (under-saturation) imbalance between the experimentally obtained and theoretical oxygen concentration is often used as an estimate of the processes prevalent in the water column, i.e. the prevalence of oxygen production by photo-synthetic processes, or consumption by the processes of mineralization of organic debris. From a precise determination of the DO concentration it is therefore possible to estimate the net production and respiration of the planktonic community.

Under this Technical Note, the Monitoring Guidelines for Determination of Hydrographic Chemical Parameters elaborate the Protocol for sample preparation and analysis of dissolved oxygen in seawater by Winkler method.

2.1. Protocol for sample preparation and analysis of dissolved oxygen in seawater by Winkler method

The Winkler titration method for the determination is based on the method developed by Winkler in 1888 (Winkler 1888)¹²⁴. The method has seen several modifications to encompass interferences, and the basic method today for the determination of oxygen concentration is the one prepared by Grasshoff

¹²⁴ Winkler, L.W., 1888. Die Bestimmung des in Wasser gelösten Sauerstoffes. Berichte der Deutschen Chemischen Gesellschaft, 21: 2843–2855.

(1983)¹²⁵. It is an iodometric titration, in which the amount of oxygen in the sample is determined indirectly via iodine. It is the most precise and reliable titrimetric procedure for DO analysis.

Briefly: A divalent manganese solution is added followed by strong alkali to a water sample in a glass stoppered bottle. Any DO present in the sample rapidly oxidizes an equivalent amount of the dispersed divalent manganous hydroxide precipitate to hydroxides. The sample is then acidified with H₂SO₄. In the presence of iodide ions in an acidic solution, the oxidized manganese reverts to the divalent state, with the liberation of iodine equivalent to the original DO content. The iodine is then titrated with sodium thiosulfate and starch as an indicator. For the analysis of field samples, DO analysis is best done in the field, as there is less chance for the sample to be altered by atmospheric equilibration, changes in temperature and chance of escape of gasses.

a. Sample preparation

a1. Equipment

The equipment for sample preparation of dissolved oxygen in seawater by Winkler method include:

- i) Transparent plastic tube (e.g. Tygon) to be connected to the sampling bottle taps;
- ii) 60-90 ml pyrex bottles, BOD type, with ground flute beak or rounded truncated cone cap. Each bottle must have been pre-calibrated for its closed cap volume with an accuracy of ± 0.1 ml;
- iii) Laboratory glassware;
- iv) Dispenser, automatic micropipettes or polyethylene syringes with notches every 0.5 mL;
- v) Insulated container, shielded from light;
- vi) 100 mL volumetric flasks;
- vii) 6 bottles for the determination of the reagent blank. These bottles must be selected from those with a known volume used for the withdrawal of oxygen, preferably so that they are two by two of equal volume (± 0.1 mL), and with a difference in volume between one pair and the next of 1 ± 0.1 mL.

a.2. Chemicals

The following reagents and chemicals are needed:

- i) manganese chloride [MnCl₂·4H₂O] or manganese sulphate [MnSO₄·H₂O];
- ii) sodium hydroxide [NaOH] or potassium hydroxide [KOH];
- iii) potassium iodide [KI].

a.3. Preparation of reagents

Solution of Mn₂⁺ (R1)

40 g of MnCl₂·4H₂O or 35 g of MnSO₄·H₂O is dissolved in 80 ml of reagent grade water and adjusted to volume in a 100 mL flask. The reagent, if stored in a closed bottle and not inadvertently contaminated with R2 containing iodide, is stable indefinitely.

Alkaline solution of ion I (R2)

20 g of sodium hydroxide or 30 g of potassium hydroxide is dissolved in 40 mL of reagent grade water. 60 g of potassium iodide is dissolved in 40 ml of reagent grade water. The two solutions are gradually mixed in a flask and adjusted to a final volume of 100 mL with H₂O. The solution should

¹²⁵ Grasshoff, K., 1983. Determination of oxygen. In: Grasshoff, K., Ehrhardt M., Kremling K. (eds), Methods of Seawater Analysis, Verlag Chemie, Weinheim: 61-72.

then be stored in a dark, well-capped plastic bottle. If it is not contaminated with R1 or with reducing or oxidizing agents, it is stable indefinitely.

a.4. Procedure

The sub-sampling of DO from the Niskin bottle, or similar, must be done quickly as the dissolved gas tends to balance itself with the atmosphere. This process will be further accelerated by the temperature difference existing between the sample and the environment.

For sub-sampling, the transparent plastic tube to the Niskin bottle, possibly with a diameter of no more than 5 mm and a length that can easily reach the bottom of the BOD bottles for sample collection is connected.

The bottles, previously cleaned from the residues of the previous samplings and analyzes, are rinsed with water from the sample to be analysed. To prevent the formation of a layer of supersaturated oxygen along the walls the bottles are not shaken vigorously.

The sample is allowed to flow into the bottle, checking that the filling tube is free of air bubbles and avoiding the bubbling of air in the sample. The sampling tube must touch the bottom of the bottle, which must be filled slowly by overflowing a quantity of water equal to at least half of its total volume.

The tube is slowly removed from the bottle, always letting the water flow, so that the bottle always remains full to the brim. Before adding the reagents, it is checked that no air bubbles are trapped in the bottle, otherwise the bottle is emptied, and the filling operation repeated.

In the case bottles for BOD of about 100 ml is used, 0.5 mL of R1 and 0.5 mL of R2 is added in rapid succession, using two automatic dispensers or two normal syringes equipped with a long and narrow needle in order to inject the reagents at least below the free surface of the sample, preferably at the bottom of the bottle. In the case bottles for BOD with a volume other than about 100 ml are used proportional volumes of R1 and R2 are added.

The cap is carefully inserted avoiding the formation of air bubbles between the cap and the liquid, letting excess water escape. The well capped bottle is shaken inverting it several times for at least 30 seconds.

The bottles are placed in a dark place at a temperature similar to that of sampling. After the precipitate settle for 2/3 of the volume the bottles are shaken again. To further limit the possibility of gas exchange with the environment, it is suggested to keep the cap firmly pressed on the neck of the bottle, using for example rubber bands, adhesive tape, etc.

Sampling for the determination of the reagent blank

Pre-selected bottles for blanks are sampled from the same sampling bottle, preferably not from the one relating to the surface level.

One dose of each reagent is added to the lowest volume pair of bottles, two doses to the volume greater than 1 mL and three doses to the volume greater than 2 mL. This operation must be carried out at least once during a sampling day.

a.5. Sample storage

The fixed samples should be stored in the dark and at a temperature as close as possible to that of sampling and analysed within the day of sampling.

Theoretically, the fixed samples could be kept for a longer time if there were no gaseous diffusion through the closures of the corks which unfortunately occurs, albeit to different degrees, in all bottles. In order to reduce this phenomenon, it is customary to keep the bottles, well closed, completely immersed in water of the same origin temperature as the sample.

b. Analytical procedure

b.1. Equipment in the laboratory

The equipment for analysis of dissolved oxygen in seawater by Winkler method includes:

- i) 1 L class A volumetric flasks
- ii) 1 mL or 5 mL glass or piston microburette
- iii) 5 Pyrex bottles of the same type as those used for sampling
- iv) 0.500 mL precision micropipette; 0.200 mL micropipette
- v) Fluorescent lamp with opaque screen or diffuser
- vi) Cold magnetic stirrer
- vii) Magnetic stirrers
- viii) 2 automatic dispensers or micropipettes or polyethylene syringes with notches every 0.5 mL (for oxygen reagents)
- ix) 1 mL dispenser (for concentrated sulfuric acid).

An alternative to the micro burette is:

- i) Potentiometric titrator;
- ii) Combined redox platinum electrode, semi-micro.

b.2. Chemicals

The following reagents and chemicals are needed:

- i) Sodium thiosulfate [$\text{Na}_2\text{S}_2\text{O}_3 \cdot 5\text{H}_2\text{O}$];
- ii) Potassium iodate [KIO_3], possibly ultrapure;
- iii) Sodium chloride [NaCl];
- iv) Chloroform [CHCl_3] or sodium-azide [NaN_3];
- v) Soluble starch;
- vi) Concentrated sulfuric acid, analytical grade [H_2SO_4].

b.3. Preparation of reagents

Thiosulfate solution ~ 0.1 mol L⁻¹ (or ~ 0.1 M)

24.82 g of $\text{Na}_2\text{S}_2\text{O}_3 \cdot 5\text{H}_2\text{O}$ are dissolved in 800 ml of reagent grade H_2O in a 1 L volumetric flask and adjusted to the mark. Few drops of chloroform or sodium azide are added as a stabilizer.

The solution should be stored in a dark glass bottle. Since thiosulfate is involved in numerous redox reactions, the solution is relatively unstable and therefore must be standardized against the potassium iodate solution before and after use. It is possible to use pre-stabilized commercial vials of thiosulfate solution of known titre.

KIO₃ standard solution 0.01667 mol L⁻¹ (or 0.01667 M)

About 5 g of iodate are dried in an oven at 110 °C for at least an hour and cooled in the dryer or taken directly from a stock that was once dried and stored cold in a dryer in the presence of a strong dehydrator. Exactly 3.567 g are weighted and them dissolved quantitatively in 800 mL of reagent

grade water in a 1 L volumetric flask (class A). The solution is adjusted exactly to volume at a temperature around the flask calibration (usually 20-25 ° C). Commercial iodized standard vials are also available.

The solution must then be stored in tightly capped dark glass bottles, kept away from the sun and opened for the shortest time possible only for sampling. Under these conditions the standard solution is to be considered stable for at least one year.

Stabilized colloidal starch solution (starch weld)

A saturated solution of sodium chloride by dissolving approximately 350 g of it in 1 L of distilled water in a beaker is prepared. 10 g of soluble starch in the saturated sodium chloride solution is hot dissolved.

The solution should be kept in a dark bottle and can be used until it becomes cloudy and flocculates.

b.4. Preparation of standard solutions

5 BOD bottles are filled to 3/4 of the volume at least with sea water or with distilled water and 0.5 mL of concentrated sulfuric acid, 0.5 ml of R2 and 0.5 mL of reagent R1 are added to each one in succession using the same dispensers used to "fix" the samples. It is preferable to carry out these operations under continuous stirring, allowing the complete mixing of each reagent before adding the next. The bottles can then be capped and stored in the dark until the iodate standard solution is added;

Exactly 10.00 mL of standard KIO_3 solution to each bottle using an automatic pipette are added;

The bottle is shaken a few seconds and placed in the dark for about 1 minute to allow the reaction of iodate dismutation to take place by producing molecular iodine. The standards are then titrated with the thiosulfate solution as indicated below for the samples.

b.5. Analysis of samples

Dissolution of the precipitate

The bottle number and its volume are recorded;

The cap is gently removed from the bottle containing the precipitate and placed on the switched off magnetic stirrer;

A magnetic stir bar is quickly inserted into the bottle trying to lift as little precipitate as possible, add 0.5 mL of concentrated sulfuric acid with a dispenser, the stirrer is started by adjusting its speed in order to avoid the formation of vortices and turbulence;

When the complete dissolution of the precipitate (the solution becomes a clear yellowish colour due to the presence of iodine) is achieved, as soon as possible the titration with sodium thiosulfate is performed.

Titration

The tip of the burette containing the thiosulfate solution is immersed in the bottle containing the sample or standard;

At the beginning the thiosulfate solution is added rapidly, and then the flow is slowed when the yellow colour of the sample clears and, importantly, and it is stopped before the total disappearance of the yellow colour.

When the solution is almost colourless, the lamp is turned on and about 0.2 mL of starch solution is added (an intense purple colour appears), the addition of thiosulfate is resumed slowly until the blue colour almost disappears.

After few seconds, when viewed transparently against diffuse fluorescent light, a faint dispersed colour like a cloud is displayed in the bottle. The titration is proceeded very slowly until the complete disappearance of the colour, the end point (EP) of the titration. The volume of added thiosulfate is recorded.

If an automatic titrator with combined redox / platinum electrode is used, the titration program must show a decrease in the titrant flow near the EP which will correspond to the inflection point of the titration curve.

c. Calculations

c.1. Standardization of thiosulfate (C_{tio})

The prepared KIO_3 standards are titrated with the ~ 0.1 M thiosulfate solution (see "Preparation of reagents").

The molar titre C_{tio} of the thiosulfate solution is:

$$c_{tio} = 6 * (V_{KIO_3} * c_{KIO_3}) / V_{tio}$$

where

c_{tio} = exact molar concentration (M) of the $Na_2S_2O_3 \cdot 5H_2O$ solution

V_{KIO_3} = volume in mL of injected KIO_3 standard (see "Preparation of standard solutions")

c_{KIO_3} = molar concentration (0.01667 M) of the KIO_3 standard used

V_{tio} = volume in mL of thiosulfate required to titrate the standard

The mean and standard deviation of V_{tio} in the replicates must be calculated and any value that differ by more than two standard deviations from the mean discarded. The mean and standard deviation of V_{tio} which will be used in the calculation of c_{tio} must be recalculated with the new values.

c.2. Determination of the reagent blank

The 3 pairs of bottles dedicated to the determination of the blank must be titrated and the volume of thiosulfate used noted. The concentration of DO (see "Calculation of dissolved oxygen concentration") must be calculated as if the blank (c_{bl}) were zero. The slope of the correlation line between the concentrations of DO thus obtained and the volume of R1 + R2 added corresponds to the blank of the reagents (c_{bl}).

A simpler way would be to calculate the difference between the average values for each pair of bottles and the next, but given the considerable variability in the differences this method is to be used in the alternative. This procedure allows the determination of the reagent blank, not that of the sample blank, i.e. the presence in the sample of interfering chemical substances (e.g. iodate) capable of producing elemental iodine in the acidified solution. If the desired level of accuracy required it, the blank should

also be measured for each sample, according to the procedure suggested by Tijssen and van Bennekom (1989)¹²⁶.

c.3. Calculation of the micro-molar concentration (M or $\mu\text{mol L}^{-1}$) of dissolved oxygen

The following equation applies for calculation of the micro-molar concentration (M or $\mu\text{mol L}^{-1}$) of dissolved oxygen:

$$c(\text{O}_2)/\mu\text{mol L}^{-1} = [(c_{\text{tio}} \cdot V_{\text{tio}}) / (4 \cdot (Y-y)) \cdot 10^6] - c_{\text{bl}}$$

where:

c_{tio} = exact molar concentration of the $\text{Na}_2\text{S}_2\text{O}_3 \cdot 5\text{H}_2\text{O}$ solution, from the standardization procedure

V_{tio} = volume in mL of thiosulfate required to titrate the unknown sample

c_{bl} = reagent blank (see reagent blank determination)

Y = volume in mL of the specific BOD bottle used for each sample

y = total volume, in mL, of reagents R1 + R2 added to each sample bottle (in the case shown, 1 mL)

c.4. Transformations :

The transformation of units needs to follow below provided scheme:

The next numerical equation must be used

$$c(\text{O}_2, \text{Unit A}) = c(\text{O}_2, \text{Unit B}) \cdot \text{Conversion factor}$$

Unit A	Unit B	Conversion factor
mg L^{-1}	mL L^{-1}	0.6997637
mg L^{-1}	$\mu\text{mol L}^{-1}$	0.0319988
mL L^{-1}	$\mu\text{mol L}^{-1}$	0,0223916

d. Dissolved oxygen expressed as a percentage of the saturation value

The calculation of the percentage of the saturation value can be made only by knowing the value of the oxygen solubility in the sea water sample that has been analysed. It is known that the solubility of a gas in a liquid depends not only on the properties of the solvent (composition and temperature), but also on the partial pressure exerted on the solution by the gas in question (Henry's law). The solubility value therefore corresponds to the amount of oxygen that would dissolve in water in conditions of equilibrium between the surface layer of the sea and the atmosphere above.

To determine it, reference is made to a sample in thermodynamic equilibrium with a gaseous mixture of composition equal to the standard atmosphere, at the pressure of a standard atmosphere (mole fraction of oxygen = 0.20946) and saturated with water vapor. Depending on whether the oxygen concentration is related to the unit of mass or volume of the solvent, two concentration values are obtained, called USAC (acronym for "Unit Standard Atmospheric Concentration). These values are represented by the symbols C_0^i and C_0^* according to the symbology introduced by Benson and Krause

¹²⁶ Tijssen S.B., Van Bennekom A.J., 1989. High precision determination of dissolved oxygen. ICES C.M. 1989/c:6, Annex C: 11-12.

(1980¹²⁷, 1984¹²⁸). These quantities have recently been recalculated on the basis of a more rigorous procedure introduced by the authors themselves and subsequently recommended by UNESCO (Millero, 1986)¹²⁹ to replace the values contained in the UNESCO oceanographic tables (1973)¹³⁰ which were based on the Weiss algorithms (1970)¹³¹.

The equation is the product of numerical interpolations of data obtained from equations that more rigorously calculate the needed quantities. Furthermore, it should be noted that the equation is based on the practical temperature scale of 1968 (IPTS-68) and therefore, if values measured on the basis of the ITS-90 scale are used, the appropriate conversions must be applied.

d.1. Calculations

The following equation applies for calculation of Dissolved oxygen expressed as a percentage of the saturation value:

$$\varphi(\text{O}_2/\text{O}_2^s) = 100 \cdot c(\text{O}_2)/C_0$$

where

$$\ln C_0 = a_0 + a_1/T + a_2/T^2 + a_3/T^3 + a_4/T^4 - S \cdot (b_0 + b_1/T + b_2/T^2)$$

In the equation C_0 corresponds to the concentration of the theoretical DO C_0^i and C_0^* reported per unit of volume. The constants to be inserted in the equation are:

$$\begin{aligned} a_0 &= -135.90205 \\ a_1 &= 1.575701 \cdot 10^5 \\ a_2 &= -6.642308 \cdot 10^7 \\ a_3 &= 1.243800 \cdot 10^{10} \\ a_4 &= - \\ &= 8.621949 \cdot 10^{11} \\ b_0 &= 0.017674 \\ b_1 &= -10.754 \\ b_2 &= 2140.7 \end{aligned}$$

e. Important notes

When fixing the samples contact between the reagents R1 and R2 must be avoided.

During manual titration, the same criterion for identifying the titration EP for both standards and samples must be used, best avoiding changing operator.

¹²⁷ Benson B.B., Krause D. Jr., 1980. The concentration and isotopic fractionation of gases in freshwater in equilibrium with atmosphere. *Limnol. Oceanogr.*, 25: 662-671.

¹²⁸ Benson B.B., D. Krause, Jr., 1984. The concentration and isotopic fractionation of oxygen dissolved in freshwater and seawater in equilibrium with atmosphere. *Limnol. Oceanogr.*, 29: 620-632.

¹²⁹ Millero F.J., 1986. Solubility of oxygen in seawater. *UNESCO Technical Papers in Marine Science*, 50: 13- 17.

¹³⁰ UNESCO. 1973. *International oceanographic tables*, Vol. 2. NIO-UNESCO, Paris.

¹³¹ Weiss, R.F., 1970. The solubility of nitrogen, oxygen and argon in water and seawater. *Deep-Sea Research*, 17: 721-735.

The titration must be performed quickly, decreasing the flow of thiosulfate only in the vicinity of the titration EP, in order to minimize errors due to the photo-oxidation of the iodide and the reduction of iodine by the starch.

f. Possible problems

A problem that usually occurs is the formation of bubbles in the bottle containing the sample; to prevent this phenomenon, the bottles must be washed with detergents and rinsed thoroughly.

Sometimes an air bubble is formed under the cap of the bottle containing the sample already fixed; in this case, the possible existence of an error due to the excess, however not quantifiable, of the amount of dissolved oxygen must be considered and noted.

g. Symbol, units and precision

For the parameters described in this protocol, the symbols and units suggested by the International System of Units (SI), as well as the expected accuracy, along with the Method identifiers as provided in the Library P01 of BODC Parameter Usage Vocabulary are provided as follows:

Concentration of dissolved oxygen

Symbol: $c(\text{O}_2)$ **Unit:** $\mu\text{mol L}^{-1}$

Precision: 0.1

Method identifier: SDN:P01::**DOXYWITX** Concentration of oxygen {O2 CAS 7782-44-7} per unit volume of the water body [dissolved plus reactive particulate phase] by Winkler titration

Saturation of Dissolved Oxygen

Symbol: $\varphi(\text{O}_2/\text{O}_2')$ **Unit:** % (*percent*)

Precision: 0.1

Method identifier: SDN:P01::**OXYSBW01** Saturation of oxygen {O2 CAS 7782-44-7} in the water body [dissolved plus reactive particulate phase] by Winkler titration and computation from concentration using Benson and Krause algorithm

3. Technical note for measuring pH

Since ocean acidification is a growing concern, monitoring of pH is necessary for studies of acidification and its effects on the carbonate buffer system. As many important biological processes are likely to be affected by rapid changes in pH, it is important to include accurate determination of pH among monitoring parameters.

pH is operationally defined, and several pH scales are used in environmental monitoring. The NBS (National Bureau of Standards) scale is suitable for waters of low ionic strength and used for freshwater monitoring. The total hydrogen ion scale is often used for pH determinations in oceanic waters.

pH is also used in marine environmental monitoring as a co-factor in measurements of primary production.

Two different principles for pH measurement are available, based on potentiometric and spectrophotometric detection. Potentiometric detection has the advantages of being fast and simple and requires no advanced or expensive equipment. Buffers used for calibration should ideally have an ionic strength matching that of the samples, which is challenging when an area with a large salinity gradient is monitored. Several pH meters, electrodes and buffers are commercially available.

Spectrophotometric detection is more accurate, has a higher precision, but requires expensive equipment. It is widely used in measurements under oceanic conditions, but less in estuarine waters. Since commercial applications for the spectrophotometric methods are not widely used; users must assemble instruments and software for data processing. Methods based on spectrophotometric detection are therefore not yet recommended for monitoring purposes.

Therefore, under this Technical Note, the Monitoring Guidelines for Determination of Hydrographic Chemical Parameters elaborates the two following Protocols: i) the Protocol for sample preparation and analysis of pH using a potentiometric method; and ii) the Protocol for sample preparation and analysis of pH using a spectrophotometric method.

3.1. Protocol for sample preparation and analysis of pH using a potentiometric method

pH is measured using a glass/combined electrode. The total hydrogen ion scale should be used. Temperature is measured and recorded both during pH measurement and at sampling depth.

Subsamples for pH should be drawn from sampler bottles as early as possible (after samples for oxygen and hydrogen sulphide, but before samples for nutrients and salinity) to avoid gas exchange between water and air. Samples should be collected in gas-tight bottles. Bottles should be rinsed thoroughly with sample water before filling. Bottles are filled with a laminar flow of sample water, allowing 2-3 bottle volumes to overflow before capping. Bottles should be completely filled, leaving no headspace. Avoid trapping bubbles of air when capping bottles. Samples should preferably be analysed as soon as possible directly after sampling.

Determination of pH using a glass electrode is described in ISO 10523¹³².

Temperature must be monitored and controlled during calibration of instrument and analysis, preferably by use of a tempered water bath. Make sure temperature of buffers and samples is constant (± 1 °C) during the process. To maintain constant temperature, select a bath temperature slightly above ambient temperature (for normal room temperature, set bath temperature to 25 °C – in a cooler environment 20 °C may have to be used). pH analysis can also be made in + 15 °C in a cooling bath which has been shown to produce comparable results.

pH meter should be calibrated daily when in use. Manufacturer's instructions for a 2-point calibration (pH 7 and pH 9 are recommended) are followed. NBS buffers for calibration is used. Attention to expiry dates of buffers has to be paid.

Electrode and temperature probe must be rinsed with deionized water and wiped between buffers/samples.

¹³² ISO 10523: Water quality – Determination of pH.

Electrode must be allowed to equilibrate in sample water for 15 minutes before first measurement. The best is if equilibrium is reached for each sample before recording a reading.

Open-cell measurements allow gas exchange between sample and air during the time of measurements. Closed-cell measurements eliminate the interferences.

Manufacturer's instructions must be followed for handling and storage of electrodes. Electrodes may require cleaning and conditioning when exposed to samples from intense plankton blooms. Anoxic water containing high concentration of hydrogen sulphide may shorten the life of electrodes.

A correction for in situ pH (Gieskes, 1969)¹³³ is sometimes applied. A better option is to report measured pH, temperature from pH measurement and in situ temperature.

pH values from potentiometric detection should be reported with two decimals. Temperature from measurement and sampling depth should also be reported.

Information on which pH scale is used must be included in metadata.

A detailed analytical protocol for the analysis of pH using a potentiometric method (Dickson et al, 2007)¹³⁴ is presented in the Annex I. (Guide to best practices for ocean CO₂ measurements, Ch: 4. Recommended standard operating procedure, SOP6a: Determination of the pH of sea water using a glass/reference electrode cell).

a. Quality control

Laboratories carrying out analyses of pH should have established a quality management system according to ISO 17025¹³⁵.

Data for samples for estimation of measurement uncertainty (repeated measurements from a sample, multiple subsamples from different samplers closed at same depth).

An internal reference material (IRM) should be analysed daily.

It is strongly recommended that all laboratories participate in interlaboratory comparisons and proficiency testing programs, to provide external verification of laboratory performance. Proficiency testing for pH in environmental waters are provided by e.g. SYKE. More proficiency testing schemes are listed at www.eptis.bam.de.

Validation of the adopted method needs to be performed on the relevant matrix and concentration range e.g. by taking part regularly at intercomparison studies or proficiency testing schemes.

Measurement uncertainty should be estimated using ISO 11352¹³⁶.

Estimation should be based on within - laboratory reproducibility, IRM, and, if available, data from proficiency testing and CRM.

¹³³ Gieskes, J. M., 1969. Effects of temperature on the pH of seawater. *Limnology and Oceanography* Vol 14 Issue 5, p 679-685.

¹³⁴ Dickson, A.G., Sabine, C.L. and Christian, J.R. (Eds.) 2007. *Guide to Best Practices for Ocean CO₂ Measurements*. PICES Special Publication 3, 191 pp.

¹³⁵ ISO 17025: General requirements for the competence of testing and calibration laboratories.

¹³⁶ ISO 11352: Water quality – Estimation of measurement uncertainty based on validation and quality control data.

b. Symbol, units and precision

For the parameter described in this protocol, the symbol and unit suggested by the International System of Units (SI), as well as the expected accuracy, along with a Method identifier as provided in the Library P01 of BODC Parameter Usage Vocabulary are provided as follows:

Symbol: *pH*

Unit:

Precision: $\pm 0,003$

Accuracy: -

Method identifier: SDN:P01:: **PHXXPR01** pH per unit volume of the water body by pH electrode

3.2. Protocol for sample preparation and analysis of pH using spectrophotometric method

Recently, the spectrophotometric method of measuring the pH value of seawater has been proposed, which consists in measuring the visible absorption of a coloured pH indicator added to the seawater sample. The measurement is precise, sensitive, and theoretically free from the need for calibrations (of calibration lines), but the instrumentation is more expensive and the analysis speed lower than the potentiometric method (Dickson 1993)¹³⁷. As précised before, this method is therefore not yet recommended for monitoring purposes. To compare the pH values obtained by this method with the potentiometric ones, it must be referred to the total hydrogen ion concentration pH scale.

A detailed analytical protocol for the analysis of pH using spectrophotometric method recommended by the International Scientific Community (IOC and SCOR) collected in Dickson et al., 2007 is presented in the Annex II. (Guide to best practices for ocean CO₂ measurements, Ch: 4. Recommended standard operating procedure, SOP6b: Determination of the pH of sea water using the indicator dye *m*-cresol purple).

a. Symbol, units and precision

For the parameter described in this protocol, the symbol and unit suggested by the International System of Units (SI), as well as the expected accuracy, along with a Method identifier as provided in the Library P01 of BODC Parameter Usage Vocabulary are provided as follows:

Symbol: *pH*

Unit:

Precision: 0.001

Accuracy: ± 0.005

Method identifier: SDN:P01:: **PHXXSP01** pH per unit volume of the water body by spectrophotometry

¹³⁷ Dickson, A.G.,1993. The measurement of sea water pH. Mar. Chem., 44: 131-142.

Annex I

Dickson, A.G., Sabine, C.L. and Christian, J.R. (Eds.), 2007. Ch: 4. Recommended standard operating procedure, SOP6a: Determination of the pH of sea water using a glass/reference electrode cell. In: Guide to best practices for ocean CO₂ measurements. PICES Special Publication 3, 7 pp.

Annex II

Dickson, A.G., Sabine, C.L. and Christian, J.R. (Eds.), 2007. Ch: 4. Recommended standard operating procedure, SOP6b: Determination of the pH of sea water using the indicator dyemcresol purple. In: Guide to best practices for ocean CO₂ measurements. PICES Special Publication 3, 7 pp.

References

- UNEP/MAP/MED POL, 2005. Sampling and Analysis Techniques for the Eutrophication Monitoring Strategy of MED POL. MAP Technical Reports Series No. 163. UNEP/MAP, Athens, 46 pp.
- UNEP/MAP, 2019. UNEP/MED WG.467/5. IMAP Guidance Factsheets: Update for Common Indicators 13, 14, 17, 18, 20 and 21: New proposal for candidate indicators 26 and 27.
- UNEP/MAP, 2019a. UNEP/MED WG.463/6. Monitoring Protocols for IMAP Common Indicators related to pollution.
- UNEP/MAP, 2019b. UNEP/MED WG.463/10. Schemes for Quality Assurance and Control of Data related to Pollution.

Dissolved oxygen

- Benson B.B., Krause D. Jr., 1980. The concentration and isotopic fractionation of gases in freshwater in equilibrium with atmosphere. *Limnol. Oceanogr.*, 25: 662-671.
- Benson B.B., D. Krause, Jr., 1984. The concentration and isotopic fractionation of oxygen dissolved in freshwater and seawater in equilibrium with atmosphere. *Limnol. Oceanogr.*, 29: 620-632.
- Grasshoff, K., 1983. - Determination of oxygen. In: Grasshoff, K., Ehrhardt M., Kremling K. (eds), *Methods of Seawater Analysis*, Verlag Chemie, Weinheim: 61-72.
- Millero F.J., 1986. Solubility of oxygen in seawater. *UNESCO Technical Papers in Marine Science*, 50: 13- 17.
- Tijssen S.B., Van Bennekom A.J., 1989. High precision determination of dissolved oxygen. *ICES C.M.* 1989/c:6, Annex C: 11-12.
- UNESCO. 1973. *International oceanographic tables*, Vol. 2. NIO-UNESCO, Paris.
- Weiss, R.F., 1970. The solubility of nitrogen, oxygen and argon in water and seawater. *Deep-Sea Research*, 17: 721–735.
- Winkler, L.W., 1888. Die Bestimmung des in Wasser gelösten Sauerstoffes. *Berichte der Deutschen Chemischen Gesellschaft*, 21: 2843–2855.

pH

- Dickson, A.G., 1993. The measurement of sea water pH. *Mar. Chem.*, 44: 131-142.
- Dickson, A.G., Sabine, C.L. and Christian, J.R. (Eds.) 2007. *Guide to Best Practices for Ocean CO₂ Measurements*. PICES Special Publication 3, 191 pp.
- Gieskes, J. M., 1969. Effects of temperature on the pH of seawater. *Limnology and Oceanography* Vol 14 Issue 5, p 679-685.
- ISO 10523: Water quality – Determination of pH.
- ISO 11352: Water quality – Estimation of measurement uncertainty based on validation and quality control data.
- ISO 17025: General requirements for the competence of testing and calibration laboratories.

Appendix 13

Monitoring Guidelines/Protocols for Determination of Concentration of Key nutrients in Seawater – Nitrogen Compounds

1. Introduction

1. In the Monitoring Guidelines for Key nutrients – Nitrogen compounds in Seawater, the protocols for manual and automated determination of the concentration nitrite, nitrate and ammonium are elaborated. Probably the most important property of seawater in terms of its effect on life in the marine environment is the concentration of dissolved nutrients. The most critical of these nutrients are nitrogen and phosphorus because they play a major role in stimulating primary production by plankton. These elements are known as limiting because plants cannot grow without them. At the moment, the water classification scheme on which the assessment of GES regarding Ecological Objective 5 related to eutrophication is based on chlorophyll *a* concentration as presented in details in the IMAP Guidance Factsheets (UNEP/MAP, 2019)¹³⁸, although in near future it will be complemented by those based on concentration of key nutrients in seawater.

The IMAP Protocols elaborated within this Monitoring Guidelines for Determination of Concentration of Key nutrients in Seawater – Nitrogen Compounds provide detail guidance on the necessary equipment, chemical reagents, analytical procedures along with appropriate methodologies for measurement of the concentration of nitrite, nitrate and ammonium in seawater, calculations, data transformation if necessary and identify weak points all endorsed through important notes and possible problems. However, they are not intended to be analytical training manuals, but guidelines for Mediterranean laboratories, which should be tested and accordingly modified, if need be, in order to validate their final results.

This Monitoring Guidelines builds upon the UNEP/MAP Integrated Monitoring and Assessment Programme (IMAP) respectively IMAP Guidance Fact Sheets for IMAP Common Indicators 13 and 14 (UNEP/MAP, 2019); standardized protocols (UNEP/MAP, 2019a)¹³⁹ and Data Quality Assurance schemes (UNEP/MAP, 2019b)¹⁴⁰ in order to allow the comparability of the data and build of regional assessment schemes. They also take into account previous Sampling and Analysis Techniques for the Eutrophication Monitoring Strategy of MED POL (UNEP/MAP/MED POL, 2005)¹⁴¹, however providing detail procedures that are of relevance for IMAP implementation. With the details of the protocols for determination of Key nutrients, the needs of the measurements both in offshore areas and in narrow coastal areas are addressed.

In the Subchapters “Symbol, units and precision” at the end of each Protocol, for all parameters described in it, the symbol and unit suggested by the International System of Units (SI) are presented. The expected accuracy, precision and where possible the Limit of Detection (LOD) are also presented. A Method identifier is also presented as it is provided in the Library P01 of the British Oceanographic Data Centre (BODC) Parameter Usage Vocabulary respectively included in Data Dictionaries and Data Standards for eutrophication built in IMAP Pilot Info System.

The below flow diagram informs on the category of this Monitoring Guidelines related to determination of concentration of key nutrients in seawater respectively concentration of nitrogen compounds in seawater within the structure of all Monitoring guidelines prepared for IMAP Common Indicators 13, 14, 17, 18 and 20.

e. Continuous flow methods

The principle used by the continuous segmented-flow auto-analysers (SFA) is recognized as the most reliable and accurate method for determination of nutrients. Different systems are available and can be configured to meet the standard methods such as ISO, EPA, ASTM, etc... Wherever possible it is

¹³⁸ (UNEP/MAP, 2019), UNEP/MED WG.467/5. IMAP Guidance Factsheets: Update for Common Indicators 13, 14, 17, 18, 20 and 21: New proposal for candidate indicators 26 and 27.

¹³⁹ (UNEP/MAP, 2019a), UNEP/MED WG.463/6. Monitoring Protocols for IMAP Common Indicators related to pollution.

¹⁴⁰ (UNEP/MAP, 2019b), UNEP/MED WG.467/10. Schemes for Quality Assurance and Control of Data related to Pollution

¹⁴¹ (UNEP/MAP/MED POL), 2005. Sampling and Analysis Techniques for the Eutrophication Monitoring Strategy of MED POL. MAP Technical Reports Series No. 163. UNEP/MAP, Athens, 46 pp.

strongly recommended that such analysers are used because of the considerable increase in precision and sample throughput that they offer. Ideally such analysers can be used in laboratories on board a research vessel allowing problems of sample deterioration during storage to be circumvented.

The multiplicity of methods reported in the literature is more related to the optimization of methods for different environments than a significant difference in the reactions used. In the Protocols dedicated to the individual methods, some specific aspects will be mentioned. On the general principles of SFA systems, in addition to the documentation provided by the manufacturers to the classic textbooks of Strickland and Parsons (1965)¹⁴² and Grasshoff et al. (1999)¹⁴³ can be referred. Equally numerous are the technical reports of the various laboratories produced to homogenize the methods within the programs international like JGOFS or WOCE. In the Protocols only the most essential indication on the most frequently used method will be provided. Important notes on the critical parts of the methods, for its successful performance will also be indicated.

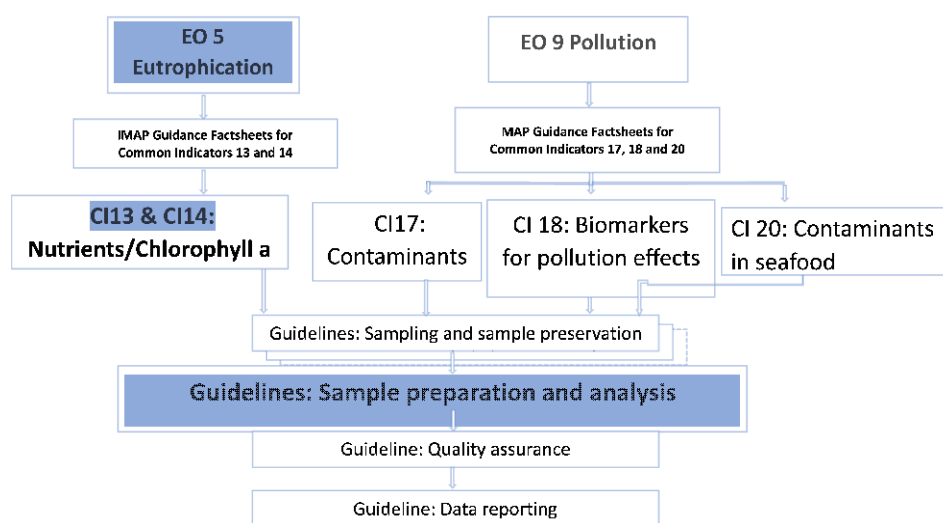

Flow Diagram: Monitoring Guidelines for IMAP Ecological Objective 5 and 9.

2. Technical note for determination of concentration of nitrite

This technical note elaborates the method for determination of concentration of nitrite that is based on a series of reactions that lead to the formation of a coloured diazo compound and measured colorimetrically. This procedure, one of the most sensitive among direct colorimetric analyses, is specific for nitrites and does not show any variation in efficiency in relation to the ionic strength of the solution. The original method, proposed by Griess-Ilosvay (Ilosvay, 1889)¹⁴⁴, was subsequently modified by Shinn (1941)¹⁴⁵ and applied to the analysis of sea water by Bendschneider and Robinson (1952)¹⁴⁶.

The analytical procedure is based on the formation, in an environment with a pH lower than 2 and a temperature not higher than 40 °C, of a diazonium salt (diazosulfanilamide chloride) which subsequently reacts with naphthylethylenediamine to generate a diazo dye.

¹⁴² Strickland J.J., Parsons T., 1965. A manual of sea water analysis: with special reference to the more common micronutrients and to particulate organic material. Fisheries Research Board of Canada, 311 pp.

¹⁴³ Grasshoff, K., Kremling, K., Ehrhardt, M. (eds), 1999. Methods of Seawater Analysis 3rd Edition Wiley-VCH Weinheim, 634 pp.

¹⁴⁴ Ilosvay L. (1889) Determination of nitrite in saliva and exhaled air. Bull. Soc. Chim. Fr., 2, 388-391.

¹⁴⁵ Shinn M.B. (1941) A colorimetric method for the determination of nitrite. Ind. Eng. Chem Anal. Ed., 13, 33-35.

¹⁴⁶ Bendschneider K., Robinson R.J. (1952) A new spectrophotometric method for the determination of nitrite in sea water. J. Mar. Res., 11, 87-96.

Under this Technical Note, this Monitoring Guidelines provides the following IMAP Protocols for the colorimetric determination of concentration of nitrite:

- Protocol for manual colorimetric determination of concentration of nitrite;
- Protocol for automated colorimetric determination of concentration of nitrite.

2.1 Protocol for manual colorimetric determination of concentration of nitrite

f. Equipment:

The equipment for manual colorimetric determination of concentration of nitrite include:

- | | |
|---|---|
| 1. graduated cylinders or 50 mL pipettes | 8. precision micropipettes to measure volumes in the range of 10-100 μ L |
| 2. 100 mL borosilicate glass containers (beaker) | 9. analytical scale |
| 3. laboratory glassware for chemical preparations | 10. stove |
| 4. 1 mL automatic dispenser | 11. microwave oven |
| 5. 500 mL volumetric flasks | 12. dryer |
| 6. volumetric flasks of 100 mL class A | 13. spectrophotometer or colorimeter sensitive to 543 nm equipped with cells of at least 50 mm optical path |
| 7. 1 L class A volumetric flask | |

g. Chemical products:

The chemical products for manual colorimetric determination of concentration of nitrite include:

- | | |
|---|---|
| 1. sulfocromic mixture | 4. <i>N</i> -(1-Naphthyl)ethylenediamine dihydrochloride [$C_{10}H_7NHCH_2CH_2NH_2 \cdot 2HCl$] |
| 2. concentrated hydrochloric acid [HCl] | 5. sodium nitrite [$NaNO_2$] |
| 3. sulfanilamide [$NH_2SO_2C_6H_4NH_2$] | 6. chloroform [$CHCl_3$] |

h. Preparation of stock solutions:

Sulfanilamide reagent

50 mL of concentrated hydrochloric acid is poured into a beaker of at least 600 mL, containing 400 mL of reagent grade water, and stirred until completely mixed. 5 g of sulfanilamide in this solution are dissolved. The volume with reagent grade water is adjusted to 500 ml. The solution is stable for many months if stored in plastic or glass containers, in the refrigerator.

NNEDDC reagent

500 mg of *N*-(1-Naphthyl) ethylenediamine dihydrochloride in 450 mL of reagent grade water is dissolved and adjusted to volume with reagent grade water in a 500 mL flask. The solution stored in the refrigerator, in dark bottles, is stable for 1-2 months and must be discarded if brown colour is developed.

Standard solution of sodium nitrite - 2 mmol L⁻¹

Few grams of sodium nitrite in an oven at 110 °C are dried and cooled in a silica gel dryer. 138 mg are weighted on an analytical balance, and in 800 mL of reagent grade water in a 1 L (class A) flask dissolved and adjusted to volume. The solution should be kept refrigerated, in a dark bottle, adding a few drops of chloroform and is stable for about a month.

i. Preparation of specific equipment for analysis:

d.1. Maintenance of reaction vessels

The reaction flasks with boiling sulfochromic mixture are periodically washed, rinsed abundantly with reagent grade water and them dried. For ordinary maintenance, after use, are rinsed with reagent grade water and placed upside down on filter paper.

j. Analytical procedure:

e.1. Reagents to be prepared at the time of use

Preparation of standard solutions

5 standards of known nitrite concentration are prepared: by diluting, in 100 mL flasks (class A), respectively 10, 25, 50, 75, 100 μL of standard solution of sodium nitrite (measured with a precision pipette) with oligotrophic seawater. The concentrations of nitrite are thus between 0.2 and 2 $\mu\text{mol L}^{-1}$ plus the nitrite content of oligotrophic seawater.

e.2. Analytical treatment

At the time of analysis, if the sample had been frozen, possibly using a 37 °C bath or in a microwave oven is quickly thawed;

The beakers with 50 mL of sample or each of the standards (measured with a graduated cylinder) are filled.

1 mL of sulfanilamide reagent to each sample or standard with a dispenser are added and the reaction allowed to take place for 5 minutes.

1 mL of NNEDDC reagent to each sample or standard with a dispenser are added and the reaction allowed to take place for additional 10 minutes.

e.3. Preparation of reagent blanks

At least two replicates of reagent blanks in the same type of 100 mL borosilicate glass container, using 50 mL of reagent grade water are prepared applying the same procedure as for samples and standards.

e.4. Spectrophotometric measurements

The absorbance of the blank ($bl_{c,i}$) of each cell of the spectrophotometer or colorimeter, used for reading against the reference cell, at 543 nm is measured, both filled with water without reagents. The operation is superfluous if only one cell is used.

For each flask, the number of the cell used, the identification of the contents of the flask (sample, standard solution, blank) are noted in a form. The cell is rinsed with part of its contents, filled and the absorbance at 543 nm read, recording the reading on the same form.

k. Calculations

The reagent blank (bl) as the average of the two blank readings is calculated.

The correlation between the absorbance values of the 5 standards and the assumed concentrations, using the Ordinary Least-Squares Regression is calculated. The colorimetric factor (f) is represented by the slope.

The concentration of nitrite in the samples is calculated with the following equation:

$$c(\text{NO}_2^-) / \mu\text{mol L}^{-1} = (\text{ABS} - \text{bl} - \text{bl}_{c,i}) f$$

where

$c(\text{NO}_2^-)$ = concentration of orthophosphates

ABS = absorbance of the sample

bl = blank of the reagents

$bl_{c,i}$ = blank of the i-th cell used

f = colorimetric factor

For a cell with a 50 mm optical path, the colorimetric factor is equal to about 4.0 $\mu\text{mol L}^{-1}$, i.e. a difference in concentration of 1 $\mu\text{mol L}^{-1}$ (for example between standard solution 3 and 5) should be the difference in absorbance of about 0.25.

l. Important notes:

The standard stock solution is renewed frequently (at least once a month).

m. Possible problems:

The suggested method is trouble- and interference-free. However, any hydrogen sulfide present in the sample must be removed before analysis (Grasshoff, 1983¹⁴⁷; Airey et al., 1984¹⁴⁸).

2.2 Protocol for automated colorimetric determination of concentration of nitrite

a. Reagents

Sulfanilamide reagent

10 g of sulfanilamide in 100 ml of concentrated HCl is dissolved and adjusted to one liter with DDW. The solution should be stored in a dark glass bottle and is stable at least 1 month.

NNEDDC reagent

1 g of *N*-(1-Naphthyl) ethylenediamine dihydrochloride in 950 mL of reagent grade water is dissolved and adjusted to volume with DDW in a 1000 mL flask. The solution stored in the refrigerator, in dark bottles, is stable for 1-2 months and must be discarded if brown colour is developed.

b. Standard

About 2 g of NaNO₂ is dried in an oven at 100 °C, checking the weight of the salt remain constant over time. The salt is placed in a silica gel dryer for additional 24 hours. 138 mg are weighted on an analytical balance, and in 800 mL of DDW in a 1 L (class A) flask dissolved and adjusted to volume. A final concentration of 2 mmol L⁻¹ is obtained. The solution should be kept refrigerated, in a dark bottle, adding a few drops of chloroform and is stable for about a month.

This standard is used in the daily procedure for the preparation of 5 standards. The concentration of the standards is chosen based on the amount of NO₂ salt expected to be found covering the entire range of expected concentrations. From the 5 standards the multiplication factor necessary to calculate the concentrations is obtained.

c. Manifold

The manifold (Fig. 1) is composed of two injectors and four coils of 10 turns each. The first injector (A) is equipped with 3 inputs: the first is for the sample, the second is for the air and the third input provided for the introduction of the first reagent. Immediately after there are 4 composite coils with 10 coils each: in the first 2 the first reagent is mixed, in the other 2 the second reagent is introduced at point (B), by means of the second injector.

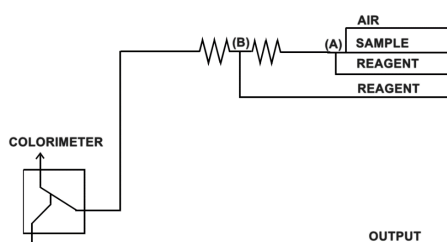

Figure 1. Manifold for nitrite measurement.

d. Important notes:

¹⁴⁷ Grasshoff, K. (1983) Determination of nitrite. In: "Methods of Seawater Analysis", Grasshoff K., M. Ehrhardt, K. Kremling Eds, Verlag Chemie, Weinheim, 139-142.

¹⁴⁸ Airey D., Dal Pont G., Sandars G. (1984) A method of determining and removing sulphide to allow the determination of sulphate, phosphate, nitrite and ammonia by conventional methods in small volumes of anoxic waters. Analytica Chim. Acta, 166, 79-92.

If an unstable baseline appears when the device is turned on in the absence of reagents, wash the circuit with 10% HCl.

If during the analysis there is an evident increase in the baseline, clean immediately the colorimeter reading cell by injecting 50% hydrochloric acid directly into the cell without stopping the circuit.

Use DDW water by deionizing it directly in the sample container of the instrument.

If it is necessary to change components of the circuit (injectors, bubblers), rebalance the circuit by changing the flow rates of the pipes.

Use suitable containers for the different reagents to be used. The container cap must be provided of small holes in which to insert capillaries (needles, etc.) for the withdrawal of the reagent.

Nutrient-poor water, i.e. oligotrophic water (OSW), as wash water between samples is used. OSW of salinity similar to the samples must be used.

e. Symbol, units and precision

For the parameter described in this protocol, the symbol and unit suggested by the International System of Units (SI), as well as the expected accuracy, along with the Method identifiers as provided in the Library P01 of BODC Parameter Usage Vocabulary are provided as follows:

Symbol: $c(\text{NO}_2^-)$	Unit: $\mu\text{mol L}^{-1}$	
Precision: ± 0.02	Accuracy: ± 0.02	LOD: 0.03
Method identifier: SDN:P01::NTRIMATX		Concentration of nitrite {NO ₂ - CAS 14797-65-0} per unit volume of the water body [dissolved plus reactive particulate phase] by manual colorimetric analysis
	SDN:P01::NTRIAAZX	Concentration of nitrite {NO ₂ - CAS 14797-65-0} per unit volume of the water body [unknown phase] by colorimetric autoanalysis

3. Technical note for determination of concentration of nitrate

The method was introduced by Morris and Riley (1963)¹⁴⁹, but only later was the dynamics of the involved reactions studied in depth (Nydhal, 1976¹⁵⁰; Grasshoff, 1983¹⁵¹). The method for the determination of nitrate (NO₃⁻) is based on its reduction to nitrite, which is then determined colorimetrically via the formation of an azo dye. It had proved to be reliable and useful for work at sea and is widely free from interferences in nearshore and oceanic waters.

The method determines the sum of nitrite and nitrate; therefore, a separate determination of nitrite must be conducted, and concentration subtracted from that obtained with this method. At concentration levels higher than about 20 $\mu\text{mol L}^{-1}$, calibration curves for a low and high range must be established.

Nitrate is reduced to nitrite in a reduction column filled with copper-coated cadmium granules. The yield of the reduction depends on the pH of the solution and on the activity of the metal surface. The conditions of the reduction described in the method are adjusted to a pH of about 8.5, so that nitrate is converted to nitrite almost quantitatively (90-95 %) and not reduced further. Ammonium chloride

¹⁴⁹ Morris A.W., Riley J.P. (1963) The determination of nitrate in sea water. *Analytica Chim. Acta*, 29, 272-279.

¹⁵⁰ Nydhal F. (1976) On the optimum conditions for the reduction of nitrate to nitrite by cadmium. *Talanta*, 23, 349-357.

¹⁵¹ Grasshoff K. (1983) Determination of nitrate. In: "Methods of Seawater Analysis", Grasshoff K., M. Ehrhardt, K. Kremling Eds, Verlag Chemie, Weinheim, 143-150.

buffer is used to control the pH and to complex the liberated cadmium ions. The nitrite formed is then determined colorimetrically (at 540 nm). The proposed method is substantially that illustrated by Grasshoff (1983).

Under this Technical Note related to determination of concentration of nitrate, this Monitoring Guidelines provides the following IMAP Protocols for the colorimetric determination of concentration of nitrate:

- Protocol for manual colorimetric determination of concentration of nitrate;
- Protocol for automated colorimetric determination of concentration of nitrate.

3.1 Protocol for manual colorimetric determination of concentration of nitrate

a. Equipment:

The equipment for manual colorimetric determination of concentration of nitrate include:

- | | |
|--|---|
| 1. graduated cylinders or 50 mL pipettes | 12. dryer |
| 2. 100 mL borosilicate glass containers (beaker) | 13. spectrophotometer or colorimeter sensitive to 543 nm equipped with cells of at least 50 mm optical path |
| 3. laboratory glassware for chemical preparations | 14. peristaltic pump with one or more channels |
| 4. 1 mL automatic dispenser | 15. reduction columns |
| 5. 1000 mL and 500 mL volumetric flasks | 16. 4-4.5 mm internal diameter tygon tube |
| 6. volumetric flasks of 100 mL class A | 17. glass wool |
| 7. 1 L class A volumetric flask | 18. pH meter |
| 8. precision micropipettes to measure volumes in the range of 10-100 μ L | 19. 0.25- and 0.42-mm mesh sieves for particle size (60 and 40 mesh) |
| 9. analytical scale | |
| 10. stove | |
| 11. microwave oven | |

b. Chemical products:

The chemical products for manual colorimetric determination of concentration of nitrate include:

1. sulfocromic mixture
2. concentrated hydrochloric acid [HCl]
3. sulfanilamide [$\text{NH}_2\text{SO}_2\text{C}_6\text{H}_4\text{NH}_2$]
4. *N*-(1-Naphthyl) ethylenediamine dihydrochloride [$\text{C}_{10}\text{H}_7\text{NHCH}_2\text{CH}_2\text{NH}_2 \cdot 2\text{HCl}$]
5. potassium nitrate 99.999% [KNO_3]
6. sodium nitrate [NaNO_2]
7. ammonium chloride [NH_4Cl]
8. ammonium hydroxide [NH_4OH]
9. granular cadmium for reactors [Cd]
10. copper sulphate pentahydrate [$\text{CuSO}_4 \cdot 5\text{H}_2\text{O}$]
11. chloroform [CHCl_3]

c. Preparation of stock solutions:

Sulfanilamide reagent

50 mL of concentrated hydrochloric acid is poured into a beaker of at least 600 mL, containing 400 mL of reagent grade water, and stirred until completely mixed. 5 g of sulfanilamide in this solution are dissolved. The volume with reagent grade water is adjusted to 500 ml. The solution is stable for many months if stored in plastic or glass containers, in the refrigerator.

NNEDDC reagent

500 mg of *N*-(1-Naphthyl)ethylenediamine dihydrochloride in 450 mL of reagent grade water is dissolved and adjusted to volume with reagent grade water in a 500 mL flask. The solution stored in the refrigerator, in dark bottles, is stable for 1-2 months and must be discarded if brown colour is developed.

Copper sulphate solution

20 g of copper sulphate pentahydrate in reagent grade water in a 1 L volumetric flask are dissolved and stored in a dark bottle. The solution is stable indefinitely.

Hydrochloric acid about 0.2 mol L⁻¹

100 mL of concentrated hydrochloric acid and 500 mL of reagent grade water are mixed in a beaker while stirring. The solution is stable indefinitely stored in a glass bottle.

Ammonium-ammonium chloride buffer

10 g of ammonium chloride for analysis in 1 L of reagent grade water in a beaker are dissolved. The pH of the solution is adjusted to 8.5 adding, drop by drop while stirring and checking the pH with a pH meter, a small quantity of ammonium hydroxide solution (about 1.5 mL should be sufficient). The buffer solution must be stored in a dark bottle and is stable for many months.

Standard solution of potassium nitrate 5 mmol L⁻¹

Few grams of potassium nitrate in an oven at 110 °C are dried and cooled in a silica gel dryer. 505.6 mg are weighted on an analytical balance, and in 800 mL of reagent grade water in a 1 L (class A) flask dissolved and adjusted to volume. The solution should be kept refrigerated, in a dark bottle, adding a few drops of chloroform and is stable for about a month.

Standard solution of sodium nitrite e 2 mmol L⁻¹

Few grams of sodium nitrite in an oven at 110 °C are dried and cooled in a silica gel dryer. 138 mg are weighted on an analytical balance, and in 800 mL of reagent grade water in a 1 L (class A) flask dissolved and adjusted to volume. The solution should be kept refrigerated, in a dark bottle, adding a few drops of chloroform and is stable for about a month.

d. Preparation of specific equipment for analysis:

d.1. Maintenance of reaction vessels

The reaction flasks with boiling sulfochromic mixture are periodically washed, rinsed abundantly with reagent grade water and them dried. For ordinary maintenance, after use, are rinsed with reagent grade water and placed upside down on filter paper.

d.2. Reduction column

The major part of the reduction column is made of a U-shaped glass tube with a total length of about 10-25 cm and an inner diameter of 3 mm. Connections to the 100 ml sample bottle and the 25 ml (marked) Erlenmeyer flask are made from flexible capillary tubing (Tygon). The sample is drawn through the column by a small peristaltic pump. For practical purpose, the whole set-up can be mounted in a box. Suitable flow rates should be determined by experimentation.

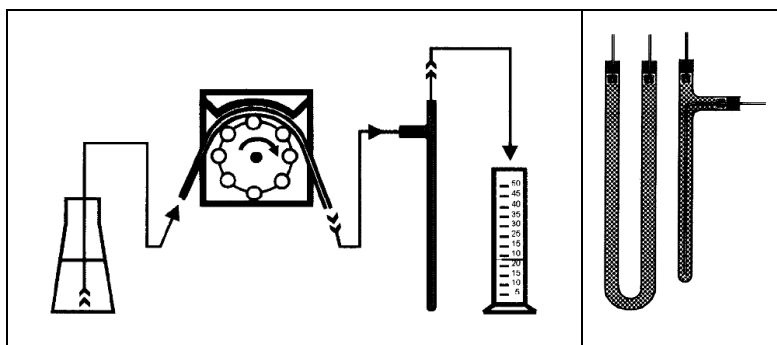

Figure 2. Reduction column for the analysis of nitrate and type of columns.

d.3. Preparation of the reduction column

Commercially available granulated cadmium (e.g. coarse powder for reductors grade - BDH) is sieved and the fraction between 40 and 60 mesh (i.e. around 0.25 and 0.42 mm) is retained and used.

The sieved cadmium granules are freed from oxides by washing them in 0.2 mol L⁻¹ hydrochloric acid. The granules in a 200 mL beaker vigorously (for about 3 minutes) with 100 mL of the copper sulphate solution are shaken. Afterwards, the copperized cadmium granules under gentle shaking are rinsed, the water decanted and washed again until the water is free from finely dispersed copper.

Cadmium is poisonous. It should, therefore, be handled with great care. The dust is never inhaled and all operations on the dry metal are performed in a fume hood.

The copperized granules are poured into the reduction column (with the aid of distilled water and a funnel). The effective packing is encouraged by gently tapping the column with a pencil. When one arm is filled, the funnel is connected to the other arm and the procedure repeated. Some space in both side arms is left in order to pack in some glass wool.

The Cd is activated by passing through about 250 mL of buffer solution (ammonium chloride) containing about 100 µmol L⁻¹ nitrate and rinsed thoroughly with buffer solution before the reducer is used for analysis.

The reduction efficiency of the reduction column is checked by analysing a nitrate standard solution of suitable concentration (e.g. equimolar). The determined absorbance is compared with that of a nitrite solution of the same concentration (e.g. if $A_{\text{NO}_3} = 0.200$, $A_{\text{NO}_2} = 0.210$, the reduction efficiency would be $(0.200 \times 100) / 0.210 = 95.2\%$).

The column is ready for use and is stable for a few months.

e. Analytical procedure:

e.1. Reagents to be prepared at the time of use

Preparation of standard solutions

5 standards of known nitrate concentration are prepared: by diluting, in 100 mL flasks (class A), respectively 10, 25, 50, 75, 100 µL of standard solution of potassium nitrate (measured with a precision pipette) with oligotrophic seawater or reagent grade water. The concentrations of nitrate are thus between 0.5 and 5 µmol L⁻¹ plus the nitrate content of oligotrophic seawater, if used for dilution.

3 standards of known nitrite concentration are prepared: by diluting, in 100 mL flasks (class A), respectively 50, 75, 100 µL of standard solution of sodium nitrite (measured with a precision pipette) with oligotrophic seawater or reagent grade water. The concentrations of nitrate are thus between 1 and 2 µmol L⁻¹ plus the nitrite content of oligotrophic seawater, if used for dilution.

e.2. Analytical treatment

At the time of analysis, if the sample had been frozen, possibly using a 37 °C bath or in a microwave oven is quickly thawed;

The 100 mL beakers with 50 mL of sample or each of the standards (measured with a graduated cylinder) are filled.

50 mL of ammonium buffer (measured with a graduated cylinder) are added and mixed well.

The end of the capillary tube is inserted in the beaker containing the first sample to be analyzed.

The peristaltic pump is adjusted in such a way to ensure a flow rate between 2.5- and 3-mL min⁻¹ and started allowing the sample to pass through the reduction column. The first 25 mL of sample is discarded.

The next 25 mL is collected and transferred in a 50 mL flask or beaker.

The other samples to be analysed, the nitrate standards and the nitrite standards is passed through the system, interrupting the operation of the peristaltic pump between each operation

After passing the last sample, the reduction column is washed with 50 mL of ammonium buffer and always kept completely full of buffer.

With a graduated cylinder for of each of the nitrite standards a substandard is prepared: 12.5 mL of standard and 12.5 mL of ammonium buffer is added to a beaker and properly mixed. The preparation of these standards, which have not passed through the reduction column, is necessary to verify the degree of transformation of nitrite to compounds with a lower oxidation number, independently of the degree of efficiency of the column, except for impurities of nitrate present in the nitrite standard.

1 mL of sulfanilamide reagent to each flask containing the samples and the three series of standards (nitrates, nitrites and nitrites not passed through the reduction column) with a dispenser are added and the reaction allowed to take place for 5 minutes.

1 mL of NNEDDC reagent to each sample or standard with a dispenser are added and the reaction allowed to take place for 10 minutes.

e.3. Preparation of reagent blanks

At least two replicates of reagent blanks in the same type of 100 mL borosilicate glass container, using 50 mL of reagent grade water are prepared applying the same procedure as for samples and standards, including the passage through the reduction column.

e.4. Spectrophotometric measurements

The absorbance of the blank ($bl_{c,i}$) of each cell of the spectrophotometer or colorimeter, used for reading against the reference cell, at 543 nm is measured, both filled with water without reagents. The operation is superfluous if only one cell is used.

For each flask, the number of the cell used, the identification of the contents of the flask (sample, standard solution, blank) are noted in a form. The cell is rinsed with part of its contents, filled and the absorbance at 543 nm read, recording the reading on the same form.

The reading of the blanks is affected by a small error due to the different matrix used, but it is usually negligible as it is related only to the nitrate impurities in the ammonium buffer.

f. Calculations

The reagent blank (bl) as the average of the two blank readings is calculated.

The correlation between the absorbance values of the three series of standards and the assumed concentrations, using the Ordinary Least-Squares Regression is calculated. The colorimetric factor for the nitrates (f_1), for the nitrites (f_2) and for the nitrites not passed on the reduction column (f_3) is represented by the slopes.

The efficiency of the column for the reduction of nitrate and for the preservation of the nitrite present in the sample is indicated by the ratios f_1/f_2 and f_2/f_3 . If the reduction efficiency is unsatisfactory (<90%), the length of the column must be increased, while this must be decreased if the nitrite yield is less than 95%.

The concentration of nitrate in the samples is calculated with the following equation:

$$c(\text{NO}_3^-) / \mu\text{mol L}^{-1} = (\text{ABS} - \text{bl} - \text{bl}_{e,i}) - c(\text{NO}_2^-) / f_2 \cdot f_1$$

where

$c(\text{NO}_3^-)$ = concentration of nitrate

$c(\text{NO}_2^-)$ = concentration of nitrite in the sample (independently derived)

ABS = absorbance of the sample

bl = blank of the reagents

$\text{bl}_{e,i}$ = blank of the i-th cell used

f_1 = colorimetric factor of nitrate

f_2 = colorimetric factor of nitrite

For a cell with a 50 mm optical path, the colorimetric factor of nitrate is equal to about $8.0 \mu\text{mol L}^{-1}$, i.e. a difference in concentration of $2 \mu\text{mol L}^{-1}$ (for example between standard solution 1 and 3) should be the difference in absorbance of about 0.25.

g. Important notes

Before carrying out the analysis, the characteristics of the column must be carefully checked. If air bubbles enter the column, it is preferable to empty them and repack, as the retention time becomes variable following the progressive expulsion of air. Alternatively, the buffer solution can be allowed to pass through the column for about 20-30 minutes, to expel most of the air. In both cases it is necessary to pass through the column at least a series of standards to verify any variations in the yield of the reduction.

The determination of the factor f_2 is superfluous when the nitrite concentrations turn out to be of an order of magnitude lower than those of nitrates. In this case it is enough to calculate the colorimetric factor f_1 and subtract the nitrite concentration from the values obtained.

If a large number of samples are to be analysed, the efficiency of the reduction column during the analysis must be checked periodically.

h. Possible problems

The suggested method is trouble- and interference-free. However, Hydrogen sulphide, hardly present in samples containing nitrate, can be precipitated as copper or cadmium sulphide (Grasshoff, 1983).

The efficiency of the column can be reduced if concentrations of phosphates higher than $2 \mu\text{mol L}^{-1}$ are present (Olsen, 1980)¹⁵².

¹⁵² Olsen R.J. (1980) Phosphate interference in the cadmium reduction (1980) analysis of nitrate. *Limnol. Oceanogr.*, 25, 758-760.

3.2 Protocol for automated colorimetric determination of concentration of nitrate

a. Reagents

Buffer

10 g of ammonium chloride dissolved in 700 mL of DDW, and then brought to the volume of one liter must be prepared. To the solution must be added 1 mL of Brij and sodium hydroxide in a percentage such as to bring the pH of the solution to a value of 8.5. The solution is very stable.

Sulfanilamide

10 g of sulfanilamide in 100 mL of concentrated HCl are dissolved and adjusted to 1 L with DDW. The solution should be stored in a brown glass bottle and is stable for at least one month.

Ethylenediamine dihydrochloride

1 g of Ethylenediamine dihydrochloride is dissolved in 1 L of DDW. The solution should be stored in a dark glass bottle and is stable for at least one month.

b. Standard

51. Few grams of potassium nitrate in an oven at 110 °C are dried and cooled in a silica gel dryer. 505.6 mg are weighted on an analytical balance, and in 800 mL of DDW in a 1 L (class A) flask dissolved and adjusted to volume. The solution should be kept refrigerated, in a dark bottle, adding a few drops of chloroform and is stable for about a month. This standard is used in the daily procedure for the preparation of 5 lower concentration standards.

The concentration of the minor standards is chosen based on the amount of NO_3^- salts expected to be found, so that the set of sub-standards covers the entire range of expected concentrations. From the 5 standards a multiplication factor is obtained which is necessary to calculate the concentrations.

c. Reducer

The reducer is composed of a 20 cm long Pyrex glass tube with an internal diameter of 2 mm and U-bent.

Cadmium granules previously prepared according to the procedure described below are inserted into the tube.

Some granular cadmium are sieved to obtain a fraction of granules between 0.42 and 0.60 mm, then washed with 10% HCl and with DDW at the end. 2 g of copper sulphate are dissolved in 100 mL of DDW. The cadmium is immersed in the solution and shaken until the colour disappears. The cadmium is washed until the total elimination of colloidal copper bound to cadmium, silvery colour of the grains. The glass tube is filed with DDW and the granules inserted from the flask with a Pasteur pipette. Once the reducer has been filled, glass wool at the ends is inserted, to prevent cadmium to escape.

There are alternatives to the use of granular cadmium such as the use of cadmium coils or with internal walls covered with cadmium or the use of polyethylene coils with a cadmium wire inside. In all cases, the activation of cadmium with the copper sulphate solution is necessary in some procedures, copper sulphate is added continuously with the buffer.

d. Manifold

The manifold (Figure 3) is built of three injectors and five coils, one with 5 turns and four with 10 turns, and a reducer. The first injector (A) is equipped with three inputs: the first is for the sample, the second is for air bubbles and with the third input the first reagent is introduced. Immediately after, a coil made up of 5 turns in which the liquid is mixed with the buffer, is located. At the end of the coil a de-bubbler, which has the function of eliminating the bubble from the circuit to prevent air from entering the reducer that is connected to the bubbler itself at point (B), is present. At point (C) after the reducer, the second injector equipped with three inputs can be found: The first for the sample to be

reduced from NO_3^- to NO_2^- , the second to restore the air bubbles and with the third the second reagent is introduced. Immediately after 4 coils made up of 10 coils each can be found: in the first 2 the mixing with the second reagent takes place, in the other 2 is where the third reagent at point (D) is injected.

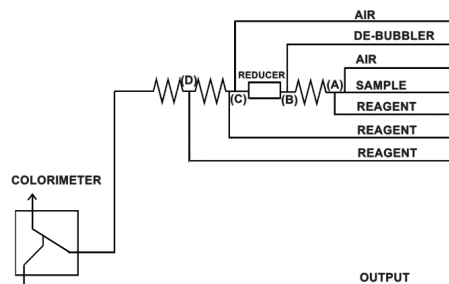

Figure 3. Manifold for nitrate measurement.

e. Important notes

Air passage through the reducer is not allowed.

The efficiency of the reducer is checked by comparing the nitrate standard with that of the nitrites according to the next methodology: 1) Two nitrate standards are prepared: one at a concentration of $5 \mu\text{mol L}^{-1}$, the other at $10 \mu\text{mol L}^{-1}$. The doubling of the concentration must correspond to an effective doubling of the reading. 2) Two nitrate standards of the same concentration of $5 \mu\text{mol L}^{-1}$ are prepared. The two standards are run in the same circuit prepared for nitrates and that they give the same reading value must be checked; to ensure that there has not been a reduction in the concentration of nitrites in the cadmium column.

The air bubbles point of the circuit must be adjusted each time the reducer is replaced by acting on the flow rates of the pipes.

The reducer by passing a standard of NO_3^- with a concentration of $25 \mu\text{mol dm}^{-3}$ through the circuit each time it is replaced must be activated.

If an unstable baseline is observed when the appliance is turned on in the absence of reagents, the circuit with 10% HCl must be washed.

If during the analysis an evident increase in the baseline is observed, the colorimeter reading cell by injecting 50% hydrochloric acid directly into the cell without stopping the circuit must be immediately cleaned.

The DDW is deionized if possible, directly in the water container of the instrument.

If a change of components of the circuit (injectors, bubblers) is necessary, the circuit by changing the flow rates of the pipes must be rebalanced.

Suitable containers for the different reagents must be used. The cap of the container must be provided with small holes in which to insert capillaries (needles, etc.) for the withdrawal of the reagent.

When mixed standards are used, NO_3^- standards with either NH_4^+ or NO_2^- standards never must be combined.

Water poor in nutrients, or oligotrophic water (OSW), as washing water between one sample and another must be used. OSW with salinity values similar to the sample to be analysed must be used.

The NO_2^- standard, passed through the nitrate reduction column must have the same reading value as the NO_2^- standard analysed in the nitrite circuit.

Since the concentration of nitrates is determined after their reduction to nitrites: The copper cadmium does not have a reduction efficiency of 100% and in certain conditions it also reduces nitrite.

Therefore, if it were necessary to discriminate the two ions, the efficiency of the reducer should be accurately determined both for nitrite with a solution with a concentration of nitrite only and for nitrate with a solution with a known concentration of nitrate only.

For the parameter described in this protocol, the symbol and unit suggested by the International System of Units (SI), as well as the expected accuracy, along with the Method identifiers as provided in the Library P01 of BODC Parameter Usage Vocabulary are provided as follows:

Symbol: $c(\text{NO}_3^-)$	Unit: $\mu\text{mol L}^{-1}$	
Precision: ± 0.02	Accuracy: ± 0.02	LOD: 0.03
Method identifier: SDN:P01::NTRAMADZ		Concentration of nitrate {NO ₃ - CAS 14797-55-8} per unit volume of the water body [dissolved plus reactive particulate <unknown phase] by filtration and manual colorimetric analysis and correction for nitrite
	SDN:P01::CHEMM012	Concentration of nitrate {NO ₃ - CAS 14797-55-8} per unit volume of the water body [dissolved plus reactive particulate phase] by colorimetric autoanalysis and correction for nitrite

4 Technical note for determination of concentration of ammonium

The determination of concentration of ammonium is based on a series of photochemically catalysed reactions that lead to the formation of indophenol blue. The concentration of the compound is then measured colorimetrically. The first analytical application of the formation of indophenol from phenol and hypochlorite was performed by Berthelot (1859)¹⁵³.

The formation of monochloramine predominates, compared to that of di- and trichloramine, for pH values higher than 7.5. The next stage of the reaction consists in the attack of monochloramine on the benzene ring of the phenol to form, probably, chloraminoquinone. Finally, quinone, or in any case the intermediate formed, produces indophenol by copulation with another phenol. This stage is strictly pH dependent, as OH⁻ enters directly into the reaction. For this reason, all methods that use phenol and hypochlorite require an environment with a pH of around 10.5 (Ivancic and Degobbis, 1984)¹⁵⁴.

Finally, given the importance of pH control in the development of the reaction (Sasaki and Sawada, 1980)¹⁵⁵, the significant salt effect (different yield of the reaction in fresh or salt water) that occurs in this method (Koroleff, 1983)¹⁵⁶ largely depends on the buffer capacity of the sample matrix. For this reason, the method can be applied to samples collected in estuarine environments, where the variations in alkalinity are strong, by adequately buffering the solution (Mantoura and Woodward, 1983)¹⁵⁷.

The procedure outlined here, mainly follows the methods described by Grasshoff and Johansen (1973)¹⁵⁸ and by Koroleff (1983) as described by Hansen and Koroleff (1999)¹⁵⁹ and is adapted to this manual from the previous one (UNEP/MAP/MED POL, 2005).

¹⁵³ Berthelot, M.P. (1859) *Repertoire de Chemie Appliquée*, pp. 284.

¹⁵⁴ Ivancic I., Degobbis D. (1984) An optimal manual procedure for ammonia analysis in natural waters by indophenol blue method. *Water Res.*, 18, 1143-1147.

¹⁵⁵ Sasaki K., Sawada Y. (1980) Determination of ammonia in estuary. *Bull. Jap. Soc. Sci. Fish.*, 46, 319-321.

¹⁵⁶ Koroleff F. (1983) Determination of ammonia. In: "Methods of seawater analysis", Grasshoff K., M. Ehrhardt, K. Kremfing Eds, Verlag Chemie, Weinheim, 150-175.

¹⁵⁷ Mantoura R.F.C., Woodward E.M.S. (1983) Optimization of the indophenol blue method for the automated determination of ammonia in estuarine water. *Eustar. Coast. Shelf, Sci.*, 17, 219-229.

¹⁵⁸ Grasshoff K., Johannsen H. (1972) A new automatic and direct method for the automatic determination of ammonia in sea water. *J. Cons. Int. Explor. Mer*, 34, 516-521.

¹⁵⁹ Hansen H.P., Koroleff, F. (1999) Determination of nutrients. In *Methods of Seawater Analysis*. K. Grasshoff, K. Kremfing and M. Ehrhardt (eds) 3rd Edition Wiley-VCH Weinheim pp159-228.

Under this Technical Note for determination of concentration of ammonium, this Monitoring Guidelines provides the following IMAP Protocols for the colorimetric determination of concentration of ammonium:

- Protocol for manual colorimetric determination of concentration of ammonium;
- Protocol for automated colorimetric determination of concentration of ammonium.

4.1 Protocol for manual colorimetric determination of concentration of ammonium

a. Equipment:

The equipment for manual colorimetric determination of concentration of nitrate include:

1. graduated cylinders or 50 mL pipettes
2. 100 mL borosilicate glass containers (beaker)
3. laboratory glassware for chemical preparations
4. 1 mL automatic dispenser
5. 1000 mL and 500 mL volumetric flasks
6. volumetric flasks of 100 mL class A
7. 1 L class A volumetric flask
8. precision micropipettes to measure volumes in the range of 10-100 μ L
9. analytical scale
10. stove
11. microwave oven
12. dryer
13. spectrophotometer or colorimeter sensitive to 543 nm equipped with cells of at least 50 mm optical path, preferable 100 mm

b. Chemical products:

1. The chemical products for manual colorimetric determination of concentration of nitrate include: sulfocromic mixture
2. concentrated hydrochloric acid [HCl]
3. Sodium hydroxide [NaOH]
4. Potassium persulfate [$K_2S_2O_8$]
5. phenol [C_6H_5OH]
6. disodium EDTA [$C_{10}H_{14}N_2Na_2O_8$]
7. sodium dichloroisocyanuric acid [$C_3HCl_2N_3NaO_3$]
8. sodium nitroprusside dihydrate [$Na_2Fe(CN)_5NO \cdot 2H_2O$]
9. trisodium citrate dihydrate [$C_6H_5Na_3O_7 \cdot 2H_2O$]
10. ammonium chloride [NH_4Cl]
11. ammonium hydroxide [NH_4OH]
12. chloroform [$CHCl_3$]

c. Preparation of stock solutions:

“Ammonia-free” water

There is no standard procedure for the preparation of water with very low ammonia content. De-ionized water may sometimes be used without subsequent distillation, but it must be noticed that ion exchange resins potentially bleed out organic substances and ammonia. In case the ammonia blank concentrations are higher than $0.3 \mu\text{mol L}^{-1}$, the water should be subjected to subsequent distillation. In this second step, 0.3 g NaOH and 1 g $K_2S_2O_8$ are added to 1000 mL of water (in a 2 L flask). The solution should be boiled for 10 minutes to remove ammonia (without the condenser) and then distilled until a residue of about 150 mL. The distilled water should be stored in a tightly sealed container, preferably made of glass. The method of preparation of ammonia-free water should be regularly checked and appropriate blanks must be analysed with every batch of samples. As an alternative, “open sea surface water” can be used as “ammonia-free” water.

Buffer solution

240 g trisodium citrate dihydrate ($C_6H_5Na_3O_7 \cdot 2H_2O$), 20 g of disodium EDTA ($C_{10}H_{14}N_2Na_2O_8$) and 0.4 g NaOH in about 600 ml distilled water are dissolved. The solution is boiled (to remove ammonia) until the volume is below 500 mL. It is then cooled and diluted to 500 mL with “ammonia-free” water. The solution is stable and should be stored in a well-stoppered polyethylene bottle.

Phenol reagent

80 g colourless phenol (C_6H_5OH) is dissolved in 300 mL of ethanol, added 600 mL of distilled water and 600 mg of sodium nitroprusside dihydrate ($Na_2Fe(CN)_5NO \cdot 2H_2O$) in “ammonia-free” water and diluted to 1000 ml. When stored in a tightly closed dark bottle and in a refrigerator, the solution should be stable for several months. **Phenol is a particularly toxic compound and safety glasses and gloves should be worn and all handling conducted in a fume cupboard.**

Hypochlorite reagent

1 g of sodium dichloroisocyanuric acid ($C_3HCl_2N_3NaO_3$; dichloro-s-triazine-2, 3, 6 (1H, 3H, 5H)-trione) and 8 g NaOH in “ammonia-free” water are dissolved and diluted to 500 mL. The sodium dichloroisocyanuric acid is employed as a hypochlorite donor (in comparison to generally used commercial hypochlorite solutions) has the advantage of being a stable solid, and that it is easy to prepare. The solution should be stored in a dark bottle in a refrigerator and is stable for at least a week.

Ammonia stock solution (A) (10 mmol L⁻¹ NH₃)

Ammonium chloride (NH_4Cl) is dried at 100 °C to constant weight. Then dissolve 0.0535 g NH_4Cl in “ammonia-free” water and dilute to 100 mL in a volumetric flask. When kept in a glass bottle (protected from sunlight) and in a refrigerator, the solution should be stable for at least several weeks.

Ammonia working solution (B) (100 μmol L⁻¹ NH₃)

Exactly 10.0 ml of the stock solution is diluted with “ammonia-free” water to a final volume of 1000 ml in a volumetric flask made of glass.

*d. Preparation of specific equipment for analysis:**d.1. Treatment of reaction vessels*

All flasks and tubes to be used should be cleaned with hot HCl, rinsed well with “ammonia-free” water and kept closed between analyses. The analysis should be performed in a well-ventilated room with no ammoniacal solutions stored (**Note:** this should include any cleaning agents containing ammonia and used by laboratory cleaning staff during or outside normal working hours). This includes the NH_4Cl reagent used for nitrate analysis. **Smoking should be forbidden.**

Alternative: Before use, all flasks should be treated by performing the reaction in them with the addition of chemical reagents to the “ammonia-free water” or “open sea surface water”. The reaction should proceed at least for 6 hours and the flasks should be shaken time to time during the reaction period. Later, the flask should be rinsed with ammonia-free water and kept stoppered when not in use. The flasks should not be washed between the analysis of different sets of samples/standards, but just rinsed with “ammonia-free” water and kept closed.

*e. Analytical procedure:**e.1. Reagents to be prepared at the time of use**Preparation of standard solutions*

7 standards of known ammonia concentration are prepared: by diluting, in 100 mL flasks (class A), respectively 0.5, 1, 2, 3, 5, 7 and 10 mL of Ammonia working solution (B) (measured with a precision pipette) with “ammonia-free” water or “open sea surface water” and filled to the 100 mL mark. The concentrations of ammonia are thus between 0.5 and 10 μmol L⁻¹. In this instance, it is probably best not to use low nutrient seawater unless it is known to have a suitably low ammonia concentration.

e.2. Analytical treatment

At the time of analysis, if the sample had been frozen, possibly using a 37 °C bath or a microwave oven is quickly thawed.

The flasks with an aliquot of samples or standard solutions of different concentrations are pre-rinsed.

The flasks with 50 mL of sample or each of the standard (measured with a graduated cylinder) are filled.

2 ml phenol reagent, 1 ml buffer solution and 2 ml hypochlorite reagent are added. The solution is mixed by swirling between the additions. The reaction bottles are closed properly and kept in a dark place during the reaction time which is at least 6 hours at room temperature, but which is reduced to 30 minutes if the samples are incubated in a water bath at 37 °C ± 1 °C. Note that standards and samples of the same series must be treated simultaneously, and in the same way.

e.3. Preparation of reagent blanks

One 100 mL flask is filled with 50 mL and one with 47,5 mL of distilled water or “open sea surface water”

To the first 2 ml phenol reagent, 1 ml buffer solution and 2 ml hypochlorite reagent are added and to the other 3 ml phenol reagent, 1.5 ml buffer solution and 3 ml hypochlorite reagent. The solutions are mixed by swirling between the additions. The reaction bottles are closed properly and kept in a dark place during the reaction time as for samples and standards.

e.4. Spectrophotometric measurements

The absorbance of the blank ($bl_{c,i}$) of each cell of the spectrophotometer or colorimeter, used for reading against the reference cell, at 630 nm is measured, both filled with water without reagents. The operation is superfluous if only one cell is used.

For each flask, the number of the cell used, the identification of the contents of the flask (sample, standard, blank) are noted in a form. The cell is rinsed with part of its contents, filled and the absorbance at 630 nm read, recording the reading on the same form.

f. Calculations:

The reagent blank (bl) as the average difference between the values of the two blanks is calculated.

The correlation between the absorbance values of the 7 standards and the assumed concentrations, using the Ordinary Least-Squares Regression is calculated. The colorimetric factor (f) is represented by the slope, covering a concentration range 0.5 to 10 $\mu\text{mol L}^{-1}$.

The concentration of ammonia in the samples is calculated with the following equation:

$$c(\text{NH}_4) / \mu\text{mol L}^{-1} = (\text{ABS} - \text{bl} - bl_{c,i}) f$$

where

$c(\text{NH}_4)$ = concentration of ammonia

ABS = absorbance of the sample

bl = blank of the reagents

$bl_{c,i}$ = blank of the i-th cell used

f = colorimetric factor

As already mentioned, for any given concentration of ammonium the blue color produced in seawater is less intensive than in distilled water. Thus, for each sample a correction must be made with respect to its salinity and the resulting pH. In many circumstances a simple correction (Hansen and Koroleff, 1999) may be used where the correction is given by:

$$c(\text{NH}_4)_{\text{corr}} / \mu\text{mol L}^{-1} = [1 + 0.0073 S_s] c(\text{NH}_4)_{\text{uncorr}}$$

where

S_s = salinity of the sample.

g. Important notes:

The method is very sensitive to the effects of a possible contamination of the glassware or reagents; therefore, it is recommended to strictly follow the instructions given for washing the glassware and to use the recommended chemical products.

It is essential to ensure that the work environment is smoke-free and that there are no reactants in the vicinity that can release ammonia.

h. Possible problems:

Interferences from amino acids and urea (at seawater levels) can be neglected but may be significant in estuarine or brackish waters, especially where these are contaminated with urban waste.

Hydrogen sulphide can be tolerated up to about $60 \mu\text{mol L}^{-1}$. Samples with higher H_2S concentrations should be diluted.

The blue colour of the indophenol, however, is influenced by salinity, which must be compensated by the application of a salt factor (see above).

4.2 Protocol for automated colorimetric determination of concentration of ammonium

a. Reagents

Buffer

The buffer is composed of 120 g of trisodiocitrate, dissolved in 500 mL DDW, and adjusted to 1L. Sodium hydroxide must be added to this solution in a percentage such as to bring the pH of the solution to a value of 11. This reagent must be stored in a glass bottle and is very stable.

Phenol reagent

35 g of phenol and 0.40 g of sodium dichloroisocyanuric acid are dissolved in 800 mL of DDW and adjusted to 1000 mL. This reagent is stable for 24 hours.

Hypochlorite reagent

5 g of sodium hydroxide and 1 g of dichloroisocyanurate are dissolved in 400 mL of DDW and adjusted to 500 mL. This reagent must be stored in a glass bottle at a temperature of $+4^\circ\text{C}$ and is stable for a week.

b. Standards

About 2 g of ammonium chloride is dried in an oven at a temperature of 100°C to constant weight and then placed in a silica gel dryer for another 24 hours. The ammonium chloride is dissolved in DDW in such a proportion as to obtain a concentration of 2 mmol L^{-1} . This standard is used in the daily procedure for the preparation of 5 lower concentration standards.

The concentration of the minor standards is chosen based on the amount of NH_4^+ salts that are expected to be found, so that the set of sub-standards covers the entire range of expected concentrations. From the 5 standards a multiplication factor is obtained which is necessary to calculate the concentrations.

c. Manifold

The manifold (Fig. 4) is built of three injectors, three coils of 10 turns each, a thermostatic bath and a trap containing 10% hydrochloric acid. The first injector (A) is equipped with 3 inputs: the first is for the sample, the second for air bubbles, by which the liquid is divided into many equal segments and with the third input the first reagent is introduced. Immediately after, there are 2 coils made up of 10 coils each: in the first the liquid is mixed with the buffer; in the second at point (B) the second reagent is injected. At point (C) the third reagent is injected. To accelerate the blue production of indophenol, the solution is passed through a coil immersed in a thermostated bath (D) at a temperature of 75 °C. At the exit of the bath, at point (E) the solution is cooled passing through the last coil. The air for producing the air bubbles is introduced into the circuit through a trap (F) containing 10% HCl. This measure must be adopted to ensure that any ammonia vapours contained in the laboratory air are eliminated

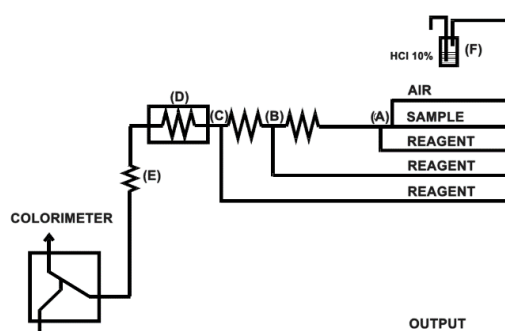

Figure 4. Manifold for ammonium measurement.

a. Important notes

The base line must be stable and if any fluctuations as if even small variations are noted it would mean that flocculate has formed in the sample caused by the phenol that is no longer stable:

The reagents one at a time, in strict order from the first to the third must be inserted;

The circuit must be washed with the progressive elimination of the reagents from the third to the first;

If precipitate is observed to form near the hypochlorite injector the circuit is probably dirty or the buffer inefficient;

If an unstable baseline is observed when the appliance is turned on in the absence of reagents, the circuit with 10% HCl must be washed;

If during the analysis an evident increase in the baseline is observed, the colorimeter reading cell by injecting 50% hydrochloric acid directly into the cell without stopping the circuit must be immediately cleaned;

The DDW is deionized if possible, directly in the water container of the instrument;

If the ambient temperature is higher than + 20 °C a heat sink to the cooling coil must be installed;

If a change of components of the circuit (injectors, bubblers) is necessary, the circuit by changing the flow rates of the pipes must be rebalanced;

Suitable containers for the different reagents must be used. The cap of the container must be provided with small holes in which to insert capillaries (needles, etc.) for the withdrawal of the reagent;

When mixed standards are used, NO_3^- standards with either NH_4^+ or NO_2^- standards never must be combined;

Water poor in nutrients, or oligotrophic water (OSW), as washing water between one sample and another must be used. OSW with salinity values similar to the sample to be analysed must be used.

a. Symbol, units and precision

For the parameter described in this protocol, the symbol and unit suggested by the International System of Units (SI), as well as the expected accuracy, along with the Method identifiers as provided in the Library P01 of BODC Parameter Usage Vocabulary are provided as follows:

Symbol: $c(\text{NH}_4^+)$	Unit: $\mu\text{mol L}^{-1}$	
Precision: ± 0.02	Accuracy: ± 0.02	LOD: 0.03
Method identifier:	SDN:P01::AMONMATX	Concentration of ammonium { NH_4^+ CAS 14798-03-9} per unit volume of the water body [dissolved plus reactive particulate phase] by manual colorimetric analysis
	SDN:P01::AMONAADZ	Concentration of ammonium { NH_4^+ CAS 14798-03-9} per unit volume of the water body [dissolved plus reactive particulate <unknown phase] by filtration and colorimetric autoanalysis

References

- Grasshoff, K., Kremling, K., Ehrhardt, M. (eds), 1999. *Methods of Seawater Analysis* 3rd Edition Wiley-VCH Weinheim, 634 pp.
- Strickland J.J., Parsons T., 1965. *A manual of sea water analysis: with special reference to the more common micronutrients and to particulate organic material*. Fisheries Research Board of Canada, 311 pp.
- UNEP/MAP/MED POL, 2005. *Sampling and Analysis Techniques for the Eutrophication Monitoring Strategy of MED POL*. MAP Technical Reports Series No. 163. UNEP/MAP, Athens, 46 pp.
- UNEP/MAP, 2019. UNEP/MED WG.467/5. *IMAP Guidance Factsheets: Update for Common Indicators 13, 14, 17, 18, 20 and 21: New proposal for candidate indicators 26 and 27*.
- UNEP/MAP, 2019a. UNEP/MED WG.463/6. *Monitoring Protocols for IMAP Common Indicators related to pollution*.
- UNEP/MAP, 2019b. UNEP/MED WG.463/10. *Schemes for Quality Assurance and Control of Data related to Pollution*.

Nitrite

- Airey D., Dal Pont G., Sandars G. (1984) A method of determining and removing sulphide to allow the determination of sulphate, phosphate, nitrite and ammonia by conventional methods in small volumes of anoxic waters. *Analytica Chim. Acta*, 166, 79-92.
- Bendschneider K., Robinson R.J. (1952) A new spectrophotometric method for the determination of nitrite in sea water. *J. Mar. Res.*, 11, 87-96.
- Grasshoff, K. (1983) Determination of nitrite. In: "Methods of Seawater Analysis", Grasshoff K., M. Ehrhardt, K. Kremling Eds, Verlag Chemie, Weinheim, 139-142.
- Ilosvay L. (1889) Determination of nitrite in saliva and exhaled air. *Bull. Soc. Chim. Fr.*, 2, 388-391.
- Shinn M.B. (1941) A colorimetric method for the determination of nitrite. *Ind. Eng. Chem Anal. Ed.*, 13, 33-35.

Nitrate

- Grasshoff K. (1983) Determination of nitrate. In: "Methods of Seawater Analysis", Grasshoff K., M. Ehrhardt, K. Kremling Eds, Verlag Chemie, Weinheim, 143-150.
- Morris A.W., Riley J.P. (1963) The determination of nitrate in sea water. *Analytica Chim. Acta*, 29, 272-279.
- Nydhal F. (1976) On the optimum conditions for the reduction of nitrate to nitrite by cadmium. *Talanta*, 23, 349-357.
- Olsen R.J. (1980) Phosphate interference in the cadmium reduction analysis of nitrate. *Limnol. Oceanogr.*, 25, 758-760.

Ammonium

- Berthelot, M.P. (1859) *Repertoire de Chemie Appliquée*, pp. 284.
- Grasshoff K., Johannsen H. (1972) A new automatic and direct method for the automatic determination of ammonia in sea water. *J. Cons. Int. Explor. Mer*, 34, 516-521.
- Hansen H.P., Koroleff, F. (1999) Determination of nutrients. In *Methods of Seawater Analysis*. K. Grasshoff, K. Kremling and M. Ehrhardt (eds) 3rd Edition Wiley-VCH Weinheim pp159-228.
- Ivancic I., Degobbis D. (1984) An optimal manual procedure for ammonia analysis in natural waters by indophenol blue method. *Water Res.*, 18, 1143-1147.
- Koroleff F. (1983) Determination of ammonia. In: "Methods of seawater analysis", Grasshoff K., M. Ehrhardt, K. Kremling Eds, Verlag Chemie, Weinheim, 150-175.

Mantoura R.F.C., Woodward E.M.S. (1983) Optimization of the indophenol blue method for the automated determination of ammonia in estuarine water. *Eustar. Coast. Shelf, Sci.*, 17, 219-229.

Sasaki K., Sawada Y. (1980) Determination of ammonia in estuary. *Bull. Jap. Soc. Sci. Fish.*, 46, 319-321.

Appendix 14

Monitoring Guidelines/Protocols for Determination of Concentration of Key Nutrients in Seawater – Phosphorous and Silica Compounds

1. Introduction

1. In the Monitoring Guidelines for Key nutrients – Phosphorous and Silica compounds in Seawater, the protocols for manual and automated determination of the concentration of orthophosphate, orthosilicate, and total phosphorous and total nitrogen are elaborated. Probably the most important property of seawater in terms of its effect on life in the marine environment is the concentration of dissolved nutrients. The most critical of these nutrients are nitrogen and phosphorus because they play a major role in stimulating primary production by plankton. These elements are known as limiting because plants cannot grow without them. At the moment, the water classification scheme on which the assessment of GES regarding Ecological Objective 5 related to eutrophication is based on chlorophyll *a* concentration as presented in detail in the IMAP Guidance Factsheets (UNEP/MAP, 2019)¹⁶⁰, although in near future it will be complemented by those based on concentration of key nutrients in seawater.

The IMAP Protocols elaborated within this Monitoring Guidelines for Determination of Concentration of Key Nutrients in Seawater – Phosphorous and Silica Compounds provides detail guidance on the necessary equipment, chemical reagents, analytical procedures along with appropriate methodologies for measurement of the concentration of nitrite, nitrate and ammonium in seawater, calculations, data transformation if necessary and identify weak points all endorsed through important notes and possible problems.. However, they are not intended to be analytical training manuals, but guidelines for Mediterranean laboratories, which should be tested and accordingly modified, if need be, in order to validate their final results.

This Monitoring Guidelines build upon the UNEP/MAP Integrated Monitoring and Assessment Programme (IMAP) respectively IMAP Guidance Fact Sheets for IMAP Common Indicators 13 and 14 (UNEP/MAP, 2019); standardized protocols (UNEP/MAP, 2019a)¹⁶¹ and Data Quality Assurance schemes (UNEP/MAP, 2019b)¹⁶² in order to allow the comparability of the data and build of regional assessment schemes. They also take into account previous Sampling and Analysis Techniques for the Eutrophication Monitoring Strategy of MED POL (UNEP/MAP/MED POL, 2005)¹⁶³, however providing detail procedures that are of relevance for IMAP implementation. With the details of the protocols for determination of Key nutrients, the needs of the measurements both in off-shore areas and in narrow coastal areas are addressed.

In the Subchapters “Symbol, units and precision” at the end of each Protocol, for all parameters described in it, the symbol and unit suggested by the International System of Units (SI) are presented. The expected accuracy, precision and where possible the Limit of Detection (LOD) are also presented. A Method identifier is also presented as it is provided in the Library P01 of the British Oceanographic Data Centre (BODC) Parameter Usage Vocabulary respectively included in Data Dictionaries and Data Standards for eutrophication built in IMAP Pilot Info System.

The below flow diagram informs on the category of this Monitoring Guidelines related to determination of chlorophyll *a* in seawater within the structure of all Monitoring guidelines prepared for IMAP Common Indicators 13, 14, 17, 18 and 20.

n. Continuous flow methods

The principle used by the continuous segmented-flow auto-analysers (SFA) is recognized as the most reliable and accurate method for determination of nutrients. Different systems are available and can be configured to meet the standard methods such as ISO, EPA, ASTM, etc... Wherever possible it is strongly recommended that such analysers are used because of the considerable increase in precision

¹⁶⁰ (UNEP/MAP, 2019), UNEP/MED WG.467/5. IMAP Guidance Factsheets: Update for Common Indicators 13, 14, 17, 18, 20 and 21: New proposal for candidate indicators 26 and 27.

¹⁶¹ (UNEP/MAP, 2019a), UNEP/MED WG.463/6. Monitoring Protocols for IMAP Common Indicators related to pollution.

¹⁶² (UNEP/MAP, 2019b), UNEP/MED WG.467/10. Schemes for Quality Assurance and Control of Data related to Pollution

¹⁶³ (UNEP/MAP/MED POL), 2005. Sampling and Analysis Techniques for the Eutrophication Monitoring Strategy of MED POL. MAP Technical Reports Series No. 163. UNEP/MAP, Athens, 46 pp.

and sample throughput that they offer. Ideally such analysers can be used in laboratories on board a research vessel allowing problems of sample deterioration during storage to be circumvented.

The multiplicity of methods reported in the literature is more related to the optimization of methods for different environments than a significant difference in the reactions used. In the Protocols dedicated to the individual methods, some specific aspects will be mentioned. On the general principles of SFA systems, in addition to the documentation provided by the manufacturers to the classic textbooks of Strickland and Parsons (1965)¹⁶⁴ and Grasshoff et al. (1999)¹⁶⁵ can be referred. Equally numerous are the technical reports of the various laboratories produced to homogenize the methods within the programs international like JGOFS or WOCE. In the Protocols only the most essential indication on the most frequently used method will be provided. Important notes on the critical parts of the methods, for its successful performance will also be indicated.

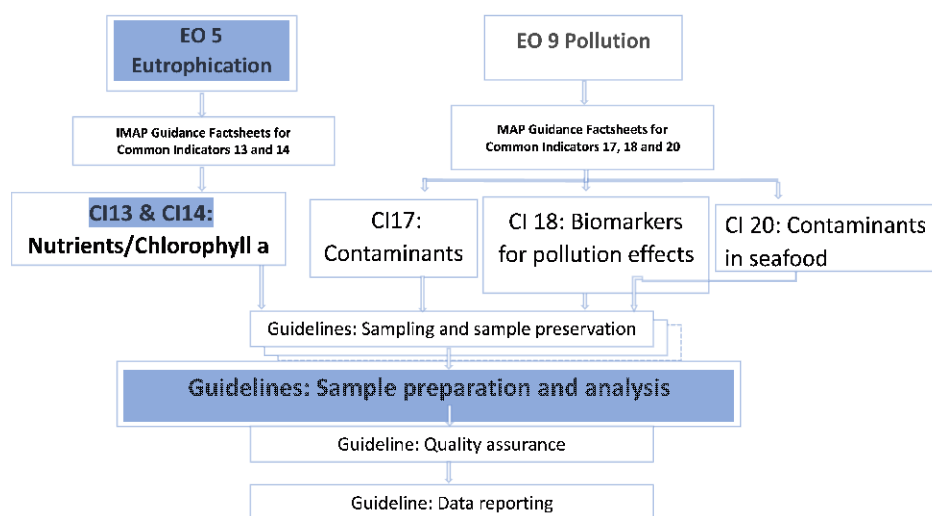

Flow Diagram: Monitoring Guidelines for IMAP Ecological Objective 5 and 9.

2. Technical note for the determination of concentration of orthophosphate

The method is based on the formation of a blue phosphomolybdic complex (from the molybdenum blue group) whose concentration is measured by colorimetry (spectrophotometer or colorimeter) (Deniges, 1920)¹⁶⁶. The aspects relevant to the development of the phosphomolybdic complex are summarized as follow: The molybdate ion and its polymers form, in an acid environment, stable heteropoly acids with elements of the IV and V groups (Boltz and Mellon 1947¹⁶⁷). Phosphomolybdic acid is a yellow complex. The reduction of molybdate from Mo (VI) to Mo (V) in this complex produces a blue coloured heteropoly acid. The maximum absorbance peak varies according to the type of reducing agent used, probably in relation to the variation of the ratio between Mo (VI) and Mo (V) as a whole and to the type of aggregation of the basic units in the solution.

¹⁶⁴ Strickland J.J., Parsons T., 1965. A manual of sea water analysis: with special reference to the more common micronutrients and to particulate organic material. Fisheries Research Board of Canada, 311 pp.

¹⁶⁵ Grasshoff, K., Kremling, K., Ehrhardt, M. (eds), 1999. Methods of Seawater Analysis 3rd Edition Wiley-VCH Weinheim, 634 pp.

¹⁶⁶ Deniges M.G. (1920) Reaction de coloration extrêmement sensible des phosphates et des arseniates. Ses applications. C. R. Acad. Sci., Paris, 171, 802-804.

¹⁶⁷ Boltz D.F., Mellon M.G. (1947) Determination of phosphorus, germanium, silicon, and arsenic by the heteropolyblue method. Ind. Eng. Chem. Anal. Ed., 19, 873-877.

Murphy and Riley (1962)¹⁶⁸ introduced, in the procedure for the determination of phosphates in seawater, the use of a trivalent antimony salt, which enters the heteropoly acid in a ratio of about 1:1 with phosphorus. This modification induces a shift of the maximum absorbance towards the infrared, with an increase in the molar extinction coefficient and a drastic increase in the rate of formation. The subsequent reduction occurs by ascorbic acid, thus eliminating dependencies on ionic strength (saline effect) and on temperature (Murphy and Riley, 1958¹⁶⁹, 1962). To minimize the interference of other ions that react in a similar way with molybdates, it is necessary to keep the pH of the final solution below 1, a condition in which the formation of hetero-polyacids with Si and As is decidedly disadvantaged (Koroleff, 1983)¹⁷⁰.

The methodology of Murphy and Riley (1962) as reported by Strickland and Parsons (1968) is described in this note.

Under this Technical Note, this Monitoring Guidelines provides the following IMAP Protocols for the colorimetric determination of concentration of orthophosphate:

- Protocol for manual colorimetric determination of concentration of orthophosphate;
- Protocol for automated colorimetric determination of concentration of orthophosphate.

2.1 Protocol for manual colorimetric determination of concentration of orthophosphate

a. Equipment:

The equipment for manual colorimetric determination of concentration of orthophosphate include:

- | | |
|--|--|
| 1. graduated cylinders or 50 mL pipettes | 8. precision micropipettes to measure volumes in the range of 10-100 μ L |
| 2. 100 mL borosilicate glass containers (preferably flasks with cap) | 9. analytical scale |
| 3. laboratory glassware for chemical preparations | 10. stove |
| 4. 5 mL automatic dispenser | 11. microwave oven |
| 5. 50, 250- and 500-mL volumetric flasks | 12. dryer |
| 6. volumetric flasks of 100 mL class A | 13. spectrophotometer or colorimeter sensitive to 880 nm (as a fallback 705 nm) equipped with cells of at least 50 mm optical path |
| 7. 1 L class A volumetric flask | |

b. Chemical products:

The chemical products for manual colorimetric determination of concentration of orthophosphate include:

- | | |
|--|--|
| 1. sulfocromic mixture | 5. ascorbic acid [C ₆ H ₈ O ₆] |
| 2. concentrated sulfuric acid [H ₂ SO ₄] | 6. potassium dihydrogen phosphate [KH ₂ PO ₄] |
| 3. ammonium heptamolybdate tetrahydrate [(NH ₄) ₆ Mo ₇ O ₂₄ ·4H ₂ O] | 7. chloroform [CHCl ₃] |
| 4. potassium antimony tartrate [K(SbO)C ₆ H ₄ O ₆] | |

¹⁶⁸ Murphy J., Riley J.P. (1962) A modified single solution method for the determination of phosphate in natural waters. *Analytica Chim. Acta*, 27, 31-36.

¹⁶⁹ Murphy J., Riley J.P. (1958) A single-solution method for the determination of soluble phosphate in sea water. *J. Mar. Biol. Ass. U.K.*, 37, 9-14.

¹⁷⁰ Koroleff F. (1983) Determination of phosphorus. In: "Methods of Seawater Analysis", Grasshoff K., M. Ehrhardt, K. Kremling Eds, Verlag Chemie, Weinheim, 125-139.

c. Preparation of stock solutions

5 N sulfuric acid

140 mL of concentrated sulfuric acid are poured slowly into a beaker containing about 800 mL of reagent grade water. Allow to cool and the volume is adjusted to 1 L. The solution, stored in a dark glass bottle, is stable indefinitely.

Molybdate ammonium solution

15 g of crystalline ammonium heptamolibdate tetrahydrate are dissolved in 450 mL of reagent grade water in a 500 mL flask and adjusted to volume. The solution, stored in a plastic or borosilicated glass bottle, away from direct light, is usable until a white precipitate is formed.

Solution of potassium antimony tartrate

0.34 g of potassium antimony tartrate are dissolved in 250 mL of reagent grade water in a 250 mL flask. The solution, stored in a glass or plastic bottle, is stable for many months, unless a white flocculate is formed.

Standard solution of potassium dihydrogen phosphate 2 mmol L⁻¹

Few grams of potassium dihydrogen phosphate in an oven at 110 °C are dried. 272.18 mg on an analytical balance are weighted and in 900 mL of reagent grade water in a 1 L (class A) flask dissolved. Up to volume is adjusted and a few drops of chloroform as a preservative added. The solution, stored in a borosilicate glass bottle, is stable for a few months.

d. Preparation of specific equipment for analysis

d.1. Treatment of reaction vessels

The reaction flasks with boiling sulfochromic mixture are periodically washed. Keep them tightly capped, filled with reagent grade water and mixed reagent (if necessary, the residue of the analysed sample can be left in the flask).

e. Analytical procedure

e.1. Reagents to be prepared at the time of use

Ascorbic acid solution

2.7 g of ascorbic acid is dissolved in 45 mL of reagent grade water in a 50 mL flask and to volume adjusted. The solution, stored in a plastic or glass bottle, is stable for 24 hours.

Mixed reagent

In a glass container are mixed: 100 mL of ammonium molybdate solution, 250 mL of 5 N sulfuric acid, 100 mL of ascorbic acid solution and 50 mL of potassium antimony tartrate solution. The solution is sufficient for about 100 samples but deteriorates within a few hours and must be replaced when its color changes from light yellow to very dark yellow.

Preparation of standard solutions

5 standards of known phosphate concentration are prepared: by diluting, in 100 mL flasks (class A), respectively 10, 25, 50, 75, 100 µL of standard solution of potassium dihydrogen phosphate (measured with a precision pipette) with oligotrophic seawater. The concentrations of phosphate are thus between 0.2 and 2 µmol L⁻¹ plus the orthophosphate content of oligotrophic seawater.

e.2. Analytical treatment

At the time of analysis, if the sample had been frozen, possibly using a 37 °C bath or a microwave oven is quickly thawed;

The flasks with an aliquot of samples or standard solutions of different concentrations are pre-rinsed;

The flasks with 50 mL of sample or each of the standard solutions (measured with a graduated cylinder) are filled. Given the remarkably low concentrations of phosphates and the relative sensitivity of the analytical method, it is advisable to carry out at least two determinations for each sample to be analysed.

5 mL of mixed reagent to each sample or standard solution with a dispenser are added and shaken.

For the reaction to take place is necessary at least 5 minutes and no more than 2 hours.

e.3. Preparation of reagent blanks

Four 100 mL flasks are filled with 50 mL of oligotrophic seawater, low in phosphates, after rinsed with the same water.

5 mL of mixed reagent are added to two flasks and double the amount in the other two.

The time the reaction to take place is necessary as for samples and standard solutions.

e.4. Spectrophotometric measurements

The absorbance of the blank ($bl_{c,i}$) of each cell of the spectrophotometer or colorimeter, used for reading against the reference cell, at 882 nm is measured, both filled with water without reagents. The operation is superfluous if only one cell is used.

For each flask, the number of the cell used, the identification of the contents of the flask (sample, standard solution, blank) are noted in a form. The cell is rinsed with part of its contents, filled and the absorbance at 882 nm read, recording the reading on the same form. Alternatively, with a loss of sensitivity of about 30%, the absorbance can be read at 705 nm.

f. Calculations:

The reagent blank (bl) as the average difference between the values of the blanks containing 10 mL and those containing 5 mL of mixed reagent is calculated.

The correlation between the absorbance values of the 5 standards and the assumed concentrations, using the Ordinary Least-Squares Regression is calculated. The colorimetric factor (f) is represented by the slope.

A standard with zero concentration of orthophosphates represented by the sample of oligotrophic seawater to which a single dose of mixed reagent has been added is considered. In this way, a total of 6 standards are obtained, covering a concentration range of $2.0 \mu\text{mol L}^{-1}$.

The concentration of orthophosphate in the samples is calculated with the following equation:

$$c(\text{PO}_4) / \mu\text{mol L}^{-1} = (\text{ABS} - \text{bl} - \text{bl}_{c,i}) f$$

where

$c(\text{PO}_4)$ = concentration of orthophosphates

ABS = absorbance of the sample

bl = blank of the reagents

$bl_{c,i}$ = blank of the i-th cell used

f = colorimetric factor

For a cell with a 50 mm optical path, the colorimetric factor is equal to about $9.9 \mu\text{mol L}^{-1}$, i.e. a difference in concentration of $1 \mu\text{mol L}^{-1}$ (for example between standard solution 3 and 5) should be the difference in absorbance of about 0.1.

g. Important notes and possible problems:

The cells of the spectrophotometer (or colorimeter) should be washed periodically with a 5% solution of soda or hydrofluoric acid because the phosphomolybdic complex tends to stick to the walls, giving them a slight blue colour.

The samples should not be lived in plastic containers at room temperature for a long time. Both due to the bacterial activity that develops on the walls of the bottle and to adsorption phenomena the concentration of phosphates tends to decrease.

After thawing the samples, the analysis must be complete in a short time to avoid phenomena of hydrolysis of organic phosphates or polyphosphates.

If the standard solution has been stored in the refrigerator, it must be brought to laboratory temperature before starting the standardization procedure.

Spectrophotometer measurement must be performed within two hours of adding the reagent to avoid the slow formation of silicomolybdic heteropoly acids.

Sulphides can interfere with the reaction, if present in concentrations higher than $50 \mu\text{mol L}^{-1}$ of S^{2-} , as the extinction coefficient and the maximum absorbance are altered (De Jonge and Villerius, 1980)¹⁷¹. In this case the sulphides from the sample should be removed (Airey et al., 1984)¹⁷².

Silicates interfere if present at concentrations higher than $150 \mu\text{mol L}^{-1}$ as a complex that absorbs in the same band is developed (Koroleff, 1983).

The reagent blank, if prepared using distilled water, may have a higher optical density than the samples to be analysed. This can derive from different causes; it is advised the procedure indicated in the paragraph "Preparation of reagent blanks" to strictly be followed or the method suggested by Novoselov et al. (1976)¹⁷³ to be applied.

2.2 Protocol for automated colorimetric determination of concentration of orthophosphate

a. Reagents:

Ammonium molybdate

10 g of molybdate are dissolved in 800 mL of DDW. The solution is stable for at least one month.

Antimony potassium tartrate (KAT)

2.5 g of KAT is dissolved in 800 mL of DDW and adjusted to 1 L. The solution is stored in a glass bottle and is stable for at least one month.

b. Solutions for use

Mixed reagent

In a 250 mL graduated glass cylinder and shaking after each addition are mixed: 100 mL of molybdate stock + 25 mL of KAT + 30 mL of H_2SO_4 conc. + 1 mL of SLS (Sodium-Laurel-Sulphate) and adjusted to 250 ml. The reagent is very stable and should be stored in a glass bottle.

Ascorbic acid

¹⁷¹ De Jonge V.N., Villerius L.A. (1980) Interference of sulphide in inorganic phosphate determination in natural waters. Mar. Chem., 9, 191-197.

¹⁷² Airey D., Dal Pont G., Sandars G. (1984) A method of determining and removing sulphide to allow the determination of sulphate, phosphate, nitrite and ammonia by conventional methods in small volumes of anoxic waters. Analytica Chim. Acta, 166, 79-92.

¹⁷³ Novoselov A.A., Sheremet'Yeva A.I., Danilenko A.F. (1976) Method for simultaneous obtaining silicon-free and phosphate-free sea water aboard ship. Oceanology, 16, 358-359.

1.8 g of ascorbic acid is dissolved in 100 mL of DDW.

c. Standards:

About 2 g of KH_2PO_4 are dried in an oven at a temperature of 110 °C, checking for constant weight of the salt over time. The salts are then placed in a silica gel dryer for another 24 hours. It is then dissolved in reagent grade water in such a proportion to obtain a concentration of 2 mmol L^{-1} .

This standard is used in the daily procedure for the preparation of 5 lower concentration standards. The concentration of the minor standards is chosen based on the amount of PO_4^{3-} salts expected to be found, so that the set of sub-standards covers the entire range of expected concentrations. From the 5 standards a multiplication factor is obtained which is necessary to calculate the concentrations.

d. Manifold

The manifold (Fig. 1) is composed of two injectors and four coils of 10 turns each. The first injector (A) is equipped with 3 inputs: the first is for the sample, the second is for the air and the third input provided for the introduction of the first reagent. Immediately after there are 3 composite coils with 10 coils each: in the first 2 the first reagent is mixed, in the other 2 the second reagent is introduced at point (B), by means of the second injector.

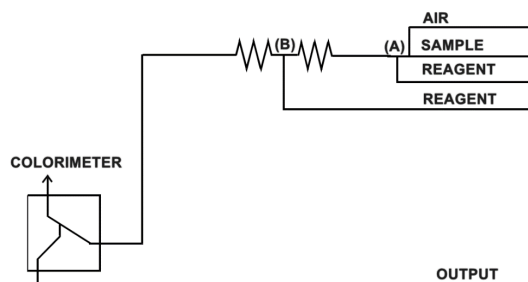

Figure 1. Manifold for orthophosphate measurement.

e. Calculations

The calculations are performed as is generally indicated in the Annex I: Automated methods for determination of concentration of key nutrients in seawater – Calculation of the concentration.

f. Important notes and possible problems

If an unstable base line occurs when the appliance is turned on in the absence of reagents, wash the circuit with NaOH and then with 10% HCl.

If during the analysis there is an evident increase in the baseline, the colorimeter reading cell is immediately cleaned by injecting 50% hydrochloric acid directly into the cell without stopping the circuit.

DDW is deionized if possible, in the water container of the instrument.

If change of components of the circuit (injectors, bubblers) is necessary, the circuit by changing the flow rates of the pipes must be rebalance

Suitable containers for the different reagents must be used. The cap of the container must be provided with small holes in which to insert capillaries (needles, etc.) for the withdrawal of the reagent.

Water poor in nutrients, or oligotrophic sea water (OSW), as washing water between one sample and another must be used. OSW must have salinity values similar to the sample to be analysed.

At temperatures below 10 °C a thermostated bath at a temperature of 40 °C must be added to the manifold.

If precipitate forms in the molybdate the reagent must be discarded.

In case of preparation of mixed standards of PO₄ and SiO₄ the standards must never be prepared in the same flask.

A colorimeter with a very narrow entrance of the reading cell to avoid refractive disturbances must be used.

High sensitivity reading phototubes for 880 nm readings must be used.

a. *Symbol, units and precision*

Symbol: $c(\text{PO}_4^{3-})$	Unit: $\mu\text{mol L}^{-1}$	
Precision: ± 0.02	Accuracy: ± 0.02	LOD: 0.03
Method identifier: SDN:P01::PHOSMAZX		Concentration of phosphate {PO ₄ ³⁻ - CAS 14265-44-2} per unit volume of the water body [unknown phase] by manual colorimetric analysis
	SDN:P01::PHOSAAZX	Concentration of phosphate {PO ₄ ³⁻ - CAS 14265-44-2} per unit volume of the water body [unknown phase] by colorimetric autoanalysis

3 Technical note for the determination of concentration of orthosilicate

The determination of the dissolved silicates is carried out by inducing the formation of a silicomolibdic polyacid which is subsequently reduced to molybdenum blue. The final compound has a maximum absorbance at 810 nm, and is measured by colorimetry.

The chain of reactions is strongly influenced by even minimal variations in the reaction conditions due to the multiplicity of intermediate products and their instability. Silicomolybdic acid is formed with different speed in relation to the degree of polymerization of the silicate.

Silicomolybdic acid exists in at least two isomers α and β (Strickland, 1952¹⁷⁴; Morrison and Wilson, 1963¹⁷⁵; Truesdale and Smith, 1975¹⁷⁶), of which the former is thermodynamically more stable but kinetically disadvantaged at pH values below 2. The two isomers α and β of silicomolybdic acid have a peak of maximum absorbance in the blue part of the spectrum, but with quite different extinction coefficients, none of which are particularly high. Furthermore, for the reasons mentioned above, they do not guarantee sufficient stability over time. The subsequent reduction of isomer β by p-methylaminophenol (metol) sulphate in an acid environment and in the presence of sulphite produces a stable molybdenum blue for at least 2 hours from the completion of the reaction (Mullin and Riley, 1955)¹⁷⁷. Also, in this process it is important to control the pH to avoid a direct reduction of excess molybdenum by metol.

All the reactions outlined above depend both on the ionic strength of the solution and on the presence of specific ions, especially the divalent ones; therefore, the concentration of the final product and perhaps also its molar extinction depend on the salt concentration of the reaction mixture and, consequently, of the sample. The formation of polyacids with molybdate, in fact, is also characteristic

¹⁷⁴ Strickland J.D.H. (1952) The preparation and properties of silicomolybdic acid. II. The preparation and properties of alpha silicomolybdic acid. J. Amer. Chem. Soc., 74, 868-871.

¹⁷⁵ Morrison I.R., Wilson A.L. (1963) The absorptiometric determination of silicon in water. Part I. Formation, stability and reduction of [β - and α -molybdosilicic acids. Analyst, 88, 88-99.

¹⁷⁶ Truesdale V.W., Smith C.J. (1975) The formation of molybdosilicic acids from mixed solutions of molybdate and silicate. Analyst, 100, 203-212.

¹⁷⁷ Mullin J.B., Riley J.P. (1955) The colorimetric determination of silicate with special reference to sea and natural waters. Analytica Chim. Acta, 12, 162-176.

of other ions, in particular phosphate and arsenate (Boltz and Mellon, 1947); to avoid the interference of the phosphomolybdates, these can be eliminated with oxalic acid (Strickland and Parsons, 1968).

Under this Technical Note, this Monitoring Guidelines provides the following IMAP Protocols for the colorimetric determination of concentration of orthosilicate:

- Protocol for manual colorimetric determination of concentration of orthosilicate;
- Protocol for automated colorimetric determination of concentration of orthosilicate.

3.1 Protocol for manual colorimetric determination of concentration of orthosilicate

a. *Equipment*

The equipment for manual colorimetric determination of concentration of orthosilicate include:

- | | |
|---|--|
| 1. 25 mL cylinder or pipette, preferably in plastic | 8. 1 L class A volumetric flask |
| 2. 50 mL plastic containers (preferably flasks or bottles with polyethylene or polymethylpentene cap) | 9. precision micropipettes to measure volumes in the range of 10 - 100 μ L |
| 3. laboratory glassware for chemical preparations | 10. spectrophotometer or colorimeter sensitive to 810 nm, which has cells of at least 50 mm optical path |
| 4. automatic dispensers or pipettes of 10 and 15 mL | 11. platinum crucible |
| 5. Whatman paper filters n. 1 | 12. agitator |
| 6. 500 mL volumetric flasks | 13. analytical scale |
| 7. volumetric flasks of 100 mL class A | 14. stove |
| | 15. dryer |

b. *Chemical products*

The chemical products for manual colorimetric determination of concentration of orthosilicate include:

1. sulfocromic mixture
2. concentrated sulfuric acid [H_2SO_4]
3. concentrated hydrochloric acid [HCl]
4. ammonium heptamolybdate tetrahydrate [$(\text{NH}_4)_6\text{Mo}_7\text{O}_{24}\cdot 4\text{H}_2\text{O}$]
5. oxalic acid [$\text{C}_2\text{H}_2\text{O}_4\cdot 2\text{H}_2\text{O}$]
6. 4-methylaminophenol sulfate (metol) [$(\text{CH}_3\text{NHC}_6\text{H}_4\text{OH})\cdot 2\text{H}_2\text{SO}_4$]
7. anhydrous sodium sulphite [Na_2SO_3]
8. powdered silica [SiO_2] and anhydrous sodium carbonate [Na_2CO_3] (alternatively, sodium hexafluorosilicate [Na_2SiF_6])

c. Preparation of stock solutions

Molybdate reagent

4.0 g of ammonium heptamolybdate tetrahydrate (preferably crystalline) are dissolved in about 300 mL of reagent grade water. 12 mL of concentrated hydrochloric acid are diluted in 100 -150 mL of reagent grade water and mixed well. While stirring, the molybdate solution is added in that of hydrochloric acid and adjusted to 500 mL with reagent grade water. The solution, stored in a polyethylene bottle, away from direct light, is usable until a white precipitate is formed or turned blue.

Solution of metol and sulphite

6 g of anhydrous sodium sulphite are dissolved in 400 mL of reagent grade water and 10 g of metol added, while stirring until it is completely dissolved. The solution is filtered, on a Whatman No. 1 filter, previously rinsed with reagent grade water, and adjusted to 500 mL. The solution is stored in a tightly closed borosilicate glass bottle and therefore should not be stored for more than a month.

Oxalic acid solution

A saturated solution of oxalic acid by dissolving 50 g of acid in 400 mL of reagent grade water is prepared. The solution is decanted separating it from the residual crystals and adjusted to the volume of 500 mL. The solution is stored in a polyethylene bottle and stable indefinitely.

50% (v/v) sulfuric acid solution

250 mL of concentrated sulfuric acid are poured into 250 mL of reagent grade water while stirring. Cool to room temperature and make up to volume with reagent grade water in a 500 cm³ mat. The solution, stored in a container of dark plastic, is stable indefinitely.

Standard solution of silicate (10 mmol L⁻¹)

The pure silica is heated to 1000 °C, cooled in a desiccator and checked for constant weight with repeated weighing. 601.0 mg of silica (the theoretical amount corresponding to 10 mmol of Si) are weighed in a platinum crucible and 1.5 g of anhydrous sodium carbonate added. Everything is mixed with a metal spatula and melted, until completely homogenized, at a temperature of 1000 °C. The melted product is kept at 1000 °C until clear. Then is cooled and in several portions of very hot water dissolved and transferred after cooling to a 1 L flask (class A). Adjusted to volume with reagent grade water and quickly transferred to a high-density polyethylene bottle. The solution is stable for a few months.

Alternatively, sodium hexafluorosilicate can be used. It must be dried in an oven at 105 °C for one hour in a metallic melting pot. In this case, given the low solubility, it is preferable to prepare solutions with concentrations not exceeding 2 mmol L⁻¹, therefore the dilutions must be corrected proportionally. Since the product is not yet supplied in analytical purity, the quantity to be weighed must be calculated based on the purity indications of the supplier. The sodium hexafluorosilicate is dissolved in 700 mL of reagent grade water in a plastic container, under gentle heating, and the solution into a 1 L (class A) flask transferred. The dissolution time is correlated to the crystalline form of the product and few hours may be necessary. The volume is adjusted to 1 L and quickly transferred to a plastic bottle to prevent the fluoride from removing silicon from the glass. The solution is stable for few months.

d. Preparation of specific equipment for analysis:

d.1. Treatment of reaction vessels

Wash the 50 cm³ polyethylene or polymethylpentene containers with sulphochromic mixture, rinse them thoroughly with reagent grade water and dry them. For routine maintenance it is sufficient, after use, to rinse them with reagent grade water and place them upside down on filter paper.

e. Analytical procedure:

e.1. Reagents to be prepared at the time of use

Reducing reagent

100 mL of metol and sulphite solution and 60 mL of oxalic acid solution are mixed. Slowly 60 mL of 50% sulfuric acid are added and adjusted to 300 mL in a cylinder with reagent grade water. This reagent must be prepared immediately before use.

e.2. Preparation of standard solutions

5 solutions of known concentration of silicate by diluting, in 100 mL flasks (class A), respectively 10, 25, 50, 75, 100 μL of standard silicate solution (measured with a precision micropipette) with oligotrophic sea water are prepared, resulting in concentrations between 1 and 10 $\mu\text{mol L}^{-1}$ of silicate, plus the silicate content of the oligotrophic water.

e.3. Analytical treatment

At the time of analysis, the sample, if had been frozen, is thawed slowly keeping it away from light. The analysis must be performed after 12 hours, to allow the polymeric forms of silicates to depolymerize.

10 mL of molybdc reagent is poured (using a dispenser) into the container and while stirring 25 mL of sample or of each of the standard solutions (measured with a graduated cylinder) added.

Respecting the same times for all samples and calibration standards the reaction is allowed to take place for at least 15 minutes but not more than 30 minutes.

Using a dispenser, 15 mL of reducing reagent are added and allowed the reaction to take place for at least 1 hour. For the whole group of samples the same reaction times must be respected.

e.4. Preparation of reagent blanks

At least two replicates of reagent blanks in 50 mL polyethylene containers, using 25 mL of oligotrophic seawater must be prepared and treated with the same analytical procedure applied to the samples and standards.

In some cases, due to a high concentration of silicates in the oligotrophic sea water too high blank value may be observed. In that case it is advisable to remove them (Novoselov et al., 1976) or the blanks must be prepared with reagent grade water.

e.5. Spectrophotometric measurement

The absorbance of the blank ($bl_{c,i}$) of each cell of the spectrophotometer or colorimeter, used for reading against the reference cell, at 810 nm is measured, both filled with water without reagents. The operation is superfluous if only one cell is used.

For each flask, the number of the cell used, the identification of the contents of the flask (sample, standard solution, blank) are noted in a form. The cell is rinsed with part of its contents, filled and the absorbance at 810 nm read, recording the reading on the same form.

f. Calculations

The reagent blank (bl) as the average difference between the values of the two blank readings is calculated.

The correlation between the absorbance values of the 5 standards and the assumed concentrations, using the Ordinary Least-Squares Regression is calculated. The color-metric factor (f) is represented by the slope.

The concentration of orthosilicate in the samples is calculated with the following equation:

$$c(\text{SiO}_4) / \mu\text{mol L}^{-1} = (\text{ABS} - \text{bl} - \text{bl}_{c,i}) \cdot f$$

where

$c(\text{SiO}_4)$ = concentration of orthosilicates

ABS = absorbance of the sample

- bl = blank of the reagents
 bl_{c, i} = blank of the i-th cell used
 f = colorimetric factor

For a cell with a 50 mm optical path, the colorimetric factor is equal to about 19 $\mu\text{mol L}^{-1}$, i.e. a difference in concentration of 10 $\mu\text{mol L}^{-1}$ (such as for example between the water used to dilute the standard solutions and the standard 5) should be approximately 0.52 in the case of samples with salinity of 37.

g. *Important notes and possible problems*

As already mentioned, after thawing, the sample must be kept in dark for at least 12 hours at room temperature to favour the depolymerization of the silicates. In fact, polymerization is promoted by freezing and an underestimation of the concentration of reactive silicates will be observed (Burton and Leatherland, 1970¹⁷⁸; MacDonald and McLaughlin, 1982¹⁷⁹; MacDonald et al., 1986¹⁸⁰).

The sample must be added to the molybdic reagent, and not vice versa, in order to guarantee a correct pH value.

During the analysis, all the samples must be kept at the same temperature, possibly around 20 °C, to avoid a variability depending on the thermal coefficient of the reaction.

Calibration standards using seawater with salinity equal to that of the samples must be prepared. If working in an estuarial environment, a set of standards that cover the range of salinity values found in the samples must be prepared. The saline coefficient (ratio between the colorimetric factor value in reagent grade water and in salt water) is quite variable: for water with salinity around 35 a value of about 0.85 is observed (Bien, 1958¹⁸¹; Fanning and Pilson, 1973¹⁸²; Koroleff, 1983).

An abnormal yield of the reaction is related almost always to pH values different from 2 or on bad handling. The pH in the final mix must be between 1.8 and 2.2. Sometimes a bad mixing of the reaction mixture, as well as an incorrect pH value is responsible for the formation of a blue colour due to the direct reduction of the molybdate and not to that of the polyacids.

The suggested method is generally free from interference for sea water. However, interference of cations such as copper, iron, cobalt and nickel with the colour of their ions may be observed. In this case the absorbance of the sample at the same wavelength without adding the reagents is necessary to be measured and the value of this reading must be added to the reagent blank. If iron ions are present, which form ferric molybdate during the reaction, a hydroxylamine hydrochloride solution (Mullin and Riley, 1955) must also be added to the samples before analysis. The development of colour is not observed if the sulphides are present in a concentration below 5 mg L^{-1} , otherwise they must be oxidized with bromine water (Koroleff, 1983).

3.2 Protocol for automated colorimetric determination of concentration of orthosilicate

a. *Reagents*

Stannous chloride.

¹⁷⁸ Burton J.D., Leatherland T.M. (1970) The reactivity of dissolved silicon in some natural waters. *Limnol. Oceanogr.*, 15, 473-476.

¹⁷⁹ MacDonald R.W., McLaughlin F.A. (1982) The effect of storage by freezing on dissolved inorganic phosphate, nitrate and reactive silicate for samples from coastal and estuarine waters. *Water Res.*, 16, 95-104.

¹⁸⁰ MacDonald R.W., McLaughlin F.A., Wong C.S. (1986) The storage of reactive silicate samples by freezing. *Limnol. Oceanogr.*, 31, 1139-1142.

¹⁸¹ Bien G.S. (1958) Salt effect correction in determining soluble silica in sea water silicomolybdic acid method. *Anal. Chem.*, 30, 1525-1526.

¹⁸² Fanning K.A., Pilson M.E.Q. (1973) On the spectrophotometric determination of dissolved silica in natural waters. *Anal. Chem.*, 45, 136-140.

20 g of stannous chloride are dissolved in 12.5 mL of concentrated HCl + 27.5 mL of DDW. The reagent is dissolved at a temperature of 70 °C.

Tartaric acid

100 g of tartaric acid are dissolved in 1 L of DDW.

Ammonium molybdate

40 g of molybdate are dissolved in 800 mL of DDW and then adjusted to 1 L.

b. Solutions for use

Molybdate

50 mL of 10% HCl + 40 mL of molybdate + 15 mL of DDW are mixed.

Stannous chloride

2.5 mL of stannous chloride + 48 mL of 10% HCl + 50 mL of DDW are mixed.

c. Standard

About 2 g of Na_2SiF_6 are dried in an oven at a temperature of 105 °C until a constant weight over time is reached. The salt is placed in a silica gel desiccator for another 24 hours. Then the salt is dissolved in reagent grade water in such a proportion to obtain a concentration of 10 mmol L^{-1} .

This standard is used in the daily procedure for the preparation of 5 lower concentration standards. The concentration of the sub-standards is chosen based on the amount of SiO_4 that is expected to be found, in a way the entire range of expected concentrations are covered. The multiplication factor for the calculation of concentrations is obtained from the 5 standards.

d. Manifold

The manifold (Fig. 2) is composed of three injectors and six coils of 10 turns each. The first injector (A) is equipped with 3 inputs: The first for the sample, the second for air bubbles and the third where the first reagent is introduced. Immediately after 6 coils made up of 10 coils each can be found: in the first two the first reagent is mixed, in the second two where at point (B) the second reagent is injected, and finally in the last two where at point (C) the third reagent is injected.

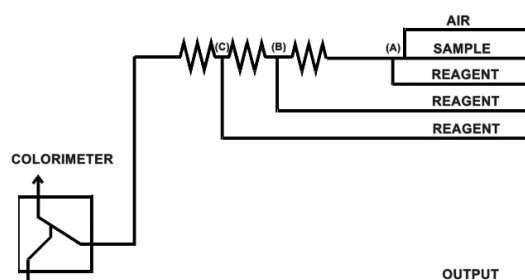

Figure 2. Manifold for orthosilicate measurement.

e. Calculations

The calculations are performed as is generally indicated in the Annex I: Automated methods for determination of concentration of key nutrients in seawater – Calculation of the concentration.

f. Important notes and possible problems

If an unstable base line occurs when the appliance is turned on in the absence of reagents, wash the circuit with NaOH and then with 10% HCl.

If during the analysis there is an evident increase in the baseline, the colorimeter reading cell is immediately cleaned by injecting 50% hydrochloric acid directly into the cell without stopping the circuit.

DDW is deionized if possible, in the water container of the instrument.

If change of components of the circuit (injectors, bubblers) is necessary, the circuit by changing the flow rates of the pipes must be rebalance

Suitable containers for the different reagents must be used. The cap of the container must be provided with small holes in which to insert capillaries (needles, etc.) for the withdrawal of the reagent.

Water poor in nutrients, or oligotrophic sea water (OSW), as washing water between one sample and another must be used. OSW must have salinity values similar to the sample to be analysed.

If precipitate forms in the molybdate the reagent must be discarded.

In case of preparation of mixed standards of PO₄ and SiO₄ the standards must never be prepared in the same flask.

A colorimeter with a very narrow entrance of the reading cell to avoid refractive disturbances must be used.

High sensitivity reading phototubes for 820 nm readings must be used.

If, when inserting the reagents, a blue colour is noticed in the sample, at the exit from the second series of coils, this would indicate that the tartaric acid is to be discarded.

Symbol, units and precision

Symbol: $c(\text{SiO}_4^{4-})$

Unit: $\mu\text{mol L}^{-1}$

Precision: ± 0.05

Accuracy: ± 0.05

LOD: 0.10

Method identifier: SDN:P01::SLCAMAZX

Concentration of silicate {SiO₄⁴⁻- CAS 17181-37-2} per unit volume of the water body [unknown phase] by manual colorimetric analysis

SDN:P01::SLCAAAXX

Concentration of silicate {SiO₄⁴⁻- CAS 17181-37-2} per unit volume of the water body [unknown phase] by colorimetric autoanalysis

4 Technical note for the combined determination of concentration of total nitrogen and total phosphorous

The concentration of total nitrogen or phosphorus in a water sample is represented as the sum of the moles of the element in question present in the form of organic and inorganic, dissolved and particulate species. In this analytical procedure both elements are determined after oxidation and hydrolysis of most of the compounds initially present in the sample in the same reaction mixture, with the production of nitrate and orthophosphate respectively. The procedure for the common mineralization of the two elements are presented.

The oxidizing agent used is potassium persulfate K₂S₂O₈, which decomposes when hot according to the reaction:

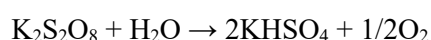

During the oxidation reaction, H⁺ is produced which determines a pH variation. The behaviour of the various nitrogen compounds in the oxidation reaction is different. Those containing N-N bonds are oxidized more difficultly while those with N = N bonds are rather refractory to nitrate oxidation. Furthermore, a time of at least 30 minutes is necessary to ensure the complete disappearance of the persulfate from the oxidation solution, thus preventing possible interference in the subsequent phases of the analytical assay, especially for the determination of nitrate.

The appearance in the reaction mixture, even in an alkaline environment, of Cl_2 which would interfere with the subsequent reduction of nitrates by cadmium is due to the subtraction of OH^- by magnesium in the form of a precipitate, which does not readily neutralize the H^+ ion produced by the reaction (Nydahl, 1978)¹⁸³. Therefore, adding OH^- to the reaction mixture or shaking the reaction vessels is suggested. Koroleff (1968¹⁸⁴; 1983) on the other hand argued that in an alkaline environment, while the complete hydrolysis of the bound phosphorus into organic compounds is achieved, a yield of polyphosphates decomposition around 60% is observed. However, the concentration of the latter is generally of secondary importance compared to bound phosphorus in organic compounds, for which Koroleff (1968; 1983b¹⁸⁵) and Valderrama (1981)¹⁸⁶ believe that a unique method for the determination of nitrogen and total phosphorus in seawater are equally reliable.

In the method reported by Valderrama (1981), thanks to the use of a buffer based on the boric acid-borate couple and based on the reactions involved, the pH of the mixture starts from about 9.7 and reaches the end of the process at about 4-5, thus creating the appropriate conditions for the oxidation-hydrolysis of both nitrogen and phosphorus and the necessary decomposition of excess persulphate. The method presented is the method of Valderrama (1981) in the version of Koroleff (1983a, b).

Under this Technical Note, this Monitoring Guidelines provides the following IMAP Protocols for the combined colorimetric determination of concentration of total nitrogen and total phosphorous:

- Protocol for preparation of samples for a combined determination of concentration of total nitrogen and total phosphorus;
- Protocol for combined manual colorimetric determination of concentration of total nitrogen and total phosphorous;
- Protocol for combined manual colorimetric determination of concentration of total nitrogen and total phosphorous.

4.1 Protocol for preparation of samples for a combined determination of concentration of total nitrogen and total phosphorus

h. Equipment

The equipment for preparation of samples for determination of concentration of total nitrogen and total phosphorous include:

1. graduated cylinders of 50 mL
2. 100 mL borosilicate glass, polypropylene, TPX or Teflon containers with hermetically sealed screw cap fitted with flange or Teflon gasket. It is recommended to use polyethylene bottles if the samples will be frozen.

i. Chemical products

The chemical products for preparation of samples for determination of concentration of total nitrogen and total phosphorous include:

1. potassium persulfate [$\text{K}_2\text{S}_2\text{O}_8$] (nitrogen content <0.001%)
2. sodium hydroxide [NaOH] (nitrogen content <0.001%)

j. Preparation of reagents:

¹⁸³ Nydahl F. (1978) On the peroxidisulphate oxidation of total nitrogen in waters to nitrate. *Talanta*, 12, 1123-1130.

¹⁸⁴ Koroleff F. (1968) Determination of total phosphorus in natural waters by means of persulphate oxidation. *ICES C.M./C.*, 33, 209-212.

¹⁸⁵ Koroleff, F. (1983b) Total and organic nitrogen. In: "Methods of Seawater Analysis", Grasshoff K., M. Ehrhardt, K. Kremling Eds, Verlag Chemie, Weinheim, 162-173.

¹⁸⁶ Valderrama J.C. (1981) The simultaneous analysis of total nitrogen and total phosphorus in natural waters. *Mar. Chem.*, 10, 109-122.

Oxidizing solution

50 g of potassium persulfate (low N content) and 30 g of boric acid are dissolved in 1 L of sodium hydroxide 0.375 mol L^{-1} (15 g of NaOH are dissolved and diluted to 1 L with distilled water and stored in a polyethylene bottle). The reagent, if stored in a well capped polyethylene bottle and wrapped in aluminium foil, is stable for at least one week.

k. Sampling procedure

Using a 50 mL cylinder, rinsed at least twice with the sample, 50 mL of water for each sub-sample are poured directly from the sampling bottle into the reaction containers, which have also been previously rinsed with the sample.

If the sample is particularly turbid (frequent occurrence in coastal waters), a duplicate sampling is necessary to determine the turbidity.

As in all determinations that include particulate matter, sub-samples must be taken after having carefully shaken the sampling bottle or within very short times that prevent significant sedimentation of the particulate.

l. Sample storage

As regards conservation, one of the three methods indicated below can be used, which ensure acceptable results:

1. The samples are kept, at the time of collection, in the hermetically sealed reaction containers. The analysis can also be performed after a long period of time. In fact, following the oxidation reaction, the nitrates and phosphates produced remain constant.
2. Immediately after sampling, 5 mL of oxidizing solution are added and the sample containers hermetically sealed. Under these conditions the samples are stable for at least 48 hours. If the oxidation reaction takes place within this time, the nitrates and phosphates produced remain constant even for 2 ÷ 3 months (Nydhal, 1978).
3. The samples, in a polyethylene bottle, are quickly frozen, without filtering.

4.2 Protocol for combined manual colorimetric determination of concentration of total nitrogen and total phosphorous

a. Equipment

The equipment for combined manual colorimetric determination of concentration of total nitrogen and total phosphorous include:

1. all that indicated for nitrate and orthophosphate determination
2. autoclave or normal pressure cooker (in the latter case it may be more practical to use, as sample containers, test tubes of about 50 mL with screw caps and Teflon seals and use a small volume)

b. Chemical product

The chemical products for combined manual colorimetric determination of concentration of total nitrogen and total phosphorous include:

1. all that indicated for nitrate and orthophosphate determination
2. disodium EDTA [$\text{C}_{10}\text{H}_{14}\text{N}_2\text{Na}_2\text{O}_8$]

c. Preparation of stock solutions

For the **determination of total nitrogen**, the stock solutions indicated in the Protocol for determination of nitrates and an organic nitrogen solution must be prepared.

Organic nitrogen solution (10 mmol L⁻¹)

186.2 mg of disodium-EDTA are dissolved in 90 mL of reagent grade water, adjusted to 100 mL in a volumetric flask (100 mL, class A) and stored in the refrigerator in a dark glass bottle. The solution is stable for a few months.

For the **determination of total phosphorus**, the solutions listed below must be prepared:

Sulfuric acid (4.5 mol L⁻¹)

250 mL of concentrated sulfuric acid to 750 mL of reagent grade water are carefully added, allowed to cool and adjusted to 1 L. Stored in a reagent bottle, the solution is stable indefinitely.

Mixed reagent

12.5 g of crystalline ammonium heptamolybdate tetrahydrate are dissolved in 125 mL of reagent grade water. 0.5 g of potassium antimony tartrate in 20 mL of reagent grade water are dissolved separately. The molybdate solution, while stirring, is added to 350 mL of 4.5 mol L⁻¹ sulfuric acid, then the potassium antimony tartrate solution is added and mixed. The solution is preserved in a dark glass bottle and stable for several months.

d. Analytical procedure

d.1. *Reagents to be prepared at the time of use*

Acidified solution of ascorbic acid

10 g of ascorbic acid are dissolved in 50 mL of reagent grade water and 50 mL of 4.5 mol L⁻¹ sulfuric acid added. The solution is stored in a dark glass bottle in the refrigerator. The solution can be used as long as it remains colorless (about a week), but is preferable to be prepared at the time of use.

d.2. *Preparation of standard solutions*

The Protocol for determination of concentrations of nitrate and orthophosphate must be followed.

d.3. *Preparation of the solution for checking the efficiency of the oxidizing reagent*

10 μmol L⁻¹ solution of nitrogen

In a 100 mL flask (class A) 100 μL (measured with a precision pipette) of organic nitrogen stock solution is diluted with reagent grade water. The solution is divided into two 50 mL subsamples and 5 mL of oxidizing reagent added. The entire amount of nitrogen present in the solution (10 μmol L⁻¹) must be determined. If this does not happen, the oxidizing solution must be prepared again.

d.4. *Preparation of reagent blanks*

50 mL of reagent grade water are transferred into 3 reaction vessels and each inoculated with 5 mL of oxidizing reagent.

The prepared blanks are autoclaved following the procedure indicated for the analytical treatment of the samples.

To prepare the blanks of the reagents related to the analysis of total nitrogen (bLN):

5 mL from each of the 3 containers are sampled with an automatic pipette and transferred into 100 mL beakers; 45 mL of reagent grade water are added to each;

To the blanks of the nitrogen reagents the same procedure applied to the samples and illustrated in detail in the Protocol for manual colorimetric determination of nitrate (ammonium buffer, reduction column, sulphanilamide, NNEDDC, spectrophotometric assay) is applied.

To prepare the blanks of the reagents related to the analysis of total phosphorus (bLP):

To each of the 50 mL left in the 3 containers as indicated for the analytical treatment of the samples the reagents (acidified solution of ascorbic acid and mixed reagent) are added.

The spectrophotometric measurement as indicated in the Protocol for manual colorimetric determination of orthophosphate are performed.

d.5. Analytical treatment

The containers with the samples and the solutions to be analysed are put in an autoclave or pressure cooker and autoclaved/cooked for at least 30 minutes at 120 °C.

The containers are brought to room temperature and checked that the sample volume has remained unchanged. If necessary, the volume is adjusted back to 55 mL with reagent grade water, but the change in volume which may have led to a parallel contamination of the sample recorded.

At the end of the oxidation stage, all the nitrogen in the sample should have been converted to nitrate and all the phosphorus to phosphate.

The procedures as indicated in the Protocols for the determination of nitrate and phosphate are followed, considering the following additions and modifications.

For nitrogen analysis

5 mL from each of the samples and of the two control samples with EDTA are sampled with an automatic pipette and transferred into 100 mL beakers; 45 mL of reagent grade water are added to each.

The same procedure illustrated in detail in the Protocol for manual colorimetric determination of nitrate (ammonium buffer, reduction column, sulphanilamide, NNEDDC, spectrophotometric assay) is applied.

For phosphorus analysis

The remaining 50 mL of sample are used and 1 mL of acidified solution of ascorbic acid with is added with a dispenser;

The solution is shaken and after about 30 seconds 1 mL of mixed reagent (measured with a dispenser) is added while shaking;

The same procedure illustrated in detail in the Protocol for manual colorimetric determination of orthophosphate is applied for the spectrophotometric measurement.

e. Calculations

The blanks of the of the cells ($bl_{c,i,N}$ and $bl_{c,i,P}$) are calculated as indicated in the Protocols for manual colorimetric determination of nitrate and orthophosphates.

The blank of the reagents (oxidizing reagent plus colour development reagent), both for phosphate (bl_P) and for nitrate (bl_N) are calculated as the average of the absorbance values of the three solutions with reagent grade water.

The colorimetric factor for the two components are calculated according to the procedure indicated in the Protocols for manual colorimetric determination of nitrate (f_N) and orthophosphate (f_P).

The concentrations are calculated according to the equations:

$$c(TN) / \mu\text{mol L}^{-1} = (ABS_N - bl_N - bl_{c,i,N}) \cdot f_N$$

$$c(TP) / \mu\text{mol L}^{-1} = (ABS_P - bl_P - bl_{c,i,P}) \cdot f_P$$

where:

ABS_N = absorbance of sample at 553 nm

ABS_P = absorbance of sample at 882 nm

$bl_{c,i,N}$ = blank of i-th cell at 553 nm

$bl_{c,i,P}$ = blank of i-th cell at 882 nm

bl_N = blank of nitrogen reagents

bl_P = blank of phosphorus reagents

f_N = colorimetric factor for nitrate

f_p = colorimetric factor for phosphate

f. Important notes and possible problems

The containers should be rinsed with reagent grade water for at least a couple of times. Between the determinations the containers should be kept filled with an HCl solution of approximately 0.1 mol L⁻¹.

The test solution should not be used to correct the reaction yield, but only as a rough check of the oxidation efficiency, since a reduced oxidizing power can occur in relation to the different type of nitrogen compounds involved in the reaction.

About the determination of nitrogen, it should be noted that some problems may be due to impurities of the reactants. It is important to use low nitrogen persulfate or to follow the recrystallization technique reported in Nydhal (1978). It is also important to always check the quality of the reagent grade water being used. In fact, ammonia is almost always present in closed environments and dissolves easily in water, water as soon as it comes out of the purifier must be used, even if this does not eliminate the risk of substances released by the exchange resins.

4.3 Protocol for the combined automated colorimetric determination of concentration of total nitrogen and total phosphorous

This Protocol do not differ in the analytical treatment of the samples from the Protocol for combined manual colorimetric determination of total nitrogen and total phosphorous (4.2) as is based on the identical methodology. The same equipment and chemical reagents must be prepared. The samples prepared and treated in the identical way together with the prepared reagent blanks and standards. At the time when the determination of the nitrate and orthophosphate are necessary the Protocol for automated colorimetric determination of nitrate and orthophosphate must be used for each of the analysed compound. The same problems identified for the automated methods for determination of nitrate and orthophosphate may arise and must be handled as indicated. The calculations are performed as is generally indicated in the Annex I: Automated methods for determination of concentration of key nutrients in seawater – Calculation of the concentration.

a. Symbol, units and precision

Symbol: $c(\text{TN})$	Unit: $\mu\text{mol L}^{-1}$	
Precision: ± 0.02	Accuracy: ± 0.02	LOD: 0.03
Method identifier: SDN:P01::NTOTWCTX		Concentration of total nitrogen {total_N} per unit volume of the water body [dissolved plus reactive particulate phase] by oxidation and colorimetric autoanalysis
Symbol: $c(\text{TP})$	Unit: $\mu\text{mol L}^{-1}$	
Precision: ± 0.02	Accuracy: ± 0.02	LOD: 0.05
Method identifier: SDN:P01::TPHSP01		Concentration of total phosphorus {total_P CAS 7723-14-0} per unit volume of the water body [dissolved plus reactive particulate phase] by oxidation and colorimetric analysis

Annex I**Automated methods for determination of concentration of key nutrients in seawater –
Calculation of the concentration**

1. Many automatic nutrient analysis systems are equipped with software that allows, with more or less sophisticated algorithms, to determine the height of the peak and to provide the concentration of the individual samples having previously determined the calibration and the reagent blank value. Although the software may be sophisticated, it is not always able to manage anomalous events, so it is advisable to continuously monitor the operation of the instrument.

3. Considering the current availability of calculation programs such as spreadsheets, the best solution is to obtain from the analyser the values of the three components necessary to calculate the concentrations, i.e. the blank value, that of the baseline near the samples and that of the individual samples. The procedure suggested below is certainly not the only one possible and, once again, it will be up to the operator to decide which paths to follow.

4. Operationally: The instrument is stabilized with the reagents and ultrapure water (DDW) for 15-20 minutes. It is verified that the hydraulics are stable (regular bubbles and stable baseline). The refractive index is then determined by continuously sampling first the ultrapure water (DDW) and then the washing water (OSW), having replaced one of the reagents, usually the one with lower flow rate, with ultrapure water. The difference in reading is recorded which corresponds to the false absorption due to refraction. The replaced reagent is reinserted, and the baseline is re-stabilized with DDW. For the analysis of the samples the DDW is replaced with OSW (the drawing needle is moved from one container to another) and waited for the baseline to re-stabilize. Then the sampler is activated by arranging the samples in groups (usually one or more stations) and taking care to combine the groups with an OSW reading. In this way each group of samples is sandwiched between two OSW readings, which allow a good control of baseline drift. It is also good practice to periodically analyze a series of solutions of known concentration (standards) which must always be prepared daily. Usually, at least one series of standards with increasing concentration is inserted at the beginning of the series of samples and one at the end. If the series of samples is very long, further series of intermediate standards can be inserted. Standards must be in increasing concentrations so that the difference between the lowest and highest includes the range of concentrations expected for the samples to be analysed. This procedure allows both to determine the linearity of response to the Lambert-Beer law (i.e. to determine the slope of the extinction / concentration line of the increasing standards which, in the absence of blank, should pass through the origin of the axes) in the expected concentration range, and to determine any variations in the efficiency of the method (gain) which would be highlighted by significant variations of this slope with the progress of the analysis. In fact, the slope of the initial standardization line, ie its angular coefficient and its reciprocal value F , will almost never coincide with those of the final and / or intermediate standards. The simplest solution to this problem is to take the average between initial, final and / or intermediate F and use this average F_m in the calculation. The most correct, but more complicated, procedure consists in determining the sequential reading "gain" sample by sample, similar to what is done for the calculation of the baseline drift and multiplying the reading value of each sample by its own F so determined. Once the samples have been analysed, it is good practice to re-measure the DDW reading and wash the circuit without the reagents.

5. To calculate the concentrations, the following quantities (the values are in the unit in use, cm if you read on the trace of a recorder or digital counts if you work on the outputs of the A / D converter) must be obtained:

V_{DDW} = value of the DDW reading at the time of blank determination

V_{OSW0} = value of the OSW reading after the blank (DDW)

R = OSW baseline variation in mm by refractive index

V_{OSW_i} = value of the OSW reading that precedes the first of the samples of the group

N_{OSW_i} = sequential number of the OSW reading that precedes the group of samples

V_{OSW_n} = value of the OSW reading that follows the last of the group samples

N_{OSW_n} = sequential number of the OSW reading after the last sample of the group

V_s = value of the sample reading

N_s = sequential number of the sample reading

D = drift

F_m = average factor obtained from the standard curves (the reciprocal of the slope or angular coefficient of the straight-line reading-concentration of the calibration samples)

c = concentration of the sample

the concentration of the sample is given by the equation:

$$c(\text{Nut.})/\mu\text{mol L}^{-1} = [V_s - D(N_s - N_{OSW_i}) - V_{OSW_i} + (V_{OSW_0} - V_{DDW}) - R] F_m$$

where the drift (D) is given by:

$$D = (V_{OSW_n} - V_{OSW_i}) / (N_{OSW_n} - N_{OSW_i})$$

6. The refractive index refers to the shift of the baseline in the absence of reactants due to the difference in salinity between deionized distilled water (DDW) and oligotrophic water (OSW).

References

- Grasshoff, K., Kremling, K., Ehrhardt, M. (eds), 1999. *Methods of Seawater Analysis* 3rd Edition Wiley-VCH Weinheim, 634 pp.
- Strickland J.J., Parsons T., 1965. *A manual of sea water analysis: with special reference to the more common micronutrients and to particulate organic material.* Fisheries Research Board of Canada, 311 pp.
- UNEP/MAP/MED POL, 2005. *Sampling and Analysis Techniques for the Eutrophication Monitoring Strategy of MED POL.* MAP Technical Reports Series No. 163. UNEP/MAP, Athens, 46 pp.
- UNEP/MAP, 2019. UNEP/MED WG.467/5. *IMAP Guidance Factsheets: Update for Common Indicators 13, 14, 17, 18, 20 and 21: New proposal for candidate indicators 26 and 27.*
- UNEP/MAP, 2019a. UNEP/MED WG.463/6. *Monitoring Protocols for IMAP Common Indicators related to pollution.*
- UNEP/MAP, 2019b. UNEP/MED WG.463/10. *Schemes for Quality Assurance and Control of Data related to Pollution.*

Orthophosphate

- Airey D., Dal Pont G., Sandars G. (1984) A method of determining and removing sulphide to allow the determination of sulphate, phosphate, nitrite and ammonia by conventional methods in small volumes of anoxic waters. *Analytica Chim. Acta*, 166, 79-92.
- Boltz D.F., Mellon M.G. (1947) Determination of phosphorus, germanium, silicon, and arsenic by the heteropolyblue method. *Ind. Eng. Chem. Anal. Ed.*, 19, 873-877.
- De Jonge V.N., Villerius L.A. (1980) Interference of sulphide in inorganic phosphate determination in natural waters. *Mar. Chem.*, 9, 191-197.
- Deniges M.G. (1920) Reaction de coloration extrêmement sensible des phosphates et des arseniates. Ses applications. *C. R. Acad. Sci., Paris*, 171, 802-804.
- Koroleff F. (1983a) Determination of phosphorus. In: "Methods of Seawater Analysis", Grasshoff K., M. Ehrhardt, K. Kremling Eds, Verlag Chemie, Weinheim, 125-139.
- Murphy J., Riley J.P. (1958) A single-solution method for the determination of soluble phosphate in sea water. *J. Mar. Biol. Ass. U.K.*, 37, 9-14.
- Murphy J., Riley J.P. (1962) A modified single solution method for the determination of phosphate in natural waters. *Analytica Chim. Acta*, 27, 31-36.
- Novoselov A.A., Sheremet'Yeva A.I., Danilenko A.F. (1976) Method for simultaneous obtaining silicon-free and phosphate-free sea water aboard ship. *Oceanology*, 16, 358-359.

Orthosilicate

- Bien G.S. (1958) Salt effect correction in determining soluble silica in sea water silicomolybdic acid method. *Anal. Chem.*, 30, 1525-1526.
- Burton J.D., Leatherland T.M. (1970) The reactivity of dissolved silicon in some natural waters. *Limnol. Oceanogr.*, 15, 473-476.
- Fanning K.A., Pilson M.E.Q. (1973) On the spectrophotometric determination of dissolved silica in natural waters. *Anal. Chem.*, 45, 136-140.
- MacDonald R.W., McLaughlin F.A. (1982) The effect of storage by freezing on dissolved inorganic phosphate, nitrate and reactive silicate for samples from coastal and estuarine waters. *Water Res.*, 16, 95-104.
- MacDonald R.W., McLaughlin F.A., Wong C.S. (1986) The storage of reactive silicate samples by freezing. *Limnol. Oceanogr.*, 31, 1139-1142.

- Morrison I.R., Wilson A.L. (1963) The absorptiometric determination of silicon in water. Part I. Formation, stability and reduction of [β - and α -molybdosilicic acids. *Analyst*, 88, 88-99.
- Mullin J.B., Riley J.P. (1955) The colorimetric determination of silicate with special reference to sea and natural waters. *Analytica Chim. Acta*, 12, 162-176.
- Strickland J.D.H. (1952) The preparation and properties of silicomolybdic acid. II. The preparation and properties of alpha silicomolybdic acid. *J. Amer. Chem. Soc.*, 74, 868-871
- Truesdale V.W., Smith C.J. (1975) The formation of molybdosilicic acids from mixed solutions of molybdate and silicate. *Analyst*, 100, 203-212.

Total Nitrogen and total Phosphorous

- Koroleff F. (1968) Determination of total phosphorus in natural waters by means of persulphate oxidation. *ICES C.M./C*, 33, 209-212.
- Koroleff, F. (1983b) Total and organic nitrogen. In: "Methods of Seawater Analysis", Grasshoff K., M. Ehrhardt, K. Kremling Eds, Verlag Chemie, Weinheim, 162-173.
- Nydahl F. (1978) On the peroxodisulphate oxidation of total nitrogen in waters to nitrate. *Talanta*, 12, 1123-1130.
- Valderrama J.C. (1981) The simultaneous analysis of total nitrogen and total phosphorus in natural waters. *Mar. Chem.*, 10, 109-122

Appendix 15
Monitoring Guidelines/Protocols for Determination of Chlorophyll *a* in Seawater

1. Introduction

1. In the Monitoring Guidelines for Determination of Chlorophyll *a* in Seawater, the four protocols for determination of the concentration of chlorophyll *a* are elaborated. The concentration of in the sea is an important indicator for the presence of algae and other plant-like organisms that carry out photosynthesis. As such, phytoplankton, which contains the chlorophyll, is an essential element of the food chain in the seas as it provides the food for numerous animals. Variations and changes in the chlorophyll levels are also relevant for the study of the ecology of the sea. At the moment, the water classification scheme on which the assessment of GES regarding Ecological Objective 5 related to eutrophication is based on chlorophyll *a* concentration as presented in the IMAP Guidance Factsheets (UNEP/MAP, 2019)¹⁸⁷.

The IMAP Protocols elaborated within this Monitoring Guidelines for Determination of Chlorophyll *a* in Seawater provide detail guidance on the necessary equipment, chemical reagents, analytical procedures along with appropriate methodologies for measurement of the concentration of chlorophyll *a* in sea water, calculations, data transformation if necessary and identify weak points all endorsed through important notes and possible problems. However, they are not intended to be analytical training manuals, but guidelines for Mediterranean laboratories, which should be tested and accordingly modified, if need be, in order to validate their final results.

This Monitoring Guidelines builds upon the UNEP/MAP Integrated Monitoring and Assessment Programme (IMAP) respectively IMAP Guidance Fact Sheets for IMAP Common Indicators 13 and 14 (UNEP/MAP, 2019); standardized protocols (UNEP/MAP, 2019a)¹⁸⁸ and Data Quality Assurance schemes (UNEP/MAP, 2019b)¹⁸⁹ in order to allow the comparability of the data and build of regional assessment schemes. They also take into account previous Sampling and Analysis Techniques for the Eutrophication Monitoring Strategy of MED POL (UNEP/MAP/MED POL, 2005)¹⁹⁰, however providing detail procedures that are of relevance for IMAP implementation. With the details of the protocols for determination of chlorophyll *a*, the needs of the measurements both in off-shore areas and in narrow coastal areas are addressed.

In the Subchapters “Symbol, units and precision” at the end of each Protocol, for all parameters described in it, the symbol and unit suggested by the International System of Units (SI) are presented. The expected accuracy, precision and where possible the Limit of Detection (LOD) are also presented. A Method identifier is also presented as it is provided in the Library P01 of the British Oceanographic Data Centre (BODC) Parameter Usage Vocabulary respectively included in Data Dictionaries and Data Standards for eutrophication built in IMAP Pilot Info System.

The below flow diagram informs on the category of this Monitoring Guidelines related to determination of chlorophyll *a* in seawater within the structure of all Monitoring guidelines prepared for IMAP Common Indicators 13, 14, 17, 18 and 20.

¹⁸⁷ (UNEP/MAP, 2019), UNEP/MED WG.467/5. IMAP Guidance Factsheets: Update for Common Indicators 13, 14, 17, 18, 20 and 21: New proposal for candidate indicators 26 and 27.

¹⁸⁸ (UNEP/MAP, 2019a), UNEP/MED WG.463/6. Monitoring Protocols for IMAP Common Indicators related to pollution.

¹⁸⁹ (UNEP/MAP, 2019b), UNEP/MED WG.467/10. Schemes for Quality Assurance and Control of Data related to Pollution

¹⁹⁰ (UNEP/MAP/MED POL), 2005. Sampling and Analysis Techniques for the Eutrophication Monitoring Strategy of MED POL. MAP Technical Reports Series No. 163. UNEP/MAP, Athens, 46 pp.

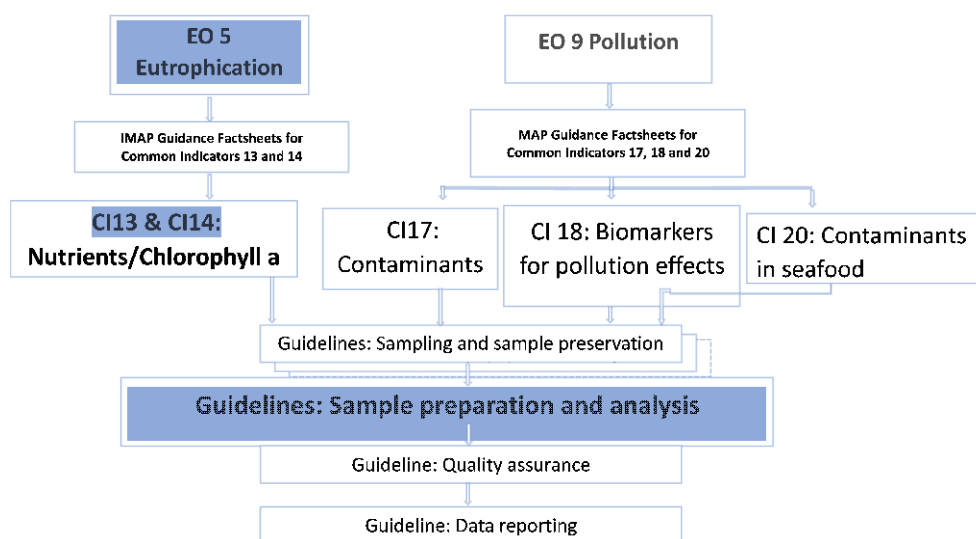

Flow Diagram: Monitoring Guidelines for IMAP Ecological Objectives

2. Technical note for determination of concentration of chlorophyll *a*

In this note the photometric, fluorometric and HPLC methods are presented, that are based on a characteristic common to all autotrophic organisms, i.e., the presence of pigments that allow to capture the light and transfer it to the reaction centres where photosynthesis begins. In the marine environment, except for a small fraction of very ancient bacteria (Kolber et al., 2001)¹⁹¹, all phototrophic organisms, i.e. those that use light to live, have either chlorophyll *a*, or a very similar pigment, divinyl chlorophyll *a*, while accessory pigments, mostly carotenoids, can change from group to group.

The methods are based on the evidence that the amount of pigments present in a planktonic organism are related with its total biomass. It should also be added that the methods used for the collection of phytoplanktonic biomass (essentially represented by filtration) do not allow to separate the phytoplanktonic carbon from the non-phytoplanktonic carbon (organic debris), simultaneously present in marine water.

In summary, although the carbon measurements are the most correct for an estimate of the phytoplankton biomass, those based on chlorophyll *a* are still the most used, both for historical and practical reasons. In fact, the former, despite the recent technical progress, are more expensive and complicated than those of the pigments proposed here.

These methods, both photometric and fluorometric, are optimal when a limited economic and time commitment is expected, while the recent chromatographic separation techniques of the pigment mixture (essentially by HPLC: Robinson, 1979¹⁹²) are costly and time demanding and not always sustainable for all laboratories.

The wide diffusion of the spectrophotometric method is also motivated by the fact that the instrument used is almost always present in an analytical laboratory, for the many determinations based on the measurement of the absorbance of coloured substances. The contraindication of the

¹⁹¹ Kolber Z.S., Gerald Plumley F., Lang A.S., Beatty T.J., Blankenship R.E., Vandover C.L., Vetriani C., Koblizek M., Rathgeber C., Falkowski P.G., 2001. Contribution of Aerobic Photoheterotrophic Bacteria to the Carbon Cycle in the Ocean. *Science*, 292: 2492-2495.

¹⁹² Robinson, A.L., 1979. HPLC: the new king of analytical chemistry. *Science*, 203: 1329-1332.

spectrophotometric method is its reduced sensitivity, compared to methods based on fluorescence. This entails either the use of cells with a higher optical path (10 cm), which in any case generate the problem of having a larger volume of solvent for extraction and waiting for the reading to stabilize, or for the filtration of large volumes of water. This is not always possible given that in the open sea and in periods other than those of intense blooms, 4-5 L are the minimum quantity necessary to obtain reliable results. Filtering large volumes of water always presents many difficulties, both for sampling, and for increasing the filtration time and for the need to use larger filters and / or ad hoc filtration systems.

On the contrary, the fluorometric method allows to obtain reliable data by filtering smaller quantities of water, using filters of smaller diameter and obtaining lower extract volumes. All these aspects make the measurement of fluorescence in overall more practical and economical, excluding the initial acquisition of a fluorimeter, both with filters and with monochromator, even if recently instruments at affordable costs have been placed on the market. However, it is good to consider that these analytical tools are suitable for fewer applications for environmental analysis. Finally, it should be remembered that all methods of measuring pigment concentrations, including HPLC and fluorometric techniques, are based on calibrations that necessarily use optical density measurements, which makes the use of the spectrophotometer irreplaceable.

The differences between the concentrations obtained by spectrophotometry-UV, fluorimetry, and spectrophotometry is visible; after the chromatography, can be significant if degradation products are present¹⁹³. The simultaneous use of the methods in the same programs is not encouraged.

Under this Technical Note, the Monitoring Guidelines for Determination of Chlorophyll *a* in Seawater elaborates the four following Protocols:

- Protocol for sample pretreatment for determination of concentration of chlorophyll *a*;
- Protocol for spectrophotometric determination of concentration of chlorophyll *a*;
- Protocol for fluorometric determination of concentration of chlorophyll *a*;
- Protocol for HPLC determination of concentration of chlorophyll *a*.

2.1 Protocol for sample pre-treatment for determination of concentration of chlorophyll *a*

After the suspended particulates containing fat-soluble pigments have been concentrated on a glass fibre filter by means of filtration the chlorophyll pigments are extracted from the cells, shredding and by homogenizing the filters, immersed in a mixture of acetone and water.

a. Specific equipment

The equipment for sample pre-treatment includes the following pieces:

- i) Centrifuge for 12 mm diameter tubes, capable of reaching 4000 rpm, preferably refrigerated.
- ii) Homogenizer (potter) with ground glass or Teflon pestle.

b. Chemical products and reagents

¹⁹³ Dos Santos, A.C.A., Calijuri, M.C., Moraes, E.M., Adorno, M.A.T., Falco, P.B., Carvalho, D.P., Deberdt, G.L.B., Benassi, S.F. 2003. Comparison of three methods for Chlorophyll determination: Spectrophotometry and Fluorimetry in samples containing pigment mixtures and spectrophotometry in samples with separate pigments through High Performance Liquid Chromatography. Acta Limnol. Bras., 15(3):7- 18.

For sample pre-treatment for determination of concentration of chlorophyll *a*, the following products and reagents are needed:

- i) Acetone, p.a. [(CH₃)₂CO]
- ii) Sodium carbonate [NaCO₃]
- iii) Hydrochloric acid [HCl]
- iv) 90% v/v neutral acetone: 100 mL of reagent grade water and 900 mL of neutral acetone (see above) separately measured are mixed. The solution is always kept away from light and in the presence of sodium carbonate.
- v) Hydrochloric acid 0.66 mol L⁻¹: 55 mL of concentrated hydrochloric acid (HCl 37% v/v) is slowly poured (under stirring) in 950 mL of reagent grade water.

c. *Procedure*

After filtration, filters are either frozen in liquid nitrogen (after being folded and placed into cryotubes) and transferred at -80°C until analyses or directly placed in the freezer at -80°C. For pigment extraction, frozen filters are directly placed in 90% acetone and triturated and homogenized for a maximum of 2 min by carefully rinsing the pestle of the homogenizer several times.

This operation must be carried out using a volume of acetone equal to that of the pure acetone used to store the filter. Since the final extract must be in 90% acetone and considering that the filter retains water (for a 47 mm GF/F filter about 0.7 mL), generally 5 mL of 90% acetone are added to the 5 mL of pure acetone.

If the sample is analysed immediately after filtration, the shredding and homogenization operations must be carried out directly with 90% acetone. The homogenization of the filter by potter causes a gradual heating of the extraction liquid, with possible partial degradation of the pigments. This inconvenience can be limited by using cold acetone (4 °C) or by placing the test tube in a beaker with ice, in any case containing the operation within a maximum time of 2 minutes.

The sample can also be homogenized by manual shredding with a glass rod, directly inside the test tube used for storage; in this case it is appropriate to estimate quantitatively what the possible decrease in efficiency is, compared to the instrument shredding.

Note, that the use of ultrasound does not seem to give good results (Nusch, 1980)¹⁹⁴ as it produces excessive heating of the extract and is therefore not recommended.

The test tube carefully capped with the obtained suspension (10 mL of 90% acetone) must be kept at 4 °C in the dark for 24 hours to complete the extraction. The closed tubes are centrifugated for 10 minutes at 4000 rpm (or 3500 for 12 minutes, if not refrigerated).

2.2 Protocol for spectrophotometric determination of concentration of chlorophyll *a*

The spectrophotometer to be used should preferably be equipped with an interference grid and a bandwidth of 1-2 nm, with cells of at least 50 mm (preferably 100 mm) with optical path and reduced volume (max 7 mL). It is important that the wavelength is carefully adjusted, frequent checks must be

¹⁹⁴ Nusch, E., 1980. Comparison of different methods for chlorophyll and phaeopigment determination. Arch. Hydrobiol. Beih., 14: 14-35.

carried out following the instructions of the manufacturer of the equipment. For spectrophotometers with a hydrogen or mercury lamp, the respective lines (hydrogen - 656 nm; mercury - 546 nm) must be checked.

With the new generations of diode lattice spectrophotometers these tasks are easier to be performed. They are even connected to a PC that allows data to be stored in digital format and therefore immediately usable for the calculations necessary for estimating concentrations.

a. Reading and calculations

After the final centrifugation of the extract, the supernatant, using a pipette or syringe, is transferred to the cell.

Three different methods for estimating photosynthetic pigments are available:

- i) method for estimating chlorophyll *a* with phaeopigments;
- ii) method for the separate estimation of chlorophylls *a*, *b* and *c*;
- iii) method for the separate estimation of chlorophyll *a* and phaeopigments.

The first method reported involves an error of variable magnitude, due to the presence of both accessory pigments (chlorophylls *b* and *c*) which have an absorption maximum even at 664 nm, both for pheophytins and pheophorbides, the main degradation products of chlorophylls. However, this method is preferable when you want to lower the sensitivity threshold of the estimate (e.g. for concentrations lower than 0.4 µg L⁻¹), as it allows a more "robust" and reliable estimate of the pigment biomass.

The other two methods allow to obtain a more precise estimate of chlorophyll *a* alone in the presence of significant quantities of chlorophyll *b* and *c*, using readings at multiple wavelengths (Jeffrey and Humphrey, 1975¹⁹⁵; Lorenzen and Jeffrey, 1980¹⁹⁶) or in the presence of significant quantities of its degradation products, having treated the extract with hydrochloric acid (Lorenzen, 1967)¹⁹⁷.

b. Method 1. Concentration of chlorophyll a

This method is based on the assumption that the maximum absorption peak of chlorophyll *a* is at 664 nm with a specific absorption coefficient of 87.67 cm⁻¹ g⁻¹ L (Jeffrey and Humphrey, 1975) and the phaeopigments are not present in high quantity.

Absorbance of the sample is read at 664 and 750 nm against a blank of 90%-acetone (not neutralized).

The concentration (*c*) of chlorophyll *a* (Chl *a*) is calculated applying the following formula:

$$c(\text{Chl } a)/\mu\text{g L}^{-1} = \{[A(s,664)-A(b,664)]-[A(s,750)-A(b,750)]\} \cdot 10^6 / (a^* \cdot op \cdot V)$$

where:

¹⁹⁵ Jeffrey S.W., Humphrey G.F., 1975. New spectrophotometric equations for determining chlorophylls *a*, *b*, *c1* and *c2* in higher plants, algae and natural phytoplankton. *Biochem. Physiol. Pflanzen.*, 167: 191-194.

¹⁹⁶ Lorenzen C.J., Jeffrey S.W., 1980. Determination of chlorophyll in sea water. *UNESCO Tech. Pap. Mar. Sci.*, 35: 1-20.

¹⁹⁷ Lorenzen C.J., 1967. Determination of chlorophyll and phaeopigments spectrophotometric equations. *Limnol. Oceanogr.*, 12: 343-346.

$A(s, 664)$ = Absorbance of the sample at 664 nm;

$A(s, 750)$ = Absorbance of the sample at 750 nm;

$A(b, 664)$ = Absorbance of white at 664 nm;

$A(b, 750)$ = Absorbance of the blank at 750 nm;

a^* = specific absorption coefficient of chlorophyll a in 90% acetone at 664 nm ($87.67 \text{ cm}^{-1}\text{g}^{-1} \text{ L}$)

op = optical path of the cell (cm);

v = volume of the extract (mL); and

V = volume of filtered sample (mL).

c. Method 2. Concentrations of chlorophylls a, b and c

The method should be used to provide accurate estimates of chlorophylls a , b and $c_1 + c_2$ on phytoplanktonic samples of mixed populations, when no significant quantities of their degradation products are present (Jeffrey and Welschmeyer, 2005¹⁹⁸; Humphrey and Jeffrey, 2005¹⁹⁹).

Absorbance at wavelengths of 630, 647, 664 and 750 nm are to be read, to estimate the incidence of the concentration of the chlorophylls b and c on the concentration of chlorophyll a (Lorenzen and Jeffrey, 1980). By applying this method, it is also necessary to read the blanks at respective wavelengths.

Determine the net absorbance of the extract at each wavelength [$A(l)$] according to the equation:

$$A(l) = [A(s, l) - A(b, l)] - [A(s, 750) - A(b, 750)]$$

where:

$A(b, l)$ = Absorbance of the blank at l nm;

$A(s, l)$ = Absorbance of the sample at l nm;

$A(b, 750)$ and $A(s, 750)$ are defined as above.

Calculate the concentrations of chlorophylls (Chl a , b and c) by applying the following equations:

$$c(\text{Chl } a)/\mu\text{g L}^{-1} = [11.85 A(664) - 1.54 A(647) - 0.08 A(630)] v 10^3 / (op V)$$

$$c(\text{Chl } b)/\mu\text{g L}^{-1} = [-5.43 A(664) + 21.03 A(647) - 2.66 A(630)] v 10^3 / (op V)$$

$$c(\text{Chl } c_1 + c_2)/\mu\text{g L}^{-1} = [-1.67 A(664) - 7.60 A(647) + 24.52 A(630)] v 10^3 / (op V)$$

¹⁹⁸ Jeffrey S.W., Welschmeyer N.A., 2005. Spectrophotometric and fluorometric equations in common use in oceanography. In: Jeffrey S.W., Mantoura R.F.C., Wright S.W. (eds), Phytoplankton pigments in oceanography: guidelines to modern methods. 2nd ed. SCOR UNESCO, Paris: 597-615.

¹⁹⁹ Humphrey G.F., Jeffrey S.W., 2005. Test of accuracy of spectro-photometric equations for the simultaneous determination of chlorophylls a , b , c_1 and c_2 . In: Jeffrey S.W., Mantoura R.F.C., Wright S.W. (eds), Phytoplankton pigments in oceanography: guidelines to modern methods. 2nd ed. SCOR UNESCO, Paris: 616-621.

where:

A (l), *op*, *v* and *V* have the meaning already expressed above.

The values of the concentrations of chlorophylls b and c can be negative when these pigments are present in very low concentrations and cannot be determined with this method, or if there are many phaeopigments that disturb the readings.

d. Method 3. Concentrations of chlorophyll a and phaeopigments

The method allows to determine the concentrations of chlorophyll *a* and phaeopigments (pheophytins, pheophorbides, chlorophyllides) assuming that the ratio between their specific absorption coefficients is equal to that between chlorophyll *a* and pheophytin *a* (Lorenzen, 1967).

The analytical procedure involves the addition of 50 µL (one drop) of HCl (0.66 mol L⁻¹) for every 5 mL of extract directly into the spectrophotometer cell immediately after the readings at 665 and 750 nm. The cell must be shaken repeatedly and it is necessary to wait 30 to 60 seconds before repeating the readings at the same wavelengths. In this way, all the chlorophyll *a* present in the extract is converted into pheophytin *a*. It is important to keep in mind that the final acid concentration in the extract must not greatly exceed the value of 3 · 10⁻³ mol L⁻¹ (30 µL of HCl 0.66 mol L⁻¹ for each ml of extract), to avoid that the carotenoids present are transformed into a compound that absorbs in the red, thus altering the value of the reading of the phaeopigments (Riemann, 1978)²⁰⁰.

Determine the net absorbance of the extract before acidification [A (665o)] and after acidification [A (665a)] according to the equation:

$$A(665\alpha) = [A(s, 665\alpha) - A(b, 665\alpha)] - [A(s, 750\alpha) - A(b, 750\alpha)]$$

where:

A(b, 665) = Absorbance of the blank at 665 nm;

A(b, 750) = Absorbance of the blank at 750 nm;

A(s, 665α) = Absorbance of the sample at 665 nm before (α = o) or after acidification (α = a);

A(s, 750 α) = Absorbance of the sample at 750 nm before (α = o) or after acidification (α = a).

The concentrations of chlorophyll *a* (Chl *a*) and phaeopigments are calculated applying the following equations:

$$c(\text{Chl } a)/\mu\text{g L}^{-1} = 26.73 [A(665o) - A(665a)] v 10^3 / (op V)$$

$$c(\text{Phaeopigments})/\mu\text{g L}^{-1} = 26.73 [1.7 A(665a) - A(665o)] v 10^3 / (op V)$$

where:

A(665o) = net optical density of the sample at 665 nm before acidification;

²⁰⁰ Riemann, B., 1978. Carotenoid interference in the spectrophotometric determination of chlorophyll degradation products from natural population of phytoplankton. *Limnol. Oceanogr.*, 23: 1059-1066.

$A(665a)$ = net optical density of the sample at 665 nm after acidification;

op , v and V have the meaning already expressed above.

e. Important notes

Instruments with interferential lattice has an optimal reading range, with respect to the measurement error, between 0.2 and 0.8 absorbance units (Strickland and Parsons, 1968)²⁰¹. The minimum concentration of chlorophyll *a* at which, using 100 mm cells of optical path, in the extract is 228 $\mu\text{g L}^{-1}$, which is equivalent to an *in situ* concentration of 0.46 $\mu\text{g L}^{-1}$, in the case 5 L of sample have been filtered. However, if the optical conditions of the measurement and the accuracy are satisfactory ($\pm 0.002 A$), readings are also valid with absorbances, at 664 nm, of 0.050 (Neveux, 1979)²⁰² corresponding to an *in situ* value of 0.11 $\mu\text{g L}^{-1}$.

If the absorbance of the blank exceeds 0.008 it is necessary to carefully clean the outside of the cells and if the readings value is still high, it is necessary to immerse the cells in sulphochromic mixture for 10 minutes and then rinse them abundantly with water before to repeat the reading. If the absorbance does not decrease, check that the disturbance is not due to impurities present in the acetone and if necessary, filter it carefully.

The reading at 750 nm gives an estimate of the turbidity of the sample and must not exceed the value of 0.010 of absorbance (i.e. 0.002 for each cm of optical path); otherwise it is necessary to repeat the centrifugation or filter the sample with a syringe equipped with a "Swinnex" support in which a 13 mm diameter Teflon filter with a porosity of 0.2 μm is inserted.

2.3 Protocol for fluorometric determination of concentration of chlorophyll *a*

The estimation of the concentration of chlorophyll *a* and phaeopigments with the fluorometric method is based on the measurement of the fluorescence of the pigments in acetone extract, before and after acidification with hydrochloric acid. The photosynthetically active (chlorophyll *a*) and inactive (phaeopigments) fractions of the chlorophyll pigments present (Yentsch and Menzel, 1963²⁰³; Holm-Hansen et al., 1965²⁰⁴) are measured. Compared to spectrophotometric ones, fluorometric methods are more sensitive, precise and rapid, however the use is recommended only when the concentration of the pigments is low, since, for high values, the relationship between fluorescence and concentration is no longer linear. The upper limit within which the relationship remains such is approx. 750 $\mu\text{g L}^{-1}$ in the acetone extract (Neveux, 1979) and approx. 1.5 $\mu\text{g L}^{-1}$ in sea water (Bianchi, 1986)²⁰⁵. In any case, this linearity interval must be verified for each instrument. Furthermore, the validity of these methods is strongly conditioned by the heterogeneity of the pigment mixture, in particular by the concentration of chlorophyll *b* in the acetone extract (Yentsch, 1965²⁰⁶; Loftus and Carpenter, 1971²⁰⁷; Gibbs, 1979²⁰⁸). In fact, the pheophytin *b* produced by the degradation of this pigment shows an emission peak at 651 nm which, inversely to that of pheophytins *a* and *c*, shows a strong increase compared to the corresponding chlorophyll, thus causing, if present, an overestimation of the phage pigments.

²⁰¹ Strickland, J.D.H., Parsons T.R., 1968. A Practical Handbook of Seawater Analysis. Bull. Fish. Res. Bd. Can., 167: 1-310.

²⁰² Neveux, J., 1979. Pigments chlorophylliens. In: Jacques G. (ed), Phytoplankton, Biomasse, Production, Numeration et Culture. Edition du Castellet, Perpignan: 1-107.

²⁰³ Yentsch, C.S., Menzel, D.W., 1963. A method for the determination of phytoplankton chlorophyll and phaeophytine by fluorescence. Deep Sea Res., 10: 221-231.

²⁰⁴ Holm-Hansen O., Lorenzen C.J., Holmes R.W., Strickland J.D.H., 1965. Fluorimetric determination of chlorophyll. J. Cons. Int. Explor. Mer., 30: 3-15.

²⁰⁵ Bianchi, F., 1986. Relazioni fra misure di clorofilla in Adriatico settentrionale. Arch. Oceanogr. Limnol., 20: 287-292.

²⁰⁶ Yentsch, C.S., 1965. Distribution of chlorophyll and phaeophytine in the open ocean. Deep Sea Res., 12: 653- 666.

²⁰⁷ Loftus M.E., Carpenter J.H., 1971. A fluorometric method for determining chlorophylls *a*, *b* and *c*. J. Mar. Res., 29: 319-338.

²⁰⁸ Gibbs, C.F., 1979. Chlorophyll *b* interference in the fluorometric determination of chlorophyll *a* and phaeopigments. Aust. J. Mar. Freshwater Res., 30: 597-606.

Finally, the presence in the samples of other compounds that fluorescence in red should not be underestimated, since they can lead to erroneous estimates of chlorophyll *a* and phaeopigments.

a. Equipment

The equipment for fluorometric determination of concentration of chlorophyll *a* include: i) Spectrophotometer, see considerations in the previous paragraphs; and ii) Filter fluorometer or spectrofluorometer.

If a filter fluorometer is used, it is recommended to use an F474-BL lamp as the light source and a Corning CS.5-60 or Kodak Wratten 47B as excitation filter and a Corning CS.2-64 as emission filter. The instrument must be equipped with a photomultiplier with sensitivity extended to the 800 nm band (e.g. Hamamatsu R446). Even if measurements are taken with a spectrofluorometer, it is necessary to use a photomultiplier with extended sensitivity in the red region. Furthermore, it is necessary to calibrate/check the wavelengths of the monochromators; the simplest calibration consists in the emission scan of a sample of deionized water, placing the excitation monochromator at 350 nm: the maximum peak (called "Raman water peak") must be at 397 ± 2 nm. As a bandwidth, the recommended setting is 4-5 nm in excitation and 10 nm in emission.

b. Procedure

b.1. Fluorometric measurements

After the extract become clear the extracts are transferred to the fluorometric cuvettes.

Fluorometric readings (excitation – exc; emission – ems) are taken at the maximum wavelengths of chlorophyll *a*, ($I_{exc} = 430$ nm, $I_{ems} = 665$ nm) if a spectrofluorometer is used;

Two fluorometric readings for each sample are taken: i) F_o : the sample as it is; ii) F_a : the sample after adding 1 drop of a 1N HCl solution (after 1 minute); and the fluorescence range is noted in which all measured samples are included.

b.2. Preparation of the initial standard

A standard solution of pure commercial chlorophyll *a* (stock solution) is prepared by dissolving the standard, supplied in crystalline form, in a 90% (v / v) acetone solution;

The optical density of this solution is read with a spectrophotometer (in general an absorbance at 664 nm equal to about 0.09 units with a 10 mm cell is obtained);

The concentration of the stock solution (in mg L⁻¹) is calculated using the following equation:

$$c(\text{Chl } a)/\mu\text{g L}^{-1} = [A(664) - A(750)]. (a^* \text{ } op)^{-1} 10^6$$

where

A(664) = Absorbance at 664 nm;

A(750) = Absorbance at 750 nm;

a^* = specific absorption coefficient of chlorophyll *a* in 90%-acetone at 664 nm ($87.67 \text{ cm}^{-1}\text{g}^{-1}$);

op = optical path of the cuvette, in cm.

The spectra (SPT) are scanned before (SPT_o) and after (SPT_a) acidification of the mother solution with a drop of 1N HCl; saved and the maximum excitation and emission noted.

The spectra have to be compared with those of chlorophyll *a* and pheophytin *a* reported in the literature, these scans must be repeated frequently to verify the possible existence of degradation processes in progress in the standard solution.

The linearity of the instrumental response must be verified: a series of substandards are prepared for a range of three orders of magnitude, using automatic pipettes or calibrated glassware, with 1:2 dilutions in succession.

Following the same methods of reading the samples ($I_{exc} = 430 \text{ nm}$, $I_{ems} = 665 \text{ nm}$), each substandard must be read before (F_o) and after (F_a) acidification.

A table containing the dilutions carried out, the concentrations obtained, the fluorescence read before (F_o) and after (F_a) acidification must be prepared.

After bringing the pairs of concentration / fluorescence values on an x-y graph; a linear relationship at low values and a loss of linearity at higher values, caused by self-quenching phenomena present in molecules of fluorescent compounds, such as chlorophylls (Lakowicz, 2006)²⁰⁹ will be noticed.

It is necessary for each operator to write down the limit beyond which linearity is lost for their instrument.

If the discrete samples show fluorescence values beyond this value, the sample must be diluted to bring it back into the linearity range of the instrumental response

b.3. Routine standardization after fluorometric measurement of samples

After each batch of analysis, starting from the stock solution, a series of 3-5 substandards must be prepared by dilutions, which fall within the fluorescence range obtained from the readings of the samples; and

For each substandard a reading before (F_o) and after (F_a) acidification with HCl must be performed.

c. Calculations of the concentrations of the samples:

The factor C is calculated as the average of the ratios between the 3-5 concentrations of each substandard ($C_{Chl a}$) and the relative fluorescence values before acidification (F_o)

The R factor is calculated as the average of the ratios between F_o and F_a for each of the 3-5 measured substandard;

The concentrations of chlorophyll *a* and phaeopigments are calculated from the sample values using the following equations proposed by Holm-Hansen et al. (1965):

$$c(\text{Chl } a)/\mu\text{g L}^{-1} = R (R-1)^{-1} C (F_o - F_a) v V^{-1}$$

$$c(\text{Phaeopigments})/\mu\text{g L}^{-1} = R (R-1)^{-1} C [(R F_a) - F_o] v V^{-1}$$

²⁰⁹ Lakowicz J. R., 2006. Principles of Fluorescence Spectroscopy. 3rd ed. Springer, Berlin: 954 pp.

where:

$R = F_o / F_a$ average;

$C = C(\text{Chl } a) / \text{average } F_o$;

F_o = fluorescence of the sample before acidification;

F_a = fluorescence of the sample after acidification;

v = volume of the extract (mL);

V = volume of filtered sample (mL).

2.4 Protocol for High-Pressure Liquid Chromatography (HPLC) determination of concentration of chlorophyll *a*

The separation of pigments is possible thanks to their difference in polarity which determines the affinity between a mobile phase (elution solvents) and a stationary (column). In practice, it is determined by their different speed of crossing the column (composed of a support consisting of silicon and molecules of C18 or C8) which represents the stationary phase, while the mixture of solvents and pigments, which runs through the column, forms the mobile phase. The stationary phase is less polar than the mobile phase and, therefore, a reverse phase HPLC is implied. The polarity of the mobile phase varies over time, thus the pigments adsorbed on the stationary phase are eluted and therefore sequentially separated from the phase mobile according to their polarity gradient. Typically, an elution gradient is used that allows to decrease the retention time of the less polar compounds and, consequently, to increase the sensitivity of the method.

Once separated, the pigments are detected and quantified according to spectrophotometric methodologies and / or fluorometric. The result of the analysis is a chromatogram (spectrophotometric and/or fluorometric), in which the position of the peaks on the time axis allows to identify the different pigments present in the sample, while from the peak areas it is possible to quantify them. With the chromatogram obtained with a spectrophotometric detector the identification and quantification of both chlorophylls and carotenoids is allowed, while from the fluorescence chromatogram the identification of only the chlorophylls and their degradation products are possible.

Currently, the most accurate spectrophotometric detectors are diode ones (Diode Array Detector: DAD) which allow the determination of the absorption spectrum of each pigment; this allows, not only to quantitatively determine the chlorophylls and carotenoids, but also to evaluate their purity. In the absence of a DAD spectrophotometric detector it is advisable to use methods with analysis times longer that limit the overlap of the peaks. The solvent gradient, flow and run time (20-40 min) are characteristic of the selected method. However, it is advisable to seek optimization of the method to minimize time and amount of solvents and maximize the resolution of the pigments.

While these chromatographic separation techniques of the pigment mixture are costly and time demanding and not always sustainable for all laboratories routine work. If the choice of implementing this method for chlorophyll *a* analysis is selected, due to the complexity in choosing the various components in order to optimize the cost /effectiveness of the apparatus that build the method it is advisable to start with consulting chapters 9 and 11 of the “Monograph on Oceanographic methodology (UNESCO Publishing, Publishers: Jeffrey SW, Mantoura RFC and Wright SW, 1997²¹⁰)

²¹⁰ Jeffrey, S. W.; Mantoura, R. F. C.; Wright, S. W., 1997. Phytoplankton Pigments in Oceanography: Guidelines to Modern Methods. UNESCO Publishing: Paris, 691 pp.

(Wright et al., 1997²¹¹ and Mantoura et al., 1997²¹², respectively). The most complete, up-to-date information about the analysis of pigments, particularly for the use of aquatic scientists, can be found in a recent book edited by Roy, Llewellyn, Egeland and Johnsen (2011)²¹³. This book follows the 1997 monograph edited by Jeffrey, Mantoura and Wright and together, these two books cover sample collection, methods for pigment extraction and analysis, with emphasis on HPLC methods, comparisons with non-chromatographic methods, preparation of pigment standards and a key for identification of the various algal pigments.

a. Symbol, units and precision

For the parameter described in this protocol, the symbol and unit suggested by the International System of Units (SI), as well as the expected accuracy, along with a Method identifier as provided in the Library P01 of BODC Parameter Usage Vocabulary are provided as follows:

Symbol: *c*(Chl a)

Unit: $\mu\text{g L}^{-1}$

Precision: 0.01

Accuracy: ± 0.05

Method identifier:	SDN:P01::CPHLSXP1	Concentration of chlorophyll-a {chl-a CAS 479-61-8} per unit volume of the water body [particulate >GF/F phase] by filtration, acetone extraction and spectrophotometry
	SDN:P01::CPHLFLP1	Concentration of chlorophyll-a {chl-a CAS 479-61-8} per unit volume of the water body [particulate >GF/F phase] by filtration, acetone extraction and fluorometry
	SDN:P01::CPHLHPP5	Concentration of chlorophyll-a {chl-a CAS 479-61-8} per unit volume of the water body [particulate >0.2 μm phase] by filtration, acetone extraction and high performance liquid chromatography (HPLC)

²¹¹ Wright, S.W.; Jeffrey, S.W.; Mantoura, R.F.C., 1997. Evaluation of methods and solvents for pigment extraction, in: Jeffrey, S.W. et al. *Phytoplankton pigments in oceanography: guidelines to modern methods*. Monographs on Oceanographic Methodology, 10: pp. 261-282.

²¹² Mantoura, R.F.C.; Barlow, R.G.; Head, E.J.H., 1997. Simple isocratic HPLC methods for chlorophylls and their degradation products, in: Jeffrey, S.W. et al. (Ed.) *Phytoplankton pigments in oceanography: guidelines to modern methods*. Monographs on Oceanographic Methodology, 10: pp. 307-326.

²¹³ Roy, S.; Llewellyn, C. A.; Egeland, E. S.; Johnsen, G., 2011. *Phytoplankton Pigments – Characterization, Chemotaxonomy and Applications in Oceanography*. Cambridge University Press: Cambridge, 843 pp.

References

- UNEP/MAP/MED POL, 2005. Sampling and Analysis Techniques for the Eutrophication Monitoring Strategy of MED POL. MAP Technical Reports Series No. 163. UNEP/MAP, Athens, 46 pp.
- UNEP/MAP, 2019. UNEP/MED WG.467/5. IMAP Guidance Factsheets: Update for Common Indicators 13, 14, 17, 18, 20 and 21: New proposal for candidate indicators 26 and 27.
- UNEP/MAP, 2019a. UNEP/MED WG.463/6. Monitoring Protocols for IMAP Common Indicators related to pollution.
- UNEP/MAP, 2019b. UNEP/MED WG.463/10. Schemes for Quality Assurance and Control of Data related to Pollution.
- Bianchi, F., 1986. Relazioni fra misure di clorofilla in Adriatico settentrionale. Arch. Oceanogr. Limnol., 20: 287-292.
- Dos Santos, A.C.A., Calijuri, M.C., Moraes, E.M., Adorno, M.A.T., Falco, P.B., Carvalho, D.P., Deberdt, G.L.B., Benassi, S.F. 2003. Comparison of three methods for Chlorophyll determination: Spectrophotometry and Fluorimetry in samples containing pigment mixtures and spectrophotometry in samples with separate pigments through High Performance Liquid Chromatography. Acta Limnol. Bras., 15(3):7- 18.
- Gibbs, C.F., 1979. Chlorophyll b interference in the fluorometric determination of chlorophyll *a* and phaeopigments. Aust. J. Mar. Freshwater Res., 30: 597-606.
- Holm-Hansen O., Lorenzen C.J., Holmes R.W., Strickland J.D.H., 1965. Fluorimetric determination of chlorophyll. J. Cons. Int. Explor. Mer., 30: 3-15.
- Humphrey G.F., Jeffrey S.W., 2005. Test of accuracy of spectro-photometric equations for the simultaneous determination of chlorophylls *a*, *b*, *c1* and *c2*. In: Jeffery S.W., Mantoura R.F.C., Wright S.W. (eds), Phytoplankton pigments in oceanography: guidelines to modern methods. 2nd ed. SCOR UNESCO, Paris: 616-621.
- Jeffrey S.W., Humphrey G.F., 1975. New spectrophotometric equations for determining chlorophylls *a*, *b*, *c1* and *c2* in higher plants, algae and natural phytoplankton. Biochem. Physiol. Pflanzen., 167: 191-194.
- Jeffrey, S. W.; Mantoura, R. F. C.; Wright, S. W., 1997. Phytoplankton Pigments in Oceanography: Guidelines to Modern Methods. UNESCO Publishing: Paris, 691 pp.
- Jeffrey S.W., Welschmeyer N.A., 2005. Spectrophotometric and fluorometric equations in common use in oceanography. In: Jeffrey S.W., Mantoura R.F.C., Wright S.W. (eds), Phytoplankton pigments in oceanography: guidelines to modern methods. 2nd ed. SCOR UNESCO, Paris: 597-615.
- Kolber Z.S., Gerald Plumley F., Lang A.S., Beatty T.J., Blankenship R.E., Vandover C.L., Vetriani C., Koblizek M., Rathgeber C., Falkowski P.G., 2001. Contribution of Aerobic Photoheterotrophic Bacteria to the Carbon Cycle in the Ocean. Science, 292: 2492-2495.
- Lakowicz J. R., 2006. Principles of Fluorescence Spectroscopy. 3rd ed. Springer, Berlin: 954 pp.
- Loftus M.E., Carpenter J.H., 1971. A fluorometric method for determining chlorophylls *a*, *b* and *c*. J. Mar. Res., 29: 319-338.
- Lorenzen C.J., 1967. Determination of chlorophyll and phaeopigments spectro-photometric equations. Limnol. Oceanogr., 12: 343-346.
- Lorenzen C.J., Jeffrey S.W., 1980. Determination of chlorophyll in sea water. UNESCO Tech. Pap. Mar. Sci., 35: 1-20.
- Mantoura, R.F.C.; Barlow, R.G.; Head, E.J.H. (1997). Simple isocratic HPLC methods for chlorophylls and their degradation products, in: Jeffrey, S.W. et al. (Ed.) Phytoplankton pigments in oceanography: guidelines to modern methods. Monographs on Oceanographic Methodology, 10: pp. 307-326

- Neveux, J., 1979. Pigments chlorophylliens. In: Jacques G. (ed), *Phytoplankton, Biomasse, Production, Numeration et Culture*. Edition du Castellet, Perpignan: 1-107.
- Nusch, E., 1980. Comparison of different methods for chlorophyll and phaeopigment determination. *Arch. Hydrobiol. Beih.*, 14: 14-35.
- Riemann, B., 1978. Carotenoid interference in the spectrophotometric determination of chlorophyll degradation products from natural population of phytoplankton. *Limnol. Oceanogr.*, 23: 1059-1066.
- Robinson, A.L., 1979. HPLC: the new king of analytical chemistry. *Science*, 203: 1329-1332.
- Roy, S.; Llewellyn, C. A.; Egeland, E. S.; Johnsen, G., 2011. *Phytoplankton Pigments – Characterization, Chemotaxonomy and Applications in Oceanography*. Cambridge University Press: Cambridge, 843 pp.
- Strickland, J.D.H., Parsons T.R., 1968. *A Practical Handbook of Seawater Analysis*. Bull. Fish. Res. Bd. Can., 167: 1-310.
- Wright SW, Jeffrey SW, Mantoura RFC, 1997. Evaluation of methods and solvents for pigment extraction. In: Jeffrey SW, Mantoura RFC, Wright SW (eds) *Phytoplankton pigments in oceanography: Guidelines to modern methods*. UNESCO, Paris, p 261
- Yentsch, C.S., 1965. Distribution of chlorophyll and phaeophytine in the open ocean. *Deep Sea Res.*, 12: 653- 666.
- Yentsch, C.S., Menzel, D.W., 1963. A method for the determination of phytoplankton chlorophyll and phaeophytine by fluorescence. *Deep Sea Res.*, 10: 221-231.

Appendix 16

**Monitoring Guidelines/Protocols for Sampling and Sample Preservation of Sediment for IMAP
Common Indicator 17: Heavy and Trace Elements and Organic Contaminant**

1. Introduction

1. Determination of the concentrations of targeted heavy metals and organic contaminants in different marine matrices is a key component of the IMAP, since the analytical results will contribute to the assessment of the environmental status of the water body under consideration. Sediment is one of the proposed matrices for the analysis of heavy metals since the establishment of the UNEP/MAP – MED POL Monitoring programme in 1981 (MED POL Phase II), because heavy metals and persistent organic contaminants in seawater tend to become insoluble and precipitate with the particulate fraction on the seafloor. Therefore, since sediment is the ultimate sink of most heavy metals and persistent organic contaminants, which are introduced into the marine environment, their analysis will provide a clear view of the pollution state of the specific water body. Furthermore, in areas with undisturbed sediments, the yearly deposited sedimentary material integrates the pollution load during this specific time period, and the analysis of different sedimentary layers is providing a historical trend of pollution processes in the region.

2. The UNEP/MAP Integrated Monitoring and Assessment Programme (IMAP) (UNEP/MAP, 2019²¹⁴; UNEP (2019a)²¹⁵), requires sediment sampling from the top layer of the seafloor, because this layer reflects the recently deposited material, therefore the actual status of pollution at the specific location. The depth of the “recently” deposited sediment varies from one location to another, influenced by the sedimentation rate but also by bioturbation, but in the coastal zone it is usually the top 1 to 5 cm from the seafloor surface. In open sea, the sedimentation rate is lower than in the coastal zone, therefore often the 1st cm of the sediment may be representing several deposition years. It is of paramount importance to collect the undisturbed top layer of the sediment for analysis. Therefore, the use of appropriate sampling equipment is very important, as well as the proper handling during sampling to collect a representative sediment sample.

3. Until now, UNEP/MAP – MED POL pollution monitoring programme was focussing on the marine coastal zone, which was affected by land-based pollution sources. Therefore, sediment sampling was mainly done in relatively shallow waters, although some Contracting Parties were also collecting sediment samples from deeper waters. In a view of extending monitoring to much deeper offshore areas in the framework of the IMAP, sediment collection protocols are also addressing sediment sampling procedures from such offshore environments. Box corers and multiple corers are mostly suitable for such offshore sediment sampling, while gravity corers can be mainly used for tracking historical pollution trends. It has to be underlined that sedimentation rates at offshore sediments are much lower than in the coastal zone, leading to a much lower yearly deposition of sediment material on the seafloor. Therefore, in order to decide on the appropriate sediment depth to be collected for recording recent contaminants’ concentrations, as well as on the required sampling frequency in offshore sediments in view of detecting possible changes in contaminants accumulation, the determination of the sedimentation rate at the sampling stations is highly needed.

4. Once a representative sediment sample has been collected, it has to be transported to the laboratory for analysis. However, transportation has to be done in such a way as to avoid any alteration of the physical and chemical characteristics of the sample. Sediment characteristics and contaminants distribution in the sample may be altered if the sediment storage and transportation is not done under specific procedures, in order to avoid sample alteration and cross contamination from the material of the containers and the sampling and transportation environment.

²¹⁴ UNEP/MAP (2019). UNEP/MED WG.467/5. IMAP Guidance Factsheets: Update for Common Indicators 13, 14, 17, 18, 20 and 21: New proposal for candidate indicators 26 and 27; UNEP (2019).

²¹⁵ UNEP/MAP (2019a). UNEP/MED WG.463/6. Monitoring Protocols for IMAP Common Indicators related to pollution;

5. The Protocols prepared in the framework of this Monitoring Guidelines for Sampling and Sample Preservation of Sediment for IMAP Common Indicator 17, as provided here-below, describe appropriate methodologies for sampling, processing and storage of marine sediment under controlled conditions to ensure the representativeness and the integrity of the samples. They are not intended to be analytical training manuals, but guidelines for Mediterranean laboratories, which should be tested and modified in order to validate their final results.

6. These Protocols aim at streamlining sediment sampling and sample preservation in order to assure comparable quality assurance of the data, as well as comparability between sampling areas and different national monitoring programmes. They provide a step-by-step guidance on the methods to be applied in the Mediterranean area for sampling and sample preservation of sediments in a view of their subsequent analysis for heavy metals and organic contaminants.

7. In order to avoid unnecessary repetitions, reference is also made to the protocols already published and publicly accessible, which can also be used by the Contracting Parties' competent laboratories participating in IMAP implementation. They build upon the UNEP/MAP (2011²¹⁶) Manual on sediment sampling and analysis (Annex I), as well as similar Guidelines/Protocols for marine sediment sampling which were developed by other Regional Seas Organisations, such as ICES/OSPAR (2018²¹⁷) CEMP Guidelines for Monitoring Contaminants in Sediments and HELCOM (2012²¹⁸) Manual for marine monitoring in the COMBINE programme, as well as EC (2010²¹⁹) Guidance on chemical monitoring of sediment and biota under the Water Framework Directive, given their suitability for application in the context of IMAP. Given the suitability of any of these Guidelines in the context of IMAP, they could be further used by interested IMAP competent Mediterranean laboratories for developing their laboratory specific sampling and sample processing methodologies.

8. The below flow diagram informs on the category of this Monitoring Guideline related to sampling and sample preservation of sediment for IMAP Common Indicator 17 within the structure of all Monitoring Guidelines prepared for IMAP Common Indicators 13, 14, 17, 18 and 20.

²¹⁶ UNEP/MAP (2011). UNEP(DEPI)MED WG.365/Inf.9. Manual on sediment sampling and analysis

²¹⁷ ICES/OSPAR (2018). CEMP Guidelines for Monitoring Contaminants in Sediments

²¹⁸ HELCOM (2012). Manual for marine monitoring in the COMBINE programme. Annex B-13 Appendix 3.: Technical note on the determination of heavy metals and persistent organic compounds in marine sediment

²¹⁹ EC (2010). Guidance Document No: 25 Guidance on chemical monitoring of sediment and biota under the Water Framework Directive

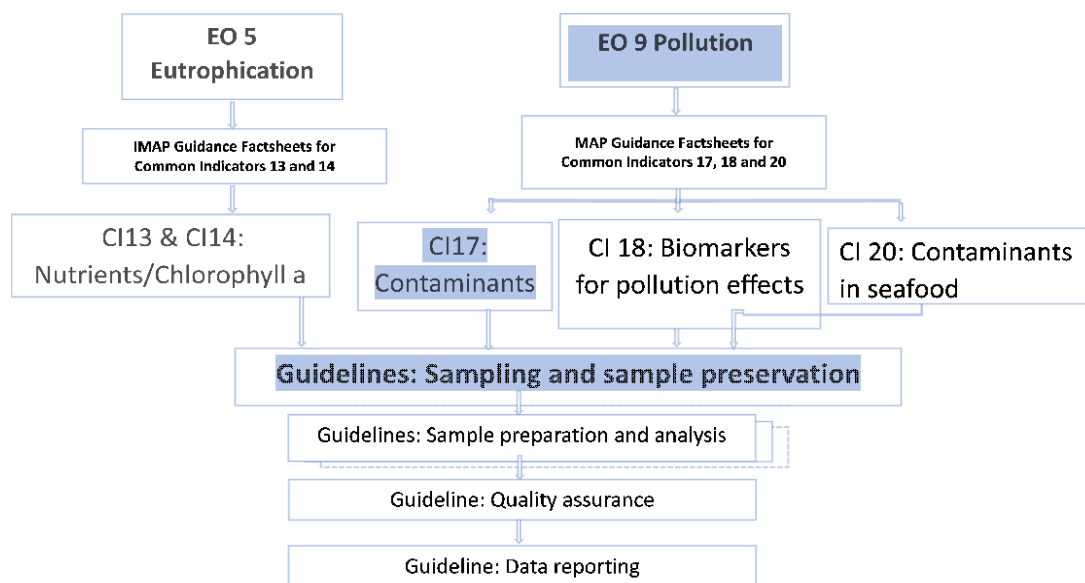

Flow Diagram: Monitoring Guidelines for IMAP Ecological Objectives 5 and 9

2. Technical note for the sampling of sediment for the analysis of heavy metals and organic contaminants

9. Sediment sampling for pollution monitoring aims at the collection of a representative sediment sample from the top layer of the seafloor, because this layer reflects the recently deposited material, therefore the actual status of pollution at the specific location. The depth of the “recently” deposited sediment varies from one location to another, influenced by the sedimentation rate but also by bioturbation. Usually it is recommended (EC, 2010) to sample the top layer of the sediment, from 1 to 5 cm depth, depending on the deposition rate. In open sea, the sedimentation rate is lower than in the coastal zone, while at coastal areas at the vicinity of large rivers the sediment sampling depth for recently deposited sediments could be more than 5 cm. During the initial phase of the IMAP (identification of key sampling sites/stations) sediment sampling should be done every two years, while during the advanced phase (when it is a fully completed MED POL Phase IV implementation with the ongoing reporting of IMAP data sets) sampling should be done every 3 to 6 years, depending on the characteristics of sedimentation areas and the chemical concerned known through previous MED POL assessments (UNEP, 2019).

10. To avoid erroneous sampling, it is of paramount importance to sample the undisturbed top layer (1-5 cm) of the sediment using the appropriate sampling equipment. Box corers are the most appropriate equipment to sample undisturbed top layers sediments in the coastal zone and the open sea, but they are relatively heavy and require adequate shipping facilities. In relatively shallow coastal areas, a grab sampler is a good solution, because it is portable and can be used from a coastal vessel, without special equipment for lowering and lifting the sampler from the seafloor. In very shallow sampling sites with a water depth less than 30 cm, surface sediment samples (5 cm) can be collected with a shovel, spatula or scoop, if no other sampling equipment is available.

11. Sediment monitoring generally addresses the top layer of the sediment because this layer indicates the actual deposited material and the actual status of pollution. Furthermore, the top layers of the sediment form the habitat of benthic organisms and therefore may affect their contaminants’

uptake (EC, 2010, UNEP/MAP, 1999²²⁰, UNEP/MAP, 2011). Surface sediments can be collected with grabs and box corers, while gravity corers can be used to collect cores to study historical pollution trends at a specific site. Also, corers could be used in order to collect deeper sediment layers in view of establishing the background concentration of contaminants at a specific area.

12. Under this technical Note, the Guideline for Sampling and Sample Preservation of Sediment for IMAP Common Indicator 17 provides the following IMAP Protocols:

- Protocol for the use of a grab for collecting sediments;
- Protocol for the use of a box corer for collecting sediments;
- Protocol for the use of a multi-corer for collecting sediments;
- Protocol for the use of a gravity corer for collecting sediments;
- Protocol for the hand collection of sediment with a shovel/scoop and a hand-held corer.

13. These Protocols are based on methods for sediment sampling and processing developed by UNEP/MAP (Annex I: UNEP/MAP (2011), UNEP(DEPI)MED WG.365/Inf.9. Manual on sediment sampling and analysis), EC (2010) Guidance Document No 25, HELCOM (2012) Technical note on the determination of heavy metals and persistent organic compounds in marine sediment, and ICES/OSPAR (2018) CEMP Guidelines for Monitoring Contaminants in Sediments. In each protocol the operation and the proper deployment and recovery of the sampling equipment is presented, and guidelines are provided for the appropriate taking of the sediment sample in order to preserve its integrity and to avoid contamination.

2.1 Protocol for the use of a grab for collecting sediments

a. Grab operation

14. A tightly closing grab, which is handled with care, can collect relatively undisturbed surface sediment samples. Grabs are not the preferable sampling equipment for collecting undisturbed sediment samples because their penetration in the sediment may disturb the recently deposited sediment layers. However, grabs may provide a workable sampling solution in relatively shoal waters, which are out of the reach of an oceanographic vessel, or when an oceanographic vessel equipped with a box corer is not available. A light-weight hand-held grab is suitable for collecting approximately 250 ml of sediment, which is an appropriate volume for sediment analysis (Figure 1).



Figure 1. Van Veen Grab

²²⁰ UNEP/MAP (1999). MED POL Phase III. Programme for the assessment and control of pollution in the Mediterranean Region.

15. To improve the sampling procedures the sampling vessel should be equipped with some sampling facilities, such as a winch, davit or other such lifting equipment. However, in very shallow coastal waters (for example less than 20 m depth) a small hand-held grab can be used with success from a small boat.

16. The grab is lowered locked-open and upon hitting the sediment's surface the lock is released and the grab's jaws are closing penetrating thus into the sediment to a depth depending on the size and the weight of the grab, as well as the hardness of the sediment.

17. Grabs can be used efficiently in sand or consolidated sediments collecting a good volume of undisturbed sample. On the other hand, in hard clays the grab may not be able to penetrate the hardened sediment, while in un-consolidated soft sediments the grab will sink through the top layer disturbing sediment stratigraphy.

b. Taking the sample

18. The water depth at the sampling station should be recorded before the deployment of the grab in order to ensure that appropriate wire/rope length is available.

19. During the descent of the grab through the water column it is important to control the speed of deployment, to allow the grab arriving at the sediment floor jaws-first. If the grab falls aside on the sediment, sampling will be unsuccessful and the grab has to be lifted, locked-open again and lowered once more. Controlling the speed of the grab's deployment will keep the wire stretched and the grab in a vertical position, as needed.

20. Another factor affecting the successful deployment of the grab is the existence of near-bottom currents that may deflect the grab from the vertical line, resulting in unsuccessful sampling. Additional weight on the grab sampler, as well as longer wire than the actual depth at the station, may be needed.

21. Once the grab is closed at the sediment floor it has to be lifted to the surface. At this stage it is important to avoid any leakage of fine-grained sediment from the grab. If the grab is well designed, no loss of collected sediment should occur. However, leakage can occur if the grab is not tightly closed because of ill-design or because of partial closure of the jaws, caused by obstruction from coarse material (for example coarse sand or shell).

22. When the grab is lifted on-board it has to be positioned on a clean surface and handled with care to ensure that no alteration of the sediment characteristics will occur because of contamination.

- i) Pose the grab on a clean surface (plastic).
- ii) Visually inspect the collected sample from the small trap doors on top of the grab to make sure that the sediment collected is undisturbed. If water is trapped on the top of the sediment remove it using a glass tube or allow to be slowly drained in order to avoid washing off the top fine-grained layers that may be present.
- iii) Record the visual characteristics of the sediment, such as grain size (fine or coarse grained), colour, smell and the presence of organisms. Taking a photo of the collected sediment is also recommended, in order to keep a visual record of the collected sample. If required, you can measure additional parameters, such Eh and pH.

c. Avoiding contamination

23. Grabs are made of metal therefore the best solution for trace metal determinations is to use a stainless-steel grab and, as an additional precaution, use plastic tools to collect subsamples from the

central part of the sample, avoiding the sediment which is in contact with the grab's walls. If possible, use grabs with Teflon coatings on all surfaces that come into contact with the sediment. The use of lowering cables coated with plastic (polyethylene) or of synthetic ropes will further minimize possible contamination.

24. After the water is drained, open the grab carefully on a clean and metal-free area (for example a plastic sheet) to collect the samples for heavy metal analysis. For the analysis of organic contaminants, the grab should be open in a dust-free area avoiding contact with possible sources of contamination from organic pollutants (such as exhaust gases).

25. Remove with a plastic or stainless-steel spoon the top layer, which is representing recent sedimentation. The depth of this layer may vary from 1 to 5 cm depending on the sedimentation rate in the sampling site and has to be decided by the institution that is responsible for the sampling.

26. It is important to ensure that enough sediment material is collected to allow for analysis of heavy metals, organic contaminants, as well as additional sediment analyses (such as grain size). The EC Guidance on sediment sampling (EC, 2010) suggests to collect 50 ml of wet sediment for heavy metal analysis. Taking into consideration that a small hand-held grab can collect approximately 250 ml of sediment, it is a suitable equipment to collect sediment samples for contaminants' analysis at shallow waters. When a larger grab is used, the collected sediment provides enough material for further analysis.

27. Surface sediment samples are transferred into wide-mouth, pre-cleaned containers:

- i) Zip-lock bags, plastic (polyethylene, polypropylene), or glass are suitable container's materials for sediments to be analysed for heavy metals;
- ii) Glass or aluminium are suitable container's materials for sediments to be analysed for organic contaminants.

28. Containers and zip-lock should be filled to the top to reduce the likelihood of oxidation during transport.

29. Sediment samples have to be stored at 4°C in a cooler box and transported to the laboratory for further processing and analysis.

Protocol for the use of a box corer for collecting sediments

a. Box corer operation

30. A box corer is a sediment sampling equipment, which collects large diameter undisturbed cores, from which replicate sub-samples may be collected by a hand-operated corer (Figure 2). Box corers are relatively heavy and are operated from a ship with appropriate equipment (heavy winch) in water depths more than 3 m (EC, 2010). Usual models collect sediment samples with a penetration of 0.75 m with a surface of 0.25 m², although there are smaller box corers available on the market. The big advantage of box corers is that they collect a virtually intact sediment core. If properly handled box corers operate efficiently in all kinds of bottoms, hard, soft or unconsolidated, retrieving undisturbed sediment cores. Therefore, if available, they are the preferable equipment for sediment sampling.

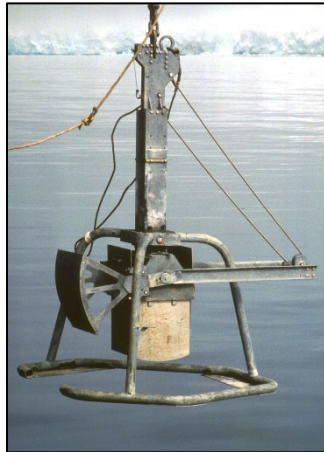

Figure 2. Box corer

b. Taking the sample

31. The water depth at the sampling station should be recorded before the deployment of the box corer in order to ensure that appropriate wire length is available.
32. The box corer is armed (locked-open) and is lowered from the ship with a controlled speed to allow the corer arriving upright at the sediment floor. Controlling the speed of the box corer's deployment will keep the wire stretched and the equipment in a vertical position, as needed. Another factor affecting the successful deployment of the box corer is the existence of near-bottom currents that may deflect it from the vertical line, resulting in unsuccessful sampling. Additional weight on the box corer, as well as longer wire than the actual depth at the station, may be needed.
33. Upon arriving at the sediment's surface, the box corer is penetrating the sediment depending on the hardness of the bottom.
34. Once the core box is filled with sediment, the winch operator slowly recovers the lifting wire and box corer ensuring the lowering of the cutting edge of the spade into the sediment to close the bottom of the box.
35. Once the box corer is lifted on board it has to be positioned on a clean area and secured.
 - i) Visually inspect the collected sample from the inspection door on top of the box corer to make sure that the spades have are closed tightly and the sediment collected is undisturbed.
 - ii) Siphon the supernatant water off the sample with a plastic or glass tube and stored it in pre-cleaned bottles, if additional seawater analysis is planned.
 - iii) Record the visual characteristics of the sediment, such as grain size (fine or coarse grained), colour, smell and the presence of organisms. If required, you can measure additional parameters, such Eh and pH.
36. Record the depth of the core penetration in order to decide if the sampling can be considered successful (appropriate sediment penetration).

c. Avoiding contamination

37. Box corers are made of metal (usually stainless steel) therefore they have to be handled with care, to avoid contamination in the determination of heavy metals. Once the box corer is open on a clean area on the deck of the ship, subsamples can be taken by hand-held plastic coring tubes for metal analysis, and by metallic tubes for organic contaminants analysis. The diameter of these coring tubes depends on the surface of the sediment retrieved with the box corer, as well as the number of subsamples required. The depth of the sediment retrieved for analysis may vary from 1 to 5 cm depending on the sedimentation rate in the sampling site and has to be decided by the institution that is responsible for the sampling. In all cases it is important to ensure that enough sediment material is collected to allow for analysis of heavy metals, as well as additional sediment analyses (such as grain size). The EC Guidance on sediment sampling (EC, 2010) suggests to collect 50 ml of wet sediment for heavy metal analysis and 250 ml for the analysis of organic contaminants. All tools for handling sediment for metal analysis should be made by plastic tools, while metallic tools have to be used for handling sediment for organic contaminants' analysis.

38. Sediment sub-samples are transferred into wide-mouth, pre-cleaned containers:

- i. Plastic (polyethylene, polypropylene) or glass are suitable container's materials for sediments to be analysed for heavy metals;
- ii. Glass or aluminium are suitable container's materials for sediments to be analysed for organic contaminants.

39. Containers and zip-lock bags should be filled to the top to reduce the likelihood of oxidation during transport.

40. If the contaminants profile will be studied, the cores collected from the box-corer have to be sliced on board to preserve their integrity. If un-sliced cores are transported in horizontal position, the profile characteristics may be lost because of mixing of layers. On the other hand, if cores are transported in vertical position, they may be compacted because of vibration altering the thickness of core's depositional layers. The core sub-samples are transferred to pre-cleaned containers: plastic (polyethylene, polypropylene) or glass are suitable container's materials for sediments to be analysed for heavy metals, while glass or aluminium are suitable container's materials for sediments to be analysed for organic contaminants.

41. Samples have to be stored at 4°C in a cooler box and transported to the laboratory for further processing and analysis.

2.2 Protocol for the use of a multi-corer for collecting sediments

a. Multi-corer operation

42. A multi-corer is a sediment sampling equipment, with several corers joined together (usually 4 to 12 corers) (Figure 3). The multi-corer is lowered from a ship and when it touches the seafloor, its weight pushes the assembled cores into the sediment. When the multi-core is lifted, individual corers' tops and bottoms are closed in order to bring an undisturbed sediment on board. Multi-corers are relatively heavy and can be operated from a ship with appropriate equipment (heavy winch) in water depths more than 3 m, as well as in offshore waters (EC, 2010). Usual models collect sediment cores of 0.7 m length and a coring tube diameter 0.1 m, although there are smaller multi-corers available in the market. The big advantage of multi-corers is that they collect several virtually intact sediment cores, which can be used for the analysis of different parameters (heavy metals, organic contaminants, grain sizes, etc.). Multi-corers can also be used for dating sediment layers. If properly handled multi-corers operate efficiently in all kind of bottoms, hard, soft or unconsolidated, retrieving undisturbed sediment cores.

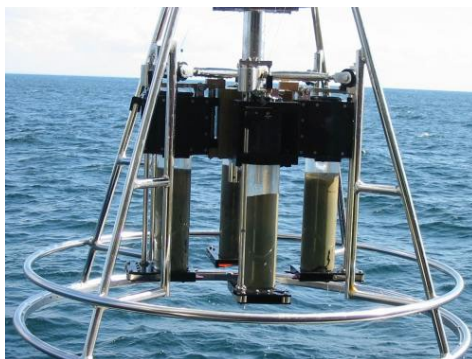

Figure 3. Multiple corer

b. Taking the sample

43. The water depth at the sampling station should be recorded before the deployment of the multi-corer in order to ensure that appropriate wire length is available.
44. The multi-corer is armed (locked-open) and is lowered from the ship with a controlled speed, in order to arrive at the bottom in an upright position.
45. During the descent of the multi-corer through the water column it is important to control the speed of deployment, to allow the corer arriving upright at the sediment floor. A speed of descent of 1 m/s is considered appropriate for the deployment of the device. Controlling the speed of the multi-corer's deployment will keep the wire stretched and the equipment in a vertical position, as needed.
46. Upon arriving at the sediment's surface, the individual corers are penetrating the sediment driven by the weights. Penetration depth depends on the hardness of the bottom.
47. Once the cores have penetrated the sediment, the winch operator slowly recovers the lifting wire and multi-corer, and upon detaching from the sediment, the core tubes are sealed, being capped both top and bottom, preserving the integrity of the samples, and the multi-corer is recovered to the surfaces.
48. Once the multi-corer is lifted on board it has to be positioned on a clean area and secured.
- i) Visually inspect the collected cores to make sure that both ends of the coring tubes are properly closed and the sediment collected is undisturbed;
 - ii) Siphon the supernatant water off the samples with a plastic or glass tube and stored it in pre-cleaned bottles, if additional seawater analysis is planned;
 - iii) Record the visual characteristics of the sediment, such as grain size (fine or coarse grained), colour, smell and the presence of organisms. If required, you can measure additional parameters, such Eh and pH;
 - iv) Record the depth of the core penetration in order to decide if the sampling can be considered successful (appropriate sediment penetration).

c. Avoiding contamination

49. Multi-corers have coring tubes made of plastic (acrylic or polycarbonate) for heavy metal analysis or stainless steel for organic contaminants or granulometric analysis. Therefore, appropriate coring tubes should be used for specific measurements. The sizes of the individual coring tubes vary, however usual models collect sediment cores of 60-70 cm length with a coring tube diameter of 10 cm. The depth of the sediment which represents the surface, recently deposited material may vary from 1 to 5 cm depending on the sedimentation rate in the sampling site and has to be decided by the

institution that is responsible for the sampling. However, in all cases it is important to ensure that enough sediment material is collected to allow for analysis of heavy metals, as well as additional sediment analyses (such as grain size). The EC Guidance on sediment sampling (EC, 2010) suggests to collect 50 ml of wet sediment for heavy metal analysis and 250 ml for the analysis of organic contaminants. As an example, if the top 5 cm are retrieved from a coring tube with an internal diameter of 10 cm, the sediment volume collected is 390 cm³.

50. Multi-corers can also be used to collect deeper sediment layers cores for dating historic pollution trends. The length of the core is restricted to 70-100 cm, which may be enough for recent pollution studies. All sediment handling tools for metal analysis, including core slicer to retrieve specific sediment layers, should be made by plastic, while metallic tools have to be used for handling sediment samples for organic contaminants' analysis. Samples are transferred into pre-cleaned containers: plastic bags or containers for heavy metal analysis and glass or aluminium for organic analysis.

51. In order to preserve the integrity of cores, it is preferable to slice them on board and to store the samples of the different sediment layers. If un-sliced cores are transported in horizontal position, the profile characteristics may be lost because of mixing of layers. On the other hand, if cores are transported in vertical position, they may be compacted because of vibration altering the thickness of core's depositional layers

52. Sediment samples are stored at 4 °C on board in a cooler box and are transported to the laboratory for further processing and analysis.

2.3 Protocol for the use of a gravity corer

a. Gravity corer operation

53. A gravity corer consists of a metallic corer tube with a plastic internal liner and attached weights that enables penetration into the sediment (Figure 4). The gravity corer is used for taking relatively long cores to study sediment layers. It is a heavy equipment (could be hundreds of kilograms), which is usually operated from a ship equipped with a heavy winch for relatively deep waters. Smaller gravity corers may be available but, they also need a boat and a winch to be handled. Gravity corers are mostly used to study contaminants' variation between sediment layers, or to record pre-industrial background concentrations of contaminants, rather than studying recent pollution changes. They can be used in both coastal and offshore sediments, taking into consideration the respective sedimentation rates, in order to evaluate the analytical results.



Figure 4. Gravity corer

54. The gravity corer is lowered from a ship and when it touches the seafloor, its weight pushes the corer tube into the sediment. Penetration depth depends on the hardness of the bottom and the weight added on top of the corer's tube. It has to be noted that because of the gravity-driven penetration of the corer into the sediment and the relatively small diameter of the coring tube, the retrieved sediment layers may be compressed and/or stretched, which may result in misleading geochronology results.

b. Taking the sample

55. The water depth at the sampling station should be recorded before the deployment of the gravity corer in order to ensure that appropriate wire length is available.

56. During the descent of the corer through the water column it is important to control the speed of deployment, to allow the corer arriving upright at the sediment floor. Controlling the speed of the gravity corer's deployment will keep the wire stretched and the equipment in a vertical position, as needed.

57. Once the corer has penetrated the sediment, the winch operator slowly recovers the lifting wire and when the corer is lifted from the seafloor the "orange peel" closing system prevents the loss of the collected sediment, preserving the integrity of the sediment layers.

58. Once the gravity corer is lifted on board it has to be positioned on a clean area and secured.

- i) Remove the inner liner of the corer and record the visual characteristics of the sediment, such as grain size (fine or coarse grained), colour, smell and the presence of organisms. If required, you can measure additional parameters, such Eh and pH.
- ii) Record the depth of the core penetration in order to decide if the sampling can be considered successful (appropriate sediment penetration).
- iii) Slice the core using a core slicer, according to predefined sections. Surface sediment, which represents recent deposition, may correspond to the upper 1 - 5 cm, according to the sedimentation rate in the area, while the core intervals, which correspond to past deposition times will be defined by the leading scientist.

c. Avoiding contamination

59. Gravity corers collect only one core at a time, therefore if a plastic liner is used the collected sediment can be used for heavy metal analysis only. Stainless steel or Teflon liners can be used for collecting sediments for organic contaminants analysis. The depth of the sediment which represents the surface, recently deposited material may vary from 1 to 5 cm depending on the sedimentation rate in the sampling site and has to be decided by the institution that is responsible for the sampling. It is important to ensure that enough sediment material is collected to allow for analysis of heavy metals, as well as additional sediment analyses (such as grain size). The EC Guidance on sediment sampling (EC, 2010) suggests to collect 50 ml of wet sediment for heavy metal analysis and 250 ml for the analysis of organic contaminants.

60. Gravity corers are mainly used to collect deeper sediment layers for dating historic pollution trends. All sediment handling tools for metal analysis, including core slicer to retrieve specific sediment layers, should be made by plastic, while metallic tools have to be used for handling sediment samples for organic contaminants' analysis. Samples are transferred into pre-cleaned containers: plastic bags or containers for heavy metal analysis and glass or aluminium or other non-contaminating material for organic analysis.

61. In order to preserve the integrity of cores, it is preferable to slice them on board and to store the samples of the different sediment layers. If un-sliced cores are transported in horizontal position, the profile characteristics may be lost because of mixing of layers. On the other hand, if cores are transported in vertical position, they may be compacted because of vibration altering the thickness of core's depositional layers

62. Sediment samples are stored at 4 °C on board in a cooler box and are transported to the laboratory for further processing and analysis.

2.4 Protocol for hand collection of sediment with a shovel/scoop and a hand-held corer

a. Hand shovel/spatula operation

63. In mud flats or in very shallow water zones with a water depth less than 30 cm, surface sediment samples (5 cm) can be collected with a shovel, spatula or scoop, if no other sampling equipment is available (Figure 5). This method can be used to collect both unconsolidated and consolidated sediment; however, it is more accurate when used in relatively calm waters. The person who will take the sample has to walk with care into the water, avoiding disturbing the site to be sampled and using a shovel/spatula/scoop he/she collects the desired thickness of the sediment. The depth of the sediment which represents the surface, recently deposited material may vary from 1 to 5 cm depending on the sedimentation rate in the sampling site, and it has to be decided by the institution that is responsible for the sampling. It is important to ensure that enough sediment material is collected to allow for analysis of heavy metals, as well as additional sediment analyses (such as grain size). The EC Guidance on sediment sampling (EC, 2010) suggests collecting 50 ml of wet sediment for heavy metal analysis and 250 ml for the analysis of organic contaminants.

64. The sample collected is transferred to a pre-cleaned container. The excess water should be removed before closing the container with the sediment sample.



Figure 5. Hand-held scoop sediment sampler

b. Avoiding contamination

65. To avoid contamination during sampling the sampling utensil (shovel/spatula/scoop) has to be made of plastic for heavy metal analysis and of stainless steel for organic contaminants analysis. The containers used to store the sediment samples should be pre-cleaned and made of plastic for heavy metal analysis or of metal/glass for organic contaminants analysis.

66. Sediment samples are stored at 4 °C on board in a cooler box and are transported to the laboratory for further processing and analysis.

3. Technical note for the preservation of sediment sample to be analysed for heavy metals and organic contaminants

67. After collection wet sediment samples have to be treated in order to be preserved unaltered until transfer to the analytical laboratory for heavy metals analysis. Sediment sample preservation include: i) Storage of wet samples on board; ii) Wet sieving to collect the grain size fraction < 2 mm, which will be further analysed for organic contaminants; iii) Freeze drying to prepare the sample for

the analysis and iv) Homogenization and storage of dried sediments. Wet sieving may also include an additional step to define the percentage (weight) of the silt and clay fraction of the sediment ($< 63 \mu\text{m}$), which is a useful parameter in assessing pollution in sediments. For the processes, the Protocol includes all necessary precautions to avoid cross-contamination of the sediment samples from tools, equipment and the laboratory environment.

68. The IMAP Protocol 3.1. addresses the treatment of sediment samples prior to analysis for heavy metals and organic contaminants.

3.1 Protocol for the treatment of sediment sample prior to analysis

a. Storage of wet samples on board

69. Upon collection wet samples have to be stored on board in such a way as to preserve them from deterioration that will affect the subsequent analysis of contaminants. Keeping the samples in low temperature (at $4 \text{ }^\circ\text{C}$) and away from light and air (as much as possible) will slow down oxidation and bacterial activity, helping in maintaining sediment's initial characteristics. The first few hours after sampling are the most critical for changes to occur in the sample, therefore preservation steps should be taken, where possible, immediately upon sample collection (HELCOM 2012).

b. Wet sieving

70. Sediment texture may differ among locations, from very fine clay in the open sea to coarse sandy sediments close to the shoreline. Finer sediments indicate net depositional areas, which are preferable sampling stations for studying pollution impact, while coarse sand, pebbles or rocky substrates are not favourable sampling locations. For pollution studies, the most informative fraction of the sediment is the silt and clay fraction ($< 63 \mu\text{m}$) because contaminants are mainly associated with finer particles (EC 2010, ICES/OSPAR 2018) and coarser sediments (sand fraction) have much lower concentrations of heavy metals and organic contaminants. Therefore, the distribution of contaminant's concentrations in sediments will generally follow the distribution of fine-grained sediments. However, sieving over $63 \mu\text{m}$ mesh adds another step in the processing of the sample and, consequently, an additional source of potential contamination. Also, sieving over $63 \mu\text{m}$ mesh may be influenced by the unsuccessful disaggregation of particle conglomerates, which may affect the efficient quantitative segregation of silt + clay from the sand fraction.

71. The IMAP Common Indicator Guidance Fact Sheets (UNEP, 2019) requires the separation of the sediment fraction less than 2 mm, as the appropriate sediment fraction for the determination of heavy metals and organic contaminants. Also, an additional sieving over a $63 \mu\text{m}$ mesh is requested, in order to record the percentage of the silt and clay fraction in the sediment. This data will be used for normalizing contaminants concentrations in the whole sediment ($< 2 \text{ mm}$) for the grain-size effect, evaluating pollution levels and comparing between areas with different sediment texture.

72. Upon arrival on board, sediment samples should be wet sieved using a 2 mm mesh-size sieve as soon as possible in order to remove large detritus and benthic organisms, which may affect the sediment characteristic during subsequent sample handling and processing (storage, freezing or ultrasonic treatment) (EC, 2010).

73. It is preferable to use seawater from the sampling site for wet sieving in order to avoid any possible alteration of the sediment equilibrium (such as adsorption or desorption of metals). If this is not possible, wet sieving could take place in the laboratory using seawater with approximately the same salinity with the sampling location. Sieving over $63 \mu\text{m}$ mesh, if not implemented on board, it can be done in the laboratory.

74. For heavy metal analysis, sieving for both 2 mm and 63 µm mesh sizes may be carried out using sieves made of polymer (PVC or acrylic rim, with nylon or polyester mesh).

75. For organic contaminants analysis sieving may be carried out using sieves made of stainless steel (rim and mesh).

76. The sediment material is placed on the mesh, water is poured, and the sieve is moved manually. For the processing of larger numbers of samples, sieves may be placed on vibrator tables. Clays often tend to form larger lumps if dried, therefore wet sieving should be done when the sediment is still wet. In case the sediment is becoming dry, it has to be pre-soaked in seawater for at least 2 hours to disaggregate the lumps (EC, 2010). However, this procedure may result in the release of contaminants, which are adsorbed on particles' surface and should be avoided, if possible. In case that pre-soaking is needed, use seawater from the sampling area and sieve disaggregated particles as soon as possible.

77. For heavy metal analysis, the sieved sediment is collected with a plastic spatula and stored in a plastic container for further processing (drying). For organic contaminants analysis the sieved sediment is collected with a stainless-steel spatula and stored in a glass or aluminium container.

c. Drying

78. Prior to the instrumental detection, sediment samples must be dried. For metal (except volatile mercury) analysis, sediments should be freeze-dried, which is the preferable procedure. Alternatively, the sediments may be dried at any temperature below 105°C until constant weight. For mercury analysis, to minimise losses due to evaporation, a sediment sub sample could be air dried at temperature <50°C (EC, 2010).

79. For organic compounds analysis drying procedures depends on the compounds to be analysed. For chlorinated hydrocarbons sediments can be freeze-dried taking care to avoid determinant loss through evaporation by keeping the temperature in the evaporation chamber below 0°C (OSPAR, 2018). For PAH determination, freeze-drying sediment samples may be a source of contamination due to the back-streaming of oil vapours from the rotary vacuum pumps. Furthermore, drying the samples may result in losses of the lower molecular weight, more volatile PAHs through evaporation. To protect sediments samples during freeze drying from cross-contamination from particles and vapours, the sample containers could be covered with a lid or filter paper perforated with a small hole (HELCOM, 2012).

d. Homogenization and storage of dried sediments

80. After drying, the samples are homogenized using a ball mill and are stored in a cool and dark place, for further analysis. Temperature is the most important factor affecting the samples, from the time of sample collection through handling to the final analyses. Also, contamination from the laboratory's air should be avoided.

81. Freeze-dried sediment samples can be stored in pre-cleaned wide-mouth bottles with a screw cap. Samples intended for the analysis of metals can be stored in plastic or glass containers. For mercury analysis, samples must be stored in acid-washed borosilicate glass or quartz containers, as mercury can move through the walls of plastic containers. Samples intended for the analysis of organic contaminants must be stored in amber glass, stainless steel or aluminium containers (EC, 2010).

82. Containers with sediment samples should be archived and kept in storage after the completion of the analysis, in order to be used as a replicate sample in case crosschecking of the results are required or additional determinations are needed in the future. Freeze-dried sediments remaining after analyses could be stored in the original sample bottle, closed with an airtight lid to protect against

moisture. When stored in a cool, dark place, samples may be archived and stored for 10-15 years (EC, 2010).

Appendix 16

UNEP(DEPI)MED WG.365/Inf.9. Manual on sediment sampling and analysis (1.1)

TABLE OF CONTENTS

	Page:
1. Introduction	1
2. Sampling Design	1
2.1 Objectives	1
2.2 Sampling sites	2
2.3 Sampling stations	2
2.4 Number of samples	3
2.5 Sampling layer	3
2.6 Sampling frequency	3
3. Sampling instruments and sample handling	4
3.1 Sampling instruments	4
3.1.1 Grab sampler	4
3.1.2 Corer	5
3.1.3 Box corer	7
3.2 Sample handling	8
3.2.1 Taking part of sample for analysis	9
3.2.2 Pre-treatment of the sample	10
4. Normalization factors	13
4.1 Background	13
4.2 Review of normalization procedures	13
4.2.1 Physical normalization	13
4.2.2 Chemical normalization by a representative element or elements	14
4.2.3 Modes of chemical normalization	15
4.3 Particle size analysis	16
4.4 Total Inorganic Carbon (TIC) and Total Organic Carbon (TOC)	18
5. Analytical techniques for organic compounds	19
5.1 Chlorinated pesticides and PCBs	19
5.2 Petroleum hydrocarbons	19
5.3 Organophosphorus pesticides	19
6. Analytical techniques for trace metals	20
7. Sediment radiochronology with ²¹⁰ Pb	20
7.1. Basic information	20
7.2. Dating models	22
7.2.1. Constant Flux and Sedimentation model (CFCS)	23
7.2.2. Constant Flux model (CF)	23
7.2.3. Incomplete inventory	24
7.2.4. Mixed sediments	24
7.3. Age model validation	25
7.4. Suggested procedure	26
8. Conclusions	26

9.	References	29
	Annex	34

1. Introduction

Within the Regional Seas Program of UNEP, many scientists are concerned about sediment sampling and analysis and therefore there is an increasing demand for the reliable analysis of both organic and inorganic pollutants in sediments. On the other hand, the sampling strategy set prior to the monitoring activity is critically important and should be established with caution in order to represent the sampling site and achieve the statistical objectives of a trend monitoring programme.

The need for a revision of the trend monitoring programme in sediments was raised during the Second Review Meeting of MEDPOL Phase III Monitoring Activities (Saronida, 2003), after a first examination of the sediment monitoring data was made by an expert, and it was recommended by the meeting to revise the existing strategy (UNEP(DEC)/MED WG.243/4). Afterwards, an expert meeting to revise the strategy for trend monitoring of pollutants in coastal water sediments was organized in April 2005 (Athens) and the meeting report (UNEP(DEC)/MED WG.273/2) considered important recommendations for the revision.

Dr Jean-Pierre Villeneuve (IAEA/MESL) drafted the initial version of the manual aimed at presenting the state-of-the-art in sediment monitoring in coastal waters. It fully took into account the recommendations of the expert meeting on both sampling strategy and analysis. A detailed section on sampling instruments and sample handling is also included in the manual, because it was observed in the training courses organized by MED POL and IAEA/MEL that there is a lack of knowledge on different sampling instruments and the sampling/sample pretreatment techniques. The draft manual was discussed at the Third Review Meeting of MEDPOL Phase III Monitoring Activities (Palermo, December 2005) and further comments of the meeting were incorporated in the present text. The section on normalization procedures was revised by Dr Barak Herut (IOLR, Israel). The section on ^{210}Pb dating was written by Dr. Joan-Albert Sanchez-Cabeza (Universitat Autònoma de Barcelona, Spain).

It is a considerable demand on resources to sample and analyze sediments, so, in order to facilitate the work of the laboratories in charge of monitoring, two different approaches (see the Conclusion) are indicated for sampling, sieving and analyzing the samples: the minimum requirement and the state-of-the-art, then laboratories could use the way that would correspond better to their needs and to their budgets.

2. Sampling design

2.1 Objectives

Sediments have an important role to play in the monitoring of the environment as they are considered as the final sink of most contaminants. Marine sediments are closely inter-related to other compartments of the environment. Therefore, their use in monitoring should be part of an integrated monitoring programme.

By far the most important step in designing of the sampling strategy of the monitoring programmes is the strict definition of the objectives of the programme concerned where the objectives should be put as detailed, specific and quantifiable as possible. To this end, a number of important factors should be taken into account, including the nature of the control measure, the contaminant concerned, the nature and location of the inputs, statistical aspects of sampling and analysis etc.

In addition, a trend monitoring programme should permit statistical comparison of the concentration of contaminants between sites (spatial distribution), highlighting areas with high concentrations of contaminants that are of concern. It is anticipated that a temporal trend monitoring programme for trace metals will at a minimum have 90% power to detect a 5% per year change over a period of between 15 and 20 years.

2.2 Sampling sites

Within MED POL monitoring programmes basically two site typologies are considered: Hot spots and coastal waters. As a matter of definition, coastal zone trend monitoring is done through a network of selected fixed coastal stations, with parameters that contribute to the assessment of trends and the overall quality status of the Mediterranean Sea. This type of monitoring is carried out on a regional basis. Trend monitoring of "hot spot" areas is done at intensively polluted areas and high risk areas where control measures have to be taken. These areas are designated by local authorities according to some common definitions provided by WHO-MED POL.

The definition of hot spots and coastal areas as regards sediment trend monitoring could be specified as follows:

- Hotspots are the most polluted sites as recorded using sediments and all such sites should be monitored (NB: these may not necessarily always be the same as the identified MED POL hot spots)
- Coastal sites are sites mainly located in the near shore coastal waters and a limited number of representative stations should be selected for state assessments.

Both hotspot and coastal areas are suitable for monitoring contaminants' content in sediments, however, only sedimentary basins with positive accumulation can be considered for monitoring. Coastal areas with sedimentation rates higher than ~5 mm/year are suitable for annual monitoring, whereas areas of lower accumulation rates should be monitored at a lower frequency. Sensitive areas for biological life and protected areas within the near shore coastal waters are also recommended to be included in the monitoring network

2.3 Sampling stations

Sample sites are normally chosen on a broad grid network or transects. It is recommended that at least **three** stations be chosen along the sediment distribution gradient of a selected site to include hot spot and the near-shore coastal area. While doing so, nearby sensitive areas for biological life should also be included in the network.

In an example case, "O" marks sampling stations in the grid below and "hot spot" station is marked by "Δ". The arrow is pointing in the direction of the residual current (distances are indicated in nautical miles).

It could be recommended to limit the number of stations for data quality assurance purpose, however, the selected station(s) should be representative for the hot spot and the other area of interest.

It is also recommended to examine the selected site for sedimentary purposes as an initial step of the work in order to identify the sediment structure of the whole area as well as

the sedimentation rates. Fine and regular sedimentation sites are experienced as more favourable for monitoring purposes.

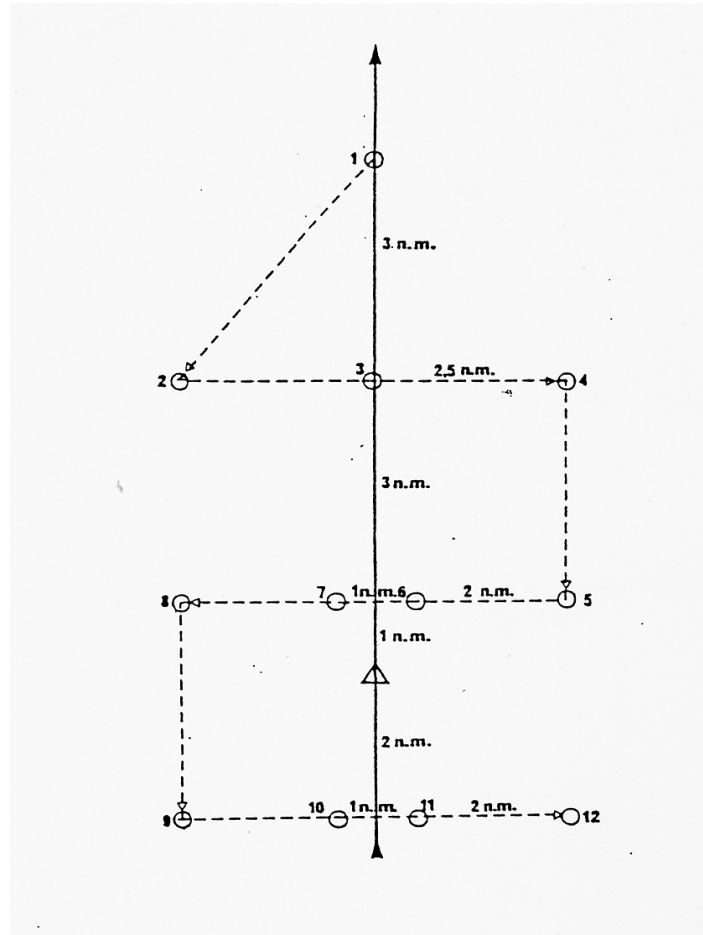

Figure 1: Example case for sampling.

2.4 Number of samples

Multiple samples have to be collected at each station in order to achieve the statistical sensitivity of sampling. It was recommended to take at least **three** samples at each station area (ex: for an area with app. 10 m depth and 10 m radius). In the pilot phase of the programme (first five years) **five** samples for each station is recommended to better understand the sampling variability if it is not known from previous monitoring efforts. Pooling of individual samples is not recommended especially in the pilot phase in order to achieve the field variability, which is an essential parameter for power analysis and trend tests.

2.5 Sampling layer

For spatial trend monitoring at a distribution gradient, surface sediments (uppermost 5 mm) should be sampled both at hot spots and near-shore waters.

For temporal trends, it is recommended to either sample the upper 5 mm at coastal near-shore stations or use core sediments and sample a sediment-depth profile, provided the sedimentation rate is known. However, this will depend on the specific situation.

2.6 Sampling frequency

As a basis and general rule, it is recommended that the sampling frequency is adapted considering the sedimentation rate.

It is generally accepted that for monitoring temporal trends at hotspot stations with high sedimentation rates (>5 mm/year), the sampling frequency can be initially set as annual or more frequent. If the sedimentation conditions are very variable at selected hot spots other frequencies could be adopted. If sampling of deeper layers at near-shore coastal waters is adopted for temporal trends, then sampling frequency could also be reduced according to the accumulation rate at the site. Sampling frequency could also be reduced when parameters are close to or below the quality targets.

In monitoring programmes of seasonal sampling, special attention should be given to sites significantly affected by river sediment input, in which accumulation rates may change seasonally following flood events. Additional attention should be paid to local conditions such as compaction, bioturbation and re-suspension events.

3. Sampling instruments and sample handling

3.1 Sampling instruments

The type of sampling equipment required for sediment surveys is dependent upon the contaminants of interest and on the information requested. Samples of surface sediment taken from a grab can be used to provide an assessment of the present levels of contamination in an area. The use of a more sophisticated sampler, such as a box-corer, would add reliability to the sample, but also would increase the operating cost of the survey. The type of sampler should be chosen among the followings:

Sediment samplers could be divided roughly into 2 different techniques: grab sampling which collects surface and near surface sediments and coring which collects a column of the subsurface sediment and could be required to establish the historical pattern of the contamination. In all grab and core operations, a slow approach to the sea floor should be ensured to avoid the creation of "bow wave" that disturbs the sediment-water interface prior to sampling. In some circumstances, it would be, also, possible to have the samples collected by divers using either glass or Teflon beakers.

3.1.1 Grab sampler

Undisturbed surface sediment samples can provide an immediate assessment of the present levels of contamination in the area in relation to the textural and geo-chemical characteristics of the sediment. The sampler used must consistently collect relatively

undisturbed samples to a required depth below the sediment surface and of sufficient volume to permit subsequent analyses.

The Van Veen grab is among the most commonly used grab samplers. With this bottom sampler, samples can be extracted from any desired depth. While it is being lowered, both levers are locked wide apart whereby the jaws are open. Upon making contact with the waterbed, the locking mechanism is released and when the rope is pulled out to raise the sampler, the jaws close.

The small model (Figure 2), with a surface of 250 cm², made of stainless steel has a weight of approximately 5 kg and could be hand-operated from a small vessel. It is not recommended for greater water depth. The main problem with this sampler is that it is sometimes difficult to recover the surface layer of the sediment, so this type of sampler could be used only in case a coring device is not available.

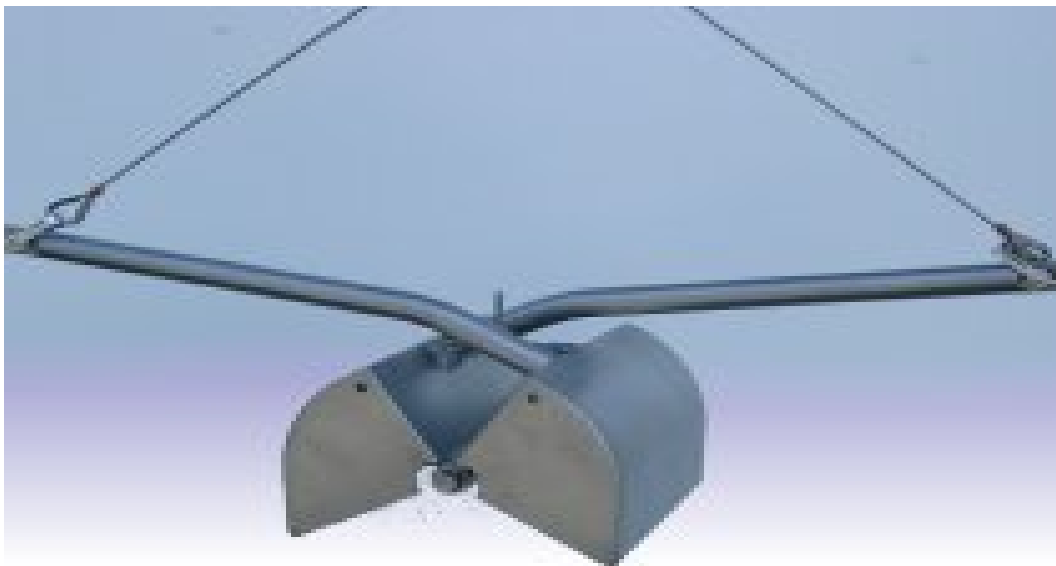

Figure 2: Van Veen grab operated manually (picture from Hydro-Bios, Germany).

There are other models of Van Veen grab, which are winch-operated, with a weight up to 80 kg. These models are presented in the **annex** to this document.

3.1.2 Corer

Sediment subsurface samples are often taken using barrel or box corers to determine the change in lithology and chemical composition with depth in order to assess environmental changes in metal fluxes with time. Cores are usually collected in areas of fine-grained sediments but specialized corers are available for coarse-grained sediments.

The main types of corers having cylindrical barrels are the gravity corer (Figure 3) which free-falls from the ship and penetrates the sea floor by gravity, and the piston corer which is released a set distance above the sea floor, penetrates the sediment by free fall, and sucks the sediment into the core barrel by an upward moving piston as the core is retrieved.



Figure 3: Gravity corer (picture from Hydro-Bios, Germany).

For trace metal analysis, plastic core liners are placed inside the core barrels to contain the sediment core sample and to avoid the problems of extrusion and contamination that occur in unlined barrels. When this kind of liner is used, care should be taken for collecting the sample for organic compounds determination, the sample should be collected at the inner part of the core at about a cm from the wall of the plastic liner. In general, the greater the diameter of the liner, the less will be the amount of distortion of the subsurface sediment by the corer penetrating the sediments. Core liners with internal diameters > 50 mm are usually satisfactory for obtaining samples for geochemical purposes.

After the corer is retrieved, the liners are capped at the bottom; the liner is removed from the barrel; the top is capped, and the core stored in a vertical position until all the water inside the liner has risen to the top. The liner is cut off at the sediment - water interface, capped and placed in a deep freezer or a cold room (4°C) for transport to the laboratory. Visual observations and measurements of sediment core samples should include information on the site number and location, depth, time, core length, lithology, stratigraphy, and any distortions in sediment layers.

In the laboratory, core sampling is best carried out by extruding the core upwards and slicing off layers (~ 1 cm) using a non-contaminating cutter (e.g. stainless steel, plexiglass or splitting the plastic core liners lengthwise, avoiding the smeared zone around the inside of the core liners and sampling the interior section of the core.

In order to check the repeatability of the sampling, more than one sediment sample can be collected within the same area. This can be done with the multi-core sampler (Figure 4). After analyzing the different samples, an estimation of the standard deviation due to sampling can be estimated.



Figure 4: Multi-core sampler.

3.1.3 Box corer

Rectangular sampling devices which obtain cores about 15-25 cm square and 15-60 cm deep are known as box corers (Figure 5) and can be recommended for detailed sampling at or below the sediment-water interface. The advantage of the various types of box or square corers is that they can recover the surface sediment and fauna virtually intact. They can be sub-sampled by inserting several 5 cm diameter tubes into them. However, when sub-sampling is used, the core material should be taken from the mid-part of the core to avoid any “edge effects”. Such samples are treated in the same way as the core samples described above.



Figure 5: Box corer.

3.2 Sample handling

The procedure outlined below assumes that these samples will be collected from a vessel equipped with the basic collection facilities such as a winch, or other such lifting equipment and adequate refrigerated storage space.

Regardless of the equipment chosen for the sampling, it is useful to know the water depth at each station before starting the sampling. The purpose is to ensure adequate cable length for operation of the correct equipment and to control the speed of entry of the sampler into the sediment. The speed of deployment of the sampler can be critical to good operation and sample recovery. It is also useful to have some understanding of the currents at the sampling site. Strong near-bottom currents can lead to poor equipment deployment, deflect a grab sampler, or require a long cable/wire to be deployed. Care should be taken to ensure that the weight of the sampler is adequate for working at the particular current conditions.

On-board, the sediments contained in the grab sampler require attention to ensure that essential components are neither lost nor contaminated through improper handling. The most critical sampling and storage techniques relate to the avoidance of chemical contamination and change in the physico-chemical characteristics of the sediments. Special steps should be taken to minimize contamination of the samples. For trace metal determinations, the use of a stainless steel grab sampler with Teflon coatings on all surfaces that come into contact with sediments, and polyethylene coated lowering cables are highly recommended. All samples should be collected into cleaned plastic (inorganic samples) or glass vials or aluminum containers (organic samples).

The actual collection procedure is quite simple:

- i. Prepare all sample containers for organic analysis by cleaning with solvent and heating in oven at 250 °C overnight.
- ii. Clean the sediment grab thoroughly with hot soapy water, rinse with tap water. Avoid placing the grab sampler on the open deck, keep in a large plastic or aluminum tub while not in use.
- iii. Clean a large sized plastic or aluminum tub depending on the destination of the sample.
- iv. Cock the grab sampler.
- v. Haul sampler on-board.
- vi. Initially, a visual inspection should be made of the sample by means of the small trap doors on top of the grab to ensure that the sample has been collected in an undisturbed state and to determine if there is water on top of the sample. If water is present, it can be siphoned off with a glass tube or slowly drained so as not to wash the sample unduly.

<p>Note : Plastic bags or wide-mouth jars (polypropylene or borosilicate glass) should be used for temporary storage of sediments for trace metal analysis. Prior to their use, containers and glass or plastic parts associated with the sampling equipment should be cleaned with detergent and acid then rinsed with metal-free water. For trace organic analysis samples should be stored in cleaned wide-mouth borosilicate glass or aluminum</p>

containers. The samples should be stored frozen, or at a sufficiently low temperature (~4°C) to limit biological and chemical activity. It is recommended that a minimum sub-sample size be 50 grams.

- vii. Once the top of the sediment is exposed, visual estimates of grain-size (coarse, medium, fine grained), color, and the relative proportions of the components should be made and recorded. By inserting the appropriate electrodes into the sample, *in situ* measurements can be made, such as pH.
- viii. Most fine-grained sediments usually have a thin, dark yellowish brown surface layer resulting from the oxidization of iron compounds at the sediment-water interface. Since in most cases this layer represents the material being deposited at the present time, it should be sampled carefully with a non-contaminating utensil such as a plastic spatula for trace metals determination and a stainless steel one for organic compounds determination. About 10-30 g should be placed in a numbered polyethylene vial for trace metal analysis and in glass or aluminum container for organic analysis, sealed and frozen for transport to the laboratory.
- ix. After the surface layer has been sampled, the grab can be opened and an additional sample, representative of the subsurface, can be obtained. Observations of this material should include color and textural characteristics. To ensure a representative sample, about 100 to 200 grams (or even more) should be collected and placed in a numbered vial. The sample should be frozen quickly for return to the laboratory. Larger samples of about 1 kg are required for admixtures of gravel, sand and mud.
- x. Store all sediment samples deep-frozen or, at least, under refrigeration (4°C) until they are transported to the laboratory.

3.2.1 Taking part of the sample for analysis

Depending on the analysis required and on the material of the sampler (plastic liner for corer), the collection of sediment should follow an agreed protocol. The main idea being to avoid contact with plastic liner for organic compounds and contact with stainless steel for trace elements analysis.

The distribution of sediment depending on the analysis to be performed is indicated in Figure 6.

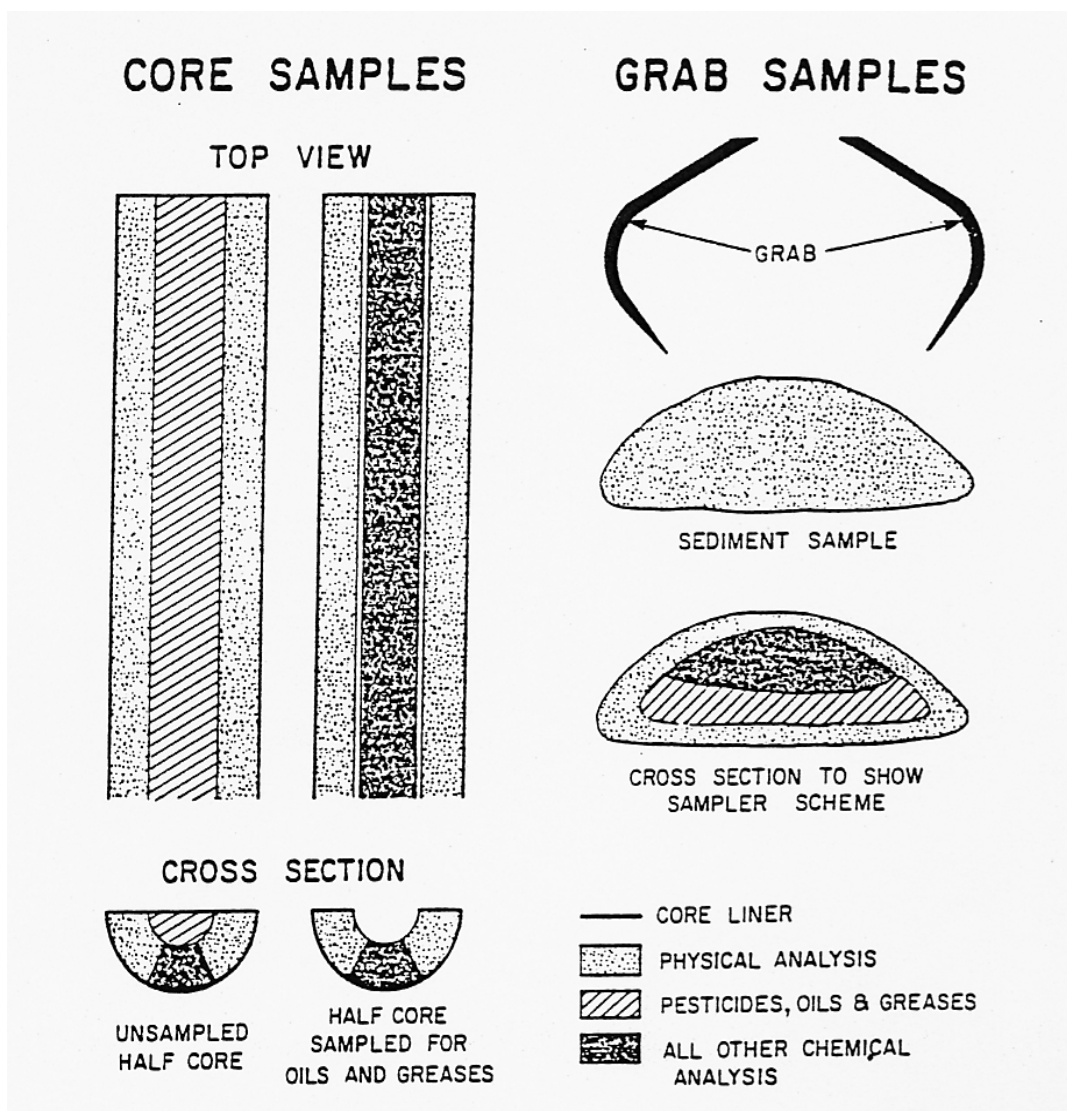

Figure 6: Collection of sediment according to analysis required.

3.2.2 Pre-treatment of the sample

(i) Freeze-drying:

After collection, the sediment samples are transferred into pre-cleaned aluminum boxes or pre-cleaned aluminum paper for organic analysis or into plastic bags for trace element analysis and deep-frozen (or at least kept refrigerated at about 4°C during the transport to the laboratory in order to avoid the bacterial degradation in case of petroleum hydrocarbon analysis).

When in the laboratory, the sediment samples should be deep-frozen at -20°C and, when frozen, freeze-dried in a freeze-dryer. But it is always interesting to archive part of the sample in order to be able to re-analyze it in case of suspected contamination during the analytical process. So, before freeze-drying, one half of the sample should be stored, as such, in the deep-freezer for future reference (in this case it could be interesting to have a -80°C deep-freezer).

In order to proceed with minimal risk of contamination in the freeze-dryer, the samples should be covered with aluminum paper with some pins holes to let the water vapor evacuate and reduce the eventual cross-contamination.

Contamination from the freeze-dryer and from the vacuum pump should be monitored by freeze-drying, with all batch of samples, a portion of clean Florisil. By analyzing the Florisil it is, then, possible to check if the freeze-dryer does not contaminate the samples.

The samples could be weighed before and after freeze-drying in order to access the ratio of dry/wet weight for each sample.

Note: for frozen sample there is no storage limit in time, for freeze-dried samples, if the samples are kept in the **dark**, in a **cool place** (20°C) and with **Teflon tape** around the neck of the bottles to avoid the humidity to enter in the sample, the limit of conservation could be on the order of 10-15 years without deterioration of the sample.

(ii) Sieving:

After freeze-drying the sediment samples could be sieved in order to remove the small gravels, pieces of branches and shells. Before sieving, it is recommended to sort out, with stainless steel forceps (for organic analysis), or with plastic ones (for trace metal analysis), from the sediment sample the small pieces of shells, branches and leaves that could be present in the sample in order to avoid contamination by extra materials. To do that, the samples are transferred to the top sieve of a sieving machine and the machine is activated. Doing so, the sediment will be disaggregated and not crushed.

The question of sieving is very delicate, as many possibilities exist. Some may sieve at 1 or even 2 mm (pre-sieving), only to remove the small pieces of shells, leaves and branches while others may sieve at 250 µm. In most cases, sieving the sediments through a 63 µm sieve in order to separate the silt and clay from the sand and coarser material is both useful and practicable and it is a widely adopted procedure. However, sieving is not recommended for fine and homogeneous sediments, usually found in the zones with high sedimentation rates where the content of the contaminants will be highest because of their wealth of fine particles for which the contaminants have a particular affinity. Obviously, when it is not possible to find fine sediments, sieving can be recommended to extract the finest particles.

Ideally, the sample could be sieved at 63 µm and the two fractions (less than 63 µm and more than 63 µm) could be analyzed. Even in some cases, sieving at 20 µm is undertaken and 3 fractions are, then, analyzed: more than 63 µm, between 20 µm and 63 µm and less than 20 µm.

Since sieving may also cause contamination problems in the samples (basically for the organic contaminants), many steps of sieving should be avoided -if possible- and it may even be recommended to sieve only from 250 µm before organic contaminant analysis.

For spatial trend monitoring sieving is not a critical issue; however, sieving from <1 or <2 mm in the field is recommended to take place directly after sampling or after the freeze-drying step.

For temporal studies sieving is recommended over 63 µm. However, the important thing is to achieve programme consistency and therefore, it is not recommended to switch to

any other fraction if all set criteria in terms of sufficient trend detection are met by a laboratory that is using a whole fraction (e.g. less than 1 or 2 mm) for temporal studies.

A preferable approach is to minimize pre-treatment procedures and unify them for all types of metal/organic analyses and monitoring programmes, both spatial and temporal. Accordingly, sieving to less than 63 μm should be avoided since dry sieving is not reproducible whereas wet sieving is complicated and may introduce the following faults: (i) metal release due to the use of water with different pH and salinity; (ii) mineral (carbonates) dissolution when distilled water is used; (iii) contamination during the sieving and the successive drying.

It is therefore recommended to use one-step dry sieving of the less-than-1 mm fraction in order to perform the analyses on total (bulk) sediment. The rationale for this recommendation is as follows:

- (i) Better representation of all relevant size fractions; in some sites coarser fractions (generally, fine and medium sand) are dominant and may contain a significant portion of the total metal (or pollutant).
- (ii) Simple to handle.
- (iii) Applicable for a wide range of sedimentary provinces and suits a multi-national monitoring programme for the Mediterranean countries.
- (iv) Facilitates the use of elemental normalizers (see below).
- (v) Avoids potential contamination that might be introduced via wet sieving and successive drying.

(iii) Wet sieving:

Some laboratories use wet sieving techniques. One of the problems that occurs with this technique is the possibility of contamination for organic samples as the material used for this wet sieving method is plastic (silicone tubing and plastic tubes with nylon nets). Another factor that has to be taken into consideration in using the wet sieving technique is the time consumed. The wet sieving method could, however, be used for trace metal work and in well-equipped and staffed laboratories.

Note: If wet sieving is applied, it is recommended to perform it on board using in-situ seawater and thus avoid using in-lab fresh or distilled water in order to prevent metal release and mineral dissolution (see above). However, wet sieving should not be applied on board if there are technical limitations and potential contamination from vessel oils and metal corrosion or from local polluted seawater.

(iv) Archiving:

Archiving sediment (and biota) samples is a must in QA/QC procedures. All samples should be kept for the duration of the monitoring in order to be able to come back to any of them, or to all of them, in case of problems.

Archives should consist of different parts: the first one being the sample wet and deep-frozen as it has been collected. This archive will be used in case of contamination that can appear during the freeze-drying process. So, one part of the original sample can be extracted again, even wet and dried with sodium sulfate, if it appears that the freeze-dryer had contaminated the sample.

Then when the sample has been dried, and an aliquot has been analyzed, the remaining sediment sample should be kept in a glass bottle, with Teflon tape around the closing system (that should be aluminum for organic and plastic for trace metal) to protect against the moisture and then, stored in a cupboard in the dark and cool place. This way, the sample archived can be stored for 10-15 years, so, for the duration of the monitoring program.

4. Normalization factors

4.1 Background

Pollutants tend to be associated with the fine particles of marine sediments due to the relatively higher surface area and the compositional characteristics of the fine particles. Both phyllosilicates and organic matter, which have a chemical affinity to trace elements and organic pollutants, are concentrated in the clay (less than 2 μm) and fine silt (2–20 μm) fractions. Most other minerals, including feldspars and heavy minerals, are found in the fine and coarse (20 - 63 μm) silt fractions, whereas the sand fraction (63 μm – 2 mm) mainly consists of carbonate (calcite, aragonite, dolomite) and/or silica (quartz, opal) minerals. Exceptions to this are coastal sediments of mafic and ultra-mafic terrains.

The metals of considerable environmental impact are As, Pb, Hg, Cd, Zn and Cu. Other metals, such as Mo, Ni, Cr and Co, may reflect anthropogenic input resulting from local quarrying and industrial activities. Anthropogenic Cd and Hg have a stronger affinity to organic matter than to clays, whereas natural Ni and Cr may be related to heavy minerals in certain sedimentological provinces. In order to detect anomalous concentrations of anthropogenic origin it is necessary to normalize the results by a physical or a chemical factor. Some elements may have background concentrations below or near the limit of detection for chemical analysis. Therefore, it has been shown that there is no single normalizing factor that can cope with all pollutant metals in all types of coastal sediments, or even in a single type. Comparing the results to average crust, or upper crust, concentration has been shown to be of limited value for this purpose (Loring and Rantala, 1992; Covelli and Fontolan, 1997) and therefore it is not discussed here.

4.2 Review of normalization methods

4.2.1 Physical normalization

The carbonate and silica mineral groups naturally contain negligible amounts of trace metals and therefore serve as diluents of the marine sediments. Removal of much of those diluents should: a) enhance the analytical capability of detecting low-concentration pollutants; and b) enable comparison between samples on a compositional basis of improved homogeneity. Consequently, choosing the less-than-20 μm or less-than-63 μm fraction for analysis, as mentioned in document UNEP(DEC)MED WG.273/2 (Anavissos meeting report, May 2005), seems like an adequate solution for normalization. Several marine sediment studies of trace elements and their isotopic composition, especially of Nd and Sr, preferred to analyze the less-than-20 μm fraction for geochemical purposes (e.g., Innocent et al., 2000; Krom et al., 2002). However, we are not aware of any such studies for environmental purposes. An essential difficulty in using this size fraction is that it excludes the contribution of trace elements in heavy minerals, and therefore the adequate evaluation of background values. Sieving the less-than-20 μm fraction is also technically problematic since it needs in-lab wet sieving with water of different pH and salinity, consumes more time and hence the

process is more prone to both metal loss from the sample and contamination. Therefore, if physical normalization is adopted, the less-than-63 μm fraction is preferable to the less-than-20 μm fraction for environmental studies, as has been suggested in the Anavissos meeting report (May, 2005), though some of the difficulties remain.

Nevertheless, utilizing physical normalization by wet sieving might suffer from the following disadvantages: a) any sample manipulation is vulnerable to contamination; b) drying the sediment in an oven or freeze drier, a common practice (Loring and Rantala, 1992; Barbanti and Bothner, 1993), is an obstacle for sample desegregation before wet sieving. Ultrasonic treatment is needed in order to facilitate desegregation, which in turn may cause transfer of pollutants from solid to solution (Barbanti and Bothner, 1993); c) in cases of highly variable mineralogical composition, especially in the sand fraction, the normalization would not reflect this variability. Therefore, most environmental studies dealing with polluting metals use the total sample composition, where "total" generally means the less-than-2, or 1 mm fraction (Loring and Rantala, 1992).

An alternative approach for utilizing physical normalization may be applied in areas where preliminary data indicates that all, or almost all, trace elements and pollutants reside in the less-than-63 μm fraction. In such cases the chemical analysis should be performed on a bulk sub-sample whereas grain-size analysis should be performed on another sub-sample. The chemical results are presented after normalization to the less-than-63 μm fraction.

4.2.2 Chemical normalization by a representative element or elements

Chemical normalization has the following advantages: a) a single analytical procedure is practiced for the determination of all required elements, the pollutants and those used for normalization; b) minimal manipulation of the sample minimizes contamination; c) the chosen element, or elements, supposedly normalizes both the grain size and the composition variability.

The element most used for marine sediment normalization is aluminum (Al) since it represents aluminosilicates, the main group of minerals generally found in the fine sediment fractions. Aluminum supposedly: a) derives from detrital minerals, transported from the continent to the sea; b) has negligible anthropogenic input; c) behaves conservatively in normal marine environments. Therefore, Al is expected to normalize for grain-size and for mineralogical variability (Bertine and Goldberg, 1977; Din, 1992; Hanson et al., 1993; Daskalakis and O'Connor, 1995; Covelli and Fontolan, 1997, among others). Another advantage of Al is its easy, precise and accurate chemical determination.

Lithium (Li) has been shown to serve as a better normalizing element than Al in marine sediments enriched with 2:1 phyllosilicates, as in the North Sea where sediments derive from eroded glacier material (Loring, 1990). This element, which generally is not contributed by anthropogenic activity, has been recently found to be superior to Al in a Mediterranean study (Aloupi and Angelidis, 2001) but inferior to Al and to Fe in another Mediterranean study (Covelli and Fontolan, 1997). Loring and Rantala (1992) recommended determining at least Li and/or Al. Rubidium is similar to Li in its geochemical behaviour. As a trace substitute for K it may represent phyllosilicates, feldspars and some heavy minerals and it is not thought to result from anthropogenic activities. It has been used successfully in a few environmental studies in the UK (Allen and Rae, 1987; Grant and Middleton, 1990), but apparently not elsewhere.

Iron (Fe) has been successfully used for normalization in several studies (Rule, 1986; Sinex and Wright, 1988; Blomquist et al., 1992; Herut et al., 1993; Daskalakis and O'Connor, 1995; Schiff and Weissberg, 1999). However, it has been suggested that remobilization and

precipitation can lead to changes in the pollutant/Fe ratio in anoxic sediments (Schiff and Weissberg, 1999). The latter are hardly expected to be found in Mediterranean sediments of open coasts.

A few studies used scandium (Grousset et al., 1995; Ackerman, 1980) and cesium (Ackerman, 1980), or also cerium, beryllium and europium (Herut et al., 1997), as the normalizing element. Since each of these elements may cause analytical difficulties, they are currently not recommended to be used on a routine basis.

4.2.3 Modes of chemical normalization

Chemical normalization by an element is to be performed by one of the following methods:

(i) By comparing the samples, suspected to be polluted, to nearby non-polluted samples of similar texture, mineralogical and major chemical composition. Background concentrations of the non-polluted samples can be established from surface sediments of other regions or from deep core samples of the same region, below the level of anthropogenic intervention. The potential pollutant concentrations should be compared with background averages in order to calculate the enrichment factor (EF) as follows:

$$(1) \quad EF = \frac{X(s)/N(s)}{X(b)/N(b)}$$

where X is the element and N the chemical normalizer (e.g. Al/Fe/Li) concentration; (s) is the sample; (b) is the background value. The evaluation of the EF value taken for estimating pollution should consider both natural variability and analytical errors (especially if the background concentrations were determined in/by another laboratory and/or analytical device).

(ii) By comparing the measured pollutant and chemical normalizers (or multi-element normalizers, Herut and Sandler, 2007) to their relationships in non-polluted (background) sediments, which have a linear relationship at the 95% confidence level, or better, and a high significance ($P < 0.001$). The regression equation should follow either $y = ax$ (x is the normalizing element) or $y = ax + b$ (Loring and Rantala, 1992; Herut et al., 1995; Covelli and Fontolan, 1997; Roach, 2005). An estimate of the anthropogenic fraction and the ratio between the measured and predicted values (y) can be defined, where the predicted value is within the range of $1 \pm 2\sigma$.

(iii) By calculating the regression line between contaminant and normalizer through a pivot point, which is the concentration of both elements in a non-polluted sand fraction (Kersten and Smedes, 2002) of a selected standard sediment composition. This approach has been adopted by OSPAR (OSPAR/JAMP, 2002; OSPAR, 2005) and is presented in detail in Herut and Sandler (2007).

In summary - Aluminum (Al) and total organic carbon (TOC) determinations should be obligatory. If possible, the determination of Fe and Li as additional normalizers is recommended in order to better assess basin-wide spatial and temporal trends. The most practical normalization approach for the Mediterranean at this stage is the use of the linear regression equations.

The lack of standardized datasets for the Mediterranean prevents defining 'pivot values' and the use of the OSPAR chemical normalization approach. It is recommended that a standard analysis be performed for the areas to be monitored including: i) grain-size distribution in order to obtain the relations between physical and chemical normalizers; ii) heavy metal concentration in natural non-contaminated sand fraction; iii) mapping the chemical normalizers (Al, Fe, Li, TOC) range for selecting the proper standard sediment composition; iv) assessment of errors associated with the normalization approach.

4.3 Particle size analysis

Particle size analysis may be performed in order to better characterize the sediment nature and the sedimentological regime of the region monitored. The methods for fractionation into grain size can be found in UNEP/IOC/IAEA (1995) and in Loring and Rantala (1992).

The most time-efficient and robust way to obtain particle size analyses is by a laser-diffraction analyzer. There are many laser-diffraction analyzers on the market, such as the Malvern Mastersizer, the Coulter LS Particle Size Analyzer, or the Microtrac S3500 Analyzer. Laser diffraction is used to detect particle sizes in the range of ~ 0.1 to 2000 μm equivalent spherical diameter (depending on the instrument) using light scattering theory. The refractive and absorption indices for the material must be known for accurate measurements to be made.

Laboratories in which continuous grain-size counters (e.g. Mastersizer) are not available should follow Figure 6. The grain size distribution below 63 μm is determined by one of the sedimentation methods.

Sedimentation methods are based on the application of Stokes' Law, which describes the terminal velocity for an isolated sphere settling in a viscous liquid under the influence of an accelerating force such as gravity. Sedimentation techniques can be cumulative or incremental. In the cumulative method, the rate at which the particles settle is determined, typically, by weighing the mass of settled particles at a certain depth over time. In the incremental method, the change in concentration or density of the material with time is measured at known depths, typically using optical or X-ray sensing. Sedimentation methods are best suited to particles in the range 2-50 μm and, therefore, may not be appropriate for bulk sediment. Temperature must be accurately controlled in order to keep viscosity constant. Incremental sedimentation techniques can be carried out using instruments such as the X-ray SediGraph, manufactured by Micrometrics.

Laboratories equipped with continuous grain-size counters should dry sieve a freeze-dried sub-sample according to the instrumental analytical range (old instruments – below 250 μm ; new – below 1 or 2 mm).

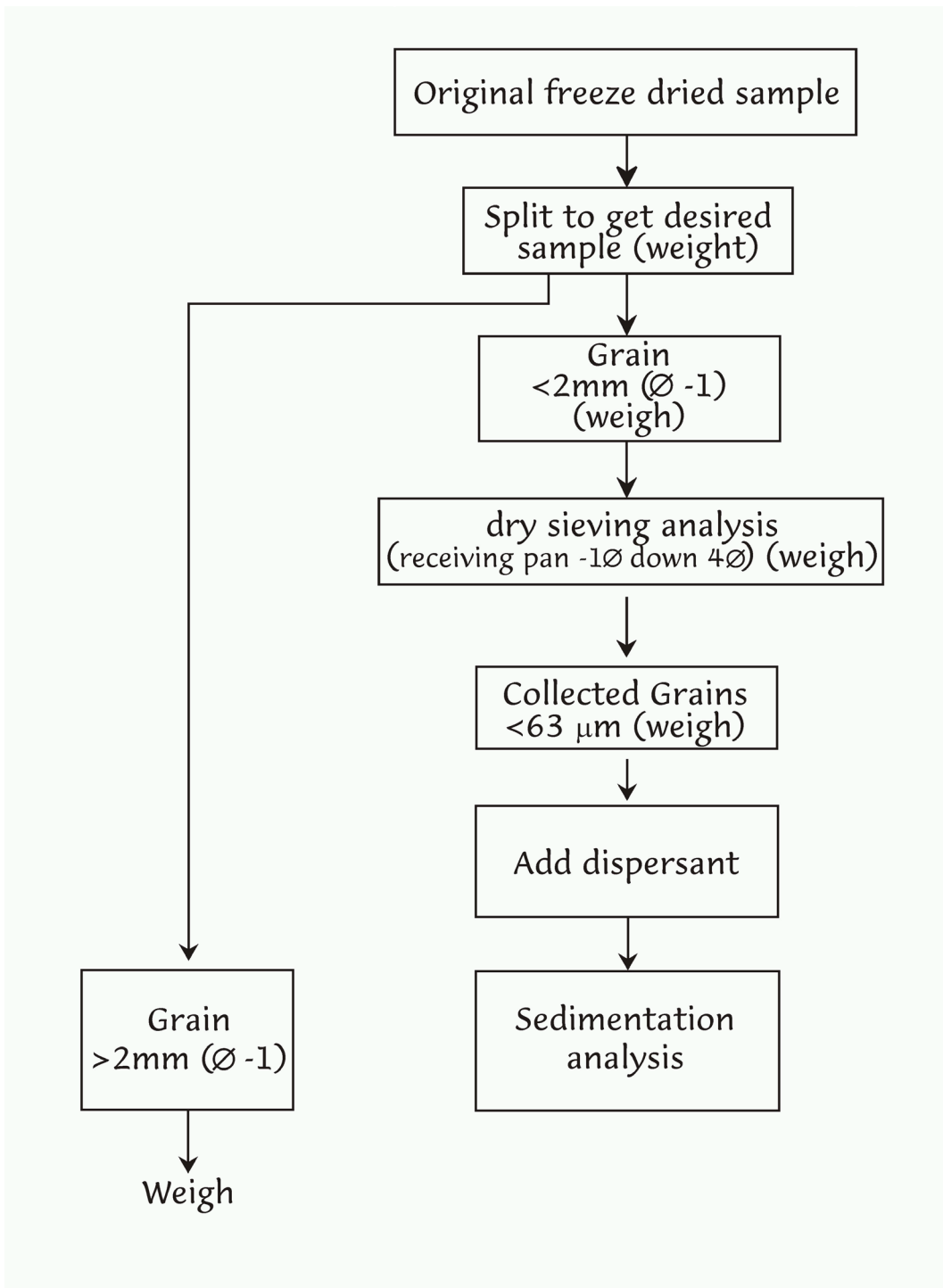

Figure 7: Sequence of steps for the grain size separation of a sediment sample (Please note that 2 mm grain size stands also for 1 mm).

4.4 Total Inorganic Carbon (TIC) and Total Organic Carbon (TOC)

Organic material interacts strongly with both organic and inorganic contaminants. The organic carbon is one of the measures of the organic material. Another parameter would be the determination of lipids, or lipid-like material. The measurement of the hexane extractable organic matter (or HEOM) is also a normalising variable.

The carbonate content (inorganic carbon) of the sediment is generally considered as a dilution factor of the main phases carrying the contaminants and should, also be determined.

Total inorganic carbon (or carbonates) are obtained by the difference of data:

$$\text{TIC (\%)} = \text{TC (\%)} - \text{TOC (\%)}$$

(i) Preparation of samples

Samples for TC analysis are weighed (mg) in tin boats and directly analysed. Samples for TOC analysis are weighed (mg) in tin capsules and acidified with H_2PO_4 1M until the inorganic carbon is removed (3 times in 8 hours intervals to the oven at 55°C). Tin boats and capsules are folded and pressed before the analysis.

(ii) Procedure

Analyses could be done with automatic analyser (such as Elementar "VARIO EL" Instrument) in CN mode. For the mass determination of C and N, an oxidation of the sample followed by the reduction of nitroxides is realized, coupled to chromatographic glass column separation and thermal conductivity detection for CO_2 and N_2 .

Note: In case a CHN analyser is available and used for the TC-TOC analysis, Total Nitrogen and Total Organic Nitrogen can be measured simultaneously which can provide a general insight of the lability of organic matter, simply based on the C/N ratio.

(iii) Quality control

Acetanilide standard ($\text{C}_8\text{H}_9\text{NO}$) is used as a correction factor for accurate and precise measurements (71.1 % C and 10.4 % N) and to control instrumental stability.

The precision of TOC and TC measurements in the samples depends in numerous random factors such as: weighing, use of an acidification step, sample structure (i.e. matrix), concentrations, as well as the instrumental noise. Coefficients of variation (% RSD) must be calculated for each pair of determination, specially, for TOC analysis, which includes an acidification step.

Alternative method to estimate Organic Material in case a CHN Analyser is not available:

The Organic Matter (OM) content in sediments can be measured with the following method:

- a) Put the (wet) sediment sample in oven at 60°C for 24 hours (up to constant weight).
- b) Weight approximately 1 g of dry sediment (precision 0.01 mg) in a small porcelain boat.
- c) Put the sediment for ignition into a furnace at 450°C for 3 hours.
- d) Weight the sediment after ignition (precision 0.01 mg).

The Organic Matter (OM) content is equivalent to the percentage of Loss of Weight (LOI %)

$$\text{LOI \%} = (W_{\text{dry}} - W_{\text{ign}}) \times 100 / W_{\text{dry}}$$

Where:

LOI % = Loss on Ignition (equivalent to the total Organic Matter)

W_{ign} = Weight after ignition

W_{dry} = Weight of dry sediment before ignition

5. Analytical techniques for organic compounds

Before proceeding to the analysis, an aliquot will be taken from the bulk sample and in order to be sure that what is analyzed is representative of the collected sample, the sediment sample should be well homogenized. This could be done in a specialized laboratory homogenizer, but it could be done, more simply, with a spatula, taking care of mixing well the sediment sample before collecting the 10 g aliquot (for organic) or the 1-2 g aliquot (for trace metal) for the extraction.

The analytical part can be found in the Reference Methods for Marine Pollution Studies published by UNEP. All these Reference Methods are available, free of charge, from IAEA-MEL/MESL.

With a set (one for 10 samples, as a minimal requirement) of sediment samples extracted, sediment Reference Material should be extracted to check the quality of the data produced (UNEP/IOC/IAEA/FAO, 1990).

5.1 Chlorinated pesticides and PCBs.

The analytical method for chlorinated pesticides and PCBs in sediment samples, can be found in UNEP/IOC/IAEA, 1996.

5.2 Petroleum hydrocarbons.

The analytical method for petroleum hydrocarbons can be found in UNEP/IOC/IAEA, 1992.

5.3 Organophosphorus pesticides

The analytical method for organophosphorus pesticides in sediment samples can be found in UNEP/FAO/IOC/IAEA, 1997.

6. Analytical techniques for trace metals

For trace elements, in general, the analytical methods can be found in UNEP/IOC/IAEA, 1995.

For mercury: in UNEP/IAEA, 1985 and UNEP/IOC/IAEA, 1985.

7. Sediment radiochronology with ^{210}Pb

One of the main objectives of surface sediment monitoring is to obtain time series that allow to derive the presence or absence of temporal trends due to anthropogenic pressure. However, monitoring programmes are often not long enough to produce valid assessments. Sediments integrate pollution signals and dated sediment cores may provide a reliable record of pollution levels (e.g. Sanchez-Cabeza and Druffel, 2009). Although radiocarbon is used to study impacts extending back millennia, the most suitable tracer for pollution studies is ^{210}Pb because its half-life (22.23 y) allows suitable dating for the last 100 years, when most of the anthropogenic impact has occurred.

^{210}Pb is a natural radionuclide of the ^{238}U radioactive chain with a half-life of $T_{1/2} = 22.23 \pm 0.12$ yr (DDEP, 2010). It is commonly assumed that *supported* ^{210}Pb in old (> 150 yr) sediments is in equilibrium with its parent radionuclide ^{226}Ra . In recent sediments, ^{210}Pb in disequilibrium with ^{226}Ra is named *excess (or unsupported)* ^{210}Pb ($^{210}\text{Pb}_{\text{ex}}$). The total ^{210}Pb concentration in sediments is usually measured i) by gamma spectrometry (46.5 keV line; Schelske et al., 1994), or ii) alpha spectrometry, through its daughter radionuclide when equilibrium is guaranteed (Sanchez-Cabeza et al., 1998). ^{226}Ra (supported ^{210}Pb) is usually determined by i) gamma spectrometry (352 keV line of ^{214}Pb in equilibrium) or ii) liquid scintillation (Sanchez-Cabeza et al., 2010). If the full ^{226}Ra profile is not available, a mean ^{226}Ra concentration can be i) computed as the mean ^{210}Pb in the core bottom if at least 3 sections show an approximately constant concentration, within the measuring uncertainty (Binford, 1990) or ii) estimated by extrapolation of ^{210}Pb in the bottom sections if the profile shows there an exponential behaviour. Then, $^{210}\text{Pb}_{\text{ex}} = ^{210}\text{Pb} - ^{226}\text{Ra}$.

The use of $^{210}\text{Pb}_{\text{ex}}$ to date sediment cores has been used in a large variety of studies. Since ^{210}Pb was first used to date ice cores (Goldberg, 1963), several authors have developed models that adapt to different sedimentary conditions. These models, used to date undisturbed sediments, can be deduced from a single fundamental equation (Krishnaswamy et al., 1971), which relates excess $^{210}\text{Pb}_{\text{ex}}$ concentration in sediment, its flux to the sediment surface and mass accumulation rate.

7.1. Basic information

$^{210}\text{Pb}_{\text{ex}}$ decays following the radioactive decay law. If both the sediment accumulation and the $^{210}\text{Pb}_{\text{ex}}$ flux to the sediment surface were constant, and there were no processes that redistribute $^{210}\text{Pb}_{\text{ex}}$ in the sediment, the profile of the $^{210}\text{Pb}_{\text{ex}}$ concentration along the core should be a pure exponential curve (Figure 8). These conditions are not commonly met, but the described models allow obtain good dates in many cases. Some needed physical constants and sampling details are:

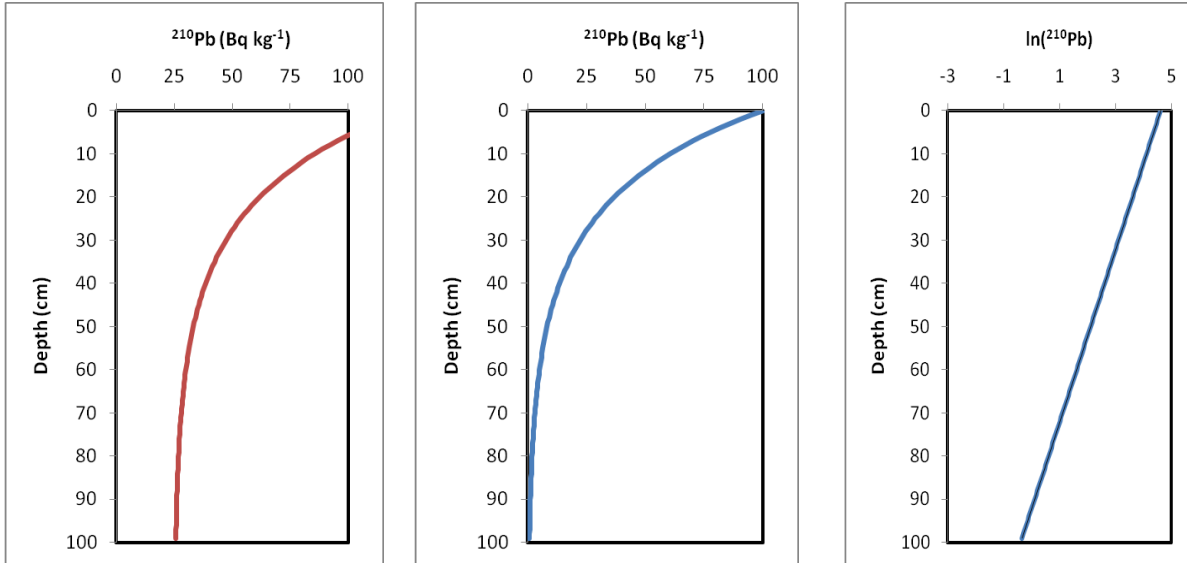

Figure 8. Ideal total ^{210}Pb (left), excess ^{210}Pb (centre) and its logarithm (right).

$$T_{1/2} = 22.23 \pm 0.12 \text{ yr} \text{ (DDEP, 2010): } ^{210}\text{Pb} \text{ half-life (yr)}$$

$$\lambda = 0.03118 \pm 0.00017 \text{ yr}^{-1}: ^{210}\text{Pb} \text{ disintegration constant (yr}^{-1}\text{)}$$

$T(0)$: sampling date (A.D.)

φ : internal core diameter (m)

$$S: \text{core cross-section (m}^2\text{), calculated as } S = \pi \left(\frac{\varphi}{2} \right)^2.$$

As different models use similar quantities and constants, a unified notation has been proposed (Sanchez-Cabeza and Ruiz-Fernandez, in press). For example, C_i is the $^{210}\text{Pb}_{\text{ex}}$ mean concentration of section i , assigned to the geometric centre of the section. Then C_1 is the top section and C_2 is the section below. In the Constant Flux (CF) model, equations refer to quantities in infinitesimal layers (i), derived from calculation. We use (i) to refer to the consecutive number of the surface cut (layer) when sampling. For example, (0) refers to the core surface and (1) to the first surface cut below the surface (usually of the order of 1 cm). For brevity, we define only quantities referred to either sections or layers (usually, section quantities are computed as means of layer quantities). To take into account sediment compaction dating must be performed as a function of mass depth m (kg m^{-2}) and not depth z (m):

- $z(i)$: depth of layer (i) (m), experimentally determined. Note that $z(0)=0$ m.
- Δz_i : width of section i (m), where $\Delta z_i = z(i) - z(i-1)$
- Δm_i : dry mass of section i (kg), experimentally determined
- $m(i)$: mass depth of layer (i) (kg m^{-2}), where $m(i) = \sum_{j=1}^{i-1} \frac{\Delta m_j}{S}$.

If we only know the section dry bulk densities ρ_j (kg m^{-3}), the mass depths $m(i)$ can also be calculated as $m(i) = \sum_{j=1}^{j=i} \rho_j \Delta z_j$. The mean dry bulk density of section j is easily computed as $\rho_j = \frac{\Delta m_j}{S \Delta z_j}$.

Some time related quantities are:

- $t(i)$: time elapsed since formation of layer (i) (yr). Note that $t(0) = 0$ yr
- $T(i)$: calendar age of layer (i) (A.D.), which is calculated as $T(i) = T(0) - t(i)$.

The CF model refers to $^{210}\text{Pb}_{\text{ex}}$ deposits (or activity per unit area):

- ΔA_i : $^{210}\text{Pb}_{\text{ex}}$ deposit in section i (Bq m^{-2}), computed as $\Delta A_i = \frac{C_i \Delta m_i}{S}$
- $A(i)$: accumulated deposit below layer (i) (Bq m^{-2}), computed as $A(i) = \sum_{j=i+1}^{j=\infty} \Delta A_j$
- $I = A(0)$: core $^{210}\text{Pb}_{\text{ex}}$ inventory (Bq m^{-2})

There is a large variety of definitions that describe sedimentation rates (linear or massic). The following are recommended:

- s : sediment accumulation rate – SAR (m yr^{-1}).
- r : mass accumulation rate – MAR ($\text{kg m}^{-2} \text{yr}^{-1}$). Sediment and mass accumulation rates (SAR and MAR) are proportional: $r = s \cdot \rho$

When a sediment layer (i) is formed, the $^{210}\text{Pb}_{\text{ex}}$ incorporated can be calculated as (Krishnaswamy et al., 1971):

$$C(i, t = 0) = \frac{f(i)}{r(i)} \quad (1)$$

This is the basic expression on which the dating models are based. If MAR increases, the concentration decreases and the ^{210}Pb signal is diluted. If MAR decreases, the concentration increases and the ^{210}Pb signal is enriched. Therefore, $^{210}\text{Pb}_{\text{ex}}$ profiles are not pure exponential functions when accumulation rates are variable.

7.2. Dating models

Dating models are used to i) obtain the section/layer age as a function of depth (t), ii) calculate accumulation rates (s , r) and iii) estimate sediment mixing rates (not reviewed here). The models have been recently reviewed by Sanchez-Cabeza and Ruiz-Fernandez (in press) and the more useful and commonly used models are described here.

7.2.1. Constant Flux and Sedimentation model (CFCS)

It is recommended that the dating experiment starts with the use of this model, commonly used in the literature to estimate mean accumulation rates. The Constant Flux and Constant Sedimentation model (CFCS; Crozaz et al., 1964; Krishnaswamy et al., 1971; Koide et al., 1973; Brugam, 1978; Appleby and Oldfield, 1983) is based on two hypotheses, (i) that the flux to the sediment surface (f) is constant and that the mass accumulation rate (r) is constant. In these conditions equation 1 leads to:

$$\frac{f}{r} = C_0 \quad (2)$$

The decay of ^{210}Pb as a function of time (and hence time) allows us to deduce the CFCS equation:

$$C_i = C_0 e^{-\lambda m_i / r} \quad (3)$$

This equation indicates that, when the CFCS hypotheses are met, a purely exponential decrease of C_i with depth should be observed (Figure 1, centre). This can be easily assessed by plotting the $^{210}\text{Pb}_{\text{ex}}$ profile in a logarithmic scale as a function of the MAR (Figure 1, right), and then perform a linear regression between (Crozaz et al., 1964) the logarithm of $^{210}\text{Pb}_{\text{ex}}$ concentration ($\ln C_i$) and the mass depth m_i :

$$\ln C_i = \ln C_0 - \frac{\lambda}{r} m_i \quad (4)$$

From the regression line equation obtained with a spreadsheet ($y = a + bx$) the intercept is $a = \ln C_0$ and the slope is $b = -\lambda / r$, then we can calculate $C_0 = e^a$ and, more importantly, $r = -\lambda / b$. From the regression uncertainties of a and b the uncertainties of C_0 and r can be easily derived. When the CFCS hypotheses are met, the purely exponential behavior of C_i vs. m_i allows to estimate ages. From the derived MAR, and assuming that $t(0) = 0$ yr, the age $t(i)$ can easily be derived from $t_i = T(0) + \frac{m_i}{r}$. When the profile is piecewise linear, showing two or more linear segments (Goldberg et al., 1977; Brugam, 1978), we may derive mean MAR for each segment.

7.2.2. Constant Flux model (CF)

The Constant Flux model (CF; Robbins, 1978; Smith and Walton, 1980; Appleby and Oldfield, 1983; Binford, 1990; Carroll and Lerche, 2003) is widely known as the Constant Rate of Supply model (CRS; Goldberg, 1963; Crozaz et al., 1964; Krishnaswamy et al., 1971; Appleby and Oldfield, 1978; Appleby, 2001 and 2008; Sanchez-Cabeza et al., 2000). The fundamental hypothesis is that the $^{210}\text{Pb}_{\text{ex}}$ flux to the sediment surface is constant (f). The age of layer (i) can be calculated as:

$$t(i) = \frac{1}{\lambda} \ln \frac{A(0)}{A(i)} \quad (5)$$

where $A(i)$ is the $^{210}\text{Pb}_{\text{ex}}$ accumulated deposit below layer (i) and that, therefore, $t(i)$ is the age of the infinitesimal layer (i), not of a section. The mean age of a section, can be estimated as

the mean of its upper and lower layers. $A(0)$ is the $^{210}\text{Pb}_{\text{ex}}$ core inventory and the $^{210}\text{Pb}_{\text{ex}}$ flux to the sediment surface is $f = \lambda A(0)$.

Garcia-Orellana et al. (2006a) evaluated the ^{210}Pb annual atmospheric flux to the Western Mediterranean from the analysis of 12 soil cores collected from coastal and island sites. The ^{210}Pb fluxes ranged from 34 ± 3 to 121 ± 12 $\text{Bq m}^{-2} \text{yr}^{-1}$, with an average of 75 $\text{Bq m}^{-2} \text{yr}^{-1}$, and were strongly correlated ($R^2 = 0.95$) with mean annual rainfall. These results can be used to assess the degree of $^{210}\text{Pb}_{\text{ex}}$ (and therefore fine particles) focussing in a particular area. In general, $^{210}\text{Pb}_{\text{ex}}$ inventories should be similar or higher than the expected atmospheric flux. Inventories below the expected atmospheric flux could indicate an incomplete inventory, due to erosion or removal of part of the sedimentary column by sedimentary events. Specific studies could be carried out to determine this value in specific regions (e.g. Sanchez-Cabeza et al., 2007).

The MAR can be calculated as:

$$r(i) = \frac{\lambda A(i)}{C(i)} \quad (6)$$

and then $s = r / \rho$. Mean section values can be calculated as the mean of their upper and lower layers.

7.2.3. Incomplete inventory

The use of the CF model requires the knowledge of the core $^{210}\text{Pb}_{\text{ex}}$ inventory, but this is sometimes not possible. The most common case is when the core length is too short and the ^{210}Pb profile does not reach the base value. In these cases it is recommended to use the CFCS model to obtain mean accumulation rates in the sampled segment and to estimate the missing inventory below layer (j) as (Appleby, 1998) $A(j) = \frac{r \cdot C(j)}{\lambda}$. Then, one can calculate the inventory from the accumulated deposit to the incomplete core bottom ($\delta(A)$) and then the total inventory is $A(0) = \delta A + A(j)$. With this value we can now use the CF model described above.

Alternatively, if a reference date (t) is known to happen at layer (i), we can calculate the inventory below that layer as $A(j) = \frac{\delta A}{e^{\lambda t} - 1}$ and then we can proceed as before (Appleby, 1998).

7.2.4. Mixed sediments

The main hypothesis of sediment dating is that the system is closed. This requires that $^{210}\text{Pb}_{\text{ex}}$ is not affected by redistribution processes. Mixed sediments do not provide useful information for reconstruction studies, although some information on mean accumulation rates below the mixed segment and other geochemical properties may be obtained.

The mixed segment (sometimes named SML, Single Mixed Layer) can be easily identified by the presence of an approximately constant ^{210}Pb activity (Figure 9). Below the mixed segment, the profile usually decreases exponentially and, therefore, the CFCS model can be used to derive MAR and SAR. Although some authors also use the CF model below

the mixed segment, caution must be taken as, assuming that mixing is the result of a continuous process, the apparent time span of the mixed segment should be taken into consideration when estimating age uncertainties. If a quadratic propagation scheme is used, any age will have an uncertainty larger than the time span covered by the mixed segment and, therefore, its utility will be compromised. Mixed sediments should only be used to estimate mean accumulation rates.

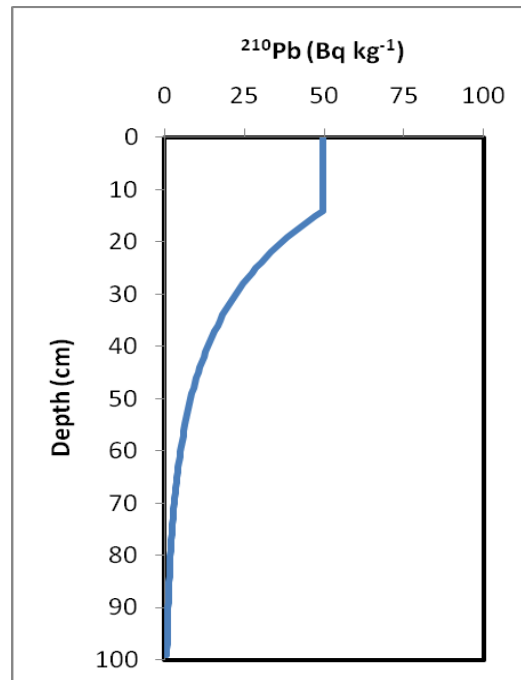

Figure 9. Mixed sediment. Notice the constant ²¹⁰Pb concentration at the surface.

7.3. Age model validation

The models shown are robust and have been successfully used many times. However, the complexity of most real situations (and particularly marine environments) is such that none of the models can be assumed appropriate without validation (Schottler and Engstrom, 2006). Traditionally, some global fallout radionuclides such as ¹³⁷Cs, ^{239,240}Pu and ²⁴¹Am are used. These three radionuclides should show a 1963 time mark in undisturbed sediments, corresponding to its maximum tropospheric concentration, and ¹³⁷Cs may reflect an additional time mark in 1986 due to the Chernobyl accident (e.g. Sanchez-Cabeza et al., 1999). Other time markers can be used to validate the age models, including for example:

- Volcanic eruptions may leave ash layers deposited in very short periods (Arnaud et al., 2006).
- Extreme events, such as floods, earthquakes and tsunamis, may leave distinct sedimentary deposits identified as abrupt changes of accumulation rates and various geochemical signatures (van den Bergh et al., 2003; Tuttle et al., 2004; Garcia-Orellana et al., 2006b).
- Changes in the type of accumulated particles (due to changes in land use, fires or other major catchment events) may be revealed by magnetostratigraphy (Oldfield and Appleby, 1984).
- The change in quantity and type of pollen grains may be related to changes in soil use in the catchment areas (Clark and Patt, 1984).

- Abrupt changes in known pollution sources (such as the opening or closure of a large industry) may be identified in polluted areas (Palanques et al., 1998; Diaz-Asencio et al., 2009).

7.4. Suggested procedure

If the $^{210}\text{Pb}_{\text{ex}}$ profile shows one or more exponential segments (linear segments in a logarithmic plot), mean MAR and SAR for each segment can be estimated by using the CFCS model. Although ages could also be estimated from MAR, the most realistic ^{210}Pb dating model is the CF model and is the one recommended to derive layer (and/or section) ages.

One procedure that could be useful in many cases is:

- From observations, calculate all basic parameters and variables.
- Observe the $^{210}\text{Pb}_{\text{ex}}$ profile, looking for deviations from the ideal exponential decay and formulating working hypothesis. If the core appears to be mixed, its use to reconstruct environmental conditions would be compromised and only MAR and SAR should be derived.
- Use the CF model to calculate the $^{210}\text{Pb}_{\text{ex}}$ flux to the surface sediment and compare it with other sediment cores and atmospheric fluxes. A deficit would imply sediment erosion and, therefore, its use to reconstruct environmental conditions would be compromised.
- Obtain the core age-model and section accumulation rates by using the CF model. Validate the CF age model.
- Obtain the MAR and SAR for each layer by using the CF model. Obtain the MAR and SAR for each section as the mean of 2 consecutive layers.
- Obtain mean accumulation rates (MAR and SAR) by using the CFCS model.
- If the $^{210}\text{Pb}_{\text{ex}}$ profile shows good linearity and the CF model cannot be validated, ages could be estimated from the MAR and massic depth by using the CFCS linear regression equation.

8. Conclusions

We can consider two different approaches to the sediment sampling for monitoring projects. They follow the schematics below depending on the budget and the manpower of the laboratories. One of the methods is a minimum requirement and the other would be the “state-of-the-art” methodology.

First approach (easiest and cheapest one):

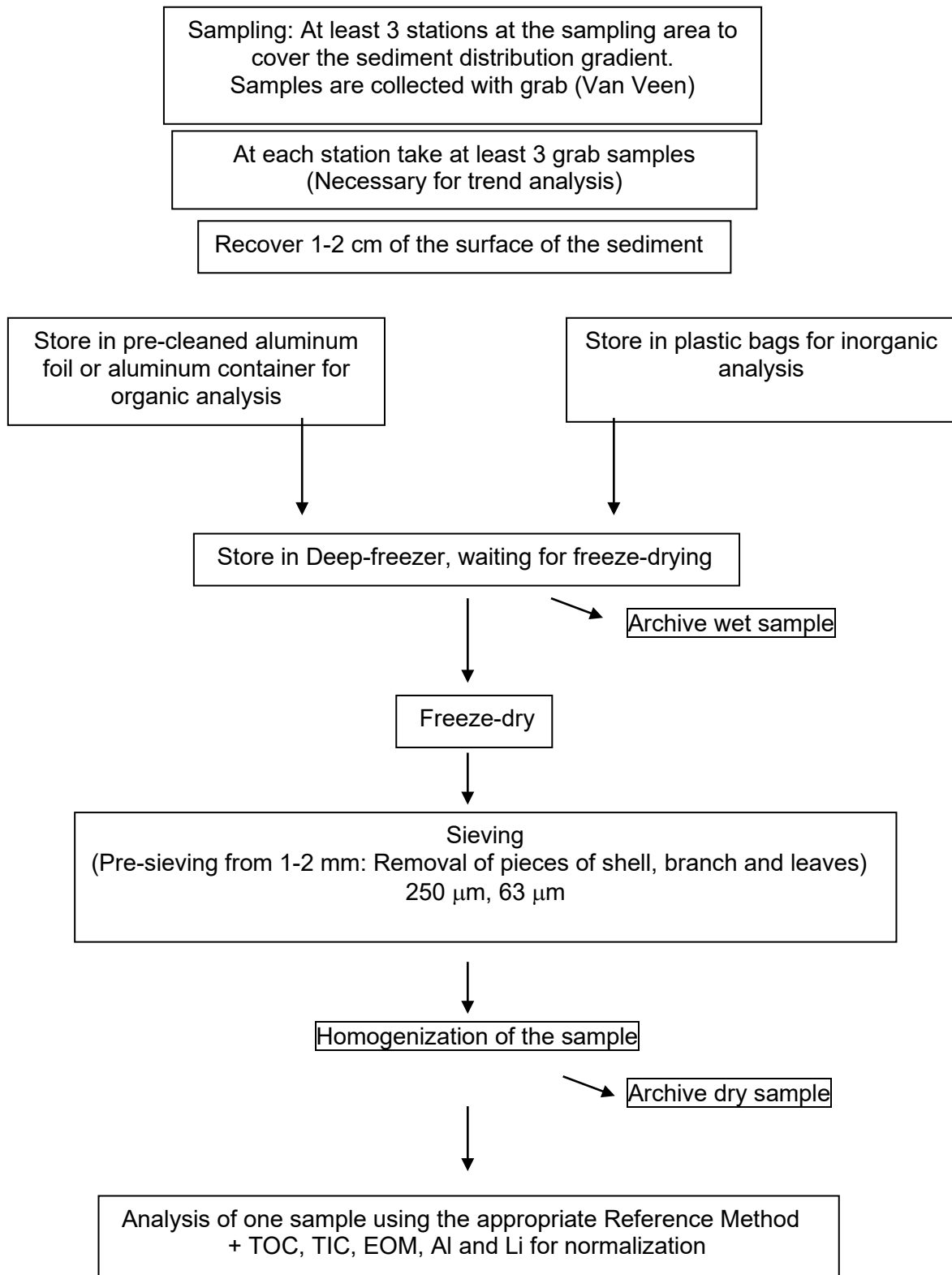

Second approach (complete procedure):

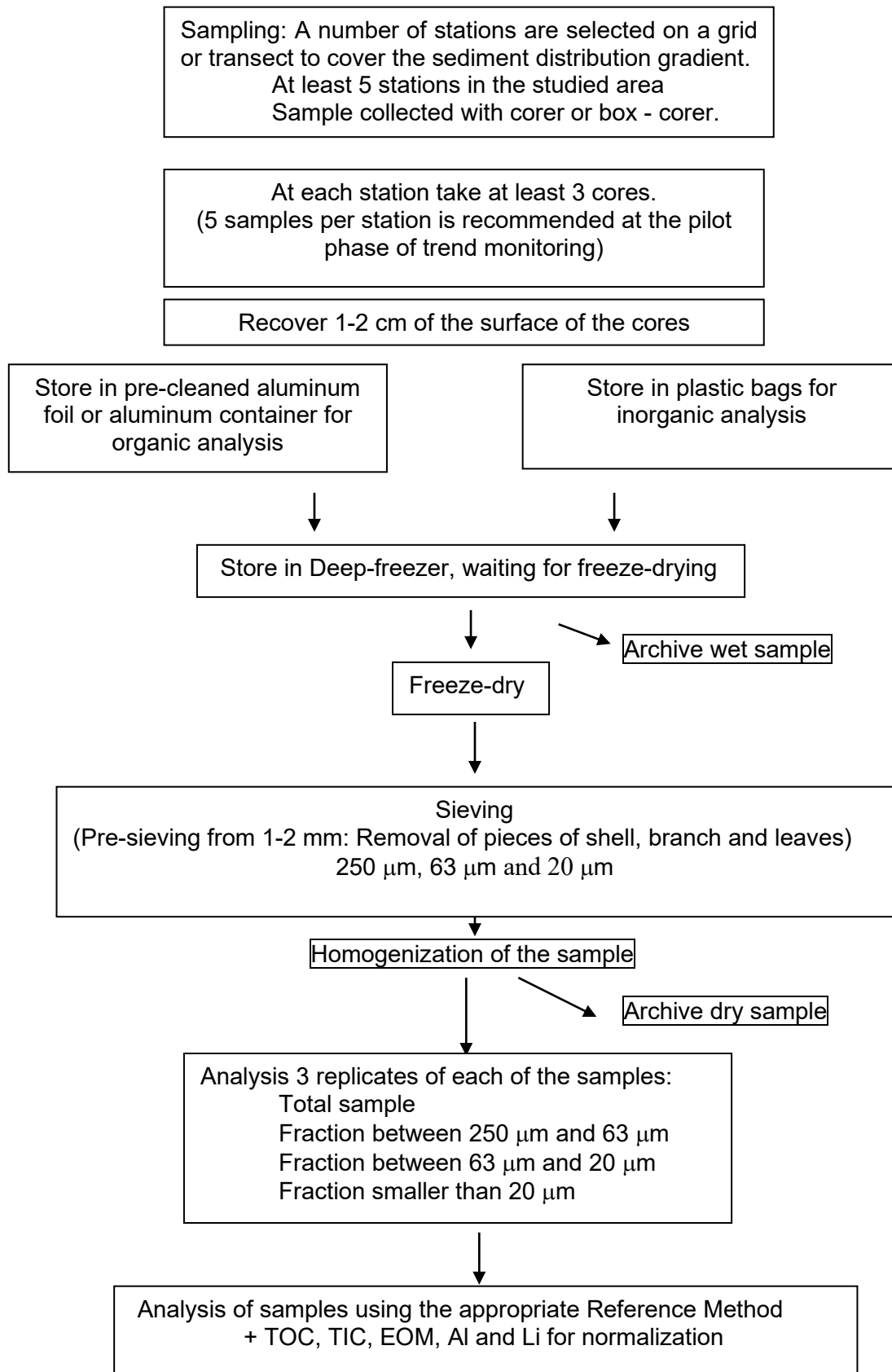

9. REFERENCES

- Ackerman F., 1980, A procedure for correcting grain size effect in heavy metal analysis of estuaries and coastal sediments. *Environment Technology Letters*, 1: 518-527.
- Allen JRL and Rae JE, 1987, Late Flandrian shoreline oscillations in the Severn estuary: A geomorphological and stratigraphical reconnaissance. *Philosophical Transactions of the Royal Society of London*, B315: 185-230.
- Aloupi M. and Angelidis M.O., 2001, Normalization to lithium for the assessment of metal contamination on coastal sediment cores from the Aegean Sea, Greece. *Marine Environmental Research*, 52: 1-12.
- Appleby P.G., Oldfield F., 1978, The calculation of ^{210}Pb dates assuming a constant rate of supply of unsupported ^{210}Pb to the sediment. *Catena*, 5: 1-8.
- Appleby P.G., Oldfield F., 1983, The assessment of ^{210}Pb data from sites with varying sediment accumulation rates. *Hydrobiologia*, 103: 29-35.
- Appleby P.G., 1998, Dating recent sediments by Pb-210: problems and solutions. *Proceedings of a Seminar, Helsinki, 2-3 April, 1997. STUK-A. 145: 7-24.*
- Appleby P.G., 2001, Chronostratigraphic techniques in recent sediments. In: *Tracking environmental change using lake sediments. Volume 1: Basin analysis, coring and chronological techniques*, Eds. W.M. Last, J.P. Smol, Kluwer Academic Publishers, Dordrecht, The Netherlands, 171–201.
- Appleby P.G., 2008, Three decades of dating recent sediments by fallout radionuclides: a review. *Holocene*, 18: 83–93.
- Arnaud F., Magand O., Chapron E., Bertrand S., Boes X., Charlet F., Melieres M.-A., 2006, Radionuclide dating (^{210}Pb , ^{137}Cs , ^{241}Am) of recent lake sediments in a highly active geodynamic setting (Lakes Puyehue and Icalma--Chilean Lake District). *Science of The Total Environment*, 366: 837-850.
- Barbanti A. and Bothner M.H., 1993, A procedure for partitioning bulk sediments into distinct grain-size fractions for geochemical analysis. *Environmental Geology*, 21: 3-13.
- Binford M.W., 1990, Calculation and uncertainty analysis of ^{21}P dates for PIRLA project lake cores. *Journal of Paleolimnology*, 3: 253-268.
- Bertine K.K. and Goldberg E.D., 1977, History of heavy metal contamination in shallow coastal sediments around Mitelene, Greece. *International Journal of Environmental Analytical Chemistry*, 68: 281-293.
- Blomquist S., Larsson U. and Borg H., 1992, Heavy metal decrease in sediments of a Baltic Bay following tertiary sewage treatment. *Marine Pollution Bulletin*, 24: 258-266.
- Brugam R.B., 1978, Pollen indicators of land-use change in Southern Connecticut. *Quaternary Research*, 9: 349-362.
- Carroll J., Lerche I., 2003, *Sedimentary processes: quantification using radionuclides*. Elsevier, Oxford, pp. 272.

Clark J.S., Patterson W.A., 1984, Pollen, Pb-210, and Opaque Spherules: An Integrated

Approach to Dating and Sedimentation in the Intertidal Environment. *Journal of Sedimentary Research*, 54: 1251.

Covelli S. and Fontolan G., 1997, Application of a normalization procedure in determining regional geochemical baselines. *Environmental Geology*, 30: 34-45

Crozaz G., Picciotto E., de Breuck W., 1964, Antarctic Snow Chronology with Pb-210. *Journal of Geophysical Research*, 69: 2597-2604.

Daskalakis K.D. and O'Connor T.P., 1995, Normalization and elemental sediment contamination in the coastal United States. *Environmental Science and Technology*, 29:470-477.

DDEP - Data Decay Evaluation Project. LNE-LNHB/CEA - Table de radionucléides 210Pb, http://www.nucleide.org/DDEP_WG/DDEPdata.htm, updated 20th August 2010.

Diaz-Asencio M., Alonso-Hernandez C., Bolaños-Alvarez Y., Gomez-Batista M., Pinto V., Morabito R., Hernandez-Albernas J., Eriksson M., Sanchez-Cabeza J.A., 2009, One century sedimentary record of Hg and Pb pollution in the Sagua estuary (Cuba) derived from 210Pb and 137Cs chronology. *Marine Pollution Bulletin*, 59: 108-115.

Din Z., 1992, Use of aluminum to normalize heavy-metal data from estuarine and coastal sediments of Straits of Melaka. *Marine Pollution Bulletin*, 24: 484-491.

Garcia-Orellana, J., Sanchez-Cabeza, J. A. , Masqué, P. , Àvila, A. , Costa, E. , Loÿe-Pilot, M.D. and Bruach-Menchén, J.M., 2006a, Atmospheric fluxes of 210Pb to the western Mediterranean Sea and the Saharan dust influence, *J. Geophys. Res.*, 111, D15305, doi 10.1029/2005JD006660.

Garcia-Orellana J., Gràcia E., Vizcaino A., Masqué P., Olid C., Martínez- Ruiz F., Piñero E., Sanchez-Cabeza J.A., Dañoibeitia J., 2006b, Identifying instrumental and historical earthquake records in the SW Iberian Margin using 210Pb turbidite dating. *Geophys. Res. Lett.*, 33: L24601.

Goldberg E.D., 1963, Geochronology with 210Pb. In: *Radioactive Dating. Proceedings of a Symposium*, International Atomic Energy Agency, Vienna, 121-131.

Goldberg E.D., Gamble E., Griffin J.J., Koide M., 1977, Pollution history of Narragansett Bay as recorded in its sediments. *Estuarine and Coastal Marine Science* 5, 549-561.

Grant A. and Middleton R., 1990, An assessment of metal contamination of sediments in the Humber Estuary, UK. *Estuary and Coastal Shelf Science*, 31: 71-85.

Grousset F.E., Quétel C.R., Thomas B., Donard O.F.X., Lambert C.E., Quillard F. and Monaco A., 1995, Anthropogenic vs. lithogenic origins of trace elements (As, Cd, Pb, Rb, Sb, Sc, Sn, Zn) in water column particles: northwestern Mediterranean Sea. *Marine Chemistry*, 48: 291-310.

Hanson P., Evans D.W. and Colby D.R., 1993, Assessment of elemental contamination in estuarine and coastal environments based on geochemical and statistical modeling of sediments. *Marine Environmental Research*, 36: 237-266.

- Herut B., Hornung H., Krom M.D., Kress N. and Cohen Y., 1993,. Trace metals in shallow sediments from the Mediterranean coastal region of Israel. *Marine Pollutant Bulletin*, 26: 675-682.
- Herut, B., Hornung, H., Kress, N., Krom, M.D. and Shirav, M., 1995, Trace metals in sediments at the lower reaches of Mediterranean coastal rivers, Israel. *Water Science Technology* 32: 239-246.
- Herut B., Gavrieli I. and Halicz L., 1997, Sources and distribution of trace and minor elements in the western Dead Sea surface sediments. *Applied Geochemistry* 12: 497-505.
- Herut, B., and Sandler, A., 2007, Normalization methods for pollutants in marine sediments: review and recommendations for the Mediterranean Basin. IOLR Report H31/2007.
- Innocent C., Fagel N. and Hillaire-Marcel C., 2000, Sm-Ns isotope systematics in seep-sea sediments: clay-size versus coarser fractions. *Marine Geology*, 168: 79-87.
- Kersten M. and Smedes F., 2002, Normalization procedures for sediment contaminants in spatial and temporal trend monitoring. *Journal of Environmental Monitoring*, 4: 109-115.
- Koide M., Bruland K.W., Goldberg E.D., 1973, Th-228/Th-232 and Pb-210 geochronologies in marine and lake sediments. *Geochimica et Cosmochimica Acta*, 37: 1171-1181.
- Krishnaswamy S., Lal D., Martin J., Meybeck M., 1971, Geochronology of lake sediments. *Earth and Planetary Science Letters*, 11: 407-414.
- Krom M.D., Stanely J.D., Cliff R.A. and Woodward J.C., 2002, Nile River sediment fluctuations over the past 7000 yr and their key role in sapropel development. *Geology*, 30: 71-74
- Loring D.H., 1990, Lithium – a new approach for the granulometric normalization of trace metal data. *Marine Chemistry*, 29: 155-168.
- Loring D.H and Rantala R.T.T., 1992, Manual for the geochemical analyses of marine sediments and suspended particulate matter. *Earth-Science Reviews*, 32: 235-283, and 1995, *Regional Seas, Reference methods for marine pollution studies no. 63*, United Nations Environment Programme.
- Oldfield F., Appleby P.G., 1984, A combined radiometric and mineral magnetic approach to recent geochronology in lakes affected by catchment disturbance and sediment redistribution. *Chemical Geology*, 44: 67-83
- OSPAR 2005, Assessment of CEMP data. OSPAR/JAMP 2002, Guidelines for Monitoring Contaminants in Sediment. Ref. No. 2002-16
- Palanques A., Sanchez-Cabeza J.A., Masqué P. León, L., 1998, Historical record of heavy metals in a highly contaminated mediterranean deposit: The Besos prodelta. *Marine Chemistry*, 61: 209-217.
- Roach A.C., 2005, Assessment of metals in sediments from Lake Macquarie, New South Wales, Australia, using normalization models and sediment quality guidelines. *Marine Environmental Research*, 59: 353-472.
- Robbins J.A., 1978, Geochemical and geophysical applications of radioactive lead isotopes. In: *Biochemistry of Lead*, Ed. J.O. Nriagu, Elsevier, Amsterdam, 285-393.

Rule J.P., 1986, Assessment of trace element geochemistry of Hampton Roads Harbor and lower Chesapeake Bay area sediments. *Environmental Geology and Water Science*, 8: 209-219.

Sanchez-Cabeza, J.A., Masqué, P. and Ani-Ragolta, I., 1998, ^{210}Pb and ^{210}Po analysis in sediments and soils by microwave acid digestion. *Journal of Radioanalytical and Nuclear Chemistry*, 227: 19-22.

Sanchez-Cabeza J.A., Masqué P., Ani-Ragolta I., Merino J., Frignani M., Alvisi F., Palanques A., Puig P., 1999, Sediment accumulation rates in the southern Barcelona continental margin (NW Mediterranean Sea) derived from ^{210}Pb and ^{137}Cs chronology. *Progress in Oceanography*, 44: 313–332.

Sanchez-Cabeza J.A., Ani-Ragolta I., Masque P., 2000, Some considerations of the ^{210}Pb constant rate of supply (CRS) dating model. *Limnology and Oceanography*, 45: 990-995.

Sanchez-Cabeza, J.A., Garcia-Talavera, M., Costa, E., Peña, V., Garcia-Orellana, J., Masqué, P., Nalda, C., 2007, Regional calibration of erosion radiotracers (^{210}Pb and ^{137}Cs): atmospheric fluxes to soils (Northern Spain). *Environmental Science and Technology*, 41: 1324-1330.

Sanchez-Cabeza J.A., Druffel E.R.M., 2009, Environmental records of anthropogenic impacts on coastal ecosystems: An introduction. *Marine Pollution Bulletin*, 59: 87-90.

Sanchez-Cabeza J.A., Liong Wee Kwong L., Betti M., 2010, Method to Determine ^{226}Ra in Small Sediment Samples by Ultralow Background Liquid Scintillation. *Analytical Chemistry*, 82: 6847-6853.

Sanchez-Cabeza J.A. and Ruiz-Fernández, A.C., in press. ^{210}Pb sediment radiochronology: an integrated formulation and classification of dating models. *Geochimica et Cosmochimica Acta*.

Schelske, C.L., Peplow, A., Brenner, M., Spencer, C.N., 1994, Low-background gamma counting: applications for ^{210}Pb dating of sediments. *Journal of Paleolimnology*, 10/2: 115-128.

Schiff K.C. and Weissberg S.B., 1999, Iron as a reference element for determining trace metal enrichment in Southern California coastal shelf sediments. *Marine Environmental Research*, 48: 161-176.

Schottler S.P., Engstrom D.R., 2006, A chronological assessment of Lake Okeechobee (Florida) sediments using multiple dating markers. *Journal of Paleolimnology*, 36: 19-36.

Sinex S.A. and Wright D.A., 1988, Distribution of trace metals in the sediments and biota of Chesapeake Bay. *Marine Pollution Bulletin*, 19: 425-431.

Smith J.N., Walton A., 1980, Sediment accumulation rates and geochronologies measured in the Saguenay Fjord using the Pb-210 dating method. *Geochimica et Cosmochimica Acta*, 44: 225-240.

Tuttle M.P., Ruffman A., Anderson T., Jeter H., 2004, Distinguishing Tsunami from Storm Deposits in Eastern North America: The 1929 Grand Banks Tsunami versus the 1991 Halloween Storm. *Seismological Research Letters*, 75: 117-131.

van den Bergh G.D., Boer W., de Haas H., van Weering Tj. C. E., van Wijhe R. Shallow marine tsunami deposits in Teluk Banten (NW Java, Indonesia), generated by the 1883 Krakatau eruption, 2003, *Marine Geology*, 197: 13-34.

Annex

Pictures of some sediment sampling devices.



Large grab sampler
(picture: S. de Mora)



Shipeck grab sampler.



Bottom sampler Ekman-Birge
(picture: Hydro-Bios, Germany).



Gravity core sampler
(picture: S. de Mora)

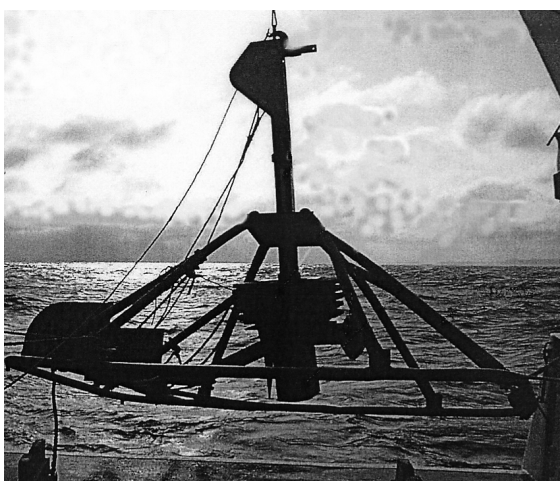

Reineck corer

Annex II
References

EC (2010). Guidance Document No: 25 Guidance on chemical monitoring of sediment and biota under the Water Framework Directive

HELCOM (2012). Manual for marine monitoring in the COMBINE programme. Annex B-13 Appendix 3.: Technical note on the determination of heavy metals and persistent organic compounds in marine sediment

ICES/OSPAR (2008). JAMP Guidelines for Monitoring Contaminants in Sediments

UNEP/MAP (1999). MED POL Phase III. Programme for the assessment and control of pollution in the Mediterranean Region.

UNEP/MAP (2011). UNEP(DEPI)MED WG.365/Inf.9. Manual on sediment sampling and analysis

UNEP/MAP (2019) UNEP/MED WG.467/5. IMAP Guidance Factsheets: Update for Common Indicators 13, 14, 17, 18, 20 and 21: New proposal for candidate indicators 26 and 27.

UNEP (2019 a) UNEP/MED WG.463/6. Monitoring Protocols for IMAP Common Indicators related to pollution.

Appendix 17

**Monitoring Guidelines/Protocols for Sample Preparation and Analysis of Sediment for IMAF
Common Indicator 17: Heavy and Trace Elements and Organic Contaminants**

1. Introduction

1. Determination of the concentrations of targeted heavy metals and organic contaminants in different marine matrices is a key component of the IMAP, since the analytical results will contribute to the assessment of the environmental status of the water body under consideration. Sediment is one of the proposed matrices for the analysis of heavy metals and organic contaminants since the establishment of the UNEP/MAP – MED POL Monitoring programme in 1981 (MED POL Phase II), because many heavy metals and persistent organic contaminants in seawater tend to become insoluble and precipitate with the particulate fraction on the seafloor. Therefore, since sediment is the ultimate sink of most heavy metals and persistent organic contaminants, which are introduced into the marine environment, their analysis will provide a clear view of the pollution state of the specific water body. Furthermore, in areas with undisturbed sediments, the yearly deposited sedimentary material integrates the pollution load during this specific time period, and the analysis of different sedimentary layers is providing a historical trend of pollution processes in the region.

2. Contaminants may enter the marine environment from land- and sea-based sources as well as through atmospheric deposition. Land-based sources are mainly affecting coastal sediments, where the higher metal and organic contaminants concentrations are usually found at the vicinity of pollution “hot spots” (coastal cities and industrial areas, river mouths draining highly populated and/or industrialized basins). Offshore sediments are mainly influenced by atmospheric deposition, which play globally a very important role, especially for some metals (such as Hg) and organic contaminants (such as PAHs).

3. Heavy metal sources are both natural and anthropogenic. Therefore, it is important to be able to differentiate between metal enrichments caused by natural causes (such as sediment’s mineralogy and granulometry) and those originating from human activities (urban, industrial). To that end, normalization of the heavy metal data is often used, in view of detecting the human imprint on the heavy metal distribution in sediment. On the other hand, persistent organic contaminants sources are solely anthropogenic, therefore the total contaminant’s load is of anthropogenic origin.

4. In line with IMAP requirements (UNEP/MAP, 2019a²²¹, UNEP/MAP, 2019b²²²), mandatory contaminants to be analysed in the marine sediment include: heavy metals (Cadmium (Cd), Lead (Pb) and total Mercury (THg)), organochlorinated compounds (PCBs, hexachlorobenzene, lindane and ΣDDTs) and Polycyclic Aromatic Hydrocarbons (US EPA 16 Reference PAHs compounds). Also, additional parameters to be analysed in sediment are: Aluminium (Al), Total Organic Carbon (TOC), grain size (<2 mm and <63 µm).

5. The UNEP/MAP Proposed assessment criteria (Background Assessment Criteria -BAC and Environmental Assessment Criteria - EAC) for targeted heavy metals and organic contaminants in sediments are presented in the Annex XIV.

6. The Protocols prepared in the framework of this Monitoring Guidelines/Protocols for Sample Preparation and Analysis of Sediment for IMAP Common Indicator 17, as provided here-below, describe appropriate methodologies for the analysis of marine sediments for the determination of heavy metals and organic contaminants, in order to ensure quality assured data. They are not intended to be analytical training manuals, but guidelines for Mediterranean laboratories, which should be tested and modified in order to validate their final results.

²²¹ UNEP/MAP (2019a). UNEP/MED WG.467/5. IMAP Guidance Factsheets: Update for Common Indicators 13, 14, 17, 18, 20 and 21: New proposal for candidate indicators 26 and 27;

²²² UNEP (2019b). UNEP/MED WG.463/6. Monitoring Protocols for IMAP Common Indicators related to pollution;

7. These Protocols aim at streamlining marine sediment sample preparation and analysis for heavy metals and organic contaminants in a view of assuring comparable quality assurance of the data, as well as comparability between sampling areas and different national monitoring programmes. They provide a step-by-step guidance on the methods to be applied in the Mediterranean area for sampling and sample preservation of sediments.

8. In order to avoid unnecessary repetitions, reference is also made to the protocols already published and publicly accessible, which can also be used by the Contracting Parties' competent laboratories participating in IMAP implementation. They build upon the UNEP/MAP - IAEA Recommended Methods for the analysis of heavy metals and organic contaminants, such as: IAEA (2011a) Recommended method on microwave digestion of marine samples for the determination of trace element content (Annex I); IAEA (2011b) Recommended method for the determination of selected trace element in samples of marine origin by flame atomic absorption spectrometry (Annex III); IAEA (2011c) Recommended method for the determination of selected trace element in samples of marine origin by atomic absorption spectrometry using graphite furnace (Annex IV); IAEA (2012a) Recommended method on the determination of Total Hg in marine samples by Thermal Decomposition Amalgamation and Atomic Absorption Spectrometry (Annex VI); IAEA (2012b) Recommended method for the determination of mercury in samples of marine origin by cold vapour atomic absorption spectroscopy (Annex VII); UNEP/IAEA (2011d) Sample work-up for the analysis of selected chlorinated hydrocarbons in the marine environment: Reference Methods for Marine Pollution Studies No 71 (Annex VII); , which were prepared in the framework of the MED POL monitoring programme. They are also streamlined with similar Guidelines/Protocols for marine sediment sample preparation and analysis which were developed by other Regional Organisations, such as OSPAR (Annex II, VIII, X and XII) and HELCOM (Annexes XI and XIII), therefore any of these Guidelines are equally suitable to be applied in the context of IMAP, as well as and US EPA (Annex V). Given the suitability of any of these Guidelines in the context of IMAP, they could be further used by interested IMAP competent Mediterranean laboratories for developing their laboratory specific sampling and sample processing methodologies. The Contracting Parties' laboratories should accommodate and always test and modify each step of the procedures to validate their results.

9. The below flow diagram informs on the category of this Monitoring Guideline related to sample preparation and analysis of sediment for IMAP Common Indicator 17 within the structure of all Monitoring Guidelines prepared for IMAP Common Indicators 13, 14, 17, 18 and 20.

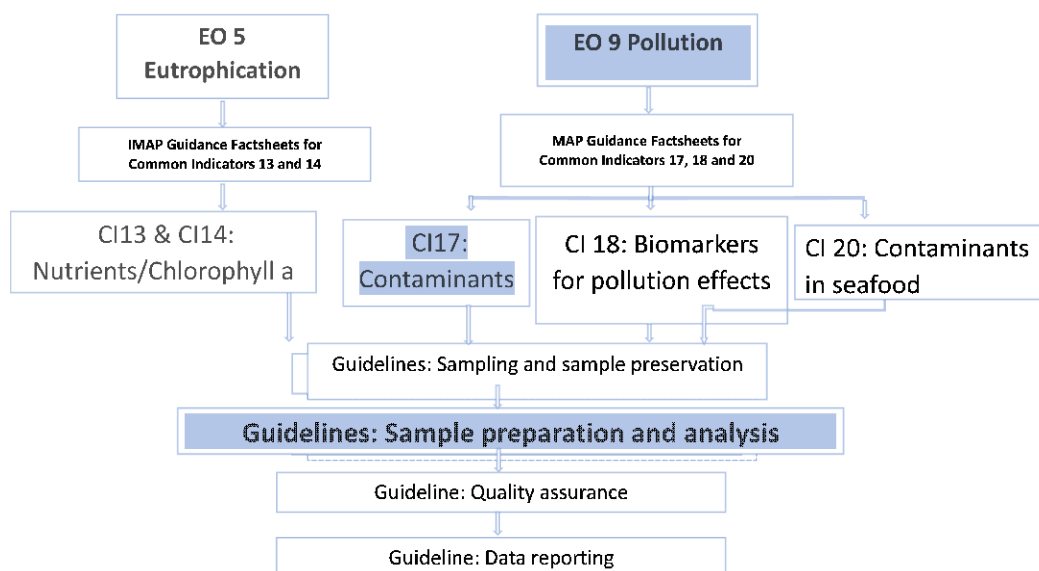

Flow Diagram: Monitoring Guidelines for IM Ecological Objectives 5 and 9

2. Technical note for the analysis of heavy metals in sediment

10. Analysis of marine sediment samples for the determination of heavy metals²²³ include: i) digestion of sediments and ii) analysis of the digested sample for heavy metals. Cd, Pb and THg are the mandatory metals to be determined in marine sediment samples (UNEP/MAP, 2019a). However, the Contracting Parties to the Barcelona Convention may decide to include in their national monitoring programmes the analysis of additional heavy metals according to their national priorities.

11. National laboratories may decide to use any validated analytical method they consider appropriate, which meets specific performance criteria (LOD, LOQ, precision, recovery and specificity). However, in order to assist analytical laboratories of the Contracting Parties, the IMAP Protocols in order to be used as guidelines for the analysis of heavy metals and trace elements in marine sediment samples. Analytical laboratories should accommodate, test and modify each step of the procedures presented in the Protocols in order to validate their final results. The list of methods and analytical equipment is not exhaustive, and laboratories are encouraged to use their own equipment/methods that consider adequate for the required analyses.

12. Regardless of the analytical method used, heavy metal analysis follow some procedures common to all analytical methodologies, such as the calibration of the analytical equipment and the cleaning and handling procedures to avoid the contamination of the samples from the laboratory's environment and the tools and containers used in the analysis.

a) Calibration

13. Calibration standards prepared from single standard stock solutions or multielement standards, by dilution of the stock solution using dilute acid, as required. All standard solutions have to be stored in polyethylene, borosilicate or quartz volumetric flasks. Standard solutions with lower concentrations, if prepared correctly and controlled in a QA system (checking of old versus new standards, and checking with standards from a different source), can be kept for a period no longer than one month

²²³ In the Guideline text the term "heavy metals" is used to designate both heavy metals and trace elements

14. The calibration procedure has to meet some basic criteria in order to provide the best estimation of the true element concentration of the sample analysed (HELCOM, 2012a²²⁴):

- i) the concentrations of standards for the preparation of the calibration curve should cover the range of anticipated concentrations;
- ii) the required analytical precision should be known and achievable throughout the entire range of concentrations;
- iii) the measured value at the lower end of the range has to be significantly different from the procedural analytical blank;
- iv) the chemical and physical properties of the calibration standards must closely resemble those of the sample under investigation.

b) Avoiding contamination

15. To avoid metal contamination in the laboratory all glassware and plastic vessels used should be carefully cleaned. The general cleaning guidelines include:

- i) Allow the vessels to soak overnight in a plastic container in a soap solution (solution 2% in tap water);
- ii) Rinse thoroughly first with tap water then with ultrapure deionised water;
- iii) Leave the vessels to stand in 10% (v/v) concentrated HNO₃ solution at room temperature for at least 6 days;
- iv) Rinse thoroughly with Milli-Q water (at least 4 times);
- v) Allow the vessels to dry under a laminar flow hood;
- vi) Store the vessels in zip-lock plastic polyethylene bags to prevent the risk of contamination prior to use.

16. This procedure should be used for all plastic ware use in the laboratory as tips, cup for autosampler, plastic containers.

17. Under this Technical Note, the Guideline for Sample Preparation and Analysis provides the following IMAP Protocols:

- Protocol for sediment digestion using nitric acid and hydrofluoric acid (microwave assisted digestion in closed systems and digestion on hot plate);
- Protocol for the analysis of heavy metals with Flame Atomic Absorption Spectroscopy (F-AAS);
- Protocol for the analysis of heavy metals with Graphite Furnace Atomic Absorption Spectroscopy (GF-AAS);
- Protocol for the analysis of heavy metals with Inductive Coupled Plasma – Mass Spectroscopy (ICP-MS);
- Protocol for the analysis of Total Mercury with solid Hg analyser;
- Protocol for the analysis of Total Mercury in samples or marine origin by Cold Vapour Atomic Absorption Spectrometry;
- Protocol for the normalization of heavy metal concentrations using Al.

²²⁴ HELCOM (2012a). Manual for marine monitoring in the COMBINE programme. Annex B-13 Appendix 3: Technical note on the determination of heavy metals and persistent organic compounds in marine sediment.

18. These Protocols are based on Analytical Methods developed by IAEA (Annex I: Recommended method on microwave digestion of marine samples for the determination of trace element content ; Annex III: Recommended method for the determination of selected trace element in samples of marine origin by flame atomic absorption spectrometry; Annex IV: Recommended method for the determination of selected trace element in samples of marine origin by atomic absorption spectrometry using graphite furnace; Annex VI: Recommended method on the determination of Total Hg in samples of marine origin by Cold Vapour Atomic Absorption Spectrometry and Annex VII: Recommended method for the determination of mercury in samples of marine origin by cold vapour atomic absorption spectroscopy), OSPAR (Annex II: CEMP Guidelines for Monitoring Contaminants in Sediments. Technical Annex 6: Determination of metals in sediments – analytical methods, Annex VIII: CEMP Guidelines for Monitoring Contaminants in Sediments. Technical Annex 5: Normalisation of contaminant concentrations in sediments), and US EPA (Annex V: US-EPA Method 6020B. ICP-MS method for the determination of elements in water samples and in waste extracts or digests).

2.1 Protocol for sediment digestion using nitric acid and hydrofluoric acid

19. Sediment samples have to be digested (wet ashing) prior to analysis. The rate of digestion and the efficiency of acid decomposition increase substantially with elevated temperatures and pressure, therefore microwave digestion in closed vessels is the preferred method. However, in case no such equipment is available, sample digestion in open vessels over a hot plate is an alternative method.

20. IMAP requires the complete disintegration of the silicate matter of sediments using Hydrofluoric acid (HF) in order to measure the total metal load in sediments, including Al, which is needed for normalization purposes. Furthermore, Certified Reference Materials (CRMs) of sediments provide certified values for total metal concentrations, therefore their use to strengthen data quality assurance requires the measurement of the total metal content in sediment samples

a) Microwave acid digestion in closed systems for heavy metals for AAS, GFAAS and ICP-MS analysis

21. Sediment digestion can be performed in Teflon, or equal quality vessels, which are metal free and resistant to strong acids including HF (Loring and Rantala, 1991²²⁵). Dried sediment samples (0.1 to 0.5 g) are weighted in the microwave vessel and placed in a laminar hood compatible with acid fume. Approximately 5 ml of analytical grade nitric acid and 2 ml of analytical grade hydrofluoric acid are added and each vessel and let to react for at least 1 hour (or more if possible). After the room temperature pre-digestion, 2ml of hydrogen peroxide (analytical grade) are added carefully, the vessels are closed and placed in the microwave apparatus and digestion steps are performed, following the IAEA's Recommended method on microwave digestion of marine samples for the determination of trace element content (Annex I. IAEA 2011a²²⁶). Oxygen peroxide and organic matter can promote an explosive reaction, so this acid must be treated with great caution when added to the sediment. Also because closed vessels retain the HF, boric acid is added after the HF digestion to complex the remaining HF and make the resulting solution less hazardous, as well as preventing aluminium fluoride precipitation. After digestion the vessels are removed from the microwave apparatus and placed in a ventilated fume hood to cool. When the pressure is adequate, the vessels are opened, and their content is transferred into a 50 ml polypropylene graduated tubes. At least one Certified Reference Material should be used and prepared in duplicate for each digestion batch. These digestions

²²⁵ Loring, DH and Rantala RTT (1991). Manual for the geochemical analyses of marine sediments and suspended particulate matter. Earth-Science Review, 32: 235:283. Elsevier Science Publishers B.V

²²⁶ IAEA (2011a). Recommended method on microwave digestion of marine samples for the determination of trace element content (IAEA/Marine Environmental Studies Laboratory in co-operation with UNEP/MAP MED POL)

are prepared in a similar manner as the samples. A reference material of similar composition and concentration range should be used.

22. Microwave assisted acid digestion of sediments are also proposed by OSPAR (2018a²²⁷) (Annex II), HELCOM (2012a) and US EPA (1996²²⁸) (Method 3052).

b) Acid digestion over a hot plate

23. In case no microwave digestion system is available, it is possible to perform digestion over a programmable heating plate placed inside a metal free and acid resistant fume hood, allowing HF and other acids treatment. Sediment samples are treated in closed Teflon vessels with hydrofluoric acid (HF) in combination with aqua regia in order to decompose the samples. The use of HF is essential because it is the only acid that completely dissolves the silicate lattices and releases all the metals. However, it should be noted that digestion in open systems may lead to loss of Hg (Delft and Vos, 1988²²⁹), while great care should be made to avoid loss of material because of violent boiling reactions. Therefore, digestion over a hot plate is not a recommended method and should be avoided if possible.

24. Several acid mixtures (together with HF) have been used for sediment digestion over a hot plate, such as aqua regia, nitric acid or perchloric acid (Loring and Rantala, 1991; Cook et al, 1997²³⁰). In case perchloric acid is used solutions are left to stand for a period of 1 hour – overnight to avoid problems with violent reactions, which may be prompted by the presence of organic matter in the sediment. Then the vessels are closed and placed on a hot plate at 120 °C or in boiling water for 1-2h depending on the method followed. Then the samples are allowed to cool to room temperature, the tubes are opened and boric acid is added to complex the remaining HF (OSPAR 2018a).

2.2 Protocol for the analysis of heavy metals with Flame AAS

25. In most marine sediments Al, Cu, Cr, Fe, Ni, Zn, as well as other metals, can be determined by Flame Atomic Absorption Spectroscopy, which has adequate sensitivity for these determinations.

26. In Atomic Absorption Spectrometry the sample solution is aspirated into a flame and atomized. A light beam is directed through the flame, into a monochromator, and onto a detector that measures the amount of light absorbed by the element in the flame. Each metal has its own characteristic wavelength so a source hollow cathode lamp composed of that element is used. The amount of energy absorbed at the characteristic wavelength is proportional to the concentration of the element in the sample.

27. Metal standard solutions for the calibration curve are prepared from stock standard solution (1000 mg l⁻¹ or an intermediate stock standard). Depending on the element, it may be necessary to make an intermediate stock standard solution. This intermediate stock is prepared as described in the Technical Note in a 2% HNO₃ matrix. The calibration curve is determined according to the expected concentrations of the samples, and the linearity of the AAS response for the element is considered (absorbance versus concentration curve given in the analytical methods book). If ionization or

²²⁷ OSPAR (2018a). CEMP Guidelines for Monitoring Contaminants in Sediments. Technical Annex 6: Determination of metals in sediments – analytical methods

²²⁸ US EPA (1996). Method 3052: Microwave assisted acid digestion of siliceous and organically based matrices.

²²⁹ Delft W. van; Vos. G. (1988) Comparison of digestion procedures for the determination of mercury in soils by cold-vapor atomic absorption Spectrometry; *Analytica Chimica Acta*, 209, 147-156.

²³⁰ Cook JM, Robinson JJ, Chenery SR and Miles DL (1997). “Determining cadmium in marine sediments by inductively coupled plasma mass spectrometry: attacking the problems or the problems with the attack?” *Analyst*, 122, 1207-1210

interferences are likely, the right option according to the analytical method book has to be chosen, e.g. use of correction for non-atomic absorption by using deuterium lamp background corrector; use of oxidizing air-acetylene flame; use of nitrous oxide-acetylene flame; addition of a releasing agent or ionization suppressant.

28. A detailed analytical protocol for the analysis of heavy metals in sediments prepared by IAEA (2011b) is presented in the Annex III.

2.3 Protocol for the analysis of heavy metals with GF-AAS

29. In marine sediments Cd, Pb, Cu as well as other metals, can be determined by Graphite Furnace Atomic Absorption Spectroscopy (GF-AAS), which has adequate sensitivity for these determinations. For GF-AAS analysis, after the digestion of the sediment sample, an aliquot of sample solution (10-50 µl) is introduced into a graphite tube of the GF-AAS and atomized by rapid heating at high temperature. A light beam is directed through the graphite tube, into a monochromator, and onto a detector that measures the amount of light absorbed by the atomized element in the tube. Each metal has its own characteristic wavelength, so a source hollow cathode lamp composed of that element is used. The amount of energy absorbed at the characteristic wavelength is proportional to the concentration of the element in the sample.

30. The reagents used include: argon, standard solution of the element of interest 1000 mg l⁻¹, deionized water. All reagents should be of analytical grade.

31. A detailed analytical protocol for the analysis of heavy metals in sediments by GF AAS prepared by IAEA (2011c²³¹) is presented in the Annex IV.

32. The AAS software generally gives typical electrothermal programs for each element for 10 µl of sample in diluted HNO₃ (0.1%) and indications concerning maximum ashing and atomization temperatures. More specific information may also be found in the literature, such as recommendations regarding matrix modifiers and the use of partition tubes or tubes with platform. When a program is optimized for the determination of an element in a specific matrix, all information should be reported in the logbook of methods of the laboratory.

33. For some elements and some matrices, the results obtained are still not satisfactory (e.g. maximum ashing temperature is not sufficient to eliminate the background), this procedure should be redone with the addition of a matrix modifier. Different matrix modifiers could be tried before finding the best solution.

2.4 Protocol for the analysis of heavy metals with ICP-MS

34. Inductive Coupled Plasma – Mass Spectroscopy (ICP-MS) is currently state-of-the-art instrumentation for metal analysis, with the possibility to determine at sub-µg L⁻¹ concentrations of a large number of elements in water and acid digested sediment samples.

35. Typical limits of detection for the determination of trace metals with ICP-MS (in mg kg⁻¹ d.w.) based on typical sample intakes (0.5 –1 g), are as follows (OSPAR, 2018):

Al	Li	As	Cd	Cr	Cu	Hg	Ni	Pb	Zn
40	0.1	1	0.01	0.2	0.1	0.05	0.2	0.2	2

²³¹ IAEA (2011c). Recommended method for the determination of selected trace element in samples of marine origin by atomic absorption spectrometry using graphite furnace

36. Inductively coupled plasma attached to a mass spectrometer (ICP-MS) allows a rapid analysis of a wide range of heavy metals. Most routine instruments utilize a quadrupole mass spectrometer, so mass resolution is not high enough to avoid overlap of double charged elements or multi-element ions (mainly hydrides, oxides and hydroxides) formed in the plasma. The main concern is for the Ar interferences as the plasma is usually an argon plasma. Some elements are prone to memory effects (particularly Hg) and needs extra precautions to avoid carry over effects. Modern ICP-MS instruments software includes all the tuning and correction formulas needed and described above to perform the analysis (HELCOM 2012a).

37. A multi-elemental determination of heavy metals by ICP-MS in water and solid samples after acid digestion, is described in the US EPA Method 6020B (2014 revision). Metal species originating in a liquid are nebulized and the resulting aerosol is transported by argon gas into the plasma torch. The ions produced by high temperatures are entrained in the plasma gas and introduced, by means of an interface, into a mass spectrometer. The ions produced in the plasma are sorted according to their mass-to-charge ratios and quantified with a channel electron multiplier. Interferences must be assessed and valid corrections applied. Interference correction must include compensation for background ions contributed by the plasma gas, reagents, and constituents of the sample matrix. The US EPA Method 6020B is presented in Annex V (US EPA 2014²³²).

2.5 Protocol for the analysis of Total Mercury with solid Hg analyser

38. Total mercury in the sediment can be analysed by solid Hg analyser, which has adequate sensitivity for this determination. The sample is dried and then chemically decomposed under oxygen in the decomposition furnace. The decomposition products are carried out to the catalytic section of the furnace, where oxidation is completed (halogens and nitrogen/sulfur oxides are trapped). The mercury present in the remaining decomposition products is selectively trapped on an amalgamator. After flushing the system with oxygen, the mercury vapour is released by rapid heating of the amalgamator and carried through the absorbance cell in the light path of a single wavelength atomic absorption spectrophotometer. The absorbance is measured at 253.7 nm as a function of mercury quantity (ng). The typical working range is 0.1–500 ng. The mercury vapour is carried through a long (first) and a short path length absorbance cell. The same quantity of mercury is measured twice with different sensitivity resulting in a dynamic range that spans four orders of magnitude. The typical detection limit is 0.01 ng of mercury.

39. Calibration standards should be prepared from single standard stock solutions or multielement standards by dilution of the stock solution using dilute acid, as required. All standard solutions have to be stored in Teflon, borosilicate or quartz volumetric flasks in 0.5-1 % HNO₃ and 0.1% (v/v) potassium dichromate. An alternative calibration curve can be performed using a solid certified reference material.

40. A detailed method describing the protocol for the determination of total mercury (inorganic and organic) in sediment prepared by IAEA (2012a²³³) ANNEX V): Recommended method on the determination of Total Mercury in marine samples by thermal decomposition, amalgamation and Atomic Absorption Spectrophotometry. With this method, Total Hg is determined without any chemical pre-treatment of the sample, minimising possible contamination and/or additional errors due

²³² USEPA (2014 revision) Method 6020B, ICP-MS. Environmental protection Agency, Washington, DC.

²³³ IAEA (2012a) Recommended method on the determination of Total Hg in marine samples by Thermal Decomposition Amalgamation and Atomic Absorption Spectrometry

to sample handling. (Annex VI). The method is based on the US EPA 7473 method (US EPA, 2007a²³⁴).

2.6 Protocol for the analysis of Total Hg in sediments by CV-AAS

41. In the Cold Vapour Atomic Absorption Spectrometry (CV-AAS) method, the inorganic mercury is reduced to its elemental form with stannous chloride. The cold mercury vapour is then passed through the quartz absorption cell of an AAS instrument where its concentration is measured. The light beam of Hg hollow cathode lamp is directed through the quartz cell, into a monochromator and onto a detector that measures the amount of light absorbed by the atomized vapour in the cell. The amount of energy absorbed at the characteristic wavelength is proportional to the concentration of the element in the sample.

42. The method is simple, rapid and applicable to a large number of environmental samples with a typical working range 0.25–100 ng mL⁻¹ for direct injection of cold vapour, using “batch” system. CV-AAS analysis can be performed manually using batch CV-AAS or automatically using flow injection (FIAS) techniques. FIAS is a very efficient approach for introducing and processing liquid samples in atomic absorption spectrometry, reduces sample and reagent consumption, and has a higher tolerance of interferences, lower determination limits and improved precision compared with conventional cold vapour techniques (HELCOM, 2012b²³⁵).

43. A detailed Recommended Method prepared by IAEA (2012b²³⁶) describing the protocol for the determination of total mercury in sediment using CV-AAS is presented in Annex VII. Methods for the determination of Total Hg in marine biota using CV-AAS are also prepared by HELCOM (2012b) and US EPA (2007b²³⁷).

2.7 Protocol for the normalization of heavy metal concentrations using Al

44. Normalization is defined here as a procedure to adjust heavy metal concentrations for the influence of the natural variability in sediment composition, grain size and mineralogy. In non-polluted sediments heavy metal concentrations usually increase with decreasing grain size of the sediment and therefore any differences in metal concentrations caused by pollution sources will be obscured by grain size differences. Normalization is therefore applied to differentiate between natural variability and anthropogenic input of contaminants.

45. A normalization approach is to consider that in sandy sediments heavy metals concentrations are considered as negligible, therefore metal concentration determined in the <2 mm fraction could be subsequently normalized to a sample consisting of 100% of the <63 µm fraction. However, this approach cannot always successfully compensate for metal variability, because natural trace metal concentrations and their variability in sediments are determined not only by grain size distribution, but also by the composition of minerals and secondary compounds.

²³⁴ US EPA (2007a). U.S. Environmental Protection Agency, EPA method 7473, Mercury in solids and solutions by thermal decomposition, amalgamation and atomic absorption spectrophotometry Rev 0.
<http://www.epa.gov/osw/hazard/testmethods/sw846/pdfs/7473.pdf>

²³⁵ HELCOM (2012b). COMBINE Annex B-12, Appendix 4, Attachment 1. Technical note on the determination of Total Mercury in marine biota by Cold Vapour Atomic Absorption Spectroscopy.

²³⁶ IAEA (2012b). Recommended method on the determination of Total Hg in samples of marine origin by Cold Vapour Atomic Absorption Spectrometry

²³⁷ US EPA (2007b). U.S. Environmental Protection Agency, EPA method 7473, Mercury in solids and solutions by thermal decomposition, amalgamation and atomic absorption spectrophotometry Rev 0.
<http://www.epa.gov/osw/hazard/testmethods/sw846/pdfs/7473.pdf>

46. To overcome this drawback, a geochemical normalization approach is often used. This technique consists in establishing the mathematical relationships between metal concentrations and the concentrations of a conservative element, which represents a certain mineral fraction of the sediment. Elements of natural origin which are structurally combined to one or more of the major fine-grained trace metal carriers are considered conservative and have been used for normalization purposes. Aluminium (Al) has been the most widely used element for normalization, because it is a major constituent of fine-grained aluminosilicates with which the bulk of trace metals are associated. However, this assumption may not be valid in all cases, since there are components in sediment which may also serve as hosts for contaminants with an even higher sorptive capacity but contain neither Si nor Al, such as organic matter, Fe/Mn oxides, or sulfide minerals (Kestern and Smedes, 2002²³⁸). Furthermore, when the sediment is derived from glacial erosion of igneous rocks, with significant amounts of aluminium present in feldspar minerals contributing to the coarse fraction, it is preferable to use lithium as a conservative element for normalization (Loring 1991²³⁹).

47. The main assumption for the application of a geochemical normalization to a conservative element is the existence of a linear relationship between the normalizer and other metals. Such a relationship suggests that, in the natural sediments of an area, the concentration of the metal will change proportionally to the concentration of the normalizer. Also, a linear relationship must exist between the normalizer's concentration and the percentage of fine-grained (silt and clay) content of the samples. Such a relationship would allow the use of the normalizer concentrations as a proxy for granulometric variability of the sediments, in order to distinguish the pollution-related metal enrichment from the natural enrichment caused by grain size variability (Loring and Rantala 1991).

Normalization procedure

48. Heavy metals (Me) concentrations are divided by the concentration of the normalizer (or co-factor) in each sample. The Me/Al ratio in the references stations represent the natural relationship between the two metals in the sediments of the area, while higher Me/Al ratios indicate metal enrichment, which cannot be explained by the natural textural variability, and should be attributed to anthropogenic inputs. A more detailed approach will calculate the regression line (and the slope) between the metal and the normalizer (Al) concentrations in the sediments of an area. In order to ensure that the changes in the normalizer's concentration reflect the differences in finer material content, it is necessary to also establish a statistically significant regression between the normalizer (Al) and the finer fraction of the sediments (i.e. clay < 2 µm or even silt+clay < 63 µm), in order to check that the normalizer is suitable to be used as a proxy of the finer sediment (Loring 1991).

49. Kestern and Smedes (2002) propose to analyse also the sand fraction (>63 µm) in order to calculate the Al (or Li) concentrations in the coarse sediments. They propose a model as presented in Figure 1. "C_X and N_X represent the co-factor and the contaminant contents possibly present in the coarse material (e.g., Al in feldspar) and can be estimated from samples without fine material. The regression line between the contaminant and co-factor will originate from that point. Regressions of co-genetic data sets but with a different contamination levels will have this point in common but tend to develop different slopes from this "turning point". In principle, therefore, only one additional sample is required to estimate the slope for a co-genetic sample set if this turning point is known. The slope for this sample with a contaminant content C_S and a co-factor content N_S can be expressed as follows":

²³⁸ Kestern, M. and Smedes, F. (2002). Normalization procedures for sediment contaminants in spatial and temporal trend monitoring. J. Environ. Monit. 4, 109-115.

²³⁹ Loring, DH (1991). Normalization of heavy metal data from estuarine and coastal sediments. ICES J. Mar. Sci. 48, 101-115

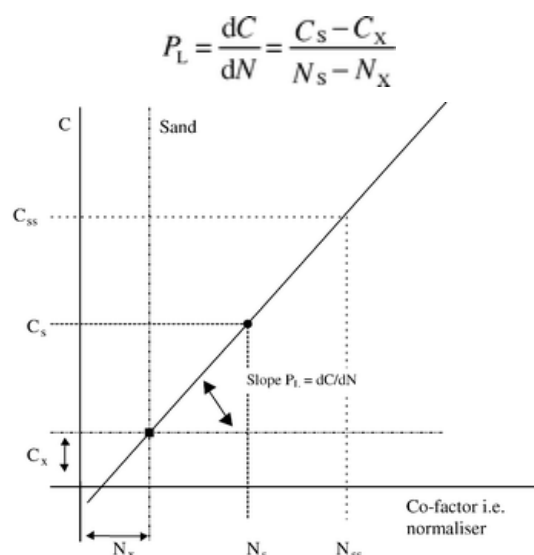

Figure 1. Contaminant content C_S and a co-factor content N_S (Kestern and Smedes, 2002, in OSPAR, 2018b²⁴⁰)

50. The slope of the regression represents the natural relationship between the metal and the co-factor (normalizer). Therefore, “regression lines drawn for samples from different areas may thus be used to compare their degree of contamination. The steeper the gradient, the more contaminated an area is considered to be Positive residuals that plot above this line indicate that the concentrations are greater than would be predicted from the contaminant/co-factor relationship, and may represent hot-spot samples” (Kestern and Smedes, 2002, in OSPAR 2018b).

51. Kestern and Smedes (2002) also underline that “the precision of the result strongly depends on the natural (or analytical) variability of N_X . For coarse-grained samples, a significant standard deviation in both the C_X coefficient and the slope may arise from propagation of the errors of the analytical variation due to the overall low concentrations. The C_X coefficient of the regression may differ significantly from site to site, in particular, when using coarser grain size fractions. For some areas, Al contents in the coarse fractions are found at the same level as in the fines, and therefore the intercept N_X becomes very high. This implies that the denominator is the result of subtracting two relatively large numbers, N_S and N_X . Consequently, due to their individual uncertainties, the result has an extreme error.” (OSPAR, 2018b). In MED POL IMAP, it has been decided to analyse the < 2 mm fraction of the sediment, therefore it is possible that N_S and N_X will be relatively high.

52. A similar approach to calculate the regression between metal and the normalizer is presented by Loring and Rantala (1992). Using data from the non-polluted (or reference) stations scatter plots of the regression lines between the metals and the normalizer (Al or Li) with 95% confidence bands are drawn. The regression line represents the natural variability of the metal concentrations in relation to the normalizer (Al or Li) content and the stations located within the confidence bands can be considered as non-polluted. On the other hand, stations located above the upper limit of the 95% confidence band may be considered as polluted.

53. A detailed discussion on normalization procedures can be found in OSPAR’s Technical Annex 5: Normalisation of contaminant concentrations in sediments (OSPAR, 2018b) (Annex VIII).

²⁴⁰ OSPAR (2018b). CEMP Guidelines for Monitoring Contaminants in Sediments. Technical Annex 5: Normalisation of contaminant concentrations in sediments.

54. The purpose of normalization is to reduce the variability between samples arising from differences in bulk sediment properties in order to draw conclusions on the level of metal contamination in a specific area, and/or to compare pollution levels between different areas. However, in some areas that the correlations between contaminant and cofactor concentrations may be weak or even absent. Therefore, normalization should be used taking into consideration its limitations and having a good knowledge of the characteristics of the sediments in the area under investigation.

3. Technical note for the analysis of organic contaminants in marine sediments

55. The mandatory organic contaminants to be analysed in sediments in the framework of IMAP are: Organochlorinated compounds (PCBs [28, 31, 52, 101, 105, 118, 138, 153, 156, 180], Hexachlorobenzene, Lindane and Σ DDTs) and polycyclic aromatic hydrocarbons (US EPA 16 individual PAHs congeners – Acenaphene, Acenaphthylene, Anthracene, Benz(a)anthracene, Benzo(b)fluoranthene, Benzo(k)fluoranthene, Benzo(a)pyrene, Benzo(ghi)perylene, Chrysene, Dibenzo(a,h)anthracene, Fluoranthene, Indeno(1,2,3-cd)pyrene, Naphthalene, Phenanthrene, Pyrene) (UNEP/MAP, 2019a; UNEP/MAP 2019b). However, Parties may decide to include in their national monitoring programmes the analysis of additional heavy organic compounds according to their national priorities.

56. Analysis of sediment samples for the determination of organic contaminants include: i) extraction; ii) concentration; iii) clean-up; iv) fractionation; and v) quantification of contaminants.

57. National laboratories may decide to use any validated analytical method they consider appropriate, which meets specific performance criteria (LOD, LOQ, precision, recovery and specificity). However, in order to assist analytical laboratories of Mediterranean Parties, a list of Protocols has been drafted to be used as guidelines for the analysis of organic compounds in marine sediment samples. Analytical laboratories should accommodate, test and modify each step of the procedures presented in the Protocols in order to validate their final results. The list of methods and analytical equipment is not exhaustive, and laboratories are encouraged to use their own equipment/methods that consider adequate for the required analyses.

58. The laboratory area used for organic trace analysis must be a dedicated facility, isolated from other projects that could be sources of contamination. It must be properly constructed with fume hoods and benches with electric sockets that are safe for use with flammable solvents. The laboratory must have extractors and rotary evaporators cooling water to run the stills. In tropical regions and in dry climates, a refrigerated re-circulating system should be used to reduce temperatures to the required levels and/or to conserve water. Stainless steel or ceramic tiles make good non-contaminating surfaces. If necessary, benches can be coated with a hard epoxy resin and walls can be painted with epoxy paint. A sheet of aluminium foil on the workbench provides a surface which can be cleaned with solvent. A vented storage facility for solvents is essential. Benches must be fitted with frames to hold stills, extractors, etc. The emergency cut-off switch should be accessible from both inside and outside the laboratory. Firefighting equipment should be mounted in obvious places and laboratory personnel trained in their use.

59. Calibration of equipment for the analysis of organic contaminants follows the same procedures as in the analysis of heavy metals (Technical Note 2). All reagents, including the distilled water should be of analytical quality. Commercially available solvents like acetone, acetonitrile, dichloromethane, hexane and pentane are invariably contaminated with ECD-active substances and their concentrations vary from batch to batch and with supplier. Powdered or crystalline reagents, such as anhydrous sodium sulphate (Na_2SO_4), potassium hydroxide (KOH), glass wool, must be extracted with hexane in a Soxhlet apparatus. Adsorbents, such as silica gel, alumina and Florisil have also to be solvent extracted. All glassware should be vigorously scrubbed with brushes in hot water and detergent and rinse five times with tap water and twice with distilled water. Then, glassware should be rinsed with

acetone or methanol followed by hexane or petroleum ether and baked overnight in an oven at 300 °C. All glassware should be stored in dust free cabinets and tightly sealed with pre-cleaned aluminium foil when not in use. Ideally glassware should be cleaned just before use. More information on cleaning reagents and glassware is provided in UNEP/IAEA (2011²⁴¹) (Annex IX.).

60. In the framework of this Technical note, this Guideline provides the following IMAP Protocols for the analysis of organic compounds in marine sediment samples:

- Protocol for the analysis of organochlorine pesticides and PCBs in sediment using Gas Chromatography-Electron Capture Detector (GC-ECD);
- Protocol for the analysis of organochlorine pesticides and PCBs in sediment using Gas Chromatography – Mass Spectrometry (GC-MS);
- Protocol for the analysis of PAHs in sediment using High Performance Liquid Chromatography - Fluorescence (HPLC-UVF);
- Protocol for the analysis of PAHs in sediment using GC-MS;
- Protocol for the normalization of organic contaminants concentrations in sediment using Total Organic Carbon (TOC).

61. These protocols are based on Analytical Methods developed by UNEP/IAEA (Annex IX: Sample work-up for the analysis of selected chlorinated hydrocarbons in the marine environment. Reference Methods for Marine Pollution Studies No 71; Annex XII:), HELCOM (Annex XI: Manual for marine monitoring COMBINE programme, Annex B-12, Appendix 2. Technical note on the determination of chlorinated biphenyls and organochlorine pesticides in marine sediment; Annex XIII: Manual for marine monitoring in the COMBINE programme, Annex B-12, Appendix 1. Technical Note on the determination of Polycyclic Aromatic Hydrocarbons in sediment) and ICES/OSPAR (Annex X: CEMP Guidelines for monitoring contaminants in sediments, Annex 2 Analysis of PCBs in sediments; Annex XV: CEMP Guidelines for monitoring contaminants in sediments, Annex 3: Determination of parent and alkylated PAHs in sediments).

3.1 Protocol for the analysis of organochlorine pesticides and PCBs in marine sediments using GC-ECD

The analysis of PCBs and organochlorine pesticides (OCPs) in sediment samples involves the extraction from the matrix with organic solvents, followed by clean-up and gas chromatographic separation with electron capture (GC-ECD) or mass spectrometric (GC-MS) detection. The samples can be extracted dry or wet. The extracts are then concentrated in a rotary evaporator to about 15 ml, and cleaned for the removal of lipids (whenever present at a significant amount) and the removal of elementary sulphur and sulphur compounds. Both these compound classes can interfere with the gas-chromatographic separation. An adsorption chromatography step (using Florisil columns) could be used to remove interfering lipids and to fractionate the extract into classes of compounds.

62. To minimize systematic errors due to insufficiently optimized gas chromatographic conditions, determinant losses (evaporation, unsatisfactory extraction yield), and/or contamination from laboratory ware, reagents and the laboratory environment, it is essential that the sources of systematic errors are identified and eliminated as far as possible (HELCOM, 2012c²⁴²). All reagents, including the distilled water should be of analytical quality. Commercially available solvents like acetone, acetonitrile, dichloromethane, hexane and pentane are invariably contaminated with ECD-active substances; their

²⁴¹ UNEP/IAEA (2011). Sample work-up for the analysis of selected chlorinated hydrocarbons in the marine environment. Reference Methods for Marine Pollution Studies No 71.

²⁴² HELCOM (2012c). Manual for marine monitoring in the COMBINE programme. Annex B-13 Technical note on the determination of heavy metals and persistent organic compounds in marine sediments. Appendix 2. Technical note on the determination of chlorinated biphenyls in marine sediment

concentrations vary from batch to batch and with supplier. Reagent quality should be checked by injection of 2 µl of a 100 ml batch of solvent, after concentration to 50 µl in a rotary evaporator. No peak in the GC-ECD chromatogram (90 – 250 °C) should be larger than that for 1pg of lindane. Otherwise, the solvent must be distilled.

63. Quantitative analysis with Electron Capture Detector (ECD) is performed by comparing the detector signal produced by the sample with that of defined standards. Due to incomplete separation, several co-eluting compounds can be present under a single detector signal, therefore, the shape and size of the signal have to be critically examined. The relative retention time and the signal size should be confirmed on columns with different polarity of their stationary phases, or by the use of multi-dimensional GC techniques. The GC should be calibrated before each batch of measurements. Since the ECD has a non-linear response curve, a multilevel calibration is strongly advised. For the purpose of determining recovery rates, an appropriate internal standard should be added to each sample at the beginning of the analytical procedure. The ideal internal standard is a PCB which is not present in the sample and which does not interfere with other PCBs. All 2,4,6-substituted PCB congeners are, in principle, suitable. Alternatively, 1,2,3,4-tetrachloronaphthalene or the homologues of dichloroalkylbenzylether can be used (HELCOM, 2012c).

64. For analysis, the samples are prepared for solvent extraction. To achieve a satisfactory recovery of the chlorinated hydrocarbons, samples are dried by either desiccation with anhydrous sodium sulphate or by freeze-drying. Lipids are then Soxhlet extracted from sediments using hexane and dichloromethane. Following initial clean-up treatments (removal of sulphur from sediment extracts), extracts are fractionated using column chromatography with an Electron Capture Detector (ECD). It is suggested, when using GC-ECD (and to a certain extent GC-MS), two columns with stationary phases of different polarity should be used, as column-specific co-elution of the target CBs with other CBs or organochlorine compounds occurs.

65. A protocol for the determination of organochlorine pesticides and polychlorinated biphenyls in sediment samples using CG-ECD prepared by UNEP/IAEA (2011) is presented in Annex IX. Similar analytical protocols using GC-ECD are also proposed by OSPAR (2018c²⁴³) (Annex X) and by HELCOM (2012c) (Annex XI).

3.2 Protocol for the analysis of organochlorine pesticides and PCBs in sediments using GC-MS

66. The analysis of PCBs and organochlorine pesticides (OCPs) in sediment samples involves a similar extraction from the matrix with polar and non-polar organic solvents, followed by clean-up and gas chromatographic separation with mass spectrometric (GC-MS) detection.

67. Quantitative analysis is performed by comparing the detector signal produced by the sample with that of defined standards, using a mass spectrometer (MS). Often, due to incomplete separation, several co-eluting compounds can be present under a single detector signal. Therefore, the shape and size of the signal have to be critically examined. With a MS detector, either the molecular mass or characteristic mass fragments should be recorded for that purpose. The GC should be calibrated before each batch of measurements. Since the MS has a non-linear response curve, a multilevel calibration is advised. For the purpose of determining recovery rates, an appropriate internal standard should be added to each sample at the beginning of the analytical procedure. The ideal internal standard is a PCB which is not present in the sample and which does not interfere with other PCBs. All 2,4,6-substituted

²⁴³ OSPAR (2018c) CEMP Guidelines for Monitoring Contaminants in Sediments. Technical Annex 2: technical annex on the analysis of PCBs in sediments.

PCB congeners are, in principle, suitable. Alternatively, 1,2,3,4-tetrachloronaphthalene or the homologues of dichloroalkylbenzylether can be used. For GC/MS, ¹³C-labelled PCBs should preferably be used as internal standards (HELCOM, 2012c).

68. A method for extraction, concentration, cleanup and fractionation for the determination of organochlorine pesticides and polychlorinated biphenyls in sediment samples is prepared by UNEP/IAEA (2011) (Annex IX.), including the list of reagents, the solvents, standards and examples for the preparation of the stock, intermediate and working solutions. All reagents, including the distilled water should be of analytical quality. Also, the analysis of PCBs and organochlorinated pesticides can be done by GC-ECD followed by confirmation using GC-MS.

69. Guidelines for the determination of organochlorine pesticides and polychlorinated biphenyls in sediment samples using CG-MS are also proposed by OSPAR (2018c) (Annex X) and by HELCOM (2012c) (Annex XI.).

3.3 Protocol for the analysis of PAHs in sediments using HPLC

70. PAHs in the marine environment may derive from combustion processes and from oil and oil products releases. Combustion PAHs are predominantly parent (unsubstituted) compounds, whereas oil and its products contain a much wider range of alkylated compounds in addition to the parent PAHs. This has implications for the analytical determination, as both HPLC-based and GC-based techniques are adequate for the determination of a limited range of parent PAHs in samples influenced by combustion processes, whereas in areas of significant oil contamination and following oil spills only GC-MS has sufficient selectivity to determine the full range of PAHs present.

71. For the analysis of sediments for PAHs, samples are defrosted and prepared for solvent extraction, which can be performed on wet or dried sediment. Wet sediment are Soxhlet extracted in two steps: first, using a polar solvent, such as acetone, to extract the water from the sediment, then the extraction continued with a less polar solvent or solvent mixture (e.g., acetone/hexane). Dry sediments can be Soxhlet extracted using medium-polar solvents such as dichloromethane or toluene, or mixtures of polar and non-polar solvents (OSPAR 2018d²⁴⁴ Annex XII, HELCOM 2012d²⁴⁵ Annex XIII).

72. Following extraction, the extract is concentrated and any polar solvents used in the extraction step are removed using a rotary evaporator to a volume of about 15 ml (the temperature of the water bath does not exceed 30 °C). The extract is dried with anhydrous sodium sulfate and transferred in a graduated tube and concentrated down to 4 to 5 ml using a flow of clean nitrogen. Then a clean-up is undertaken with purposes to remove of lipids, whenever present in significant amount; remove elementary sulphur and sulphur compounds. Both these compound classes can interfere with the gas-chromatographic separation. To remove polar interferences from the extract in view of using HPLC-UVF for subsequent analysis, a chromatographic procedures using disactivated aluminum oxide (10 % water) eluted with hexane as well as silica or modified silica columns can be used (HELCOM, 2012d)

73. Detailed methods for the extraction, clean-up and determination of parent PAHs using High Performance Liquid Chromatography – Fluorescence developed by OSPAR, 2018d) and HELCOM (2012d) are presented in Annex XII and Annex XIII, respectively.

²⁴⁴ OSPAR (2018d). CEMP Guidelines for monitoring contaminants in sediments. Technical Annex 3: Determination of parent and alkylated PAHs in sediments

²⁴⁵ HELCOM (2012d). Manual for marine monitoring in the COMBINE programme. Annex B-13, Appendix 1. Technical note on the determination of Polycyclic Aromatic Hydrocarbons (PAHs) in sediment

3.4 Protocol for the analysis of PAHs in sediments using GC-MS

74. For the analysis of sediments for PAHs using GC-MS the extraction, concentration and clean-up procedures are similar to the procedures described for the analysis with HPLC. Solvent extraction can be performed on wet or dried sediment. Wet sediment is Soxhlet extracted in two steps: first, using a polar solvent, such as acetone, to extract the water from the sediment, then the extraction continued with a less polar solvent or solvent mixture (e.g., acetone/hexane). Dry sediments can be Soxhlet extracted using medium-polar solvents such as dichloromethane or toluene, or mixtures of polar and non-polar solvents (OSPAR 2018d, HELCOM 2012d).

75. When the extraction is completed, the extract is evaporated with a rotary evaporator to a volume of about 15 ml (the temperature of the water bath does not exceed 30 °C). The extract is dried with anhydrous sodium sulfate and transferred in a graduated tube and concentrated down to 4 to 5 ml using a flow of clean nitrogen. For GC-MS analysis sulphur should be removed from the extracts in order to protect the detector. This can be achieved by the addition of copper powder, wire or gauze during or after organic solvent extraction. Ultrasonic treatment might improve the removal of sulphur (OSPAR 2018d, HELCOM, 2012d).

76. Detailed methods for the extraction, clean-up and determination of PAHs using GC - MS developed by (OSPAR, 2018d) and HELCOM (2012d) are presented in Annex XII and Annex XIII respectively.

3.5 Protocol for the normalization of organic contaminants using Total Organic Carbon (TOC)

77. Normalisation is defined as a procedure to adjust contaminant concentrations for the influence of the natural variability in sediment composition, grain size, organic matter and mineralogy. Most natural and anthropogenic substances, metals and organic contaminants, show a much higher affinity to fine particulate matter compared to the coarse fraction. Grain size and organic matter are important factors controlling the distribution of natural and anthropogenic components in sediments. Therefore, normalizing contaminant's data for the effects of grain size or organic carbon is used to allow meaningful comparisons of the occurrence of substances in sediments of variable bulk properties (OSPAR, 2018b).

78. In the European Commission's Guidance Document No: 25 on chemical monitoring of sediment and biota under the Water Framework Directive (EC, 2010²⁴⁶), is mentioned that organic contaminants in sediment can be normalized using the total organic carbon (TOC) concentration, because organic matter coatings of fine particles is more effective in bounding lipophilic substances such as chlorinated compounds and PAHs. It is suggested that usually coarser (sand) sediments are less important carriers of lipophilic substances because of their smaller relative surface area. Therefore, it is possible to use the ratio of [concentration of the organic compound]/[TOC] as a normalised value.

79. In many cases the mobility and partitioning of organic contaminants in the environment can be predicted based on their partitioning into the bulk organic carbon in the sediment, which may be presented using different normalizers (Total Organic Carbon - TOC; Elemental Organic Carbon - EOC; particulate organic carbon - POC; loss-on-ignition - LOI). However, Kestern and Smedes (2002) underline that because organic contaminants may enter the marine environment via different pathways,

²⁴⁶ EC (2010). Guidance Document No: 25 Guidance on chemical monitoring of sediment and biota under the Water Framework Directive

“the key issue for normalization is thus proper characterization of the Organic Matter by as many parameters as possible. The types of information that can be obtained by the utilization of at least the few key parameters are often complementary and extremely useful, considering the complexity and diversity of Organic Matter encountered in the sediment environment.” They also note that “Due to its variability, Organic Matter will occur in both the fine and the coarse sediment fraction. Unlike Al in the case of metals, some Organic Matter in the coarse fraction may contribute to the affinity for organic contaminants as a co-factor as well, albeit of limited environmental significance.”

80. Therefore, the use of TOC as a normalizing factor should be used cautiously and only if field data support the usefulness of normalizing organic contaminants concentrations, as the means to enhance environmental information for pollution assessment. Normalization to TOC is not a mandatory information to be reported to UNEP/MAP and is up to country to decide if it will be done. However, Parties are encouraged to analyse TOC in sediments as an additional information, which could be used in better understanding of the pollution processes in the areas under investigation in the framework of IMAP.

a) TOC analysis with Carbon Analyser

81. Total Carbon (inorganic and organic) in sediments can be determined with a Carbon Analyser. The sample is injected into a heated reaction chamber packed with an oxidative catalyst ($\text{Pt}/\text{Al}_2\text{O}_3$) the water is vaporized and both organic and inorganic carbon are oxidized to CO_2 , which is measured by means of an Infrared (IR) analyser. Then the inorganic carbon is measured separately, by acidifying the sediment sample with HCl acid at $\text{pH} < 3$ and all carbonates are transformed to CO_2 measured in the IR analyser. TOC can be calculated as the difference Total Carbon – Inorganic Carbon. Alternatively, inorganic carbonates are converted to CO_2 with acid, which is removed by purging before the sample injection. The remaining sample contains only the organic carbon fraction of total carbon, which is measured in the IR analyser.

b) TOC analysis with wet oxidation

82. The wet oxidation technique is the complete oxidation of organic carbon using $\text{K}_2\text{Cr}_2\text{O}_7$ and concentrated H_2SO_4 and the titration of excess dichromate with 0.5N ferrous ammonium sulphate solution to a sharp one drop end point (Schumacher, 2002²⁴⁷). The method is based on the Walkley and Black (1934²⁴⁸) protocol as modified and described by Nelson and Sommers (1996²⁴⁹).

83. 0.5 g of dried sediment is placed in a 500 ml Erlenmeyer flask and 10 ml of 1 N $\text{K}_2\text{Cr}_2\text{O}_7$ solution and 20 ml of concentrated H_2SO_4 are added and mixed for 20 min. The mixture is diluted to 200 ml volume with distilled water and 10 ml of 85% H_3PO_4 , 0.2 g NaF and 15 drops of diphenylamine indicator. The solution is back titrated with 0.5 N ferrous solution.

²⁴⁷ Schumacher, B.A (2002). Methods for the determination of Total Organic Carbon (TOC) in soils and sediments. EPA/600/R-02/069

²⁴⁸ Walkley, A. and Black, I. A. (1934). An examination of the Degtjareff method for determining soil organic matter and a proposed modification of the chromic acid titration method. *Soil Science*, 37: 29-38

²⁴⁹ Nelson, D.W and Sommers, L.E. (1996). *Methods of Soil Analysis. Part 3. Chemical Methods*. Soil Science Society of America Book Series no.5, pp. 961-1010.

Appendix 17
Report

Recommended Method on
MICROWAVE DIGESTION OF MARINE SAMPLES FOR
THE DETERMINATION
OF TRACE ELEMENT CONTENT



REPORT

Recommended Method on MICROWAVE DIGESTION OF MARINE SAMPLES FOR THE DETERMINATION OF TRACE ELEMENT CONTENT

IAEA/NAEL

**Marine Environmental Studies Laboratory in co-operation with
UNEP/MAP MED POL**

November 2011

For further information on this method, please contact:

IAEA-Environment Laboratories
Marine Environmental Studies Laboratory
4a Quai Antoine 1er
MC-98000 Principality of Monaco

Tel. (377) 979 772 72 Fax. (377) 979 772 73

E-mail: NAEL-MESL.Contact-Point@iaea.org

Recommended Method on
MICROWAVE DIGESTION OF MARINE SAMPLES
FOR THE DETERMINATION OF TRACE ELEMENT CONTENT

DISCLAIMER

This is not an official IAEA publication. The views expressed do not necessarily reflect those of the International Atomic Energy Agency or its Member States.

The material has not undergone an official review by the IAEA. This document should not be quoted or listed as a reference.

The use of particular designations of countries or territories does not imply any judgment by the IAEA, as to the legal status of such countries or territories, of their authorities and institutions or of the delimitation of their boundaries.

The mention of names of specific companies or products (whether or not indicated as registered) does not imply any intention to infringe proprietary rights, nor should it be construed as an endorsement or recommendation on the part of the IAEA.

Limited Distribution

Reproduced by the IAEA

TABLE OF CONTENTS

1. SCOPE	1
2. PRINCIPLE	1
3. SAMPLE PRE-TREATMENT	1
4. REAGENTS	1
5. MATERIAL	2
6. PROCEDURE	2
7. QUALITY CONTROL	5
8. REFERENCES	5

NOTE: This method is not intended to be an analytical training manual. Therefore, the method is written with the assumption that it will be performed by formally trained analytical chemist. Several stages of this procedure are potentially hazardous, especially stages with HF; users should be familiar with the necessary safety precautions.

In addition, the IAEA's recommended methods are intended to be guidance methods that can be used by laboratories as a starting point for generating their own standard operating procedure. If performance data are included in the method, they shall not be used as absolute QC acceptance criteria.

1. SCOPE

The method here below describes the protocol for dissolution of samples from marine origin. Digests are suitable for analyses of total content of trace element in sediment and biological material.

The goal of this method is the total sample decomposition with the judicious choice of acid combinations this is achievable for most matrices. The selection of reagents which give the highest recoveries for the target analytes is considered the optimum method condition.

The recommended protocol is mainly based on the EPA 3052 method; users are encouraged to consult this document (EPA, 1996).

2. PRINCIPLE

The grinded and dried samples are solubilized in an acid mixture using microwave oven apparatus.

The use of hydrofluoric acid allows the decomposition of silicates by reaction of F with Si to form the volatile SiF₄. The excess of hydrofluoric acid is either neutralized by boric acid, or digests are evaporated to dryness depending on the method used to analyze samples.

3. SAMPLE PRE-TREATMENT

Sediment samples are prepared following the recommendations of UNEP (2005).

Marine organisms are prepared following the recommendations of UNEP (1984, 1994).

4. REAGENTS

The reagents used shall meet the purity requirement of the subsequent analyses

- 4.1. ULTRAPUR WATER (type MilliQ).
- 4.2. NITRIC ACID 65%.
- 4.3. HYDROFLUORIC ACID.
- 4.4. HYDROCHLORIC ACID.
- 4.5. BORIC ACID.
- 4.6. HYDROGEN PEROXIDE.

5. MATERIAL

5.1. MICROWAVE APPARATUS

The microwave decomposition system should be temperature controlled. The temperature sensor should be accurate at $\pm 2.5^{\circ}\text{C}$. The calibration of the temperature sensor should be done at least once a year, preferably by the maintenance service of the manufacturer.

The microwave unit should be corrosion resistant.

The unit cavity should be well ventilated and connected to fume cleaner or special neutralizing system.

The method requires microwave transparent and acid resistant material (i.e. PFA, TFM) to be used as reactor. The minimal volume of the vessels should be 45 ml and it should be able to work under the pressure of 800PSI. the reactor system should be equipped with a pressure relief system.

- 5.2. ANALYTICAL BALANCE with 0.001 g precision at least.
- 5.3. FUME HOOD.
- 5.4. LAMINAR FLOW HOOD.
- 5.5. VOLUMETRIC CONTAINERS of 50 ml or 100 ml in polypropylene.
- 5.6. WEIGHING CUP in polyethylene.
- 5.7. PLASTIC SPATULAS.

6. PROCEDURE

- 6.1. All PLASTIC MATERIAL (i.e. volumetric, weighing cup...) should be acid cleaned by soaking in laboratory soap (or 10% alcohol) for at least 24h, followed by 24h of soaking in 10% nitric acid. Stronger acid cleaning protocol could be applied depending on the requirement of the subsequent analyses.
- 6.2. MICROWAVE VESSELS should be at least cleaned after each use by running the same microwave program used for samples with 5 ml of HNO_3 . If the risk of cross contamination is high (i.e. running sandy sediment after organic rich sediment) and/or in the case of long storage, the vessels should be cleaned twice. If available, an acid cleaner

(using acid vapors) can be used as a final cleaning stage. After cleaning, the vessels should be carefully rinsed with water and dried under a laminar flow hood. If a laminar flow hood is not available, vessels should be kept locked in double plastic bag; date of storage should be mentioned on the second bag.

6.3. Accurately weigh 0.1 to 0.5 g of well mixed sample in the microwave vessel.

6.4. In a fume hood, add 5 ml of nitric acid and 2 ml of hydrofluoric acid, close vessels with caps, then it is recommended to let samples react for at least 1 hour (or more if possible). Protect vessels by covering them with plastic bags or place them in a laminar flow hood compatible with acid fume. The quantity of hydrofluoric acid depends on the expected content of silicon dioxide, samples with low concentrations of silicon dioxide (< 10% like plant material to 0% like biological sample) may require less hydrofluoric acid (0.5 ml to 0 ml). Examples of acid quantities for different matrix are listed in table below.

	HF (ml)	HNO ₃ (ml)	HCl (ml)	H ₂ O ₂ (ml)	Boric (g)
Sediment	2	5	2 or 0	2	0.8
Fish	0	5	2 or 0	2	0
Sea plant	0.5	5	2 or 0	2	0

6.5. After room temperature pre-digestion, add 2 ml of hydrogen peroxide and close the reactors as recommended by the microwave manufacturer.

NOTE: The quantity and ratio of reagent can be adapted on a performance based judgment (i.e. visual total digestion, certified reference material results).

- In case of a sample containing high calcium carbonate, the hydrofluoric acid content can be set to 0 to avoid precipitation of insoluble CaF.
- A two stage digestion, using half of the hydrofluoric acid at the first stage and half at the second, could increase recovery and help achieving total decomposition.
- Additional reagent can be added depending on the sample composition to achieve complete dissolution. For example, 2±2 ml of HCl can be added to help the stabilization of As, Sb, Hg, Fe and Al at high level; however HCl might increase analytical difficulties for some techniques (i.e. ICP-MS) (Kingston 1997)
- Only one acid mixture or quantity should be used in a single batch, in the microwave, to insure consistent reaction conditions between all vessels and monitored conditions. This limitation is due to the current practice of monitoring a representative vessel, and applying a uniform microwave field to reproduce these reaction conditions within a group of vessels being simultaneously heated.

6.6. Place the closed reactor in the microwave apparatus, connect temperature and pressure control as specified by the manufacturer. The samples should be heated at 180°C

(minimum) in about 6 minutes and the temperature maintained for at least 10 minutes. The total decomposition is primarily controlled by maintaining samples at 180°C for 10 minutes. The ramping profile can be adapted, especially for safety purpose when very reactive samples are decomposed (i.e. biological material). In that case, it is recommended to increase the ramping time to 10 or 15 minutes. If possible, record temperature and pressure profile. In most samples matrices, pressure should peak between 5 and 15 minutes; profiles can be used to optimize temperature program.

- 6.7. At the end of the temperature profile, let the sample cool until the inside temperature goes down to 60°C, then remove the reactors from the microwave and place them in a ventilated fume hood. The pressure is carefully released following the manufacturer's instruction and reactors are opened.
- 6.8. In the case of removal of hydrofluoric acid excess with boric acid, 0.8 g of boric acid and 15 ml of water are added in the vessel. The quantity of boric acid is proportional to the quantity of hydrofluoric acid (usually 0.4 g for 1 ml should be sufficient). The vessels are closed again and run in the microwave with a program that heat samples at 170°C in 10 minutes and maintain this temperature for 10 minutes.
- 6.9. At the end of the temperature profile, let the sample cool until inside the temperature goes down to 60°C, then remove the reactors from the microwave and place them in a ventilated fume hood. The pressure is carefully released following the manufacturer's instruction and reactors are opened. Transfer the samples in a volumetric container and dilute them to a known volume (or a known weight, this requires to record the tare of each container before).

NOTE: An excess of boric acid will produce cloudy solutions, this might cause problem with sample introduction system of ICP. The use of boric acid will prevent measurement of boron, and possible bias introduced should be carefully investigated.

- If the use of boric acid is not possible, or if it is necessary to reduce the concentration of acid in final solutions, digest can be evaporated to incipient dryness on a hot plate at about 140°C. This stage should be performed in a controlled environment to avoid contamination and acid vapour should be treated. Some microwave oven apparatus can perform evaporation. The residue is then diluted to a known volume in nitric or hydrochloric diluted solution (usually 2% v/v) depending on the subsequent analytical method used.
- In case of insoluble precipitate or residue some extra steps can be performed like the addition of 2 ml of perchloric acid to the solution before evaporation, but this requires doing the evaporation under a specific hood for safety reason. Another option is the addition of 2 ml of concentrated hydrochloric acid, evaporation to near dryness, addition of concentrated nitric acid, evaporation to near dryness and dilution in known volume in 2% nitric acid solution.

Most samples will be totally dissolved by this method with the judicious choice of the acid combinations. A few refractory sample matrix compounds, such as TiO₂, alumina, and other oxides may not be totally dissolved, and in some cases may sequester target analyte elements.

7. QUALITY CONTROL

- 7.1. Each microwave batch should contain at the minimum one certified reference material of representative matrix.
- 7.2. A duplicate or triplicate sample should be processed on a routine basis. A duplicate sample should be processed with each analytical batch or every 10 samples. A duplicate sample should be prepared for each matrix type (i.e. sediment, sea plant, etc.).
- 7.3. A spiked sample should also be included whenever a new sample matrix is being analyzed, especially if no certified reference material is available for that matrix.
- 7.4. Blank samples should be prepared using the same reagents and quantities used in sample preparation, placed in vessels of the same type, and processed with the samples. Each microwave batch should contain at least two blank samples.

8. REFERENCES

EPA (1996) U.S. Environmental Protection Agency, EPA method 3052, Microwave assisted acid digestion of siliceous and organically based matrices Rev 0, December 2007, (<http://www.epa.gov/osw/hazard/testmethods/sw846/pdfs/3052.pdf>).

Kingston, H. M., Haswell, S (1997), Microwave Enhanced Chemistry, ACS Professional Reference.

Book Series; American Chemical Society: Washington, DC, 1997.

UNEP (2005), UNEP (DEC)/MED WG.282/inf.5/Rev1, Method for sediment sampling and analysis, February 2005, UNEP.

UNEP/IOC/IAEA (1984) reference method 7 rev2: Sampling of selected marine organisms and sample preparation for trace metal.

UNEP/IOC/IAEA (1994) reference method 57: Quality assurance and good laboratory practice, UNEP, 1994.

Annex II:

OSPAR COMMISSION

**CEMP Guidelines for Monitoring Contaminants in Sediments
(OSPAR Agreement 2002-16)**

**Technical Annex 6: Determination of metals in sediments –
Analytical methods**



CEMP Guidelines for Monitoring Contaminants in Sediments

(OSPAR Agreement 2002-16)

Technical Annex 6: Determination of metals in sediments – analytical methods

1. Introduction

This technical annex provides advice on the determination of metals (including metalloids and some non-metals like Se) in whole sediment and in sieved fractions. Determinations of trace metals can be achieved by acid digestion of the sediment followed by analysis of the digest solution by spectroscopic or spectrometric methods, or non-destructive techniques such as X-ray fluorescence analysis (XRF), instrumental neutron activation analysis (INAA) etc. The guidelines are intended to assist analytical chemists both in starting up metals analyses in sediments, and to those already performing such analyses. They do not provide full detail on specific laboratory procedures. Further guidance may be sought from specialised laboratories and publications (e.g. Loring and Rantala., 1991; Popek, 2003) or general guidance for selection of analytical methods (e.g. Larsen et al., 2011). Analyses should be carried out by experienced staff and the procedure validated.

Trace metals may occur in both fine and sand fractions of sediments. However, most natural and anthropogenic substances (metals and organic contaminants) show a much higher affinity to fine particulate matter than the coarse fraction. Iron and manganese oxy-hydroxide coatings, and constituents such as organic matter and clay minerals, contribute to the affinity for contaminants for this fine material.

Total methods, such as procedures involving total dissolution of sediment samples with hydrofluoric acid (HF) prior to analysis, or non-destructive methods without digestion such as neutron activation analysis (INAA) and X-ray fluorescence analysis, determine total trace metal contents in the whole sediment sample. In contrast, methods using a partial digestion with only strong acids, e.g. nitric acid or aqua regia, mainly measure trace metals in the fine fraction, and only extract small amounts of trace metals from the coarse fraction. For fine material, similar results have been obtained using both total and strong partial methods (Smedes et al, 2000; QUASH/QUASIMEME intercalibrations).

2. Sampling, pre-treatment and storage

Sampling sediments for metals analysis should preferably be done using cleaned plastic equipment, but this may not always be possible (e.g. at sea). Where metal sampling gear such as grabs must be used, care must be taken to avoid contamination of the sample, for instance by sub-sampling only sediment that has had no contact with the walls of the sampling device (maintain at least 1cm distance from sides). Sample thickness should be chosen according to the monitoring proposes.

For ordinary surveys, the upper 2 cm of the sediment are sampled, but for other purposes like retrospective surveys, core samples can be taken. If knowledge exists about about the sedimentation rate, the sampling strategy can be based on this (e.g. Wadden Sea sampling of the upper 1 mm).

Sediments can be stored in closed plastic or glass containers. Samples must be sieved at 2 mm as soon as possible after sampling to remove large debris as well as large detritus and benthic organisms.

Otherwise during further sample handling like storage, freezing or ultrasonic treatment, biotic material will deteriorate and become part of the sediment sample. Samples may then be further wet sieved to a smaller size fraction. Further details on sieving procedures are available in the Technical Annex 5: Normalisation of Contaminant Concentrations in Sediments.

For total analysis, metals are usually not very sensitive with regard to storage conditions, so other measured parameters may determine how to store the samples. For total analysis of metals the sample can be stored at 4°C for a few weeks and for extended periods when frozen at –20°C, although direct wet sieving is preferred. For prolonged storage freeze-drying of samples can be considered. In this case contamination and losses of contaminants during freeze-drying have to be checked, in particular for volatile parameters (e.g. volatile organics) to be analysed in the same samples. Air-drying is not appropriate due to high contamination risks. Besides, samples may be difficult to disaggregate and mineral structures may be affected.

Once sieved and dried, samples should be homogenised and ground to a fine powder in a non-contaminating mill (e.g. made of agate or silicon nitride), and stored in plastic or glass containers until analysis.

3. Blanks and contamination

Any contact between the samples and metals should be avoided. If metallic implements are required during sampling (e.g. grab jaws), they should be of stainless steel and contact between the sub-sample and metal should be minimised.

Plastic and glassware should be cleaned using a laboratory washing machine incorporating an acid wash, or by an equivalent cleaning procedure. Some plastic ware may not need to be cleaned before first use for metals work, but this feature must be thoroughly examined (e.g. using acid leaching tests) before proceeding with any real samples.

Blanks should be taken through the whole procedure. In practice, this will generally represent the time from acid addition to a sample container through to the final measurement. There should be at least one analytical blank in a batch of 10-20 samples, representing 5-10% of the sample number.

For core-samples, care should be taken not to contaminate lower samples with upper samples in the process of cutting up the sediment core.

4. Digestion

4.1 Hydrofluoric acid digestion

HF digestions should be performed in polytetrafluorethylene (PTFE or PFA) vessels or equal quality, since the vessel must be metal-free and resist attack by the acid itself. Dried samples (normally 0.2-1g) should be accurately weighed into the vessel. Under fume extraction, the acid(s) are added. Some workers add HF first and leave the mixture to stand overnight, others add HF and nitric acid; others use a perchloric acid mixture etc. In general, the mixtures are left to stand for a period (1 hour – overnight) to avoid problems with violent reactions, which may be prompted by the presence of organic matter in the sediment. Note that perchloric acid and organic matter can promote an explosive reaction, so this acid must be treated with great caution if applied to sediments. Specially designed fume hoods should be used for HF and perchloric acid treatments.

HF is corrosive and toxic. It is therefore necessary to either remove the acid or render it less harmful to the measurement instruments. The acid may either be boiled off, which requires specialised facilities to extract the toxic fumes, or neutralised with boric acid (H_3BO_3), which is itself toxic.

Samples may be digested in a programmable heating block, with HF removal by evaporation. Alternatively, microwave digestions provide a rapid way to digest sediments. Some systems may allow the evaporation of HF, but in general microwaves use closed systems which allow pressure and temperature effects to rapidly dissolve the sediment. The most common methods use polytetrafluoroethylene (PTFE or PFA) lined and sealed digestion vessels (Nakashima *et al* 1988; Loring and Rantala, 1990). Since these closed systems retain the HF, boric acid is added after the HF digestion to complex remaining HF and make the resulting solution less hazardous, as well as preventing aluminium fluoride precipitation. The solution should be made up to volume with ultra pure water and left to stand for at least 24 hours prior to analysis to precipitate excess boric acid. Others use adjusted amounts of boric acid and heat the digest to accelerate the process (Maham *et al* 1987). Typical methods are described, for example, in Cook *et al* (1997), Jones and Laslett (1994), Wu *et al.* (1996), Quelle *et al.* (2011).

If HF is to be removed by evaporation, care should be taken to ensure that mercury is not lost from sample solutions (Delft and Vos, 1988). It can be difficult to avoid mercury contamination with total digestion, but usually mercury is not bound strongly, so mercury can alternatively be analysed using strong acid digestion or by direct analysis (Taylor *et al.*, 2012).

4.2 Strong acid digestion

Partial digestions follow broadly similar procedures to HF digestions, as above, for example using HNO_3 or aqua regia and deionised water to ca. 0.5 g sample.. Microwave digestion is the preferred technique but alternative methods applying high pressure and temperature can be used. The method used needs to be checked. Adequate performance is achieved when digestion dissolves all the Al and Li from the clay fraction. It can easily be tested whether a method meets this requirement through parallel analyses of very fine grained samples by the partial method in use and a total method e.g. HF. If results for Al and Li do not differ significantly, the partial method used is sufficiently strong. To optimise the tests and to further normalise results, sieving to 20 or 63 μm grain size can be used, also reducing problems with detection limits in sandy sediments. A more general discussion on normalization can be found in the Technical Annex 5: Normalisation of Contaminant Concentrations in Sediments.

If the partial method results in lower contents than the total method, the conditions for the partial digestion such as time, temperature, acid concentration etc. need to be adjusted. Usually boiling with aqua regia is insufficient for a complete dissolution of Al. Historically, aqua regia has been used for strong acid digestions, but hydrochloric acid produces interferences for multi-element analysis by ICP and Cd in graphite furnace, so concentrated nitric acid alone may be used as a substitute (Christensen *et al.*, 1982; Krungalz and Fainshtein, 1989; Koopmann and Prange, 1991). However, collision or reaction cell technology in ICP-MS can be used to reduce the interfering effect of chloride and other multi-element interferences, down to levels of <1% mass overlap for double charged or multi-element species, thus minimising correction formulas for standard mass-corrections.

5. Analysis and detection

Analysis of metals in solution resulting from digestion may be performed by a variety of means, but usually involve spectrometric or spectroscopic detection. Flame or graphite furnace atomic absorption spectroscopy used to be the major method used for analysis of metals (Welz, 1985). Alternatively, non-destructive methods, i.e. XRF (e.g. Jenkins, 1999; Potts, 1992; Williams, 1987; Bertin, 1984) and INAA (Alfassi, 1998), which do not require a preceding digestion step, can be used. Multielement

techniques like inductively coupled plasma attached to either an emission spectrometer (ICP-AES) or mass spectrometer (ICP-MS) allow much more rapid analysis of a wide range of metals (Kimbrough and Lauenstein, 2006; Duzgoren- Aydin et al., 2011; Castillo et al., 2012).

Interferences in analysis may arise through the presence of other components in the sample. Use of 3-point standard additions may highlight where these occur and can be used to correct for suppression or enhancement effects. Interferences occurring with multi-element analytical techniques can be complex and require skilled personnel to identify and minimise such effects (Cook *et al*, 1997).

Mercury can be detected by fluorescence spectrometry or cold vapour atomic absorption spectrometry. Direct methods for analysing mercury use pyrolysis combined with a gold trap and fluorescence or atomic absorption detection are sensitive enough to measure sediments directly (Maggi et al., 2009; Kelly et al., 2012). ICP-MS is also sufficiently sensitive to measure Hg, but care should be taken about controlling carry over memory effects. It should be ensured that the limits of detection of the analytical technique selected meets the requirements of the respective monitoring programme. Typical detection limits using different methods are given in Table 1.

Table 1: Typical limits of detection for the determination of trace metals with different techniques (in mg/kg d.w.) based on typical sample intakes (0.5 – 1 g)

	Al	Li	As	Cd	Cr	Cu	Hg	Ni	Pb	Zn
AAS / flame	5	0.2		0.5	5	2		5	5	10
AAS / graphite furnace, hydride technique, cold vapour	<1	<1-	0.2	0.02	<1	<1	0.05	<1	<1	-
ICP – AES with hydride generation	10	10	10 1	0.5	1	1	-	2	5	1
ICP – MS	40	0.1	1	0.01	0.2	0.1	0.05	0.2	0.2	2
X-ray fluorescence analysis (XRF)	1000	-	-	-	10	10	-	10	10	20
Neutron activation analysis (INAA)	-	-	0.3	1	0.8	-	0.1	-	-	2
Fluorescence, AAS spectrometry (direct or cold vapour/hydride generation)	-	-	0.2	-	-	-	0.00 5	-	-	-
Direct Mercury Analyzer (AA)							0.00 5			

6. Metal speciation

Several methods are in use to examine metal speciation in sediments, mainly by use of sequential extraction (e.g. Gleyzes et al., 2002; Scouller et al., 2006; Sutherland, 2010; Duzgoren-Aydin et al., 2011), but currently also by passive samplers (for metals primarily DGTs) in porewater (Peijnenburg et al., 2014).

7. Limits of detection

The limit of detection for each metal is normally determined by analysing a blank solution (containing acid to the dilution it is present in the sample) at least ten times. The limit of detection is calculated from 3 times the standard deviation of the blank taken through the whole procedure. For typical limits of detection, see Table 1.

8. Calibration and standards

Calibrations are usually performed using multi-element stock solutions, using at least a 4-point calibration covering the range of concentrations expected. Multi-element solutions are commercially available, and may be used provided that they are of a similar matrix to the analyte. A crosscheck solution from a separate batch, or from a different supplier or an internal reference standard, should be used to check the calibration. Differences should not exceed 5%.

For non-destructive methods, appropriate certified reference sediments are required for calibration purposes.

9. Quality assurance

Every determinand should have its own Quality Control and Quality Assessment (QC – QA) scheme that includes regular blanks and calibration checks, the use of internal reference materials and certified reference materials and quality control charts. A system suitability check should be included in each batch to confirm that measuring instrument is operating correctly. In each batch of samples at least one standard addition (from the start of the digestion) should be included to demonstrate that matrix effects do not occur, and also a duplicate sample analysed in a different batch.

At least one laboratory reference material should be included in each batch of samples in order to check the long-term performance. A quality control Shewhart chart should be constructed for selected trace metals. If the warning limits are exceeded, the method should be checked for possible errors. When alarm limits are exceeded, the results should not be reported.

Certified reference materials (CRMs) for sediments are commercially available for both total methods and partial digestion methods. The data provided by such materials provide an independent check on the analytical performance. Table 2 contains information on certified reference materials available for use in marine monitoring.

Table 2: Certified Reference Materials for metals in marine sediments.

Code	Organization	Matrix
BCR 277R	IRMM ¹	Estuarine sediment
BCR 320R	IRMM	Channel sediment
BCR CC580	IRMM	Estuarine sediment (only Hg and CH ₃ Hg)
BCR 667	IRMM	Estuarine sediment
HISS-1	NRC ²	Marine sediment
MESS-3	NRC	Marine sediment
PACS-2	NRC	Marine sediment (Harbour)
SRM 1646a	NIST ³	Estuarine sediment
SRM 1944	NIST	Marine sediment
SRM 2702	NIST	Marine sediment

¹IRMM: Institute for Reference Materials and Measurements (Europe)

²NRC: National Research Council (Canada)

³NIST: The National Institute of Standards and Technology (USA)

Participation in an international proficiency-testing scheme e.g. QUASIMEME is highly recommended to improve comparability between laboratories. Relevant quality assurance data should be reported e.g. to ICES, together with concentration data.

10 References

Alfassi ZB (1998) Instrumental multi-element chemical analysis. Kluwer Academic Publishers. Bertin EP (1984) Principles and practice of X-ray spectrometric analysis. Plenum Press. Christensen TH, Pedersen LR, Tjell JC (1982) Comparison of four methods for digestion of sewage sludge samples for the analysis of metals by atomic absorption spectrophotometry. Intern. J. Environ. Anal. Chem., 12, 41-50.

Castillo MLA, de Torres AG, Alonso EV, Cordero MTS, Pavon JMC (2012) Multi-element determination of Pt, Pd and Ir traces in environmental samples by ICP-MS after preconcentration. Talanta, 99, 853-858.

Cook JM, Robinson JJ, Chenery SR, Miles DL (1997). Determining cadmium in marine sediments by inductively coupled plasma mass spectrometry: attacking the problems or the problems with the attack? *Analyst*, 122, 1207-1210

Delft Wv, Vos G (1988) Comparison of digestion procedures for the determination of mercury in soils by cold-vapor atomic absorption spectrometry. *Analytica Chimica Acta*, 209, 147-156.

Duzgoren-Aydin NS, Avula B, Willett KL, Khan IA (2011) Determination of total and partially extractable solid-bound element concentrations using collision/reaction cell inductively coupled plasma-mass spectrometry and their significance in environmental studies. *Environmental Monitoring Assessment*, 172 (1-4), 51–66.

Gleyzes C, Tellier S, Astruc M (2002). Fractionation studies of trace elements in contaminated soils and sediment: a review of sequential extraction procedures. *Trends in Analytical Chemistry*, 21, 451-467.

Jones BR, Laslett RE (1994). Methods for analysis of trace metals in marine and other samples. DFR Lowestoft. AEP Analytical methods no. 11 pp29 ISSN 0953-4466.

Jenkins R (1999). X-ray fluorescence spectrometry, 2nd ed. John Wiley and Sons.

Kelly JG, Han FX, Su Y, Xia Y, Philips V, Shi Z, Monts DL, Pichardo ST, Xia K (2012) Rapid Determination of Mercury in Contaminated Soil and Plant Samples Using Portable Mercury Direct Analyzer without Sample Preparation, a Comparative Study. *Water Air Soil Pollut.*, 223, 2361–2371.

Kimbrough KL, Lauenstein GG (Editors) (2006) Major and Trace Element Analytical Methods of the National Status and Trends Program: 2000-2006. Silver Spring, MD. NOAA Technical Memorandum NOS NCCOS 29, 19 pp.

Koopmann C, Prange A (1991) Multielement determination in sediments from the German Wadden Sea – investigations on sample preparation techniques. *Spectrochimica Acta*, 46B, 1395-1402.

Krumgalz B, Fainshtein G (1989) Trace metal contents in certified reference sediments determined by nitric acid digestion and atomic absorption spectrometry. *Analytica Chimica Acta*, 218, 335-340.

Larsen MM, Søndergaard J, Asmund G, Parmentier K, Vermaercke P (2011) Trace Elements. In: Philippe Quevauviller PR, Gert Verreert, editors. *Chemical Marine Monitoring: Policy Framework and Analytical Trends*. 10. John Wiley and Sons Ltd., West Sussex, 2011, pp. 71-100.

Loring DH, Rantala RT (1990) Sediments and suspended particulate matter: Total and partial methods of digestion. *ICES Techniques in Marine Environmental Sciences*, No. 9, 14pp.

Loring DH, Rantala RTT (1991) Manual for the geochemical analyses of marine sediments and suspended particulate matter. *Earth-Science Review*, 32: 235:283. Elsevier Science Publishers B.V. Maggi C, Berducci MT, Bianchi J, Giani M, Campanella L (2009) Methylmercury determination in marine sediment and organisms by Direct Mercury Analyser. *Analytica Chimica Acta*, 641, 32-36.

Mahan IK, Foderaro TA, Garza TL, Marinez RM, Maoney GA, Trivisonno MR, Willging EM (1987) Microwave digestion techniques in the sequential extraction of Calcium, Iron, Manganese, Lead, and Zinc in sediments; *Anal. Chem*, 59, 938-945.

Nakashima S, Sturgeon RE, Willie SN, Berman SS (1988) Acid digestion of Marine samples for trace element analysis using microwave heating. *Analyst*, 113, 159-163.

Parsons C, Grabulosa EM, Pili E, Floor GH, Roman-Ross, G, Charlet, L (2013) Quantification of trace arsenic in soils by field-portable X-ray fluorescence spectrometry: Considerations for sample preparation and measurement conditions. *Journal of Hazardous Materials*, 262, 1213-1222.

Peijnenburg WJGM, Teasdale PR, Reible D, Mondon J, Bennett W, Campbell GC (2014) Passive Sampling Methods for Contaminated Sediments: State of the Science for Metals; Integrated Environmental Assessment and Management, 10 (2), 179-196.

Popek EP (2003) Sampling and Analysis of Environmental Chemical Pollutants. A Complete Guide. Elsevier. ISBN: 978-0-12-561540-2.

Potts PJ (1992) A handbook of silicate rock analysis. Blackie. ISBN: 978-0-216-93209-8 (Print) 978-1-4615-3270-5 (Online).

Quelle C, Besada V, Andrade JM, Gutiérrez N, Schultze F, Gago J, González JJ (2011) Chemometric tools to evaluate the spatial distribution of trace metals in surface sediments of two Spanish rías. Talanta, 87, 197-209.

Scouller RC, Snape I, Stark JS, Gore DB (2006) Evaluation of geochemical methods for discrimination of metal contamination in Antarctic marine sediments: A case study from Casey Station. Chemosphere, 65, 294-309.

Smedes F, Davies, IM, Wells D, Allan A, Besada V (2000) Quality assurance of sampling and sample handling (QUASH) – Interlaboratory study on sieving and normalisation of geographically different sediments; QUASH round 5.

Sutherland RA (2010) BCR-701: A review of 10 years of sequential extraction analyses; Analytica Chimica Acta, 680, 10-20.

Taylor DL, Linehan JC, Murray DW, Prell WL (2012) Indicators of sediment and biotic mercury contamination in a southern New England estuary. Marine Pollution Bulletin, 64(4): 807-819.

Welz B (1985) Atomic Spectroscopy; VCH publishers, Weinheim, Germany.

Williams KL (1987) An introduction to X-ray spectrometry – X-ray fluorescence and electron microprobe analysis. Allen and Win.

Wu SL, Zhao YH, Feng XB, Wittmeier A (1996) Application of inductively coupled plasma mass spectrometry for total metal determination in silicon-containing solid samples using the microwave-assisted nitric acid-hydrofluoric acid-hydrogen peroxide-boric acid digestion system. Journal of Analytical Atomic Spectrometry, 11 (4), 287-296.

Annex III:

Recommended method for the determination of selected trace element in samples of marine origin by flame atomic absorption spectrometry



Recommended method for the determination of selected trace element in samples of marine origin by flame atomic absorption spectrometry

Marine Environmental Studies Laboratory in co-operation with MED POL

November 2011

Table of Content

1. SCOPE:.....	3
2. PRINCIPLE:	4
3. SAMPLE PRE-TREATMENT:.....	4
4. REAGENT:.....	4
5. MATERIAL:.....	5
6. INTERFERENCES:.....	5
7. PROCEDURE:.....	7
8. CALCULATION OF RESULTS:	10
9. EXPRESSION OF RESULTS:.....	10
10. References:.....	11

***NOTE:** This recommended method is not intended to be an analytical training manual. Therefore the method is written with the assumption that it will be performed by formally trained analytical chemists.*

In addition the IAEA recommended methods are intended to be guidance methods that can be used by laboratories as a starting point for generating their own standard operating procedure. If performance data are included in the method they must not be used as absolute QC acceptance criteria,

The recommended protocol is mainly based on EPA 7000B method and ISO 11047 users are encouraged to consult this documents (US EPA, 2007; ISO 1998).

1. **SCOPE:**

This recommended method describes a protocol for measurement of Al, Ca, Co, Cr, Cu, Fe, Mg, Mn, Ni, Sr and Zn by flame (direct aspiration) atomic absorption spectrometry. The method is simple, rapid and applicable to a large number of environmental samples. This method is applicable when the element content in the digested solution is above the method limit. This limit will vary with the matrices and instrument model, indicative quantification limits are reported in table 1.

Table 1: Example of lower quantification limit for analyte in reagent water

Element	Lower quantification limit (mg l ⁻¹)
Al	0.5
Ca	0.02
Co	0.06
Cr	0.1
Cu	0.04
Fe	0.05
Mg	0.003
Mn	0.03
Ni	0.07
Sr	0.06
Zn	0.01

2. **PRINCIPLE:**

The method is based on the atomic absorption spectrometric measurement of the element in the mineralised solutions. In direct-aspiration atomic absorption spectrophotometry, the solution is aspirated and atomized in a flame. A light beam from a hollow cathode lamp or an electrodeless discharge lamp is directed through the flame into a monochromator, and onto a detector that measures the amount of absorbed light. Absorption depends upon the presence of free unexcited ground-state atoms in the flame. Because the wavelength of the light beam is characteristic of only the metal being determined, the light energy absorbed by the flame is a measure of the concentration of that metal in the sample. This principle is the basis of atomic absorption spectrophotometry.

3. **SAMPLE PRE-TREATMENT:**

Samples are prepared following the recommended method for microwave digestion of marine samples for determination of trace element content. (IAEA recommended method, 2011).

4. **REAGENT:**

All reagent used should be free of contamination of analyte of interest

4.1. Water: Reagent water (referenced also as water in the text) should be free of contamination

4.2. Caesium chloride solution, 4g l⁻¹: Dissolve 4g of CsCl of at least 99.999% purity in reagent water to 1 liter.

4.3. Caesium-Lanthanum solution: weigh 5.865g of La₂O₃ and 12.67g of CsCl in 100ml container, add 50ml of reagent water and 25ml of HCl and dilute to 100ml. Commercial solution specially produced for AAS may be used.

4.4. Commercial standard solution 1000µg ml⁻¹: Use a certified reference material solution; this solution should be accompanied by a certificate that should include at the minimum the traceability of the certified concentration as well as the expiration date. The density of the solution or the certified content in mg kg⁻¹ should also be defined to allow preparation of the calibration solution by weighing.

5. MATERIAL:

This section does not list common laboratory glassware

5.1. Atomic absorption spectrophotometer: This shall be equipped with: a hollow cathode lamp or an electrode-less discharge lamp appropriate to the element of interest (operated at the current recommended for the lamp by the instrument manufacturer), a background correction system, a burner suitable for an air/acetylene or nitrous oxide/acetylene flame (operated following the manufacturer's instructions). Deuterium background correction is the minimum technical specification acceptable for background correction for the measurement wavelengths below 350 nm.

5.2. Glassware: All glassware, polypropylene, or fluorocarbon (PFA or TFM) containers, including sample bottles, flasks and pipets tips, should be washed in the following sequence -- 24h soaking in laboratory soap (or 10% alcohol) followed by 24h soaking in 10% nitric acid, followed by 10% soaking in water, final rinse in water, drying under laminar flow hood. Cleaned items should be kept in double sealed plastic bags.

If it can be documented through an active analytical quality control program using spiked samples and method blanks that certain steps in the cleaning procedure are not needed for routine samples, those steps may be eliminated from the procedure (i.e. For the levels measured by flame AAS some sterile plastic containers are sufficiently free of contamination in certain analytes.)

5.3. Pipettes: microliter pipettes size ranging from 50 to 10000 μ l as needed. The accuracy and precision of the pipettes used should be checked as a routine every 6 months and obtained results should be compared with the individual certificates.

5.4. Volumetric containers preferably in polypropylene of a suitable precision and accuracy

6. INTERFERENCES:

6.1. The most troublesome type of interference in atomic absorption spectrometry is usually termed "chemical" and is caused by lack of absorption of atoms bound in molecular combination in the flame. This phenomenon can occur when the flame is not sufficiently hot to dissociate the molecule. The addition of chemical buffer (i.e. Lanthanum or calcium) or the use of nitrous oxide/acetylene gas mixture will help to prevent this interference.

6.2. The presence of high dissolved solids in the sample may result in interference from non-atomic absorbance such as light scattering. In the absence of background correction, this can result in false positive, signal contribution from uncorrected background which cannot be compensated by the method of standard addition.

6.3. Ionisation interference occurs when the flame temperature is sufficiently high to generate the removal of an electron from a neutral atom, giving a positively charged ion. This type of interference can generally be controlled by the addition of a large excess (~1mg l⁻¹) of an easily ionized element such as K or Cs.

6.4. Spectral interference can occur when an absorbing wavelength of an element present in the sample, but not being determined, falls within the width of the absorption line of the element of interest. This type of interference may sometimes be reduced by narrowing the slit width.

Specific conditions applied to individual analytes in case of known interferences are displayed in table 2.

Table 2: Instrument parameter

Element	Wavelength (nm)	Flame type	Chemical buffer*	Background	Typical calibration range (mg l ⁻¹)
Al	324.7	acetylene/NO ₂	Caesium chloride	Deuterium	1.5-40
Ca	422.7	acetylene/NO ₂	Caesium Lanthanum		0.02-1.2
Co	240.7	acetylene/air		Deuterium	0.06-4
Cr	357.9	acetylene/NO ₂			0.3-6
Cr	357.9	acetylene/air	Caesium chloride		0.1-6
Cu	324.7	acetylene/air		Deuterium	0.04-3
Fe	248.3	acetylene/air	Caesium chloride	Deuterium	0.05-3
Mg	285.2	acetylene/air	Caesium Lanthanum	Deuterium	0.003-0.3
Mn	279.5	acetylene/air	Caesium Lanthanum	Deuterium	0.03-3
Ni	232.0	acetylene/air		Deuterium	0.07-4
Sr		acetylene/NO ₂	Caesium chloride		0.06-5
Zn	213.9	acetylene/air		Deuterium	0.01-1.5

* see 4.2, 4.3 and 7.4 for use of chemical buffer

7. **PROCEDURE:**

7.1. Sample solution: Use sample prepared following the recommended method for digestion of marine samples for the determination of trace metal (IAEA, 2011)

7.2. Blank solution: Prepare at least two blank solutions with each batch of sample using same procedure than for samples

7.3. Preparation of calibration solutions:

7.3.1. Before each batch of determination prepare by appropriate dilution of $1000\mu\text{g ml}^{-1}$ stock standard solution (4.4) at least 4 standard solutions and one calibration blank solution covering the appropriate range of the linear part of the curve. The calibration standards and calibration blank should be prepared using the same type of acid or combination of acids and at the same concentration as will result in the test portion.

7.3.2. Calibration solutions should be prepared fresh each day.

7.3.3. If necessary intermediate stock standard solutions can be prepared in 10% nitric acid, these solutions should be prepared monthly.

7.3.4. All volumetric material (pipettes and containers) should be of appropriate precision and accuracy, if not available standard solution can be prepared by weighing.

7.3.5. Example of calibration curve are given in table 2.

7.4. Special case: Use of chemical buffer. If a chemical buffer is added, it should be at the same concentration as in the sample solution (7.1), the blank (7.2), calibration blank and standard solutions (7.3) following the recommendation of table 2.

For CsCl add 5ml of 4g l^{-1} for 50 ml of solution (4.2)

For CsLa solution add 0.5ml for 50ml of solution (4.3)

The chemical buffer will be added to a separate portion of sample and blank solutions that will need to be diluted to a known volume.

7.5. Calibration

7.5.1. Set up the atomic absorption spectrometer according to the manufacturer's instructions at the appropriate wavelength using appropriate conditions (see table 2), and with the suitable background correction system in operation.

7.5.2. Aspirate a calibration solution (7.3) and optimize the aspiration conditions, burner height and flame conditions to get the maximum signal.

7.5.3. Adjust the response of the instrument to zero absorbance whilst aspirating water

7.5.4. Aspirate the set of calibration solutions in ascending order and, as a zero member, the blank calibration solution (7.3).

NOTE: Care should be taken to ensure that, when using the more concentrated standards, the absorbance is < 1 , and preferably not more than 0,6.

The calibration curve is automatically plot from instrument software. The obtained curve should be linear with $r < 0.995$.

To correct for the instrumental drift the calibration should be performed every 20 samples or if the calibration verification has failed (7.8.1).

7.6. Aspirate blank (7.2) and sample solutions (7.1) and record their concentrations calculated by software using the calibration curve.

7.7. If the concentration of the test portion exceeds the calibration range dilute the test portion with the blank solution accordingly.

As an option to avoid too big dilution factors and/or to avoid a diluting large number of solutions, if all solutions are exceeding the calibration range, the burner can be turned from 0 to 90° to decrease the instrument's sensitivity. New calibration standard solutions should be prepared to match the sample range and the procedure should be repeated from (7.3).

7.8. Quality control solutions: Quality control solutions as describe below should be measured during the run.

7.8.1. Initial Calibration Verification ICV:

After initial calibration, the calibration curve must be verified by the use of initial calibration verification (ICV) standard.

The ICV standard is a standard solution made from an independent (second source) material at or near midrange. This solution as a calibration standard is prepared using the same type of acid or combination of acids and at the same concentration as will result in the test portion. If a chemical buffer is necessary it should be added in the ICV.

The acceptance criteria for the ICV standard must be $\pm 10\%$ of its true value

If the calibration curve cannot be verified within the specified limits, the cause must be determined and the instrument recalibrated before samples are analyzed. The analysis data for the ICV must be kept on file with the sample analysis

The calibration curve must also be verified at the end of each analysis batch and/or after every 10 samples. If the calibration cannot be verified within the specified limits, the sample analysis must be discontinued, the cause determined and the instrument recalibrated. All samples following the last acceptable test must be reanalyzed.

7.8.2. Blank solution (7.2): Maximum allowed blank concentration should be well documented and if blank solution exceeds this value all samples prepared along the contaminated blank should be prepared again and reanalysed.

7.8.3. Post digestion spike

Each unknown type of sample should be spike to check for potential matrix effect.

This spike is consider as a single point standard addition, and should be performed with a minimum dilution factor. The recovery of spike calculated as equation 1 should be 85-115%. If this test fails it is recommended to run analyses with standard addition method.

Spike solution: mix a fixe volume (V1) of sample solution, and a known volume (V2) of a standard solution of a known concentration (C_{standard})

Unspike solution: mix same fixe volume (V1) of sample solution, and same volume (V2) of reagent water

Measure concentration C (mg l⁻¹) in both solutions on the calibration curve (7.6), and calculate recovery as:

$$\text{Equation 1} \quad C_{\text{spike}} = \frac{C_{\text{standard}} \times V_2}{(V_1 + V_2)}$$

$$\text{Equation 2} \quad R = \frac{C_{\text{Spike Solution}} - C_{\text{Unspike solution}}}{C_{\text{spike}}} \times 100$$

To be valid concentrations of spike and unspike solutions should be in the linearity range of the calibration curve and the Spike concentration (equation 1) should be in the range of 50-150% of the concentration of unspike solution.

7.8.4. Dilution test:

If the analyte concentration is sufficiently high (minimally, a factor of 10 above the lower limit of quantitation after dilution), an analysis of a 1:5

dilution should agree within $\pm 10\%$ of the original determination. If not, then a chemical or physical interference effect should be suspected, and method of standard addition is recommended.

7.8.5. Certified Reference Material:

At least one certified reference material of a representative matrix should be prepared with each batch of sample, the calculated result should fall in the value of the certificate within the coverage uncertainty. (Linsinger, 2010), to show evidence of unbiased result.

Results of CRM should be recorded for quality control purpose and plot in control chart (UNEP/IOC/IAEA 1994).

An example of sequence order with recommended criteria and actions is given in table 3.

8. CALCULATION OF RESULTS:

Results are calculated with equation 3

$$\text{Equation 3: } w(m) = \frac{(\rho_1 - \rho_0)}{m} \times f \times V \times R$$

$w(m)$ mass fraction of element m in the sample in mg kg^{-1}

ρ_1 : concentration of element m in milligrams per liter as measured in the sample solution

ρ_0 : concentration of element m in milligrams per liter as measured in the blank solution

f : is the dilution factor calculated as

$$f = \frac{\text{final volume}}{\text{initial volume}}$$

or equal to 1 if ρ_1 is determined in undiluted solution

R : recovery calculated using CRM (see 7.8.5) or pre digestion spike

9. EXPRESSION OF RESULTS:

The rounding of values will depend of the uncertainty reported with the result; in general for this method no more than two significant figures will be reported.

Uncertainty component should be reported with all results. (ISO 2005, Nordtest 2004)

Example : $w(\text{Zn}) = 8.5 \pm 1.2 \text{ mg kg}^{-1}$

Table 3: Example of an analytical sequence:

Solutions Description	Performance	Action
Calibration blank	< maximum allowed calibration blank value	Stop until resolve
Standard solution 1 -4	$r > 0.995$	recalibrate in the linearity range
ICV	$\pm 10\%$ of true value	Stop until resolve
Sample blank	< maximum allowed blank value	
CRM	Fall in certificate value within coverage uncertainty, or fall within acceptable criteria of the QC chart	Stop until resolve, check Matrix spike and run again with standard addition method if necessary
Matrix Spike	recovery $100\% \pm 15\%$	switch to standard addition, keep record for future analyses of the same matrix
Dilution Test	sample 1 = 5x sample 1 diluted 5x within 10%	switch to standard addition, keep record for future analyses of the same matrix
Unknown Sample 1-10	should \geq standard 1 and \leq standard 4	report as <minimum quantification limit or dilute
ICV	$\pm 10\%$ of true value	Stop until resolve
Unknown Sample 11-20	should \geq standard 1 and \leq standard 4	report as <minimum quantification limit or dilute
Calibration blank	< maximum allowed calibration blank value	Stop until resolve
Standard solution 1 -4	$r > 0.995$	recalibrate in the linearity range
ICV	$\pm 10\%$ of true value	Stop until resolve
Ect....		

10. REFERENCES:

EPA (2007) U.S. Environmental Protection Agency, EPA method 7000B: Flame Atomic Absorption Spectrophotometry, Rev 2, Febuary 2007, (<http://www.epa.gov/osw/hazard/testmethods/sw846/pdfs/7000b.pdf>)

IAEA (2011) IAEA Recommended method for microwave digestion of marines samples for the determination of trace element content, 2011, *in preparation*, available upon request

ISO (1995) Guide to the expression of uncertainty of measurements International Organisation for Standardization: Geneva

ISO (1998) International Standard Organisation 11047:1998 Soil quality- determination of Cadmium, chromium, copper, lead, manganese, nickel and zinc in aqua regia extracts of soil- flame and electrothermal atomic absorption spectrometric methods, ISO geneva

Linsinger, T. (2010), European Commission - Joint Research Centre, Institute for Reference Materials and Measurements (http://www.erm-crm.org/ERM_products/application_notes/application_note_1/Documents/erm_application_note_1_english_rev3.pdf)

Nordtest (2004) Handbook For Calculation Of Measurement Uncertainty In Environmental Laboratories Edition 2 <http://www.nordicinnovation.net/nordtestfiler/tec537.pdf>)

UNEP/IOC/IAEA (1994) reference method 57: Quality assurance and good laboratory practice, UNEP, 1994

Annex IV:

Recommended method for the determination of selected trace element in samples of marine origin by atomic absorption spectrometry using graphite furnace



Recommended method for the determination of selected trace element in samples of marine origin by atomic absorption spectrometry using graphite furnace

Marine Environmental Studies Laboratory in co-operation with MED POL

November 2011

Table of content

1. SCOPE:.....	3
2. PRINCIPLE:.....	3
3. SAMPLE PRE-TREATMENT:	4
4. REAGENTS:	4
5. MATERIALS:	6
6. INTERFERENCES:	6
7. CHEMICAL MODIFICATION:.....	7
8. PROCEDURE	8
9. CALCULATION OF RESULTS:	14
10. EXPRESSION OF RESULTS:	14
11. REFERENCES:.....	14
Table 1 Approximate characteristic masses and typical working range	3
Table 2 Recommended chemical modifiers	8
Table 3 Example of temperature program	9
Table 4 Example of analytical sequence:	12

***NOTE:** This recommended method is not intended to be an analytical training manual. Therefore the method is written with the assumption that it will be performed by formally trained analytical chemist.*

In addition, the IAEA recommended methods are intended to be guidance methods that can be used by laboratories as a starting point for generating their own standard operating procedure. If performance data are included in the method they must not be used as absolute QC acceptance criteria.

The recommended protocol is mainly based on EPA 7010 method and ISO 15586 users are encouraged to consult this documents (US EPA, 2007; ISO 2003)

1. **SCOPE:**

This International Standard includes principles and procedures for the determination of trace levels of: As, Cd, Co, Cr, Cu, Ni, Pb, and V in samples from marine origin, using atomic absorption spectrometry with electro thermal atomization in a graphite furnace. The method is applicable to the determination of low concentrations of elements. The detection limit of the method for each element depends on the sample matrix as well as the instrument, the type of atomizer and the use of chemical modifiers. Table 1 gives approximate working range and characteristic masses.

Table 1 Approximate characteristic masses and typical working range using 20µl sample volume

Element	Characteristic mass M_0^* pg	Working range ng ml ⁻¹
As	15	5-50
Cd	0.8	0.2-2
Co	10	3-30
Cr	3	2-20
Cu	10	3-30
Ni	13	5-50
Pb	15	5-50
V	35	10-100

**The characteristic mass (m_0) of an element is the mass in pg corresponding to a signal of 0.00044 unity using peak area as integration*

2. **PRINCIPLE:**

An aliquot of sample solution (5-50 μL) is introduced into a graphite tube of the GF AAS and atomized by rapid heating at high temperature. A light beam is directed through the graphite tube, into a monochromator, and onto a detector that measures the amount of light absorbed by the atomized element in the tube. Each metal has its own characteristic wavelength therefore a source hollow cathode lamp composed of that element is used. The amount of energy absorbed at the characteristic wavelength is proportional to the concentration of the element in the sample.

3. **SAMPLE PRE-TREATMENT:**

Samples are prepared following the recommended method for microwave digestion of marine samples for determination of trace element content. (IAEA recommended method, 2011)

4. **REAGENTS:**

4.1. Water: Reagent water (referenced also as water in the text) should be free of contamination

4.2. Concentrated acid solution as used for sample preparation (section 3)

4.3. Commercial standard solution $1000\mu\text{g ml}^{-1}$: Use certified reference material solution; this solution should be accompanied by a certificate that should include at least the traceability of the certified concentration as well as the expiration date. The density of the solution or the certified content in mg kg^{-1} should also be defined to allow preparation of calibration solution by weighing.

4.4. Calibration solutions: Prepare calibration solutions from the standard solutions (4.3) by appropriate dilution. Intermediate standard solutions should be prepared in 2% (v/v) nitric acid. For calibration solution use the same amount of acid as that of the samples solutions.

Calibration solutions below 1 mg/l should not be used for more than one month, and those below $100 \mu\text{g/l}$ should not be used for more than one day.

4.5. Blank calibration solution: Prepare a blank calibration solution in the same way as the calibration solution but without adding standard. The final amount of acid will be the same as that of the sample solutions.

4.6. Palladium nitrate/magnesium nitrate modifier

Pd(NO₃)₂ solution is commercially available (10 g/l). Dissolve 0,259 g of Mg(NO₃)₂·6H₂O in 100 ml of water. Mix the palladium nitrate solution with twice as much magnesium nitrate solution. 10 µl of the mixed solution is equal to 15 µg Pd and 10 µg Mg(NO₃)₂. The mixture is also commercially available.

Prepare a fresh solution monthly.

4.7. Magnesium nitrate modifier

Dissolve 0,865 g of Mg(NO₃)₂·6H₂O in 100 ml of water. 10 µl of this solution is equal to 50 µg Mg(NO₃)₂.

4.8. Ammonium dihydrogen phosphate modifier

Dissolve 2,0 g of NH₄H₂PO₄ in 100 ml of water. 10 µl of this solution is equal to 200 µg NH₄H₂PO₄.

4.9. Ammonium dihydrogen phosphate/magnesium nitrate modifier

Dissolve 2,0 g of NH₄H₂PO₄ and 0,173 g of Mg(NO₃)₂·6H₂O in 100 ml of water. 10 µl of this solution is equal to 200 µg NH₄H₂PO₄ and 10 µg Mg(NO₃)₂.

4.10. Palladium/Ammonium dihydrogen phosphate/magnesium nitrate modifier

Mix 2ml of Pd(NO₃)₂ solution is commercially available (10 g/l), 2ml of Mg(NO₃)₂ solution prepared as (4.7), 0.5ml of NH₄H₂PO₄ prepared as (4.8) and dilute with water to 10ml. 4µl of this solution is equal to 8µg of Pd, 4µg of Mg(NO₃)₂ and 4µg of NH₄H₂PO₄.

4.11. Nickel modifier

Dissolve 0,200 g of nickel powder in 1 ml concentrated nitric acid and dilute to 100 ml with water. 10 µl of this solution is equal to 20 µg Ni. Solutions of Ni(NO₃)₂ are also commercially available.

4.12. Iridium solution 1000µg ml⁻¹

Use commercial solution (standard)

4.13. Argon

5. MATERIALS:

5.1. Glassware: All glassware, polypropylene, or fluorocarbon (PFA or TFM) containers, including sample bottles, flasks and pipettes tips, should be washed in the following sequence -- 24h soaking in laboratory soap (or 10% alcohol) followed by 24h soaking in 10% nitric acid, followed by 10% soaking in water, final rinsing in water, drying under laminar flow hood. Cleaned items should be kept in double sealed plastic bags

5.2. Pipettes: microliter pipettes size ranging from 50 to 10000 μ l as needed. The accuracy and precision of the pipettes used should be checked as a routine every 6 months and the obtained results should be compared with the individual certificates.

5.3. Volumetric containers preferably in polypropylene of suitable precision and accuracy

5.4. Atomic Absorption Spectrometer equipped with graphite furnace, background correction system and necessary hollow cathode lamp.

5.5. Auto sampler

5.6. Polypropylene cups for automatic sampler cleaned as explained in (5.1)

5.7. Graphite tubes: pyrolytically-coated with platforms, preferably for highly and medium volatile elements, whereas elements of low volatility should be atomized from the wall. Provided satisfactory results are achieved, manufacturer's recommendations regarding the use of graphite tubes and platforms should be followed.

6. INTERFERENCES:

Some sample solutions, may contain large amounts of substances that may affect the results. High concentrations of chloride may cause low results, because the volatility of many elements is increased and analyte loss may occur during the pyrolysis step. Matrix effects may be overcome, partially or completely, by the optimization of the temperature program, the use of pyrolytically-coated tubes and platforms, the use of chemical modifiers, the standard addition technique and the use of background correction.

7. CHEMICAL MODIFICATION:

Chemical modifiers are used to overcome spectral and/or non-spectral interferences in a sample (matrix effects). In general, the aim of chemical modification is to allow a pyrolysis temperature that is high enough to remove the bulk of concomitants before the atomization step. In order to ascertain that the modification works, the spike procedures is performed with and without the addition of a chosen chemical modifier and recovery are compared

Spike experiment:

Spike solution: mix a fixe volume (V1) of sample solution, and a known volume (V2) of a standard solution of a known concentration (C_{standard})

Unspike solution: mix same fixe volume (V1) of sample solution, and same volume (V2) of reagent water

Measure concentration C (mg l⁻¹) in both solutions on the calibration curve, and calculate recovery as:

$$\text{Equation 1} \quad C_{\text{spike}} = \frac{C_{\text{standard}} \times V_2}{(V_1 + V_2)}$$

$$\text{Equation 2} \quad R = \frac{C_{\text{Spike Solution}} - C_{\text{Unspike solution}}}{C_{\text{spike}}} \times 100$$

To be valid concentrations of spike and unspike solutions should be in the linearity range of the calibration curve and Spike concentration (equation 1) should be in the range of 50-150% of the concentration of unspike solution. The recovery should be 100 ± 15%

In Table 2 some recommendations of chemical modifiers are given.

Other chemical modifiers may be used if they show consistent results. Graphite tube can also be pretreated with Iridium (Vasileva 2001) as following:

Inject 50µl of the solution and run the temperature program below

Step	Temperature (°C)	Ramp Time (s)	Hold Time (s)
1	100	5	30
2	1200	20	5
3	100	5	2
4	2500	2	10

Repeat this 3 times, the coating is stable for about 200 injections and can be repeated

If chemical modifiers are used, add them to test samples, sample blank solutions, calibration solutions, and blank calibration solutions. Preferably inject the modifier solution with the auto sampler directly into the atomizer after the sample is delivered.

Table 2 Recommended chemical modifiers

Element	Chemical modifier	Amount* µg
As	Pd + Mg(NO ₃) ₂ or NH ₄ H ₂ PO ₄	15+10 200
Cd	Pd + Mg(NO ₃) ₂ +NH ₄ H ₂ PO ₄ or Ir coating	8+4+4
Co	Pd + Mg(NO ₃) ₂	15+10
Cr	Mg(NO ₃) ₂	50
Cu	None	
Ni	Mg(NO ₃) ₂	50
Pb	Pd + Mg(NO ₃) ₂ +NH ₄ H ₂ PO ₄ or Ir coating	8+4+4
V	None	

*These amounts are only recommendation, significantly lower amounts may be required in some atomizers, see also recommendations from instrument manufacturers.

8. PROCEDURE

8.1. Switch on the instrument and perform the optimization according to the manufacturer's instructions. Install an appropriate graphite tube, and set up the auto sampler.

8.2. Program the graphite furnace and the auto sampler. Examples of temperature program are given in table 3.

Note: Method for specific element and matrix should be developed and all necessary information should be stored with at least:

- *Temperature program*
- *Matrix modifier*
- *Type of graphite tube*
- *Matrix effect*
- *Type of calibration curve*
- *Typical m_0 obtained with the program*
- *Linearity*

Table 3 Example of temperature program

Element	Cu	Cu	Cd	Cd	Pb	Pb	As	As	Cr	Cr
Sample type	Sediment	Biota	Sediment	Biota	Sediment	Biota	Sediment	Biota	Sediment	Biota
Wavelength(nm)	327.4	327.4	228.8	228.8	283.3	283.3	193.7	193.7	357.9	357.9
Graphite tube	Partition Tube	Partition Tube	platform	platform	platform	platform	platform	platform	Partition Tube	Partition Tube
Matrix Modifier	none	none	none	Pd,Mg, Amonium Phosphate	none	Pd,Mg ,Amonium Phosphate	Pd,Mg	Pd,Mg	none	none
Peak Measurement	area	area	area	area	area	area	area	area	area	area
M0(pg/0.0044 UA) on standard	13	13	1	1	16	16	15	15	2.5	2.5
Ashing T° (C°)	700	700	300	700	400	925	1400	1400	1100	1100
Atomisation T° (C°)	2300	2300	1800	1900	2100	2200	2600	2600	2600	2600
Remark							Number of Fire is critical	Standard Addition often required. Number of fire is critical	Use peak Height for lower concentration (peak shape)	Standard Addition often required. Use peak Height for lower concentration (peak shape)

8.3. Generality for measurements:

All measurements should be performed with at least duplicate injections of solutions; the relative standard deviation should be less than 5% for a signal above 0.01 unit of absorbance.

It is recommended to work in peak area.

Check the number of firing and change the graphite tube when appropriate, if graphite tube is changed during a run, the instrument needs to be recalibrated.

8.4. Run the calibration:

8.4.1. **Standard calibration technique:** Perform the calibration with a blank calibration solution (4.5) and 3 to 5 equidistant calibration solutions (4.4) for an appropriate concentration range.

To correct for the instrumental drift calibration should be performed every 10 samples (if possible the option of reslope using the middle standard point should be applied every 5 samples)

Calibration solutions can be prepared by the auto sampler from the highest standard solution, the minimum volume uptake should not be less than 4 μ l.

The blank calibration solution should be free of analyte, or below a well-documented maximum allowed calibration blank value (i.e. validation, control charts..).

It should be stressed that the linearity of the calibration curve is often limited. The calibration curve is automatically plot by instrument software, if linear regression is set checked that $r \leq 0.995$ or switch to second order equation.

8.4.2. **Standard addition method:** This technique involves preparing same aliquots of sample solution with increasing amount of analyte. As describe in section 7 for the spike experiment using an increasing concentration of standard (V1 and V2 should stay the same). The auto sampler can be prograded to perform standard addition. Determine the analyte concentration in the reagent blank solution the same way. Example of standard addition is given in figure 1. The concentration is obtained by dividing the absorbance of zero addition by the slope.

The standard addition should be performed for each type of matrix (i.e. a sediment sample solution cannot be measured with a standard addition curve done on a fish sample solution). For similar sample matrices (i.e. same fish species) the slope obtained with one sample can be used for other measurements respecting recalibration every 10 samples.

For standard addition to be valid the following limitation should be taken into consideration:

- The resulting calibration should be linear ($r \leq 0.995$), software calibration equation is a linear regression
- The additions should represent ideally 50, 100, 150 and 200% of the sample concentration
- The standard addition technic cannot be used to correct for spectral interferences, such as unspecific background absorption, and should not be used if interferences change the signal by a factor of more than three.

Figure 1 Standard addition example

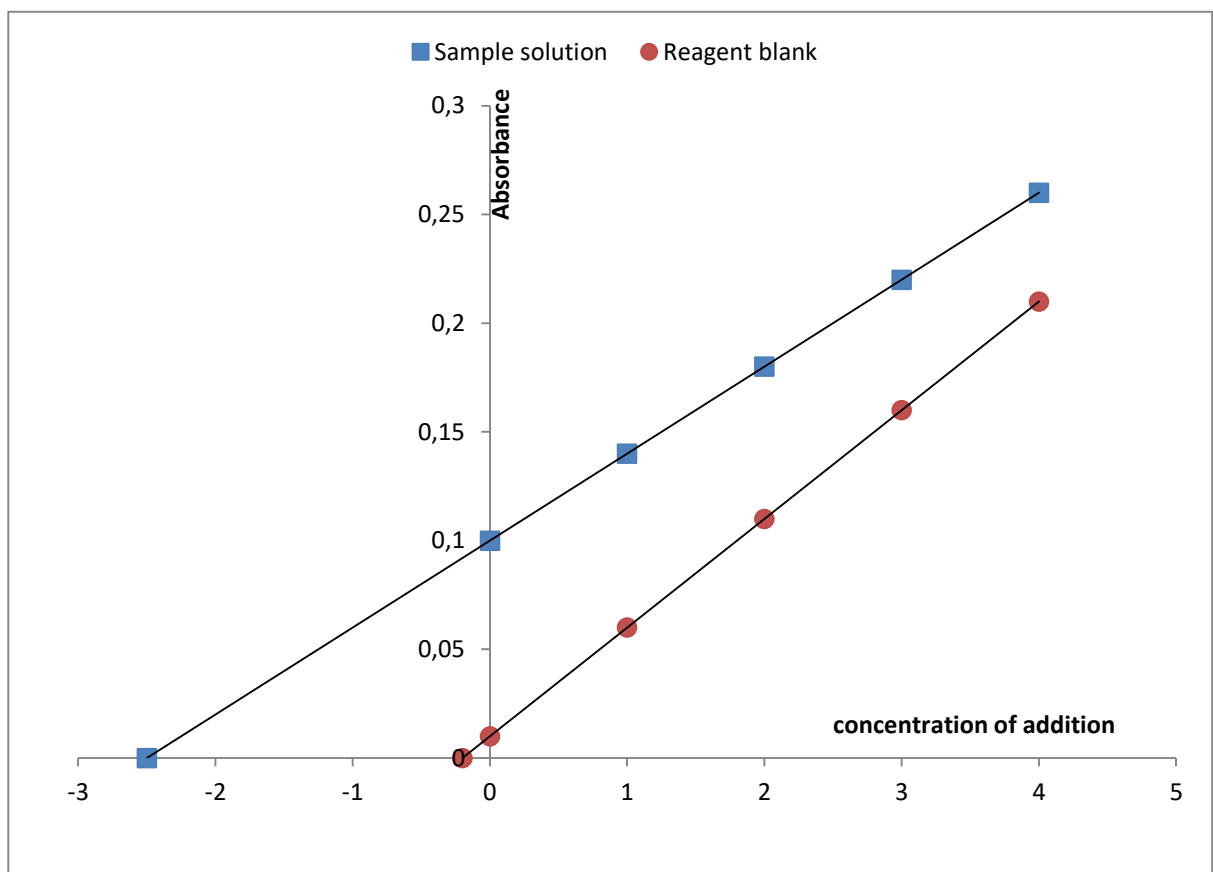

8.5. Measure sample blank and sample solutions (prepared following section 3) record the concentration as calculated by the software and calculate results following equation 3 (section 9), if samples exceed the highest point of calibration dilute appropriately. As an option a smaller volume of solution can be injected to stay under linear range of the instrument.

8.6. Quality control solutions: Quality control solutions as described below should be measured during the run. An example of a sequence order with recommended criteria and action is given in table 4.

Table 4 Example of analytical sequence:

Solutions Description	Performance	Action
Calibration blank	< maximum allowed calibration blank value	Stop until resolve
Standard solution 1 -4	$r > 0.995$	recalibrate in the linearity range
ICV	$\pm 10\%$ of true value	Stop until resolve
Sample blank	< maximum allowed blank value	
CRM	Fall in certificate value within coverage uncertainty, or fall within acceptable criteria of the QC chart	Stop until resolve, check Matrix spike and run again with standard addition method if necessary
Matrix Spike	recovery $100\% \pm 15\%$	switch to standard addition, keep record for future analyses of the same matrix
Dilution Test	sample 1 = 5x sample 1 diluted 5x within 10%	switch to standard addition, keep record for future analyses of the same matrix
Unknown Sample 1-10	should \geq standard 1 and \leq standard 4	report as <minimum quantification limit or dilute

ETC...(restart sequence from calibration blank)

8.6.1. Initial Calibration Verification ICV:

After the initial calibration, the calibration curve must be verified using the initial calibration verification (ICV) standard.

The ICV standard is a standard solution made from an independent (second source) material at or near midrange. This solution as calibration standard is prepared using the same type of acid or combination of acids and at the same concentration as will result in the test portion.

The acceptance criteria for the ICV standard must be $\pm 10\%$ of its true value

If the calibration curve cannot be verified within the specified limits, the cause must be determined and the instrument recalibrated before samples are analyzed.

The analysis data for the ICV must be kept on file with the sample analysis

The calibration curve must also be verified at the end of each analysis batch and/or after every 10 samples. If the calibration cannot be verified within the specified limits, the sample analysis must be discontinued, the cause determined and the instrument recalibrated. All samples following the last acceptable test must be reanalyzed.

8.6.2. **Blank solution (4.5):** Maximum allowed blank concentration should be well documented and if blank solution exceeds this value all samples prepared along the contaminated blank should be prepared again and re analyzed.

8.6.3. **Post digestion spike**

Each unknown type of sample should be spike to check for potential matrix effect.

This spike is consider as a single point standard addition, and should be performed with a minimum dilution factor. Recovery of spike calculated as equation 1 should be 85-115%. If this test failed it is recommended to run analyses with standard addition method. (see section 7 for detail)

8.6.4. **Dilution test:**

If the analyte concentration is sufficiently high (minimally, a factor of 10 above the lower limit of quantitation after dilution), an analysis of a 1:5 dilution should agree within $\pm 10\%$ of the original determination. If not, then a chemical or physical interference effect should be suspected, and method of standard addition is recommended.

8.6.5. **Certified reference material:**

At least one certified reference material of a representative matrix will be prepared with each batch of sample, the calculated result should be comparable with the value of the certificate within the coverage uncertainty.(Linsinger, 2010), to show evidence of unbiased result.

Results of CRM should be record for quality control purpose and plot in control chart (UNEP/IOC/IAEA 1994)

9. CALCULATION OF RESULTS:

Results are calculated with equation 3

$$\text{Equation 3: } w(m) = \frac{(\rho_1 - \rho_0)}{m} \times f \times V \times R$$

w(m) mass fraction of element m in the sample in mg kg⁻¹

ρ1: concentration of element m in milligrams per liter as measured in the sample solution

ρ0: concentration of element m in milligrams per liter as measured in the blank solution

f: is the dilution factor calculated as

$$f = \frac{\text{final volume}}{\text{initial volume}}$$

or equal to 1 if ρ1 is determined in undiluted solution

R: recovery calculated using CRM (see 8.6.5) or pre digestion spike

10. EXPRESSION OF RESULTS:

The rounding of values will depend of the uncertainty reported with the result. Uncertainty component should be reported with all results. (ISO 1995, Nordtest 2004)

Example : w(Pb) = 8.5 ± 1.2 mg kg⁻¹

11. REFERENCES:

EPA (2007) U.S. Environmental Protection Agency, EPA method 7010: Graphite furnace Atomic Absorption Spectrophotometry, Rev 0, February 2007, (<http://www.epa.gov/osw/hazard/testmethods/sw846/pdfs/7010.pdf>)

IAEA (2011) IAEA Recommended method for microwave digestion of marines samples for the determination of trace element content, 2011, *in preparation*, available upon request

ISO (1995) Guide to the expression of uncertainty of measurements International Organisation for Standardization: Geneva

ISO (1998) International Standard Organisation 11047:1998 Soil quality- determination of Cadmium, chromium, copper, lead, manganese, nickel and zinc in aqua regia extracts of soil-flame and electrothermal atomic absorption spectrometric methods, ISO geneva

Linsinger, T. (2010), European Commission - Joint Research Centre, Institute for Reference Materials and Measurements (http://www.erm-crm.org/ERM_products/application_notes/application_note_1/Documents/erm_application_note_1_english_rev3.pdf)

Nordtest (2004) Handbook For Calculation Of Measurement Uncertainty In Environmental Laboratories Edition 2 <http://www.nordicinnovation.net/nordtestfiler/tec537.pdf>

UNEP/IOC/IAEA (1994) reference method 57: Quality assurance and good laboratory practice, UNEP, 1994

Vasileva. E, Baeten. H, Hoenig. M (2001), Advantages of the iridium permanent modifier in fast programs applied to trace-element analysis of plant samples by electrothermal atomic absorption spectrometry, Fresenius J Anal Chem (2001) 369 :491–495

Annex V:

METHOD 6020B

INDUCTIVELY COUPLED PLASMA—MASS SPECTROMETRY

INDUCTIVELY COUPLED PLASMA—MASS SPECTROMETRY

SW-846 is not intended to be an analytical training manual. Therefore, method procedures are written based on the assumption that they will be performed by analysts who are formally trained in at least the basic principles of chemical analysis and in the use of the subject technology.

In addition, SW-846 methods, with the exception of required method use for the analysis of method-defined parameters, are intended to be guidance methods which contain general information on how to perform an analytical procedure or technique which a laboratory can use as a basic starting point for generating its own detailed standard operating procedure (SOP), either for its own general use or for a specific project application. The performance data included in this method are for guidance purposes only, and are not intended to be and must not be used as absolute quality control (QC) acceptance criteria for purposes of laboratory accreditation.

1.0 SCOPE AND APPLICATION

1.1 Inductively coupled plasma-mass spectrometry (ICP-MS) is applicable to the determination of sub- $\mu\text{g/L}$ concentrations of a large number of elements in water samples and in waste extracts or digests (Refs. 1 and 2). When dissolved constituents are required, samples must be filtered and acid-preserved prior to analysis. No digestion is required prior to analysis for dissolved elements in water samples. Acid digestion prior to filtration and analysis is required for groundwater, aqueous samples, industrial wastes, soils, sludges, sediments, and other solid wastes for which total (acid-leachable) elements are required. The analyst should insure that a sample digestion method is chosen that is appropriate for each analyte and the intended use of the data. Refer to Chapter Three for the appropriate digestion procedures.

1.2 ICP-MS has been applied to the determination of over 60 elements in various matrices. Analytes for which the acceptability of Method 6020 has been demonstrated through multi-laboratory testing on solid and aqueous wastes are listed below.

Element	Symbol	CASRN ^a	Element	Symbol	CASRN ^a
Aluminum	Al	7429-90-5	Magnesium	Mg	7439-95-4
Antimony	Sb	7440-36-0	Manganese	Mn	7439-96-5
Arsenic	As	7440-38-2	Mercury	Hg	7439-97-6
Barium	Ba	7440-39-3	Nickel	Ni	7440-02-0
Beryllium	Be	7440-41-7	Potassium	K	7440-09-7

Element	Symbol	CASRN ^a	Element	Symbol	CASRN ^a
Cadmium	Cd	7440-43-9	Selenium	Se	7782-49-2
Calcium	Ca	7440-70-2	Silver	Ag	7440-22-4
Chromium	Cr	7440-47-3	Sodium	Na	7440-23-5
Cobalt	Co	7440-48-4	Thallium	Tl	7440-28-0
Copper	Cu	7440-50-8	Vanadium	V	7440-62-2
Iron	Fe	7439-89-6	Zinc	Zn	7440-66-6
Lead	Pb	7439-92-1			

^aChemical Abstract Service Registry Number

The performance acceptability of ICP-MS for the determination of the listed elements was based upon comparison of the multi-laboratory testing results with those obtained from either furnace atomic absorption spectrophotometry or inductively coupled plasma—optical emission spectrometry. It should be noted that one multi-laboratory study was conducted in 1988. As advances in ICP-MS instrumentation and software have been made since that time, other elements have been added through validation and with additional improvements in performance of the method. Performance, in general, presently exceeds the original multi-laboratory performance data for the listed elements (and others) that are provided in Sec. 13.0. Instrument detection limits (IDLs), lower limits of quantitation (LLOQs) and linear ranges will vary with the matrices, instrumentation, and operating conditions. In relatively simple matrices, IDLs will generally be < 0.1 µg/L. For less sensitive elements (e.g., Se and As) and desensitized major elements, IDLs may be ≥ 1.0 µg/L.

1.3 If Method 6020 is used to determine any analyte not listed in Sec. 1.2, it is the responsibility of the analyst to demonstrate the precision and bias of the method for the waste to be analyzed. The analyst must always monitor potential sources of interferences and take appropriate action to ensure data of known quality (see Sec. 9.0). Other elements and matrices may be analyzed by this method if performance is demonstrated for the analyte of interest, in the matrices of interest, at the concentration levels of interest in the same manner as the listed elements and matrices (see Sec. 9.0).

1.4 Use of this method should be restricted to spectroscopists who are knowledgeable in the recognition and correction of spectral, chemical, and physical interferences in ICP-MS analysis.

1.5 An appropriate internal standard is necessary for each analyte determined by ICP-MS. Recommended internal standards are ⁶Li, ⁴⁵Sc, ⁸⁹Y, ¹⁰³Rh, ¹¹⁵In, ¹⁵⁹Tb, ¹⁶⁵Ho, and ²⁰⁹Bi. The lithium internal standard should have an enriched abundance of ⁶Li, so that

Page 3 interference from lithium native to the sample is minimized. Other elements may need to be used as internal standards when samples contain significant native amounts of the recommended internal standards as indicated by high bias of internal standard recoveries.

Note: Other potential causes of a high bias should also be considered before a final decision is made that the internal standard high bias is caused by an excessive concentration of the internal standard isotope in the sample.

1.6 Prior to employing this method, analysts are advised to consult the preparatory method for each type of procedure that may be employed in the overall analysis (e.g., Methods 3005, 3010, 3015, 3031, 3040, 3050, 3051, 3052, 7000, and 6800) for additional information on QC procedures, development of QC acceptance criteria, calculations, and general guidance. Analysts also should consult the disclaimer statement at the front of the manual and the information in Chapter Two for guidance on the intended flexibility in the choice of methods, apparatus, materials, reagents, and supplies, and on the responsibilities of the analyst for demonstrating that the techniques employed are appropriate for the analytes of interest, in the matrix of interest, and at the levels of concern.

In addition, analysts and data users are advised that, except where explicitly specified in a regulation, the use of SW-846 methods is *not* mandatory in response to Federal testing requirements. The information contained in this method is provided by EPA as guidance to be used by the analyst and the regulated community in making judgments necessary to generate results that meet the data quality objectives (DQOs) for the intended application.

1.7 This method is restricted to use by, or under supervision of, properly experienced and trained personnel. Each analyst must demonstrate the ability to generate acceptable results with this method.

2.0 SUMMARY OF METHOD

2.1 Prior to analysis, aqueous and solid samples are solubilized or digested using the appropriate sample preparation methods (see Chapter Three). When analyzing groundwater samples for dissolved constituents, acid digestion is not necessary, if the samples are filtered and acid-preserved prior to analysis (e.g., Methods 3005, 3010, 3015, 3031, 3050, 3051 and 3052). For oils, greases, or waxes, use the solvent dissolution procedure in method 3040 to prepare the samples.

2.2 This method describes multi-element determinations using ICP-MS in environmental samples. The method measures ions produced by a radio-frequency inductively coupled plasma. Analyte species in liquid are nebulized and the resulting aerosol is transported by argon gas into the plasma torch. The ions produced by high temperatures are entrained in the plasma gas and introduced, by means of an interface, into a mass spectrometer. The ions produced in the plasma are sorted according to their mass-to-charge (m/z) ratios and quantified with a channel electron multiplier. Interferences must be assessed and valid corrections applied or the data flagged to indicate problems. Interference correction must include compensation for background ions contributed by the plasma gas, reagents, and constituents of the sample matrix.

3.0 DEFINITIONS

Refer to Chapter One, Chapter Three, and the manufacturer's instructions for definitions that may be relevant to this procedure.

4.0 INTERFERENCES

4.1 Isobaric elemental interferences in ICP-MS are caused by isotopes of different elements forming atomic ions with the same nominal m/z ratio. A data system must be used to correct for these interferences. This involves determining the signal for another isotope of the interfering element and subtracting the appropriate signal from the analyte isotope signal.

4.2 Isobaric molecular and doubly charged ion interferences in ICP-MS are caused by ions consisting of more than one atom or charge, respectively. Most isobaric interferences that could affect ICP-MS determinations have been identified in the literature (Refs. 3 and 4). Examples include $^{75}\text{ArCl}^+$ ion on the ^{75}As signal and MoO^+ ions on the cadmium isotopes. While the approach used to correct for molecular isobaric interferences is demonstrated below using the natural isotope abundances from the literature (Ref. 5), the most precise coefficients for an instrument can be determined from the ratio of the net isotope signals *observed* for a standard solution of the interfering element at a concentration which produces sufficient interference at the isotopes of interest that a reliable measurement can be made. Because the ^{35}Cl natural abundance of 75.77% is 3.13 times the ^{37}Cl abundance of 24.23%, the chloride correction for arsenic can be calculated (approximately) as follows (where the $^{38}\text{Ar}^{37}\text{Cl}^+$ contribution at m/z 75 is a negligible 0.06% of the $^{40}\text{Ar}^{35}\text{Cl}^+$ signal):

Corrected arsenic signal (using the abundances of natural isotopes
for coefficient approximations) =

$$(m/z\ 75\ \text{signal}) - (3.13) [(m/z\ 77\ \text{signal}) - (0.87) (m/z\ 82\ \text{signal})]$$

where, the final term adjusts for any selenium contribution at 77 m/z ,

NOTE: Arsenic values can be biased high by this type of equation when the net signal at m/z 82 is caused by ions other than $^{82}\text{Se}^+$, (e.g., $^{81}\text{BrH}^+$ from bromine wastes [Ref. 6]).

NOTE: The coefficients should be verified experimentally using the procedures or coefficients provided by the instrument manufacturer.

Similarly,

Corrected cadmium signal (using the abundances of natural isotopes
for coefficient approximations) =

$$(m/z\ 114\ \text{signal}) - (0.027)(m/z\ 118\ \text{signal}) - (1.63)(m/z\ 108\ \text{signal})$$

where, the last 2 terms adjust for any $^{114}\text{Sn}^+$ or $^{114}\text{MoO}^+$ contributions at m/z 114.

NOTE: Cadmium values will be biased low by this type of equation when $^{92}\text{ZrO}^+$ ions contribute at m/z 108, but use of m/z 111 for Cd is even subject to direct ($^{94}\text{ZrOH}^+$) and indirect ($^{90}\text{ZrO}^+$) additive interferences when Zr is present.

NOTE: With respect to the arsenic equation above, the coefficients could be improved. For example, the coefficient to modify "3.13" (in the equation above) for a particular instrument can be determined from the observed ratio of the m/z 75 to the m/z 77 net isotope signals for a solution of hydrochloric acid. The concentration of HCl used should provide enough signal at the measured isotopes to ensure that a reliable measurement can be made, while not exceeding the linear range of the detector.

The accuracy of these types of equations is based upon the constancy of the *observed* isotopic ratios for the interfering species. Corrections that presume a constant fraction of a molecular ion relative to the "parent" ion have not been found (Ref. 7) to be reliable, e.g., oxide levels can vary with operating conditions. If a correction for an oxide ion is based upon the ratio of parent-to-oxide ion intensities, the correction must be adjusted for the degree of oxide formation by the use of an appropriate oxide internal standard previously demonstrated to form a similar level of oxide as the interferent. For example, this type of correction has been reported (Ref. 7) for oxide-ion corrections using ThO^+/Th^+ for the determination of rare earth elements. The use of aerosol desolvation and/or mixed gas plasmas have been shown to greatly reduce molecular interferences (Ref. 8). These techniques can be used, provided that IDL, bias, and precision specifications for analysis of the samples can be met.

4.3 As technology continues to develop, modifications to existing ICP-MS instrumentation can reduce or completely remove common interferences thus eliminating the need for reliance on correction equations. Instruments must be able to demonstrate successful freedom from interferences. Examples of such modifications are discussed in more detail below:

4.3.1 Recent ICP-MS instruments may include collision or reaction cells for removal of molecular isobaric interferences. This type of interference removal is effective, and highly recommended for complex and/or varying matrices. The systems work either by collision of molecular species with an inert gas (usually helium) or by reaction of molecular species or the target analyte with reactive gases (e.g., ammonia or methane). Manufacturer recommendations should be followed for the configuration of the collision/reaction cell. This technique may eliminate the need for most correction equations, but freedom from interference still needs to be demonstrated using the spectral interference check (SIC) solutions described in sections 7.23 and 9.9.

4.3.2 High resolution ICP-MS instruments are available based on several mass analyzer designs with much higher mass resolution within the mass range of traditional ICP-MS instruments. These mass analyzers are not based on quadrupole mass analyzers and have orders of magnitude resolution above quadrupoles, which helps reduce or eliminate interference from polyatomic ions with the same nominal mass. These mass analyzers reduce or eliminate the need for most correction equations, but the instrument needs to be operated at sufficient resolution to remove the expected

interference. For example, resolving ^{52}Cr from $^{40}\text{Ar}^{12}\text{C}$ requires a resolution of around 4000, while resolving ^{75}As from $^{40}\text{Ar}^{35}\text{Cl}$ requires a resolution of around 8000. Freedom from interferences needs to be demonstrated for the particular higher resolution mass analyzers ICP-MS.

4.4 Additionally, solid-phase chelation may be used to eliminate isobaric interferences from both element and molecular sources. An on-line method has been demonstrated for environmental waters such as sea water, drinking water and acid decomposed samples. Acid decomposed samples refer to samples decomposed by methods similar to methods 3052, 3051, 3050 or 3015. Samples with % levels of iron and aluminum should be avoided. The method also provides a method for preconcentration to enhance detection limits simultaneously with elimination of isobaric interferences. The method relies on chelating resins such as imminodiacetate or other appropriate resins and selectively concentrates the elements of interest while eliminating interfering elements from the sample matrix. By eliminating the elements that are direct isobaric interferences or those that form isobaric interfering molecular masses, the mass region is simplified and these interferences cannot occur. The method has been proven effective for the certification of reference materials and validated using reference materials (Refs. 13-15). The method has the potential to be used on-line or off-line as an effective sample preparation method specifically designed to address interference problems.

4.5 Since commercial quadrupole ICP-MS instruments nominally provide unit resolution at 10% of the peak height, very high ion currents at adjacent masses can also contribute to ion signals at the mass of interest. Although this type of interference is uncommon, it is not easily corrected, and samples exhibiting a significant problem of this type could need resolution improvement, matrix separation, or analysis using another verified and documented isotope, or otherwise the use of another method.

4.6 Physical interferences are associated with the sample nebulization and transport processes as well as with ion-transmission efficiencies. Nebulization and transport processes can be affected if a matrix component causes a change in surface tension or viscosity. Changes in matrix composition can cause significant signal suppression or enhancement (Ref. 9). Dissolved solids can deposit on the nebulizer tip of a pneumatic nebulizer and on the interface skimmers (reducing the orifice size and the instrument performance). Dissolved solid levels below 0.2% (2,000 mg/L) have been currently recommended (Ref. 10) to minimize solid deposition, although currently-available ICP-MS systems may be able to tolerate much higher levels. An internal standard can be used to correct for physical interferences, if it is carefully matched to the analyte so that the two elements are similarly affected by matrix changes (Ref. 11). When intolerable physical interferences are present in a sample, a significant suppression of the internal standard signals (to less than 30% of the signals in the calibrations standard) will be observed. Dilution of the sample five-fold (i.e., dilute one part sample with four parts diluent [1:5 = 1+4]) will usually eliminate the problem.

4.7 Memory interferences or carry-over can occur when there are large concentration differences between samples or standards which are analyzed sequentially. Sample deposition on the sampler and skimmer cones, spray chamber design, and the type of nebulizer affect the extent of the memory interferences which are observed. The rinse period between samples must be long enough to eliminate significant memory interference.

4.8 Reagents and sample processing hardware may yield artifacts and/or interferences to sample analysis. All of these materials must be demonstrated to be free from interferences under the conditions of the analysis by analyzing method blanks. Specific selection of reagents may be necessary. Refer to each method to be used for specific guidance on QC procedures.

5.0 SAFETY

5.1 This method does not address all safety issues associated with its use. The laboratory is responsible for maintaining a safe work environment and a current awareness file of OSHA regulations regarding the safe handling of the chemicals specified in this method. A reference file of material safety data sheets (MSDSs) should be available to all personnel involved in these analyses.

5.2 Concentrated nitric and hydrochloric acids are moderately toxic and extremely irritating to skin and mucus membranes. Use these reagents in a hood and if eye or skin contact occurs, flush with large volumes of water. Always wear safety glasses or a shield for eye protection when working with these reagents.

5.3 **Hydrofluoric acid is a very toxic acid and penetrates the skin and tissues deeply if not treated immediately.** Injury occurs in two stages: firstly, by hydration that induces tissue necrosis; and secondly, by penetration of fluoride ions deep into the tissue and thereby reacting with calcium. Boric acid and/or other complexing reagents and appropriate treatment agents should be administered immediately.

WARNING: Consult appropriate safety literature for determining the proper protective eyewear, clothing and gloves to use when handling hydrofluoric acid. **Always have appropriate treatment materials readily available prior to working with this acid.** See Method 3052 for additional recommendations for handling hydrofluoric acid from a safety and an instrument standpoint.

5.4 Many metal salts, are extremely toxic if inhaled or swallowed.

WARNING: Exercise extreme care to ensure that samples and standards are handled safely and properly and that all exhaust gases are properly vented. Wash hands thoroughly after handling.

6.0 EQUIPMENT AND SUPPLIES

6.1 Inductively coupled plasma-mass spectrometer:

6.1.1 The system must be capable of providing resolution, better than or equal to 1.0 u (unified atomic mass unit) at 10% peak height. The system must have a mass range from at least 6 to 240 u and a data system that allows corrections for isobaric interferences and the application of the internal standard technique. Use of a mass-flow controller for the nebulizer argon and a peristaltic pump for the sample solution are recommended.

6.1.2 Argon gas, high-purity grade (99.99%).

6.2 Volumetric flasks of suitable material composition, precision and accuracy

6.3 Volumetric pipets of suitable material composition, precision and accuracy

This section does not list all common laboratory ware (e.g., beakers) that might be used.

7.0 REAGENTS AND STANDARDS

7.1 Reagent-grade, and whenever necessary, ultra-high purity-grade chemicals, must be used in all tests. Unless otherwise indicated, it is intended that all reagents conform to the specifications of the Committee on Analytical Reagents of the American Chemical Society, where such specifications are available. Other grades may be used, provided it is first ascertained that the reagent is of sufficiently high purity to permit its use without lessening the accuracy of the determination.

7.2 Reagent water - Reagent water must be interference free. All references to water in this method refer to reagent water unless otherwise specified.

7.3 Ultra high-purity or equivalent acids must be used in the preparation of standards and for sample processing. Redistilled acids are recommended because of the high sensitivity of ICP-MS. Nitric acid at less than 2% (v/v) is necessary for ICP-MS to minimize damage to the interface and to minimize isobaric molecular-ion interferences with the analytes. Many more molecular-ion interferences are observed when hydrochloric and sulfuric acids are used (Refs. 3 and 4). The use of 1% (v/v) HCl is necessary for the stability of antimony and silver concentrations in the range of 50 - 500 µg/L. For concentrations greater than 500 µg/L silver, additional HCl will be needed. As a consequence, the accuracy of analytes that need significant chloride molecular-ion corrections (e.g., As and V) will degrade.

7.3.1 Nitric acid (concentrated), HNO₃

7.3.2 Nitric acid (50% [v/v]), HNO₃ - Prepare by adding 500 mL concentrated HNO₃ to 400 mL water and diluting to 1 L.

7.3.3 Nitric acid (1% [v/v]), HNO₃ - Prepare by adding 10 mL concentrated HNO₃ to 400 mL water and diluting to 1 L.

7.3.4 Hydrochloric acid (concentrated), HCl

7.3.5 Hydrochloric acid (37%), HCl - Prepare by adding 370 mL concentrated HCl to 400 mL water and diluting to 1L.

7.3.6 Hydrofluoric acid (concentrated), HF

7.3.7 Phosphoric acid (concentrated), H₃PO₄

7.3.8 Phosphoric acid (85% [v/v]), H_3PO_4 - Prepare by adding 850 mL concentrated H_3PO_4 to 100 mL water and diluting to 1 L.

7.3.9 Sulfuric acid (concentrated), H_2SO_4

7.3.10 Sulfuric acid (96% [v/v]) H_2SO_4 , - Prepare by adding 40 mL water to a 2 L glass beaker. While gently stirring, carefully add 960 mL concentrated H_2SO_4 to the beaker. Mix until combined. Allow to cool. Carefully, quantitatively transfer solution to a 1-L volumetric flask. Bring to volume with additional water if necessary. Mix thoroughly through inversion to combine.

WARNING: Considerable heat is generated upon combining sulfuric acid and water. The use of appropriate personal protection (e.g. proper gloves, safety glasses and protective clothing) is necessary to avoid personal injury such as thermal burns or acid burns due to solution splatter. Also, always add acid to water (rather than water to acid) to reduce splatter.

7.3.11 Citric acid, $HO_2CCH_2C(OH)(CO_2H)CH_2CO_2H$

7.4 Bismuth(III) oxide, Bi_2O_3

7.5 Holmium(III) carbonate pentahydrate, $Ho_2(CO_3)_3 \cdot 5H_2O$

7.6 Indium (powder), In

7.7 Lithium [6Li] carbonate (95 atom % 6Li), 6Li_2CO_3

7.8 Ammonium hexachlororhodate(III), $(NH_4)_3RhCl_6$

7.9 Scandium(III) oxide, Sc_2O_3

7.10 Terbium(III) carbonate pentahydrate, $Tb_2(CO_3)_3 \cdot 5H_2O$

7.11 Yttrium(III) carbonate, $Y_2(CO_3)_3 \cdot 3H_2O$

7.12 Ammonium hexafluorotitanate(IV), $(NH_4)_2TiF_6$

7.13 Ammonium molybdate(VI) $(NH_4)_2MoO_4$

7.14 Aluminum(III) nitrate nonahydrate, $Al(NO_3)_3 \cdot 9H_2O$

7.15 Calcium carbonate, $CaCO_3$

7.16 Iron powder, Fe

7.17 Magnesium oxide, MgO

7.18 Sodium carbonate, Na_2CO_3

7.20 Standard stock solutions - Purchase standard stock solutions from an appropriate commercial source. Otherwise, prepare them manually in the laboratory using only ultra, high-purity grade chemicals or metals ($\geq 99.99\%$ purity). See Method 6010 for instructions on preparing standard solutions from solids. Replace stock standards when succeeding dilutions for the preparation of calibration standards cannot be verified.

7.20.1 Bismuth internal standard stock solution (100 $\mu\text{g/mL}$ Bi) - Dissolve 0.1115 g Bi_2O_3 in a minimum amount of dilute HNO_3 . Add 10 mL concentrated HNO_3 and dilute to 1 L with reagent water.

7.20.2 Holmium internal standard stock solution (100 $\mu\text{g/mL}$ Ho) - Dissolve 0.1757 g $\text{Ho}_2(\text{CO}_3)_3 \cdot 5\text{H}_2\text{O}$ in 10 mL reagent water and 10 mL concentrated HNO_3 . After dissolution is complete, warm the solution to degas. Add 10 mL concentrated HNO_3 and dilute to 1 L with reagent water.

7.20.3 Indium internal standard stock solution (100 $\mu\text{g/mL}$ In) - Dissolve 0.1000 g indium in 10 mL concentrated HNO_3 . Dilute to 1 L with reagent water.

7.20.4 Lithium internal standard stock solution (100 $\mu\text{g/mL}$ ^6Li) - Dissolve 0.6312 g $^6\text{Li}_2\text{CO}_3$ (95% atomic abundance) in 10 mL of reagent water and 10 mL concentrated HNO_3 . After dissolution is complete, warm the solution to degas. Add 10 mL concentrated HNO_3 and dilute to 1 L with reagent water.

7.20.5 Rhodium internal standard stock solution (100 $\mu\text{g/mL}$ Rh) - Dissolve 0.3593 g $(\text{NH}_4)_3\text{RhCl}_6$ in 10 mL reagent water. Add 100 mL concentrated HCl and dilute to 1 L with reagent water.

7.20.6 Scandium internal standard stock solution (100 $\mu\text{g/mL}$ Sc) - Dissolve 0.15343 g Sc_2O_3 in 10 mL 50% hot HNO_3 . Add 5 mL concentrated HNO_3 and dilute to 1 L with reagent water.

7.20.7 Terbium internal standard stock solution (100 $\mu\text{g/mL}$ Tb) - Dissolve 0.1828 g $\text{Tb}_2(\text{CO}_3)_3 \cdot 5\text{H}_2\text{O}$ in 10 mL 50% HNO_3 . After dissolution is complete, warm the solution to degas. Add 5 mL concentrated HNO_3 and dilute to 1 L with reagent water.

7.20.8 Yttrium internal standard stock solution (100 $\mu\text{g/mL}$ Y) - Dissolve 0.2316 g $\text{Y}_2(\text{CO}_3)_3 \cdot 3\text{H}_2\text{O}$ in 10 mL 50% HNO_3 . Add 5 mL concentrated HNO_3 and dilute to 1 L with reagent water.

7.20.9 Titanium interference stock solution (100 $\mu\text{g/mL}$ Ti) - Dissolve 0.4133 g $(\text{NH}_4)_2\text{TiF}_6$ in reagent water. Add 2 drops concentrated HF and dilute to 1 L with reagent water.

7.20.10 Molybdenum interference stock solution (100 $\mu\text{g/mL}$ Mo) - Dissolve 0.2043 g $(\text{NH}_4)_2\text{MoO}_4$ in reagent water. Dilute to 1 L with reagent water.

7.20.11 Gold preservative stock solution for mercury (100 µg/mL Au) - Purchase as a commercially prepared, high-purity solution of AuCl₃ in dilute HCl matrix.

7.21 Mixed-calibration standard solutions - Prepare by diluting stock standard solutions to levels in the linear range for the instrument, using the same combination and concentrations of acids used in the preparation of the sample digestates (approximately 1% HNO₃). The calibration standard solutions must contain a suitable concentration of an appropriate internal standard for each analyte. Internal standards may be added on-line at the time of analysis using a second channel of the peristaltic pump and an appropriate mixing manifold. Generally, an internal standard should be no more than 50 u removed from the analyte. Recommended internal standards include ⁶Li, ⁴⁵Sc, ⁸⁹Y, ¹⁰³Rh, ¹¹⁵In, ¹⁵⁹Tb, ¹⁶⁹Ho, and ²⁰⁹Bi. Prior to preparing the mixed standards, each stock standard solution must be analyzed separately to determine possible spectral interferences or the presence of impurities.

NOTE: Care should be taken when preparing the calibration standards to ensure that the elements are compatible and stable when mixed together. Standards which interfere with another analyte, or which are contaminated with another analyte, may not be included in the same calibration standard as that analyte.

Transfer the mixed-standard solutions to an appropriate container for storage. Freshly mixed standards must be prepared as needed with the realization that concentrations can change upon aging. Calibration standards must be initially verified using a QC standard (see Sec. 7.24).

7.22 Blanks - Three types of blanks are necessary for analysis: (1) the calibration blank, which is used in establishing the calibration curve; (2) the method blank, which is used to monitor for possible contamination resulting from the sample preparation procedure; and (3) the rinse blank, which is used to flush the system between all samples and standards.

7.22.1 Calibration blank - Prepare by acidifying reagent water using the same combination and concentrations of acids used in the preparation of the matrix-matched calibration standards (Sec. 7.21) along with the selected concentrations of internal standards, such that there is an appropriate internal standard element for each of the target analytes. The use of HCl for antimony and silver is discussed in Sec. 7.3. The calibration blank will also be used for all initial calibration blank (ICB) and continuing calibration blank (CCB) determinations.

7.22.2 Method blank — Prepare by a processing either a volume of reagent water equal to that used for actual aqueous samples, or, otherwise, a clean, empty container, equivalent to that used for actual solid samples through all of the preparatory and instrument determination steps used for making ICP-MS determinations in samples. These steps may include, but are not limited to, pre-filtering, digestion, dilution, filtering, and analysis (refer to Sec. 9.5).

7.22.3 Rinse blank - Prepare as a 1 - 2% HNO₃ solution. Prepare a sufficient quantity such that it may be used to flush the system in between standards and samples. If mercury is to be analyzed, the rinse blank should also contain 2 µg/mL AuCl₃.

7.23 Spectral interference check (SIC) solutions - Prepare so as to contain known concentrations of interfering elements that will demonstrate the appropriate magnitude of interferences and provide an adequate test of any corrections. Chloride in the SIC solution provides a means to evaluate software corrections for chloride-related interferences such as $^{35}\text{Cl}^{16}\text{O}^+$ on $^{51}\text{V}^+$ and $^{40}\text{Ar}^{35}\text{Cl}^+$ on $^{75}\text{As}^+$. Iron is used to demonstrate adequate resolution of the spectrometer for the determination of manganese. Molybdenum serves to indicate oxide effects on cadmium isotopes. The other components are present to evaluate the ability of the measurement system to correct for various molecular-ion isobaric interferences. The SIC is used to verify that the interference levels are corrected by the data system within appropriate QC limits.

NOTE: The final SIC solution concentrations in Table 1 are intended to evaluate corrections for known interferences on only the analytes identified in Sec. 1.0. If the test method is to be used to determine other element(s), it is the responsibility of the analyst to modify the SIC solution accordingly, or prepare an alternative SIC solution, so as to allow adequate verification of interference corrections on the additional element(s) (see Sec. 9.9).

7.23.1 Mixed stock SIC solutions - Prepare the SIC stock solutions using only ultra-pure reagents. They can be obtained commercially or prepared using the following procedures:

7.23.1.1 Mixed SIC stock solution I - Prepare by adding 13.903 g $\text{Al}(\text{NO}_3)_3 \cdot 9\text{H}_2\text{O}$, 2.498 g CaCO_3 (previously dried at 180 EC for 1 hr), 1.000 g Fe, 1.658 g MgO, 2.305 g Na_2CO_3 and 1.767 g K_2CO_3 to 25 mL of reagent water. Slowly add 40 mL of (50%) HNO_3 . After dissolution is complete, warm the solution to degas. Cool and dilute to 1 L with reagent water.

7.23.1.2 Mixed SIC stock solution II - Prepare by slowly adding 7.444 g 85% H_3PO_4 , 6.373 g 96% H_2SO_4 , 40.024 g 37% HCl, and 10.664 g citric acid ($\text{C}_6\text{O}_7\text{H}_8$) to 100 mL of reagent water. Dilute to 1 L with reagent water.

7.23.2 Mixed working SIC solution - Prepare by combining 10.0 mL of SIC stock solution I, 2.0 mL each of 100- $\mu\text{g}/\text{mL}$ titanium stock solution and 100- $\mu\text{g}/\text{mL}$ molybdenum stock solution, and 5.0 mL of SIC stock solution II. Dilute to 100 mL with reagent water. Prepare fresh weekly.

7.24 Initial calibration verification (ICV) standard - Prepare by combining compatible metals from standard stock solution sources that differ from those used for the preparation of the calibration standards. The ICV should be prepared so as to contain metal concentrations that are near, but not equal to, the midpoint concentration level of the calibration curve.

7.25 Continuing calibration verification (CCV) standard - Prepare using the same acid matrix and stock standards employed when preparing the calibration standards. The CCV should be prepared so as to contain metal concentrations equal or nearly equivalent to the midpoint concentration of the calibration curve.

7.26 Mass spectrometer tuning solution - Prepare so as to contain elements that represent all of the mass regions of interest (i.e., 10 $\mu\text{g}/\text{L}$ Li, Co, In, and Tl) in order to verify that

7.27 If the determination of one or more metals using a non-aqueous solvent is required, then all standards and quality control samples must be prepared on a weight/weight basis in the non-aqueous solvent since the density of non-aqueous solvents is not uniform. Standards and quality control materials containing organometallic materials that are soluble in non-aqueous solvents are available from a variety of vendors.

8.0 SAMPLE COLLECTION, PRESERVATION, AND STORAGE

Sample collection, preservation and storage requirements may vary by EPA program and may be specified in a regulation or project planning document that requires compliance monitoring for a given contaminant. Where such requirements are specified in the regulation, follow those requirements. In the absence of specific regulatory requirements, use the following information as guidance in determining the sample collection, preservation and storage requirements.

See Chapter Three, Inorganic Analytes, for sample collection and preservation instructions.

9.0 QUALITY CONTROL

9.1 Refer to Chapter One for guidance on quality assurance (QA) and QC protocols. When inconsistencies exist between QC guidelines, method-specific QC criteria take precedence over those criteria given in Chapter One. Any effort involving the collection of analytical data should include development of a structured and systematic planning document, such as a Quality Assurance Project Plan (QAPP) or a Sampling and Analysis Plan (SAP), which translates project objectives and specifications into directions for those that will implement the project and assess the results. Each laboratory should maintain a formal quality assurance program. The laboratory should also maintain records to document the quality of the data generated. All data sheets and QC data should be maintained for reference or inspection.

9.2 Refer to Methods 3005, 3010, 3015, 3031, 3040, 3050, 3051, 3052, 7000, and 6800 for QC procedures to ensure the proper operation of the various sample preparation techniques. Any more specific QC procedures provided in this method will supersede those noted in Methods 3005, 3010, 3015, 3031, 3040, 3050, 3051, 3052, 7000, and 6800.

9.3 Instrument Detection Limits

Instrument detection limits (IDLs) are useful means to evaluate the instrument noise level and response changes over time for each analyte from a series of reagent blank analyses to obtain a calculated concentration. They are not to be confused with the lower limit of quantitation, nor should they be used in establishing this limit. It may be helpful to compare the calculated IDLs to the established lower limit of quantitation, however, it should be understood that the lower limit of quantitation needs to be verified according to the guidance in Sec. 9.8. IDLs in $\mu\text{g/L}$ can be estimated as the mean of the blank result plus three times the standard

Page 14 deviation of 10 replicate analyses of the reagent blank solution. (Use zero for the mean if the mean is negative). Each measurement should be performed as though it were a separate analytical sample (i.e., each measurement must be followed by a rinse and/or any other procedure normally performed between the analysis of separate samples). IDLs should be determined at least once using new equipment, after major instrument maintenance such as changing the detector, and/or at a frequency designated by the project. An instrument log book should be kept with the dates and information pertaining to each IDL performed.

9.4 Initial demonstration of proficiency

Each laboratory must demonstrate initial proficiency with each sample preparation and determinative method combination by generating data of acceptable precision and bias for target analytes in a clean matrix. If an autosampler is used to perform sample dilutions, before using the autosampler to dilute samples, the laboratory should satisfy itself that those dilutions are of equivalent or better accuracy than is achieved by an experienced analyst performing manual dilutions. It is recommended that the laboratory should repeat the demonstration of proficiency whenever new staff members are trained or significant changes in instrumentation are made.

9.5 Initially, before processing any samples, the analyst should demonstrate that all parts of the equipment that come into direct contact with the sample and reagents are interference-free. This is accomplished through the analysis of a method blank. As a continuing check, each time samples are digested and analyzed, and when there is a change in reagents, a method blank should be prepared and analyzed for the compounds of interest as a safeguard against chronic laboratory contamination. If an interference is observed that would prevent the determination of the target analyte, determine the source and eliminate it, if possible, before processing the samples. The method blank should be carried through all stages of sample preparation and instrument determination procedures. When new reagents or chemicals are received, the laboratory should monitor the preparation and/or analysis blanks associated with samples for any signs of contamination. It is not necessary to test every new batch of reagents or chemicals prior to sample preparation if the source shows no prior problems. However, if reagents are changed during a preparation batch, separate blanks need to be prepared for each set of reagents.

9.6 Linear range

The linear range establishes the highest concentration that may be reported without diluting the sample. Following calibration, the laboratory may choose to analyze a standard at a higher concentration than the high standard in the calibration. The standard must recover within 10% of the true value, and if successful, establishes the linear range. The linear range standards must be analyzed in the same instrument run as the calibration they are associated with (i.e., on a daily basis) but may be analyzed anywhere within that run. If a linear range standard is not analyzed for any specific element, the highest standard in the calibration becomes the linear range.

9.7 Sample QC for preparation and analysis

The laboratory must also have procedures for documenting the effect of the matrix on method performance (precision, bias, and sensitivity). At a minimum, this should include the

Page 15 analysis of QC samples including a method blank, a matrix spike (MS), a laboratory control sample (LCS), and a duplicate sample in each analytical batch. Any method blanks, LCS, MS samples, and duplicate samples should be subjected to the same preparatory and instrument determination procedures as those used on actual samples (see Sec. 11.0).

9.7.1 For each batch of samples analyzed, at least one method blank must be carried throughout the entire sample preparation and instrument determination process, as described in Chapter One. The importance of the method blank is to aid in identifying when and/or if sample contamination is occurring. The method blank is considered to be acceptable if it does not contain the target analytes at concentration levels that exceed the acceptance limits defined in Chapter One or in the project-specific DQOs. The laboratory should not subtract the results of the method blank from those of any associated samples. Such "blank subtraction" is not reliable because it is based on a single method blank value rather than a statistically determined blank concentration.

Blanks are generally considered to be acceptable if target analyte concentrations are less than $\frac{1}{2}$ the LLOQ or are less than project-specific requirements. Blanks may contain analyte concentrations greater than acceptance limits if the associated samples in the batch are unaffected (i.e. targets are not present in samples or sample concentrations are $\geq 10X$ the blank). Other criteria may be used depending on the needs of the project.

If the method blank fails to meet the necessary acceptance criteria, it should be re-analyzed once. If still unacceptable, then all samples associated with the method blank must be re-prepared and re-analyzed, along with all other appropriate analysis batch QC samples. If the method blank results do not meet the acceptance criteria and reanalysis is not practical, then the laboratory should report the sample results along with the method blank results, and provide a discussion of the potential impact of the contamination on the sample results. However, if an analyte of interest is found in a sample in the batch near its concentration confirmed in the blank, the presence and/or concentration of that analyte should be considered suspect and may require qualification. Refer to Chapter One for additional guidance regarding the proper protocol when analyzing method blanks.

9.7.2 Documenting the effect of the matrix should include the analysis of at least one MS and one duplicate unspiked sample or one matrix spike/matrix spike duplicate (MS/MSD) pair for each batch of samples processed, at a minimum frequency of one per every 20 samples, as described in Chapter One. An MS/MSD pair is used to document the bias and precision of a method in a given sample matrix. The decision on whether to prepare and analyze duplicate samples or an MS/MSD pair must be based on knowledge of the samples in the analysis batch. If samples are expected to contain target analytes above the LLOQ, laboratories may choose to use an MS and a duplicate analysis of an unspiked field sample. If samples are not expected to contain target analytes above the LLOQ, the laboratories should use an MS/MSD pair.

MS/MSD samples should be spiked with each target element at the project-specific action levels, or, when lacking project-specific action levels, between the low- and mid-level standards, as appropriate. Acceptance criteria should be set at laboratory-derived limits, developed through the use of historical analyses, for each matrix type being analyzed. However, historically derived acceptance limits must not exceed $\pm 25\%$

recovery of the target element spike values for bias, and ≤ 20 relative percent difference (RPD) for precision. In the absence of historical data, MS/MSD acceptance limits should be set at $\pm 25\%$ recovery and ≤ 20 RPD. Refer to Sec. 4.0 of Chapter One for further guidance. If the bias and precision indicators in an analytical batch fail to meet the acceptance criteria, then the interference test discussed in Sec. 9.10 should be performed. Refer to the definitions of bias and precision, in Chapter One, for the proper data reduction protocols.

NOTE: If the background sample concentration is very low or non-detect, a spike of greater than 5 times the background concentration is still acceptable. To assess data precision with duplicate analyses, it is preferable to use a high concentration field sample to prepare unspiked laboratory duplicates for metals analyses.

Calculate the RPD between duplicate or MS determinations as follows:

$$\text{RPD} = \frac{|D_1 - D_2|}{\left(\frac{|D_1 + D_2|}{2}\right)} \times 100$$

where:

RPD = relative percent difference

D_1 = MS or first sample analysis value

D_2 = MSD or duplicate sample analysis value

9.7.3 At least one LCS should be prepared and analyzed with each batch of analytical samples processed, at a minimum frequency of one LCS per every 20 samples, as described in Chapter One. The LCS consists of an aliquot of a clean (control) matrix similar to the sample matrix and of the same weight or volume. The LCS should be spiked at the same levels and using the same spiking materials as the corresponding MS/MSD (see above Sec. 9.7.2). When the results of the MS analysis indicate a potential problem due to the sample matrix itself, the LCS results are used to verify that the laboratory can acceptably perform the analysis in a clean matrix.

LCS acceptance criteria should be set at laboratory-derived limits, developed through the use of historical analyses. However, historically derived acceptance limits must not exceed $\pm 20\%$ of the target element spike values. In the absence of historical data, LCS acceptance limits should be set at $\pm 20\%$. If the result of an LCS does not meet the established acceptance criteria, it should be re-analyzed once. If still unacceptable, then all samples associated with the LCS must be re-prepared and re-analyzed, along with all other appropriate analysis batch QC samples.

9.7.4 Reference materials containing known amounts of target elements are recommended when an appropriately similar medium of interest are available as one type of QC after appropriate sample preparation. The reference material may be used as the LCS. For soil reference materials, the manufacturers' established acceptance criterion should be used. For solid reference materials, $\pm 20\%$ (see Sec. 9.7.3) recovery of the reported manufacturers' target element values may not be achievable. Refer to Chapters One and Three for additional information.

9.8 Lower Limit of Quantitation (LLOQ) check standard

9.8.1 The laboratory should establish the LLOQ as the lowest point of quantitation which, in most cases, is the lowest concentration in the calibration curve. The LLOQ is initially verified by the analysis of at least 7 replicate samples, spiked at the LLOQ and processed through all preparation and analysis steps of the method. The mean recovery and relative standard deviation of these samples provide an initial statement of precision and accuracy at the LLOQ. In most cases the mean recovery should be +/- 35% of the true value and RSD should be $\leq 20\%$. In-house limits may be calculated when sufficient data points exist. Monitoring recovery of LLOQ over time is useful for assessing precision and bias. Refer to a scientifically valid and published method such as Chapter 9 of Quality Assurance of Chemical Measurements (Taylor 1987) or the Report of the Federal Advisory Committee on Detection and Quantitation Approaches and Uses in Clean Water Act Programs (<http://water.epa.gov/scitech/methods/cwa/det/index.cfm>) for calculating precision and bias for LLOQ.

9.8.2 Ongoing LLOQ verification, at a minimum, is on a quarterly basis to validate quantitation capability at low analyte concentration levels. This verification may be accomplished either with clean control material (e.g., reagent water, method blanks, Ottawa sand, diatomaceous earth, etc.) or a representative sample matrix (free of target compounds). Optimally, the LLOQ should be less than the desired regulatory action levels based on the stated project-specific requirements.

9.9 Verify the magnitude of elemental and molecular-ion isobaric interferences and the adequacy of any corrections at the beginning of an analytical run or once every 12 hours of continuing sample analysis, whichever is more frequent. Do this by analyzing the SIC solution. Results for the unspiked elements in the SIC solution should be less than 2 times the LLOQ. Note that it may not be possible to obtain SIC spiking solutions that are completely free of the unspiked elements. If the presence and concentration of an unspiked element can be confirmed via vendor documentation and/or determination of multiple isotopes of the element in the correct ratios, the concentration actually present may be subtracted from the determined value prior to comparing to the LLOQ limits. Refer to Sec. 4.0 for a discussion on interferences and potential solutions to those interferences if additional guidance is needed.

9.10 The intensities of each internal standard must be monitored for every analysis to ensure that it does not decrease below 30%, with respect to its intensity during the initial calibration. If this occurs, a significant matrix effect must be suspected. Under these conditions, the IDL has degraded, and therefore the correction capability of the internal-standardization technique must then be questioned. If this happens, perform the following procedure:

9.10.1 Make sure the instrument has not drifted by observing the internal standard intensities in the nearest clean matrix, i.e., the calibration blank. If the low internal standard intensities are also observed in the nearby calibration blank, terminate the analysis, correct the problem, recalibrate the instrument, verify the new calibration, and reanalyze the affected samples.

9.10.2 If drift has not been demonstrated to occur as outlined in Sec. 9.10.1, matrix effects need to be removed by diluting the affected sample. Dilute the sample five-

fold (1:5), taking into consideration the need to add the appropriate amounts of internal standards, and reanalyze. If the first dilution does not eliminate the problem, repeat the dilution procedure in an iterative fashion, using ever-increasing dilutions, until the internal-standard intensities exceed the 30% acceptance limit. Correct the reported results using the appropriate dilution factors.

9.11 To obtain analyte data of known quality, it is necessary to measure more than the analytes of interest in order to apply corrections or to determine whether interference corrections are necessary. For example, tungsten oxide molecular-ion species can be very difficult to distinguish from mercury isotopes. If the concentrations of interference sources (such as C, Cl, Mo, Zr, W) are such that, at the correction factor, the analyte is less than the LLOQ and the concentration of interferents are insignificant, then the data may go uncorrected.

NOTE: Monitoring the interference sources does not inevitably necessitate monitoring of the interferant itself, but that a molecular species may be monitored to indicate the presence of the interferent.

When correction equations are used, all QC criteria must also be met. Extensive QC for interference corrections is needed at all times. The monitored masses must include those elements whose hydrogen, oxygen, hydroxyl, chlorine, nitrogen, carbon and sulfur molecular ions could impact the analytes of interest. Unsuspected interferences may be detected by adding pure major matrix components to a sample to observe any impact on the analyte signals. When an interference source is present, the sample elements impacted must be flagged to indicate (a) the percentage interference correction applied to the data; or (b) an uncorrected interference, by virtue of the elemental equation used for quantitation. The isotope proportions for an element or molecular-ion cluster provide information useful for QA.

NOTE: Only isobaric elemental, molecular, and doubly charged interference corrections, which employ the observed isotopic-response ratios or parent-to-oxide ratios (provided an oxide internal standard is used as described in Sec. 4.2) for each instrument system, are acceptable corrections for use in this method.

9.12 It is recommended that the laboratory adopt additional QA practices for use with this method. The specific practices that are most productive depend upon the needs of the laboratory and the nature of the samples. Whenever possible, the laboratory should analyze reference materials and participate in relevant performance evaluation (PE) studies.

9.13 If less than acceptable bias and precision data are generated for the matrix spike(s), the additional QC protocols in Sections 9.13.1 and/or 9.13.2 should be performed prior to reporting concentration data for the elements in this method. At a minimum these tests should be performed with each batch of samples prepared/analyzed with corresponding unacceptable data quality results. If matrix interference effects are confirmed, then an alternative test method should be considered or the current test method modified, so that the analysis is not affected by the same interference. The use of a standard-addition analysis procedure may also be used to compensate for this effect (refer to Method 7000).

9.13.1 Dilution test

If the analyte concentration is within the linear range of the instrument and sufficiently high (minimally, a factor of 25 times greater than the LLOQ), an analysis of a 1:5 dilution should agree to within $\pm 20\%$ of the original determination. If not, then a chemical or physical interference effect must be suspected. The matrix spike is often a good choice of sample for the dilution test, since reasonable concentrations of most analytes are present. Elements that fail the dilution test are reported as estimated values.

9.13.2 Post-digestion MS

If a high concentration sample is not available for performing the dilution test, then a post-digestion MS should be performed. The test only needs to be performed for the specific elements that failed original matrix spike limits, and only if the spike concentration added was greater than the concentration determined in the unspiked sample. Following preparation, which may include, but is not limited to, pre-filtration, digestion, dilution and filtration, an aliquot, or dilution thereof, should be obtained from the final aqueous, unspiked-analytical sample, and spiked with a known quantity of target elements. The spike addition should be based on the indigenous concentration of each element of interest in the sample. The recovery of the post-digestion MS should fall within a $\pm 25\%$ acceptance range, relative to the known true value, or otherwise within the laboratory-derived acceptance limits. If the post-digestion MS recovery fails to meet the acceptance criteria, the sample results must be reported as estimated values.

9.14 Ultra-trace analysis necessitates the use of clean chemistry practices. Several suggestions for the reduction of contaminants in the analytical blank are provided in Chapter Three, Inorganic Analytes.

10.0 CALIBRATION AND STANDARDIZATION

10.1 Conduct mass calibration and resolution verification checks in the mass regions of interest using the mass spectrometer tuning solution (Sec. 7.26). The mass calibration and resolution verification acceptance criteria must be met prior to the analysis of samples. If the mass calibration differs by more than 0.1 u from the true value, then the mass calibration must be adjusted to the correct value. The resolution must also be verified to be less than 0.9 u full width at 10% peak height.

10.2 At a minimum, the elements required for the project plus any required for interference correction must be calibrated. Recommended isotopes for the analytes in Sec. 1.2 are provided in Table 2. Flush the system in between each standard and sample using the rinse blank (Sec. 7.22.3). The rinse time needs to be sufficient to ensure that analytes present in the linear range are effectively cleaned out prior to analysis of the subsequent sample. Use the average of at least three readings (of a single injection) for both calibration standard and sample analyses.

10.3 Calibration standards should be prepared on an as-needed basis unless stability warrants preparing fresh daily, (or each time a batch of samples is analyzed). If the ICV standard is prepared daily and the results of the ICV analyses meet the acceptance criteria,

Page 20 then the calibration standards do not need to be prepared daily and may be prepared and stored for as long as the calibration standard viability can be verified through the use of the ICV. If the ICV fails to meet the acceptance criteria, trouble shoot the situation, and then prepare a new set of calibration standards if needed and recalibrate the instrument

10.4 A calibration curve must be analyzed daily. The instrument may be calibrated using a single point standard and a calibration blank (ICB) or a multipoint calibration curve. If a multipoint curve is used a minimum of three standards are required and the correlation coefficient (r) should be ≥ 0.995 or the coefficient of determination (r^2) should be ≥ 0.990 . Relative Standard Error may be used as an alternative to r or r^2 , and should be $\leq 20\%$. If a multipoint calibration is used the low standard must be at or below the LLOQ.

NOTE: Inversely weighted linear regressions or other methods may be used in order to minimize curve fitting errors at the low end of the calibration curve.

10.5 After the initial calibration is completed it is verified using several checks.

10.5.1 Initial Calibration Verification (ICV) - The ICV is a standard prepared from a different source than the initial calibration standards. It is analyzed at approximately the mid-level of the calibration and serves as a check that the initial calibration standards are at the correct concentrations. The acceptance range is 90-110% of the true value.

10.5.2 Low-level readback or verification - For a multi-point calibration, the low level standard should quantitate to within 80-120% of the true value. For a single point calibration, a standard from the same source as the calibration standard and at or below the LLOQ is analyzed and should recover within 80-120% of the true value.

10.5.3 Mid-level readback or verification - For a multi-point calibration, the mid-level standard should quantitate to within 90-110% of the true value. For a single point calibration, a standard from the same source as the calibration standard and at the mid-point of the linear range is analyzed and should recover within 90-110% of the true value.

10.5.4 Initial Calibration blank (ICB) - If a multi-level calibration is used, an ICB is analyzed immediately after the calibration (or after the ICV) and must not contain target analytes above half the LLOQ. If a single point calibration is used, the calibration is forced through the ICB, but a second ICB is analyzed as a check and must not contain target analytes above half the LLOQ. If the ICB consistently has target analyte concentrations greater than half the LLOQ, the LLOQ should be re-evaluated.

NOTE: After cleaning the sampler and skimmer cones, improved performance in calibration stability has been observed by method users if the instrument is exposed to the SIC solution. Improved performance has also been observed if the instrument is allowed to rinse for 5 - 10 minutes before starting the calibration process.

10.5.5 Verify the ongoing validity of the calibration curve after every 10 samples, and at the end of each analysis batch run, through the analysis of a CCV standard (Sec. 7.25) and a CCB (Sec. 7.22.1). For the curve to be considered valid the analysis result of the CCV standard must be within $\pm 10\%$ of its true value and the CCB must not contain target analytes above the LLOQ. If the calibration cannot be verified, sample analysis

must be discontinued, the cause of the problem determined and the instrument recalibrated. All samples following the last acceptable CCV standard must be reanalyzed. Flow-injection systems may be used as long as they can meet the performance criteria of the method.

11.0 PROCEDURE

11.1 Preliminary treatment of most samples is necessary because of the complexity and variability of sample matrices. Groundwater samples which have been pre-filtered and acidified will not need acid digestion. Samples which are not digested must either use an internal standard or be matrix-matched with the standards (i.e., acid concentrations should match). Solubilization and digestion procedures are presented in Chapter Three, Inorganic Analytes.

NOTE: If mercury is to be analyzed, the digestion procedure must use mixed nitric and hydrochloric acids through all steps of the digestion. Mercury will be lost if the sample is digested when hydrochloric acid is not present. If it has not already been added to the sample as a preservative, Au should be added to give a final concentration of 2 mg/L (use 2.0 mL of gold preservative stock (Sec. 7.20.11) per 100 mL of sample) to preserve the mercury and to prevent it from plating out in the sample introduction system.

11.2 Initiate an appropriate operating configuration of the instrument computer according to the instrument manufacturer's instructions.

11.3 Set up the instrument with the proper operating parameters according to the instrument manufacturer's instructions.

11.4 Operating conditions

Tune the instrument by following the instructions provided by the instrument manufacturer. Allow at least 30 minutes for the instrument to equilibrate before analyzing samples.

NOTE: The instrument should have features that protect it from high ion currents. If not, precautions must be taken to protect the detector. A channel electron multiplier or active film multiplier will suffer from fatigue after being exposed to high ion currents. This fatigue can last from several seconds to hours depending on the extent of exposure. During this time period, response factors are constantly changing, which invalidates the calibration curve, causes instability, and invalidates sample analyses.

11.5 Calibrate the instrument following the procedure outlined in Sec. 10.0.

11.6 Flush the system with the rinse blank solution (Sec. 7.22.3) until the signal levels return to the data quality objectives or method LLOQs (usually about 30 seconds) before the analysis of each sample. Nebulize each sample until a steady-state signal is achieved (usually about 30 seconds) prior to collecting data.

11.7 Dilute and reanalyze samples that exceed the linear range for an analyte (or species needed for a correction) or measure an alternate, but less-abundant, isotope. The

Alternatively apply solid-phase chelation chromatography to eliminate the matrix as described in Sec. 4.3.

11.8 Determination of percent dry weight

When sample results are to be calculated on a dry-weight basis, a separate portion of sample for this determination should be weighed out at the same time as the portion used for analytical determination.

CAUTION: The drying oven should be contained in a hood or vented. Significant laboratory contamination may result from a heavily contaminated hazardous waste sample.

11.8.1 Immediately after weighing the sample aliquot to be digested, weigh an additional 5- to 10-g aliquot of the sample to the nearest 0.01g into a tared crucible. Dry this aliquot overnight at 105 EC. Allow the sample to cool in a desiccator before weighing.

11.8.2 Calculate the % dry weight as follows:

$$\% \text{ dry weight} = \frac{\text{g of dry sample}}{\text{g of sample}} \times 100$$

This oven-dried aliquot is not used for the extraction and should be appropriately disposed of once the dry weight is determined.

12.0 DATA ANALYSIS AND CALCULATIONS

12.1 If dilutions were performed, apply the appropriate corrections to the sample values.

12.2 If appropriate, or required by the project or regulation for data reporting, calculate results for solids on a dry-weight basis as follows:

$$\text{Concentration}_{DW} = \frac{C \times V}{W \times S}$$

where:

Concentration_{DW} = Concentration on a dry weight basis (mg/kg)

C = Digest concentration (mg/L)

V = Final volume after sample preparation (L)

W = Wet sample mass (kg)

S = % Solids/100 = % dry weight/100

Calculations must include appropriate interference corrections (see Sec. 4.2 for examples), internal-standard normalization, and the summation of signals at 206, 207, and 208 *m/z* for lead (to compensate for any differences in the abundances of these isotopes between samples and standards).

Performance data and related information are provided in SW-846 methods only as examples and guidance. The data do not represent required performance criteria for users of the methods. Instead, performance criteria should be developed on a project-specific basis, and the laboratory should establish in-house QC performance criteria for the application of this method. These performance data are not intended to be and must not be used as absolute QC acceptance criteria for purposes of laboratory accreditation.

Table 3 summarizes the method performance data for aqueous and sea water samples with interfering elements removed and samples preconcentrated prior to analysis. Table 4 summarizes the performance data for a simulated drinking water standard. These data are provided for guidance purposes only.

14.0 POLLUTION PREVENTION

14.1 Pollution prevention encompasses any technique that reduces or eliminates the quantity and/or toxicity of waste at the point of generation. Numerous opportunities for pollution prevention exist in laboratory operations. The EPA has established a preferred hierarchy of environmental management techniques that places pollution prevention as the management option of first choice. Whenever feasible, laboratory personnel should use pollution prevention techniques to address their waste generation. When wastes cannot be feasibly reduced at the source, the Agency recommends recycling as the next best option.

14.2 For information about pollution prevention that may be applicable to laboratories and research institutions consult *Less is Better: Laboratory Chemical Management for Waste Reduction*, a free publication available from the American Chemical Society (ACS), Committee on Chemical Safety,
http://portal.acs.org/portal/fileFetch/C/WPCP_012290/pdf/WPCP_012290.pdf.

15.0 WASTE MANAGEMENT

The Environmental Protection Agency requires that laboratory waste management practices be conducted consistent with all applicable rules and regulations. The Agency urges laboratories to protect the air, water, and land by minimizing and controlling all releases from hoods and bench operations, complying with the letter and spirit of any sewer discharge permits and regulations, and by complying with all solid and hazardous waste regulations, particularly the hazardous waste identification rules and land disposal restrictions. For further information on waste management, consult the ACS publication listed in Sec. 14.2.

1. Horlick, G., et al., *Spectrochim. Acta* 40B, 1555 (1985).
2. Gray, A.L., *Spectrochim. Acta* 40B, 1525 (1985); 41B, 151 (1986).
3. Tan, S.H., and Horlick, G., *Appl. Spectrosc.* 40, 445 (1986).
4. Vaughan, M.A., and Horlick, G., *Appl. Spectrosc.* 40, 434 (1986).
5. Holden, N.E., "Table of the Isotopes," in Lide, D.R., Ed., *CRC Handbook of Chemistry and Physics*, 74th Ed., CRC Press, Boca Raton, FL, 1993.
6. Hinnert, T.A., Heithmar, E., Rissmann, E., and Smith, D., *Winter Conference on Plasma Spectrochemistry*, Abstract THP18; p. 237, San Diego, CA (1994).
7. Lichte, F.E., et al., *Anal. Chem.* 59, 1150 (1987).
8. Evans E.H., and Ebdon, L., *J. Anal. At. Spectrom.* 4, 299 (1989).
9. Beauchemin, D., et al., *Spectrochim. Acta* 42B, 467 (1987).
10. Houk, R.S., *Anal. Chem.* 58, 97A (1986).
11. Thompson, J.J., and Houk, R.S., *Appl. Spectrosc.* 41, 801 (1987).
12. Newberry, W.R., Butler, L.C., Hurd, M.L., Laing, G.A., Stapanian, M.A., Aleckson, K.A., Dobb, D.E., Rowan, J.T., and Garner, F.C., *Final Report of the Multi-Laboratory Evaluation of Method 6020 CLP-M Inductively Coupled Plasma-Mass Spectrometry* (1989).
13. Taylor, Daniel B., Kingston, H.M., Nogay, Donald J., Koller, Dagmar, and Hutton, Robert. *On-Line Solid-phase Chelation for the Determination of Eight Metals in Environmental Waters by Inductively Coupled Plasma Mass Spectrometry*.
14. Kingston, H. M., Siriraks, A., and Riviello, J. M., Patent Number 5,126,272, "A Method and Apparatus for Detecting Transition and Rare Earth Elements in a Matrix", U.S. Patent, Filed U.S. Patent Office, March 1989, 31 pages, Granted June 30, 1992, Patent held by US Government.
15. Kingston, H. M., Siriraks, A., and Riviello, J. M., Patent Number 5,244,634 , "A Method and Apparatus for Detecting Transition and Rare Earth Elements in a Matrix", U.S. Patent , Filed U.S. Patent Office, March 1989, 31 pages, Granted Sept. 14, 1993, Patent held by US Government.
16. Dobb, David E., Rowan, J.T., and Cardenas, D., Lockheed Environmental Systems and Technologies Co., Las Vegas, NV; and Butler, L.C., and Heithmar, E.M., U.S.EPA, Las Vegas, NV; *Determination of Mercury by ICP-MS*.

18. Federal Advisory Committee on Detection and Quantitation Approaches and Uses in Clean Water Act Programs, Final Report, <http://water.epa.gov/scitech/methods/cwa/det/index.cfm> (December 28, 2007).

17.0 TABLES, DIAGRAMS, FLOW CHARTS, AND VALIDATION DATA

The pages to follow contain the tables, and figures referenced by this method.

TABLE 1

RECOMMENDED SPECTRAL INTERFERENCE CHECK (SIC) SOLUTION
COMPONENTS AND CONCENTRATIONS

Solution Component	SIC Concentration (mg/L)
Al	100.0
Ca	300.0
Fe	250.0
Mg	100.0
Na	250.0
P	100.0
K	100.0
S	100.0
C	200.0
Cl	2000.0
Mo	2.0
Ti	2.0

TABLE 2

RECOMMENDED ELEMENTAL ISOTOPES FOR SELECTED ELEMENTS

Element of Interest	Mass of Isotope
Aluminum	<u>27</u>
Antimony	121, <u>123</u>
Arsenic	<u>75</u>
Barium	138, 137, 136, <u>135</u> , 134
Beryllium	<u>9</u>
Bismuth (IS)	209
Cadmium	<u>114</u> , 112, <u>111</u> , 110, 113, 116, 106
Calcium (I)	42, 43, <u>44</u> , 46, 48
Chlorine (I)	35, 37, (77, 82) ^a
Chromium	<u>52</u> , <u>53</u> , <u>50</u> , 54
Cobalt	<u>59</u>
Copper	<u>63</u> , <u>65</u>
Holmium (IS)	165
Indium (IS)	<u>115</u> , 113
Iron (I)	<u>56</u> , <u>54</u> , <u>57</u> , 58
Lanthanum (I)	139
Lead	<u>208</u> , <u>207</u> , <u>206</u> , 204
Lithium (IS)	6 ^b , 7
Magnesium (I)	24, <u>25</u> , <u>26</u>
Manganese	<u>55</u>
Mercury	202, <u>200</u> , 199, 201
Molybdenum (I)	98, 95, 96, 92, <u>97</u> , 94, (108) ^a
Nickel	58, <u>60</u> , 62, <u>61</u> , 64
Potassium (I)	<u>39</u>
Rhodium (IS)	103
Scandium (IS)	45
Selenium	80, <u>78</u> , <u>82</u> , <u>76</u> , <u>77</u> , 74
Silver	<u>107</u> , <u>109</u>
Sodium (I)	<u>23</u>
Terbium (IS)	159
Thallium	<u>205</u> , 203
Vanadium	<u>51</u> , <u>50</u>
Tin (I)	120, <u>118</u>
Yttrium (IS)	89
Zinc	64, <u>66</u> , <u>68</u> , <u>67</u> , 70

NOTE: Method 6020 is recommended for only those analytes listed in Sec.1.2. Other elements are included in this table because they are potential interferents (labeled I) in the determination of recommended analytes, or because they are commonly used internal standards (labeled IS). Isotopes are listed in descending order of natural abundance. The most generally useful isotopes are underlined and in boldface, although certain matrices may necessitate the use of alternative isotopes.

^a These masses are also useful for interference correction (Sec. 4.2).

^b Internal standard must be enriched in the ⁶Li isotope. This minimizes interference from indigenous lithium.

TABLE 3

METHOD PERFORMANCE DATA FOR AQUEOUS AND SEA WATER SAMPLES ^a
WITH INTERFERING ELEMENTS REMOVED AND SAMPLES PRECONCENTRATED PRIOR TO ANALYSIS

ELEMENT	ISOTOPE	CONCENTRATION (ng/mL) ^b		
		9.0 mL	27.0 mL	CERTIFIED
Manganese	55	1.8±0.05	1.9±0.2	1.99±0.15
Nickel	58	0.32±0.018	0.32±0.04	0.30±0.04
Cobalt	59	0.033±0.002	0.028±0.003	0.025±0.006
Copper	63	0.68±0.03	0.63±0.03	0.68±0.04
Zinc	64	1.6±0.05	1.8±0.15	1.97±0.12
Copper	65	0.67±0.03	0.6±0.05	0.68±0.04
Zinc	66	1.6±0.06	1.8±0.2	1.97±0.12
Cadmium	112	0.020±0.0015	0.019±0.0018	0.019±0.004
Cadmium	114	0.020±0.0009	0.019±0.002	0.019±0.004
Lead	206	0.013±0.0009	0.019±0.0011	0.019±0.006
Lead	207	0.014±0.0005	0.019±0.004	0.019±0.006
Lead	208	0.014±0.0006	0.019±0.002	0.019±0.006

NOTE: Data obtained from Ref. 12.

^a The dilution of the sea-water during the adjustment of pH produced 10 mL samples containing 9 mL of sea-water and 30 mL samples containing 27 mL of sea-water. Samples containing 9.0 mL of CASS-2, n=5; samples containing 27.0 mL of CASS-2, n=3.

^b 95% confidence limits

TABLE 4

ANALYSIS OF NIST SRM 1643b - TRACE METALS IN WATER ^a

ELEMENT	ISOTOPE	CONCENTRATION (ng/mL) ^b	
		DETERMINED	CERTIFIED
Manganese	55	30±1.3	28±2
Nickel	58	50±2	49±3
Cobalt	59	27±1.3	26±1
Nickel	60	51±2	49±3
Copper	63	23±1.0	21.9±0.4
Zinc	64	67±1.4	66±2
Copper	65	22±0.9	21.9±0.4
Zinc	66	67±1.8	66±2
Cadmium	111	20±0.5	20±1
Cadmium	112	19.9±0.3	20±1
Cadmium	114	19.8±0.4	20±1
Lead	206	23±0.5	23.7±0.7
Lead	207	23.9±0.4	23.7±0.7
Lead	208	24.2±0.4	23.7±0.7

NOTE: Data obtained from Ref. 12.

^a 5.0 mL samples, n=5

^b 95% confidence limits

TABLE 5

COMPARISON OF TOTAL MERCURY RESULTS IN HEAVILY CONTAMINATED SOILS

Soil Sample	Mercury in µg/g	
	ICP-MS	CVAA
1	27.8	29.2
2	442	376
3	64.7	58.2
4	339	589
5	281	454
6	23.8	21.4
7	217	183
8	157	129
9	1670	1360
10	73.5	64.8
11	2090	1830
12	96.4	85.8
13	1080	1190
14	294	258
15	3300	2850
16	301	281
17	2130	2020
18	247	226
19	2630	2080

NOTE: Data obtained from Ref. 16.

INDUCTIVELY COUPLED PLASMA - MASS SPECTROMETRY

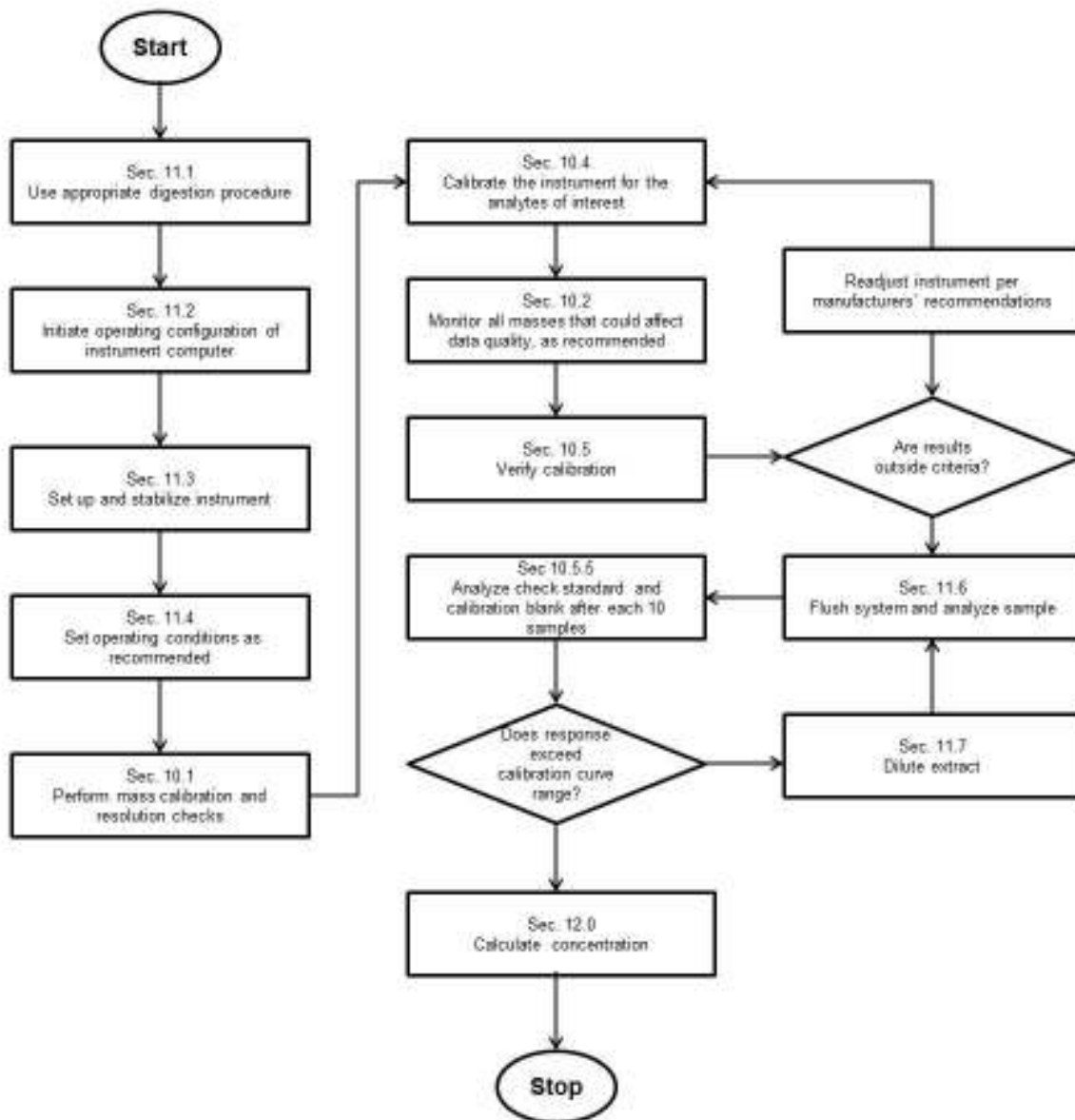

Summary of Revisions to Method 6020 (From Revision 1, February 2007):

1. Improved overall method formatting for consistency with new SW-846 methods style guidance.
2. Section 1.2 – Changed “Inductively coupled plasma—atomic emission spectrometry” to “Inductively coupled plasma—optical emission spectrometry”.
3. Section 1.6 - inserted references to additional 3000 series preparatory methods to ICP analysis. Also added method 6800 to sections 1.6 and 9.2 as a preparatory method.
4. Inserted additional safety guidance regarding the use of HF.
5. Inserted new section (7.27) regarding analysis of non-aqueous solvents.
6. Reformatted certain paragraphs with the heading "NOTE" or "WARNING" to better denote the importance of the recommendations provided therein.
7. Extensively reformatted “REAGENTS AND STANDARDS” section and to meet current SW-846 method guidelines.
8. Significantly updated and expanded “QUALITY CONTROL” section for better adherence to current SW-846 method guidelines and for improved alignment with current universal practices for published analytical methods.
9. Inserted new sections (Sections 7.23 and 9.9) to describe the preparation and use of the spectral interference check (SIC) solution; also added instructions to match the matrix of this solution to that of the calibration standards.
10. Renamed "QC standard" as "ICV standard" in Sec. 7.24.
11. Added new Sec. 7.25 describing the preparation of a "CCV" standard, consistent with the equivalent section in 6010.
12. Replaced the term “unity” with “uniform” in Section 7.27.
13. Removed all references to method 7000 except for guidance regarding the method of standard addition.
14. The term “accuracy” was replaced by “bias” where appropriate.
15. In Section 9.4, the requirement to repeat the demonstration of proficiency for new staff and instrumentation changes was changed to a recommendation.
16. Section 9.7.2 – Added a note regarding MS/MSD spike concentrations and unspiked laboratory duplicates.
17. The section regarding analysis of reference materials (Sec. 9.7.4) was revised for clarity and the term “Standard Reference Material” was replaced with “reference material” throughout the method.
18. Inserted new section (Sec. 9.8) describing the preparation and use of an LLOQ standard. This section includes two new references for guidance on assessing precision and bias.
19. The section describing matrix interference check samples (Sec. 9.13) has been revised for clarity. The post-digestion MS is only recommended if a high concentration sample is not available for performing the dilution test.
20. Substituted certain terms with new terms (i.e. “must” in place of “shall”) to conform with the Performance-based Methods Approach goal of flexibility.
21. Removed reference to “linear dynamic range” as noted by the Inorganic Methods Work Group. Section 9.6 regarding the linear range was added.
22. Mid-level read back or verification standard added to Section 10.5.3.
23. Moved the sentence “If the ICB consistently has target analyte concentrations greater than half the LLOQ, the LLOQ should be re-evaluated.” From Section 10.5.5 to Section 10.5.4.
24. Added 95 as mass of isotope for molybdenum.

Page 33 25. Tables 3 and 4 from 6020A presenting example precision and accuracy data for aqueous and solid matrices were removed.

26. Language was updated in Section 9.7.1 regarding method blanks.

Annex VI:

**Recommended Method for the
DETERMINATION OF TOTAL MERCURY IN
MARINE SAMPLES BY THERMAL
DECOMPOSITION AMALGAMATION AND
ATOMIC ABSORPTION SPECTROPHOTOMETRY**



REPORT

Recommended Method for the DETERMINATION OF TOTAL MERCURY IN MARINE SAMPLES BY THERMAL DECOMPOSITION AMALGAMATION AND ATOMIC ABSORPTION SPECTROPHOTOMETRY

IAEA/NAEL

**Marine Environmental Studies Laboratory in co-operation with
UNEP/MAP MED POL**

December 2012

For further information on this method, please contact:

IAEA-Environment Laboratories
Marine Environmental Studies Laboratory
4a Quai Antoine 1er
MC-98000 Principality of Monaco

Tel. (377) 979 772 72; Fax. (377) 979 772 73
E-mail: NAEL-MESL.Contact-Point@iaea.org

Recommended Method for the
DETERMINATION OF TOTAL MERCURY IN MARINE SAMPLES BY
THERMAL DECOMPOSITION AMALGAMATION
AND ATOMIC ABSORPTION SPECTROPHOTOMETRY

DISCLAIMER

This is not an official IAEA publication. The views expressed do not necessarily reflect those of the International Atomic Energy Agency or its Member States.

The material has not undergone an official review by the IAEA. This document should not be quoted or listed as a reference.

The use of particular designations of countries or territories does not imply any judgment by the IAEA, as to the legal status of such countries or territories, of their authorities and institutions or of the delimitation of their boundaries.

The mention of names of specific companies or products (whether or not indicated as registered) does not imply any intention to infringe proprietary rights, nor should it be construed as an endorsement or recommendation on the part of the IAEA.

Limited Distribution

Reproduced by the IAEA

TABLE OF CONTENTS

1. SCOPE	1
2. PRINCIPLE.....	1
3. SAMPLE PRE-TREATMENT	1
4. REAGENTS	2
5. MATERIAL	2
6. CALIBRATION	3
7. PROCEDURE	4
8. QUALITY CONTROL.....	6
9. CALCULATION OF RESULTS	7
10. EXPRESSION OF RESULTS	8
11. REFERENCES	8

NOTE: This method is not intended to be an analytical training manual. Therefore, this method is written with the assumption that it will be performed by formally trained analytical chemist.

In addition, the IAEA recommended methods are intended to be guidance methods that can be used by laboratories as a starting point for generating their own standard operating procedure. If performance data are included in the method, they shall not be used as absolute QC acceptance criteria.

1. SCOPE

The method hereinafter describes the protocol for the determination of total mercury (inorganic and organic) in sediment and biological material.

By using this method, the total mercury in solid samples can be determined without sample chemical pre-treatment.

The recommended protocol is mainly based on the EPA 7473 method; users are encouraged to consult this document (EPA, 2007).

2. PRINCIPLE

The sample is dried and then chemically decomposed under oxygen in the decomposition furnace. The decomposition products are carried out to the catalytic section of the furnace, where oxidation is completed (halogens and nitrogen/sulfur oxides are trapped). The mercury present in the remaining decomposition products is selectively trapped on an amalgamator. After flushing the system with oxygen, the mercury vapour is released by rapid heating of the amalgamator, and carried through the absorbance cell in the light path of a single wavelength atomic absorption spectrophotometer. The absorbance is measured at 253.7 nm as a function of mercury quantity (ng).

The typical working range is 0.1–500 ng. The mercury vapour is carried through a long (first) and a short path length absorbance cell. The same quantity of mercury is measured twice with different sensitivity resulting in a dynamic range that spans four orders of magnitude.

The typical detection limit is 0.01 ng of mercury.

3. SAMPLE PRE-TREATMENT

The sediment samples are prepared following the recommendations of UNEP (2005);

The marine organisms are prepared following the recommendations of UNEP (1984, 1994).

4. REAGENTS

The reagents used shall meet the purity requirement of the subsequent analysis

4.1. ULTRAPUR WATER (type MilliQ)

4.2. NITRIC ACID 65%

4.3. POTASSIUM DICHROMATE OXIDIZING SOLUTION (10% w/v)

Weight 25 g of $K_2Cr_2O_7$ in 250 ml glass bottle, fill it up to 250 ml with water, and shake until total dissolution of solids. Keep the bottle tightly closed in a double plastic bag, and in an Hg free environment (i.e. laminar flow hood). This solution is stable indefinitely and rarely becomes contaminated.

4.4. COMMERCIAL STANDARD SOLUTION 1000 $\mu\text{g ml}^{-1}$ MERCURY

Use a certified reference material solution; this solution should be accompanied by a certificate stipulating at minimum the traceability of the certified concentration, as well as the expiry date. The density of the solution, or the certified content in mg kg^{-1} should also be defined, to allow for the preparation of the calibration solution by weighing. Stock solutions should be kept at 5°C.

5. MATERIAL

5.1. SOLID MERCURY ANALYZER

Optionally equipped with an auto-sampler.

5.2. ANALYTICAL BALANCE

With a 0.001 g precision at least.

5.3. VOLUMETRIC CONTAINERS

Preferably in Teflon or glass.

5.4. PIPETTES

Some microliter pipettes sized ranging from 50 to 10000 μl are needed. The accuracy and precision of the pipettes used should be checked as a routine every 6 months, and the results obtained should be compared with the individual certificates.

5.5. METAL SPATULA (inox).

5.6. SAMPLE BOAT

Metal or metal alloy. Before measurement, sample boats are cleaned by heating over a flame until constant "red" to remove mercury.

5.7. OXYGEN

It should be of high purity and free of mercury. If there is a possible mercury contamination from oxygen, install a gold mesh filter between the cylinder and the instrument to prevent any mercury from entering the instrument.

6. CALIBRATION

- 6.1. PRIMARY CALIBRATION. This is the calibration of the instrument working range. This calibration is performed initially (usually done by the manufacturer and stored in the instrument), and/or when any significant instrumental parameters are changed (i.e. after maintenance).
- 6.2. PREPARE STANDARD SOLUTIONS of appropriate concentration by dilution of a commercial standard (see 4.4). It is recommended to prepare standard solution in Teflon or glass container, in 1 or 0.5% HNO₃ (see 4.2) and 0.1% (v/v) potassium dichromate (see 4.3). Fresh mercury standard should be prepared daily. Prepare a zero calibration solution using the same quantity of acid and potassium dichromate.
- 6.3. START THE INSTRUMENT according to the manufacturer recommendations.
- 6.4. CLEAN THE SYSTEM. Inject 100 µl of water and start the measurement with the recommended parameters (see 7.1). Repeat the cleaning until the absorbance is below 0.001ABS.
- 6.5. SET THE INSTRUMENT PARAMETERS (see 7.1) for selected volume (usually 100 µl) and inject the zero calibration, at least three measurements should be done. The zero solution serves to correct the amount of mercury in water and reagent used for preparing the calibration curve, hence the important of keeping the injected volume equal at all points of the calibration curve. If the amount of mercury in the zero calibration is high (i.e. more than 0.01 ng), it is recommended to check for contamination sources and to prepare new standard solution with clean acid.
- 6.6. STANDARDS ARE MEASURED from the lowest to the highest at least twice. The maximum relative standard deviation between readings should be 3% (except for zero calibration); if higher it is recommended to carry out more measurements.
- 6.7. EXAMPLE OF AMOUNTS used for recalibration (primary):

First Range:

Standard (ng ml ⁻¹)	1	3	10	30	100	300
Volume injected (µl)	100	100	100	100	100	100
Quantity of Hg (ng)	0.1	0.3	1	3	10	30

Second Range:

Standard ($\mu\text{g ml}^{-1}$)	1	2	3	4	5	6
Volume injected (μl)	100	100	100	100	100	100
Quantity of Hg (ng)	100	200	300	400	500	600

Note: The calibration of the second range might induce problems for subsequent analysis, due to the relatively high quantity of mercury introduced (especially with memory effect). It should be performed only if there is a probability of using it (i.e. measuring samples with high mercury level $> 1\mu\text{g g}^{-1}$). After the reading of the last calibration point, clean the system (see 6.4).

- 6.8. ALTERNATIVE CALIBRATION CURVE can be performed using a solid certified reference material. In this case, weigh accurately a CRM onto a tare sample boat, set up the instrument according to the sample type (see 7.1) and measure the absorbance. The matrix of the CRM should be as similar as possible to the sample of interest. Repeat this procedure with different weights of the CRM and/or with different CRM, to get results in the desired working range.
- 6.9. CONSTRUCT A CALIBRATION CURVE by plotting the absorbance against Nano grams of mercury (this could be done automatically by the software). The type of equation will depend on the levels, as the response is not linear over the entire working range.
- 6.10. DAILY CALIBRATION: calibration performed every day with a minimum number of standards to ensure that the primary calibration is valid. It can be performed by using either liquid standard (see 6.2) or solid certified reference material (CRM) see 6.8. It should be performed in the range of interest, with at least two standards (or matrix CRM) and the results should agree within the acceptance criteria. The acceptance criteria should be set through the use of historical data, but the maximum deviation should not exceed 10%.

7. PROCEDURE

7.1. GENERAL ANALYTICAL PARAMETERS

The analytical parameters will depend on the sample size and matrix, and are instrument specific. It is important to follow the guidelines from the instrument manufacturer. There are three time to set: drying, decomposition and waiting.

Some typical recommended conditions below:

Drying time:

Sample type	Dry (s)	Comments
Liquid	0.7 x injected Volume (μ l)	
Dry inorganic	10	
Organic liquid	50–300	To be optimized ¹
Dry organic (i.e. fat)	50–200	To be optimized ¹
Wet (i.e. fresh)	0.7 x weight x % moisture	Example: 100 mg with 45% moisture $0.7 \times 100 \times 0.45 = 31.5\text{s}$ (35)

¹ In the case of organic, there is a risk of explosion especially with organic liquid; to optimize set the instrument at: 300s dry/ 150s decomposition/ 45s wait, do the measurement and check for possible small explosion, note the time of the phenomenon and add to the drying time 10s more.

Decomposition time:

Sample type	Decomposition (s)	Comments
Liquid	150–400	To be optimized ¹
Solid inorganic	120 + 0.4 x sample (mg)	To be optimized ¹
Solid organic	120	

¹ Set the instrument to XX (see above) dry/ 400s decomposition/ 45s wait, run a sample and observe the results. Decrease the decomposition time by 30s and repeat measurement. Continue until you observe a significant decrease, note that time and add to the decomposition time 30s more.

Waiting time:

It is recommended to use 40–45s, except for long decomposition time (over 200s) when it is beneficial to add 10s of waiting for every 100s of decomposition.

Note: These indications above are recommended by ALTECH (AMA 254).

7.2. ANALYSIS OF A SOLID SAMPLE

Weight a sample accurately onto a tare boat, insert the boat into the instrument, set the appropriate parameters (see 7.1) and start the measurements. The results can be records on absorbance, quantity or concentration depending on the instrument software. See 9: Calculation of results.

7.3. ANALYSIS OF BLANK FOR SOLID MEASUREMENT

Analyse an empty sample boat using the same instrument settings than for the sample.

7.4. ANALYSIS OF A LIQUID SAMPLE

Dose a known volume of the sample onto a sample boat, set the appropriate parameters (see 7.1) and start the measurements. The results can be records on absorbance, quantity or concentration depending on the instrument software. See the calculation section (see 9).

7.5. ANALYSIS OF BLANK FOR LIQUID

Repeat 7.4 with the same volume of blank solution (solution that contain the same reagent and chemical than the sample).

8. QUALITY CONTROL

8.1. For every day of analysis, the CALIBRATION SHOULD BE VALIDATED by doing a daily calibration (see 6.10) before starting the measurements. The results of the daily calibration should be recorded for quality control purposes.

8.2. CERTIFIED REFERENCE MATERIAL

At least one certified reference material of a representative matrix should be measured with each batch of the sample, the calculated results should fall in the value of the certificate and within the coverage uncertainty (Linsinger, 2010), to show evidence of unbiased results. The results for the CRM should be recorded for quality control purpose and plotted in a control chart (UNEP/IOC/IAEA 1994).

8.3. A DUPLICATE OR TRIPLICATE SAMPLE should be processed on a routine basis.

A duplicate sample should be processed with each analytical batch or for every 10 samples.

8.4. A SPIKED SAMPLE should also be included, whenever a new sample matrix is being analysed, especially if no certified reference material is available for that matrix. Measure a spiked sample by adding a known volume of standard solution (prepared as in paragraph 6.2) to the sample in the boat. Keep the spike volume small enough not to overspill. The recovery of spike calculated with the equation 2 should be 85–115% (this limits should be reset after collection of historical data). If the test fails, it is recommended to check the calibration (see 6.10) and/or to revise the instrument parameters (see 7.1).

$$\text{Spike (ng)} = \text{Concentration of standard (ng/ml)} \times \text{Volume of spike (ml)} \quad \text{Equation 1}$$

$$\text{Recovery (\%)} = \frac{\text{Spiked sample (ng)} - \text{Unspiked sample (ng)}}{\text{Spike (ng)}} \times 100 \quad \text{Equation 2}$$

To be valid the quantity of Spike (equation 1) should be in the range of 50–150% the quantity of unspiked sample.

9. CALCULATION OF RESULTS

9.1. SOLID SAMPLE RESULTS are calculated using equation 3

$$w(Hg) = \frac{(\rho_1 - \rho_0)}{m} \times R \quad \text{Equation 3}$$

Where:

w(Hg) is the mass fraction of element m in the sample, expressed in mg kg⁻¹;

ρ₁ is the quantity of mercury, expressed in ng as measured in the sample;

ρ₀ is the quantity of mercury expressed in ng as measured in the blank (see 7.3);

R is the recovery calculated using the CRM (see 8.2) or spike (see 8.4);

m is the amount of sample in mg.

Note: ρ₁ and ρ₀ are calculated using calibration curve equation (usually done by software).

9.2. LIQUID SAMPLE RESULTS are calculated using equation 4

$$w(Hg) = \frac{(\rho_1 - \rho_0) \times V}{V_i \times m} \times f \times R \quad \text{Equation 4}$$

Where:

w(Hg) is the mass fraction of mercury in the sample, expressed in mg kg⁻¹;

ρ₁ is the quantity of mercury, expressed in ng as measured in the sample solution;

ρ₀ is the quantity of mercury expressed in ng as measured in the blank solution (see 7.4);

R is the recovery calculated using the CRM (see 8.2) or spike (see 8.4);

V_i is the injected volume (should be the same in sample and blank solution) in ml;

m is the amount of sample in mg;

V is the volume of solution in ml;

f is the dilution factor.

Note: ρ₁ and ρ₀ are calculated using calibration curve equation (usually done by software).

10. EXPRESSION OF RESULTS

The rounding of values will depend on the uncertainty reported with the results; in general for this method two or three significant figures should be reported.

The uncertainty component should be reported with all results. (ISO 2005, Nordtest 2004)

Example: $w(\text{Hg}) = 0.512 \pm 0.065 \text{ mg kg}^{-1}$.

11. REFERENCES

- EPA (2007). U.S. Environmental Protection Agency, EPA method 7473, Mercury in solids and solutions by thermal decomposition, amalgamation and atomic absorption spectrophotometry Rev 0, February 2007:

<http://www.epa.gov/osw/hazard/testmethods/sw846/pdfs/7473.pdf>

- ISO (1995). Guide to the expression of uncertainty of measurements International Organisation for Standardization: Geneva

- Linsinger, T. (2010). European Commission - Joint Research Centre, Institute for Reference Materials and Measurements http://www.erm-crm.org/ERM_products/application_notes/application_note_1/Documents/erm_application_note_1_english_rev3.pdf

- Nordtest (2004). Handbook For Calculation Of Measurement Uncertainty In Environmental Laboratories Edition 2 <http://www.nordicinnovation.net/nordtestfiler/tec537.pdf>

- UNEP (2005). UNEP (DEC)/MED WG.282/inf.5/Rev1, Method for sediment sampling and analysis, February 2005, UNEP.

- UNEP/IOC/IAEA (1984). Reference method 7 rev2: Sampling of selected marine organisms and sample preparation for trace metal.

- UNEP/IOC/IAEA (1994). Reference method 57: Quality assurance and good laboratory practice, UNEP, 1994.

Annex VII:

**RECOMMENDED METHOD FOR THE DETERMINATION OF TOTAL MERCURY IN
SAMPLES OF MARINE ORIGIN BY COLD VAPOUR ATOMIC ABSORPTION
SPECTROMETRY**



REPORT

RECOMMENDED METHOD FOR THE DETERMINATION OF TOTAL MERCURY IN SAMPLES OF MARINE ORIGIN BY COLD VAPOUR ATOMIC ABSORPTION SPECTROMETRY

**IAEA/NAEL Marine Environmental Studies Laboratory in co-operation with
UNEP/MAP MED POL**

December 2012

For further information on this method, please contact:

IAEA-Environment Laboratories
Marine Environmental Studies Laboratory
4a Quai Antoine 1er
MC-98000 Principality of Monaco

Tel. (377) 979 772 72; Fax. (377) 979 772 76

E-mail: NAEL-MESL.Contact-Point@iaea.org

RECOMMENDED METHOD ON THE DETERMINATION OF TOTAL MERCURY
IN SAMPLES OF MARINE ORIGIN BY COLD VAPOUR ATOMIC ABSORPTION
SPECTROMETRY

DISCLAIMER

This is not an official IAEA publication. The views expressed do not necessarily reflect those of the International Atomic Energy Agency or its Member States.

The material has not undergone an official review by the IAEA. This document should not be quoted or listed as a reference.

The use of particular designations of countries or territories does not imply any judgment by the IAEA, as to the legal status of such countries or territories, of their authorities and institutions or of the delimitation of their boundaries.

The mention of names of specific companies or products (whether or not indicated as registered) does not imply any intention to infringe proprietary rights, nor should it be construed as an endorsement or recommendation on the part of the IAEA.

Limited Distribution

Reproduced by the IAEA

TABLE OF CONTENT

1. SCOPE.....	1
2. PRINCIPLE	1
3. REAGENT	2
4. MATERIAL	3
5. INTERFERENCES	4
6. SAMPLE PREPARATION.....	5
7. PROCEDURE	6
8. CALCULATION OF RESULTS	10
9. EXPRESSION OF RESULTS	10
10. REFERENCES	10

NOTE: This method is not intended to be an analytical training manual. Therefore, the method is written with the assumption that it will be used by formally trained analytical chemists.

In addition, the IAEA recommended methods are intended to be guidance methods that can be used by laboratories as a starting point for generating their own standard operating procedure. If performance data are included in the method they must not be used as absolute QC acceptance criteria.

1. SCOPE

This method describes a protocol for measurement of total mercury by cold vapour atomic absorption spectrometry (CV-AAS). The method is simple, rapid and applicable to a large number of environmental samples. This method is applicable when the element content in the digested solution is above the method limit (~ 0.15 ng ml⁻¹ depending on instrument). The typical working range is 0.25–100 ng ml⁻¹ for direct injection of cold vapour, using “batch system”; FIAS or amalgamation accessory will give better sensitivity.

2. PRINCIPLE

The sediment or biological samples are mineralized with strong acids. The inorganic mercury is reduced to its elemental form with stannous chloride. The cold mercury vapour is then passed through the quartz absorption cell of an atomic absorption spectrometer (AAS), where its concentration is measured. The light beam of Hg hollow cathode lamp is directed through the quartz cell, into a monochromator and onto a detector that measures the amount of light absorbed by the atomized vapour in the cell. The amount of energy absorbed at the characteristic wavelength is proportional to the concentration of the element in the sample.

3. REAGENT

The reagents used shall meet the purity requirement of the subsequent analysis:

3.1. WATER

Reagent water (referenced also as water in the text) should be free of contamination.

3.2. NITRIC ACID 65%

3.3. HYDROCHLORIC ACID (37%)

3.4. HYDROGEN PEROXIDE

3.5. VANADIUM PENTOXIDE (V_2O_5)

3.6. SILICON ANTI-FOAMING

3.7. HYDROXYLAMINE HYDROCHLORIDE ($NH_2OH.HCl$)

Dissolve 12.0 g of $NH_2OH.HCl$ in 100 ml reagent water. This solution may be purified by the addition of 0.1 ml of $SnCl_2$ solution and purging 1 hour with Hg-free argon.

3.8. POTASSIUM DICHROMATE OXIDIZING SOLUTION (10% w/v)

Weight 25 g of $K_2Cr_2O_7$ in a 250 ml glass bottle, fill it up to 250 ml with water, and shake until total dissolution of the solid. Keep the bottle tightly closed in a double plastic bag, and in an Hg free environment (i.e. laminar flow hood). This solution is stable indefinitely and rarely becomes contaminated.

3.9. $BrCl$ OXIDIZING SOLUTION

Weigh accurately 11 g of $KBrO_3$ and 15 g of KBr into a clean 1 liter glass bottle. Add 200 ml of Milli-Q water; add carefully 800 ml of concentrated HCl . The dilution has to be carried out in a well-ventilated fume hood to prevent exposure to toxic fumes released during dissolution of $KBrO_3$. Keep the bottle wrapped in aluminium foil, tightly closed in a double plastic bag, and in an Hg free environment (i.e. laminar flow hood). This solution is stable indefinitely but can become contaminated.

3.10. STANNOUS CHLORINE SOLUTION 20% (w/v) in 20% (w/v) HCl

Weigh 20 g of $SnCl_2$ in a 100 ml volumetric flask; add 20 ml of concentrated HCl ; dissolve the $SnCl_2$ (if needed heat at $60^\circ C$ for a few minutes on a hot plate); complete to 100 ml with water. This solution might be purified by bubbling with Hg-free argon for 15 minutes. The obtained solution should be clear and transparent, cloudy or yellow solution indicates a bad quality $SnCl_2$. This solution should be prepared fresh every day preferably, if not it should be kept in the fridge.

Note: The concentration of this solution is dependent on the type of accessory use for vapour generation, and can vary between 5 and 30%, the recommendation of the manufacturer

should be followed (i.e. the solution above is recommended for a VGA-70 from Varian). The validity of the solution (i.e. shelf-life) should be defined during method validation.

3.11. COMMERCIAL STANDARD SOLUTION 1000 $\mu\text{g ml}^{-1}$

Use a certified reference material solution; this solution should be accompanied by a certificate stipulating at minimum the traceability of the certified concentration, as well as the expiry date. The density of the solution, or the certified content in mg kg^{-1} should also be defined, to allow for the preparation of the calibration solution by weighing. Stock solutions should be kept at 5°C.

3.12. ARGON

Use of a gas purifier cartridge for removing mercury, oxygen and organic compounds is recommended.

4. MATERIAL

This section does not list the common laboratory glassware.

4.1. ATOMIC ABSORPTION SPECTROPHOTOMETER

Instrument equipped with an appropriate cold vapour generation system and a quartz or glass tube atomizer. Use a hollow cathode lamp or, preferably, an electrodeless discharge lamp (which gives a greater and more stable light intensity), operated at a current recommended for the lamp and by the instrument manufacturer. An AAS system with background correction device is recommended.

4.2. GLASSWARE

All the glassware, polypropylene, or fluorocarbon (PFA or TFM) containers, including the sample bottles, flasks and pipettes tips, should be washed in the following sequence:

- 24 hrs soaking in a laboratory soap (or 10% alcohol);
- followed by 24 hrs soaking in 10% nitric acid;
- followed by 10% soaking in water;
- final rinse in water; and
- drying under a laminar flow hood.

The cleaned items should be kept in a double sealed plastic bag. It is better to avoid storage of low level ($< 5 \text{ ng ml}^{-1}$) solution in plastic, and for this purpose glass or Teflon is recommended.

If it can be documented, through an active analytical quality control program, using spiked samples and method blanks, then certain steps in the cleaning procedure would not be needed for routine samples, those steps may be eliminated from the procedure (i.e. for the levels

measured by flame AAS, some sterile plastic containers are sufficiently free of contamination for certain analytes).

4.3. PIPETTES

Some microliter pipettes size ranging from 50 to 10000 µl are needed. The accuracy and precision of the pipettes used should be checked as a routine every 6 months, and the results obtained should be compared with the individual certificates.

4.4. VOLUMETRIC CONTAINERS of suitable precision and accuracy.

5. INTERFERENCES

- 5.1. IODIDE, GOLD AND SILVER are known interferences for mercury determination by cold vapour. In samples from marine origin (biota or sediment), the levels of those elements are low, and consequently, do not interfere in the measurement process.
- 5.2. WATER VAPOUR (moisture) should be avoided in the measurement cell, always follow the manufacturer's protocol (e.g. use of membrane drying tube, correct position of gas separator...) and check for absence of moisture in the measurement cell.
- 5.3. When using GOLD AMALGAMATION, and with certain batch systems, the excess of oxidant can cause interference or damage the gold amalgamator, it is then recommended to pre-reduce the samples with hydroxylamine ammonium (see 3.7). This is important when using large amount of digested solution in "batch system".
- 5.4. Some samples (i.e. plants or large amount of mussels) might produce FOAM during the reduction reaction. If the amount of foam is important, it can interfere with gas liquid separation, and/or leak in the measurement cell, this phenomenon can be overcome by using silicon anti-foaming inside the gas liquid separator and/or in the "batch" system. Another option is to use vanadium pentoxide during digestion (see 6.4).
- 5.5. REDUCTION of inorganic mercury will induce loss, so it is important to stabilise all the solutions by using a strong oxidant as dichromate or BrCl (see 3.8 or 3.9).

6. SAMPLE PREPARATION

- 6.1. The sample should be prepared according to the recommended method for digestion of marine samples for the determination of trace metal (IAEA, 2011), but before diluting to the final volume (or weight) with water, add an adequate volume of potassium dichromate or BrCl to get the final concentration of 2% or 1% respectively. All the samples from marine origin (sediment or biota) can be prepared using the acid mixture recommended for fish, as Hg is not attached to silicates. For microwave digestion of sample size above 0.8 g, it is strongly recommended to do cold digestion for at least 5 hours and to use a long ramping time (i.e. 25 minutes) to avoid strong reactions in the microwave vessels.
- 6.2. If other trace elements have to be determined in the digested solution prepared according to the recommended method for digestion of marine samples for the determination of trace metal (IAEA, 2011), following the dilution to the final volume or weight, transfer a quantitatively sufficient amount of digested solution (i.e. at least 10 ml) into a separate container (preferably glass or Teflon), and add an oxidising solution 1% (v/v) of BrCl (see 3.9) or 2% (v/v) of potassium dichromate (see 3.8). Record the amount of oxidising solution added in order to calculate the dilution factor (i.e. dilution factor = 1.01 for 0.1 ml of dichromate in 10 ml).
- 6.3. Alternatively, the samples can be digested using a mixture of 5 ml of HNO₃ and 2 ml of H₂O₂ at 90°C for 4 hours on a hot plate. It is recommended to leave the samples in acid at room temperature, for at least 1 hour before heating. The digestion can be performed either in a Teflon or glass closed containers. After cooling, add an adequate volume of potassium dichromate or BrCl to get the final concentration of 2% or 1% respectively, and dilute to the final volume with water (i.e. for 50 ml final volume, add 1 ml of potassium dichromate or 0.5 ml of BrCl solution). This procedure can be used with bigger sample size if needed (i.e. 2 g); in this case, the volume of nitric acid should be increased to obtain a liquid mixture.
- 6.4. In the case that the digested solution produces foam during the reduction process (see 5.4), 45 mg of vanadium pentoxide should be added in the digestion vessels before addition of the acid mixture, then follow either paragraph 6.1 or 6.3.

7. PROCEDURE

7.1. SAMPLE SOLUTION

Use the sample prepared with one option as described in section 6.

7.2. BLANK SOLUTION

Prepare at least two blank solutions with each batch of sample, using the same procedure than for the samples.

7.3. PREPARATION OF CALIBRATION SOLUTIONS

7.3.1. Before each batch of determination, prepare by the appropriate dilution of 1000 $\mu\text{g ml}^{-1}$ stock standard solution (see 3.11), at least 4 standard solutions and one calibration blank solution, covering the appropriate range of the linear part of the curve. The calibration standards and calibration blank should be prepared using the same type of acid and oxidising solution than in the test portion (the final concentration should be similar).

7.3.2. Calibration solutions should be prepared fresh each day.

7.3.3. If the necessary intermediate stock standard solutions can be prepared in 5% nitric acid and 1% BrCl or 2% $\text{K}_2\text{Cr}_2\text{O}_7$, these solutions should be prepared monthly.

7.3.4. All volumetric material (pipettes and containers) should be of appropriate precision and accuracy, if not available standard solution can be prepared by weighing.

7.4. INSTALLATION OF VAPOUR GENERATOR ACCESSORY

7.4.1. Install the accessory according to the manufacturer's instructions. Certain systems (i.e. VGA from Varian) are designed to be used for hydride generation as well, and require in the instructions to aspirate an extra HCl solution, in the case of stannous chlorine reduction this solution is to be replaced by water. It is recommended to separate the systems used for hydride and for SnCl_2 (i.e. use a spare gas liquid separator and Teflon tubing).

7.4.2. Switch on the argon. For on-line system: start the pump, check the aspiration, and verify the gas liquid separator. If needed replace the pump tubing, clean the gas liquid separator by sonication in diluted detergent.

7.4.3. Clean the system by aspirating reagent and 10% nitric acid as a sample for about 10 minutes. For batch system, perform two cycles with 10% nitric acid.

7.4.4. Set up the atomic absorption spectrometer according to the manufacturer's instructions, at the appropriate wavelength, using the appropriate conditions, and with the suitable background correction system in operation.

7.4.5. Optimise the position of the measurement cell to get the maximum signal.

7.4.6. Connect the vapour generation system to the measurement cell.

7.5. CALIBRATION

7.5.1. Adjust the response of the instrument to zero absorbance whilst aspirating water.

NOTE: if the instrument zero reading is more than 0.002 ABS, the system should be clean again and reagent should be checked.

7.5.2. Aspirate the set of calibration solutions in ascending order, and as a zero member, the blank calibration solution. After the last standard, aspirate 10% nitric acid for 1 minute to rinse the system.

NOTE: The calibration curve is automatically plotted by the instrument software. The obtained curve should be linear with $r > 0.995$.

To correct for the instrumental drift, the calibration should be performed every 20 samples or if the calibration verification has failed (see 7.8.1).

7.6. ASPIRATE SAMPLE BLANK (see 7.2) AND SAMPLE SOLUTIONS (see 7.1)

Record their concentrations as calculated by the software using the calibration curve. Rinse the system by aspirating 10% nitric acid for at least 30 s between samples.

7.7. IF THE CONCENTRATION OF THE TEST PORTION EXCEEDS THE CALIBRATION RANGE, dilute the test portion with the blank solution accordingly.

NOTE: After the measurement of high level (or over calibration) sample, measure a sample blank or water to check the absence of memory effect. If necessary, clean the system for 1 minute with 10% nitric acid.

7.8. QUALITY CONTROL SOLUTIONS

The quality control solutions as described below should be measured during the run.

7.8.1. Calibration Verification CV

After the initial calibration, the calibration curve must be verified by the use of initial calibration verification (CV) standard.

The CV standard is a standard solution made from an independent (second source) material, at/or near midrange. This solution as a calibration standard should be prepared using the same type of acid and oxidising solution than in the test portion (the final concentration should be similar).

The acceptance criteria for the CV standard must be $\pm 10\%$ of its true value.

If the calibration curve cannot be verified within the specified limits, the causes must be determined and the instrument recalibrated before the samples are analysed. The analysis data for the CV must be kept on file with the sample analysis.

The calibration curve must also be verified at the end of each analysis batch and/or after every 10 samples. If the calibration cannot be verified within the specified limits, the sample analysis must be discontinued, the causes must be determined and the instrument recalibrated. All samples following the last acceptable test must be reanalysed.

7.8.2. Blank solution (see 7.2)

The maximum allowed blank concentration should be well documented, and if the blank solution exceeds this value all samples prepared along the contaminated blank should be prepared again and reanalysed.

7.8.3. Post digestion spike

Each unknown type of sample should be spiked to check for potential matrix effect.

This spike is considered as a single point standard addition, and should be performed with a minimum dilution factor. The recovery of spike calculated with equation 1 should be 85-115%. If this test fails, it is recommended to run analysis with standard addition method.

Spike solution: mix a fix volume (V1) of the sample solution, and a known volume (V2) of a standard solution with known concentrations (Cstandard).

Unspike solution: mix the same fix volume (V1) of sample solution, and the same volume (V2) of reagent water.

Measure the concentration C (mg l⁻¹) in both solutions on the calibration curve (see 7.6), and calculate recovery as:

$$C_{spike} = \frac{C_{standard} \times V_2}{(V_1 + V_2)} \quad \text{Equation 1}$$

$$R = \frac{C_{Spike\ Solution} - C_{Unspike\ solution}}{C_{spike}} \times 100 \quad \text{Equation 2}$$

To be valid, the concentrations of spiked and unspiked solutions should be in the linearity range of the calibration curve, and the spiked concentration (equation 1) should be in the range of 50-150% of the concentration of the unspiked solution.

7.8.4. Dilution test

If the analyte concentration is sufficiently high (minimally, a factor of 10 above the lower limit of the quantitation following dilution), an analysis of a 1:5 dilution should agree within

$\pm 10\%$ of the original determination. If not, then a chemical or physical interference effect should be suspected, and method of standard addition is recommended.

7.8.5. Certified Reference Material

At least one certified reference material of a representative matrix should be prepared with each batch of sample, the calculated result should fall in the value of the certificate and within the coverage uncertainty (Linsinger, 2010), to show evidence of an unbiased result.

The results for the CRM should be recorded for quality control purpose and plotted on a control chart (UNEP/IOC/IAEA 1994).

An example of sequence order with recommended criteria and actions is given in table 1.

TABLE 1. EXAMPLE OF AN ANALYTICAL SEQUENCE:

Solutions Description	Performance	Action
Calibration blank	< maximum allowed calibration blank value	Stop until resolve
Standard solution 1–4	$r > 0.995$	recalibrate in the linearity range
CV	$\pm 10\%$ of the true value	Stop until resolve
Sample blank	< maximum allowed blank value	
CRM	Fall in the certificate value within coverage uncertainty, or fall within acceptable criteria of the QC chart	Stop until resolve, check Matrix spike and run again with standard addition method if necessary
Matrix Spike	recovery $100\% \pm 15\%$	switch to standard addition, keep records for future analysis of the same matrix
Dilution Test	sample 1 = 5x sample 1 diluted 5x within 10%	switch to standard addition, keep records for future analysis of the same matrix
Unknown Sample 1–10	should \geq standard 1 and \leq standard 4	report as <minimum quantification limit or dilute
CV	$\pm 10\%$ of the true value	Stop until resolve
Unknown Sample 11–20	should \geq standard 1 and \leq standard 4	report as <minimum quantification limit or dilute
Calibration blank	< maximum allowed calibration blank value	Stop until resolve
Standard solution 1–4	$r > 0.995$	recalibrate in the linearity range
CV	$\pm 10\%$ of the true value	Stop until resolve
Etc....		

8. CALCULATION OF RESULTS

Results are calculated using equation 3

$$w(m) = \frac{(\rho_1 - \rho_0)}{m} \times f \times V \times R \quad \text{Equation 3}$$

Where:

w(m) is the mass fraction of element m in the sample, expressed in mg kg⁻¹;

ρ1 is the concentration of element m, expressed in mg/l as measured in the sample solution;

ρ0 is the concentration of element m expressed in mg/l as measured in the blank solution;

F is the dilution factor calculated as follow:

$$f = \frac{\text{final volume}}{\text{initial volume}}$$

or equal to 1 if ρ1 is determined in undiluted solution;

R is the recovery calculated using the CRM (see 7.8.5) or the post digestion spike.

m is the mass of sample in g

V is the volume of solution in ml

9. EXPRESSION OF RESULTS

The rounding of values will depend on the uncertainty reported with the result; in general for this method two or three significant figures should be reported.

Uncertainty component should be reported with all results. (ISO 2005, Nordtest 2004)

Example: w(Hg) = 0.512 ± 0.065 mg kg⁻¹.

10. REFERENCES

- IAEA (2011). IAEA Recommended method on the microwave digestion of marines samples for the determination of trace element content, 2011, *in preparation*, available upon request
- ISO (1995). Guide to the expression of uncertainty of measurements International Organisation for Standardization: Geneva
- Linsinger T. (2010). European Commission - Joint Research Centre, Institute for Reference Materials and Measurements (http://www.erm-crm.org/ERM_products/application_notes/application_note_1/Documents/erm_application_note_1_english_rev3.pdf)

- Nordtest (2004). Handbook For Calculation Of Measurement Uncertainty In Environmental Laboratories Edition 2 <http://www.nordicinnovation.net/nordtestfiler/tec537.pdf>
- UNEP/IOC/IAEA (1994) reference method 57: Quality assurance and good laboratory practice, UNEP, 1994.

Annex VIII:

CEMP Guidelines for Monitoring Contaminants in Sediments

(OSPAR Agreement 2002-16)

Technical Annex 5: Normalisation of contaminant concentrations in sediments



CEMP Guidelines for Monitoring Contaminants in Sediments

(OSPAR Agreement 2002-16)

Technical Annex 5: Normalisation of contaminant concentrations in sediments

1. Introduction

As contaminant concentrations may vary due to differences in bulk sediment composition, e.g. differences in particle size distribution, organic matter content, results from comparisons of observed data to assessment criteria or trend assessments may be obscured. In order to reduce variances of contaminant concentrations due to differences in bulk sediment composition and to increase the power of monitoring programmes to address the objectives of the JAMP, procedures for normalisation of the concentrations of contaminants in sediment have been developed and used in OSPAR assessments of monitoring data.

2. Purposes

This annex provides guidance on the application of methods to normalise contaminant concentrations in sediments. Normalisation is defined here as a procedure to adjust contaminant concentrations for the influence of the natural variability in sediment composition, grain size, organic matter and mineralogy. Most natural and anthropogenic substances, metals and organic contaminants, show a much higher affinity to fine particulate matter compared to the coarse fraction. Constituents such as organic matter and clay minerals contribute to the affinity to contaminants in this fine material.

Fine material, both inorganic and organic, and associated contaminants are preferentially deposited in areas of low hydrodynamic energy, while in areas of higher energy, fine particulate matter is mixed with coarser sediment particles which generally have smaller binding capacity for contaminants. This dilution effect will cause lower and variable contaminant concentrations in the resulting sediment. Obviously, grain size and organic matter are important factors controlling the distribution of natural and anthropogenic components in sediments. It is, therefore, essential to normalise for the effects of grain size or organic carbon in order to provide a basis for reliable assessments of temporal trends and for meaningful comparisons of the occurrence of substances in sediments of variable bulk properties with background (assessment) criteria and environmental assessment criteria derived for a defined sediment composition.

In sediment of varying bulk properties, contaminant concentrations will be closely related to the distribution of fine grained material, and any effects of other sources of contaminants, for example anthropogenic sources, will be at least partly obscured by grain size differences. Also in temporal trend monitoring, differences in sediment bulk properties can obscure trends, but if samples have a considerable and constant percentage of fine material, the influence of grain size distribution is of minor importance and may probably be neglected.

3. Normalisation procedures

Two different approaches to correct for variable sediment compositions are widely used:

a. Isolation of the fine fraction by sieving, e.g. <20 μm , <63 μm , can be regarded as means to reduce the differences in sediment granulometric compositions and is applicable to both metals and organic contaminants (e.g. Ackermann *et al.* 1983; Klamer *et al.* 1990; QUASH, 2000). Consequently the coarse particles, which usually do not bind anthropogenic contaminants and dilute their concentrations, are removed from the sample. Then, contaminant concentrations measured in these fine fractions can be directly compared. Subsequently, the differences in sediment composition due to geochemical nature remaining after sieving can be further corrected for by the use of co-factors. Thus, sieving is a powerful first step in normalisation;

b. Normalisation can be performed by relating the contaminant concentration with components of the sediment that represents its affinity for contaminants, i.e. binding capacity. Normalisation of contaminant concentrations can be performed by linear regression against cofactors (Cato, 1977; Smedes, 1997; Smedes *et al.*, 1997). Another procedure takes into account that the coarse sediment fraction contains natural metal concentrations in the crystal structure before the normalisation is performed (see section 4). Combinations of co-factors, possibly identified from multiple regression analysis, can be used.

4. Normalisation using co-factors

a. The binding capacity of the sediments can be related to the content of fines, primary factor, in the sediments. Normalisation can be achieved by calculating the concentration of a contaminant with respect to a specific **grain-size fraction** such as <2 μm , i.e. the clay factor, <20 μm or <63 μm ;

b. As the content of fines is represented by the contents of major elements of the clay fraction such as **aluminium** (Windom *et al.* 1989) or an appropriate trace element enriched in that fraction such as **lithium** (Loring 1991), these can also be used as co-factors, secondary factors. Both, aluminium and lithium behave conservatively, as they are not significantly affected by, for instance, the early diagenetic processes and strong redox effects frequently observed in sediments. Problems may occur when the sediment is derived from glacial erosion of igneous rocks, with significant amounts of aluminium present in feldspar minerals contributing to the coarse fraction. In such cases, lithium may be the preferable co-factor (Loring 1991);

c. Organic matter, usually represented by organic carbon, is the most common co-factor for organic contaminants due to their strong affinity to this sediment component. In some environments, trace metal concentrations can also be normalised using organic carbon content especially in surface sediments (Cato 1977). However, due to the non-conservative nature of organic matter, its suitability as co-factor has to be checked prior to an assessment.

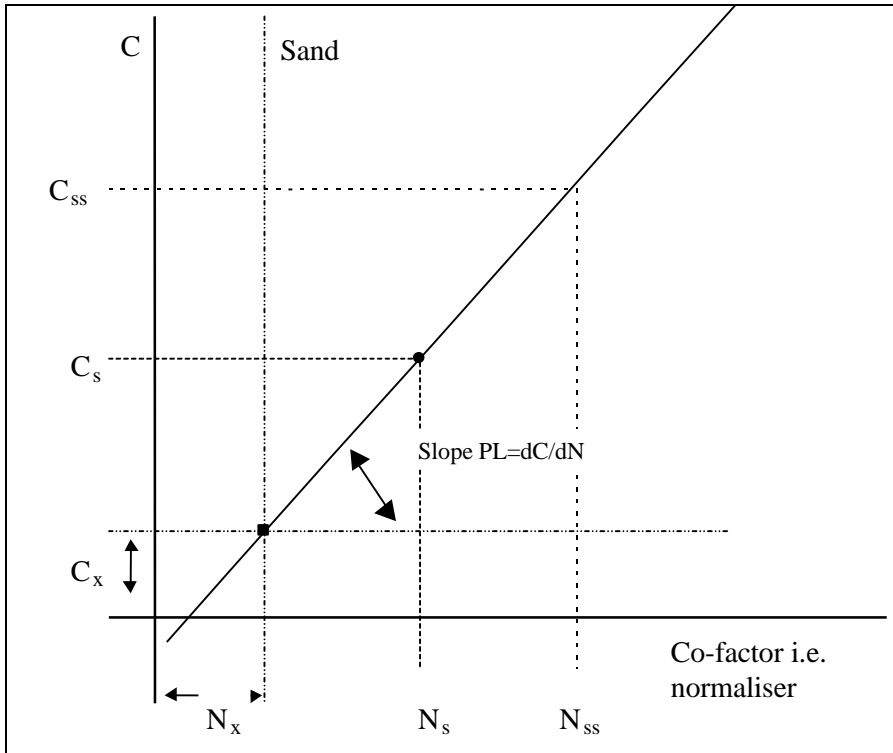

Figure 1: Relationship between the contaminant C and the cofactor N (from Smedes, 1997).

5. Theory

The general model for normalisation taking into account the possible presence of contaminants and cofactors in the coarse material is given in figure 1 (Cato, 1977; Smedes *et al.* 1997; Kersten and Smedes, 2002). C_x and N_x represent the contaminant and the co-factor contents, respectively, in pure sand. These “intercepts” can be estimated from samples without fines and organic material. The line of regression between the contaminant and co-factor will originate from that point. That means that regression lines of sample sets with a different pollution level and consequently different slopes will have this point in common (i.e. pivot point) (OSPAR 2008). When this pivot point is known, only one sample is required to estimate the slope. This allows determination of the contaminant content for any agreed (preselected) co-factor content (N_{ss}) by interpolation or extrapolation. The slope (PL) for a sample with a contaminant content C_s and a co-factor content of N_s can be expressed as follows:

$$PL = \frac{dC}{dN} = \frac{C_s - C_x}{N_s - N_x} \quad (1)$$

The extrapolation to an agreed co-factor content, N_{ss} , follows the same slope:

$$PL = \frac{dC}{dN} = \frac{C_s - C_x}{N_s - N_x} = \frac{C_{ss} - C_x}{N_{ss} - N_x} \quad (2)$$

Rewriting gives the contaminant content, C_{ss} , that is normalised to N_{ss} :

$$C_{ss} = (C_s - C_x) \frac{N_{ss} - N_x}{N_s - N_x} + C_x \quad (3)$$

Results of different samples normalised to the agreed N_{ss} can be compared directly.

Normalisation by this model can be applied with different cofactors. Here primary and secondary cofactors can be distinguished. A primary cofactor like the clay fraction or organic carbon is not present in the coarse fraction and consequently has no intercept ($N_x=0$). Al and Li are present in the coarse fraction and therefore are considered to be secondary cofactors. Provided N_x and C_x are known, the model allows recalculation of total samples to a co-factor content usually found in sieved fractions, either <20 or $<63\mu\text{m}$. However such an extrapolation for a coarse grained sample will be associated with a large error due to the uncertainty of the intercepts and the analysed parameters. For a more fine grained sample, or a sieved fraction, the uncertainty of the normalised result is much lower than for normalisation of a coarse grained sample to the agreed cofactor content and will result in a more accurate result. The model presented also applies to the normalisation of organic contaminants using organic carbon but in that case the intercepts N_x and C_x will not differ significantly from zero.

Principally, the result allows comparison of data of total and sieved samples, irrespective of the sieving diameter but the error has to be taken into account. Through propagation of errors the standard error of the result can be calculated from the analytical variation and the natural variation of the intercept N_x (Smedes *et al.*, 2005). Results can therefore always be reported with a standard deviation.

6. Considerations on co-factors

The **clay mineral content** is the most important cofactor for trace metals. In the model above the N_x will be zero for clay and only the intercept due to the content of the trace metal in the coarse fraction (C_x) has to be taken into account. However, current intercomparison exercises do not include this parameter. Presently other parameters such as aluminium or lithium are used to represent the clay content.

The **aluminium** content in the sandy fraction may vary from area to area. For some areas aluminium contents in the sandy fractions are found at the same level as found in the fines (Loring, 1991) and therefore the intercept N_x becomes very high. In equation (3) this implies that the denominator is the result of subtracting two large numbers, that is the normaliser content in the sample (N_s) and the normaliser content in only sand (N_x). Consequently, due to their individual uncertainties, the result has an extremely high error. Obviously, normalisation with low intercepts is more accurate. Much lower intercepts are found if partial digestion methods are used that digest the clay minerals, but not the coarse minerals. Using partial digestion, the spatial variability of the results of aluminium analyses in the sandy fraction has been found to be much smaller than with total methods. Although normalising concentrations of contaminants in fine grained material will always give more accurate results, an error calculation will identify whether using coarse samples (and total methods, e.g. HF, X-ray fluorescence, lithium tetraborate fusion) allows the requirements of the programme to be met.

For most areas the **lithium** content in the sandy fraction is much lower than in the fine fraction. In addition, results from partial digestion and total methods do not differ significantly. There is only little spatial variability of the lithium content in the sandy fraction. Generally, compared to aluminium, more accurate normalised data can be expected using lithium.

As for clay, no intercept (N_x) applies for organic matter, which is usually represented by **organic carbon**. Organic matter also occurs in the coarse fraction but is even then a cofactor that contributes to the affinity for contaminants, whereas the aluminium in the coarse fraction does not.

Furthermore, organic matter in a sample is not always well defined as it can be composed of material with different properties. The most variable properties will be found in the organic matter

present in the coarse fraction and not associated with the fines. In **fine sediments** or in the sieved fine fractions the majority of the organic matter is associated with the mineral particles and it is assumed to be of more constant composition than in the total sample. In addition, the nature of the organic matter may show spatial and temporal variations. For samples with low organic carbon content close to the detection limit, normalisation using this cofactor suffers from a large relative error. This results from the detection limit and the insufficient homogeneity that cannot be improved due to the limited intake mass for analysis.

For further interpretation of data the **proportion of fines** determined by sieving can be useful. Provided, there are no significant amounts of organic matter in coarse fractions, the proportion can be used as a co-factor, particularly for organic contaminants. The error in the determination of fines has to be taken into account and will be relatively high for coarse samples.

7. Considerations on contaminants

Almost all trace metals, except mercury and in general also cadmium, are present in the coarse mineral matrix of samples. The metal concentrations show a spatial variability depending on the origin of the sandy material. In sandy sediments, partial digestion techniques result in lower values than are obtained from total digestion techniques. This implies that partial digestion results in lower intercepts (pivot point is closer to the zero). However, the partial digestion must be strong enough so the clay will be totally digested (as is the case with HF digestion techniques), and the measured aluminium content remains representative for the clay. It was demonstrated that analyses of fine material gave similar results for several trace elements using both total and strong partial methods (Smedes *et al.* 2000; Kersten and Smedes, 2002, cf. Technical Annex 6)

For organic contaminants the situation is more complex. In general, correlations of organic contaminants with organic carbon have no significant intercept, i.e. the contaminants are primarily associated with organic matter. Thus, for sediment samples that contain low concentrations of organic carbon (e.g. very sandy sediments), concentrations of these contaminants can be below or very close to the analytical detection limit. Application of the normalisation procedure using organic carbon to such samples is inappropriate, since it will greatly magnify the analytical error. The influence of these errors can be minimised by analysing muddy sediments, or by analysing a fine fraction sieved from the bulk sandy sediment.

In some cases, PAHs in sediment are found associated with materials such as soot or ash. Concentrations of PAHs can be quite high in these materials, and this can result in high concentrations of PAHs in grain size fractions where soot, ash, etc. are concentrated. These materials generally are present in small quantities, and the PAHs associated with them have little biological activity, and therefore are of limited environmental significance. Although the available data are not comprehensive, existing information indicates that PAH concentrations in sieved fine fractions (e.g. <63 µm) are not significantly affected by the presence of small amounts of soot, ash etc.

8. Isolation of fine fractions for analyses

The Sample preparation

Samples should be sieved at 2 mm as soon as possible after sampling to remove large detritus and benthic organisms. Otherwise during further sample handling like storage, freezing or ultrasonic treatment, biotic material will deteriorate and become part of the sediment sample. Until the final sieving procedure that isolates the fines, the sample can be stored at 4°C for about a week and up to

3 months when frozen at -20°C , although direct wet sieving is preferred. For prolonged storage freeze-drying of samples can be considered. In this case contamination and losses of contaminants during freeze-drying have to be checked. Air-drying is not appropriate due to high contamination risks and checks are needed. Besides, samples may be difficult to be disaggregated and mineral structures may be affected.

Requirements for Sieving

A wet sieving procedure is required to isolate the fine-grained fractions, $<63\ \mu\text{m}$ or $<20\ \mu\text{m}$. Wet sieving re-suspends fine particles that would otherwise remain attached to coarser particles in the sample. Sediments should be agitated during sieving to prevent to disaggregate agglomerates of fines and to prevent clogging of the mesh. Freeze-dried samples need to be re-suspended using ultrasonic treatment. Seawater, preferably from the sampling site, should be used for sieving as it reduces the risk of physico-chemical changes in the sample i.e. losses through leaching or contamination. Furthermore seawater assists the settling of fine particles after the sieving. If water from the sampling site is not available, then seawater of an unpolluted site, diluted with deionised water to the required salinity, can be used. The amount of water used for sieving should be kept to a minimum and be reused for sieving subsequent batches.

To minimise or prevent contamination it is recommended to use large sample amounts of sediment for sieving. No significant contaminant losses or contamination was detected when at least 25 g of fine fraction is isolated.

Methodology

Both automated and manual methods are available for sieving. A video presentation of these methods can be provided by the QUASH Project (QUASH 1999).

- The automatic sieving method pumps seawater over a sieve that is clamped on a vibrating table (Klamer *et al.* 1990). The water passing the sieve is led to a flow-through centrifuge that retains the sieved particles and the effluent of the centrifuge is returned to the sieve by a peristaltic pump. Large sample amounts, up to 500 g, can be handled easily.
- The second method is a manual system sieving small portions 20-60 g using an 8-cm sieve in a glass beaker placed in an ultrasonic bath (Ackermann *et al.* 1983). Particles are isolated from the water passing the sieve by batch wise centrifugation. The water can be reused for a subsequent batch of sediment. In case of sandy samples, when large amounts of sediments have to be sieved, removal of the coarse material by a pre-sieving over e.g. 200- μm mesh can facilitate the sieving process.

Isolated fine fractions have to be homogenised thoroughly, preferably by a ball mill, as centrifugation produces inhomogeneous samples due to differences in settling speed of different grain-size fractions.

9. Limitations of normalisation

The purpose of normalisation is to reduce the variability between samples arising from differences in bulk sediment properties. However, it has been observed in some areas that the correlations between contaminant and cofactor concentrations may be weak or even absent. This may happen, e.g., if the cofactor used is inappropriate for the contaminant of concern, the degree of contamination is very variable with time or space, or there is significant additional variance arising from the measurements of the concentration of the chosen cofactor.

Contracting Parties may specify additional cofactors other than Al, Li or TOC to be used for the normalisation of concentrations of particular contaminants in their monitoring data. The effectiveness of the normalisation should be assessed through the effect of application of normalisation on the residual variance about time series, as described above. When making proposals, it will be necessary for Contracting Parties to ensure that pivot values and Background Concentrations expressed in relation to the same cofactors are also available.

Current procedures applied in OSPAR trend assessments include the application of smoothers or, for short time series, linear regressions. Normalisation using cofactors should be applied if this results in a reduction of the residual variance around the fitted smoother or regression in time series, but should not be applied if the residual variance is not reduced. In case the residual variance can be reduced for time series, normalisation should also be applied to check whether observed concentrations of contaminants are at or close to Background (Assessment) Concentrations and whether they comply with the Environmental Assessment Criteria.

Furthermore, as the composition of sand-sized material may differ significantly between different parts of the Convention area, **pivot values** (cf. Section 5) can vary too. In addition, they can vary with the analytical method, i.e. with partial or total digestion for metals analysis. The use of inappropriate pivot values could have significant impact on the calculated normalised concentrations (cf. Section 5), particularly for sediment samples containing relatively small proportions of fine grained material. Therefore, Contracting Parties may propose derived pivot values appropriate to particular parts of the Convention area to OSPAR/ICES for review. Such regionalised pivot values should be applicable over large parts of the Convention area, for example across entire (sub-)Regions

The current **Background (Assessment) Concentrations** may be inappropriate for application throughout the Convention area, as they were derived from a data set that emphasises the northern part of the Convention area. In addition, the Background Concentrations are currently expressed as normalised values (to 5% aluminium for metals and 2.5% TOC), and these “reference” values for the cofactors may not be appropriate for all areas. The use of inappropriate values for Background Concentrations could result in misleading assessments, e.g., as to whether concentrations in sediment are at or close to background. Therefore, Contracting Parties may propose derived Background Concentrations and associated cofactor values that they consider to be appropriate to particular parts of the Convention area. OSPAR/ICES will review if the combinations of Background Concentrations and associated cofactor values are consistent with the way in which pivot values to be used in the assessment of the field data are expressed, to allow the construction of straight lines joining pivot values and Background Concentrations. Such regionalised Background Concentrations should be applicable over large parts of the Convention area, for example across entire (sub-)Regions)

10. Recommendations

1. For monitoring, it would be ideal to analyse samples with equal composition. This could be confirmed by determination of co-factors Al, Li, TOC and parameters of the grain size distribution (e.g. clay content, proportion <20µm, proportion <63µm). However, this situation will seldom occur.
2. New temporal trend programs should be carried out by the analysis of fine sediments or a fine-grained fraction, isolated by sieving. Existing temporal trend programs could be continued using existing procedures, provided that assessment of the data indicates that the statistical power of the programs is adequate for the overall objectives.

3. Contaminant concentrations in whole sediments can be subjected to normalisation using co-factors for organic matter, clay minerals etc., by taking into account the presence of both co-factors and target contaminants in the mineral structure of the sand fraction of the sediment. Taking into account these non-zero intercepts of regressions of contaminant concentrations with co-factors, normalisation to preselected co-factor content will reduce the variance arising from different grain sizes. Normalised values for sandy sediments will have greater uncertainties than for muddy sediments. The propagated error of the variables used for normalisation may be unacceptably high for sandy sediments, if both contaminant and co-factor concentrations are low, particularly when approaching detection limits. In that case, in order to reduce the overall uncertainty, alternative procedures, such as sieving, need to be used to minimise the impact of this error structure.

4. The natural variance of sample composition will be smaller in the fraction <20 µm than in the fraction <63 µm. Therefore, for trace metals, the fraction <20 µm should be preferred over the fraction <63 µm. However, separation of the fraction <20 µm can be considerably more laborious than the separation of the fraction <63 µm and might be an obstacle to its wide application. For this practical reason, the fraction <63 µm is an acceptable compromise for monitoring programmes. For organic contaminants, the fraction < 63 µm should be used for analyses, as it may be difficult to incorporate the organic matter with the highest binding capacity for organic contaminants in the fine grained fraction < 20 µm completely. Thus, variances due to separating the fine fraction can be reduced.

5. There will still be some residual variance arising from differences in the composition (mineralogy and organic carbon content) of the sediments. Therefore, the preferred approach is analyses of contaminants in fine sediments or in the fraction <63 µm, followed by normalisation of analytical results using cofactors (see section 3). Current scientific knowledge indicates that this procedure minimises the variances arising from differences in grain size, mineralogy and organic matter content. Application of this two-tiered approach to fractions < 20 µm gives results that can be directly compared to results found by normalisation of concentrations measured in fractions < 63 µm.

6. In order to clarify aspects of data interpretation, analytical data for field samples should be accompanied by information on limits of detection and long term precision. In order to contribute to environmental assessment, data for field samples should include the grain size distribution, as a minimum the proportion of the analysed fraction in the original whole sediment. Aluminium (Al) and total organic (TOC) concentrations should be reported for use as potential cofactors. If possible, the determination of Li as an additional potential cofactor is recommended.

7. In order to take into consideration potential regional differences in sediment composition in monitoring contaminants in sediments and its assessment, cofactors others than those mentioned in section 3 may be used. Furthermore, regionalised pivot points for calculating normalised contaminant concentrations as well as regionalised Background (Assessment) Concentrations may be derived for different regions.

11. References

Ackermann, F., Bergmann, H., and Schleichert, U. (1983) Monitoring of heavy metals in coastal and estuarine sediments – A question of grain-size: <20 µm versus <60 µm. *Environmental Technology Letters*, 4: 317-328.

Cato, I. (1977): Recent sedimentological and geochemical conditions and pollution problems in two marine areas in south-western Sweden. *Striae* 6, 158 pp. Uppsala.

Gobeil, C., MacDonald, R. W. & Sundby, B. (1997): Diagenetic separation of cadmium and manganese in suboxic continental margin sediments. *Geochim. Cosmochim. Acta* 61, 4647-4654.

Kersten, M., and Smedes, F. 2002. Normalisation procedures for sediment contaminants in spatial and temporal trend monitoring – a critical review, *J. Environ. Monit.*, 4: 109-115

Klamer, J. C., Hegeman, W. J. M. & Smedes, F. (1990): Comparison of grain size correction procedures for organic micropollutants and heavy metals in marine sediments. *Hydrobiologia* 208, 213-220.

Loring, D. H. (1991): Normalisation of heavy-metal data from estuarine and coastal sediments. *ICES J. mar. Sci.* 48, 101-115.

OSPAR 2008. CEMP Assessment Manual. Coordinated Environmental Monitoring Programme Assessment Manual for contaminants in sediment and biota.

QUASH (1999) Sediment Sieving Techniques, QUASH Project Office, FRS Marine Laboratory, PO Box 101, Victoria Road, Aberdeen, AB11 9DB, Scotland

Smedes, F. (1997) Grainsize Correction Procedures, Report of the ICES Working Group on Marine Sediments in Relation to Pollution. ICES CM 1997/Env:4, Ref. E, Annex 6.

Smedes, F., Lourens, J., and Wezel, van A. (1997) "Zand, Slib en Zeven, Standardisation of contaminant contents in marine sediments, Report RIKZ-96.043 (Dutch), ISSN 0927-3980, RIKZ, PO Box 20907, 2500 EX, The Hague.

Smedes, F. Davies, I.M., Wells, D., Allan, A., Besada, V. (2000): Quality Assurance of Sampling and Sample Handling (QUASH) –Interlaboratory study on sieving and normalisation of geographically different sediments; QUASH round 5 (sponsored by the EU Standards, Measurements and Testing Programme)

Smedes, F., Davies, I.M., and Fryer, R. J. 2005. Pragmatic estimation of uncertainty in normalised concentrations of contaminants in sediments. *ICES CM* 2005/Z:04.

Windom, H. L., *et al.* (1989): Natural trace metal concentrations in estuarine and coastal marine sediments of the southeastern United States. *Environ. Sci. Technol.* 23, 314-320.

Annex IX:

**Sample work-up for the analysis of selected chlorinated
hydrocarbons in the marine environment**



UNITED NATIONS ENVIRONMENT PROGRAMME

November 2011

Sample work-up for the analysis of selected chlorinated hydrocarbons in the marine environment

Recommended Methods For Marine Pollution Studies 71

Prepared in co-operation with



NOTE: This recommended method is not intended to be an analytical training manual. Therefore, the method is written with the assumption that it will be used by formally trained analytical chemists. Several stages of this procedure are potentially hazardous; users should be familiar with the necessary safety precautions.

For bibliographic purposes this document may be cited as:

UNEP/IAEA: Sample work-up for the analysis of selected chlorinated hydrocarbons in the marine environment. Reference Methods for Marine Pollution Studies No 71, UNEP, 2011.

PREFACE

The Regional Seas Programme was initiated by UNEP in 1974. Since then, the Governing Council of UNEP has repeatedly endorsed a regional approach to the control of marine pollution and the management of marine and coastal resources and has requested the development of regional action plans. The Regional Seas Programme at present includes thirteen regions and has over 140 coastal States participating in it (1).

One of the basic components of the action plans sponsored by UNEP in the framework of the Regional Seas Programme is the assessment of the state of the marine environment, its resources and the sources and trends of the pollution and its impact on human health, marine ecosystems and amenities. In order to assist those participating in this activity and to ensure that the data obtained through this assessment can be compared on a world-wide basis and thus contribute to the Global Environment Monitoring System (GEMS) of UNEP, a set of Reference Methods and Guidelines for marine pollution studies are being developed as part of a programme of comprehensive technical support which includes the provision of expert advice, reference methods and materials, training and data quality assurance (2). The Methods recommended for adoption by Governments participating in the Regional Seas Programme.

The methods and guidelines are prepared in co-operation with the relevant specialised bodies of the United Nations system as well as other organisations and are tested by a number of experts competent in the field relevant to the methods described.

In the description of the methods and guidelines, the style used by the International Organisation for Standardisation (ISO) has been followed as closely as possible.

The methods and guidelines published in UNEP's series of Reference Methods for Marine Pollution Studies are not considered as definitive. They are planned to be periodically revised taking into account the new developments in analytical instrumentation, our understanding of the problems and the actual need of the users. In order to facilitate these revisions, the users are invited to convey their comments and suggestions to:

Marine Environmental Studies Laboratory
IAEA Environment Laboratories
4, Quai Antoine 1^{er}
MC 98000 MONACO

which is responsible for the technical co-ordination of the development, testing and inter-calibration of Reference Methods.

References:

(1) www.unep.org/regionalseas (2011)

(2) UNEP/IAEA/IOC: Reference Methods and Materials: A Programme of comprehensive support for regional and global marine pollution assessment. UNEP, 1990.

CONTENTS

	Page
1. Scope and field of application	1
2. Principles	1
3. Reagents, solvents, standards	1
3.1. Reagents	1
3.1.1. List of reagents	1
3.1.2. Cleaning of solvents	3
3.1.3. Cleaning of reagents and adsorbents	3
3.1.3.1. Cleaning of reagents	3
3.1.3.2. Cleaning of adsorbents	4
3.2. Apparatus and equipment	4
3.2.1. List of materials	4
3.2.2. Cleaning of glassware	5
4. Sediments	7
4.1. Sampling	7
4.2. Cleaning of extraction thimbles	7
4.3. Extraction of sediment	7
4.3.1. Extraction of freeze-dried samples	7
4.3.2. Extraction of wet samples	7
4.3.3. Example of determination of percent moisture	8
4.4. Concentration of the extract	8
4.5. Extractable organic matter	9
4.6. Clean-up procedure and fractionation	10
4.6.1. Sulphur and sulphur compounds removal	10
4.6.2. Fractionation	11
4.6.2.1. Florisil	11
4.6.2.2. Gel permeation chromatography	13
4.6.2.3. Alumina and HPLC (silica column)	13
4.6.2.4. High pressure chromatography	13
5. Biota	14
5.1. Sampling	14
5.2. Cleaning of extraction thimbles	14
5.3. Extraction of tissues	16
5.3.1. Extraction procedure for freeze-dried samples	16
5.3.2. Extraction procedure without freeze-drying	16
5.4. Concentration of the extract	16
5.5. Extractable organic matter (EOM)	16
5.6. Clean-up procedure and fractionation	16
5.6.1. Removal of lipids by concentrated sulphuric acid	16
5.6.2. Fractionation	16
6. Capillary Gas chromatographic determinations	17
6.1. Gas chromatography conditions	17
6.2. Column preparation	17
6.3. Column test	18
6.4. Electron capture detector	19
6.5. Quantification	19
7. Computerized gas chromatography/Mass spectrometry (GC/MS)	20
7.1. Operating conditions	20
7.2. Example of a selected ion monitoring programme useful for quantitative analysis of chlorinated compounds	25
8. Notes on water analysis	25
9. Alternative procedures	25
9.1. Combining sample preparation and extraction for chlorinated and petroleum hydrocarbons	25
9.2. Supercritical fluid extraction (SFE) of marine samples	26
9.3. Microwave assisted extraction for marine samples	28
9.3.1. Sediment	28
9.3.2. Biota	28

10. Data interpretation	29
10.1. DDT	29
10.2. PCBs congeners	29
10.3. Typical profiles of commercial mixtures	30
11. Quality assurance / quality control	31
11.1. Precision	31
11.2. Accuracy	31
11.3. Blanks	31
11.4. Recovery	31
11.5. Archiving and reporting of results	31
12. References	34
 Annex:	
Explanations sent to all laboratories with sets of standard provided by IAEA-EL/MESL.	36

1. SCOPE AND FIELD OF APPLICATION

This reference method is intended for use in monitoring programmes and pilot research studies. The document describes procedures for the isolation of purified fractions amenable for the determination of DDTs and PCBs in marine sediments and marine organisms by capillary GC/ECD. It is assumed that most of the participants in the UNEP Regional Seas Programmes are equipped with advanced high resolution capillary gas chromatographs and will be able to implement most, if not all, of the procedures described in Reference Method No 40, "Determination of DDTs and PCBs by capillary gas chromatography and electron capture detection" (UNEP 1988). Assuming consistent results are routinely being obtained with these methods by the analytical laboratory, the determination of specific compounds (as opposed to generic mixture of PCBs) opens up the possibility not only of identifying environmental "hot spots", but also for characterising sources, elucidating transport pathways and developing data of greater toxicological relevance. The organisation and content of this document, however, deserves further comment. Under the sections devoted to SEDIMENTS and ORGANISMS, subsections are provided relating to procedures for: 1) Sampling, 2) Extraction and 3) Clean-up and fractionation. In each subsection, several alternative procedures are described. These various procedures have been previously tested and are provided to accommodate the range of capabilities in participating laboratories. For example, laboratories which have access to an HPLC may consider the benefits of using HPLC fractionation procedures in lieu of more conventional low pressure column chromatographic method. Participants are generally encouraged to implement the most effective procedures within the constraints of their individual laboratories.

Several other halogenated pesticides and other electron capturing organic compounds may be present in environmental samples and many of these compounds could also be isolated by the methods described here. However, not all residues will be stable to the clean-up procedures applied for the determination of PCBs and DDTs. Consequently, every analyst must test for analyte recovery and analytical reproducibility prior to applying these methods for other analytes on a routine basis. Primary emphasis should be placed on obtaining the cleanest possible purified fraction for capillary GC/ECD analysis so that interferences and misidentification are minimised, if not eliminated.

2. PRINCIPLES

Following collection of sediment or biota samples using appropriate techniques, samples are stored in trace organic free vessels at -20°C until analysis. For analysis, the samples are prepared for solvent extraction. To achieve a satisfactory recovery of the chlorinated hydrocarbons, samples are dried by either desiccation with anhydrous sodium sulphate or by freeze-drying. Lipids are then Soxhlet extracted from sediments using hexane and dichloromethane, and from biota using hexane or petroleum ether. Following initial clean-up treatments (removal of sulphur from sediment extracts and treatment of biota extracts with concentrated sulphuric acid to destroy some interfering lipids), extracts are fractionated using column chromatography. Detailed protocols for absorption chromatographic fractionation are described for both low and high pressure systems, using Florisil and silica gel respectively. (Additional information concerning alternative techniques including gel permeation chromatography is provided).

3. REAGENTS, SOLVENTS, STANDARDS

3.1. Reagents

3.1.1. List of reagents

- Demineralized distilled water produced by distillation over potassium permanganate (0.1 g/l KMnO₄) or equivalent quality, demonstrated to be free from interfering substances.
- Detergent.
- Potassium dichromate.
- HCl. 32%.
- Concentrated H₂SO₄ (d 20°C: 1.84 g/ml).
- Sulfochromic cleaning solution made from concentrated sulphuric acid and potassium

- dichromate.
- KOH.
 - Anhydrous sodium sulphate.
 - Copper fine powder (particle size 63µm).
 - Carborundum boiling chips.
 - Hg.
 - Glass wool
 - Alumina (200-240).
 - Silica gel (60-100).
 - Florisil PR (60-100).
 - Bio-Beads SX-3 (200-400).
 - Sephadex LX-20.

Solvents:

- Hexane, Dichloromethane, Methanol, Pentane, Cyclohexane, Toluene and Ethyl Acetate, all "distilled in glass" quality.

Standards:

- PCB congeners: 29, 30, 121, 198.
- ε HCH.
- Endosulfan Id₄.
- n-C₁₄ d₃₀, n-C₁₉ d₄₀, n-C₃₂ d₆₆.
- Naphthalene d₈.
- Hexamethylbenzene.
- Cadalene: 1, 6-dimethyl-4-(1-methylethyl)naphthalene.
- DDT reference solutions - Prepare a stock solution of the DDT series (pp' DDT, op DDT, pp' DDD, op DDD, pp' DDE, op DDE) by dissolving 50 mg of each compound in 100 ml of hexane. Store stock solution in sealed glass ampoules.
- Other reference solutions - should be prepared if other residues are to be quantified in these procedures.

NOTES:

Working solutions obtained from the stock reference solutions should be prepared on a regular basis depending on their use and stored in clean glass volumetric flasks tightly capped with non-contaminating materials such as Teflon or glass. Extreme care must be taken to ensure that the concentrations of the standards have not altered due to solvent evaporation.

In order to achieve acceptable accuracy for the standard solutions, at least 50 mg of pure individual compound should be weighed and dissolved into 100 ml of hexane. This will give stock solutions of 500ng/µl.

Example of preparation of stock solutions:

Preparation of a stock solution of pp' DDE at approximately 500ng/µl:

The pp' DDE stock solution is prepared by dissolving approximately (but weighed accurately) 50 mg of pp' DDE in hexane in a 100 ml volumetric flask and bringing the volume to exactly 100 ml with hexane. If the actual weight of pp' DDE is 52 mg, then

$$\frac{52 \text{ mg DDE}}{100 \text{ ml solvent}} \times \frac{1000 \mu\text{g}}{\text{mg}} \times \frac{\text{ml}}{1000 \mu\text{l}} = \frac{52 \text{ mg DDE}}{100 \text{ ml of solution}}$$

$$52 \text{ mg}/100 \text{ ml} \Rightarrow 0.52 \text{ mg/ml} \Rightarrow 520 \mu\text{g/ml} \Rightarrow 520 \text{ ng}/\mu\text{l}$$

The concentration of the stock solution will be: 520ng/µl

Preparation of an intermediate solution:

Use the stock solution to prepare the intermediate solution. The concentration of pp' DDE intermediate solution should be approximately 5ng/μl. To prepare the 5ng/μl intermediate solution, transfer 1 ml of the pp' DDE stock solution into a 100 ml volumetric flask and dilute with hexane to 100 ml.

$$\frac{1 \text{ ml DDE stock solution}}{100 \text{ ml final volume}} \times \frac{520 \text{ ng DDE}}{\mu\text{l}} = \frac{5.2 \text{ ng}}{\mu\text{l intermediate solution}}$$

The concentration of the intermediate solution will be: 5.2 ng/μl

Preparation of the working solution:

Use the intermediate solution to prepare the working solution. The concentration of pp' DDE in the working solution could be approximately 50pg/μl.

To prepare the 50 pg/μl working solution, transfer 1 ml of the pp' DDE intermediate solution into a 100 ml volumetric flask and dilute with hexane to 100 ml.

$$\frac{1 \text{ ml DDE intermediate solution}}{100 \text{ ml final volume}} \times \frac{5.2 \text{ ng}}{\mu\text{l}} \times \frac{1000 \text{ pg}}{\text{ng}} = \frac{52 \text{ pg}}{\mu\text{l working solution}}$$

The concentration of the working solution will be: 52 pg/μl

3.1.2. Cleaning of solvents

All reagents, including the distilled water should be of analytical quality. Commercially available solvents like acetone, acetonitrile, dichloromethane, hexane and pentane are invariably contaminated with ECD-active substances; their concentrations vary from batch to batch and with supplier. Reagent quality should be checked by injection of 2 μl of a 100 ml batch of solvent, after concentration to 50 μl in a rotary evaporator. No peak in the GC-ECD chromatogram (90 - 250 °C) should be larger than that for 1pg of lindane. Otherwise, the solvent must be distilled. The following procedure has been found to be both efficient and cost effective, as it allows the use of technical grade solvents as the basic material (reducing the cost by one order of magnitude). 130 - 150 cm height columns are required; the packing material must be glass (to allow subsequent cleaning with an oxidising acid). The entire equipment is cleaned prior to use by 2 consecutive distillation procedures with 500 ml water in each case. It is essential that a current of nitrogen gas (15 ml/min) flows from the distillation flask during distillation of the organic solvents: the condenser serves as exhaust. Ambient air is not in contact with the solvent in this way. Problems are associated with other methods of excluding room air (e.g., active carbon or molecular sieves), the most important one being discontinuity. The condensate is distilled into a 1 litre flask at a 1:20 ratio. This large volume allows for direct transfer into the appropriate solvent containers which should be made of glass and of a sufficient size to provide solvent for not more than 6 analyses. A bottle with sufficient solvent for 10 - 15 analysis has to be opened and closed many times and even when kept closed, when not in use, contamination from the surrounding atmosphere takes place. For more detailed information, consult the Reference Method No 65: UNEP/IOC/IAEA: Reagent and laboratory ware clean-up procedures for low-level contaminant monitoring.

3.1.3. Cleaning of reagents and adsorbents**3.1.3.1. Cleaning of reagents**

Powdered or crystalline reagents, such as anhydrous sodium sulfate (Na₂SO₄)*, potassium hydroxide (KOH), glass wool * and carbon or carborundum boiling chips *, must be thoroughly cleaned before use. They should be extracted with hexane in a Soxhlet apparatus for 8 hours and then with methanol or dichloromethane for another 8 hours. For those items indicated by an *, this will require pre-combustion in a muffle furnace at approximately 400°C.

3.1.3.2. Cleaning of adsorbents

Silica gel, alumina and Florisil have to be solvent extracted. Each reagent is first refluxed with methanol or dichloromethane in a Soxhlet apparatus for 8 hours, then with n-hexane for the same period. The solvent is removed by a rotary evaporator operating at low speed, until the sorbent starts falling down as fine particles. Reagents are dried in a drying oven at 0.01 mbar. If this is not available, they are dried in a normal oven at 120°C for 4 hours. This serves to activate silica and alumina. Florisil has to be activated at 130°C for 12 hours. The sorbent is allowed to cool in the oven (if possible under vacuum to avoid uptake of contaminants from the atmosphere) or alternatively, in a dessicator. As active sorbents attract water and contaminants from the atmosphere, controlled deactivation should be carried out by adding water to the fully active sorbent (5% by weight to silica, 2% by weight to alumina, and 0.5% by weight to Florisil). The deactivation procedure should be carried out by adding the water to the sorbent and mixing by gentle shaking for a few minutes. The equilibration takes one day. The activity can be maintained for longer periods of time by sealing the required amount of sorbent in glass ampoules. Otherwise, the activation/deactivation has to be done the day before use.

3.2. Apparatus and equipment

The laboratory used for organic trace analysis must be a dedicated facility, isolated from other projects that could be sources of contamination. It must be properly constructed with fume hoods and benches with electric sockets that are safe for use with flammable solvents. The laboratory must have extractors and rotary evaporators cooling water to run the stills. In tropical regions and in dry climates, a refrigerated re-circulating system should be used to reduce temperatures to the required levels and/or to conserve water. Stainless steel or ceramic tiles make good non-contaminating surfaces. If necessary, benches can be coated with a hard epoxy resin and walls can be painted with epoxy paint. A sheet of aluminium foil on the workbench provides a surface which can be cleaned with solvent. A vented storage facility for solvents is essential. Benches must be fitted with frames to hold stills, extractors, etc. The emergency cut-off switch should be accessible from both inside and outside the laboratory. Fire fighting equipment should be mounted in obvious places and laboratory personnel trained in their use.

3.2.1. List of materials

- A coring device with liners and plunger or a grab sampler (thoroughly cleaned with detergents and solvents before use).
- Glass jars and aluminium foil, stainless steel knives, scoops, forceps, labels, marking pens, logbook.
- Insulated plastic boxes for transporting samples. Ice or dry ice.
- Deep freezer (-18 to -20°C) for sample preservation (frost free type freezers heat to above zero during frost removal cycles and they cannot be used for long term storage).
- Rotary evaporator.
- Kuderna-Danish (or similar) concentrator and heater.
- Soxhlet extraction apparatus and heaters.
- Glassware including boiling flasks, ground glass stoppers, beakers, Erlenmeyer flasks, separatory funnels, centrifuge tubes, weighing bottles, pipettes, tissue grinders.
- Drying oven (temperature range up to at least 300°C) for determining sample dry weights, baking of contaminant residues from glassware and reagents.

Note: A muffle furnace is better for baking materials at greater than 300°C, if required.

- Centrifuge and tubes.
- Freeze-dryer and porcelain pestle and mortar.
- Analytical balance with an accuracy of 0.1 mg and an electro-balance with an accuracy of at least 1 µg.
- Stainless steel tweezers and spatulas.

- Dessicator - completely free of organic contamination and with no grease applied to sealing edges.
- Supply of clean, dry nitrogen.
- Columns for silica gel, alumina and Florisil chromatography.
- Mechanical blender (food mixer).
- Vacuum pump (water-jet air pump).

3.2.2. Cleaning of glassware

Scrub all glassware vigorously with brushes in hot water and detergent. Rinse five times with tap water and twice with distilled water. Rinse with acetone or methanol followed by hexane or petroleum ether. Bake overnight in an oven at 300 °C. All glassware should be stored in dust free cabinets and tightly sealed with pre-cleaned aluminium foil when not in use. Ideally glassware should be cleaned just before use.

For more detailed information, consult Reference Method No 65: UNEP/IOC/IAEA: Reagent and laboratory ware clean-up procedures for low level contaminant monitoring.

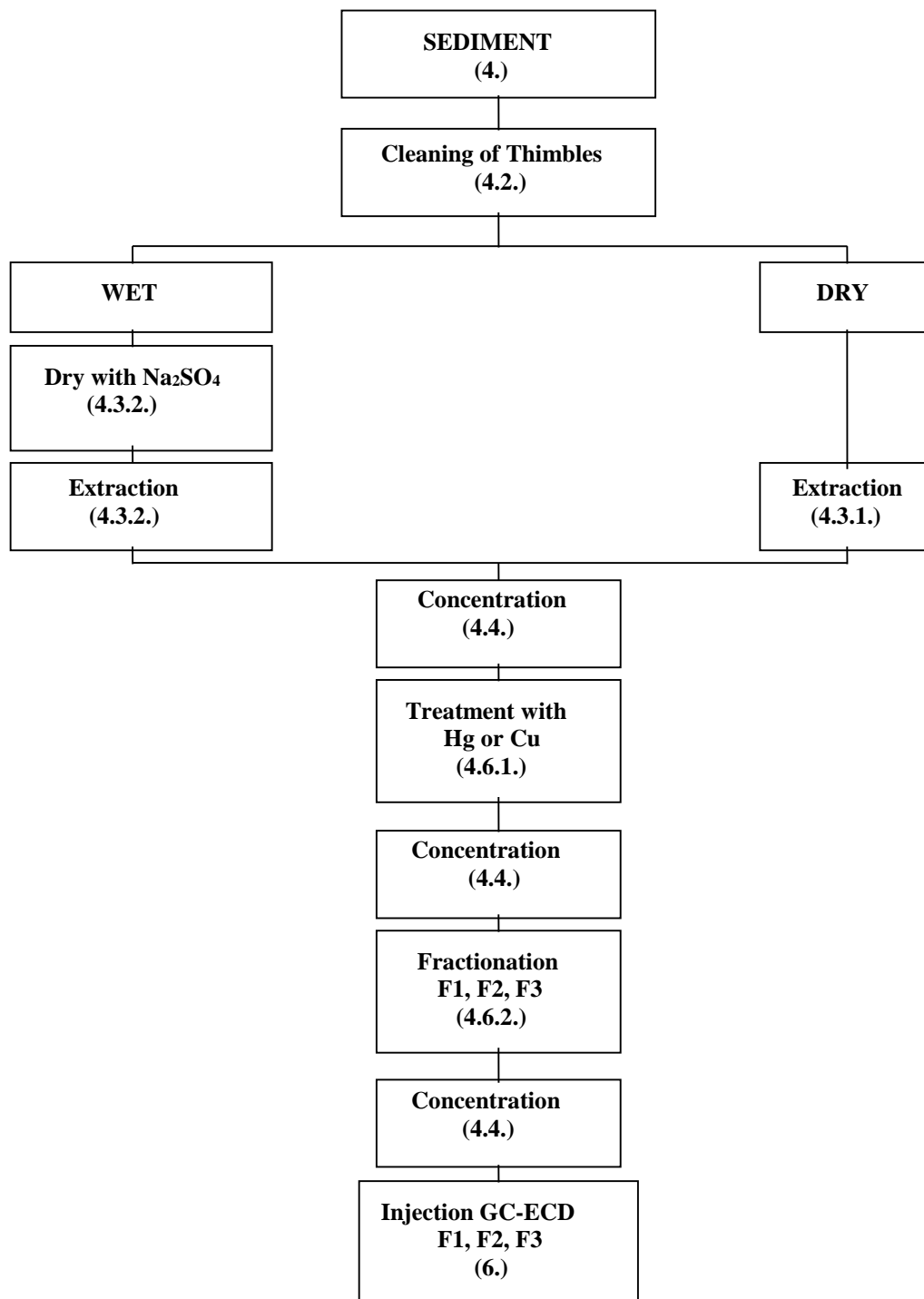

Diagram of the extraction procedure for sediment samples.

4. SEDIMENTS

4.1. Sampling

For the preparation of the samples (including selection of sites, collection of samples and storage) the reader should refer to the Reference Method N° 58: Guidelines for the use of sediments for the marine pollution monitoring programmes, to the Reference Method N° 20: UNEP/IOC/IAEA: Monitoring of petroleum hydrocarbons in sediments and to UNEP(DEC)/MEDW.C282/Inf.5/Rev1: Methods for sediment sampling and analysis (2006).

4.2. Cleaning of extraction thimbles

Paper extraction thimbles should be cleaned prior to sample extraction. For use in the extraction of sediment samples, the extraction can be performed in the Soxhlet apparatus with 250 ml of a mixture hexane / dichloromethane (50:50) for 8 hours cycling the solvent through at a rate of 4 to 5 cycles per hour. Add into the solvent a few carborundum boiling chips to get a regular ebullition.

The use of disposable paper thimbles for the extraction procedure rather than re-usable glass fibre thimbles is recommended due to the difficulties encountered in cleaning the latter.

4.3. Extraction of sediments

4.3.1. Extraction of freeze-dried samples

Select a 50-100 g sub-sample of the sediment, weigh this sub-sample and freeze-dry it. When dried, re-weigh it and calculate the dry to wet ratio. Then pulverise the sample using a pestle and mortar and sieve it using a 250 µm stainless steel sieve. Accurately weigh about 20 g of ground sample and place it in the pre-cleaned extraction thimble. Add 1 ml of a solution of 25 pg/µl of 2,4,5 trichlorobiphenyl (PCB N° 29), 20.9 pg/µl of 2,2',3,3',4,5,5',6 octachlorobiphenyl (PCB N° 198), 20 pg/µl of ε HCH and 21 pg/µl of Endosulfan Id₄ as internal standards and extract for 8 hours in a Soxhlet apparatus with 250 ml of a mixture hexane / dichloromethane (50:50), cycling the solvent through at a rate of 4 to 5 cycles per hour, add into the solvent a few carborundum boiling chips to get a regular ebullition. Alternatively (or in addition), PCB congeners No 30, 121, or octachloronaphthalene and PCB congeners can be used as internal standards. Prepare a procedural blank by extracting an empty thimble using the same procedure as for the samples.

4.3.2. Extraction of wet samples

The sediment is thawed, sieved at 250 µm and homogenised manually with a stainless steel spatula or clean glass rod. A sub-sample of 1-2 g is weighed into a flask and placed in a drying oven at 105 °C for 24 hours, then allowed to cool to room temperature and re-weighed. Calculate the dry to wet ratio and discard the dry sediment (unless it is being used for other analysis e.g. TOC, total organic carbon).

Place a 30-40 g sub-sample of thawed, homogenised sediment into a blender. Slowly, add 100g of anhydrous sodium sulphate (desiccant) and blend the mixture at high speed for 10 minutes. Transfer the dried sample quantitatively to the pre-cleaned extraction thimble in the Soxhlet apparatus, add the internal standard solution (see above) and apply the same extraction procedure as above. Extract the same amount of sodium sulphate as a procedural blank, making sure to add an appropriate amount of internal standard solution.

4.3.3. Example of determination of percent moisture

Many environmental measurements require the results to be reported on a dry weight basis. The percent moisture or water content in the sample is determined by weighing an aliquot, not used for analysis, of the sample before and after drying. The drying can be done by heating a few grams (1-2 g) of the sample in an oven to constant weight.

Weigh an empty glass beaker that will be used to hold the sample while it is dried.

Empty beaker weight = 10.4417 g

Add the wet sample to the beaker and reweigh. Calculate the wet weight of the sample.

Empty beaker weight + wet sample = 12.2972 g

Wet sample weight = 12.2972 g - 10.4417 g = 1.8555 g

Dry the sample to constant weight: dry the sample for 24 hours, weigh it, dry again for 12 hours, re-weigh it, when the difference in weight is less than 5%, it means that the sample is dried.

Empty beaker weight + dry sample weight = 10.9396 g

Dry sample weight = 10.9396 g - Empty beaker weight

Dry sample weight = 10.9396 g - 10.4417 g = 0.4979 g

Calculate the percent dry sample weight.

$$\begin{aligned} \% \text{ Sample weight} &= \frac{\text{Sample dry weight}}{\text{Sample wet weight}} \times 100 \\ &= \frac{0.4979}{1.8555} \times 100 = 26.8 \% \end{aligned}$$

Calculate the percent moisture.

$$\begin{aligned} \text{Water content} &= \text{wet weight} - \text{dry weight} \\ &= 1.855 \text{ g} - 0.4979 \text{ g} = 1.3576 \text{ g} \end{aligned}$$

$$\% \text{ Moisture} = \frac{\text{Sample water weight}}{\text{Sample wet weight}} \times 100$$

$$\% \text{ moisture} = \frac{1.3576}{1.8555} \times 100 = 73.2 \%$$

4.4. Concentration of the extract

For both extraction procedures, the extracts are concentrated in a rotary evaporator to about 15 ml. Under good vacuum conditions the temperature of the water bath must not exceed 30 °C. Dry the extract with anhydrous sodium sulphate (when the sodium sulphate moves freely in the flask it means that the extract is dried). Collect the dried extract in the graduated tube of a Kuderna-Danish concentrator. Concentrate the extract to approximately 5 ml with the Kuderna-Danish concentrator and adjust the volume to exactly 1 ml by evaporating excess solvent under a gentle stream of clean dry nitrogen. The sample extract will be analysed gravimetrically for extractable organic matter (EOM) content at the 1 ml volume as a starting point. If measurements of the EOM are outside the calibration range of the balance, the total volume of the extract is adjusted accordingly using either dilution with hexane or evaporating under a stream of nitrogen gas.

4.5. Extractable organic matter

Before carrying out the clean-up procedure, it is advisable to determine the extractable organic matter.

The EOM is determined in the following manner. On the weighing pan of an electro-balance, evaporate a known volume of the sediment or biota extract (up to 100 µl) and weigh the residue with a precision of about ± 1 µg. If the residue is less than 2 µg, pre-concentration of the original extract is required. The quantity of EOM is:

$$\text{EOM } (\mu\text{g/g}) = \frac{\text{Weight of residue } (\mu\text{g}) \times \text{volume of the extract (ml)} \times 1000}{\text{Volume evaporated } (\mu\text{l}) \times \text{quantity of sample extracted (g)}}$$

Note that extreme care must be taken to ensure balance and pans are clean, dry and stable to obtain accurate readings at the ± 1 µg level. A small hot plate is used to warm pans and forceps and thus keep these instruments dry after solvent cleaning. If no electro-balance is available, a known volume of the extract can be transferred into a clean pre-weighed beaker. The solvent is evaporated with dry and clean nitrogen until a constant weight of about 1 mg is reached. Calculate the amount of “lipids” in the sample taking into account the volume of the lipid extract which was dried.

Example of calculation of E.O.M.

The extractable organic matter content of a sample is operationally defined as the weight of material extracted with the solvent employed (H.E.O.M. in case hexane is used as solvent). An aliquot of the sample extract is taken (few µl), the solvent is evaporated and the residue is weighed to determine the quantity of lipids extracted in the aliquot and from it to the total sample. The results are normally reported in mg lipids per gram dry weight extracted.

A 1 µl aliquot is removed from a 2.5 ml sample extract for determination of E.O.M. The 1 µl aliquot is evaporated on the pan of an electro-balance and the residue is weighed. Three determinations are made and the average taken.

Measurements:

Sample dry weight extracted: 4.443 g

Total volume of the extract: 2.5 ml

Sample aliquot removed: 1 µl

(1) Weight of a 1 µl aliquot after solvent evaporation: 32.2 µg

(2) Weight of a 1 µl aliquot after solvent evaporation: 32.1 µg

(3) Weight of a 1 µl aliquot after solvent evaporation: 32.3 µg

Average weight of a 1 µl aliquot : 32.2 µg

Total volume of the extract: 2.5 ml

Total quantity of lipids in the sample:

$$32.2 \mu\text{g}/\mu\text{l} \times 2.5 \text{ ml} \times \frac{1000 \mu\text{l}}{\text{ml}} = 80500 \mu\text{g} \text{ or: } 80.5 \text{ mg}$$

With 4.443 g of sample extracted:

$$80.5 \text{ mg} / 4.443 \text{ g} = 18.1 \text{ mg lipids/g}$$

4.6. Clean-up procedure and fractionation

Purposes of the clean-up: removal of lipids, whenever present at a significant amount; removal of elementary sulphur and sulphur compounds. Both these compound classes can interfere with the gas-chromatographic separation.

4.6.1. Sulphur and sulphur compounds removal

Elementary sulphur and sulphur compounds such as mercaptans should be removed from the extract. This could be done by using either mercury or activated copper.

a) Mercury method.

Add one drop (a few ml) of mercury to the sediment extract and shake vigorously for one minute. Centrifuge and carefully recover and transfer the extract in another tube with a Pasteur pipette. If the mercury is still tarnished, repeat the treatment with another drop of mercury, shake, transfer the hexane into another tube. Repeat this treatment until the mercury stays brilliant in the extract. Rinse the mercury with 5 ml of hexane and combine the extracts. Then, concentrate the resulting solution to ca. 1 ml with a gentle stream of nitrogen.

Cleaning of mercury:

Caution: When removing mercury from the sample, always use a plastic tray to keep the glassware in and work under a fume hood.

Fit a folded filter paper in a 10 cm diameter conical glass funnel and fix the funnel over a 250 ml glass beaker. Using a needle, make a small hole in the bottom of the filter paper. Carefully put the mercury onto the funnel. The mercury flows through the small hole in the filter paper leaving the solid impurities on its surface. The mercury collected is washed three times by shaking it carefully with dichloromethane and by removing dichloromethane layer with the help of a clean glass syringe. Allow the rest of dichloromethane evaporate and store the clean mercury in a thick walled glass bottle with a ground glass stopper. In order to avoid escape of mercury vapour, store the mercury under methanol.

Another way of cleaning the mercury involves sucking the dirty mercury through a capillary tube, such as a Pasteur pipette, connected to a guard-flask and then to a vacuum pump. The mercury will pass through the Pasteur pipette and will be collected and cleaned in the guard-flask. Then it should be transferred into a thick wall glass bottle with a ground glass stopper. The mercury is covered with a layer of methanol to protect it from oxidation.

b) Activated copper method.

Transfer about 20 grams of the copper powder in an Erlenmeyer. Add enough concentrated HCl to cover the copper powder, agitate. Sonicate for 10 min., agitate, put again in ultrasonic bath and sonicate for 10 min. Throw the used HCl, add some fresh HCl, transfer in ultrasonic bath and sonicate for 20 min. repeat that procedure four times in total. Wash with distilled water, agitate, discard, add water again, transfer in ultrasonic bath and sonicate for 15 min., discard the used water, repeat that procedure again, up to pH neutral. Wash with acetone, agitate, transfer in ultrasonic bath and sonicate for 15 min. repeat that procedure four times in total. Then use the same procedure with hexane as a solvent.

Keep in hexane (use it immediately, avoids Cu to be in contact with air).

Transfer 3 to 4 Pasteur pipettes per sample in the flasks containing the hexane extracts. Let the copper react all night. The presence of sulphur compounds in the sample will be detected by the tarnishing of the copper powder. Then, concentrate the resulting solution to ca. 1 ml with a gentle stream of pure nitrogen.

4.6.2. Fractionation

An adsorption chromatography step is used to remove interfering lipids and to fractionate the extract into classes of compounds. Many variations of adsorption chromatography clean-up procedures have been published to date. Four procedures are reported here in order of increasing complexity.

Preparation of the columns: Glass burettes (1 cm diameter) with Teflon stopcocks make convenient adsorption columns. The column is plugged with pre-cleaned cotton or glass wool. Prepare separate columns for each sample and blank determination. The column is partially filled with hexane. The appropriate amount of sorbent is mixed with hexane in a small beaker to form a slurry. A glass funnel and a glass rod are used to pour the adsorbent into the column. Several rinses with hexane are necessary to fill the column to the desired height. Tap with a pencil or a hard silicone tube against the column in order to settle the adsorbent into an even bed. Flush the material adhering to the wall of the column down to the bed with solvent. Prepare each column freshly immediately before use. Never let the column get dry.

4.6.2.1. Florisil

A Florisil column is used for this fractionation, which is prepared in the following way. The Florisil should be pre-extracted in the Soxhlet apparatus to remove any contaminants, using methanol or dichloromethane for 8 hours, followed by hexane for another 8 hours. It is then dried in an oven. Activation is achieved by heating the dried Florisil at 130°C for 12 hours. It is then partially deactivated with 0.5% water by weight and stored in a tightly sealed glass jar with ground glass stopper. The water should be well mixed into the Florisil and the mixture should be allowed to equilibrate for one day before use. The activation/deactivation procedure should be carried out one day before use. A 1 cm burette with Teflon stopcock is plugged with pre-cleaned glass wool. A column with a sintered glass disk could also be used. 17 grams of Florisil are weighed out in a beaker and covered with hexane. A slurry is made by agitation and poured into the glass column. The Florisil is allowed to settle into an even bed and any Florisil adhering to the column is rinsed down with hexane. The solvent is drained to just above the Florisil bed. It should be rinsed with a further 5 ml of hexane; one gram of anhydrous sodium sulphate is added to the top of the column in order to protect the surface of the Florisil from any disturbance. The column should never run dry. Individual columns should be prepared immediately before use and a new column of Florisil used for each sample.

The extract, reduced to 1 ml, is put onto the Florisil column. It is carefully eluted with 65 ml of hexane and the first fraction collected. Then the column is eluted with 45 ml of a mixture containing 70 % of hexane and 30 % of dichloromethane and the second fraction collected. The third fraction will be eluted with 60 ml of pure dichloromethane.

Fraction one will contain the PCBs, pp' and op DDE and some other pesticides such as HCB, aldrin, heptachlor, DDMU.

Fraction two will contain the DDTs, DDDs, most of the toxaphene, and some pesticides such as the HCH isomers and chlordane components.

Fraction three will contain mainly dieldrin, endrin, heptachlor epoxide and endosulfan components. Typical chromatograms obtained are shown below.

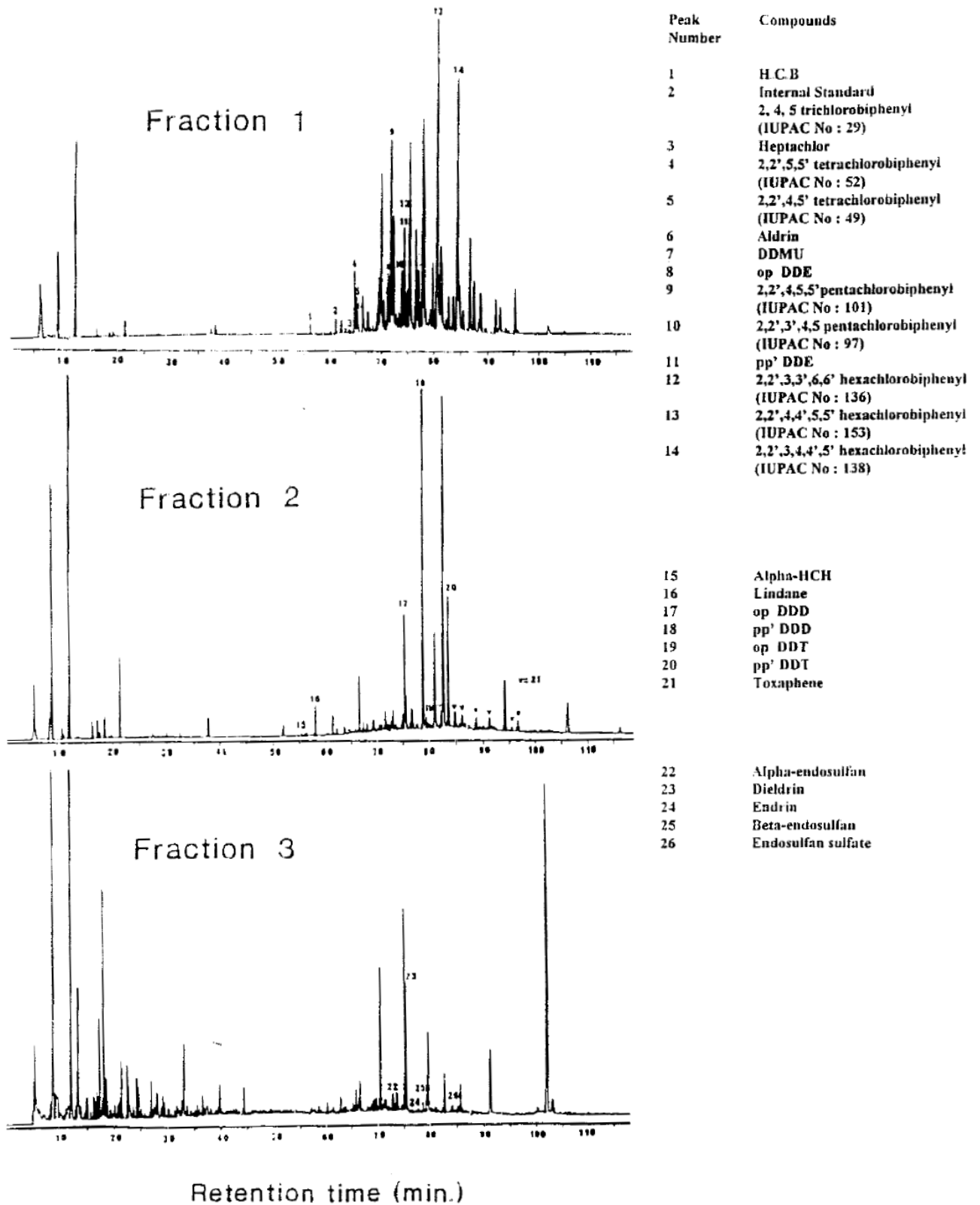

Figure 2: GC-ECD organohalogen analyses

4.6.2.2. Gel permeation chromatography

Low pressure GPC can be used as an alternative clean-up technique to remove high molecular weight co-extractable lipidic material from polycyclic aromatic compounds and halogenated aromatics. Concurrently, elemental sulphur could be also removed from the whole organic extract.

The main feature of the semi-preparative-GPC as a clean-up technique relies on the compatibility of this analytical procedure with labile components of the extract (i.e. DDTs, chlorinated cyclohexadiene derivatives), which are not stable in other types of extract clean-up procedures. Further, GPC as a clean-up technique has already been automated, enabling a high sample throughput, taking into account the short analysis time involved.

The GPC retention mechanism may involve adsorption, partition and size exclusion mechanisms. The predominance of one mechanism over the others is largely determined by the choice of the mobile phase and the pore size of the packing. In the case of GPC packings with large pore size (1000-2000 daltons) size exclusion and adsorption mechanisms prevail (Bio-Beads SX-3 using cyclohexane, dichloromethane-hexane, dichloromethane-cyclohexane, toluene-ethylacetate and ethylacetate-cyclohexane) (Ericksson *et al.*, 1986). On the other hand, when smaller pore sizes (400 daltons) are used in combination with highly polar solvents, (THF, DMF) size exclusion predominates (Lee *et al.*, 1981). While using the first approach, a chemical class fractionation could be obtained, however, if smaller pore sizes are used it should be combined with another fractionation technique (i.e. adsorption chromatography) to achieve this selectivity. It has yet to be demonstrated that using GPC as a single clean-up step produces a completely clean extract for GC-ECD determination. Nevertheless, taking into account the increasing availability of high-resolution low molecular weight exclusion packings, they could definitively integrate fractionation and clean-up in a single step.

Low resolution packing (Sephadex LH and Bio-Beads SX, 200-400 mesh size) are the most widely used because they are inexpensive and afford relatively high sample loading (500 mg in 10 mm i.d. columns). The implementation of low resolution GPC requires a solvent delivery system and a UV detector and may be useful. For method development, it is advisable to inject a broad range of standard compounds covering the whole range of molecular weights of the analytes to be determined in order to determine the cut-off points to fractionate real samples. Reported recoveries of PCBs and PAHs range from 60 to 80 % for the concentration level (ng) injected. (Fernandez and Bayona, 1992).

4.6.2.3. Alumina and HPLC (silica column)

The first step in this clean-up procedure is an adsorption step using an alumina column to remove most of the lipid material. Prepare an alumina column (4 x 0.5 cm i.d., made from a Pasteur pipette). Apply the concentrated extract to the top of the column and elute with 10 ml hexane. Concentrate the eluate to about 200 µl. It is followed by a second step to more completely remove interfering compounds and at the same time to separate the compounds of interest into different fractions, containing aliphatics, PCBs, PAHs, pesticides and toxaphene. Between 20 and 200 µl of the extract (after alumina clean-up) are eluted on a stainless steel column (200 x 4 mm i.d.), packed with Nucleosil 100-5 with n-pentane, 20 % dichloromethane in n-pentane and finally dichloromethane. The eluate is collected in fractions containing 1) n-hydrocarbons, 2) PCBs, 3) PAHs and toxaphene, 4) pesticides and toxaphene and 5) acids, etc. (polar compounds). The size of the fractions has to be determined with standard solutions containing the compounds of interest, collecting the eluate in 0.5 ml fractions. Each fraction is then analysed by GC-ECD. Full details have been given in the literature (Petrick *et al.*, 1988 and IOC, 1993).

4.6.2.4. High pressure chromatography

High pressure liquid chromatography (HPLC) columns packed with microparticles are available and have the advantages of high reproducibility, low consumption of solvents, high efficiency and high sample loading capacity.

This method can be used to separate fractions containing aliphatic hydrocarbons, PCBs and aromatic hydrocarbons from interfering compounds. These fractions can then be analysed separately for their constituents by GC-FID and/or GC-ECD.

HPLC methods have been developed using synthetic solutions of n-alkanes, PAHs, pesticides, PCBs and toxaphene and have been applied to samples in which interfering substances were present in such high concentrations as to render the analysis of HC and PCBs extremely difficult without this clean-up procedure (e.g. sediments and biological tissues with OCs in the ng/g range). The samples are eluted with n-hexane, subjected to clean-up over alumina, concentrated down to 20-200 µl and treated by HPLC. With the use of n-hexane, n-pentane and 10 %, 20 % and 50 % dichloromethane in n-hexane, respectively, the following five fractions are obtained : 1) n-hydrocarbons and alkenes, 2) PCBs and alkylbenzenes, 3) PAHs and toxaphene, 4) pesticides, 5) acids, etc.(polar compounds). (Petrick *et al.* 1988).

5. BIOTA

5.1. Sampling

Organisms accumulate many contaminants from their environment (i.e., from sea water, suspended particulate matter, sediment and food). Field and laboratory studies have shown that contaminant concentrations in some marine plants and animals reflect concentrations in their environment. Scientists use this process (termed bio-accumulation) to assess marine contamination resulting from human activity (e.g., pipeline discharges, dumping from ships).

There are problems with using biota as bio-accumulators (bio-indicators). For example, tissues from individuals of a species exposed to the same contaminant concentration may contain different levels of contamination after the same exposure time. These deviations reflect individual differences in factors such as age, sex, size, and physiological and nutritional states. Also, various species show different contaminant concentrations following identical exposure; differences in elimination rates may partially account for this. These factors must be considered when planning a monitoring programme in order to control their effects on the precision of the analysis (by reducing the variances). Variance reduction is necessary in order to detect smaller differences in mean contaminant concentrations observed in monitoring programmes.

For proper sampling and sample preparation, refer to Reference Method No 6 “Guidelines for monitoring chemical contaminants in the sea using marine organisms” and Reference Method No 12 Rev.2 “Sampling of selected marine organisms and sample preparation for the analysis of chlorinated hydrocarbons”.

5.2. Cleaning of extraction thimbles

As for extraction of sediment samples, thimbles should be extracted first with the same solvent used for the extraction of the sample. As the extraction of biota sample is achieved with hexane, a pre-extraction of these thimbles is made with 250 ml of hexane for 8 hours in the Soxhlet apparatus, cycling the solvent through at a rate of 4 to 5 cycles per hour. Add into the solvent a few carborundum boiling chips to get a regular ebullition.

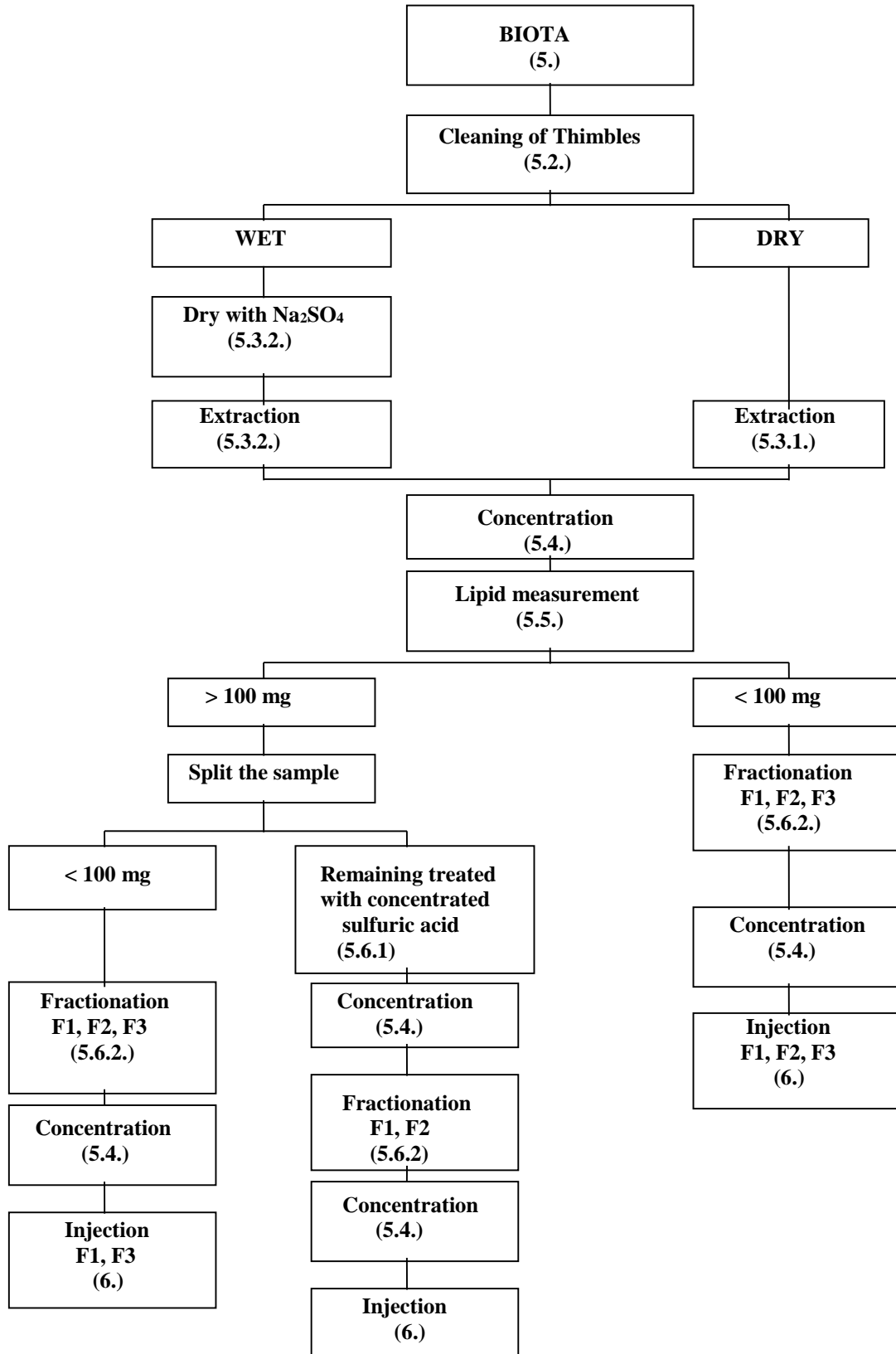

Figure 3: Diagram of the extraction procedure for biota samples.

5.3. Extraction of tissues

5.3.1. Extraction procedure for freeze-dried samples.

Take a 50 to 100 g fresh weight sub-sample from the sample. Weigh this sub-sample and freeze-dry it. When the sub-sample appears to be dry, re-weigh it and freeze-dry it for a further 24 hours and then re-weigh it. If the difference between the two dry weights is greater than 5%, continue the freeze-drying process. Special care must be taken to ensure that the freeze-drier is clean and does not contaminate the samples. The freeze drying procedure should be tested by drying 100 g Na₂SO₄ as a blank and extracting this as a sample. Pulverise the freeze-dried sub-sample carefully using a cleaned pestle and mortar. Accurately weigh about 5 to 10 g of this pulverised material, note the exact weight to be extracted, and place it into a pre-cleaned extraction thimble in a Soxhlet apparatus. The size of the sub-sample should be adjusted so that about 100 mg of extractable organic matter ("lipid") will be obtained. Smaller sub-samples should be used if residue concentrations are expected to be high. Add a known amount of internal standard to the sub-sample in the thimble before Soxhlet extraction. It is important to spike the sample at levels that are near to that of the analyte concentrations in the samples. If, in the end, the analyte and the internal standard concentrations do not fall within the established calibration range of the GC-ECD, the analysis must be repeated. Consequently, it may be advisable to perform range-finding analysis for samples of unknown character beforehand. Candidate internal standards are the same as for sediment samples (see 5.3.). Add about 200 ml of hexane or petroleum ether to the extraction flask with a few carborundum boiling chips, and extract the sample for 8 hours cycling the solvent through at a rate of 4 to 5 cycles per hour. Extract an empty thimble as a procedural blank, making sure to spike it with internal standards in the same fashion as the sample. If unacceptable procedural blanks are found, the source of contamination must be identified and eliminated rather than subtracting high blank values from the analytical results.

5.3.2. Extraction procedure without freeze-drying

Select a 25 to 100 g fresh weight sub-sample and place in a blender. Add anhydrous sodium sulphate to the sample, manually homogenise and determine whether the sample is adequately dried. If not, more sodium sulphate should be added until a dry mixture is obtained. Normally, 3 times by the sample weight used should be enough. Once this has been achieved, blend the mixture at high speed for 1 or 2 minutes until the mixture is well homogenised and the sample appears to be dry. Transfer the mixture to a pre-cleaned extraction thimble, add internal standards as described above and extract the dehydrated tissue with about 200 ml hexane or petroleum ether for 8 hours in a Soxhlet apparatus, cycling 4 to 5 times per hour. Extract the same amount of sodium sulphate as the procedural blank, making sure to add internal standards in the same fashion as the sample.

5.4. Concentration of the extract

Refer to section (4.4.)

5.5. Extractable Organic Matter (EOM)

Refer to section (4.5.)

5.6. Clean-up procedure and fractionation

5.6.1. Removal of lipids by concentrated sulphuric acid

If the lipid content of the extracts is higher than 100-150 mg, a preliminary step for the removal of the lipids is necessary before further sample purification. This can be carried out by using concentrated sulphuric acid. Treatment with sulphuric acid is used when chlorinated hydrocarbons are to be determined. However, sulphuric acid will destroy dieldrin and endrin so that an aliquot of the untreated extract must be set aside for the determination of these compounds.

CAUTION: During all this procedure it is very important to wear safety glasses.

Take an aliquot of the concentrated extract, containing about 200 mg of “lipids”, transfer into a separatory funnel and add to this extract enough hexane in order to dilute the sample (40 to 50 ml should be enough), this will allow recovery of the hexane after acid treatment, because if the sample is too concentrated, the destroyed “lipids” will become almost solid and it will be difficult then to recover the hexane from this solid mass. Add 5 ml concentrated sulphuric acid to the extract and tightly fit the glass stopper and shake vigorously. Invert the funnel and carefully vent the vapours out through the stopcock. Repeat this procedure for several minutes. Place the separatory funnel in a rack and allow the phases to separate. Four or five samples and a spiked blank are convenient to process at one time. The extract should be colourless. Recover the hexane phase into a glass beaker. Dry with sodium sulphate and transfer the hexane into a Kuderna-Danish concentrator. Reduce the volume of the extract by evaporating the solvent with a gentle stream of pure nitrogen to about 1 ml.

5.6.2. Fractionation

Refer to section (4.6.2.)

6. CAPILLARY GAS CHROMATOGRAPHIC DETERMINATIONS

6.1. Gas chromatographic conditions

- Gas chromatograph with a split/splitless injection system, separate regulation system for inlet and column pressures and temperatures; multi-ramp temperature programming facilities (preferably microprocessor controlled), electron capture detector interfaced with the column with electronic control unit and pulsed mode facilities. An integrator with a short response time (0.25 s) is essential.
- Narrow-bore (0.22 mm internal diameter), 25 m long, fused silica open tubular column, coated with SE-54 (0.17 µm film thickness, preferably chemically bonded) with sufficient resolution to separate the relevant peaks in the standards provided for PCB analysis.
- Carrier gas should be high purity H₂. If this is not available or if the GC is not equipped with a special security system for hydrogen leak, He may be used. Gas purification traps should be used with molecular sieves to remove oxygen, moisture and other interfering substances.
- High purity nitrogen gas (99.995 %) as ECD make-up gas can be used (Argon/methane high purity gas is another option).

Conditions:

- H₂ or He carrier gas at inlet pressure of 0.5 to 1 Kg/cm² to achieve a flow rate of 1 to 2 ml/min.
- Make-up gas N₂ or Ar/CH₄ at the flow rate recommended by the manufacturer (between 30 and 60 ml/min.).
- ECD temperature: 300°C

6.2. Column preparation

Fused silica columns are the columns of choice for their inertness and durability (they are extremely flexible). They are made of material that is stable up to 360 °C. The 5 % phenyl methyl silicone gum (SE-54) liquid phase, is present as a thin, (0.17 µm), uniform film which can tolerate temperatures up to 300 °C. SE-54 is relatively resistant to the detrimental effects of solvents, oxygen and water, at least at low temperatures. These columns are even more resistant and durable if the liquid phase is chemically bonded to the support by the manufacturer.

For GC/MS work, it is advised to restrict the film thickness to 0.17 µm because with thicker films some of the phase could be released, resulting in an increase of the noise signal in the GC/MS.

The flexible fused silica columns can be conveniently connected directly to the inlet and outlet systems without the transfer lines used in conventional glass capillary chromatography which often lead to increased dead volume. Low bleed graphite or vespel ferrules provide a good seal.

The presence of extraneous peaks and elevated baseline drift will result in poor detector performance. This can be caused by components which elute from the column, such as residual solvents and low molecular weight liquid phase fractions on new columns and build-up of later eluting compounds on old columns. Conditioning is a necessary step to remove these contaminants. New columns are connected to the inlet (while left unconnected to the detector). Columns are flushed with carrier gas at low temperature for 15 min. to remove the oxygen, then heated at 70-100 °C for 30 min. and finally at 170 °C overnight. The column can be then connected to the detector. Old columns can be heated directly to elevated temperatures overnight. The final temperature is selected as a compromise between time required to develop a stable baseline and expected column life. Thus, it may be necessary for older columns to be heated to the maximum temperature of the liquid phase resulting in shorter column life. The temperature of the ECD, when connected to the column, should always be at least 50 °C higher than the column, in order to avoid condensation of the material onto the detector foil. It is essential that carrier gas flows through the column at all times when at elevated temperatures. Even short exposure of the column to higher temperature without sufficient flow will ruin the column.

CAUTION: if H₂ is used as a carrier gas, position the column end outside of the oven to avoid explosion risk.

6.3. Column test

When the column has been connected to the detector, the carrier gas flow is set to 30 ml per minute for a column with 4 mm internal diameter. The column performance is then measured according to the criteria of the “number of theoretical plates” for a specific compound and can be achieved according to the following procedure.

- Set injector and detector temperatures at 200 and 300°C respectively and the column oven temperature at 180 °C.
- Inject pp’ DDT standard and measure the retention time (Tr). Adjust the column temperature to get a pp’ DDT retention time relative to Aldrin of 3.03.
- Measure the width of the pp’ DDT peak at its half height ($b_{1/2}$), in minutes and the retention time (Tr) also in minutes.
- Calculate the number of theoretical plates using the formula:

$$N = 5.54 \left(\frac{Tr}{b_{1/2}} \right)^2$$

- A parameter which is independent of the column length is the height equivalent to a theoretical plate (HETP):

$$HETP = \frac{L}{N}$$

Where L is the column length. Adjust the flow rate of the carrier gas to obtain optimum performance. The HETP should be as low as possible (i.e. the number of theoretical plates should be as great as possible).

The column remains in optimum condition as long as the liquid phase exists as a thin, uniform film. The quality of the film at the inlet side may be degraded as a result of repeated splitless

injections. Decreased column quality may be remedied by the removal of the end of the column (10 to 20 cm) at the inlet side. Chemically bonded liquid phases require less maintenance.

6.4. Electron capture detector

High-energy electrons, emitted by a radioactive source within the detector (e.g. a ^{63}Ni foil), are subject to repeated collisions with carrier gas molecules, producing secondary electrons. These electrons, upon returning to their normal state, can be captured by sample molecules, eluting from a GC column. The resulting reduction in cell current is the operating principle of an electron capture detector. The detector current produced is actually a non-linear function of the concentration of electron-capturing material. However, the useful linear range of an ECD may be greatly improved if the instrument is operated at a constant current, but in a pulsed mode, i.e. with short voltage pulses being applied to the cell electrodes. The current in the cell is kept constant by varying the frequency of the pulses.

Contamination of the detector (and thus lower sensitivity) may result from high-boiling organic compounds eluting from the column. Periodic heating to 350°C may overcome this problem. The ^{63}Ni ECD can be used at 320°C under normal operational conditions, in order to limit such contamination.

The optimum flow for an ECD (30 to 60 ml/min.) is much higher than carrier gas flow through the column of one or two ml/min. Thus an additional detector purge flow is necessary (N_2 or Ar/CH_4). Once leaving the outlet of the column, the compounds have to be taken up into an increased gas flow in order to avoid extra-volume band broadening within the detector. Thus, the detector purge flow also serves as the sweep gas.

6.5. Quantification

The most widely used information for identification of a peak is its retention time, or its relative retention time (i.e., the adjusted retention time relative to that of a selected reference compound). Retention behaviour is temperature dependent and comparison of retention times obtained at two or more temperatures may aid in determining a peak's identity. However, retention times are not specific and despite the high resolution offered by capillary columns, two compounds of interest in the same sample may have identical retention times.

One way of using retention indexes could be to inject di-n-alkyl-phthalates such as a mixture containing di-n-methyl-phthalate, di-n-ethyl-phthalate, di-n-propyl-phthalate, di-n-butyl-phthalate, di-n-hexyl-phthalate and di-n-heptyl-phthalate, which will cover the elution range from 70°C to 260°C . An arbitrary index of 100 is given to the di-n-methyl phthalate, 200 to the di-n-ethyl phthalate, and so on up to 700 to the di-n-heptyl phthalate; it is possible to identify all chlorinated pesticides by a proper retention index. This will be used also for unknown compounds which can be found easily on the GC/MS using the same index and so, identified. (Villeneuve J.P. 1986).

PCBs represent a complex mixture of compounds that cannot all be resolved on a packed column. Also there is no simple standard available for their quantification. Each peak in a sample chromatogram might correspond to a mixture of more than one individual compound. These difficulties have led to the recommendation of various quantification procedures. The usual method to quantify PCBs is to compare packed-column chromatograms of commercially available industrial formulations (Aroclors, Clophens, Phenoclor) with the sample chromatogram. Most commonly, it is possible to match one single formulation, such as Aroclor 1254 or Aroclor 1260 with the sample chromatogram. An industrial formulation (or mixture of formulations) should be chosen to be as close a match as possible and in the case of sample extracts from sediment or organisms, Aroclor 1254 and Aroclor 1260 are most frequently chosen.

For the second fraction obtained on Florisil separation, it is possible to quantify DDTs after comparison with the retention times of peaks in the sample chromatogram to those in the corresponding standard, the peak heights (or peak areas) are measured and related to the peak height (or peak area) in the standard according to the formula:

$$[\text{Concentration}] = \frac{h \times C \times V \times 1000}{h' \times V(\text{inj}) \times M \times R} \text{ ng/g (or pg/g)}$$

Where:

- V = total extract volume (ml)
- M = weight of sample extracted (g)
- H = peak height of the compound in the sample
- h' = peak height of the compound in the standard
- C = quantity of standard injected (ng or pg)
- V (inj) = volume of sample injected (µl)
- R = Recovery of the sample

7. COMPUTERIZED GAS CHROMATOGRAPHY/MASS SPECTROMETRY (GC/MS)

7.1. Operating conditions

The chemical ionisation source of a mass spectrometer can be used to produce negative ions by electron capture reactions (CI-NI-MS) using a non-reactive enhancement gas such as methane or argon. CI-NI has the advantage of being highly selective, permitting the detection of specific compounds in complex matrices. Under CI-NI conditions, methane (99.99 %) is used as the reagent gas. Samples are introduced through a SE-54, 30 m x 0.25 mm i.d., fused silica column. The film thickness used is 0.17 µm in order to minimise the bleeding of the phase into the system. Helium is used as carrier gas with an inlet pressure of 13 psi, which gives a carrier flow of 1.5 ml/min. or a gas velocity of 44 cm/sec.

The temperature of the injection port is held at 250°C.

The temperature of the source is set at 240°C, the quadrupole at 100°C and the interface at 285°C.

Injections of 1-3 µl are made in the splitless mode.

The temperature programme of the oven starts at 70°C, for 2 minutes, then it is increased at 3°C/min. to 260°C and kept under isothermal conditions for 40 minutes.

File : C:\HPCHEM\1\DATA\AR1254.D
Operator : jpv
Acquired : 12 Jul 95 8:02 am using AcqMethod OC
Instrument : 5989B
Sample Name: standard ar1254
Misc Info :
Vial Number: 1

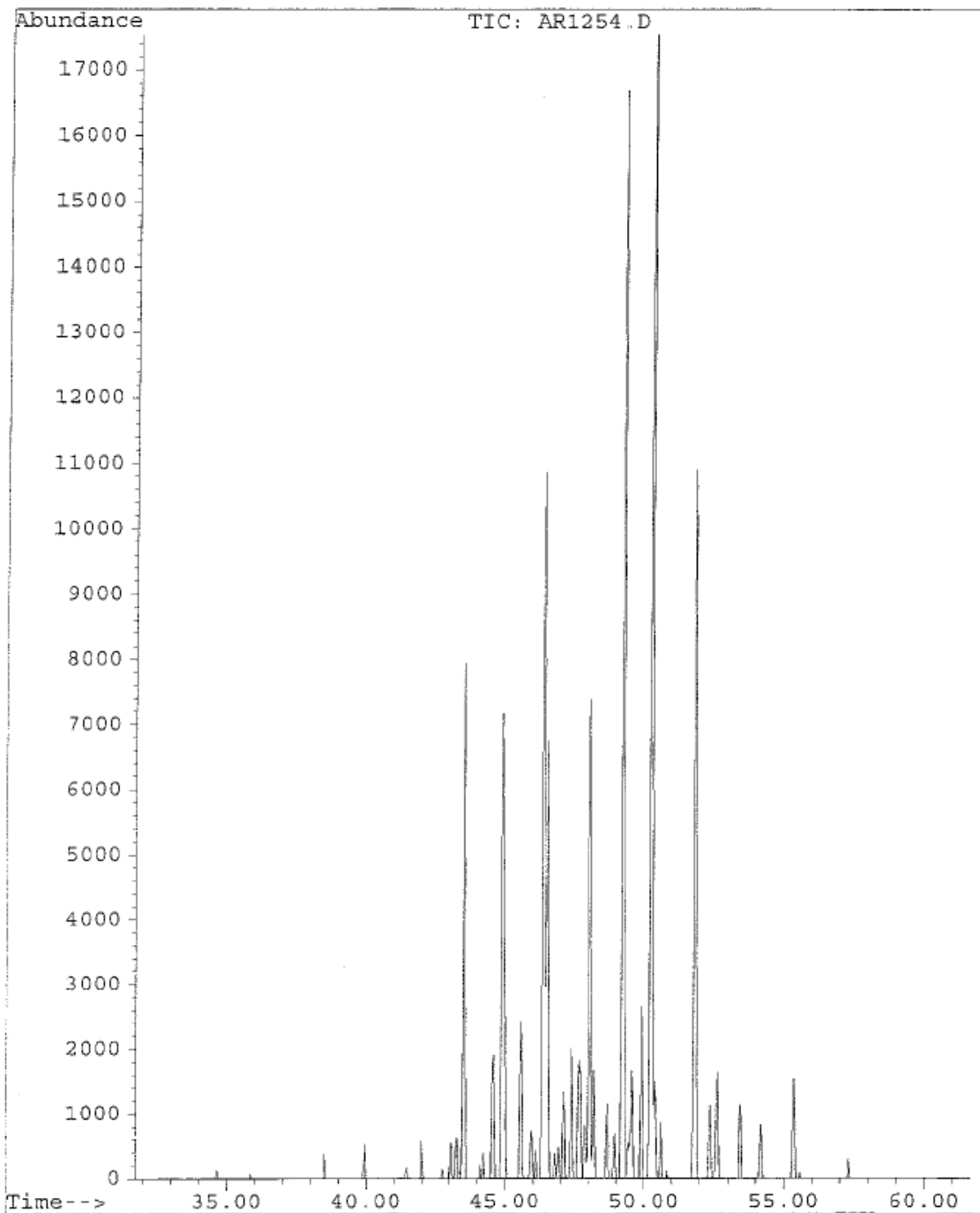

Figure 4: TIC of Aroclor 1254

File : C:\HPCHEM\1\DATA\AR1254.D
Operator : jpv
Acquired : 12 Jul 95 8:02 am using AcqMethod OC
Instrument : 5989B
Sample Name: standard ar1254
Misc Info :
Vial Number: 1

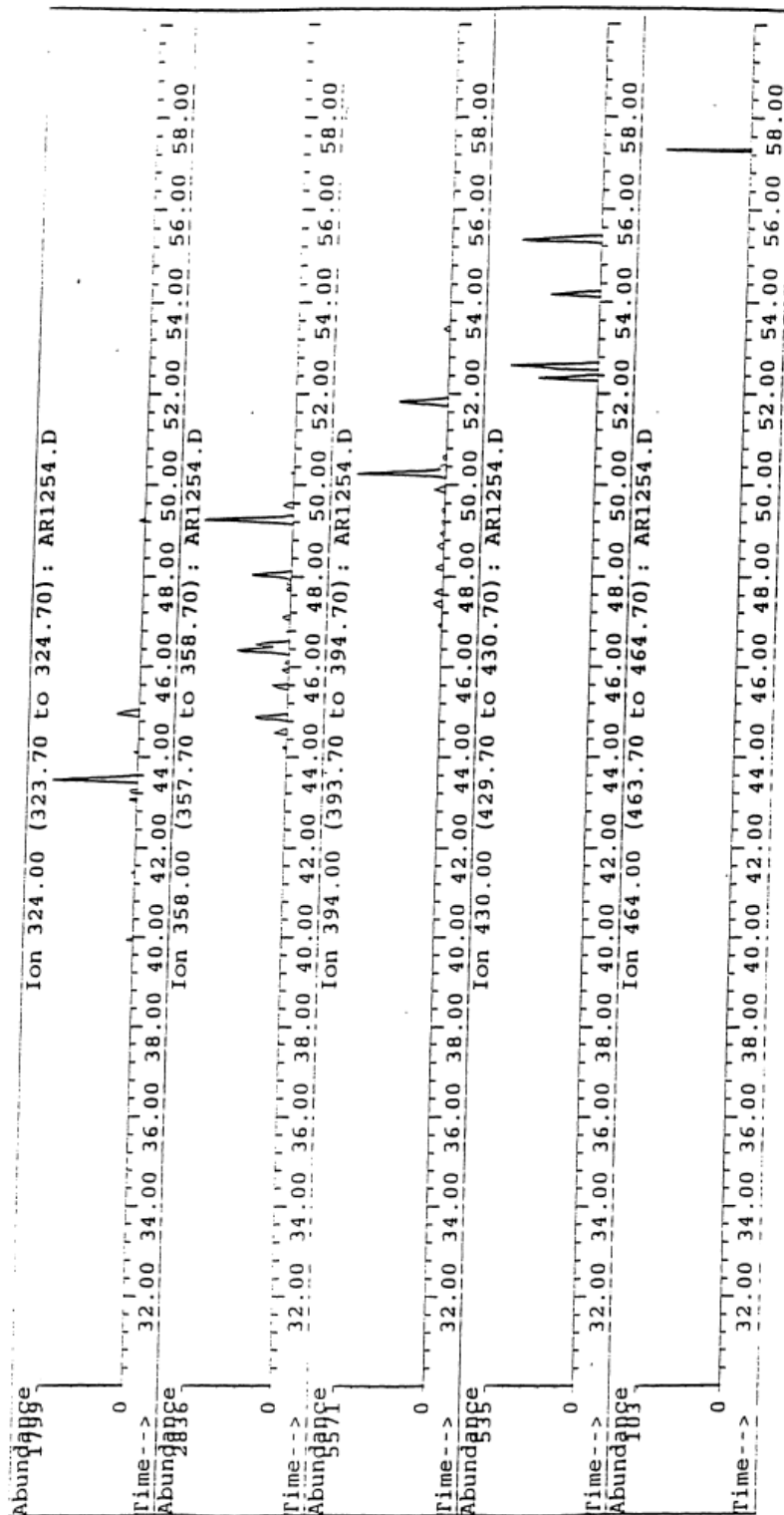

Figure 5: RIC of Aroclor 1254 main compounds

File : C:\HPCHEM\1\DATA\AR1260.D
Operator : jpv
Acquired : 12 Jul 95 9:42 am using AcqMethod OC
Instrument : 5989B
Sample Name: standard ar1260
Misc Info :
Vial Number: 1

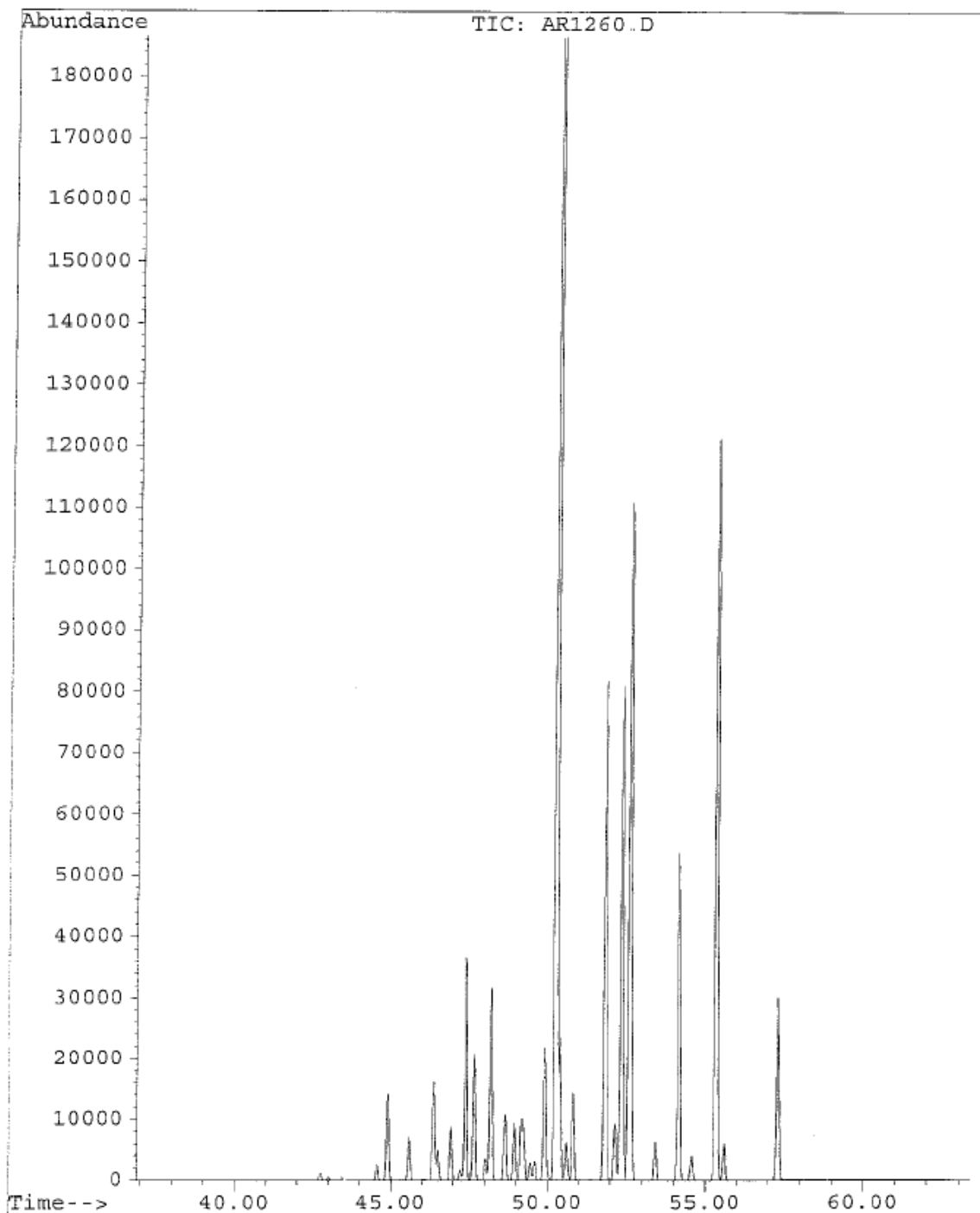

Figure 6: TIC of Aroclor 1260

File : C:\HPCHEM\1\DATA\AR1260.D
 Operator : jpv
 Acquired : 12 Jul 95 9:42 am using AcqMethod OC
 Instrument : 5989B
 Sample Name: standard ar1260
 Misc Info :
 Vial Number: 1

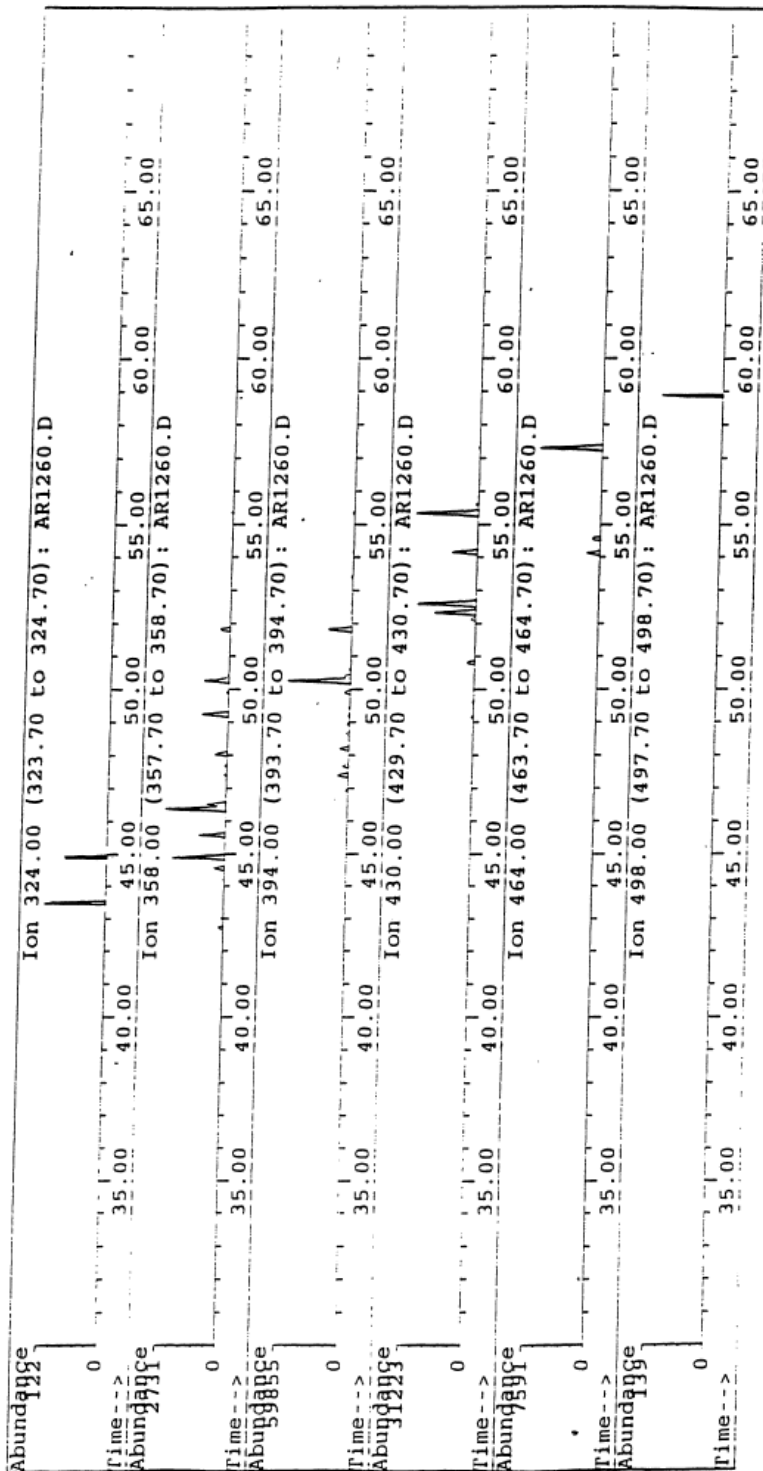

Figure 7: RIC of Aroclor 1260 main compounds

7.2. Example of a selected ion monitoring programme useful for quantitative analysis of chlorinated compounds.

Compounds	Fraction N° on Florisil	Retention Time (min.)	Target Ion (daltons)
HCB	1	37-38	284
Heptachlor	1	44-45	266
Aldrin	1	46-48	237
op DDE	1	51-53	246
Transnonachlor	1	52-54	444
pp' DDE	1	53-55	281
PCBs			
3 Cl	1		258
4 Cl	1		292
5 Cl	1	40-55	324
6 Cl	1	40-55	358
7 Cl	1	45-55	394
8 Cl	1	45-60	430
9 Cl	1	50-60	464
10 Cl	1	58-60	498
α HCH	2	37-39	255
β HCH	2	39-41	255
γ HCH (Lindane)	2	39-41	255
δ HCH	2	41-43	255
γ Chlordane	2	51-53	410
α Chlordane	2	52-54	266
op DDD	2	54-56	248
pp' DDD	2	56-58	248
op DDT	2	56-58	246
pp' DDT	2	58-60	283
Heptachlor epoxide	3	49-51	318
α Endosulfan	3	52-54	406
Dieldrin	3	53-55	346
Endrin	3	55-57	346
β Endosulfan	3	55-57	406
Endosulfan sulfate	3	58-60	386

8. NOTES ON WATER ANALYSIS

The levels of lipophilic compounds in tissues of aquatic organisms and organic fractions of sediments are determined to a large extent by the levels of these compounds in the surrounding water (marine mammals are an obvious exception). Data for CBs and hydrocarbons in sea water is therefore extremely useful for an understanding of the levels in organisms. However, the levels in sea water are extremely low and consequently, their determination needs considerable experience. Large volumes of water are required and extreme care has to be taken in order to avoid contamination during sampling, extraction and clean-up of the samples. Details are described in Manual and guide No 27 of IOC, 1993 and Villeneuve J.P. (1986).

9. ALTERNATIVE PROCEDURES

9.1. Combining sample preparation and extraction for chlorinated and petroleum hydrocarbons in sediment samples.

In the event that analyses for petroleum hydrocarbons and chlorinated compounds (and/or sterols) are of interest, the following extraction procedure can be used. To the freeze-dried sample introduce internal standards for each compound class. The following are suggested: 1) aliphatic hydrocarbons: - n-C₁₄ d₃₀, n-C₁₉ d₄₀, n-C₃₂ d₆₆, 2) polycyclic aromatic hydrocarbons: Naphthalene d₈,

Hexamethylbenzene, Cadalene (deuterated PAHs are also useful), 3) organochlorine compounds: PCB congeners 29, 30, 121 or 198, ϵ HCH and Endosulfan Id₄, 4) sterols: 5 α (H)-androstan-3 β -ol. These standards are used for quantifying the recovery of the total procedure. Samples are Soxhlet extracted for 8 hours with 250 ml of a mixture hexane / dichloromethane (50:50), cycling the solvent through at a rate of 4 to 5 cycles per hour. The solvent extract is concentrated by rotary evaporation down to 15 ml and transferred to a Kuderna-Danish tube. It is then further concentrated down to 5-6 ml under nitrogen gas. Following removal of sulphur and water, the extract is separated into aliquots: 1/3 for petroleum hydrocarbons and sterols and 2/3 for chlorinated hydrocarbons.

Note: Mercury method should be used only if chlorinated pesticides and PCBs are analysed. If the combined method is used for petroleum and chlorinated hydrocarbons, then the copper method should be used instead of mercury that will destroy some of the PAHs.

9.2. Supercritical fluid extraction (SFE) of marine samples

Sample preparation is probably the most time-consuming and labor-intensive analytical task performed in a laboratory. Studies shows that 60 % of the overall sample analysis time is spent in sample preparation which is the main source of error and of contamination. In addition, the amount of hazardous chemicals used for sample preparation is a continuous source of concern. Due to safe handling and disposal requirements, the reduction of their use is a priority for laboratories worldwide.

Supercritical fluids are gases (i.e. N₂O and CO₂) at room temperature and pressures above the critical point. The SFE technique allows an efficient extraction of a variety of contaminants with considerable reduction in the analysis cost, sample amount and allows the extraction of the thermal sensitive substances, reducing the amount of environmentally hazardous solvents.

A small change in the pressure of a supercritical fluid results in a big change in its density and the solvent strength of the fluid changes with changing density. As a result, one supercritical fluid easily performs the work of many solvents. If this is not enough, it is possible to add a modifier, such as methanol (a few per cent) to increase the solvating range of the fluid. Therefore, SFE should speed up the sample preparation process, minimising the wastes associated with the analysis.

Until now, the main fields of analytical applications of SFE are related to environmental studies and to the food-processing industry (Hawthorne, 1990, Bayona, 1993). A method using carbon dioxide (80°C-340 atm) for the extraction of total petroleum hydrocarbons has been approved as an EPA standard method. The extraction efficiency of modified CO₂ for the recovery of 41 organochlorine and 47 organophosphorus pesticides spiked on sand at different pressures and temperatures were higher than 80%. Furthermore, by increasing the extraction temperature up to 200°C, PCBs and PAHs can be extracted from naturally occurring samples with neat CO₂. Nam *et al.* (1991), have developed a method for rapid determination of polychlorinated organics in complex matrices. The method is based on direct coupling of supercritical fluid extraction with tandem supercritical fluid chromatography and gas chromatography. The on-line system permits simultaneous extraction and analysis with high reproducibility and accuracy.

**Selection guide for CO₂ extraction of common pollutants
 (from Hewlett-Packard)**

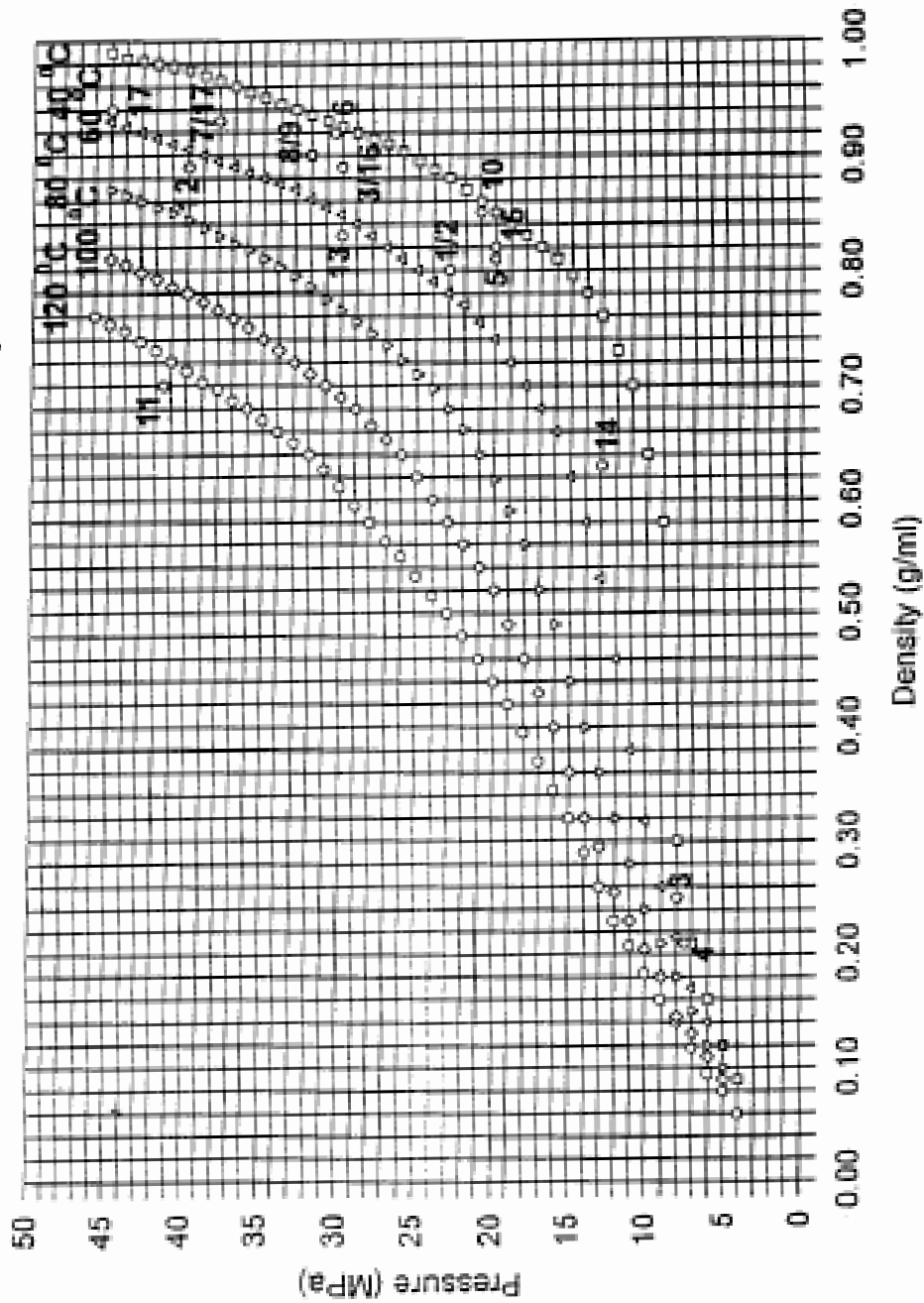

Figure 8: Guide for CO₂ extractions

9.3. Microwave assisted extraction for marine samples

9.3.1 Sediment

Another alternative method for the extraction of chlorinated hydrocarbons in sediment samples (or combined extraction for chlorinated hydrocarbons and petroleum hydrocarbons) is the use of the Microwave oven instead of the Soxhlet extractor. The main advantage of the microwave oven is the fact that, for one sample, only 40 ml of solvent mixture are used instead of 250 ml for clean-up of extraction thimbles and 250 ml for the extraction itself.

10 to 15 grams of freeze-dried sediment sample, ground and sieved at 250 µm, are put in the glass tube of the reactor. Appropriate internal standards (for OCs and/or PHs, see 10.1.) are added to the sample for recovery and samples are extracted with 40 ml of a mixture of hexane / dichloromethane (50:50).

Extraction is realised within the following cycle:

- Power of the microwaves: 1200 watts
- Temperature increase to 115 °C in 10 minutes.
- Extraction maintained at 115 °C for 30 minutes
- Cooling to ambient temperature within one hour.

The carousel containing 14 reactors, 12 samples could be extracted together with one blank and one Reference Material within 1 and half hour and with 10 times less solvent mixture than the standard Soxhlet extraction.

After cooling down to room temperature the solvent mixture is recovered in a 100 ml glass flask. The sediment is poured in a glass funnel containing a plug made of glass wool. The extracted sediment is washed with 10 - 20 ml of hexane. The extract follows then the procedure of clean-up and fractionation.

9.3.2 Biota

3 to 8 grams of freeze-dried biota sample is accurately weighted, the weight to be extracted is noted, and it is placed into the pre-cleaned glass tube of the reactor. A known amount of internal standard is added to the sub-sample in the tube before extraction. Candidate internal standards are the same than for sediment samples refers to section (5.3.1.)

Extraction is realized with 30 ml of a mixture hexane / acetone (90:10) within the following cycle:

- Power of the microwaves: 1200 watts
- Temperature increase to 115 °C in 10 minutes.
- Extraction maintained at 115 °C for 20 minutes
- Cooling to ambient temperature within one hour.

The carousel containing 14 reactors, 12 samples could be extracted with one blank and one Reference Material within 1 and half hour and with 10 times less solvent mixture than the standard Soxhlet extraction.

After cooling down to room temperature the solvent mixture is recovered in a 100 ml glass flask. The powder of biota is poured in a glass funnel containing a plug made of glass wool. The extracted biota is washed with 10 - 20 ml of hexane. The extract is then concentrated with rotary evaporator and ready for E.O.M, clean-up and fractionation procedure.

10. DATA INTERPRETATION

10.1. DDT

The residence time of total DDT in the environment is relatively short ($t_{1/2} = 3-5$ years), so, at least 75-80 % of the current total DDT should be in the form of DDE or DDD if it was introduced into the environment before the 1975 ban. Values of Henry's law constant indicate that these compounds can reach the troposphere as vapour. These vapours are little adsorbed by airborne particulate matter and represent the major component in atmospheric chlorinated hydrocarbon levels. Vapour movements of these pollutants suggest that restrictions and regulations operating in the more technically advanced countries could only be partially effective on a worldwide basis.

The presence of the *op* DDT together with anomalous *pp'* DDT values in environmental samples indicates a recent treatment with this insecticide.

10.2. PCBs congeners

Among the 209 possible PCB congeners, seven of them: 28, 52, 101, 118, 138, 153 and 180, were selected as the most relevant because of their distribution in the chromatogram and in the chlorination range.

Recently, attention has been paid to congeners having 2 para-chlorines and at least 1 meta-chlorine. These congeners are called "coplanar" PCBs. Among the 209 congeners, 20 members attain coplanarity due to non-ortho chlorine substitution in the biphenyl ring. Three of these show the same range of toxicity as the 2,3,7,8 tetrachlorodibenzo-p-dioxin and the 2,3,7,8 tetrachlorodibenzofuran, these are the IUPAC N^o: 77, 126 and 169. These compounds should be identified and quantified in the environmental samples with high priority. They can be separated using fractionation with carbon chromatography (Tanabe *et al.*, 1986).

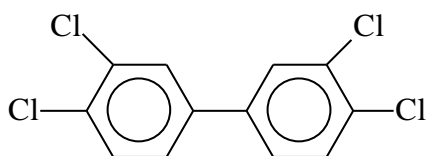

3,3',4,4' tetrachlorobiphenyl
IUPAC N^o: 77

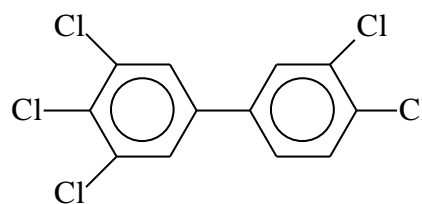

3,3',4,4',5 pentachlorobiphenyl
IUPAC N^o: 126

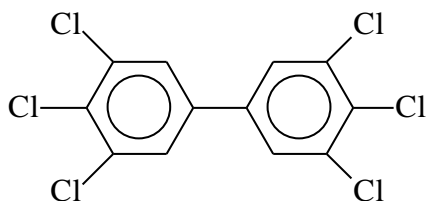

3,3',4,4',5,5' hexachlorobiphenyl
IUPAC N^o: 169

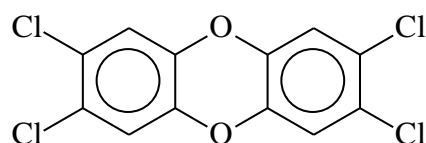

2,3,7,8 tetrachlorodibenzo-p-dioxin

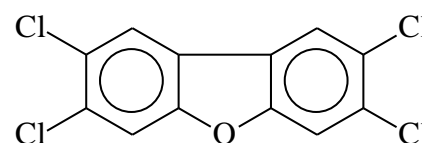

2,3,7,8 tetrachlorodibenzofuran

10.3. Typical profiles of commercial mixtures

Formulations available in different countries are slightly different in their composition (Aroclor in USA, Kanechlor in Japan, Clophen in Germany, Phenoclor in France, Fenclor in Italy or Sovol in Russia). For the same global composition, such as Aroclor 1254, KC-500 or Phenoclor DP-5, the composition of individual congeners differs by 5-10 %. If a sample is collected on the French coast (therefore, contaminated with DP-5), and is quantified with DP-5 and Aroclor 1254, the difference observed in concentration could be in the order of 5-10 %. This shows the importance of choosing one common standard for the quantification of global industrial formulations or the importance of quantifying with individual congeners.

Percent contribution of individual chlorobiphenyls to Clophen A 50 and Aroclor 1254.

PCB N°	Clophen A50	Aroclor 1254	PCB N°	Clophen A50	Aroclor 1254
17	0	0.19	115	0.28	0.3
18	0	0.41	118	10.9	6.39
28	0.05	0.25	119	0.19	0.14
31	0.05	0.22	122	0.19	0.5
33	0.11	0.14	123	0.85	0.81
40	0.28	0.2	126	0.08	0
41	0.83	0.64	128	3.04	2.07
42	0.13	0.23	129	0.83	0.23
44	2.46	2.03	130	0.83	0.63
47	0.18	0.11	131	0.06	0.16
48	0.17	0.14	132	2.57	1.98
49	1.96	1.64	134	0.52	0.49
52	5.53	5.18	135	1.61	1.62
53	0.06	0.09	136	0.91	1.12
56	0.44	0.58	137	0.25	0.25
60	0.34	0.54	138	3.61	3.2
63	0.15	0.05	141	0.98	1.04
64	0.71	0.45	146	0.8	0.83
66	0.5	0.59	149	4.5	2.21
67	0.13	0.09	151	1.22	1.17
70	3.85	3.21	153	4.17	4.26
74	1.35	0.78	156	1.43	1.62
82	1.05	0.95	157	0.31	0
83	0.53	0.45	158	0.98	0.77
84	2.08	1.95	167	0.35	0.21
85	1.85	1.66	170	0.65	0.31
87	4.22	3.78	171	0.5	0.5
90	0.85	0.93	172	0.09	0.05
91	0.92	0.83	173	0.09	0.09
92	1.53	1.58	174	0.37	0.34
95	6	6.02	175	0.11	0.05
96	0.05	0.08	176	0.43	0.32
97	2.8	2.55	177	0.21	0.21
99	4.06	3.6	178	0.19	1.35
100	0.15	0.1	179	0.2	0.21
101	7.72	7.94	180	0.53	0.38
105	1.9	3.83	183	0.21	0.17
107	0.94	0.72	187	0.3	0.32
110	6.27	5.85	190	0.05	0.08
			201	0.6	0.68

11. QUALITY ASSURANCE / QUALITY CONTROL

Guidelines on the QA/QC requirements for analysis of sediments and marine organisms are detailed in Reference Method No 57, "Contaminant monitoring programs using marine organisms: Quality assurance and good laboratory practice". Brief descriptions of issues that must be addressed in the course of understanding the procedures described here are given below.

11.1. Precision

The precision of the method should be established by replicate analysis of samples of the appropriate matrix. Estimate the precision of the entire analytical procedure by extracting five sub-samples from the same sample after homogenisation. Alternatively, perform replicate analysis of an appropriate certified reference material (RM; see below) containing the analytes of interest. The principal advantage of using a RM is that the material permits the simultaneous evaluation of accuracy while offering a well homogenised sample. Precision should be evaluated as a matter of course during the initial implementation procedure just before initiation of sample analysis.

11.2. Accuracy

The accuracy of the methods described here must be confirmed by analysis of a suitable RM (i.e. appropriate matrix, analytes) prior to initiation of sample analysis. Agreement between measured and certified concentrations for any individual analyte should be within 35 % and on average within 25%. It is advisable to introduce RMs on a regular basis (e.g. every 10-20 samples) as a method of checking the procedure. Further description of the preparation of control charts and criteria for data acceptance are discussed in Reference Method N° 57.

11.3. Blanks

Blanks represent an opportunity to evaluate and monitor the potential introduction of contaminants into samples during processing. Contributions to the analyte signal can arise from contaminants in the reagents, those arising from passive contact between the sample and the environment (e.g. the atmosphere) and those introduced during sample handling by hands, implements or glassware. It is essential to establish a consistently low (i.e. with respect to analytes) blank prior to initiating analysis or even the determination of the method detection limit. In addition, it is necessary to perform blank determinations on a regular basis (e.g. every batch of samples).

11.4. Recovery

Recovery reflects the ability of the analyst to fully recover surrogate compounds introduced to the sample matrix or blank at the beginning of the procedure. The primary criteria for selection of compounds to be used for testing recovery are that they: 1) have physical (i.e. chromatographic/partitioning) properties similar to and if necessary spanning those of the analytes of interest, 2) do not suffer from interferences during gas chromatographic analysis, 3) are baseline resolved from the analytes of interest.

Recovery should be tested on all samples and blanks as a routine matter of course. Recoveries below 70% are to be considered unacceptable. Recoveries in excess of 100 % may indicate the presence of interference.

11.5. Archiving and reporting of results

Every sample should have an associated worksheet which follows the samples and the extracts through the various stages of the procedure and upon which the analyst notes all relevant details. An example of such a worksheet is given below. Each laboratory should construct and complete such a worksheet. Relevant chromatograms should be attached to the worksheet. Analyses should be grouped

and composite or summary analysis sheets archived with each group. Final disposal of the data will depend on the reasons for which it was collected but should follow the overall plan model.

All processed samples should be archived at all steps of the procedure:

- deep frozen (in the deep-freezer as it was received).
- freeze-dried (in sealed glass container kept in a dark place).
- extracted (after injection on the GC, sample extracts should be concentrated down to 1 ml and transferred into sealed glass vials, a Pasteur pipette sealed with a butane burner is adequate and cheap).

Sample: IAEA-357 : Marine Sediment

wet wt.

----- =, % water in freeze dried sample determined by drying at 105°C :
dry wt.

.....g freeze-dried wt. extracted with hexane in Soxhlet extractor for 8 hours.

.....pg PCB N°29,pg PCB N°198,pg ε HCH and pg Endosulfan Id₄ were added as internal standard.

Theml extract was reduced by rotary evaporator to approximatelyml.

This was treated with sodium sulfate to dry the extract. Then treated with mercury to remove sulphur. This was further reduced toml for lipid determinations. Corrected dry wt. :g.

Lipid determinations:

.....ml total extract;

10 µl aliquots weighed on micro-balance:mg;mg;mg.

HEOM =mg/g dry weight.

.....mg lipid subjected to column chromatography fractionation on Florisil.

F1:ml hexane

F2:ml hexane/dichloromethane (70:30)

F3:ml dichloromethane

GC determinations:

PCB N°29 :ng recovered in F1 :% Recovery.

PCB N°198 :ng recovered in F1 :% Recovery.

ε HCH :ng recovered in F2 :% Recovery.

Endosulfan Id₄:ng recovered in F3 :% Recovery.

Attach tabulation of individual compounds quantified in sample.

Sample worksheet for analysis of chlorinated compounds in marine sediments.

12. REFERENCES

- Bayona, J.M. (1993). The role of supercritical fluid extraction in sample preparation. *Robotics Lab. Autom.* 5, 156-187.
- Eganhouse, R.P. and Kaplan, I.R. (1988). Depositional history of recent sediments from San Pedro shelf, California: Reconstruction using elemental abundance, isotopic composition and molecular markers. *Mar. Chem.*, 24 (2), 163-191.
- Eisenreich, S.J., Capel, P.D., Robbins, J.A. and Bourbonniere, R. (1989). Accumulation and diagenesis of chlorinated hydrocarbons in lacustrine sediments. *Environ. Sci. and Technol.*, 23, 1116-1126.
- Ericksson, M.D. (1986). *Analytical Chemistry of PCBs*, Butterworth, Stonehaus, 149-153.
- Fernandez, P., Porte, C., Barcelo, D., Bayona, J.M. and Albaiges, J. (1988). Selective enrichment procedures for the determination of polychlorinated biphenyls and polycyclic aromatic hydrocarbons in environmental samples by gel permeation chromatography. *J. Chromatogr.* 456, 155-164.
- Fernandez, P. and Bayona, J.M. (1992). Use of off-line gel permeation chromatography - normal phase liquid chromatography for the determination of polycyclic aromatic compounds in environmental samples and standard reference materials (air particulate matter and marine sediment). *J. Chromatogr.*, 625, 141-149.
- Hawthorne, S.B. (1990). Analytical-scale supercritical fluid extraction, *Anal. Chem.*, 62, 633A-642A.
- Hom, W., Risebrough, R.W., Soutar, A. and Young, D.R. (1974). Deposition of DDE and polychlorinated biphenyls in dated sediments of the Santa Barbara basin. *Science*, 184, 1197-1199.
- Langenfeld, J.J., Hawthorne, S.B., Miller, D.J. and Pawliszyn, J. (1993). Effects of temperature and pressure on supercritical fluid extraction efficiencies of polycyclic aromatic hydrocarbons and polychlorinated biphenyls. *Anal. Chem.* 65, 338-344.
- Lee, M.L., Novotny, M.V. and Bartle, K.D. (1981), in *Analytical Chemistry of Polycyclic Aromatic Compounds*, Academic Press, New York, 143-152.
- Lopez-Avila, V., Dohiwala, N.S. and Beckert, W.F. (1990). "Supercritical fluid extraction and its applications to environmental analysis. *J. Chromatogr. Sci.* , 28, 468-79.
- Lopez-Avila, V., Benedicto, J., Dohiwala, N.S., Young, R. and Beckert, W.F. (1992). Development of an off-line SFR-IR method for petroleum hydrocarbons in solids. *J. Chromatogr. Sci.*, 30, 335-343.

Manuals and Guides No 27. IOC (1993).

- Nam, K.S., Kapila, S., Yanders, A.F. and Puri, R.K. (1991). A multiple sample extraction and on-line system for the analysis of chlorinated compounds. *Chemosphere*, 23, 1109-1116.
- Petrick, G., Schulz, D.E. and Duinker, J.C. (1988). Clean-up of environmental samples by high-performance liquid chromatography for analysis of organochlorine compounds by gas chromatography with electron-capture detection. *J. Chromatogr.*, 435, 241-248.
- Reference Method No 6, UNEP/FAO/IOC/IAEA: Guidelines for monitoring chemical contaminants in the sea using marine organisms. UNEP, 1993.
- Reference Method No 12 Rev.2, UNEP/FAO/IOC/IAEA: Sampling of selected marine organisms and sample preparation for the analysis of chlorinated hydrocarbons. UNEP, 1991.
- Reference Method No 20, UNEP/IOC/IAEA: Determination of petroleum hydrocarbons in sediments. UNEP, 1992.
- Reference Method No 57, UNEP/IOC/IAEA/FAO: Contaminant monitoring programme using marine organisms: Quality assurance and good laboratory practice. UNEP, 1990.

Reference Method No 58: Guidelines for the use of sediments for marine pollution monitoring programmes. (in preparation).

Reference Method No 65, UNEP/IOC/IAEA: Reagent and laboratory ware clean-up procedures for low-level contaminants monitoring. (in preparation).

Tanabe, S., Kannan, N., Wakimoto, T. and Tatsukawa, R. (1986). Method for the determination of three toxic non-ortho-chlorine substituted co-planar PCBs in environmental samples at part-per-trillion levels. Intern. J. Environ. Anal. Chem. Vol. 29, 199-213.

UNEP (DEC)/MED WG.282/Inf.5/Rev1: Methods for sediment sampling and analysis (2006).

Villeneuve, J.P. (1986). Géochimie des composés organochlorés dans l'environnement marin. Thèse de Doctorat de l'Université Paris VI. 180 pages.

ANNEX

**PREPARATION OF THE SOLUTION OF INTERNAL STANDARDS:
PCB No 29, PCB No 198, ε HCH and Endosulfan I d4**

Stock Solution of PCB No 29:

1 ml from the original vial (250ng/μl) should be transferred into a 100 ml volumetric flask, and then the volume is adjusted to 100 ml with hexane. This stock solution contains:

2.5 ng/μl of PCB No 29

Stock Solution of Endosulfan I d4:

1 ml from the original vial (250ng/μl) should be transferred into a 100 ml volumetric flask, and then the volume is adjusted to 100 ml with hexane. This stock solution contains:

2.5 ng/μl of Endosulfan I d₄

Working solution of internal standards:

0.5 ml from the stock solution of PCB No 29 (2.5 ng/μl) should be transferred into a 50 ml volumetric flask, then, 0.5 ml from the stock solution of Endosulfan I d₄ (2.5 ng/μl) should be transferred into the volumetric flask, then 1 ml from the original vial (1ng/μl) of ε HCH should be transferred into that volumetric flask, then 0.5 ml from the concentrated solution (2ng/μl) of PCB No 198, and the volume adjusted to 50 ml with hexane. This working solution contains:

25 pg/μl of PCB No 29

20 pg/μl of PCB No 198

20 pg/μl of ε HCH

25 pg/μl of Endosulfan I d₄

CAUTION: VIALS SHOULD BE COOLED AT 20°C PRIOR TO OPENING

Preparation of the Aroclor 1254 solution

Preparation of the stock solution:

1 ml from the original vial should be transferred into a 100 ml volumetric flask, then, the volume is adjusted to 100 ml with hexane. This stock solution contains:

6.5 ng/μl of Aroclor 1254

Preparation of the working solution:

1 ml from this stock solution should be transferred into a 50 ml volumetric flask and the volume adjusted to 50 ml with hexane. This working solution contains :

0.13 ng/μl of Aroclor 1254

CAUTION : VIAL SHOULD BE COOLED TO 20 °C PRIOR TO OPENING

Preparation of the Aroclor 1260 solution

Preparation of the stock solution:

1 ml from the original vial should be transferred into a 100 ml volumetric flask, then the volume is adjusted to 100 ml with hexane. This solution contains:

5.44 ng/μl of Aroclor 1260

Preparation of the working solution:

1 ml from the stock solution should be transferred into a 50 ml volumetric flask, then the volume is adjusted to 50 ml with hexane. This working solution contains

0.1088 ng/μl of Aroclor 1260

CAUTION: VIAL SHOULD BE COOLED TO 20 °C PRIOR TO OPENING

Preparation of the pp' DDE, pp' DDD and pp' DDT solution

pp' DDE:

Stock solution: 1 ml from the original vial should be transferred into a 100 ml volumetric flask, then the volume is adjusted to 100 ml with hexane. This stock solution contains:

5 ng/μl of pp' DDE

pp' DDD:

Stock solution: 1 ml from the original vial should be transferred into a 100 ml volumetric flask, then the volume is adjusted to 100 ml with hexane. This solution contains:

5 ng/μl of pp' DDD

pp' DDT:

Stock solution: 1 ml of the original vial should be transferred into a 100 ml volumetric flask, then the volume is adjusted to 100 ml with hexane. This stock solution contains:

5 ng/μl of pp' DDT

Working solution: pp' DDE, pp' DDD and pp' DDT together.

1 ml from the stock solution of pp' DDE, 2 ml of the stock solution of pp' DDD and 3 ml of the stock solution of pp' DDT should be transferred into a 100 ml volumetric flask and the volume adjusted to 100 ml with hexane. This solution contains

- pp' DDE : 50 pg/μl
- pp' DDD : 100 pg/μl
- pp' DDT : 150 pg/μl

NOTE: Further dilution may be necessary depending on the sensitivity of the EC Detector.

CAUTION: VIAL SHOULD BE COOLED TO 20 °C PRIOR TO OPENING

Preparation of Aldrin, Dieldrin and Endrin standard solutions:

Aldrin:

Stock solution: 1 ml from the original vial should be transferred into a 100 ml volumetric flask, then the volume is adjusted to 100 ml with hexane. This solution contains:

5 ng/μl of Aldrin

Dieldrin:

Stock solution: 1 ml from the original vial should be transferred into a 100 ml volumetric flask, then the volume is adjusted to 100 ml with hexane. This solution contains:

5 ng/μl of Dieldrin

Endrin:

Stock solution: 1 ml from the original vial should be transferred into a 100 ml volumetric flask, then the volume is adjusted to 100 ml with hexane. This solution contains:

5 ng/μl of Endrin

Working solution: Aldrin, Dieldrin and Endrin together.

1 ml from the stock solution of Aldrin, 1 ml from the stock solution of Dieldrin and 1 ml from the stock solution of Endrin are transferred into a 100 ml volumetric flask and the volume is adjusted to 100 ml with hexane. This working solution contains:

Aldrin : 50 pg/μl
Dieldrin : 50 pg/μl
Endrin : 50 pg/μl

NOTE: Further dilution may be necessary depending on the sensitivity of the detector.

CAUTION: VIALS SHOULD BE COOLED TO 20 °C PRIOR TO OPENING

Preparation of the HCB and Lindane standard solutions:

HCB:

Stock solution: 1 ml from the original vial should be transferred into a 100 ml volumetric flask, then the volume is adjusted to 100 ml with hexane. This solution contains:

5 ng/μl of HCB

Lindane:

Stock solution: 1 ml from the original vial should be transferred into a 100 ml volumetric flask, then the volume is adjusted to 100 ml with hexane. This solution contains:

5 ng/μl of lindane

Working solution:

1 ml from the stock solution of HCB and 1 ml from the stock solution of Lindane are transferred into a 100 ml volumetric flask, then the volume is adjusted to 100 ml with hexane. This solution contains:

HCB : 50 pg/μl

Lindane : 50 pg/μl

NOTE: further dilution may be necessary depending on the sensitivity of the EC Detector.

CAUTION: VIALS SHOULD BE COOLED TO 20 °C PRIOR TO OPENING

Preparation of the PCB congeners solution

In a 100 ml volumetric flask, transfer 1 ml from the original vial. Adjust to 100 ml with hexane in order to obtain the working solution with the following concentrations:

CB N°:	Compounds:	Concentrations (pg/μl)
8	2,4'	17.50
18	2,2',5	12
31	2,4',5	10.6
28	2,4,4'	4.6
52	2,2',5,5'	8.6
49	2,2',4,5'	12.1
44	2,2',3,5'	10.7
66	2,3',4,4'	5.5
95	2,2',3,5',6	5.7
101	2,2',4,5,5'	9.3
110	2,3,3',4',6	11.1
149	2,2',3,4',5',6	12.1
118	2,3',4,4',5	8.5
153	2,2',4,4',5,5'	8.4
138	2,2',3,4,4',5'	13.8
183	2,2',3,4,4',5',6	10.3
174	2,2',3,3',4',5,6'	9.4
177	2,2',3,3',4',5,6	9.5
180	2,2',3,4,4',5,5'	16.3
170	2,2',3,3',4,4',5	13.4
199	2,2',3,3',4,5,5',6'	9.3
194	2,2',3,3',4,4',5,5'	12.6

Separate into 10 volumetric flasks of 10 ml, seal with Teflon tape and keep in refrigerated place in order not to evaporate them.

CAUTION: VIAL SHOULD BE COOLED TO 20 °C PRIOR TO OPENING

EUNOCI 221-02937-0, E05 SED @ BHIMADZU

14:241	15.223	15.961	17.859	19.88	21.880	21.728	22.598	25.850	27.665	48.812	48.873	44.546	45.661	50.523	8	54.133	18	56.927	31	58.927	28	52.791	52	68.927	49	62.827	44	62.827	66 + 95	66.927	101	68.927	110	71.867	118	72.791	153	74.827	183	74.827	174	76.194	177	78.194	180	80.298	170	82.178	199	84.751	86.664	86.664	194
--------	--------	--------	--------	-------	--------	--------	--------	--------	--------	--------	--------	--------	--------	--------	---	--------	----	--------	----	--------	----	--------	----	--------	----	--------	----	--------	---------	--------	-----	--------	-----	--------	-----	--------	-----	--------	-----	--------	-----	--------	-----	--------	-----	--------	-----	--------	-----	--------	--------	--------	-----

Issued and printed by

Oceans and Coastal Areas Programme Activity Centre
United Nations Environment Programme

Additional copies of this and other publications issued by
the Oceans and Coastal Areas Programme Activity Centre
can be obtained from:

Oceans and Coastal Areas Programme Activity Centre
United Nations Environment Programme
P.O. Box 30552
Nairobi
Kenya

Or from:

Marine Environmental Studies Laboratory
International Atomic Energy Agency
Environment Laboratories
4 Quai Antoine 1^{er}
98000 MONACO

Annex X:

OSPAR COMMISSION

CEMP Guidelines for Monitoring Contaminants in Sediments

(OSPAR Agreement 2002-16)

Technical Annex 2: technical annex on the analysis of PCBs in sediments

Determination of chlorobiphenyls in sediments – analytical method



CEMP Guidelines for Monitoring Contaminants in Sediments

(OSPAR Agreement 2002-16)

Technical Annex 2: technical annex on the analysis of PCBs in sediments

Determination of chlorobiphenyls in sediments – analytical method

1. Introduction

This annex provides advice on (chlorinated biphenyl) CB analysis for all sediment fractions and suspended particulate matter (*e.g.* < 2mm fraction and < 20µm fraction). The guideline is an update of the earlier version (Smedes and de Boer, 1994 and 1997) taking into account evolutions in the field of analytical chemistry and also covering the determination of planar CBs. Basically, these consist of mono-*ortho* (CB105, CB114, CB118, CB123, CB156, CB157, CB167 and CB189) and non-*ortho* substituted CBs (CB81, CB77, CB126 and CB169). When reviewing the literature, it should be noted that planar, coplanar and dioxin-like CBs / PCBs are all equivalent terms. OSPAR SIME has advised that monitoring for planar CBs in sediments should only take place when the concentrations of marker (non-planar) CBs are *e.g.* 100 times higher than the Background Assessment Concentrations for those compounds.

The analysis of CBs in sediments generally involves extraction with organic solvents, clean-up (removal of sulphur and column fractionation), and gas chromatographic separation with electron-capture or mass spectrometric detection. All stages of the procedure are susceptible to insufficient recovery of analytes and/or contamination. Quality control procedures are recommended in order to check the method's performance. These guidelines are intended to encourage and assist analytical chemists to reconsider their methods and to improve their procedures and/or the associated quality control measures where necessary. Due to the low concentrations of, particularly, non-*ortho* substituted CBs in sediments compared to those of other CBs, their determination requires an additional separation and concentration step. Therefore, in the relevant sections a distinction will be made between the non-*ortho* substituted CBs and the others.

These guidelines can also be used for several other groups of organochlorine compounds, *e.g.* DDTs and their metabolites, chlorobenzenes and hexachlorocyclohexanes. Recoveries in the clean-up procedures must be checked carefully. In particular, treatment with H₂SO₄ results in a loss of some compounds (*e.g.* dieldrin and endosulfanes (de Boer and Wells, 1996). Also, the clean-up procedure with silver ions can result in low recoveries for some pesticides (*e.g.* hexachlorocyclohexanes).

These guidelines are not intended as a complete laboratory manual. If necessary, guidance should be sought from highly specialised research laboratories. Whichever analytical procedure is adopted, each laboratory must demonstrate the validity of each step in the procedure. In addition, the use of a

second (and different) method, carried out concurrently with the routine procedure is recommended for validation. Analyses must be carried out by experienced staff.

2. Sampling and storage

Plastic materials (except polyethylene or polytetrafluorethene) must not be used for sampling due to the possible adsorption of contaminants onto the container material. Samples should be stored in solvent washed aluminium cans or glass jars. Aluminium cans are preferred, as glass jars are more susceptible to breakage. Samples should be transported in closed containers; a temperature of 25°C should not be exceeded. If samples are not analysed within 48 h after sampling, they must be stored in the short term at 4°C. Storage over several months or longer should be limited to those samples which have been frozen (< -20°C) and dried samples.

3. Precautionary measures

Solvents, chemicals and adsorption materials must be free of CBs or other interfering compounds. If not they should be purified using appropriate methods. Solvents should be checked by concentrating the volume normally used in the procedure to 10% of the final volume and then determining the presence of CBs and other interfering compounds by GC analysis. If necessary, the solvents can be purified by re-distillation but this practice is not favoured by most analytical laboratories as they generally opt to buy high quality solvents directly. Chemicals and adsorption materials should be purified by extraction and/or heating. Glass fibre materials (e.g. Soxhlet thimbles and filter papers used in pressurised liquid extraction (PLE)) should be cleaned by solvent extraction or pre-baked at 450°C overnight. Alternatively, glass thimbles with a G1 glass filter at the bottom can be used. Generally, paper filters should be avoided and substituted by appropriate glass filters. As all super cleaned materials are prone to contamination (e.g. by the adsorption of CBs and other compounds from laboratory air), materials ready for use should be held in sealed containers and should not be stored for long periods. All containers, tools, glassware *etc.* which come into contact with the sample must be made of appropriate material and must have been thoroughly pre-cleaned. Glassware should be extensively washed with detergents, heated at > 250°C and rinsed immediately before use with organic solvents or mixtures such as hexane/acetone. In addition, all glassware should preferably be covered with aluminium foil and stored in cupboards to keep out any dust. Old and scratched glassware is more likely to cause blank problems because of the larger surface and therefore greater chance of adsorption. Furthermore, scratched glassware can be more difficult to clean. All glassware should be stored in clean cupboards, ensuring dust cannot enter (QUASIMEME, 2007)

4. Pre-treatment

Before taking a subsample for analysis, the samples should be sufficiently homogenised.

CBs can be extracted from wet or dried samples, although storage, homogenisation and extraction are much easier when the samples are dry. Drying the samples, however, may alter the concentrations e.g. by the loss of compounds through evaporation or by contamination (Smedes and de Boer, 1994 and 1997). Losses and contamination must be accounted for.

Chemical drying can be performed by grinding with Na_2SO_4 or MgSO_4 until the sample reaches a free-flowing consistency. It is essential that there are at least several hours between grinding and extraction to allow for complete dehydration of the sample; any residual water will decrease the extraction efficiency.

Freeze-drying is becoming a more popular technique, although its application should be carefully considered. Possible losses or contamination must be checked. Losses through evaporation are diminished by keeping the temperature in the evaporation chamber below 0°C . Contamination during freeze-drying is reduced by putting a lid, with a hole of about 3 mm in diameter, on the sample container.

5. Extraction

The target compounds must be extracted from the sediment with an organic solvent prior to analysis. Extraction methods do not differ for planar CBs but, because of the low concentrations, a substantially larger sample intake has to be considered. Generally, at least a 100 g sample of freeze-dried sediment is required.

5.1 Wet sediments

Wet sediments are extracted in a step-wise procedure by mixing them with organic solvents. Extraction is enhanced by shaking, Ultra Turrax mixing, ball mill tumbler or ultrasonic treatment. Water miscible solvents are used (especially in the first step) such as methanol, acetone, acetonitrile, *etc.* The extraction efficiency of the first step is low as there will be a considerable amount of water in the liquid phase at that stage. The extraction is continued with a mixture of polar and apolar solvents (*e.g.* acetone/hexane or methanol/dichloromethane). For adequate extraction of target compounds, wet sediments must be extracted with organic solvents at least three times. The contact time with the solvent should be sufficient to complete the desorption of the CBs from the sediment.

When using a Soxhlet, extraction of wet sediments should be done in two steps. A polar solvent, such as acetone, is first used to extract the water from the sediment and then the flask is replaced and the extraction continued with a polar/apolar mixture such as acetone/hexane.

In both cases water must be added to the combined extracts and the CBs must be extracted to an apolar solvent such as hexane.

5.2 Dry sediments

For dried sediments, Soxhlet extraction is the most frequently used technique. A mixture of a polar and an apolar solvent (*e.g.* acetone/hexane) is recommended for efficient extraction; a good choice is 25% acetone in hexane. A greater proportion of polar solvent increases the extraction efficiency, but the polar solvent must be removed prior to gas chromatographic analysis. Extraction can be carried out with a normal Soxhlet or a hot Soxhlet apparatus. A sufficient number of extraction cycles must be performed (ca. 8 h for the hot Soxhlet and ca. 12 to 24 h for normal Soxhlet extraction). The extraction efficiency must be checked for different types of sediments by a second extraction step. These extracts should be analysed separately.

Although the use of binary non-polar/polar solvent mixtures and Soxhlet is still the benchmark for CB extraction, there have been numerous attempts to find alternative procedures, which are less time-consuming, use less solvent and/or enable miniaturisation. Amongst these novel approaches are

pressurised liquid extraction (PLE) and related subcritical water extraction (SWE), microwave-assisted extraction (MAE), matrix solid-phase dispersion (MSPD), ultrasound extraction (US) and supercritical fluid extraction (SFE).

From among the techniques mentioned, PLE or Accelerated Solvent Extraction (ASE) has – so far – been most successful. Soxhlet methods are easily translated into PLE as the same solvent compositions can be used. The method further allows interesting modifications that include in-cell clean-up of samples by adding fat retainers, such as florisil or alumina, to the cell, and the use of a small carbon column in the extraction cell, which selectively adsorbs dioxin-like compounds (subsequently isolated by back-flushing with toluene) (Sporring *et al.*, 2003). PLE and MAE have the shared advantage over SFE that they are matrix-independent, which facilitates method development and changing-over from the classical Soxhlet extraction. Recent years have also seen an increased use of ultrasound-based techniques for analytes isolation from solid samples. With most applications, extraction efficiency is fully satisfactory, and sonication time often is 30 min or less (Roose and Brinkman, 2005).

All the methods described above are in principle suitable for extracting CBs from sediments. However, Soxhlet extraction is still the reference for alternative approaches.

6. Clean-up

6.1 Removal of sulphur and sulphur-containing compounds

An aqueous saturated Na_2SO_3 solution is added to a hexane extract. In order to allow the transfer of the HSO_3^- ions to the organic phase, tetrabutylammonium salts (TBA) and *iso*-propanol are then added to the mixture. Water is subsequently added to remove the *iso*-propanol. The aqueous phase must then be quantitatively extracted with hexane (Jensen *et al.*, 1977). If the extraction was performed by a polar solvent miscible with water, then a Na_2SO_3 solution can be added directly after extraction. If the extraction mixture also contains an apolar solvent, then depending on the ratio of the solvents, the addition of TBA and *iso*-propanol may or may not be necessary. Any excess Na_2SO_3 and reaction products can be removed by the addition of water and thus partitioning between apolar solvent and water.

Japenga *et al.* (1987) developed a column method for the removal of sulphur and sulphur-containing compounds. The column material is made by mixing an aqueous solution of Na_2SO_3 with Al_2O_3 . Some NaOH is also added to improve the reaction with sulphur. Subsequently the material is dried under nitrogen until a level of deactivation equivalent to 10 % water is reached. Storage must be under nitrogen because sulphite in this form may easily be oxidised to sulphate. Eluting the extract (hexane) through a column filled with this material results in removal of the sulphur in combination with further clean-up of the sediment extract. The sulphur removal properties are somewhat difficult to control.

Mercury, activated copper powder, wire or gauze (Smedes and de Boer, 1994 and 1997; Wade and Cantillo, 1996) remove the sulphur directly from an organic solvent. Although mercury is appropriate for removing sulphur, it should be avoided for environmental reasons. Copper can be applied during or after Soxhlet extraction. Ultrasonic treatment might improve the removal of sulphur. If sulphur appears to be present in the final extract the amount of copper or mercury used was insufficient and the clean-up procedure must be repeated.

Silver ions strongly bind sulphur and sulphur compounds. Loaded onto silica, AgNO₃ is a very efficient sulphur removing agent. It can be prepared by mixing dissolved AgNO₃ with silica and subsequently drying under nitrogen. Compounds containing aromatic rings are strongly retained, but for CBs this retention is reduced, probably due to shielding of the rings by the chlorine atoms. Retained compounds can easily be eluted by using cyclohexene, or another solvent with double bonds, as a modifier (Eganhouse, 1986; Japenga *et al.*, 1987).

Elemental sulphur is strongly retained on a polystyrene-divinylbenzene copolymer column as generally applied for gel permeation chromatography (GPC). In addition, GPC combines sulphur removal with a clean-up stage.

All these methods have advantages and disadvantages. For different samples, the use of multiple methods may sometimes prove necessary. Several of the methods leave some aromatic sulphur compounds in the extract. These compounds elute from the GC column at similar retention times to some of the lower-chlorinated CBs. The major part of these compounds can be removed by eluting an apolar extract over a column with silica loaded with concentrated H₂SO₄. Other interfering compounds (*e.g.* phthalates and fatty acid esters) are also removed by using this procedure.

6.2 Further clean-up

The extraction procedures above will result in the co-extraction of many compounds other than CBs. The extract may be coloured due to pigments extracted from sediment, and may also contain sulphur and sulphur-containing compounds, oil, PAHs and many other natural and anthropogenic compounds which will need to be removed from the extract. Different clean-up techniques may be used, either singly or in combination, and the choice will be influenced by the selectivity and sensitivity of the final measurement technique and also by the extraction method employed. Most CBs are stable under acid conditions; therefore treatment with sulphuric acid or acid impregnated silica columns may be used in the clean-up.

The most commonly used clean-up methods involve the use of alumina or silica adsorption chromatography, but gel permeation chromatography (GPC) is also employed.

As CBs are apolar, clean-up using normal-phase chromatography is the most appropriate technique for the separation from other compounds. Using an apolar solvent (*e.g.* hexane or *iso*-octane) as an eluent, CBs normally elute very rapidly. All polar solvents used in the extraction or sulphur removal step should be removed before further clean-up. The last concentration step is usually performed by evaporation with a gentle stream of nitrogen. Evaporation to dryness should always be avoided.

Deactivated Al₂O₃ (with 5-10% water) is often used as a primary clean-up method. Provided that sulphur has been removed beforehand, Al₂O₃ clean-up sometimes yields a sufficiently clean extract for a GC-ECD analysis of the sample to be performed. Al₂O₃ removes lipid compounds from the extracts (although samples with a very high lipid content and low CB concentrations may require additional clean-up).

Deactivated silica (with 1-5% water) does not retain CBs (including planar CBs) and only slightly retains polycyclic aromatic hydrocarbons (PAHs) when eluted with hexane or *iso*-octane. When organochlorine pesticides are also to be determined in the same extract, deactivation of the silica with a few percent of water is essential.

For high activity silica (overnight at 180°C) the retention of CBs is negligible, while PAHs are more strongly retained. The CBs and a few other organochlorine compounds are eluted with apolar solvents. More polar solvents (*e.g.* hexane/acetone) should be avoided as some interfering organochlorine pesticides would be eluted.

For the separation of CBs from lipids or oil components, reversed-phase HPLC can be used. In reversed-phase chromatography CBs elute during a solvent gradient of 80 to 90% methanol, together with numerous other compounds of similar polarity. Most of the above mentioned extraction methods and clean-up procedures yield an extract containing an apolar solvent. These cannot be injected directly for reversed-phase chromatography, and so compounds must be transferred between solvents several times *e.g.* before injection and after elution. When using polar solvents for extraction (*e.g.* for wet sediments) reversed-phase columns could be used directly for clean-up. When eluting an acetonitrile extract from a C₁₈ solid phase extraction (SPE) column with acetonitrile, high molecular hydrocarbons are strongly retained while CBs elute in the first few column volumes.

The above mentioned normal-phase chromatographic procedures on silica and Al₂O₃ can be transferred to HPLC having the advantages of higher resolution and better reproducibility.

When using GPC the elution of CBs should be carefully checked. When applying GPC, two serial columns are often used for improved lipid separation. Solvent mixtures such as dichloromethane/hexane or cyclohexane/ethyl acetate can be used as eluents for GPC. However, a second clean-up step is often required to separate the CBs from other organohalogenated compounds.

One advantage of using PLE extraction is that it is possible to combine the clean up with the extraction, especially when mass spectrometry will be used as the detection method. If Soxhlet extraction is used for biota, then there is a much greater quantity of residual lipid to be removed than in the case of PLE with fat retainers. An additional clean-up stage may therefore be necessary. Methods have been developed for online clean-up and fractionation of dioxins, furans and CBs with PLE for food, feed and environmental samples (Sporring *et al.*, 2003). The first method utilises a fat retainer for the on-line clean-up of fat. Silica impregnated with sulphuric acid, alumina and Florisil have all been used as fat retainers. A non-polar extraction solvent such as hexane should be used if fat retainers are used during PLE.

Non-*ortho* CBs require a more specialised clean-up, similar to that which is generally associated with the analysis of dioxins and furans. Although initial clean-up may very well proceed along the lines described above, the larger sample intake results in even larger amounts of co-extractives and care has to be taken that the capacity of the adsorption columns is not exceeded and/or that sulphur is adequately removed. Often, more rigorous procedures are applied to remove the excess material by *e.g.* shaking the sample with concentrated sulphuric acid. A more efficient and safer alternative is to elute the sample over a silica column impregnated with sulphuric acid (40 % w/w).

Non-*ortho* CBs are nearly always separated from the other CBs using advanced separation techniques. A very efficient method is to inject the extracts (after concentrating them) into a HPLC system coupled to PYE (2-(1-pyrenyl) ethyldimethylsilylated silica) column. Column dimensions are typically 4.6 x 150 mm column, but combinations of several columns in-line are sometimes used. PYE columns not only allow the separation of *ortho*, mono-*ortho* and non-*ortho* CBs on the basis of structural polarity from each other but also from dibenzo-*p*-dioxins and dibenzofurans. The eluting solvent is an apolar solvent

such as *iso*-hexane. When coupled to a fraction collector, the use of a HPLC system allows the automatic clean-up of a considerable number of samples. Alternatively, HPLC systems equipped with porous graphite carbon. Column sizes are in the order of 50 x 4.7 mm and care has to be taken that the column is not overloaded. Similarly to PYE columns, they will separate non-*ortho* CBs from the others and from dioxins and furans. Fully automated systems, such as Powerprep, that combine several steps are routinely used (Focant and De Pauw, 2002).

7. Pre-concentration

Evaporation of solvents with a rotary-film evaporator was up until recent the common method. However, evaporation of solvents using this technique should be performed at low temperature (water bath temperature of $\leq 30^{\circ}\text{C}$) and under controlled pressure conditions, in order to prevent losses of the more volatile CBs. To reduce the sample to the final volume, solvents can be removed by blowing-down with gently streaming nitrogen. Only nitrogen of a controlled high quality should be used. As a solvent for the final solution to be injected into the GC, *iso*-octane is recommended.

Turbovap sample concentrators can also be used to reduce solvent volume. This is a rapid technique, but needs to be carefully optimised and monitored to prevent both losses (both of volatiles and solvent aerosols) and cross-contamination. The use of rotary-film evaporators is more time consuming but more controllable. Here also, evaporation to dryness should be avoided at all costs. Syncore parallel evaporators (Buchi, Switzerland) can be used with careful optimisation of the evaporation parameters. The Buchi Syncore Analyst also uses glass tubes but the system is sealed, avoiding contamination from the lab air during evaporation. It does not use a nitrogen stream, thus reducing the loss of volatiles and if the flashback module is fitted the sides of the tubes are rinsed automatically thus reducing the loss of the heavier components. Again water-bath temperatures should be minimised to prevent losses. When reducing the sample to the required final volume, solvents can be removed by a stream of clean nitrogen gas. Suitable solvents for injection into the gas chromatograph (GC) include hexane, heptane, toluene and *iso*-octane.

7.1 Calibration and preparation of calibrant solutions

Internal standards (recovery and quantification standards) should be added in a fixed volume or weight to all standards and samples. The ideal internal standard is a CB which is not found in the samples. All CBs with a 2,4,6-substitution (e.g. CB115, CB155, CB198) are, in principle, suitable. Alternatively, 1,2,3,4-tetrachloronaphthalene or homologues of dichloroalkylbenzylether can be used. For GC analysis with mass selective detection (GC-MS), ^{13}C labelled CBs should be used for each degree of chlorination. This especially critical for the non-*ortho* CBs. If possible, the labelled calibrant solutions should correspond to the unlabelled determinants. For the non-*ortho* CBs a labelled standard is available for each congener and use of all of them is recommended. When preparing a calibration solution for a new determinant for the first time, two independent stock solutions of different concentrations should always be prepared simultaneously to allow cross checking. A new calibration solution should also be cross-checked to the old standard solution. Crystalline CBs of known purity should always be used for preparing calibration solutions. If the quality of the standard materials is not guaranteed (e.g. as in the case for a Certified Reference Material) by the producer or supplier, it should be checked by GC preferably with mass spectrometric detection. Solid standards should be weighed to a precision of 10^{-5} grams. In recent years, a lot of certified commercial custom made

standards have become available and laboratories have been switching to these. Calibration solutions should preferably be stored in ampoules in a cool and dark place. When stored in containers the weight loss during storage should be recorded.

8. Instrumental determination

8.1 Injection techniques

The two modes commonly used are splitless and on-column injection. In split injection, strong discrimination effects may occur. The liner should possess sufficient capacity with respect to the injected volume after evaporation, but should not be oversized to avoid poor transfer to the column and losses by adsorption. Liners with light packing of (silylated) glass wool may improve the performance for CBs, but may degrade some organochlorine compounds like DDT, which are often included in national monitoring programmes.

Recently, other techniques such as temperature-programmed or pressure-programmed injection have become more prominent. They offer additional advantages such as an increased injection volume without the negative effects previously associated with that, but should be thoroughly optimised before use. Increasing the injection volume will allow either or both the elimination of an extra evaporation step and lowering the detection limits.

8.2 Carrier gas

Hydrogen is the preferred carrier gas and is indispensable for columns with very small inner diameters. Helium is also acceptable and the standard carrier for GC-MS.

8.3 Columns

Only capillary columns should be used. The following parameters are recommended:

Minimum Length	50 m (for microcolumns of internal diameter <0.1 mm, shorter columns can be suitable).
Maximum internal diameter	0.25 mm. Note that for diameters <0.15 mm the elevated pressure of the carrier gas needs special instrumental equipment as most of the instruments are limited to 400 kPa.
Film thickness	0.2-0.4 µm.

Columns which do not fulfil these requirements generally do not offer sufficient resolution to separate CB28, CB105 and CB156 from closely eluting CBs. A wide range of stationary phases can be used for CB separation. The chemical composition is different for many producers and depends on the maximum temperature at which the column can be operated. Further advice may be found in the producer's catalogues, where compositions, applications and tables to compare products from different manufacturers are included.

In recent years, new chromatographic phases have become available that result in an improved separation of critical CB pairs. A good example is the HT-8 phase (1,7-dicarba-closo-dodecarborane phenylmethyl siloxane) (Larsen *et al.*, 1995) that shows a remarkable selectivity for CBs. This column

is currently recommended for CB analysis. Examples of the retention times for various CBs are given in Table 1.

8.4 Detection

The electron capture detector (ECD) is still frequently used for CB analysis. Injection of chlorinated solvents or oxygen-containing solvents should therefore be avoided due to the generation of large interfering signals. When using mass selective detectors (MSD) negative chemical ionisation mode (NCI) is extremely sensitive for pentachlorinated to decachlorinated CBs and is approximately ten fold better than ECD. However, MS systems have improved considerably allowing analysis by Electron impact ionisation (EI), whereas before, electron-capture negative ion chemical ionisation (ECNICI) was often necessary in order to detect the low concentrations of, in particular the planar CBs. Suggested target and qualifier ions for *ortho* CBs (including non-*ortho* CBs) are shown in Table 1 and in Table 2 for non-*ortho* CBs.

Table 1 Example of retention times for selected CB congeners using a 50 m HT8 column (0.25 mm i.d. and 0.25 µm film), along with possible target and qualifier ions. Temperature programme: 80°C, hold for 1 minute, ramp 20°C/minute, to 170°C, hold 7.5 minutes, ramp 3°C/minute to 300°C, hold for 10 minutes.

CB congener	MW	RT	Target Ion	Qualifier Ion	Number of chlorines
¹³C-CB28	270	28.371	268	270	3
CB31	258	28.071	256	258	3
CB28	258	28.388	256	258	3
¹³C-CB52	304	30.317	304	302	4
CB52	292	30.336	292	290	4
CB49	292	30.698	292	290	4
CB44	292	32.024	292	290	4
CB74	292	34.881	292	290	4
CB70	292	35.199	292	290	4
¹³C-CB101	340	36.612	338	340	5
CB101	326	36.630	326	328	5
CB99	326	37.062	326	328	5
CB97	326	38.267	326	328	5
CB110	326	39.277	326	328	5
CB123*	326	41.2	326	328	5
CB118*	326	41.563	326	328	5
CB105*	326	43.443	326	328	5
CB114*	326	42.2	326	328	5
¹³C-CB153	374	42.567	372	374	6
CB149	362	40.328	360	362	6
CB153	362	42.584	360	362	6
CB132	362	42.236	360	362	6
CB137	362	43.744	360	362	6
¹³C-CB138	374	44.437	372	374	6
CB138	362	44.487	360	362	6
CB158	362	44.663	360	362	6
CB128	362	46.307	360	362	6
¹³C-CB156	374	48.406	372	374	6
CB156*	362	48.366	360	362	6
CB167*	362	46.4**	360	362	6
CB157*	362	48.698	360	362	6
¹³C-CB180	408	48.829	406	408	7

CB congener	MW	RT	Target Ion	Qualifier Ion	Number of chlorines
CB187	396	44.787	394	396	7
CB183	396	45.264	394	396	7
CB180	396	48.846	394	396	7
CB170	396	50.684	394	396	7
¹³ C-CB189	406	53.182	406	408	7
CB189*	396	53.196	394	396	7
¹³ C - CB194	442	57.504	442	440	8
CB198	430	50.347	430	428	8
CB194	430	57.514	430	428	8

***mono-ortho CBs, ** to be checked**

Next to conventional GC-MS, the use of ion-trap with its tandem MS² option – i.e., yielding improved selectivity – is receiving increased attention. The use of GC-ITMS provides a less expensive alternative to high-resolution mass spectrometry (HRMS), which is commonly used to determine PCDD/F and, as such, also ideally suited for all CB groups (Eppe *et al.*, 2004).

Table 2 Possible target and qualifier ions for non-*ortho* CBs, including labelled internal standards

CB	Target ion (<i>m/z</i>)	Qualifier (<i>m/z</i>)	Qualifier (<i>m/z</i>)	Qualifier (<i>m/z</i>)
¹³ CB81	304	302	NA	NA
CB81	292	290	220	222
¹³ CB77	304	302	NA	NA
CB77	292	290	220	222
¹³ CB126	338	340	NA	NA
CB126	326	328	254	256
¹³ CB169	372	374	NA	NA
CB169	360	362	218	220

8.5 Separation, identification and quantification

When using GC-ECD and to a certain extent GC-MS, two columns with stationary phases of different polarity should be used, as column-specific coelution of the target CBs with other CBs or organochlorine compounds occurs. The temperature programme must be optimised for each column to achieve sufficient separation of the CB congeners to be determined. An isothermal period in the programme around 200-220°C of approximately 30 minutes is recommended. Care should be taken that CBs of interest do not co-elute with other CB congeners (for example CB28 and CB31). When using GC-ECD, compounds are identified by their retention time in relation to the standard solutions under the same conditions. Therefore GC conditions should be constant. Shifts in retention times

should be checked for different areas of the chromatogram by identifying characteristic, unmistakable peaks (*e.g.* originating from the internal standard or higher concentrated CBs such as CB153 and CB138). When using a GC-MS system, the molecular mass or characteristic mass fragments or the ratio of two ion masses can be used to confirm the identity of separated CBs. Since calibration curves of most CBs normally non-linear when using a GC-ECD, but should be linear for GC-MS, a multilevel calibration of at least five concentrations is recommended. The calibration curve must be controlled and the best fit must be applied for the relevant concentration range. Otherwise, one should strive to work in the linear range of the detector must. Analysis of the calibration solutions should be carried out in a mode encompassing the concentrations of the sample solutions (or alternatively by injecting matrix-containing sample solutions and matrix-free standard solutions distributed regularly over the series). When the chromatogram is processed with the help of automated integrators the baseline is not always set unambiguously and always needs to be inspected visually. When using GC-ECD, peak height is preferable to peak area for quantification purposes. From the two columns of different polarity the more reliable result should be reported.

Recent years have witnessed the emergence of so-called comprehensive two-dimensional gas chromatography (GC x GC) – a technique that can be used to considerably improve analyte/matrix as well as analyte/analyte separation. Briefly, a non-polar x (semi-)polar column combination is used, with a conventional 25-30 m long first-dimension, and a short, 0.5-1 m long, second-dimension column. The columns are connected via an interface called a modulator. The latter device serves to trap, and focus, each subsequent small effluent fraction from the first-dimension column and, then, to launch it into the second column. The main advantages of the comprehensive approach are that the entire sample (and not one or a few heart-cuts, as in conventional multidimensional GC (Dallüge *et al.* 2003) is subjected to a completely different separation, that the two-dimensional separation does not take any more time than the first-dimension run, and that the re-focusing in the modulator helps to increase analyte detectability. The most interesting additional benefit for CBs is, that structurally related as CB congeners show up as so-called ordered structures in the two-dimensional GC x GC plane. The very rapid second-dimension separation requires the use of detectors with sufficiently high data acquisition rates. Initially, only flame ionisation detectors could meet this requirement. However, today there is also a micro-ECD on the market that is widely used for GC x GC- μ ECD of halogenated compound classes. Even more importantly, analyte identification can be performed by using a time-of-flight mass spectrometer [Dallüge *et al.*, 2002] or – with a modest loss of performance, but at a much lower price – one of the very recently introduced rapid-scanning quadrupole mass spectrometers [Korytar *et al.*, 2005; Adachour *et al.*, 2005). So far, the use of GC x GC has been limited to qualitative applications and still seems inappropriate for routine quantification of analytes.

9. Quality assurance

Planners of monitoring programmes must decide on the accuracy, precision, repeatability, and limits of detection and determination which they consider acceptable. The limit of determination should depend on the purpose of the investigation. A limit of at least 0.1 ng/g (dry weight, fraction < 2mm) should be reached, but detection limits of 0.01 ng/g are achievable nowadays. The method for calculating the limit of determination should reflect QUASIMEME advice (Topping *et al.*, 1992). The limit of determination that can be achieved depends on the blank, on the sample matrix, on

concentrations of interfering compounds and on the mass of sediment taken for analysis. References of relevance to QA procedures include HELCOM, 1988; QUASIMEME 1992; Wells *et al.*, 1992; Oehlenschläger, 1994; Smedes *et al.*, 1994 and ICES, 1996.

9.1 System performance

The performance of the GC system should be monitored by regularly checking the resolution of two closely eluting CBs. A decrease in resolution points to deteriorating GC conditions. The signal-to-noise ratio yields information on the condition of the detector. A dirty ECD detector or MS ion source can be recognised by the presence of an elevated background signal together with a reduced signal-to-noise ratio. Chromatograms should be inspected visually by a trained operator.

9.2 Recovery

The recovery should be checked and reported. One method is to add an internal (recovery) standard to each sample immediately before extraction and a second (quantification) standard immediately prior to injection. If smaller losses occur in extraction or clean-up or solutions are concentrated by uncontrolled evaporation of solvents (*e.g.* because vials are not perfectly capped) losses can be compensated for by normalisation. If major losses are recognised and the reasons are unknown, the results should not be reported, as recoveries are likely to be irreproducible. A control for the recovery standard is recommended by adding the calibration solution to a real sample. Recoveries should be between 70 and 120%, if not, samples should be repeated.

10. References

- Adahchour, M., Brandt, M., Baier, H-U., Vreuls, R.J.J., Max Batenburg, A. and Brinkman, U.A.Th. 2005 Comprehensive two-dimensional gas chromatography coupled to a rapid-scanning quadrupole mass spectrometer: principles and applications *J. Chromatogr. A*1067: 245-254
- Alcock, R.E., Halsall, C.J., Harris, C.A., Johnston, A.E., Lead, W.A., Sanders, G. and Jones, K.C., 1994. Contamination of environmental samples prepared for PCB analysis. *Environ. Sci. Technol.* 28: 1838-1842.
- Balfanz, E., Fuchs, J. and Kieper, H., 1993. Sampling and analysis of polychlorinated biphenyls (PCB) in indoor air due to permanently elastic sealants. *Chemosphere* 26: 871-880,
- Bowadt, S. and Johannsson, B., 1994. Analysis of PCBs in sulfur-containing sediments by off-line supercritical fluid extraction and HRGC-ECD. *Anal. Chem.* 66: 667-673.
- Dallüge, J., Beens, J. and Brinkman, U.A.Th. 2003 Comprehensive two-dimensional gas chromatography: a powerful and versatile analytical tool *J. Chromatogr.*, 1000: 69-108.
- Dallüge, J., Vreuls, R.J.J., Beens, J. and Brinkman, U.A.Th. 2002b Optimization and characterization of comprehensive two-dimensional gas chromatography with time-of-flight mass spectrometric detection (GC×GC-TOF MS) *J. Sep. Sci.*, 25: 201-214.
- de Boer, J. and Wells, D.E. 1996. The 1994 QUASIMEME Laboratory performance studies: chlorobiphenyls and organochlorine pesticides in fish and sediment. *Mar. Pollut. Bull.* 32: 654-666.
- Eganhouse, R.P., 1986. Long-chain alkylbenzenes: their analytical chemistry, environmental occurrence and fate; *Intern. J. Environ. Anal. Chem.* 26: 241-263.

- Eppe, G., Focant, J.F., Pirard, C. and De Pauw, E. 2004 PTV-LV-GC/MS/MS as screening and complementary method to HRMS for the monitoring of dioxin levels in food and feed *Talanta* 63: 1135–1146
- Focant, J.-F. and De Pauw, E. 2002. Fast automated extraction and clean-up of biological fluids for polychlorinated dibenzo-p-dioxins, dibenzofurans and coplanar polychlorinated biphenyls analysis. *J. Chromatogr. B*, 776 :199-212.
- Japenga, J., Wagenaar, W.J., Smedes, F. and Salomons, W. 1987. A new rapid clean-up procedure for the simultaneous determination of different groups of organic micropollutants in sediments; application in two European estuarine sediment studies; *Environ. Techn. Lett.* 8: 9-20,
- Jensen, S., Renbey, L. and Reutergårdh, L., 1977. Residue analysis of sediment and sewage sludge for organochlorines in the presence of elemental sulfur. *Anal. Chem.* 49: 316-318.
- Korytar, P., Parera, J., Leonards, P.E.G., de Boer, J. and Brinkman, U.A.Th. 2005 Quadrupole mass spectrometer operating in the electron-capture negative ion mode as detector for comprehensive two-dimensional gas chromatography. *J. Chromatogr. A* 1067: 255-264
- Larsen, B., Cont, M., Montanarella, L. and Platzner N. 1995 Enhanced selectivity in the analysis of chlorobiphenyls on a carborane phenylmethylsiloxane copolymer gas chromatography phase (HT-8) *J. Chromatogr. A* 708:115-129
- Lee, H.B. and Peart, T.E., 1994. Optimization of supercritical carbon dioxide extraction for polychlorinated biphenyls and chlorinated benzenes from sediments. *J. Chromatogr.* 663: 87-95.
- Richter, B.E., Ezzell, J.L., Felix, D., Roberts, K.A. and Later, D.W., 1995. An accelerated solvent extraction system for the rapid preparation of environmental organic compounds in soil. *American Laboratory* 2: 24-28.
- Roose, P. and Brinkman, U. A.Th., 2005 Monitoring organic microcontaminants in the marine environment: principles, programmes and progress *TrAC*, 24: 897-926
- Smedes, F. and de Boer, J., 1997. Determination of chlorobiphenyls in sediments – analytical methods *TRAC* 16: 503-517.
- Smedes, F. and de Boer, J., 1994. Guidelines for the determination of chlorobiphenyls in sediments. *Quimica Analytica* 13: 100-108.
- Sporring, S., Wiberg, K., Bjorklund, E. and Haglund, P. 2003. Combined extraction/Clean-up strategies for fast determination of PCDD/Fs and WHO PCBs in food and feed samples using accelerated solvent extraction, *Organohalogen Compounds*, 60-65, Dioxin 2003, Boston.
- Tong, P. and Imagawa, T., 1995. Optimization of supercritical fluid extraction for polychlorinated biphenyls from sediments. *Analytica Chimica Acta* 310: 93-100,
- Topping, G., Wells, D.E. and Griepink, B., 1992. Guidelines on quality assurance for marine monitoring. DG XII. Measurements and testing programme, Rue de la Loi 200, PO Box 1049, Brussels.
- Wade, T.L. and Cantillo, A.Y., 1996. Use of standards and reference materials in the measurement of chlorinated hydrocarbon residues – Chemistry Workbook; Integrated Ocean Global Station System (IGOSS) Plan and Implementation Programme 1996-2003, IOC Technical Series 45, UNESCO.

Annex XI:

HELCOM

Guidelines on the determination of chlorinated hydrocarbons in sediment

Guidelines on the determination of chlorinated hydrocarbons in sediment

1.	Introduction.....	2
2.	Sampling and storage	2
3.	Blanks and contamination.....	2
4.	Pretreatment.....	3
5.	Extraction and clean-up.....	3
	5.1. Extraction of wet sediments	3
	5.2. Extraction of dry sediments	4
	5.3. Removal of sulphur and sulphur-containing compounds.....	4
	5.4. Further clean-up.....	5
6.	Gas chromatography	6
	6.1 Column dimensions.....	6
	6.2 Stationary phases	6
	6.3 Carrier gas	7
	6.4 Injection techniques.....	7
	6.5 Temperature programming.....	7
	6.6 Detection.....	7
	6.7 Identification	7
7.	Quantification.....	7
8.	Quality Assurance.....	8
	8.1. Extraction efficiency and clean-up.....	8
	8.2 Calibrant and calibration	8
	8.3 System performance	8
	8.4 Long-term stability	9
	8.5 Internal standards	9
	8.6 Interlaboratory proficiency testing schemes	9
7.	References.....	9

1. Introduction

These guidelines are based on the review from Smedes and de Boer (1994, 1998) and Eljarrat and Barceló (2009).

The analysis of chlorinated hydrocarbons in sediments generally involves extraction with organic solvents, clean-up, removal of sulphur, column fractionation and gas chromatographic separation, mostly with electron capture or mass-spectrometric detection.

All steps of the procedure are susceptible to insufficient recovery and contamination. Quality control measures are recommended in order to regularly monitor the performance of the method. These guidelines are intended to encourage and assist analytical chemists to critically review their methods and to improve their procedures and quality assurance measures, if necessary.

These guidelines can be applied for the determination of several types of chlorinated hydrocarbons, e.g., chlorinated biphenyls (CB), chlorobenzenes, DDT and its metabolites and hexachlorocyclohexanes. It should be noted that these guidelines do not cover the determination of non-*ortho* substituted CB. Due to the low concentrations of non-*ortho* CB in sediments comparing to those of other CB, their determination requires an additional separation and concentration step similar to the analysis of polychlorinated dibenzo-*p*-dioxins and dibenzofurans (PCDD/F).

These guidelines are not intended as complete laboratory manual. If necessary, guidance should be sought from specialized laboratories. Laboratories should demonstrate validity of each methodological step. Moreover, use of an alternative method, carried out concurrently to the routine procedure, is recommended for validation.

Contracting parties should follow the HELCOM monitoring guideline but minor deviations from this are acceptable if the method achieves comparable results. Validation of the adopted method needs to be performed on the relevant matrix and concentration range e.g. by taking part in intercomparison studies or proficiency testing schemes.

2. Sampling and storage

The major criterion for successful sediment sampling is to ensure undisturbed sample stratification. (For further details about sampling, see Annex B-13, Appendix 3 “Technical note on the determination of heavy metals in marine sediments” of the COMBINE manual.)

Plastic materials (except polytetra-fluorethene, PTFE) should not be used for sampling and storage due to the risk of adsorption of target compounds onto the container material. Samples should be transported in closed containers and preferentially at temperatures below 10 °C. The samples should be stored at 4 °C as soon as possible, but at least if they have not been analysed within 48 hours after collection (short-term storage). For long-term storage over several months the samples should be frozen below -20 °C or dried (Law and de Boer, 1995). When drying, avoid methods with substantial risk of losing volatile substances (see Chapter 4: Pretreatment).

3. Blanks and contamination

Basically, care should be taken to avoid contaminations during all steps of the analytical chain, including sampling, extraction and clean-up.

In order to reduce blank and sample contaminations to a minimum it is strongly recommended to pretreat all used glassware, solvents, chemicals, adsorption materials, etc., as follows:

- Glassware should be thoroughly washed with detergents and can be furthered cleaned, other than calibrated instruments, by heating at temperatures > 250 °C. The glassware should be rinsed with an organic solvent prior to use.
- All solvents should be analyzed for impurities by concentrating to 10 % of the regular final volume. This concentrate is then analysed similarly to a sample by HPLC or GC. The solvent blank should not contain target analytes or other interfering compounds in higher concentrations than specified by the laboratory.
- All chemicals and adsorption materials should be analyzed for impurities and purified (e.g., by heating or extraction), if necessary. Soxhlet thimbles should be pre-extracted. Glass fiber thimbles are preferred over paper thimbles. Alternatively, full glass Soxhlet thimbles, with a G1 glass filter at the bottom, can be used.

Storage of these supercleaned materials for a longer period is not recommended, as laboratory air might contain target compounds which can adsorb onto these materials. Therefore, contaminated blank samples might occur despite precautionary measures due to contamination from the air. Volatile compounds are usually the most common contaminants in blank samples (Gremm and Frimmel, 1990). Therefore, if possible, critical steps should be done in a clean bench.

4. Pretreatment

The samples should be thoroughly homogenized before subsampling for analysis. The amount of samples usually depends on the expected concentrations. For the marine environment, the amount of sample should be equal to an amount representing 50–100 mg of organic carbon.

Chlorinated hydrocarbons can be extracted from wet or dried samples. However, storage, homogenization and extraction are easier to handle with dried samples.

Drying the samples at ambient or elevated temperatures as well as freeze-drying may alter the concentrations, e.g., by contamination or loss of compounds through evaporation (Law *et al.*, 1994). Therefore, potential losses and contaminations should be analyzed in advance, e.g. by exposing 1–2 g CIS-bonded silica to the drying conditions and subsequent extraction and analysis (clean-up can be omitted) (Smedes and de Boer, 1998). For evaluation of potential losses, analytes identical or similar to chlorinated hydrocarbons need to be added to the material. However, bear in mind that added analytes can behave differently from analytes that have interacted longer with the matrix material and therefore may be sorbed more strongly. To avoid contamination during freeze-drying, placing a lid with a hole of about 3 mm in diameter on the sample container is suggested.

Chemical drying of samples can be performed by grinding with Na₂SO₄, or MgSO₄ until the sample reaches a sandy consistency. It is essential that several hours elapse between grinding and extraction to allow for complete dehydration of the sample. Residual water will decrease extraction efficiency.

5. Extraction and clean-up

The target compounds must be extracted from the sediment with an organic solvent prior to further analysis.

Other extraction and clean-up methods than those described below may be used, provided that the methods have been tested and found equivalent to established methods regarding e.g. recovery.

5.1. Extraction of wet sediments

Wet sediments are extracted by mixing with organic solvents. Extraction is enhanced by shaking, ultraturrax mixing, ball mill tumbler or ultrasonic treatment. Water-miscible solvents such as methanol, acetone, and acetonitrile, are used, in particular in the first step. The extraction efficiency of the first step is

low as there will be a considerable amount of water in the liquid phase. Extraction will be continued with a mixture of polar and apolar solvents such as acetone/ hexane or methanol/ dichloromethane. It has to be kept in mind that hexane and dichloromethane is a lot more toxic than similar solvents such as pentane, heptane, cyclohexane, isohexane. For complete extraction at least three subsequent extractions are required and a contact time of up to 24 hours with the solvent should be sufficient to complete the desorption of the chlorinated hydrocarbons from the sediment.

Soxhlet extraction or extraction by pressurized liquid extraction such as ASE of wet sediments should be conducted in two steps. First, a polar solvent, such as acetone, is used to extract the water from the sediment. In a second step the collecting flask is replaced and the extraction will be continued using a less polar solvent or solvent mixture such as acetone/hexane or toluene. Thereafter, the extracts will be combined.

To separate the water and keep the chlorinated hydrocarbons in a solvent that is compatible with the continued analysis different methods can be used. For example, water will be added to the combined extracts and the chlorinated hydrocarbon compounds will be extracted to a non-polar solvent. Another possibility is to add Na_2SO_4 to bind water.

Extraction should be conducted with a sufficient number of extraction cycles. Extraction efficiency should be analyzed for different types of sediments through a second extraction step. The extracts will be analysed separately and compared. A recovery of more than 90 % during the first extraction step is considered adequate.

5.2. Extraction of dry sediments

For dried sediments pressurized liquid extraction (e.g. ASE) is frequently applied to extract chlorinated hydrocarbons. The use of a mixture of a polar and a non-polar solvent, e.g., 25 % (v/v) acetone/hexane is recommended for sufficient extraction efficiency. A higher content of polar solvent increases extraction efficiency, but it has to be removed prior to gas chromatographic analysis.

Alternatively to ASE, extraction can be conducted with a regular Soxhlet, a hot Soxhlet with at least 50 to 60 extraction cycles (approximately 8 hours for the hot Soxhlet) or by microwave extraction. Supercritical fluid extractions have also been demonstrated, but have not found wide application due to low reproducibility compared to the other technique (Law et al, 2011).

Extraction should be conducted with a sufficient number of extraction cycles. Extraction efficiency should be analyzed for different types of sediments through a second extraction step. The extracts will be analysed separately and compared. A recovery of more than 90 % during the first extraction step is considered adequate.

Prior to any concentration steps, a keeper (high-boiling solvent, e.g. a high-boiling alkane or toluene) should be added. Make sure that the keeper does not interfere with the analytes of interest in the instrumental analysis.

5.3. Removal of sulphur and sulphur-containing compounds

The crude extracts usually require clean-up to remove co-extracted compounds (Wise *et al.*, 1995). Due to chlorophyll-like compounds extracted from the sediment, the raw extract is usually colored and also contains sulphur and sulphur-containing compounds, oil, PAH compounds and other natural and anthropogenic compounds. Selection of the appropriate clean-up method depends on the subsequent instrumental method to be used for analysis. Copper powder, wires, or gauze are the most common ways to remove the sulphur directly from an organic solvent. Copper can be applied during or after sediment extraction. Ultrasonic treatment might improve the removal of sulphur. If sulphur appears to be present in the final extract, the amount of copper used was insufficient and the clean-up procedure must be repeated.

Be aware that a prolonged contact between the sample and the copper may degrade some chlorinated pesticides.

Another possibility to remove sulphur is to add an aqueous saturated Na_2SO_3 solution to a hexane extract. In order to allow transfer of the HSO_3^- ions to the organic phase, tetrabutylammonium (TBA) salts and isopropanol are added to the mixture. Subsequently, water is added to remove the isopropanol. The aqueous phase is then quantitatively extracted with hexane (Jensen *et al.*, 1977). If the extraction is performed with a polar solvent which is miscible with water, the Na_2SO_3 solution can be added directly after the extraction. If the extraction mixture also contains a non-polar solvent, then, depending on the ratio of the solvents, the addition of TBA and isopropanol may not be necessary. Any excess Na_2SO_3 and reaction products can be removed by the addition of water and partitioning between the non-polar solvent and water.

Japenga *et al.* (1987) developed a column method for the removal of sulphur and sulphur-containing compounds. The column material is made by mixing an aqueous solution of Na_2SO_3 with Al_2O_3 . Some NaOH is also added to improve the reaction with sulphur. Subsequently, the material is dried under nitrogen until a level of deactivation equivalent to 10 % water is reached. Storage must be under nitrogen because sulphite in this form may easily be oxidized to sulphate. Eluting the extract (hexane) through a column filled with this material results in removal of the sulphur in combination with further clean-up of the sediment extract.

Silver ions strongly bind sulphur and sulphur compounds. Loaded on silica, AgNO_3 is a very efficient sulphur-removing agent. It can be prepared by mixing dissolved AgNO_3 with silica and subsequently drying under nitrogen. Compounds containing aromatic rings are strongly retained, but for chlorinated hydrocarbons retention is reduced, probably due to shielding of the rings by the chlorine atoms. Retained compounds can easily be eluted by using cyclohexene, or another solvent with double bonds, as a modifier.

Elemental sulphur is strongly retained on a polystyrene divinylbenzene copolymer column as generally applied for gel permeation chromatography (GPC). In addition, this method combines the removal of sulphur with a clean-up.

Sometimes the use of multiple methods may be necessary for different samples. Several methods leave aromatic sulphur compounds in the extract which will elute from the GC column at the same retention time as the lower chlorinated biphenyls. The major part of these compounds can be removed by eluting a non-polar extract over a column containing silica loaded with concentrated sulphuric acid.

The recovery during clean-up should be analyzed carefully. In particular, treatment with H_2SO_4 results in loss of, e.g., dieldrin and endosulfanes. Also, the clean-up procedure with silver ions or copper can result in low recoveries for certain pesticides.

5.4. Further clean-up

Clean-up using normal phase chromatography is the most appropriate technique for the separation of the chlorinated hydrocarbons from other compounds. Using non-polar solvent, e.g., hexane or *iso*-octane, chlorinated hydrocarbons usually elute very rapidly.

All polar solvents used during extraction or sulphur-removal should be removed before further clean-up. The last concentration step is usually performed by evaporation with a gentle stream of nitrogen. Evaporation to dryness should always be avoided.

Deactivated Al_2O_3 (5–10 % water) is often used as the primary clean-up step through which usually a sufficiently clean extract for a gas chromatography- electron capture detector (GC-ECD) analysis of the sample is achieved, given that sulphur has been removed.

Deactivated SiO₂ (1–5 % water) does not retain chlorinated hydrocarbons (including planar CB) and only slightly retains polycyclic hydrocarbons when eluted with hexane or *iso*-octane.

For high activity silica (overnight at 180 °C), the retention of chlorinated hydrocarbons is negligible while PAH compounds are more strongly retained. The chlorinated hydrocarbons are eluted with non-polar solvents. Upon using more polar solvents (e.g., hexane/acetone) some interfering organochlorine pesticides might become eluted.

When GPC is used for removing sulphur (see 5.3 REMOVAL OF SULPHUR AND SULPHUR-CONTAINING COMPOUNDS) the removal of high molecular weight material can also be incorporated into the procedure. GPC does not separate chlorinated hydrocarbons from other compounds in the same molecular range (such as organochlorine pesticides), so additional clean-up is usually required.

For the separation of chlorinated hydrocarbons from lipids or oil components reverse-phase high-performance liquid chromatography (RP-HPLC) can be used. Due to the use of aqueous solvents in RP-HPLC solvents need to be changed from polar to non-polar and *vice versa*. Another option is the use of strong acid (e.g. H₂SO₄) to degrade the lipids; however, it may also degrade some pesticides.

6. Gas chromatography

In particular, for the large number of CB congeners (a total of 209) high-resolution capillary gas chromatography (GC) is the method of choice. However, the analysis of CBs in sediments should focus on the determination of selected individual congeners as it is currently impossible to separate all CBs in technical mixtures and from other ECD-detectable compounds. For example, the seven common indicator-PCBs should be analysed. If there is a desire to separate and analyse all congeners, it is recommended to use multidimensional gas chromatography (MGC) that makes use of two successive columns of different selectivity or polarity. However, the optimization is difficult (co-elution of some PCBs) and it is not routinely applied at commercial laboratories. Alternatively two ECD detectors and two parallel columns with different selectivity or polarity can be used, reducing the detection limit by a factor of 2 but improving the selectivity of co-elution PCBs by choosing the column with least overlap for suspected co-elutions.

Another option is to use GC-MS instrumentation for more selective determination.

For all GC methods, parameters have to be optimized.

6.1 Column dimensions

Column dimensions for the determination of chlorinated hydrocarbons are:

- length: minimum 50 m, and
- inner diameter (i. d.): maximum 0.25 mm.
- film thickness: 0.2 µm to 0.4 µm

Greater resolution can be obtained by reducing the inner diameter to 0.20 mm or less. Below a diameter of 0.15 mm the carrier gas pressure rises to values above 500 kPa, which are often not compatible with regular GC instruments. Also, the risk of leakage increases.

6.2 Stationary phases

A wide range of stationary phases can be used for the separation of chlorinated hydrocarbons (e.g., 94 % dimethyl-, 5 % phenyl-, 1 % vinyl polysiloxane, or 7 % phenyl-, 7 % cyanopropyl-, 86 % methyl-siloxane).

The use of more polar phases is sometimes limited as their maximum temperatures are not as high as for non-polar, chemically bonded phases. Stationary phases that separate chlorinated hydrocarbons on the

basis of molecular size, such as the liquid crystal phase, should not be used for monitoring purposes since they do not provide sufficient reproducibility.

6.3 Carrier gas

Preferentially, hydrogen should be used as the GC carrier gas. When using columns with very small inner diameters, the use of hydrogen is essential. The linear gas velocity should be optimized.

Appropriate settings for 0.25 mm i.d. columns range from 20–40 cm s⁻¹ and for 0.15 mm i.d. columns from 30–50 cm s⁻¹.

6.4 Injection techniques

The two systems commonly used are splitless and on-column injection. Split injection should not be used due to strong discrimination effects. Other techniques such as temperature-programmed or pressure-programmed injection may have additional advantages, but should be thoroughly optimized before use.

The volume of the liner should be large enough to contain the gas volume of the evaporated injected solvent. When the liner is too small, memory effects may occur due to contamination of the gas tubing attached to the injector. Very large liner volumes can cause a poor transfer of early eluting components, so that peaks due to those analytes will be reduced or even disappear. In addition, the use of a light packing of (silylated) glass wool in the liner improves the response and reproducibility of the injection, but some organochlorine pesticides such as DDT may be degraded when this technique is applied.

An auto-sampler should be used.

6.5 Temperature programming

The temperature programme must be optimized for sufficient separation of the chlorinated hydrocarbons. A separation time of 60 to 120 minutes can be necessary. In addition to a reproducible temperature programme, a fixed equilibration time is important for a correct analysis and constant retention times.

For further details and recommendations see Smedes and de Boer (1998).

6.6 Detection

The use of a mass spectrometer (MS) or tandem mass spectrometer (MS/MS) is highly recommended. MS gives the possibility to use ¹³C labelled internal standards. Different ionization methods have been reported: Electron impact ionization (EI), Negative chemical ionization (NCI) or electron capture negative ionization (ECNI). Another used detector for the analysis of chlorinated hydrocarbons is the electron capture detector (ECD), but injection of chlorinated or oxygen-containing solvents should be avoided. NCI and ECNI is extremely sensitive for penta- to decachlorinated CBs (approximately ten-fold better than ECD), but can be less sensitive for less chlorinated PCBs (Law et al, 2011).

6.7 Identification

Usually, the compounds in the sample are identified based on their retention times as compared to those of the standard compounds analyzed under the same conditions. Moreover, upon using GC-MS compound characteristic mass fragments serve as additional identifiers.

7. Quantification

Automatically processed chromatograms should be reviewed if, e.g., the baseline is set correctly.

For calibration purposes a multilevel calibration with at least five concentration levels is recommended. The calibration curve should be linear and cover the working range. Obtained calibrations should be regularly validated in terms of precision and accuracy.

Prior to running a series of samples and standards, the GC or HPLC systems should be equilibrated by injecting at least one sample extract. In addition, standards used for multilevel calibrations should be

regularly distributed over the sample series so that matrix- and non-matrix-containing injections alternate. A sample series should include:

- a procedural blank;
- a laboratory reference material;
- at least five standards;
- one standard sample treated similarly to the samples for determination of the recovery.

The limit of quantification usually depends on the purpose of the investigation. The limit of quantification that can be achieved depends on the blank sample, the sample matrix, concentrations of interfering compounds, and the amount of sample. However, a limit of quantification of 0.1 ng g^{-1} (dry weight, fraction < 2 mm) or better should be attained for single compound analysis. The method for calculating the limit of determination should follow the advice in Part B-4.2.3 (COMBINE manual).

8. Quality Assurance

A number of measures should be taken to ensure sufficient quality of the analysis. Six main areas can be identified:

1. extraction efficiency and clean-up;
2. calibrant and calibration;
3. system performance;
4. long-term stability;
5. internal standards; and
6. frequent participation in interlaboratory proficiency testing schemes (e.g. QUASIMEME two times a year, www.quasimeme.org)

8.1. Extraction efficiency and clean-up

Extraction efficiency and clean-up can be controlled by analysing reference materials (Annex B-7). To determine the recovery rates of the clean-up and concentration steps, it is recommended to pass a standard solution (see 8.5. INTERNAL STANDARDS) through the entire procedure. The addition of corresponding internal standards to the samples is preferred.

If major losses have occurred, the results should not be reported.

8.2 Calibrant and calibration

Basically, calibration solutions should be stored in ampoules at a cool, dark place. Weight loss during storage should be recorded for all standards.

Calibration solutions from certified crystalline compounds should be used. However, the laboratory should have the appropriate equipment and expertise to handle these hazardous crystalline substances. Alternatively, certified compound solutions can be used. Preparation of two independent stock solutions allows cross-checks of the standard solutions if necessary.

8.3 System performance

The performance of the GC system can be monitored through regularly analyzing the resolution of two closely eluting compounds. A decrease in resolution indicates deteriorating GC conditions.

The signal-to-noise ratio of a low concentrated standard can give information on the condition of the detector. For example, a dirty MS-source can be recognized by the presence of a higher background signal, together with a reduced signal-to-noise ratio if not used in the SIM mode.

8.4 Long-term stability

One laboratory reference sample should be included in each series of samples. A quality control chart should be recorded for selected chlorinated hydrocarbons. If the warning limits are exceeded, the method should be checked for possible errors. When alarm limits are exceeded, the results obtained should not be reported.

A certified reference material should be analysed at least twice a year, and each time the procedure is changed.

8.5 Internal standards

Internal standards should be added to all standards and samples either in a fixed volume or by weight and should not interfere with the target analytes.

If possible, it is preferable to have internal standards corresponding as much as possible to each analyte, e.g. using isotopically labeled compounds combined with mass spectrometry as detection technique (e.g. pp-DDT-D8, isotopically labelled CBd).

After clean-up and before GC analysis, an additional internal standard can be added to evaluate the recovery of the internal standards added before clean-up.

8.6 Interlaboratory proficiency testing schemes

Each laboratory analysing sediments should participate in interlaboratory studies on the determination of chlorinated hydrocarbons in sediments on a regular basis (e.g. QUASIMEME offers the possibility to take part twice a year, www.quasimeme.org).

7. References

- Eljarrat, E., Barceló, D. 2009. Chlorinated and brominated organic pollutants in contaminated river sediments. In: Contaminated sediments. The Handbook of Environmental Chemistry Vol. 5T. Springer
- Japenga, J., Wagenaar, W.J., Smedes, F., and Salomons, W. 1987. A new rapid clean-up procedure for the simultaneous determination of different groups of organic micropollutants in sediments; application in two European estuarine sediment studies. *Environ. Techn. Lett.* 8: 9–20.
- Jensen, S., Renbey, L., and Reutergårdh, L. 1977. Residue analysis of sediment and sewage sludge for organochlorines in the presence of elemental sulfur. *Analytical Chemistry*, 49: 316–318.
- Law, R.J., Webster, L., Theobald, N. Rumney, H.S. and de Boer, J. (2011) Organic Micropollutants. *In* Chemical Marine Monitoring: Policy Framework and Analytical Trends, Quevauviller, P. Roose, P. And Verreet, G. John Wiley /Sons, Ltd.
- Smedes, F., and de Boer, J. 1994. Guidelines for the determination of chlorobiphenyls in sediments. *Quimica Analytica*, 13: 100–108.
- Smedes, F., and de Boer, J. 1998. Chlorobiphenyls in marine sediments: Guidelines for determination. ICES Techniques in Marine Environmental Sciences, No.21. 24 pp.

Annex XII:

OSPAR COMMISSION

CEMP Guidelines for Monitoring Contaminants in Sediments

(OSPAR Agreement 2002-16)

Technical Annex 3: Determination of parent and alkylated PAHs in sediments



CEMP Guidelines for Monitoring Contaminants in Sediments

(OSPAR Agreement 2002-16)

Technical Annex 3: Determination of parent and alkylated PAHs in sediments

1. Introduction

Polycyclic aromatic hydrocarbons (PAHs) consist of a variable number of fused aromatic rings. By definition, PAHs contain at least two fused rings. PAHs arise from incomplete combustion processes and from both natural and anthropogenic sources, although the latter generally predominate. PAHs are also found in oil and oil products, and these include a wide range of alkylated PAHs formed as a result of diagenetic processes, whereas PAHs from combustion sources comprise mainly parent (non-alkylated) PAHs. Metabolites of some of the high MW PAHs are potent animal and human carcinogens – benzo[*a*]pyrene is the prime example. Carcinogenic activity is closely related to structure. Benzo[*e*]pyrene and the four benzofluoranthene isomers all have a molecular weight of 252 Da, however they are much less potent than benzo[*a*]pyrene. Less is known about toxicity of alkylated PAHs. However, one study has demonstrated that alkylated PAHs may have increased toxicity compared to the parent compound (Marvanova *et al.*, 2008).

This Technical Annex provides advice on the analysis of parent and alkylated polycyclic aromatic hydrocarbons (PAH) in total sediment, sieved fractions, and suspended particulate matter. The analysis of in sediments generally includes extraction with organic solvents, clean-up, high performance liquid chromatography (HPLC) with ultraviolet or fluorescence detection or gas chromatographic (GC) separation with flame ionisation (FID) or mass spectrometric (MS) detection (e.g., Fetzer and Vo-Dinh, 1989; Wise *et al.*, 1995). All steps in the procedure are susceptible to insufficient recovery and/or contamination. Quality control procedures are recommended in order to check the performance of the method. These guidelines are intended to encourage and assist analytical chemists to critically reconsider their methods and to improve their procedures and/or the associated quality control measures, where necessary.

These guidelines are not intended as a complete laboratory manual. If necessary, guidance should be sought from highly specialised research laboratories. Whichever procedure is adopted, each laboratory must demonstrate the validity of each step of its procedure. In addition, the use of a second (and different method), carried out concurrently to the routine procedure, is recommended for validation. The analyses must be carried out by experienced staff.

2. Pre-treatment and Storage

2.1 Contamination

Sample contamination may occur during sampling, sample handling, pre-treatment and analysis, due to the environment, the containers or packing materials used, the instruments used during sample preparation, and from the solvents and reagents used during the analytical procedures. Controlled conditions are therefore required for all procedures. In the case of PAHs, particular care must be taken

to avoid contamination at sea. On ships there are multiple sources of PAHs, such as the oils used for fuel and lubrication, and the exhaust from the ship's engines. It is important that the likely sources of contamination are identified and steps taken to preclude sample handling in areas where contamination can occur. A ship is a working vessel and there can always be procedures occurring as a result of the day-to-day operations (deck cleaning, automatic overboard bilge discharges, etc.) that could affect the sampling process. It is advisable to collect samples of the ship's fuel, bilge water, and oils and greases used on winches, etc., which can be used as fingerprinting samples at a later date, if there are suspicions of contamination in particular instances.

Freeze-drying of sediment samples may be a source of contamination due to the back-streaming of oil vapours from the rotary vacuum pumps. Furthermore drying the samples may result in losses of the lower molecular weight, more volatile PAHs through evaporation (Law *et al.*, 1994).

Plastic materials must not be used for sampling and storage owing to possible adsorption of the PAHs onto the container material. Samples should be transported in closed containers; a temperature of 25°C should not be exceeded. If the samples are not analysed within 48 hours after sampling, they must be stored at 4°C (short-term storage). Storage over several months is only possible for frozen, (i.e., below -20°C) and/or dried samples (Law and de Boer, 1995).

As PAHs are sensitive to photo-degradation, exposure to direct sunlight or other strong light must be avoided during storage of the samples as well as during all steps of sample preparation, including extraction and storage of the extracts (Law and Biscaya, 1994). The use of amber glassware is strongly recommended.

2.2 Blanks

The procedural detection limit is determined by the blank value. In order to keep the blank value as low as possible, PAHs or other interfering compounds should be removed from all glassware, solvents, chemicals, adsorption materials, etc., that are used in the analysis. The following procedures should be used:

- glassware should be thoroughly washed with detergents and rinsed with an organic solvent prior to use. Further cleaning of the glassware, other than calibrated instruments, can be carried out by heating at temperatures >250°C;
- all solvents should be checked for impurities by concentrating the amount normally used to 10% of the normal end volume. This concentrate can then be analysed by GC and should not contain significant amounts of PAHs or other interfering compounds;
- all chemicals and adsorption materials should be checked for impurities and purified (e.g., by heating or extraction), if necessary. Soxhlet thimbles should be pre-extracted. Glassfibre thimbles are preferred over paper thimbles. Alternatively, full glass Soxhlet thimbles, with a G1 glass filter at the bottom, can be used. The storage of these supercleaned materials for a long period is not recommended, as laboratory air can contain PAHs that will be absorbed by these materials. Blank values occurring despite all the above-mentioned precautions may be due to contamination from the air. The most volatile compounds will usually show the highest blanks (Gremm and Frimmel, 1990).
- Glassfibre filters used for the PLE (pressurised liquid extraction) method should be heated at 450°C overnight.

3. Pre-treatment

Before taking a subsample for analysis, the samples should be sufficiently homogenised. The intake mass is dependent on the expected concentrations. For the marine environment, as a rule of thumb, the mass of sample taken for analysis can be equal to an amount representing 50–100 mg organic carbon. PAHs can be extracted from wet or dried samples. However, storage, homogenisation and extraction are much easier when the samples are dry. Care must be taken if freeze-drying samples for the reasons described in 2.1. Possible losses and contamination have to be checked. Contamination can be checked by exposing 1–2 g C18-bonded silica to drying conditions and analysing it as a sample (clean-up can be omitted) (Smedes and de Boer, 1997). Contamination during freeze-drying can be reduced by placing a lid, with a hole about 3 mm in diameter, on the sample container, while evaporation of the water is not hindered.

4. Extraction and clean-up

Exposure to light must be kept to a minimum during extraction and further handling of the extracts (Law and Biscaya, 1994). Since photo-degradation occurs more rapidly in the absence of a sample matrix, first of all the standard solution used for checking the recovery of the procedure will be affected, allowing a proper detection of the influence of light. The most photo-sensitive PAH is benzo[*a*]pyrene, followed by anthracene.

4.1 Wet sediments

Wet sediments should be extracted using a stepwise procedure by mixing with organic solvents. Extraction is enhanced by shaking, Ultra Turrax mixing, ball mill tumbling or ultrasonic treatment. Water-miscible solvents, such as acetone, methanol, or acetonitrile, are used in the first step. The extraction efficiency of the first step will be low as there is a considerable amount of water in the liquid phase. For sufficient extraction, at least three subsequent extractions are needed. The contact time with the solvent should be sufficient to complete the desorption of the PAHs out of the sediment pores. Heating by microwave or refluxing will accelerate this process.

When utilising a Soxhlet, the extraction of wet sediments should be conducted in two steps. First, a polar solvent, such as acetone, is used to extract the water from the sediment, then the flask is replaced and the extraction continued with a less polar solvent or solvent mixture (e.g., acetone/hexane). Thereafter, the extracts must be combined. For both batch and Soxhlet extraction, water must be added to the combined extracts and the PAHs must be extracted to a non-polar solvent.

Extraction of wet sediments by pressurised liquid extraction (PLE) is a more recent method, requiring less solvent and time for the extraction process. Wet sediment is dried by mixing with sufficient anhydrous sodium sulphate to form a free flowing mixture and is packed into stainless steel tubes for extraction. Extractions are performed at elevated temperatures and pressures. Various extracting solvents (DCM, acetone, methanol, acetonitrile, hexane, DCM: acetone [1:1], hexane:acetone [1:1]) were investigated by Saim *et al.* (1998) and as long as the solvent polarity was >1.89 (*i.e.* all except hexane) no significant differences were noted. Extraction temperatures can be manipulated to suit the analytical requirements.

4.2 Dry sediments

Although all the methods mentioned above can also be used for dried sediments, Soxhlet extraction is the most frequently applied technique to extract PAHs from dried sediments. Medium-polar

solvents such as dichloromethane or toluene, or mixtures of polar and non-polar solvents can be used. When using dichloromethane, losses of PAHs have occasionally been observed (Baker, 1993). Although toluene is not favoured because of its high boiling point, it should be chosen as solvent when it is expected that sediment samples contain soot particles. For routine marine samples, the use of a mixture of a polar and a non-polar solvent (e.g., acetone/hexane (1/3, v/v)) is recommended.

The extraction can be carried out with a regular or a hot Soxhlet (Smedes and de Boer, 1997). A sufficient number of extraction cycles must be performed (approximately 8 hours for the hot Soxhlet and 12 to 24 hours for normal Soxhlet). The extraction efficiency has to be checked for different types of sediments by a second extraction step. These extracts should be analysed separately.

PLE can also be used for the extraction of freeze-dried sediments. Instead of anhydrous sodium sulphate to dry the sediment the sample is mixed with a clean sand or diatomaceous earth to increase the surface area of the sediment. The same solvent mixtures detailed above for wet sediment extraction can be used for the dry sediments. Supercritical fluid extraction (SFE) has also been used for the extraction of organic compounds. The optimum conditions may vary for specific sediments (e.g., Dean *et al.*, 1995; Reimer and Suarez, 1995).

4.3 Clean-up

The crude extract requires a clean-up to remove the many other compounds which are co-extracted (e.g., Wise *et al.*, 1995). Due to chlorophyll-like compounds extracted from the sediment, the raw extract will be coloured and also contain sulphur and sulphur-containing compounds, oil, and many other natural and anthropogenic compounds. Selection of the appropriate clean-up method depends on the subsequent instrumental method to be used for analysis. Prior to the clean-up, the sample must be concentrated and any polar solvents used in the extraction step should be removed. The recommended acetone/hexane mixture will end in hexane when evaporated because of the formation of an azeotrope. Evaporation can be done either using a rotary evaporator or parallel evaporating systems such as Syncore. Especially for the rotary evaporator, care should be taken to stop the evaporation in time at about 5 ml. For further reducing the volume, a gentle stream of nitrogen should be applied. The extract should never be evaporated to dryness. The drawback of the rotary evaporator is that more volatile components may be lost during the nitrogen drying stage whilst the heavier components stick to the glassware. The Buchi Syncore Analyst also uses glass tubes but the system is sealed, avoiding contamination from the lab air during evaporation. It does not use a nitrogen stream, thus reducing the loss of volatiles and if the flashback module is fitted the sides of the tubes are rinsed automatically thus reducing the loss of the heavier components.

For removing more polar interferences from the extract, deactivated aluminium oxide (10 % water), eluted with hexane, as well as silica or modified silica columns, e.g., aminopropylsilane, eluted with toluene or a semipolar solvent mixture such as hexane/acetone (95/5, v/v) or hexane/dichloromethane (98/2, v/v), can be used. Gel permeation chromatography (GPC) can be used to remove high molecular weight material and sulphur from the extracts.

For GC-MS analysis, sulphur should be removed from the extracts, in order to protect the detector. This can be achieved by the addition of copper powder, wire or gauze during or after Soxhlet extraction. Copper can also be added to the PLE cell, however, this is not always sufficient and further treatment with copper may be required following extraction. Ultrasonic treatment might improve the removal of sulphur. As an alternative to copper, other methods can be used (Smedes and de Boer, 1997).

Aliphatic hydrocarbons originating from mineral oil interfere with the flame ionisation detection. They can be removed from the extract by fractionation over columns filled with activated aluminium oxide or silica. The first fraction eluting with hexane is rejected. The PAHs elute in a second fraction with a more polar solvent, e.g., diethylether or acetone/hexane. When applying fractionation, the elution pattern has to be checked frequently. This should be carried out in the presence of sample matrix, as that can partially deactivate the clean-up column, resulting in earlier elution of the PAHs than in a standard solution.

Gel permeation chromatography (GPC) and high performance liquid chromatography (HPLC) based methods are also employed (Nondek *et al.*, 1993; Nyman *et al.*, 1993; Perfetti *et al.*, 1992). The major advantages of using HPLC-based clean-up methods are their ease of automation and reproducibility.

Isocratic HPLC fractionation of the extract can be used to give separate aliphatic and aromatic fractions (Webster *et al.*, 2002). A metal free silica column is used for the clean up/fractionation as dibenzothiophene (DBT) can be retained on ordinary silica columns. The split time is determined by injection of a solution containing representative aliphatic and PAH standards. The silica column is regenerated by a cleaning cycle after a set number of samples. If PAHs are to be analysed by HPLC and there are significant amounts of alkylated PAHs present then the removal of the alkylated PAHs may be difficult.

4.4 Pre-concentration

In the methods suggested above, all result in an extract in which non-polar solvents are dominant. The sample volume should be 2 ml or greater to avoid errors when transferring solvents during the clean-up stages. Syncore parallel evaporators can be used with careful optimisation of the evaporation parameters. Evaporation of solvents using a rotary-film evaporator should be performed at low temperature (water bath temperature of 30°C or lower) and under controlled pressure conditions, in order to prevent losses of the more volatile PAHs such as naphthalenes. For the same reasons, evaporation to dryness must be avoided. When reducing the sample to final volume, solvents can be removed by a stream of clean nitrogen gas. Suitable solvents for injection into the GC-MS include pentane, hexane, heptane, *iso*-hexane, and *iso*-octane.

5. Selection of PAHs to be determined

The choice of PAHs to be analysed is not straightforward, both because of differences in the range of PAH compounds resulting from combustion processes and from oil and oil products, and also because the aims of specific monitoring programmes can require the analysis of different representative groups of compounds. PAHs arising from combustion processes are predominantly parent (unsubstituted) compounds, whereas oil and its products contain a much wider range of alkylated compounds in addition to the parent PAHs. This has implications for the analytical determination, as both HPLC-based and GC-based techniques are adequate for the determination of a limited range of parent PAHs in samples influenced by combustion processes, whereas in areas of significant oil contamination and following oil spills only GC-MS has sufficient selectivity to determine the full range of PAHs present. The availability of pure individual PAHs for the preparation of standards is problematic and limits both the choice of determinands and, to some degree, the quantification procedures that can be used. The availability of reference materials certified for PAHs is also rather limited. A list of target parent and alkylated PAHs suitable for environmental monitoring is given in Table A2.1, and this differs both from the list previously developed within ICES specifically for

intercomparison purposes, and the historic list of Borneff. In both cases, the lists were concentrated on a subset of parent (predominantly combustion-derived) PAHs due to analytical limitations. This approach completely neglects the determination of alkylated PAHs, which allows the interpretation of PAH accumulation from multiple sources including those due to oil inputs. It will not be necessary for all of these PAH compounds and groups to be analysed in all cases, but an appropriate selection can be made from this list depending on the specific aims of the monitoring programme to be undertaken.

Table A2.1 Compounds of interest for environmental monitoring for which the guidelines apply. For compounds in italics standards are not available for any isomers in this group.

Compound	MW	Compound	MW
Naphthalene	128	Benzo[b]naphtho[2,3- <i>d</i>]thiophene	234
<i>C</i> ₁ -Naphthalenes	142	<i>C</i> ₁ -benzonaphthothiophenes	248
<i>C</i> ₂ -Naphthalenes	156	<i>C</i> ₂ -Fluoranthenes/Pyrenes	230
<i>C</i> ₃ -Naphthalenes	170	Benz[<i>a</i>]anthracene	228
<i>C</i> ₄ -Naphthalenes	184	Chrysene	228
Acenaphthylene	152	2,3-Benzanthracene	228
Acenaphthene	154	<i>C</i> ₁ - Benz[<i>a</i>]anthracene/ Chrysene	242
Biphenyl	154	<i>C</i> ₂ - Benz[<i>a</i>]anthracene/ Chrysene	256
Fluorene	166	<i>C</i> ₃ - Benz[<i>a</i>]anthracene/ Chrysene	270
<i>C</i> ₁ -Fluorenes	180	Benzo[<i>a</i>]fluoranthene	252
<i>C</i> ₂ -Fluorenes	194	Benzo[<i>b</i>]fluoranthene	252
<i>C</i> ₃ -Fluorenes	208	Benzo[<i>j</i>]fluoranthene	252
Dibenzothiophene	184	Benzo[<i>k</i>]fluoranthene	252
<i>C</i> ₁ -Dibenzothiophenes	198	Benzo[<i>e</i>]pyrene	252
<i>C</i> ₂ -Dibenzothiophenes	212	Benzo[<i>a</i>]pyrene	252
<i>C</i> ₃ -Dibenzothiophenes	226	Perylene	252
Phenanthrene	178	Indeno[1,2,3- <i>cd</i>]pyrene	276
Anthracene	178	Benzo[<i>ghi</i>]perylene	276
<i>C</i> ₁ -Phenanthrenes/Anthracenes	192	Dibenz[<i>a,h</i>]anthracene	278
<i>C</i> ₂ -Phenanthrenes/Anthracenes	206	Benzo[<i>k</i>]fluoranthene	252
<i>C</i> ₃ -Phenanthrenes/Anthracenes	220	Cyclopenta[<i>cd</i>]pyrene	226
Fluoranthene	202	Naphtho[2,1- <i>a</i>]pyrene	302
Pyrene	202	Dibenz[<i>a,e</i>]pyrene	302
<i>C</i> ₁ -Fluoranthenes/Pyrenes	216	Dibenz[<i>a,i</i>]pyrene	302
Benzo[<i>b</i>]naphtho[2,1- <i>d</i>]thiophene	234	Dibenz[<i>a,l</i>]pyrene	302
Benzo[<i>b</i>]naphtho[1,2- <i>d</i>]thiophene	234	Dibenz[<i>a,h</i>]pyrene	302

6. Instrumental determination of PAHs

The greatest sensitivity and selectivity in routine analysis for parent PAH is achieved by combining HPLC with fluorescence detection (HPLC-UVF) or capillary gas chromatography with mass spectrometry (GC-MS). However, for the analysis of parent and alkylated PAHs GC-MS is the method of choice. In terms of flexibility, GC-MS is the most capable technique, as in principle it does not limit the selection of determinands in any way, while HPLC is suited only to the analysis of parent PAHs. In the past, analyses have also been conducted using HPLC with UV-absorption detection and GC with flame-ionisation detection, but neither can be recommended for alkylated PAHs because of their relatively poor selectivity. Both in terms of the initial capital cost of the instrumentation, and the cost per sample analysed, HPLC-UVF is cheaper than GC-MS. With the advent of high-sensitivity benchtop

GC-MS systems, however, this cost advantage is now not as marked as in the past, and the additional information regarding sources available makes GC-MS the method of choice.

Limits of determination within the range of $0.05 \mu\text{g kg}^{-1}$ dry weight for individual PAH compounds should be achievable by GC-MS.

6.1 GC-MS

The three injection modes commonly used are splitless, on-column and PTV (programmed temperature vaporiser). Automatic sample injection should be used wherever possible to improve the reproducibility of injection and the precision of the overall method. If splitless injection is used, the liner should be of sufficient capacity to contain the injected solvent volume after evaporation. For PAH analysis, the cleanliness of the liner is also very important if adsorption effects and discrimination are to be avoided, and the analytical column should not contain active sites to which PAHs can be adsorbed. Helium is the preferred carrier gas, and only capillary columns should be used. Because of the wide boiling range of the PAHs to be determined and the surface-active properties of the higher PAHs, the preferred column length is 25–50 m, with an internal diameter of 0.15 mm to 0.3 mm. Film thicknesses of $0.2 \mu\text{m}$ to $1 \mu\text{m}$ are generally used; this choice has little impact on critical resolution, but thicker films are often used when one-ring aromatic compounds are to be determined alongside PAHs, or where a high sample loading is needed. No stationary phase has been found on which all PAH isomers can be resolved; the most commonly used stationary phase for PAH analysis is 5% phenyl methylsilicone (DB-5 or equivalent). This will not, however, resolve critical isomers such as benzo[*b*], [*j*] and [*k*]fluoranthenes, or chrysene from triphenylene. Chrysene and triphenylene can be separated on other columns, if necessary such as a 60 m non-polar column such as DB5MS. For PAHs there is no sensitivity gain from the use of chemical ionisation (either positive or negative ion), so analyses are usually conducted in electron-impact mode at 70eV. Quadrupole instruments are used in single ion monitoring to achieve greater sensitivity. The masses to be detected are programmed to change during the analysis as different PAHs elute from the capillary column. In SIM the molecular ion is used for quantification. Qualifier ions can be used to confirm identification but they are limited for PAHs. Triple quadrupole mass spectrometry can also be used and will give greater sensitivity. Some instruments such as ion-trap and time of flight mass spectrometers exhibit the same sensitivity in both modes, so full scan spectra can be used for quantification.

An example of mass spectrometer operating conditions in SIM mode is given in Table A2.2. The ions are grouped and screened within GC time windows of the compounds. In general the number of ions should not be greater than 20. The dwell time is an important parameter and should be close for each ion. For GC capillary column analysis a dwell time should not be shorter than 20 ms, while a sum of a dwell in each retention time windows should not be greater than 500 ms. An example of conditions that can be used along with dwell times are shown in Table A2.2.

Table A.2.2 Example of operational conditions for the GC-MS analysis of parent and alkylated PAHs.

Group N°	Retention time (min)	Dwell time (ms)	Ions in group (AMU)					
1	8.00	100	128	136	142			
2	21.00	100	152	156	160			
3	23.70	100	154	164	168	170		
4	26.80	80	166	176	180	182	184	
5	31.60	80	178	184	188	194	196	198
6	35.30	100	192	198				
7	36.60	100	206	212				
8	39.40	80	202	206	212	216	220	226
9	44.65	100	216	220				
10	45.30	100	226	228	230	234	240	
11	48.58	90	242	248				
12	52.00	100	252	256	264	266		
13	59.00	100	266	276	278	288		

Alkylated homologues of PAHs (C1–C4), mainly associated with petrogenic sources, contain a number of different isomers that can give very complex but distinct distribution profiles when analysed by GC-MS. Integration of each isomer separately is difficult for most alkylated PAHs. 1- and 2-Methyl naphthalene give well resolved peaks that can be quantified separately. C1-Phenanthrene/anthracene gives five distinct peaks corresponding to 3-methyl phenanthrene, 2-methyl phenanthrene, 2-methyl anthracene, 4- and 9-methyl phenanthrene and 1-methyl phenanthrene. These may be integrated as a group or as separate isomers. For all other alkylated PAHs the area for all isomers may be summed and quantified against a single representative isomer. This method will, however, lead to an overestimation of the concentration as may include non alkylated PAHs. Examples of integrations of both parent and alkylated PAHs are shown in Appendix 1.

7. Calibration and quantification

7.1 Standards

The availability of pure PAH compounds are limited. Although most of the parent compounds can be purchased as pure compounds, the range of possible alkyl-substituted PAHs is vast and only a limited selection of them can be obtained. PAH standards are available for at least one isomer of most alkyl group listed in Table A2.1. A range of deuterated PAHs (normally 5 to 7) should be used as internal standards to cover the range of PAHs being analysed in samples. A range of fully-deuterated parent PAHs is available for use as standards in PAH analysis. Suitable standards could range from d_8 -naphthalene to d_{14} -dibenz[*a,h*]anthracene. Crystalline PAHs of known purity should be used for the

preparation of calibration standards. If the quality of the standard materials is not guaranteed by the producer or supplier (as for certified reference materials), then it should be checked by GC-MS analysis. Solid standards should be weighed to a precision of 10^{-5} grams. Calibration standards should be stored in the dark because some PAHs are photosensitive, and ideally solutions to be stored should be sealed in amber glass ampoules or sealed GC vials. Otherwise, they can be stored in a refrigerator in stoppered measuring cylinders or flasks that are gas tight to avoid evaporation of the solvent during storage.

7.2 Calibration

Multilevel calibration with at least five calibration levels is preferred to adequately define the calibration curve. In general, GC-MS calibration is linear over a considerable concentration range but may exhibit a change of slope at very low concentrations. Quantification should be conducted in the linear region of the calibration curve. A separate calibration curve may be used where sample concentrations are very low. An internal standard method should be employed, using a range of deuterated PAHs as internal standards.

7.3 Recovery

The recovery of analytes should be checked and reported. Given the wide boiling range of the PAHs to be determined, the recovery may vary with compound group, from the volatile PAHs of low molecular weight to the larger compounds. Deuterated standards can be added in two groups: those to be used for quantification are added at the start of the analytical procedure, whilst those from which the absolute recovery will be assessed are added prior to GC-MS injection. This allows the recovery to be calculated.

8. Analytical quality control

Planners of monitoring programmes must decide on the accuracy, precision, repeatability, and limits of detection and determination, which they consider acceptable. Achievable limits of determination for each individual component using GC-MS are $0.05 \mu\text{g kg}^{-1}$ dry weight.

Further information on analytical quality control procedures for PAHs can be found elsewhere (Law and de Boer, 1995). A procedural blank should be measured with each sample batch, and should be prepared simultaneously using the same chemical reagents and solvents as for the samples. Its purpose is to indicate sample contamination by interfering compounds, which will result in errors in quantification. The procedural blank is also very important in the calculation of limits of detection and limits of quantification for the analytical method. In addition, a laboratory reference material (LRM) should be analysed within each sample batch. The LRM must be homogeneous and well characterised for the determinands of interest within the analytical laboratory. Ideally, stability tests should have been undertaken to show that the LRM yields consistent results over time. The LRM should be of the same matrix type (e.g., liver, muscle, mussel tissue) as the samples, and the determinand concentrations should be in the same range as those in the samples. Realistically, and given the wide range of PAH concentrations encountered, particularly in oil spill investigations, this is bound to involve some compromise. The data produced for the LRM in successive sample batches should be used to prepare control charts. It is also useful to analyse the LRM in duplicate from time to time to check within-batch analytical variability. The analysis of an LRM is primarily intended as a check that the analytical method is under control and yields acceptable precision, but a certified reference material (CRM) of a similar matrix should be analysed periodically in order to check the method bias.

A marine sediment (NIST SRM 1941b)¹ is available, with certified values for 24 PAHs and a further 44 as reference (non-certified) values. At regular intervals, the laboratory should participate in an intercomparison or proficiency exercise in which samples are circulated without knowledge of the determinand concentrations, in order to provide an independent check on performance.

9. Data reporting

The calculation of results and the reporting of data can represent major sources of error, as has been shown in intercomparison studies for PAHs. Control procedures should be established in order to ensure that data are correct and to obviate transcription errors. Data stored on databases should be checked and validated, and checks are also necessary when data are transferred between databases. Data should be reported in accordance with the latest ICES reporting formats.

10. References

Baker, J. T. 1993. Baker communication 'Baker Gramm': Dichloromethane.

Dean, J. R., Barnabas, I. J., and Fowles, I. A. 1995. Extraction of polyaromatic hydrocarbons from highly contaminated soils: A comparison between Soxhlet, microwave and supercritical fluid extraction techniques. *Analytical Proceedings*, 32: 305–308.

Farrington, J. W., Davis, A. C., Livramento, J. B., Clifford, C. H., Frew, N. M., and Knap, A. 1986. ICES/IOC Intercomparison Exercises on the Determination of Petroleum Hydrocarbons in Biological Tissues (mussel homogenate) – ICES (2/HC/BT). ICES Cooperative Research Report, 141: 1–75.

Fetzer, J. C., and Vo-Dinh, T. 1989. *Chemical analysis of polycyclic aromatic compounds*. Wiley, New York.

Gremm, T., and Frimmel, F.H. 1990. Systematische Untersuchung zur PAK-Bestimmung mittels HPLC (Systematic investigations of PAH-determination with HPLC). (In German). *Vom Wasser*, 75: 171–182.

Höfler, F., Jensen, D., Ezzel, J., and Richter, B. 1995. Accelerated solvent extraction of PAHs from solid samples with subsequent HPLC analysis. *GIT Spezial. Chromatographie*, 1/95.

Law, R. J., and Biscaya, J. L. 1994. Polycyclic aromatic hydrocarbons (PAHs)—problems and progress in sampling, analysis and interpretation. *Marine Pollution Bulletin*, 29: 235–241.

Law, R. J., and de Boer, J. 1995. Quality assurance of analysis of organic compounds in marine matrices: application to analysis of chlorobiphenyls and polycyclic aromatic hydrocarbons. In *Quality assurance in environmental monitoring*. Ed. by P. Quevauviller. VCH Weinheim, New York.

Law, R. J., and Klungsøyr, J. 1996. The 1994 QUASIMEME laboratory-performance studies: Polycyclic aromatic hydrocarbons (PAHs) in standard solutions. *Marine Pollution Bulletin*, 32: 667–673.

Law, R. J., Klungsøyr, J., and Fredriks, I. L. 1998. The QUASIMEME interlaboratory testing scheme for polycyclic aromatic hydrocarbons (PAHs): assessment of the first three rounds, 1994–1995. *Marine Pollution Bulletin*. 35: 64–77.

Law, R. J., Klungsøyr, J., Roose, P., and de Waal, W. 1994. *Marine Pollution Bulletin*, 29: 217.

Marvanova, S., Vondracek, J., Pencikova, K., Trilecova, L., Krcmar, P., Topinka, J., Novakova, Z., Milcova, A., and Machala, M. 2008. Toxic effects of methylated[a]anthracenes in liver cells. *Chemical Research in Toxicology*. In press.

¹ More info on https://srmors.nist.gov/view_detail.cfm?srm=1941B

Reimer, G., and Suarez, A. 1995. Comparison of supercritical fluid extraction and Soxhlet extraction for the analysis of native polycyclic aromatic hydrocarbons in soil. *Journal of Chromatography A*, 699: 253–263.

Reupert, R., and Brausen, G. 1994. Bestimmung von polycyclischen aromatischen Kohlenwasserstoffen in Wasser, Sediment, Schlamm und Boden mittels Hochleistungsflüssigkeitschromatographie (Determination of polycyclic aromatic hydrocarbons in water, sludges, sediments, and soils by high performance liquid chromatography). *Acta Hydrochimica Hydrobiologica*, 22: 202–215.

Richter, B. E., Ezzell, J. L., Felix, D., Roberts, K. A., and Later, D. W. 1995. An accelerated solvent extraction system for the rapid preparation of environmental organic compounds in soil. *American Laboratory*, 27: 24–28.

Saim, N., Dean, J. R., Abdullah, P., and Zakaria, Z. 1998. 'An experimental design approach for the determination of polycyclic aromatic hydrocarbons from highly contaminated soil using accelerated solvent extraction', *Analytical Chemistry*, 70, 420-424.

Smedes, F., and de Boer, J. 1997. Chlorobiphenyls in marine sediments: guidelines for determination. *ICES Techniques in Marine Environmental Sciences*, No. 21.

Wise, S. A., Schantz, M. M., Benner, B. A., Hays, M. J., and Schiller, S. B. 1995. Certification of polycyclic aromatic hydrocarbons in a marine sediment standard reference material. *Analytical Chemistry*, 67: 1171–1178.

Webster, L., McIntosh, A. D., Megginson, C., Shepherd, N. J., and Moffat, C. F. 2002. The polycyclic aromatic hydrocarbon composition of mussels (*Mytilus edulis*) from Scottish coastal waters. *Journal of Environmental Monitoring*. 5:150-159.

Annex XIII:

HELCOM

Guidelines for the determination of polycyclic aromatic hydrocarbons (PAH) in sediment

Guidelines for the determination of polycyclic aromatic hydrocarbons (PAH) in sediment

1. Introduction	1
2. Sampling and storage.....	2
3. Blanks and contamination	2
4. Pretreatment	3
5. Extraction and clean-up	3
5.1 Extraction of wet sediments	3
5.2 Extraction of dry sediments	4
5.3 Clean-up	4
6. Chromatographic determination	5
6.1 High performance liquid chromatography.....	6
6.1.1 Columns	6
6.1.2 Gradient Elution.....	6
6.1.3 Detection	7
6.1.4 Identification	7
6.2 Gas chromatography	7
6.2.1 Columns	7
6.2.2 Carrier gas.....	8
6.2.3 Injection techniques	8
6.2.4 Temperature programming.....	8
6.2.5 Detection	8
6.2.6 Identification	8
7. Quantification	8
8. Quality Assurance	9
8.1 Extraction efficiency and clean-up	9
8.2 Calibrant and calibration	9
8.3 System performance	10
8.4 Long-term stability	10
8.5 Internal standards	10
8.6 Interlaboratory proficiency testing schemes	10
9. References	10

1. Introduction

This Technical note provides advice on the analysis of polycyclic aromatic hydrocarbons (PAH) in total marine sediments, sieved fractions, and suspended particulate matter. The analysis of PAH compounds in sediments basically includes extraction with organic solvents, clean-up, and separation through high performance liquid chromatography (HPLC) with ultraviolet (UV) or fluorescence detection or gas chromatographic separation (GC) with flame ionization (FID) or mass spectrometric (MS) detection (Kassim & Barcelo, 2009, 1989; Wise *et al.*, 1995).

All steps of the procedure are susceptible to insufficient recovery and contamination. Quality control measures are recommended in order to regularly monitor the performance of the method. These guidelines are intended to encourage and assist analytical chemists to critically review their methods and to improve their procedures and quality assurance measures, if necessary.

These guidelines are not intended as complete laboratory manual. If necessary, guidance should be sought from specialized laboratories. Laboratories should demonstrate validity of each methodological step.

Moreover, use of an alternative method, carried out concurrently to the routine procedure, is recommended for validation.

Contracting parties should follow the HELCOM monitoring guideline but minor deviations from this are acceptable if the method achieves comparable results. Validation of the adopted method needs to be performed on the relevant matrix and concentration range e.g. by taking part in intercomparison studies or proficiency testing schemes.

2. Sampling and storage

The major criterion for successful sediment sampling is to ensure undisturbed sample stratification. (For further details about sampling, see Annex B-13, Appendix 3 "Technical note on the determination of heavy metals in marine sediments" of the HELCOM COMBINE manual.)

Plastic materials should not be used for sampling and storage due to the risk of adsorption of PAH compounds onto the container material. Samples should be transported in closed containers and preferentially at temperatures below 10 °C. The samples should be stored at 4 °C as soon as possible, but at least if they have not been analysed within 48 hours after collection (short-term storage). For long-term storage over several months the samples should be frozen below -20 °C or dried (Law and de Boer, 1995). When drying, avoid methods with substantial risk of losing volatile substances (see Chapter 4: Pretreatment).

PAH compounds are sensitive to photo-degradation and, thus, exposure to direct sunlight or other light sources should be avoided during storage as well as during all steps of sample preparation (Law and Biscaya, 1994). The use of amber glassware is strongly recommended.

3. Blanks and contamination

Basically, care should be taken to avoid contaminations during all steps of the analytical chain, including sampling, extraction and clean-up.

In order to reduce blank and sample contaminations to a minimum it is strongly recommended to pretreat all used glassware, solvents, chemicals, adsorption materials, etc., as follows:

- Glassware should be thoroughly washed with detergents and can be furthered cleaned, other than calibrated instruments, by heating at temperatures > 250 °C. The glassware should be rinsed with an organic solvent prior to use.
- All solvents should be analyzed for impurities by concentrating to 10 % of the regular final volume. This concentrate is then analysed similarly to a sample by HPLC or GC. The solvent blank should not contain target analytes or other interfering compounds in higher concentrations than specified by the laboratory.
- All chemicals and adsorption materials should be analyzed for impurities and purified (e.g., by heating or extraction), if necessary. Soxhlet thimbles should be pre-extracted. Glass fiber thimbles are preferred over paper thimbles. Alternatively, full glass Soxhlet thimbles, with a G1 glass filter at the bottom, can be used.

Storage of these supercleaned materials for a longer period is not recommended, as laboratory air might contain PAH compounds which can adsorb onto these materials. Therefore, contaminated blank samples might occur despite precautionary measures due to contamination from the air. Volatile compounds, in particular naphthalene and phenanthrene, are usually the most common contaminants in blank samples (Gremm and Frimmel, 1990). Therefore, if possible, critical steps should be done in a clean bench.

4. Pretreatment

The samples should be thoroughly homogenized before subsampling for analysis. The amount of samples usually depends on the expected concentrations. For the marine environment, the amount of sample should be equal to an amount representing 50–100 mg of organic carbon.

PAHs can be extracted from wet or dried samples. However, storage, homogenization and extraction are easier to handle with dried samples.

Drying the samples at ambient or elevated temperatures as well as freeze-drying may alter the concentrations, e.g., by contamination or loss of compounds through evaporation (Law *et al.*, 1994). Therefore, potential losses and contaminations should be analyzed in advance, e.g. by exposing 1–2 g CIS-bonded silica to the drying conditions and subsequent extraction and analysis (clean-up can be omitted) (Smedes and de Boer, 1998). For evaluation of potential losses, analytes identical or similar to PAHs need to be added to the material. However, bear in mind that added analytes can behave differently from analytes that have interacted longer with the matrix material and therefore may be sorbed more strongly. To avoid contamination during freeze-drying, placing a lid with a hole of about 3 mm in diameter on the sample container is suggested.

Chemical drying of samples can be performed by grinding with Na_2SO_4 , or MgSO_4 until the sample reaches a sandy consistency. It is essential that several hours elapse between grinding and extraction to allow for complete dehydration of the sample. Residual water will decrease extraction efficiency.

5. Extraction and clean-up

Exposure to light must be kept to a minimum during extraction and further handling of the extracts (Law and Biscaya, 1994). The most photo-sensitive PAH is benzo[*a*]pyrene, followed by anthracene. Photo-degradation occurs more rapidly in the absence of a sample matrix. Therefore, the PAH standard solution should be regularly analyzed for their PAH content.

Other extraction and clean-up methods than those described below may be used, provided that the methods have been tested and found equivalent to established methods regarding e.g. recovery. For naphthalene, which can easily be lost in several steps during sample preparation, headspace or purge and trap analysis might provide a suitable alternative to extraction methods.

5.1 Extraction of wet sediments

A commonly used and very efficient method for PAH extraction from sediments is alkaline saponification. This method requires only a short extraction time (approximately 1.5 hrs under the reflux) and it also eliminates organic sulphur and other interfering compounds such as lipids. The resulting extract is easy to clean up.

Wet sediments could also be extracted using a stepwise procedure by mixing with organic solvents. Extraction is enhanced by shaking, Ultra Turrax mixing, ball mill tumbling or ultrasonic treatment. Water-miscible solvents, such as acetone, methanol, or acetonitrile, are used in the first step. The extraction efficiency of the first step will be low as there is a considerable amount of water in the liquid phase. In a second step a less polar solvent / solvent mixture such as acetone/hexane should be used. It has to be kept in mind that hexane is a lot more toxic than similar solvents such as pentane, heptane, cyclohexane, isohexane. For sufficient extraction at least three subsequent extractions are needed. The contact time with the solvent should be long enough to allow complete desorption of the PAH compounds from the sediment pores. The contact time might be up to 24 hours which basically depends on the type of sediment.

The required contact time of the sediment with the solvent can be reduced by using microwave extraction, supercritical fluid extraction, Soxhlet extraction or pressured liquid extraction (e.g. ASE). Soxhlet or ASE extraction of wet sediments should be conducted in two steps. First, a polar solvent, such as acetone, is

used to extract the water from the sediment. In a second step the collecting flask is replaced and the extraction will be continued using a less polar solvent or solvent mixture such as acetone/hexane or toluene. Thereafter, the extracts will be combined.

To separate the water and keep the PAHs in a solvent that is compatible with the continued analysis different methods can be used. For example, water will be added to the combined extracts and the PAH compounds will be extracted to a non-polar solvent. Another possibility is to add Na₂SO₄ to bind water.

Extraction should be conducted with a sufficient number of extraction cycles. Extraction efficiency should be analyzed for different types of sediments through a second extraction step. The extracts will be analysed separately and compared. A recovery of more than 90 % during the first extraction step is considered adequate.

5.2 Extraction of dry sediments

The methods described above can also be used for dried sediments. However, pressurized liquid extraction (PLE) is the most frequently applied technique to extract PAH compounds from dried sediments and it is recommended over mixing methods, in particular for dry samples.

Medium-polar solvents such as dichloromethane or toluene or mixtures of polar and non-polar solvents can be used. When using dichloromethane, losses of PAHs have occasionally been observed. Although toluene is not favored due to its high boiling point, it should be chosen when sediment samples could contain soot particles. For routine marine samples, the use of a mixture of a polar and a non-polar solvent such as acetone/hexane (1/3, v/v) is recommended.

Extraction should be conducted with a sufficient number of extraction cycles. Extraction efficiency should be analyzed for different types of sediments through a second extraction step. The extracts will be analysed separately and compared. A recovery of more than 90 % during the first extraction step is considered adequate.

5.3 Clean-up

The crude extracts usually require clean-up to remove co-extracted compounds (Wise *et al.*, 1995). Due to chlorophyll-like compounds extracted from the sediment, the raw extract is usually colored and also contains sulphur and sulphur-containing compounds, oil and other natural and anthropogenic compounds. Selection of the appropriate clean-up method depends on the subsequent instrumental method to be used for analysis.

Prior to the clean-up, the sample must be concentrated and polar solvents used during extraction should be removed. The recommended acetone/hexane mixture will result in hexane after evaporation due to the formation of an azeotrope if hexane is abundant. Evaporation can be done using either a Kuderna-Danish, a rotary evaporator or other evaporation system (e.g. parallel evaporation). In particular, upon using rotary or parallel evaporation, ambient or mild vacuum conditions and a water bath temperature of not more than 30 °C should be applied and care should be taken to stop evaporation at a sample volume of about 2 ml or by using automatic systems. For further volume reduction a gentle stream of nitrogen can be applied. The extract should never be evaporated to dryness.

To remove polar interferences from the extract the following chromatographic procedures can be used:

- deactivated aluminium oxide (10 % water), eluted with hexane – in particular upon using HPLC-Fluorescence for subsequent analysis
- silica or modified silica columns, e.g., aminopropylsilane or cyanopropyl phase eluted with toluene or a semipolar solvent mixture such as hexane/acetone (95/5, v/v) or hexane/dichloromethane (98/2, v/v)

- Gel permeation chromatography (LC-GPC) can be used to remove high molecular weight material and sulphur from the extracts

For GC-MS analysis sulphur should be removed from the extracts in order to protect the detector. This can be achieved by the addition of copper powder, wire or gauze during or after organic solvent extraction. Ultrasonic treatment might improve the removal of sulphur. Alternative methods to the use of copper were reported by (Smedes and de Boer, 1998).

Analysis by GC-FID or HPLC-UV requires a more elaborate clean-up. Aliphatic hydrocarbons originating from mineral oil interfere with the flame ionization detection. They can be removed from the extract by fractionation over columns filled with activated aluminium oxide or silica as described above. However, a first fraction is eluted with only hexane and then rejected. The PAHs elute in the second fraction with a more polar solvent, e.g., diethylether or acetone/hexane. When applying fractionation, the elution pattern has to be checked frequently and in the presence of sample matrix, as this can partially deactivate the clean-up column resulting in earlier elution of the PAH compounds than in the standard solution.

Alkylated PAHs are difficult to remove from extracts by column clean-up. When excessive amounts of these compounds are present, they may interfere with HPLC analysis and such samples should be better analysed by GC-MS. An alternative could be preparative HPLC fractionation using a normal phase silica, cyanopropyl or aminopropyl column.

After clean-up, the eluate or fractions must be concentrated, to e.g. 1 ml. Any concentration method should be conducted carefully as described above as high volatility of the PAH compounds may result in losses during evaporation. HPLC and GC require different solvents for injection of the extract. With the methods suggested, obtained extracts are usually in non-polar solvents. However, for HPLC analysis even small amounts of non-polar solvents may result in a shift of retention time and broadening of the peaks (Reupert and Brausen, 1994). Acetonitrile should be used preferentially as the PAH exhibit higher stability in acetonitrile as compared to e.g., methanol. Hexane can be removed by the addition of 5 ml acetonitrile for each ml of extract and subsequent evaporation to 1–2 ml. Azeotropic evaporation leaves only acetonitrile. During solvent exchange, evaporation to dryness should be avoided.

Azeotropic exchange can also be applied the other way around. In that case, 5 ml hexane must be added for each ml of acetonitrile.

For GC methods, *iso*-octane or toluene are suitable solvents for injection and can be added as keeper before evaporation to the required volume.

6. Chromatographic determination

The separation of PAHs should be optimized for at least the compounds listed in Annex B-13 (Appendix 1, Table 1) (Keith and Telliard, 1979). Separation should not only be optimized for a standard solution but also for a sample, as samples often contain several non-target PAHs that should be separated from the target compounds, if possible. In addition, sample extracts can be affected by remaining matrix effects, despite clean-up.

Basically and in particular for the parent PAH both HPLC-Fluorescence and GC-MS analyses are considered to be equally valid methods. However, with respect to the alkylated PAH species satisfactory analysis is often not obtained using HPLC. This is particularly relevant as alkylated PAH compounds are of increasing interest. Therefore, use of GC-MS analysis is recommended.

Table 1 Compounds of interest for environmental monitoring for which the guideline applies.

Compound	MW	Compound	MW
----------	----	----------	----

Naphtalene	128	Fluoranthene	202
C1-Naphtalenes	142	Pyrene	202
C2-Naphtalenes	156	Benzo[a]anthracene	228
C3-Naphtalenes	170	Chrysene	228
Acenaphthylene	152	Benzo[a]pyrene	252
Acenaphthene	154	Perylene	252
Fluorene	166	Indeno[1,2,3-cd]pyrene	276
Phenanthrene	178	Benzo[k]fluoranthene	252
Anthracene	178	Benzo[ghi]perylene	276
C1-Phenanthrene/Anthracene	196	Dibenzo[ah]anthracene	278
C2-Phenanthrene/Anthracene	206		
C3-Phenanthrene/Anthracene	220		

6.1 High performance liquid chromatography

For HPLC analysis of PAH, a binary gradient is necessary to achieve proper compound separation.

Using HPLC and measuring concentrations with the peak height, a 50 % valley should be considered as adequate separation.

Solvents should be degassed through an online degassing system in order to allow proper operation of the high pressure pump. Sample injection should be carried out with an autosampler. In addition, a thermostated column compartment (10–30 °C) should be used as retention time and resolution can be affected by varying the temperature.

6.1.1 Columns

The column specifications are:

- stationary phases: e.g., octadecylsilane (RP-18), or special PAH column material;
- length: 15–25 cm;
- inner diameter: 4.6 mm or less;
- particle size: 5 µm or less.

If the dimensions of the detector cell and the tubings are appropriate, columns with diameters smaller than 4.6 mm can be chosen in order to reduce the flow of the eluent and, thus, to save solvent. In this case the amount of sample injected should also be reduced to e.g. 25–50 µl for a 4.6 mm column or 10 to 20 µl for a 3 mm column.

6.1.2 Gradient Elution

For elution, e.g. methanol/water or acetonitrile/water can be applied. The use of acetonitrile allows higher flow rates, with the disadvantage of having higher health risks than methanol.

A typical elution gradient with a flow rate of 1–1.5 ml min⁻¹ for a 4.6 mm column is:

- start at initially 50 % methanol/water or acetonitrile/water

- run to 100 % methanol or acetonitrile in 40 minutes
- remain for 20 minutes
- back to the initial conditions for about 5 minutes
- equilibrium time of about 5 to 10 minutes (3–5 times the dead volume) prior to the next injection,

100 % methanol or acetonitrile may not be sufficient to elute all non-target compounds from the column. In this respect, a further elution step using acetone/methanol (1/1) or acetonitrile/acetone (1/1) can be applied. A ternary gradient is then necessary.

In order to obtain reproducible retention times, the equilibrium time after each run should be constant. Therefore, automatic injection is strongly recommended.

6.1.3 Detection

For the detection of PAHs, the more sensitive and selective fluorescence detector is preferred over a UV detector. The excitation and emission wavelengths should be programmable to allow the detection of PAHs at their optimum wavelength (Reupert and Brausen, 1994; ISO, 1995).

However, when PAHs elute close to each other, wavelength switching cannot be carried out between these peaks and a wavelength pair appropriate for the respective compounds has to be chosen. The use of two detectors in series, or running the analysis twice with different wavelength programmes, can minimize the need for such compromises.

As the fluorescence signals of some PAHs can decrease by up to a factor of ten in the presence of oxygen, the eluents must be degassed thoroughly. Therefore, instruments with online degassing systems are strongly recommended. In addition, PTFE tubings should not be used as this material is permeable to oxygen and allows oxygen to enter the system again. The use of stainless steel or PEEK (polyetheretherketone) tubing is recommended.

Acenaphthylene is not detectable with fluorescence and, therefore, a UV or diode-array detector should be used for detection.

Another possible detection technique is mass spectrometry, where isotopically labeled compounds are used as internal standards.

6.1.4 Identification

The individual PAHs are identified by comparing the retention time of the substance in a sample with that of the respective compound in a standard solution analyzed under the same conditions. It is recommended to confirm the results by using other suitable wavelength for UV-absorption or excitation and emission wavelengths for fluorescence detection. For HPLC analysis, reproducibility of retention times should be within ± 1 minute.

6.2 Gas chromatography

6.2.1 Columns

Column dimensions for the determination of PAHs should be the following:

- length: minimum 25 m;
- inner diameter (i. d.): maximum 0.25 mm;
- film thickness: between 0.2 μm and 0.4 μm ;
- stationary phases: A wide range of non-polar or slightly polar stationary phases can be used for the separation of PAHs, e.g., a 5 % phenyl-substituted methyl polysiloxane phase.

Better resolution can be obtained by increasing the length and reducing the inner diameter to 0.20 mm or less. However, below a diameter of 0.15 mm, the carrier gas pressure rises to values above 500 kPa, which are often not compatible with regular GC equipment. Also, the risk of leakages increases.

6.2.2 Carrier gas

Preferentially, helium should be used as carrier gas for GC-MS. Upon using columns with very small inner diameters, the use of hydrogen is essential.

The linear gas velocity should be optimized. Appropriate settings for 0.25 mm i.d. columns range from 20 to 40 cm s⁻¹ and for 0.15 mm i.d. columns from 30 to 50 cm s⁻¹.

6.2.3 Injection techniques

Sample injection should be carried out with an autosampler. The two systems commonly used are splitless and on-column injection. Other techniques such as temperature-programmed or pressure-programmed injection may have additional advantages, but should be thoroughly optimized before use. Due to their high boiling points, on-column injection is recommended for separation of the PAH compounds.

6.2.4 Temperature programming

The temperature program must be optimized for sufficient separation of the PAH compounds. For GC-MS analysis peak areas are generally used and a 10 % valley would represent a good separation. Less resolved peaks may also be quantified - e.g. by dropping perpendiculars to the baseline-, but increasing errors may result.

In addition to a reproducible temperature program, a fixed equilibration time is important for a correct analysis and constant retention times.

6.2.5 Detection

The most frequently used detector for GC analysis of the PAH compounds is a mass spectrometric detector operating in the Selected Ion Monitoring (SIM) mode and with electron impact ionization (EI) as the ionization method. The selectivity of a mass spectrometric detector is excellent and the chromatographic noise of a standard is similar to that of a sample. However, major drawbacks are the matrix-dependent response and the convex calibration curves that both often occur and make quantification difficult which, however, can be overcome with tandem mass spectrometry (GC-MS/MS).

Another technique for PAH identification is the full-scan MS using an ion trap operating with the same sensitivity as SIM, but in full scan to give the best detection limits and compound identification for methylated PAHs, compared to quadrupole MS with multiple ion monitoring mode (Law et al, 2011). The use of a flame ionization detector (FID) is also possible, but since the selectivity of the FID is low, it is not recommended. In addition, isotopically labeled internal standards (see 8.5) cannot be used in combination with a FID.

6.2.6 Identification

For GC-MS analysis the presence of the characteristic mass fragments or mass transitions (GC-MS/MS) prove the presence of the particular PAH compound. Retention times should be reproducible within ±0.05 minutes.

7. Quantification

Automatically processed chromatograms should be reviewed if, e.g., the baseline is set correctly. Because the separation of the peaks is often incomplete in HPLC analysis, the use of peak heights is recommended for quantification. In case of GC techniques, the use of peak areas is recommended.

For calibration purposes a multilevel calibration with at least five concentration levels is recommended. The calibration curve should be linear and cover the working range. Usually, the response of FID, UV and fluorescence detectors exhibit linearity over a large range.

Since mass spectrometric detectors often lack sufficient linear response, the use of stable isotopes is a prerequisite. Furthermore, the response of PAHs in standard solutions is often much lower than in sample extracts. A combination of different methods, e.g., use of internal standards and standard addition, might give quantitative results.

Obtained calibrations should be regularly validated in terms of precision and accuracy.

Prior to running a series of samples and standards, the GC or HPLC systems should be equilibrated by injecting at least one sample extract. In addition, standards used for multilevel calibrations should be regularly distributed over the sample series so that matrix- and non-matrix-containing injections alternate. A sample series should include:

- a procedural blank;
- a laboratory reference material;
- at least five standards;
- one standard sample treated similarly to the samples for determination of the recovery.

The method for calculating the limit of determination should reflect the advice in Part B-4.2.3 (COMBINE manual).

The limit of quantification usually depends on the purpose of the investigation. The limit of quantification that can be achieved depends on the blank sample, the sample matrix, concentrations of interfering compounds, and the amount of sample. However, a limit of quantification of 2 ng g⁻¹ (dry weight) or better should be attained for single compound analysis.

8. Quality Assurance

A number of measures should be taken to ensure sufficient quality of the analysis. Six main areas can be identified:

1. extraction efficiency and clean-up;
2. calibrant and calibration;
3. system performance;
4. long-term stability;
5. internal standards; and
6. Frequent participation in interlaboratory proficiency testing schemes (e.g. QUASIMEME two times a year, www.quasimeme.org).

8.1 Extraction efficiency and clean-up

Extraction efficiency and clean-up can be controlled by analysing reference materials (Annex B-7). To determine the recovery rates of the clean-up and concentration steps, it is recommended to pass a standard solution (see 8.5. INTERNAL STANDARDS) through the entire procedure. The addition of corresponding internal standards to the samples is preferred.

If major losses have occurred, the results should not be reported.

8.2 Calibrant and calibration

Basically, calibration solutions should be stored in ampoules at a cool, dark place. Weight loss during storage should be recorded for all standards.

For PAH determination preferentially calibration solutions from certified crystalline PAHs should be used. However, the laboratory should have the appropriate equipment and expertise to handle these hazardous crystalline substances. Alternatively, certified PAH solutions can be used. Preparation of two independent stock solutions allows cross-checks of the standard solutions if necessary.

8.3 System performance

The performance of the HPLC or GC system can be monitored through regularly analyzing the resolution of two closely eluting PAHs or chlorinated biphenyl compounds. A decrease in resolution indicates deteriorating HPLC or GC conditions.

The signal-to-noise ratio of a low concentrated standard can give information on the condition of the detector. For example, a dirty MS-source can be recognized by the presence of a higher background signal, together with a reduced signal-to-noise ratio if not used in the SIM mode.

8.4 Long-term stability

One laboratory reference sample should be included in each series of samples. A quality control chart should be recorded for selected PAH compounds, e.g., fluoranthene (stable results), pyrene (sensitive to quenching), benzo[a]pyrene (sensitive to light). If warning limits are exceeded, the method should be checked for possible errors and the obtained sample results should not be reported.

If available, a certified reference material (CRM) should be analysed regularly and in particular, if the procedure was changed.

8.5 Internal standards

Internal standards should be added to all standards and samples either in a fixed volume or by weight and should not interfere with the target analytes.

A number of deuterated PAH compounds were proven to be suitable for GC-MS as well as for HPLC analysis. For GC-MS analysis it is recommended to have internal standards corresponding to each analyte, e.g. by using isotopically labeled compounds. Otherwise, at least four internal standards representing the different ring-sizes of the PAH compounds should be added.

The following compounds can be used (Wise et al., 1995):

- for HPLC analysis: phenanthrene-d10, fluoranthene-d10, perylene-d12, 6-methyl-chrysene;
- for GC-MS analysis: naphthalene-d8, phenanthrene-d10, chrysene-d12, perylene-d12;
- for GC-FID analysis: 1-butylpropylene, m-tetraphenyl

After clean-up and before GC analysis, an additional internal standard can be added to evaluate the recovery of the internal standards added before clean-up.

8.6 Interlaboratory proficiency testing schemes

Each laboratory analysing sediments should participate in interlaboratory studies on the determination of PAH in sediments on a regular basis (e.g. QUASIMEME offers the possibility to take part twice a year, www.quasimeme.org).

9. References

Dean, J.R., Barnabas, I.J., and Fowles, I.A. 1995. Extraction of polyaromatic hydrocarbons from highly contaminated soils: A comparison between Soxhlet, microwave and supercritical fluid extraction techniques. *Analytical Proceedings*, 32: 305–308.

- Gremm, T., and Frimmel, F.H. 1990. Systematische Untersuchung zur PAK-Bestimmung mittels HPLC (Systematic investigations of PAH-determination with HPLC). (In German). *Vom Wasser*, 75: 171–182.
- ISO. 1995. ISO/DIS 13877 Draft International Standard. Soil quality—determination of polynuclear aromatic hydrocarbons—methods using high-performance liquid chromatography. International Organization for Standardization, Paris.
- Kassim, T.A., Barceló. D. 2009. Contaminated Sediments. *The Handbook of Environmental Chemistry Vol 5/T*.
- Keith, L.H., and Telliard, W.A. 1979. Priority pollutants. 1. A perspective view. *Environmental Science and Technology*, 13: 416–423.
- Krahn, M.M., Moore, L.K., Bogar, R.G., Wigren, C.A., Cham, S., and Brown, D.W. 1988. High performance liquid chromatographic method for isolating organic contaminants from tissue and sediment extracts. *Journal of Chromatography*, 437: 161–175.
- Law, R.J., and Biscaya, J.L. 1994. Polycyclic aromatic hydrocarbons (PAHs)—problems and progress in sampling, analysis and interpretation. *Marine Pollution Bulletin*, 29: 235–241.
- Law, R.J., and de Boer, J. 1995. Quality assurance of analysis of organic compounds in marine matrices: application to analysis of chlorobiphenyls and polycyclic aromatic hydrocarbons. *In* Quality assurance in environmental monitoring, pp. 129–156. Ed. by P. Quevauviller. VCH Weinheim, New York.
- Law, R.J., Klungsøyr, J., Roose P., and de Waal, W. 1994. QUASIMEME Workshop III: Summary of seminar and poster sessions. *Marine Pollution Bulletin*, 29: 217–221.
- Law, R.J., Webster, L., Theobald, N. Rumney, H.S. and de Boer, J. (2011) Organic Micropollutants. *In* Chemical Marine Monitoring: Policy Framework and Analytical Trends, Quevauviller, P. Roose, P. And Verreet, G. John Wiley /Sons, Ltd.
- Reimer, G., and Suarez, A. 1995. Comparison of supercritical fluid extraction and Soxhlet extraction for the analysis of native polycyclic aromatic hydrocarbons in soil. *Journal of Chromatography (A)*, 699: 253–263.
- Reupert, R., and Brausen, G. 1994. Bestimmung von polycyclischen aromatischen Kohlenwasserstoffen in Wasser, Sediment, Schlamm und Boden mittels Hochleistungsflussigkeitschromatographie (Determination of polycyclic aromatic hydrocarbons in water, sediments, sludges, and soils by high performance liquid chromatography). *Acta Hydrochimica et Hydrobiologica*, 22: 202–215.
- Smedes, F., and de Boer, J. 1998. Chlorobiphenyls in marine sediments: Guidelines for determination. *ICES Techniques in Marine Environmental Sciences*, No. 21, 24 pp.
- Topping, G., Wells, D.E., and Griepink, B. 1992. Guidelines on quality assurance for marine monitoring. DG XII, Measurements and Testing Programme, Brussels.
- Wise, S.A., Schantz, M.M., Benner, B.A., Hays, M.J., and Schiller, S.B. 1995. Certification of polycyclic aromatic hydrocarbons in a marine sediment standard reference material. *Analytical Chemistry*, 67: 1171–1178.

Annex XIV:

Background Assessment Criteria recommended to be used to assess concentrations in Mediterranean sediments, mussel (*Mytilus galloprovincialis*) and fish (*Mullus barbatus*) (UNEP(DEPI)/MED WG.444/12, 6th Meeting of the Ecosystem Approach Coordination Group 2017)

Annex XIV: Background Assessment Criteria recommended to be used to assess concentrations in Mediterranean sediments, mussel (*Mytilus galloprovincialis*) and fish (*Mullus barbatus*)
(UNEP(DEPI)/MED WG.444/12, 6th Meeting of the Ecosystem Approach Coordination Group 2017)

Table of the proposed assessment criteria for trace metals (TMs)

Table A.1.1. Mediterranean Sea: Background Concentrations (Med BCs), Med BACs and EACs;
Calculation =>BC = 50th (median); BAC=1.5 x BC (mussel, sediment); BAC=2.0 x BC (fish)

Trace metal	Mussel (MG) $\mu\text{g kg}^{-1}$ d.w.			Fish (MB) $\mu\text{g kg}^{-1}$ f.w.			Sediment $\mu\text{g kg}^{-1}$ d.w.		
	BC	Med BAC	EC*	BC	Med BAC	EC*	BC	Med BAC	ERL**
Cd	730.0	1095.0	5000	(3.7) ^a	(16.0) ^b	50	85.0	127.5	1200
Hg	115.5	173.2	2500	50.6	101.2	1000	53.0	79.5	150
Pb	1542	2313	7500	(31) ^a	(40) ^b	300	16950	25425	46700

^aCd value is below the detection limit (<BDL) and Pb presents a majority of non-detected values in monitoring datasets.

^bestimated BACs from reliable limits of detection (BAC=1.5 x LOD) using analytical data and certified reference material information (DORM-2) (see also text). However, liver tissue matrix should be recommended in fish for Cd and Pb as within OSPAR Convention.

*EC/EU 1881/2006 and 629/2008 Directives for maximum levels for certain contaminants in foodstuffs

** Long et al. 1995 (idem OSPAR adopted values)

Table of the proposed assessment criteria for polycyclic aromatic hydrocarbons (PAHs)

Table A.2.1. Mediterranean Sea Background Concentrations (BCs), Med BACs and EACs;
Calculation =>BC = 50th (median); BAC=2.5 x BC (mussel); no data for sediment available

PAH compound	Mussel (MG) $\mu\text{g kg}^{-1}$ d.w.			Sediment $\mu\text{g kg}^{-1}$ d.w.		
	Med BC	Med BAC	^a OSPAR EAC	^a OSPAR BC	^a OSPAR BAC	^c ERL
F	1.0	2.5	-	-	-	-
P	7.1	17.8	1700	4.0	7.3	240
A	0.5	1.2	290	1.0	1.8	85
FL	3.0	7.4	110	7.5	14.4	600
PY	2.0	5.0	100	6.0	11.3	665
BaA	0.8	1.9	80	3.5	7.1	261
C	1.0	2.4	-	4.0	8.0	384
BkF	0.6	1.4	260	-	-	-
BaP	0.5	1.2	600	4.0	8.2	430
GHI	0.9	2.3	110	3.5	6.9	85
DA	0.5	1.3	-	-	-	-
ID	1.2	2.9	-	4.0	8.3	240

^fNaphthalene, Acenaphthylene, Acenaphthene, Benz(e)pyrene and Benzo(b)fluoranthene are below detection limits (BDLs) or have limited monitoring datasets, and therefore their BACs are preliminary estimations.

^aOSPAR Commission, CEMP: 2008/2009 Assessment of trends and concentrations of selected hazardous substances in sediments and biota (OSPAR PAHs sediment datasets from Spain, not TOC corrected);

^cERL: Effect Range Low

Table of the proposed assessment criteria for organochlorinated compounds (OCs)
(Summary of OSPAR values to be used in the Mediterranean Sea) Table A.3.1. OSPAR Region
(Background Concentrations (BCs), BACs and EACs)¹

OCs compound	Mussel $\mu\text{g kg}^{-1}$ d.w.			Fish $\mu\text{g kg}^{-1}$ w.w.			^d Sediment $\mu\text{g kg}^{-1}$ d.w.		
	BC/LC ^c	BA C	EAC	BC/LC ^c	BA C	EAC (lipid w.)	BC/LC ^c	BAC	EAC/ER L
CB28 ^a	0.25	0.75	3.2	0.05	0.10	64	0.05	0.22	1.7
CB52 ^a	0.25	0.75	5.4	0.05	0.08	108	0.05	0.12	2.7
CB101 ^a	0.25	0.70	6.0	0.05	0.08	120	0.05	0.14	3.0
CB105 ^a	0.25	0.75	-	0.05	0.08	-	0.05	-	-
CB118 ^a	0.25	0.60	1.2	0.05	0.10	24	0.05	0.17	0.6
CB138 ^a	0.25	0.60	15.8	0.05	0.09	316	0.05	0.15	7.9
CB153 ^a	0.25	0.60	80	0.05	0.10	1600	0.05	0.19	40
CB156 ^a	0.25	0.60	-	0.05	0.08	-	0.05	-	-
CB180 ^a	0.25	0.60	24	0.05	0.11	480	0.05	0.10	12
Σ 7CBs ICES ^b	-	-	-	-	-	-	0.20	0.46	11.5*
Lindane ^a	0.25	0.97	1.45	-	-	11**	0.05	0.13 ₊	3.0*
α -HCH ^a	0.25	0.64	-	-	-	-	-	-	-
pp'DDE ^a	0.25	0.63	5-50***	0.05	0.10	-	0.05	0.09 ₊	2.2*
HCb ^a	0.25	0.63	-	0.05	0.09	-	0.05	0.16 ₊	20.0*
Dieldrin ^a	-	-	5-50***	-	-	-	0.05	0.19 ₊	2.0*

¹OSPAR Commission, 2013.

^aOSPAR Commission, CEMP: 2008/2009 Assessment of trends and concentrations of selected hazardous substances in sediments and biota, Monitoring and Assessment Series

^bOSPAR Commission, Background document on CEMP assessment criteria for the QSR 2010, Monitoring and Assessment Series

^cLC: Low concentrations calculated from QUASIMEME; However, BC values should be considered as zero for OCs

^dTotal organic carbon (TOC) corrected values; ⁺LC from Spain (OSPAR, 2013)

*ERLs values instead EACs: Effect Range Low (Long et al. 1995); ERL for ICES Σ 7CB is total CB concentration/2

**EAC for fish liver derived by applying a conversion factor of 10 on EAC for whole fish (CEMP 2008/2009)

***Ecotoxicological assessment criteria (earlier data from the QSR2000 Report-Chapter 4)

Annex XV:

References

Annex XV: References

Cook JM, Robinson JJ, Chenery SR and Miles DL (1997). "Determining cadmium in marine sediments by inductively coupled plasma mass spectrometry: attacking the problems or the problems with the attack?" *Analyst*, 122, 1207-1210

Delft W. van; Vos. G. (1988) Comparison of digestion procedures for the determination of mercury in soils by cold-vapor atomic absorption Spectrometry; *Analytica Chimica Acta*, 209, 147-156.

EC (2010). Guidance Document No: 25 Guidance on chemical monitoring of sediment and biota under the Water Framework Directive

HELCOM (2012a). Manual for marine monitoring in the COMBINE programme. Annex B-13 Appendix 3: Technical note on the determination of heavy metals and persistent organic compounds in marine sediment.

HELCOM (2012b). COMBINE Annex B-12, Appendix 4, Attachment 1. Technical note on the determination of Total Mercury in marine biota by Cold Vapour Atomic Absorption Spectroscopy.

HELCOM (2012c). Manual for marine monitoring in the COMBINE programme. Annex B-13 Technical note on the determination of heavy metals and persistent organic compounds in marine sediments. Appendix 2. Technical note on the determination of chlorinated biphenyls in marine sediment

HELCOM (2012d). Manual for marine monitoring in the COMBINE programme. Annex B-13, Appendix 1. Technical note on the determination of Polycyclic Aromatic Hydrocarbons (PAHs) in sediment

IAEA (2011a). Recommended method on microwave digestion of marine samples for the determination of trace element content (IAEA/Marine Environmental Studies Laboratory in co-operation with UNEP/MAP MED POL)

IAEA (2011c). Recommended method for the determination of selected trace element in samples of marine origin by atomic absorption spectrometry using graphite furnace

IAEA (2012a) Recommended method on the determination of Total Hg in marine samples by Thermal Decomposition Amalgamation and Atomic Absorption Spectrometry

IAEA (2012b). Recommended method on the determination of Total Hg in samples of marine origin by Cold Vapour Atomic Absorption Spectrometry

Kestern, M. and Smedes, F. (2002). Normalization procedures for sediment contaminants in spatial and temporal trend monitoring. *J. Environ. Monit.* 4, 109-115.

Loring, DH (1991). Normalization of heavy metal data from estuarine and coastal sediments. *ICES J. Mar. Sci.* 48, 101-115

Loring, DH and Rantala RTT (1991). Manual for the geochemical analyses of marine sediments and suspended particulate matter. *Earth-Science Review*, 32: 235:283. Elsevier Science Publishers B.V

Nelson, D.W and Sommers, L.E. (1996). *Methods of Soil Analysis. Part 3. Chemical Methods.* Soil Science Society of America Book Series no.5, pp. 961-1010.

OSPAR (2018a). CEMP Guidelines for Monitoring Contaminants in Sediments. Technical Annex 6: Determination of metals in sediments – analytical methods

OSPAR (2018b). CEMP Guidelines for Monitoring Contaminants in Sediments. Technical Annex 5: Normalisation of contaminant concentrations in sediments.

OSPAR (2018c) CEMP Guidelines for Monitoring Contaminants in Sediments. Technical Annex 2: technical annex on the analysis of PCBs in sediments.

OSPAR (2018d). CEMP Guidelines for monitoring contaminants in sediments. Technical Annex 3: Determination of parent and alkylated PAHs in sediments

Schumacher, B.A (2002). Methods for the determination of Total Organic Carbon (TOC) in soils and sediments. EPA/600/R-02/069

UNEP/IAEA (2011). Sample work-up for the analysis of selected chlorinated hydrocarbons in the marine environment. Reference Methods for Marine Pollution Studies No 71.

UNEP/MAP (2019a). UNEP/MED WG.467/5. IMAP Guidance Factsheets: Update for Common Indicators 13, 14, 17, 18, 20 and 21: New proposal for candidate indicators 26 and 27;

UNEP (2019b). UNEP/MED WG.463/6. Monitoring Protocols for IMAP Common Indicators related to pollution;

US EPA (1996). Method 3052: Microwave assisted acid digestion of siliceous and organically based matrices.

US EPA (2007a). U.S. Environmental Protection Agency, EPA method 7473, Mercury in solids and solutions by thermal decomposition, amalgamation and atomic absorption spectrophotometry Rev 0. <http://www.epa.gov/osw/hazard/testmethods/sw846/pdfs/7473.pdf>

US EPA (2007b). U.S. Environmental Protection Agency, EPA method 7473, Mercury in solids and solutions by thermal decomposition, amalgamation and atomic absorption spectrophotometry Rev 0. <http://www.epa.gov/osw/hazard/testmethods/sw846/pdfs/7473.pdf>

US EPA (2014 revision) Method 6020B, ICP-MS. Environmental protection Agency, Washington, DC.

Walkley, A. and Black, I. A. (1934). An examination of the Degtjareff method for determining soil organic matter and a proposed modification of the chromic acid titration method. Soil Science, 37: 29-38

Appendix 18

Monitoring Guidelines/Protocols for Sampling and Sample Preservation of Marine Biota for IMAP Common Indicator 17: Heavy and Trace Elements and Organic Contaminants

1. Introduction

1. Heavy metals and organic contaminants are entering the Mediterranean marine environment discharged from land-based and sea-based pollution sources, as well as from atmospheric deposition. The UNEP/MAP Integrated Monitoring and Assessment Programme (IMAP) (UNEP/MAP, 2019a²⁵⁰; UNEP (2019b²⁵¹)) includes the analysis of specific sedentary marine sentinel organisms (bivalves and benthic feeding fish) in order to assess pollution impact on the marine organisms. The suggested species for monitoring contaminants are a benthic feeding fish (e.g. *Mullus barbatus*) and bivalves (e.g. *Mytilus galloprovincialis*, *Donax trunculus*). However, in case different species of fish and bivalves are used by the Contracting Parties to the Barcelona Convention for assessing marine pollution, explanation has to be provided to UNEP/MAP Secretariat on the reason behind the selection of a different sentinel species for CII7 monitoring.

2. Standardize protocols for sampling and processing of marine biota samples is important in view of assuring comparable quality assurance of the data, as well as comparability between sampling areas and different national monitoring programmes. Also, sampling protocols provide guidance on the suitability of selected sampling sites, the number of required samples, the biometric indices to be recorded, the appropriate handling to avoid cross-contamination, and the storage conditions in view of maintaining the sample's integrity during the transfer from the sampling site to the analytical laboratory. Furthermore, protocols are providing guidance on the procedures to dissect the organisms (fish and bivalves) in order to collect the appropriate tissue for analysis (muscle and liver of fish and whole body of bivalves), taking care to avoid cross-contamination by metals or organic contaminants, depending on the foreseen analysis.

3. The Protocols on of this Guidelines, as provided here-below aim at streamlining sampling and processing of marine biota samples in view of assuring comparable quality assurance of the data, as well as comparability between sampling areas and different national monitoring programmes. They also provide the guidance on the suitability of selected sampling sites, the number of required samples, the biometric indices to be recorded, the appropriate handling to avoid cross-contamination, and the storage conditions in view of maintaining the sample's integrity during the transfer from the sampling site to the analytical laboratory to ensure the representativeness and the integrity of the samples. Furthermore, they guide on the procedures to dissect the organisms (fish and bivalves) in order to collect the appropriate tissue for analysis (muscle and liver of fish and whole body of bivalves), taking care on a need to avoid cross-contamination by metals or organic contaminants, depending on the foreseen analysis. They are not intended to be analytical training manuals, but guidelines for Mediterranean laboratories, which should be tested and modified in order to validate their final results.

4. In order to avoid unnecessary repetitions, reference is also made to the protocols already published and publicly accessible, which can also be used by the Contracting Parties' competent laboratories participating in IMAP implementation. Namely, the six here-below elaborated IMAP Protocols build on previous UNEP/MAP - IAEA Recommended Methods, such as Reference Methods No 6 on sampling of selected marine organisms and sample preparation for trace metal analysis (UNEP/FAO/IOC/IAEA, 1987, Annex I) and Reference Methods No 7 (Rev. 2) on sampling and dissecting marine organisms (UNEP/FAO/IOC/IAEA, 1988, Annex II), which were prepared in the framework of the MED POL monitoring programme. IMAP Protocols are also streamlined with similar Guidelines/Protocols for marine biota sampling, sample processing and preservation, which were developed by other Regional Seas Organisations, such as HELCOM (2012²⁵²) (Annex III) and ICES/OSPAR (2018²⁵³) (Annex IV) as well as the European Commission's guidance documents (EC

²⁵⁰ UNEP/MAP (2019a). UNEP/MED WG.467/5. IMAP Guidance Factsheets: Update for Common Indicators 13, 14, 17, 18, 20 and 21: New proposal for candidate indicators 26 and 27

²⁵¹ UNEP (2019b). UNEP/MED WG.463/6. Monitoring Protocols for IMAP Common Indicators related to pollution

²⁵² HELCOM (2012). Annex B-12, Appendix 1. Technical note on biological material sampling and sample handling for the analysis of persistent organic pollutants (PAHs, PCBs and OCPs) and metallic trace elements

²⁵³ ICES/OSPAR (2018). CEMP Guidelines for Monitoring Contaminants in Biota

2010²⁵⁴ and 2014²⁵⁵). Given the suitability of any of these Guidelines in the context of IMAP, they could be further used by interested IMAP competent Mediterranean laboratories for developing their laboratory specific sampling and sample processing methodologies.

5. The below flow diagram informs on the category of this Monitoring Guideline related to sample preparation and analysis of marine biota for IMAP Common Indicator 17 within the structure of all Monitoring Guidelines prepared for IMAP Common Indicators 13, 14, 17, 18 and 20.

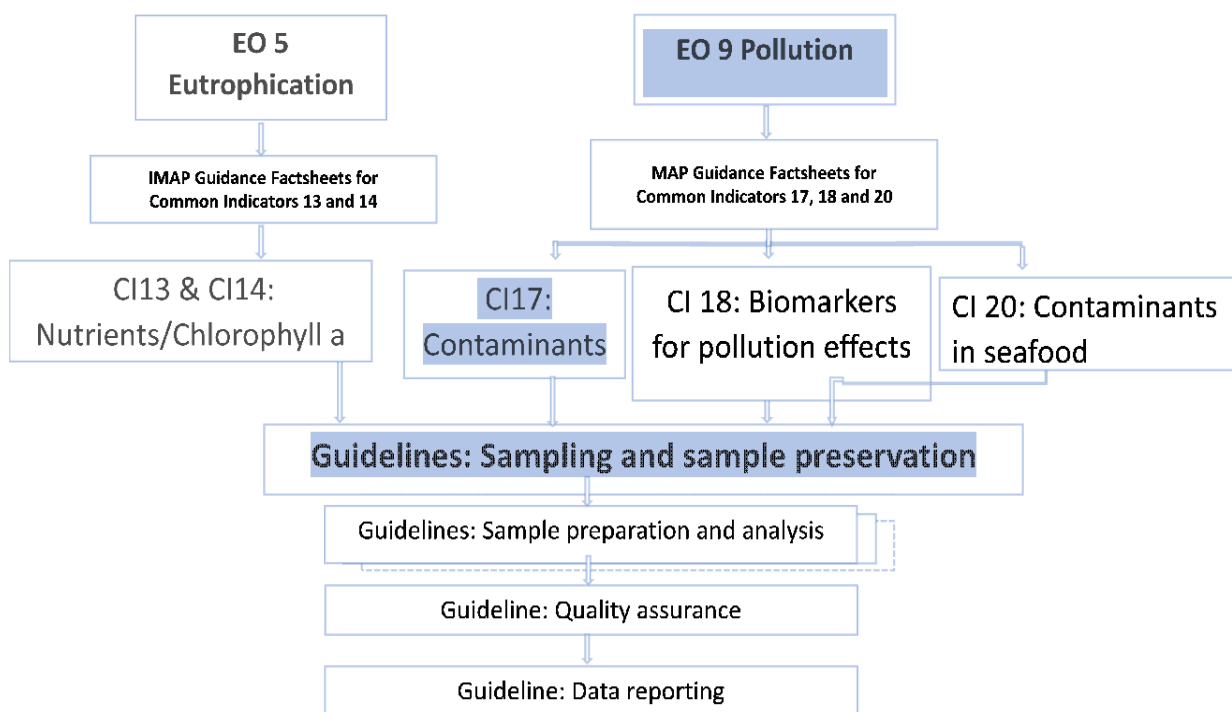

Flow Diagram: Monitoring Guidelines for IMAP Ecological Objectives 5 and 9

2. Technical note for the sampling of marine biota for the analysis of heavy metals and organic contaminants

6. Sampling is a very important step in the analysis of marine biota, since it affects the representatives of the sample, which is the basis of every Quality Assurance scheme. The fish and bivalves collected should reflect the condition of other organisms of the same species in the marine area under consideration. The sampling location and conditions (including seafloor nature, sampling depth, location of pollution sources) have to be chosen carefully, taking into consideration other oceanographic data (such as temperature, turbidity, trophic level) in the sampling area. The handling of biota after collection is also of primary importance, in order to follow appropriate procedures to avoid cross contamination of the samples from the ship's environment and the storage of samples. Also, the appropriate preservation of samples during transportation from the sampling site to the laboratory for further analysis is crucial, in order to avoid the deterioration of the biota tissues that may result in loss of determinant or contamination from the packaging materials. Finally, once the biota samples arrive at the laboratory, additional processing is required to dry and homogenize the samples and to store the

²⁵⁴ EC (2010). Guidance Document No: 25 Guidance on chemical monitoring of sediment and biota under the Water Framework Directive

²⁵⁵ EC (2014). Guidance Document No: 32 Guidance on biota monitoring under the Water Framework Directive

dried samples in appropriate conditions in order to avoid any alteration of the contaminants' concentrations in the samples.

7. Under this Technical Note, this Guidelines for Sampling and Sample Preservation of Marine Biota for IMAP Common Indicator 17 provides the following Protocols:

- Protocol for the collection of fish for heavy metal and organic contaminants analysis;
- Protocol for the collection of bivalves for heavy metal and organic contaminants analysis;
- Protocol for the dissection of fish to collect muscle and liver;
- Protocol for the dissection of bivalves.

2.1 Protocol for the collection of fish for heavy metal and organic contaminants analysis

8. The most common fish species used for marine pollution monitoring in the Mediterranean region is the mullet (*Mullus barbatus*) (UNEP, 2019b). However, in different areas, according to local conditions, other benthic fish may be used for monitoring contaminants. A list of available reference species (Code list) for Data Dictionaries and Data Standards of the IMAP (Pilot) Info System for E09 (CI17 and CI20) is presented in the document UNEP/MED WG.467/8 (UNEP, 2019c²⁵⁶).

9. For fish sampling, in line with the IMAP Monitoring Protocols for CI17 (UNEP, 2019b), 3-5 parallel composite samples (5-6 specimen for each fish sample) are collected from the same size class at each site. During the initial phase of the IMAP (identification of key sampling sites/stations) fish sampling should be done every 4 years and bivalves sampling yearly, while during the advanced phase (when it is a fully completed MED POL Phase IV implementation with the ongoing reporting of data sets) biota sampling should be done every 1 to 3 years, according the trends and levels assessed at the different stations/sites (UNEP, 2019a). EU requests Member States to determine the frequency of monitoring in sediment and/or biota so as to provide sufficient data for a reliable long-term trend analysis (2008/105/EC²⁵⁷). As a guideline, the Directive suggests a monitoring frequency of three years for sediment and biota, unless technical knowledge and expert judgment justify another interval.

10. Fish having a length of 12-16 cm should be included if possible in the selected size classes, to be in line with the Protocol for fish collection for the CI18. Fish can be collected by gill net fishing or trawling using a square-meshed net of 40 mm or, if justified, by a diamond meshed net of 50 mm as required by the EU legislation (EC 1967/2006²⁵⁸). Guidelines for collection of fish are presented in UNEP/FAO/IOC/IAEA (1987) (Annex I) and UNEP/FAO/IOC/IAEA (1988) (Annex II). Fish could be sampled from a research vessel or from a small fishing boat. Guidelines on sampling and processing of fish samples are also provided by HELCOM (2012) (Annex III.) and OSPAR (2018).

11. It has to be underlined that concentrations of chemical pollutants in marine biota tissues can be influenced by many environmental factors (such as seasonal fluctuations of temperature, organic matter, nutrients) and biological factors (such as the phase of reproductive cycle, weight fluctuations, changes in relative tissue composition, the massive development of gonadic tissues during gametogenesis and the loss of weight during spawning). In order to avoid such variations, it is recommended that sampling take place in the off-spawning period (EC. 2010). Also, in order to evaluate the influence of common biological and environmental factors it is suggested to record the date, seawater temperature, salinity, phytoplankton development, at sampling time.

12. Fish samples should be protected from contamination, which may occur during sampling, sample handling, storage and transfer to the laboratory for further analysis. In case fish are dissected on board, the work must be carried out by personnel capable of identifying and removing the desired

²⁵⁶ UNEP (2019c) UNEP/MED WG.467/8. Data Standards and Data Dictionaries for Common Indicators related to pollution and marine litter.

²⁵⁷ EC Directive 2008/105/EC (2008) on environmental quality standards in the field of water policy, amending and subsequently repealing Council Directives 82/176/EEC, 83/513/EEC, 84/156/EEC, 84/491/EEC, 86/280/EEC and amending Directive 2000/60/EC of the European Parliament and of the Council

²⁵⁸ EC Council Regulation No 1967/2006 concerning management measures for the sustainable exploitation of fisheries resources in the Mediterranean Sea

organs according to the requirements of the investigation. Fish samples have to be handled with care to avoid any contact with metals (for heavy metal analysis) or possible sources of organic contaminants (for chlorinated hydrocarbons and PAHs analysis). Detailed procedures for fish dissection and the measures to be taken in order to avoid sample contamination during handling, are presented in Protocol for the fish dissection to collect muscle and liver. Upon fish collection additional information on length, wet weight and sex should be recorded. In case of pooling, number of specimens and length range should also be recorded.

13. In case fish samples have to be transported to the laboratory for dissection, they have to be handled and stored in such a way, as to avoid sample deterioration or contamination. A ship has several potential metal contamination sources (metallic hull and superstructures, paint). To prevent metal contamination fish samples intended for heavy metal analysis should be handled in metal-free areas (working surfaces with plastic coatings or cover) and stored in plastic bags for transport to the laboratory. Regarding PAHs and chlorinated hydrocarbons, possible contamination sources in a ship include fuel and lubrication, as well as exhaust from the ship's engines. Fish samples intended for organic contaminants analysis have to be stored in metal containers for their transport to a stainless steel or aluminium clean working surface in the ship's laboratory. Before starting the handling of fish samples, it is important to identify possible contamination sources in the ship and the samples handling area, in order to take appropriate measures to avoid contamination.

14. In case fish transport to the laboratory is done in less than 24 hours, samples can be stored on ice. However, for longer periods, fish samples have to be frozen (-20 °C) and transported frozen to the laboratory for further processing. Each sample should be labelled with the sample's identification number, the type of tissue, and the date and location of sampling.

2.2 Protocol for the collection of bivalves for heavy metal and organic contaminants analysis

15. *Mytilus galloprovincialis* and *Donnax trunculus* are the bivalve species suggested to be analysed for heavy metals and organic contaminants in the framework of CI17 (UNEP/MAP, 2019; UNEP/MAP 2019a). If the Contracting Party decides to analyse other bivalve species, it has to provide UNEP/MAP the rationale behind its decision. To facilitate reporting a list of available reference species (Code list) is provided in the document UNEP/MED WG.467/8 (UNEP, 2019c).

16. In line with the IMAP Monitoring Protocols for CI17 (UNEP, 2019b), 3-5 parallel composite samples of bivalves (10 specimens for each bivalves sample) are collected yearly from the same size class at each trend monitoring. Minimum bivalves sampling is once per year, although twice per year may be applied if possible to be in line with CI18 sampling frequency. The most adequate sampling period is during the post winter months, but before the spawning period. Usually, in most Mediterranean coastal areas, April-June is an appropriate sampling period, but local climatic characteristics have to be taken into consideration for the fixing of the sampling period.

17. The bivalves' size to be collected should be 4-5 cm, to be in line with the sampling protocol for CI18. However, a length-stratified sampling could be applied, which is generating data that can also be used in monitoring programmes for temporal trends of contaminants in biota (HELCOM, 2012). The HELCOM methodology requires that at least 20 mussels in the largest length interval can easily be found and the length stratification should be determined in such a way that it can be maintained over many years for the purposes of temporal trend monitoring. It is also requiring that the length interval shall be at least 5 mm in size. The length range should be split into at least three length intervals (small, medium, and large) which are of equal size after log transformation and the number of specimens selected for analysis depends on their length, e.g. 80-100 individuals are necessary to suffice material within the length range 4-5 cm (HELCOM, 2012).

18. Bivalves sampling sites should host an abundant population of the targeted species in order to take appropriate size of sample and to be reasonably accessible in order to easily and rapidly transport biota samples to the laboratory. Bivalves growing on metal structures (i.e. underwater pipes) or substrates, which may be enriched in metals or organic contaminants, should be exempted from collection. Divers will collect manually the mussels living at a 4-5 m under the water surface. Mussel

byssus threads should be cut from the substrate, since pulling the animals from the rocks (threading) can result in damage to internal tissues. Using mussels living at the water/air interface, the physical contamination by lipophilic contaminants present on the water surface may alter the evaluation of the chemical's content in mussel soft tissues.

19. Detailed guidelines for bivalves' collection for analysis and samples processing are presented in the recommended methods developed by UNEP/FAO/IOC/IAEA (1987) (Annex I) and UNEP/FAO/IOC/IAEA (1988) (Annex II). Also, similar guidelines are published by HELCOM (2012) (Annex III) and OSPAR (2018) (Annex IV).

20. In places where no wild bivalves populations are found, caged bivalves can be used as an alternative option for monitoring (UNEP, 2019b). Adult mussels (4-5 cm) are collected from a mussel farm, transported to the marine area under investigation and re-immersed for 10 days to permit them to re-cluster and reduce mortality risk during transplantation at the sampling site. Then cages with mussels are transported to the sampling site, where cages are suspended at 6m to 8m from the sea surface, anchored at the bottom with a 30 kg ballast, and exposed for 12 weeks. During recovery of cages, the biometric parameters shell height and wet weight (w.w.) of soft tissues are measured at least in 15 mussels per each cage. Details on the protocol for using caged bivalves in monitoring heavy metals and organic contaminants in the marine environment are presented in Galgani et al. (2011)²⁵⁹ and Galgani et al (2014)²⁶⁰.

21. The undamaged bivalves are transported to the laboratory moist and alive in appropriate closed containers to avoid contamination (i.e. plastic containers for organisms to be analysed for heavy metals and metals containers for organisms to be analysed for chlorinated hydrocarbons and PAHs), at temperatures between 5 °C and 15 °C (24 hours is the maximum transport time in these conditions). Bivalves should be kept moist using clean seawater from the sampling site without submerging them. For a transportation time of more than 24 hours, bivalves should be placed in appropriate container and frozen. Frozen, samples can be stored in a deep freezer at temperatures of -20°C. Each sample should be labelled with the sample's identification number, the type of tissue, and the date and location of sampling.

2.3 Protocol for the dissection of fish to collect muscle

i) Dissection

22. Muscle tissues of fish has to be dissected while the organism is in good condition, otherwise the decay of the tissues will affect the concentration of contaminants. Therefore, it is preferable to dissect collected fish on board, by experienced personnel able to perform the dissection and remove the fish tissues to be analysed (muscle and liver). The on-board dissection should be done in a clean area free from possible contamination of the sample by metals or organic contaminants respectively. If no on-board dissection capability is available (because of lack of experienced personnel and/or lack of adequate clean dissection area), collected fish should be transferred to the laboratory taking care to prevent tissue decay. If the laboratory is reachable within 24 hours, fish could be preserved on ice during the transfer. For longer periods, fish should be frozen immediately and transferred frozen to the laboratory, where they will be thawed before dissection.

²⁵⁹ Galgani, F., Martínez-Gómez, C., Giovanardi, F., Romanelli, G., Caixach, J., Cento, A., Scarpato, A., BenBrahim, S., Messaoudi, S., Deudero, S., Boulahdid, M., Benedicto, J., Andral, B. (2011). Assessment of polycyclic aromatic hydrocarbon concentrations in mussels (*Mytilus galloprovincialis*) from the western basin of the Mediterranean Sea. *Environ. Monit. Assess.* 172 (1–4), 301–317. <https://doi.org/10.1007/s10661-010-1335-5>.

²⁶⁰ Galgani, F., Chiffolleau, J.F., Barrah, M., Drebiga, U., Tomasino, C., Andral, B. (2014). Assessment of heavy metal and organic contaminants levels along the Libyan coast using transplanted mussels (*Mytilus galloprovincialis*). *Environ. Sci. Pollut. Res.* 21, 11331–11339. <https://doi.org/10.1007/s11356-014-3079-1>.

23. Detailed guidelines for the dissection of fish and collection of samples for further analysis is presented in the UNEP/FAO/IOC/IAEA Reference Method No 6 (1987) (Annex I.) and UNEP/FAO/IOC/IAEA Reference Method No 7 (1988) (Annex II).

24. HELCOM (2012) and OSPAR (2018) propose a similar procedure for fish dissection and removal of muscle for further analysis. The method requires the removal of the epidermis and the collection of a sample from the right side dorso-lateral muscle in order to ensure uniformity of samples (Figure 1). It is also suggested to take the entire right dorsal lateral filet as a uniform sample, from which subsamples can be taken after homogenizing for replicate dry weight and contaminant determinations. If the amount of material obtained by this procedure is too large to be easily handled, a specific portion of the dorsal musculature should be chosen for the sample. It is recommended that the portion of the muscle lying directly under the first dorsal fin should be utilized in this case. It is important to obtain the same portion of the muscle tissue for each sample, because both fat and water content vary significantly in the muscle tissue from the anterior to the caudal muscle of the fish.

25. In case fish samples are frozen for their transfer from the field to the laboratory, they have to rest until thawed. It is often suggested that the dissection of fish is easiest when the material, at least the surface layers of the muscle tissue, is half frozen. Extreme care has to be demonstrated during dissection because any loss of liquid or fat due to improper cutting or handling of the tissue makes the determinations of dry weight and fat content less accurate, which is also affecting the accuracy of the reported contaminants' concentrations.

26. In all cases fish dissections should be undertaken by trained personnel.

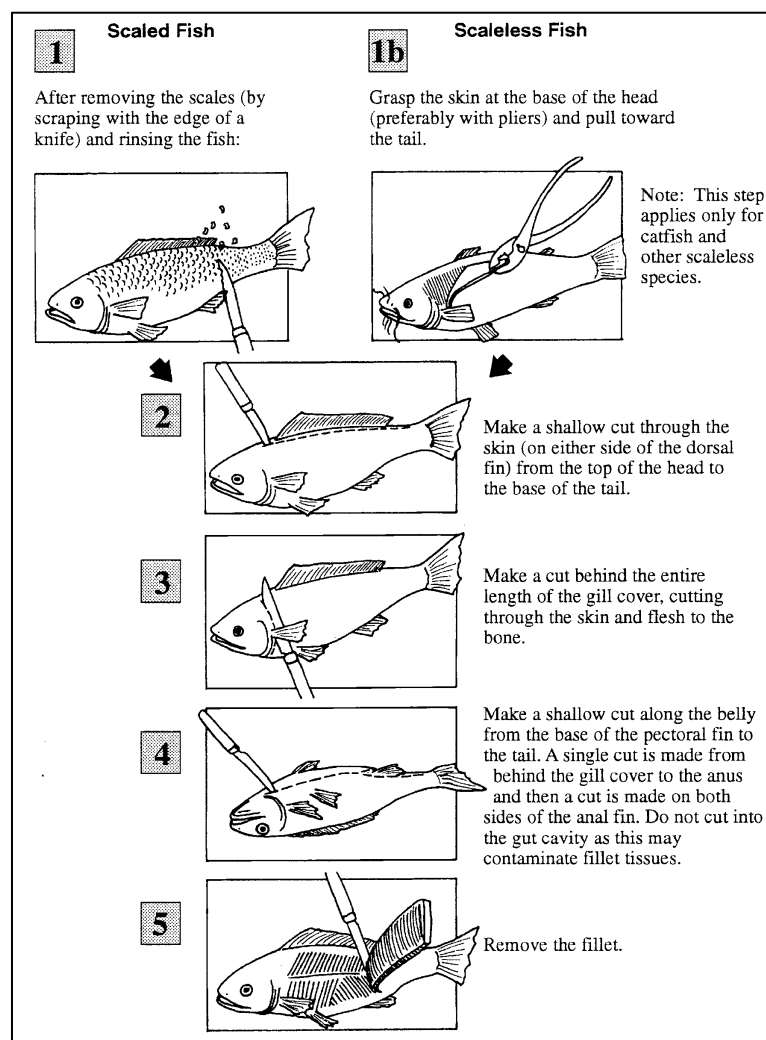

Figure 1. Fish filleting procedure (from US EPA, 2000²⁶¹)

27. In case liver tissue is sampled for analysis (not a mandatory tissue in the framework of IMAP), HELCOM guidelines underline that “the liver must be identified in the presence of other organs such as the digestive system or gonads. After opening the body cavity with a scalpel, the connective tissue around the liver should be cut away and as much as possible of the liver is cut out in a single piece together with the gall bladder. The bile duct is then carefully clamped and the gall bladder dissected away from the liver.”

b) Avoiding contamination

28. For metal analysis, handling of fish should be made on a metal-free bench, using plastic knives and tweezers for holding tissues during dissection. After each sample has been prepared, all tools and equipment (such as homogenizers) should be cleaned.

29. For organic contaminants analysis, handling of fish should be made on a metallic (stainless steel or aluminium) bench, using stainless steel knives and tweezers for holding tissues during dissection. After each sample has been prepared, all tools and equipment (such as homogenizers) should be cleaned.

²⁶¹US EPA (2000). Guidance for Assessing Chemical Contaminant Data for Use in Fish Advisories Volume 1 Fish Sampling and Analysis. Third Edition.

30. After the removal of a tissue sample from a fish, the tools have to be cleaned before being used to remove another organ (i.e. liver) of the same individual or being used on a different individual.

31. HELCOM (2012) recommends the following procedures for cleaning tools used for preparing samples:

For analysis of heavy metals, tools should be:

- i) Washed in acetone or alcohol and high purity water.
- ii) Washed in HNO₃ diluted (1+1) with high purity water. Tweezers and haemostates should be washed in diluted (1+6) acid.
- iii) Rinsed with high purity water.

For analysis of organochlorine pesticides

- i) Washed in acetone or alcohol and rinse in high purity water.

32. The glass plate used during dissection should be cleaned in the same manner. The tools must be stored in a dust-free area when not in use. Also, the dissection room should be kept clean and the air should be free from particles. If clean benches are not available on board the ship, the dissection of fish should be carried out in the land-based laboratory under conditions of maximum protection against contamination.

2.4 Protocol for the dissection of bivalves

a) Depuration

33. Collected bivalves should be left to void the gut contents and any associated contaminants before freezing or sample preparation, because gut contents may contain significant quantities of contaminants associated with food and sediment particles which are not truly assimilated into the tissues of the mussels (HELCOM, 2012). Bivalve's depuration over a period of 24 hours is usually sufficient and should be undertaken under controlled conditions and in filtered sea water in the laboratory. The aquarium should be aerated, and the temperature and salinity of the water should be similar to that from which the animals were removed.

b) Bivalve dissection

34. According to the UNEP (2019b) UNEP/MED WG.463/6. Monitoring Protocols for IMAP Common Indicators related to pollution, the whole soft tissue of bivalves has to be collected for analysis. Detailed guidelines for the dissection of fish and collection of samples for further analysis is presented in the UNEP/FAO/IOC/IAEA Reference Method No 6 (1987) (Annex I) and UNEP/FAO/IOC/IAEA Reference Method No 7 (1988) (Annex II). Guidelines for sampling and processing of bivalves is also prepared by HELCOM (2012) (Annex III) and OSPAR (2018) (Annex IV).

35. In general, foreign materials attached to the outer surface of the shell have to be removed using a clean plastic/stainless steel knife and a strong plastic/metal brush. Handle the mussels as little as possible. Rinse each mussel with clean seawater and let the water drain off. Then pull out the byssus which extrudes from between the closed shells on the concave side of the shells; weigh the whole mussel and note the weight.

36. For removing the soft tissue for analysis, bivalves should be shucked live and opened with minimal tissue damage. Insert a clean plastic/stainless steel knife into the opening from which the byssus extrudes and cut the adductor muscles. Avoid forcing the mussel to open, if the abductor muscle is cut, the bivalve will open easily (Figure 2). Rinse the soft part of the mussel in its shells with clean seawater. The soft tissues should be removed and homogenized as soon as possible, frozen and kept in plastic containers (for metal analysis) or in metal containers at -20°C until analysis. Homogenization can be done using stainless steel blades (for organic contaminants analysis) or using an agate mortar, following the drying of the sample.

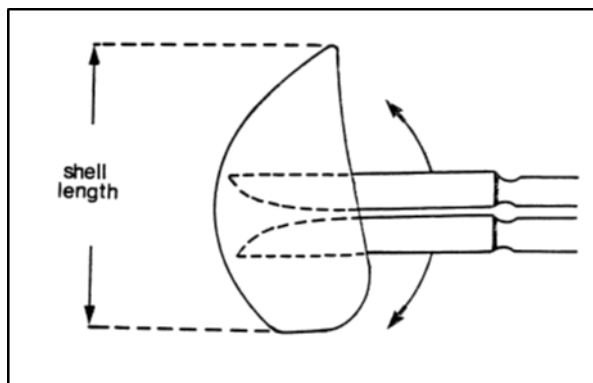

Figure 2. Cutting the abductor muscle

37. For metal analysis, the handling of bivalves should be made on a metal-free bench, using plastic knives and tweezers for holding tissues during dissection. After each sample has been prepared, all tools and equipment (such as homogenizers) should be cleaned with a tissue and rinsed with clean water.

38. For organic contaminants analysis, the handling of bivalves should be made on a metallic (stainless steel or aluminium) bench, using stainless steel knives and tweezers for holding tissues during dissection. After each sample has been prepared, all tools and equipment (such as homogenizers) should be cleaned with tissue and rinsed with solvent

39. In all cases bivalve dissection should be undertaken by trained personnel.

3. Technical note for the sample preservation of marine biota for the analysis of heavy metals and organic contaminants

40. Once the biota samples arrive at the laboratory, additional processing is required to dry and homogenize the samples and to store the dried samples in appropriate conditions. During the processing of the samples it is important to avoid any cross contamination (metal or organic contaminants) from the equipment and the containers used to store the dried samples. Analysis may be performed at a later stage, it is therefore important to avoid any alteration of the contaminants' concentrations in the samples during storage.

41. Under the Technical Note, this Guidelines for Sampling and Sample Preservation of Marine Biota for IMAP Common Indicator 17 provides the following Protocols:

- Protocol for the treatment of biota samples prior to analysis of heavy metals;
- Protocol for the treatment of biota samples prior to analysis of organic contaminants.

3.1 Protocol for the treatment of biota samples prior to analysis of heavy metals

a) Storage of wet samples on board

42. Upon collection wet samples have to be stored on board in such a way as to preserve them from deterioration that will affect the subsequent analysis of contaminants. When the fish transport to the laboratory is done in less than 24 hours, samples can be stored on ice. However, for longer periods, fish samples have to be frozen (-20 °C) and transported frozen to the laboratory for further processing. Each sample should be labelled with the sample's identification number, the type of tissue (if already dissected), and the date and location of sampling.

b) Drying of biota tissues

43. Drying biota tissues is a procedure to establish the dry/wet weight (dw/ww) ratio of the tissues, in order to express metal concentrations accordingly enabling comparisons between different data sets. Dried biota tissues can then be digested for heavy metal analysis. For metal (except volatile mercury)

analysis, biota freeze-drying is the preferable procedure. Alternatively, the biota tissues may be dried at any temperature below 105°C until constant weight. For mercury analysis, to minimise losses due to evaporation, a biota tissue sub sample could be air dried at temperature <50°C (EC, 2010).

44. Frozen biota samples are placed in clean wide-mouth glass or plastic containers suitable for freeze-drying and are freeze-dried for 24 hours taking care to protect them from cross-contamination from particles and vapours. A possible way to protect samples from contamination is to cover the sample containers with a filter paper perforated with a small hole (HELCOM, 2012). Then the containers with the samples are weighted and freeze-dried again for another 24 hours and weighted. If the difference between the 2 weighing is less than 0.5%, drying is completed and the dw/ww ratio can be calculated. Otherwise the drying cycle can be repeated (24 hours) until the difference between successive weighing is less than 0.5%.

45. Freeze dried biota tissues are then grinded and homogenized using a metal-free ball mill.

46. Guidelines for processing biota samples for metal analysis are provided by OSPAR (2018) and HELCOM (2012).

c) Storage of dried biota tissues

47. Freeze-dried tissue samples can be stored in pre-cleaned wide-mouth bottles with a screw cap. Samples intended for the analysis of metals can be stored in plastic or glass containers. For mercury analysis, samples must be stored in acid-washed borosilicate glass or quartz containers, as mercury can move through the walls of plastic containers (EC, 2010).

48. Containers with biota tissue samples should be archived and kept in storage after the completion of the analysis, in order to be used as a replicate sample in case crosschecking of the results are required or additional determinations are needed in the future. Freeze-dried biota tissues remaining after analyses could be stored in the original sample bottle, closed with an airtight lid to protect against moisture and stored in a cool, dark place. Under these conditions, samples may be archived and stored for 10-15 years. (EC, 2010).

3.2 Protocol for the treatment of biota samples prior to analysis of organic contaminants

a) Storage of wet samples on board

49. Upon collection wet samples have to be stored on board in such a way as to preserve them from deterioration that will affect the subsequent analysis of contaminants. When the fish transport to the laboratory is done in less than 24 hours, samples can be stored on ice. However, for longer periods, fish samples have to be frozen (-20 °C) and transported frozen to the laboratory for further processing. Each sample should be labelled with the sample's identification number, the type of tissue, and the date and location of sampling.

b) Drying of biota tissues

50. For organic contaminants analysis drying procedures depends on the compounds to be analysed. For chlorinated hydrocarbons biota can be freeze-dried taking care to avoid determinant loss through evaporation by keeping the temperature in the evaporation chamber below 0°C. (OSPAR, 2018). For PAH determination, freeze-drying of biota tissues may be a source of contamination due to the back-streaming of oil vapours from the rotary vacuum pumps. Furthermore, drying may result in losses of the lower molecular weight, more volatile PAHs through evaporation. A possible way to protect samples from contamination is to cover the sample containers with a filter paper perforated with a small hole (HELCOM, 2012). Frozen biota samples are placed in clean wide-mouth glass containers suitable for freeze-drying and are freeze-dried for 24 hours taking care to protect them from cross-contamination from particles and vapors. Then the containers with the samples are weighted and freeze-dried again for another 24 hours and weighted. If the difference between the 2 weighing is less than 0.5%, drying is completed and the dw/ww ratio can be calculated. Otherwise the drying cycle can be repeated (24 hours) until the difference between successive weighing is less than 0.5%.

51. Freeze dried biota tissues are then grinded and homogenized using a plastic-free ball mill.

c) Storage of dried biota tissues

52. Freeze-dried tissue samples can be stored in pre-cleaned wide-mouth bottles with a screw cap. Samples intended for the analysis of organic contaminants should be stored in glass containers.

53. Containers with biota tissue samples should be archived and kept in storage after the completion of the analysis, in order to be used as a replicate sample in case crosschecking of the results are required or additional determinations are needed in the future. Freeze-dried biota tissues remaining after analyses could be stored in the original sample bottle, closed with an airtight lid to protect against moisture and stored in a cool, dark place. Under these conditions, samples may be archived and stored for 10-15 years. (EC, 2010).

Appendix 18

Guidelines for monitoring chemical contaminants in the sea using marine organisms



UNITED NATIONS ENVIRONMENT PROGRAMME

SEPTEMBER 1992

*Guidelines for monitoring
chemical contaminants in
the sea using marine organisms*

Reference Methods For Marine Pollution Studies No. 6

Prepared in co-operation with



FAO



IOC



IAEA

UNEP 1992

NOTE: This document has been prepared in co-operation between the United Nations Environment Programme (UNEP), The Food and Agriculture Organization of the United Nations (FAO), the International Atomic Energy Agency (IAEA) and the Intergovernmental Oceanographic Commission (IOC) under project FP/S102-88-03 (2849).

For bibliographic purposes this document may be cited as:

UNEP/FAO/IOC/IAEA: Guidelines for monitoring chemical contaminants in the sea using marine organisms. Reference Methods for Marine Pollution Studies No. 6, UNEP 1992.

PREFACE

The Regional Seas Programme was initiated by UNEP in 1974. Since then the Governing Council of UNEP has repeatedly endorsed a regional approach to the control of marine pollution and the management of marine and coastal resources and has requested the development of regional action plans. The Regional Seas Programme at present includes ten regions and has over 120 coastal States participating in it (1),(2).

One of the basic components of the action plans sponsored by UNEP in the framework of the Regional Seas Programme is the assessment of the state of the marine environment and of its resources, and of the sources and trends of the pollution, and the impact of pollution on human health, marine ecosystems and amenities. In order to assist those participating in this activity and to ensure that the data obtained through this assessment can be compared on a world-wide basis and thus contribute to the Global Environment Monitoring System (GEMS) of UNEP, a set of Reference Methods and Guidelines for marine pollution studies are being developed as part of a programme of comprehensive technical support which includes the provision of expert advice, reference methods and materials, training and data quality assurance (3). The Methods are recommended to be adopted by Governments participating in the Regional Seas Programme.

The methods and guidelines are prepared in co-operation with the relevant specialized bodies of the United Nations system as well as other organizations and are tested by a number of experts competent in the field relevant to the methods described.

In the description of the methods and guidelines the style used by the International Organization for Standardization (ISO) is followed as closely as possible.

The methods and guidelines, as published in UNEP's series of Reference Methods for Marine Pollution Studies, are not considered as final. They are planned to be periodically revised taking into account the development of our understanding of the problems, of analytical instrumentation and the actual need of the users. In order to facilitate these revisions the users are invited to convey their comments and suggestions to:

Marine Environmental Studies Laboratory
IAEA Marine Environment Laboratory
19, Avenue des Castellans
MC 98000 MONACO

which is responsible for the technical co-ordination of the development, testing and intercalibration of Reference Methods.

-
- | | | |
|-----|----------------|--|
| (1) | UNEP: | Achievements and planned development of the UNEP's Regional Seas Programme and comparable programmes sponsored by other bodies. UNEP Regional Seas Reports and Studies No. 1 UNEP, 1982. |
| (2) | P. HULM: | A Strategy for the Seas. The Regional Seas Programme: Past and Future, UNEP 1983. |
| (3) | UNEP/IAEA/IOC: | Reference Methods and Materials: A Programme of comprehensive support for regional and global marine pollution assessments. UNEP 1990. |

- ii -

The present document was prepared at the initiative of FAO, the Food and Agriculture Organization of the United Nations as part of its contribution to the Regional Seas Programme and in particular the Mediterranean Action Plan. The assistance of Dr. G. Topping with this work is particularly appreciated. The document was subsequently edited at IAEA's Marine Environmental Laboratory and reviewed by GEMSI, the IOC/UNEP Group of Experts on Methods, Standards and Intercalibration. The assistance of all those who participated in this work is gratefully acknowledge.

CONTENTS

	<u>Page</u>
1. Scope and field of application	1
2. References	1
3. Introduction	2
4. Definitions	3
5. Aims of monitoring programmes	4
6. Pilot study	5
7. Designing a monitoring programme	6
8. Selection of contaminants	7
9. Selection of organisms	8
10. Location of sampling sites	10
11. Period and frequency of sampling	11
12. Size of sample	12
13. Selection of tissue	13
14. Appendix 1: Guidance on the planning of a pilot study	14
15. Appendix 2: Documentation of data	17
16. Appendix 3: Examples of chemical substances measured in marine organisms from monitoring purposes	18
17. Appendix 4: A) List of MED-POL species B) List of possible organisms for the assessment of contamination in the North Atlantic Region	19
18. Appendix 5: Detection of differences in levels of contaminants in marine organisms in relation to spatial; and trend monitoring programmes	21

1. SCOPE AND FIELD OF APPLICATION

This publication provides guidelines for monitoring chemical contaminants in the sea using measurements in marine organisms. It describes strategies for applying such measurements to the protection of public health, the assessment of the geographical distribution of contaminants and the evaluation of time trends in contamination which in turn can demonstrate the effectiveness of measures designed to control potential sources of pollution.

2. REFERENCES

The following are useful publications to consult in relation to the design, planning and conduct of marine pollution monitoring programmes using marine organisms:

- BRYAN, G.W., LANGSTONE, W.J. and HUMMERSTONE, L.G. (1980). The use of biological indicators of heavy metal contamination in estuaries. Marine Biological Association of the United Kingdom, Occasional publication Number 1, June 1980, 73 p.
- BURNS, K.A. and SMITH, J.L. (1981). Biological monitoring of ambient water quality: the case for using sentinel organisms for monitoring petroleum pollution in coastal waters. *Estuar. Coastal Shelf Sci.*, 13: 433-443.
- DAVIES, I.M. and PIRIE, J.M. (1980). Evaluation of a "Mussel Watch" project for heavy metals in Scottish Coastal waters. *Mar.Biol.*, 57: 87-93.
- GOLDBERG, E.D., BOWEN, V.T., FARRINGTON, J.W., HARVEY, G., MARTIN, J.H., PARKER, P.L., RISEBOROUGH, R.W., ROBERTSON, W., SCHNEIDER, E. and GANBLE, E. (1978). The "Mussel Watch". *Environ.Conserv.*, 5: 101-125.
- GORDON, M., KNAUER, G.A. and MARTIN, J.H. (1980). *Mytilus californianus* as a bio-indicator of trace metal pollution: variability and statistical considerations. *Mar.Pollut.Bull.*, 11: 195-198.
- PHILLIPS, D.J.H., (1980). Quantitative aquatic biological indicators: Their use to monitor trace metal and organochlorine pollution. Pollution Monitoring Series, London, Applied Science Publishers Ltd, 488 p.
- PHILLIPS, D.J.H. and SEGAR, D.A. (1986). Use of bio-indicators in monitoring conservative contaminants: Programme design imperatives. *Mar.Pollut.Bull.*, 17(1): 10-17.
- SEGAR, D.A. and STAMMAN, E. (1986). Fundamentals of marine pollution monitoring programme design. *Mar.Pollut.Bull.*, 17(5): 194-200.
- TOPPING, G. (1983). Guidelines for the use of biological material in the first order pollution assessment and trend monitoring. Dept. of Agriculture and Fisheries for Scotland, Marine Laboratory, Scottish Fisheries Research Report No 28. ISSN 0308 8022, 28 p.

3. INTRODUCTION

Marine organisms can accumulate contaminants from seawater, suspended particulate matter, sediments and their food. It has also been demonstrated, through field observations and experimental studies, that the concentration of some contaminants in tissues are related to the concentrations in the surrounding environment. This process, termed bio-accumulation, has been used by scientists to assess the marine contamination which has been caused by man's activities (eg. marine disposal of wastes by pipeline discharges and dumping from ships).

There are however certain difficulties in using bio-accumulators, or bio-indicators as they are sometimes known, for this purpose. For example, individuals of the same species exposed to the same concentration of contaminants for the same period of time will not accumulate the substances at the same rate. This is related to such factors as age, sex, size and physiological state of the individual. Similarly, different species do not bio-accumulate to the same level when they are exposed to the same concentration of contaminant in sea water, and often have different rates of contaminant elimination.

Therefore, careful consideration must be given to the above factors when a monitoring programme is designed in order to reduce (or allow for) the effects of natural variability.

This document provides guidance on the design of such programmes and is intended for scientists who are responsible for marine pollution monitoring programmes. It is particularly aimed at programmes which fall under the auspices of the UNEP, IOC and FAO.

The guidelines presented in this report cover the following aspects of marine pollution monitoring programmes:

- aims
- pilot studies
- criteria for the selection of contaminants, organisms and locations to be studied
- size of sample
- frequency of sampling operations
- tissue selection.

Although an important component of these programmes is the analysis of contaminants in samples, this matter will not be addressed in detail in this document since other UNEP Reference Methods For Marine Pollution Studies cover this topic. Readers of this document are therefore advised to have the relevant analytical documents to hand (see UNEP/IOC/IAEA 1990); particularly "Contaminant monitoring programmes using marine organisms: Quality Assurance and Good Laboratory Practice" Reference Method No 57, since this deals with all aspects of work which influence the quality of data.

4. DEFINITIONS

Before discussing the programmes for which these guidelines may be used, it is necessary to define some of the more important terms which are used in this report.

Term	Definition
Accuracy, precision limit of detection	See definitions in Appendix 2 of Reference Method No 57.
Anthropogenic	Derived from human activity
Contamination	in the context of the marine environment this term describes a situation where either the concentrations of some natural substances (eg. metals) are clearly above normal values, or the concentrations of man-made substances (eg. DDT) is detectable but which do not necessarily cause deleterious effects (referred to as pollution, see definition below).
Bio-indicator	A species which accumulates a contaminant in its tissue in amounts that are proportional to the levels of the contaminant in the local environment (ie. water, sediment and food).
Hot spot	An area of the sea where there is a significantly high level of contamination
Pollution	The Group of Experts on Scientific Aspects of Marine Pollution defines pollution as "the introduction by man, directly or indirectly, of substances or energy into the marine environment (including estuaries) which results in such deleterious effects as harm to living resources, hazards to human health, hindrance to marine activities including fishing, impairment of quality for use of seawater and reduction of amenities."
Monitoring	A programme of repeated measurements of contaminants in marine samples which is carried out for a specific purpose eg. annual measurements of mercury in the edible tissue of fish to provide information on the potential annual intake of mercury by consumers. A study of mercury in fish which examines levels in different species would not be classed as monitoring. If, however, this study was repeated in subsequent years these sets of data would be classed as 'monitoring data'.

Pilot study	Measurements of contaminants in marine samples, in an area not previously studied, to investigate the current levels of contamination. This work is a prerequisite to a monitoring programme since the information collected in this study enables the investigator to design the sampling programme suited to the specific aims of the monitoring work. Without such information the investigator may be unable to judge which contaminants, organisms and locations to select for the monitoring programme.
Quality Assurance	All procedures that are carried out by a laboratory to ensure that it produces data of the appropriate quality to meet the defined aims of its monitoring programme. Quality Assurance essentially consists of two elements - quality control and quality assessment. Definitions of these latter terms are given in UNEP Reference Method No 57.

5. AIMS OF MONITORING PROGRAMMES

There are three principal aims of monitoring programmes which involve the collection and analysis of marine organisms; they are:

- to compare contaminant levels in the edible tissues of marine organisms against national limits and to provide data to calculate the potential amount of contaminant taken in by consumers (ie Public Health monitoring).
- to compare the levels of contamination in different geographical areas (Spatial Monitoring). Such measurements are often made to assess whether the current discharges of wastes are producing unacceptable levels of contamination ie they are causing, or likely to cause, marine pollution problems.
- to measure the levels of contaminants over time at particular locations to judge whether they are changing in relation to the inputs of contaminants (ie Trend Monitoring). Such measurements are made to assess the efficiency of measures taken to reduce pollution.

Investigators should write down the specific aims of each monitoring programme before commencing any field measurements. These aims are needed to narrow the list of parameters, species and sites to be investigated). There are two distinct aspects of aims:

Environmental management - Are standards complied with? What is the spatial extent of contamination? What are the changes of levels with time in relation to changes in inputs of contaminants?

Environmental science - Statistical significance of differences in levels of contaminants - representative sampling of the population - selection of analytical methods with the required accuracy and precision.

6. PILOT STUDY

This assists the investigator in the design of an efficient monitoring programme for each specific aim. Provided a pilot study is carefully planned (see Appendix 1 for guidance), it can provide the following information:

- a) In relation to public health studies, it can identify the relevant edible species, particularly the ones which contain elevated levels of regulated contaminants and therefore merit further investigation to determine the need for additional regulatory action, such as input controls or restriction on the harvesting or consumption of fish/shellfish.
- b) It can identify which areas of the marine environment are sufficiently contaminated to warrant monitoring.
- c) It can provide an indication of the variability of contaminant levels in individuals of the same species from the same population and location. This information is essential to an investigator wishing to establish a programme of trend monitoring. Without it, he may not be able to judge whether his sampling and analytical work will be sufficiently detailed to detect changes in contaminant levels with time against the natural fluctuations that may exist in any population of organisms.
- d) It can identify which tissues of organisms, particularly fish and large shellfish, are the most appropriate ones to use in specific monitoring programmes since not all tissues reflect changes in the levels of contaminants in the environment to which the organism is exposed.
- e) It can identify, and sometimes quantify, inputs of contaminants to the study area. This will help the investigator to select which contaminants should be given priority, if the resources for monitoring are limited, and in which areas contaminated organisms are likely to be found.

A pilot study can easily be expanded in order to accommodate measurements of biological effects. These effects may include changes in community structure and populations or adverse changes in the biochemistry of organisms (for example, acetyl cholinesterase depression by organophosphorus pesticides). Linkage of "levels" with "effects" is an important step in a complete pollution assessment. When effects are noted on a pilot scale, associated with specific contaminants or groups of contaminants, a strong case can be made for incorporating such contaminants in a full-scale monitoring programme and for taking immediate measures for their control and abatement. Details of some biological effects measurements are included in the Reference Method Series (see UNEP/IOC/IAEA, 1990).

Once a pilot study has been successfully completed, and the results evaluated, the investigator should prepare a protocol for each specific monitoring programme for the collection and analysis of samples. This protocol will specify what information is required to meet the specific aims, and the criteria to obtain the required quantity and quality of data. Time spent on the planning of a statistically significant sampling and analytical programme, will inevitably produce a more efficient programme which makes the best use of the laboratory's most important resource (ie staff time). Initially, it is generally sensible to conduct a programme which satisfies essential, rather than very ambitious, aims. It is relatively easy to expand this basic programme if extra resources become available. Finally, it is necessary to review the monitoring programme on a regular basis, to assess how well the aims are being met. This review may result in a reduction of effort on sampling and analyses, and the time gained can be usefully employed on other aspects of marine pollution studies. However, it might identify the need to put in more effort.

7. DESIGNING A MONITORING PROGRAMME

There are a number of factors to be considered in the planning of a monitoring programme which is to meet specific aims:

- a) Which contaminants should be measured?
- b) Which organism(s) should be selected?
- c) Where should the samples be collected?
- d) When should the sampling be done and how frequently should it be carried out?
- e) How many individual organisms should be collected on each sampling occasion and which size(s) should be included in each sample?
- f) Which tissue(s) of the organism(s) should be selected for analysis?

It is the principal investigator, together with a knowledgeable statistician and biologist, who will have to do this evaluation, design and plan the sampling work, prepare the necessary instruction sheets for the field staff, discuss with the analysts the precautions to be taken by staff in the storage and processing of samples prior to their analysis.

Specifically, the investigator will have to do the following:

- (i) Design a sampling programme for the organisms of interest; selecting sufficient numbers, and sizes, of individuals at each site at appropriate intervals of time to take into account the inherent variability of contaminant levels in the organisms. This work will be done on the basis of the results obtained from the pilot study and any relevant information from other similar studies. Sampling must be designed to provide a statistically sound basis on which to judge changes in contaminant levels. Once this sampling programme has been designed, instruction sheets should be prepared and issued to the field staff.
- (ii) Ensure that samples are collected, stored and transported to the laboratory in a way which minimizes losses and gains of contaminants prior to analysis. Guidance on this can be obtained by consulting the relevant documents in the UNEP Reference Methods series. Again it will be necessary to prepare instruction sheets for field and laboratory staff.
- (iii) Arrange for the processed samples to be analyzed using methods which have the required accuracy and precision. Experience has shown that close collaboration between the principal investigator and the analysts is essential if this work is to be successful. The investigator and the principal analyst should consult the UNEP Reference Method No 57 which gives guidelines on Quality Assurance, if they are in any doubt about how to achieve and maintain the required quality of analytical data.
- (iv) Ensure that there is an adequate system of documentation to allow samples to be traced from the time of collection to the recording of analytical data. The investigator should ensure that all relevant staff are aware of, and comply with, the system of documentation (see Appendix 2 for more details on this matter).

Each of the factors a - f will now be considered in more detail.

8. SELECTION OF CONTAMINANTS

The selection of substances to be monitored will be determined by a) the aims of the monitoring programme, b) the findings of the pilot study (ie which contaminants, present at significant levels above the background values, justify further study), and c) the ability of the analyst to measure these substances with the required accuracy and precision. In practice the last factor will often determine whether a particular contaminant or group of contaminants can be included in the monitoring programme.

It is essential that the principal investigator and the principal analyst agree to the required accuracy, precision and limit of detection for the measurements to ensure that the necessary standards of analysis are achieved eg. it would be inappropriate to consider measurements of specific changes in contaminant levels using an analytical method which had an inadequate level of precision.

If the analytical method used in the pilot study does not meet the required standard for the specific monitoring purposes, the analyst must select another method which meets the required standard. If for any reason this is not possible (eg. there is a statutory requirement to use a particular method) the investigator should abandon the proposed monitoring programme. Any other action will merely result in wasted effort, since the aims will not be met using an inadequate analytical method. However, it must be stressed that the use of an analytical method which, in theory, has the required performance characteristics to meet the aims does not necessarily guarantee success. Other factors have to be taken into account in obtaining the required quality of analytical data. These are discussed in some detail in "Quality Assurance and Good Laboratory Practice in relation to Marine Pollution Monitoring Programmes", UNEP Reference Method No 57. Investigators are strongly advised to obtain a copy of this document for analysts at the outset of the work.

In addition to selecting contaminants to meet the aims of the laboratory's marine pollution programme, it may be appropriate to include other contaminants which meet regional and international needs. This should only be considered if the additional data is useful to the laboratory, or if it is part of the laboratory's commitment to Regional Studies, and does not jeopardize the main aims of the laboratory's monitoring programme. A list of contaminants, identified by some organizations (International Council for the Exploration of the Seas, Oslo and Paris Commission's Joint Monitoring Group) for monitoring work in the North Sea and adjacent waters as well as those recommended (category I and II substances) for the MED POL programme are given, for information, in Appendix 3.

The final selection of contaminants should also be related to knowledge of their likely sources (eg. an extensive monitoring programme for pesticides along a desert coastline would be unwarranted) and information from scientific literature on their transport and persistence in the environment. Such information will also help to identify which environmental compartment should most usefully be monitored. As an example, organophosphorus pesticides are rapidly metabolized by many marine organisms but are rather persistent in sediments. It would be pointless to monitor them in biota but highly relevant to monitor their biological effects.

9. SELECTION OF ORGANISMS

9.1 Spatial and trend monitoring

Experience has shown that the most reliable data on contaminant trends in organisms are obtained by sampling organisms which have the following characteristics:

- A simple relationship exists between contaminant residues in the organisms and the average concentrations in the surrounding seawater or sediments.
- The organism accumulates the contaminant without being affected by the levels encountered.
- The organism is sedentary and thus representative of the area of collection.
- The organism is widespread in the study region, to allow comparisons between different areas.
- The organism is sufficiently long-lived, to allow sampling of more than one year class if desired.
- The organism is of a reasonable size, to give adequate tissue for analysis.
- The organism is easy to sample and robust enough to survive in the laboratory, allowing (if desired) depuration before analysis and, if needed, studies of uptake of contaminants.
- The organism exhibits high concentration factors, to allow direct analysis without pre-concentration.
- The organism is tolerant of brackish water, to allow comparisons to be made between estuarine and offshore sites.

These characteristics restrict the useful organisms to a range of fairly large, abundant, widespread, inter-tidal organisms, mainly molluscs. Filter-feeding molluscs are more likely to reflect contaminants in the water column, whilst deposit feeders will also be influenced by sediment chemistry. The working of the sediments both by organisms and water currents will cause an averaging of short-term variations in contaminant loading. Water chemistry, however, will more rapidly respond to effluent discharges and dispersal conditions at the time of sampling. Filter-feeders are therefore more likely to provide the information required to fulfill the objectives of a monitoring programme concerned with water quality. In Appendix 4, lists are given of organisms which some scientists in the United Kingdom have suggested may be used for monitoring a range of metals and organochlorine compounds in either rocky or muddy inter-tidal areas in UK waters.

In practice the selection of an organism, for monitoring purposes, is determined by its availability in the study area and its known ability to act as a bio-indicator. If this latter information is not known it must be obtained from either the scientific literature (eg. Phillips 1980), or the pilot study. Final selection should be made in consultation with a knowledgeable biologist. Common mussels, (*Mytilus edulis*, *M. californianus* and *M. galloprovincialis*), that are used in global mussel watch programmes are generally suitable for spatial and trend monitoring programmes in coastal waters.

Other species of shellfish, and fish, can be used for spatial and trend monitoring purposes provided the organism can be shown to accumulate the specific contaminant(s) and that the concentrations of the contaminant(s) are in proportion to the concentrations in either water or sediment or food.

9.2 Public Health programmes

If the pilot study has revealed that edible species from the local fishery contain levels of contaminants which approach or exceed statutory limits for contaminants in foodstuffs, then these organisms should be included in any subsequent public health monitoring programme.

Since permissible limits of some contaminants (eg. Cd) in foodstuffs are extremely low, the analytical method for this work must be capable of producing the required data quality. A high degree of accuracy, and a detection limit which is ca 1/10 of the permissible concentration of the contaminant in the foodstuff, are essential for this work. These criteria enable the analyst to have confidence in the results that are provided to managers for regulatory purposes.

10. LOCATION OF SAMPLING SITES

10.1 Spatial and trend monitoring

Hot spots are usually found in estuarine and coastal areas where anthropogenic wastes are discharged. The offshore areas where hot spots are most likely to occur are those used for the dumping of wastes from ships or those in the vicinity of offshore oil platforms.

A decision to monitor contaminant levels in 'hot spots' should be taken only after careful consideration of the discharges to these areas. If, as a result of the pilot study, the relevant authorities decide to reduce inputs then it would be appropriate to monitor to judge whether the new controls have been effective in reducing levels in organisms. If no action is to be taken on the regulation of discharges then monitoring is only justified if there is a good reason to update the information collected in the pilot study.

Other estuarine, coastal and offshore sampling sites may be included in the programme to provide coverage of both clean and moderately contaminated areas. All sampling should be done by scientific personnel operating from research or chartered vessels, rather than by fishermen, to ensure that contamination of the samples during and after collection is kept within acceptable limits.

For long-term monitoring programmes, the precise locality of sampling sites should be registered as very small spatial variation may strongly influence the final data (ie "mussels from the harbour wall" should specify which point in the harbour wall). In some cases it may be useful to photograph the sites, particularly where intertidal organisms are taken.

10.2 Public Health Programmes

In some countries there may be officials who are knowledgeable about the edible species of fish and shellfish caught by commercial fishermen. Investigators may find it helpful to discuss their proposed monitoring programme with such officials since they can often offer valuable advice in the design of the collection programmes.

Samples of fish and shellfish may be obtained from the fish markets or from fishing vessels or research ships which are operating in traditional fishing areas. The basic requirement is a representative sample of the species normally consumed by the general public. It should be noted, however, that some countries may specify the exact sampling procedures for public health monitoring.

Commercial fishermen do not usually take any special precautions during the collection, storage, transport and off-loading of their catches, other than to ensure that they are presentable enough for sale. The retailer and the consumer do not normally adopt any stringent dissection procedures, other than from a public health viewpoint. The scientist, however, will use careful sampling and pre-treatment procedures to ensure that contamination is kept within acceptable limits. These different approaches to sampling may lead to differences in the amount of contaminants found in the samples. In general the scientific samples will be less contaminated than those taken from fish markets, fishing boats and fish retailers.

The final decision on where and how to collect samples for public health monitoring will depend on whether information is required on actual contaminant intake by the consumer (in which case samples will be taken from the fish markets or fish retailers) or whether the aim is to determine which edible species and areas are exposed to contamination (in which case the sampling must be done by scientific staff).

11. PERIOD AND FREQUENCY OF SAMPLING

11.1 Spatial and trend monitoring

For spatial monitoring, collections should be made over a short interval of time (within weeks rather than months) to enable a synoptic comparison of concentrations of contaminants at different sites. This also helps to ensure that organisms are in the same physiological state. If major annual changes in the quantity and/or composition of inputs are anticipated it would be appropriate to conduct an annual or biennial sampling. Experience has shown that the effects of changes in inputs of contaminants are often confined to the area in the immediate vicinity of the discharge. It is these areas where more frequent monitoring should be conducted.

For trend monitoring, the frequency of sampling will a) reflect the time scales over which the changes are required to be detected, b) the degree of confidence required in the measurement of these changes, and c) the available laboratory resources. Investigators should note that there is nothing more frustrating and time-wasting than a programme in which the proposed work is well below the minimum standard required to detect the desired changes in contaminant levels. If, for any reason, the resources are insufficient to meet the specific aims of the programme, then the programme should be canceled and replaced with one which has less ambitious aims but which can be carried out successfully with available resources.

If no changes in inputs are expected, then it would be sensible to restrict sampling to ca 5 yearly intervals. A more frequent sampling programme can only be justified if there is a need to provide more regular data for other purposes eg. to reassure the general public that levels of contaminants are not changing.

Seasonal variations in food supply, and the spawning cycle, are known to cause changes in total body weight, as well as lipid concentration and composition and, these may influence contaminant levels in the tissues of some organisms. In order to minimize these variations, it is suggested that sampling be undertaken at the pre-spawning period.

11.2 Public Health monitoring

Unless there is a seasonal fishing pattern for some species, samples may be taken at any time of the year. Ideally all species should be sampled at the same time so that a synoptic picture of the contaminant levels can be obtained. A typical monitoring programme might consist of a survey every 5 years. A more frequent sampling programme (ie annual) will be needed if the results of the pilot programme show that concentrations of contaminants in foodstuffs approach or exceed permissible limits for foodstuffs. Increased sampling should be confined to the particular species and contaminants which give cause for concern.

12. SIZE OF SAMPLE

12.1 Spatial and trend monitoring

Ideally, the investigator will have established the relationship between contaminant levels and size of organisms from the results of the pilot study. It is good practice to select a particular size or size range to minimize the variance of contaminant levels from sample to sample. The number of individuals required for each sample will be determined by the magnitude of the change that is considered to be significant in relation to the specific aims. The smaller the difference the greater the number of individuals required for each sample. (See Appendix 5 for further guidance)

If the relationship between size of organism and contaminant level has not been obtained from the pilot study then a sufficient number of individuals should be collected at one of the sampling sites to cover the size range of organisms in the population, to establish the variability of contaminant levels with size. This is a minimum requirement since, ideally, this sampling procedure should be done at all sites. The information on variability at one site will allow the investigator to make comparisons with other sites where individuals of a limited size range are collected.

If either analytical resources or sample material is limited it may not be practical for the individuals from each site to be analyzed separately. In this case, individuals should be combined to make one sample (often referred to as 'pooled' samples). For 'pooled samples', no information will be obtained on the variation of contaminant levels with size but the data can be used to assess site to site differences with some level of confidence, provided that a number of replicate analyses are done on each of the 'pooled' samples, and the 'pooled' samples consist of individuals from the same size range.

12.2 Public Health monitoring

The size(s) of organisms to be sampled should be based on information on consumption patterns. If a range of sizes is sold, then these different sizes should be analyzed. The number of individual organisms in each sample will be influenced by the importance of the species as a foodstuff, the availability of scientific manpower and the need to sample sufficient numbers of each species and of each size category to cover the range of values encountered in a typical population or catch. Generally, a sample of 5-10 individuals from each size range of fish and large shellfish (crabs, lobsters) and ca 50 individuals for smaller shellfish (eg. mussels, shrimps) would be sufficient.

13. SELECTION OF TISSUE

13.1 Spatial and trend monitoring

For invertebrates, whole soft tissue (less viscera) should be taken for analysis.

For fish, muscle is the most useful tissue for most purposes. However, liver and kidney tissues have been used for studies of fish and the digestive gland of large crustaceans. In general, whole soft tissue is taken for smaller shellfish.

13.2 Public Health monitoring

Only edible tissue need be analyzed for contaminants - usually this means muscle tissue for fish and large crustaceans and whole soft tissue (less viscera, ie guts, gills and gonad) for small shellfish.

Every opportunity should be taken to collect data on the size (or length) and age of the species. This may be relevant to subsequent decisions on regulatory action.

13.3 Normalization procedures

It is usual to report all tissue data on a dry weight basis (ie. g contaminant/g (dry weight)). However, some literature values use wet weight which may be required for public health studies. Since drying is a common part of most analytical protocols (see RM. No. 7 "Sampling of selected marine organisms and sample preparation for trace metal analysis" and RM. No. 12 "Sampling of selected marine organisms and sample preparation for the analysis of chlorinated hydrocarbons"), the reader is advised to record wet/dry weight ratios on a routine basis.

In the case of lipophilic contaminants, such as chlorinated hydrocarbons, contaminant concentrations are often expressed in terms of g contaminant/g HEOM (where HEOM is Hexane Extractable Organic Matter, principally lipid). This procedure enables a certain degree of normalization for seasonal or spatial variations in the lipid content of sentinel organisms and facilitates the comparability of data.

Appendix 1

GUIDANCE ON THE PLANNING OF A PILOT STUDY

Desk Study

It is important to determine what is known about contaminants in the proposed study area, before any field work is done. Some of this information can be found by reviewing the relevant scientific journals and other published material (eg. books, conference proceedings).

Annual reports of other marine institutes, local and central government and industrial research laboratories are also useful sources of data, as are unpublished scientific reports from these organizations. If these latter sources provide useful data, it is good practice to contact scientists from the relevant organizations to identify whether there is any other unpublished data or information, which might be useful to the investigator.

This review can often provide data on the current levels of contamination in water, sediments or biota and occasionally information on inputs of contaminants to the area via rivers, pipelines or dumping from ships. It may also reveal the type of industry and agriculture located in the coastal region, the range and scale of potentially toxic substances used by them, and possibly information on their discharges to the rivers and sea. These latter data should be verified by contacting the local or national authority, which has responsibility for regulating discharges to rivers and coastal waters. This authority should also be approached for information on the past and present discharges to the area.

For public health work, the investigator should identify which fish and shellfish species are caught for human consumption, and whether there are relevant permissible limits for contaminants in marine foodstuffs. Information on commercial catches can be obtained from either the local fishermen or their representative organizations or the local or central government fisheries department. Information on food standards can be obtained from the local environmental health department or the central government department responsible for food safety. It is difficult to be more specific about the exact sources of the above information in each country since they do vary from country to country.

This review should enable the principal investigator to identify the group of contaminants, and specific fish and shellfish, which should be given priority in the pilot study for public health purposes. It will also give some general guidance on the species to be selected for spatial and trend monitoring purposes. However, before the principal investigator can plan this latter work he needs to do some additional desk work to identify the locations where samples should be collected.

Identifying sampling sites

It is essential that the pilot study covers the areas which are likely to be contaminated and the areas which, from a hydrographic and input viewpoint, are unlikely to be significantly affected (ie sites located well offshore from industrialized areas or those located in inshore areas next to less populated and industrialized areas).

The level and extent of contamination in coastal and estuarine waters is determined by:

- the rate of input of contaminants
- the location of the individual inputs
- the composition of the waste - whether the contaminants are in solution, attached to solids or associated with mixtures of solid and liquid
- the dilution and dispersion of wastes following discharge, and in the case of discharges containing solids, the settlement of solid material to the sea bed sediments
- the physical and chemical processes in the sea (ie adsorption and desorption of substances between dissolved and particulate phases of seawater).

Unless the principal investigator has a good working knowledge of hydrography of the local area, it will be necessary to seek the help of an hydrographic expert to determine the optimum locations for sampling in relation to known inputs.

Assuming the principal investigator can provide the hydrographer with the relevant information on inputs, and that his colleague has a good understanding of the hydrographic characteristics of the area (direction, speed and variability of currents, salinity and temperature of the water masses, and the freshwater flows to the sea) it should be possible to calculate the theoretical dilution and dispersion of wastes at estuarine and coastal sites. This information can then be used to identify the locations where organisms are exposed to contamination and the adjacent areas where they will probably not be subject to contamination (ie clean or control areas).

If expert hydrographic advice is not available, the principal investigator should establish a sampling grid along the likely gradient of contamination; with sampling sites located at progressively increasing distances from the input (100m, 300m, 1000m, 3000m etc.). If a river is the principal source of contamination to the study area, the investigator can establish his sampling grid along the salinity gradient. It is relatively easy to calculate the dilution of river water, and the corresponding dilution of contaminants, by measuring the salinity at locations in an estuary and comparing these measurements with the salinity values of the water entering the estuary. For this calculation, the investigator assumes that river water has zero salinity and that the contaminants behave conservatively during mixing of freshwater and seawater.

Sample size

The concentration of some contaminants can vary with size of the organisms. It is important in spatial and trend monitoring to reduce this source of variability in the data to detect differences in contaminant levels between sites and with time (see Appendix 5). If this relationship is not known by the investigator prior to the commencement of monitoring, it will be necessary to establish it during the pilot study.

To do this, the investigator must collect a representative sample of each population of species at each sampling site. This sample should include sufficient numbers of individuals to cover the range of sizes/ages/lengths of individuals in each population. The investigator should consult a knowledgeable biologist for guidance on the range of sizes that might be expected for each species.

Selection of tissue

Although there is considerable scientific literature on the accumulation of contaminants by different tissues (eg. Phillips, 1980), it is advisable for the investigator to check this aspect for the specific organisms to be examined in the pilot study. It is also advisable to consult a biologist to determine the best procedure for dissection of organisms into their constituent parts, to ensure that there is no possibility of one tissue being contaminated by another.

Ideally, the investigator should investigate the relationship between the contaminant level, tissue and size of organism by analyzing tissue from individuals of different sizes rather than by analyzing pooled samples; even if the latter consist of a number of individuals of the same size or size range. However, if analytical resources are limited, it may be necessary for him to establish this relationship by analyzing pooled samples.

Appendix 2

DOCUMENTATION OF DATA

The adoption of the following guidelines by a laboratory should provide adequate documentation to allow it to trace samples from the collection stage to the completion of its analyses by providing a record of the appropriate data in logbooks or in computer files.

Documentation

- (i) Descriptions of the sampling strategy, methods of sample collection, procedures for storage, and pre-treatment and analytical procedures, plus a list of ancillary site observations;
- (ii) Sample documentation (description of organisms, numbers of individuals collected for each sample, weights of tissue taken for analysis (individual tissue or homogenate) plus ancillary data on organisms (length, weight and age);
- (iii) Description of analytical procedures, including details of accuracy, precision and limit of detection;
- (iv) Description of quality control and quality assessment and evidence that these procedures have been applied and have provided acceptable data;
- (v) Description of working standards used on each occasion and calculations of results;
- (vi) A secure system for the long term storage of data either in logbooks or computer files is essential. It is also advisable to have a duplicate set of records in case one is lost, mislaid or accidentally destroyed;

Advice should be sought on the correct method of storing computer tapes and/or discs to ensure the long-term stability of data files.

Storage of data

It has been shown that even the most experienced personnel can make simple arithmetic errors in calculating results. Thus, a check should be made for such errors before compiling tables of results. Once this check has been MADE it is appropriate to carry out a preliminary assessment of the quality of the data, prior to its evaluation and publication, to ensure that no erroneous results are included. This assessment can include a comparison of the results with existing data (ie data for the study area either previously collected by the laboratory or data published in the literature). Before consigning data to long term storage, a final check should be made to ensure that no errors have been made in transcribing the data (ie the re-typing of data sets by typists or data processors can sometimes lead to such errors).

Appendix 3

EXAMPLES OF CHEMICAL SUBSTANCES MEASURED IN MARINE ORGANISMS FOR MONITORING PURPOSES

(SOURCE:

Trace metals

Arsenic (As), Cadmium (Cd), Chromium (Cr), Copper (Cu), Lead (Pb), Mercury (Hg), Nickel (Ni), Tin (Sn), and Zinc (Zn).

DDT and its metabolites

o,p'-DDD, p,p'-DDD, o,p'-DDE, o,p'-DDT, and p,p'-DDT.

Chlorinated pesticides other than DDT

Aldrin, Alpha-Chlordane, Trans-Nonachlor, Dieldrin, Heptachlor, Heptachlor epoxide, Hexachlorobenzene, Lindane (gamma-BHC), and Mirex (+ Endosulfan ?)

Polychlorinated biphenyls (PCBs)

Measurements are usually restricted to either a small number of individual compounds (known as congeners) or to the total concentration of PCBs.

Polyaromatic hydrocarbons

These can include:

2-ring compounds	Naphthalene, 1-Methylnaphthalene, 2-Methylnaphthalene, 2,6-Dimethylnaphthalene, and Acenaphthene.
3-ring compounds	Fluorene, Phenanthrene, 1-Methylphenanthrene and Anthracene.
4-ring compounds	Fluoranthrene, Pyrene, and Benz(a)anthracene
5-ring compounds	Chrysene, Benzo(a)pyrene, Benzo(e)pyrene, and Dibenz(a,h)anthracene.

For the purposes of the Long-term programme for pollution monitoring and research in the Mediterranean sea (MED POL - Phase II) the following chemical contaminants were identified for analysis in marine organisms.

category I (mandatory)

total mercury
organic mercury
cadmium
halogenated hydrocarbons

category II (optional)

total arsenic
radionuclides
polynuclear aromatic hydrocarbons

Appendix 4

A. LIST OF MED-POL SPECIES

For the purposes of the Long-term programme for pollution monitoring and research in the Mediterranean sea (MED POL - Phase II) the following species (nearly all edible), representing different ecotypes, are recommended for the monitoring of chemical contaminants in marine organisms.

a) Bivalves

Mytilus galloprovincialis, or

Mytilus edulis, or

b) Demersal fish

Perna perna, or

Donax trunculus

M. edulis, P. perna or D. trunculus can only be monitored as alternative species if Mytilus galloprovincialis does not occur in the area.

Mullus barbatus, or

Mullus surmuletus, or

Upeneus molluccensis

M. surmuletus or U. molluccensis can only be monitored as alternative species if Mullus barbatus does not occur in the area.

c) Pelagic carnivore fish

Thunnus thynnus, or

Thunnus alalunga, or

Xiphias gladius

d) Pelagic plankton feeding fish

Sardina pilchardus

Other clupeids should only be monitored as alternative species if S. pilchardus does not occur in the area.

e) Crustaceans

Parapenaeus longirostris, or

Nephrops norvegicus, or

Penaeus kerathurus

N. norvegicus or P. kerathurus can only be monitored as alternative species if P. longirostris does not occur in the area.

**B. LIST OF POSSIBLE ORGANISMS FOR THE ASSESSMENT OF
CONTAMINATION IN THE NORTH ATLANTIC REGION**

	Cd	Hg	Cu	Cr	Pb	Zn	HH	PHC
Rocky substrate								
<u>Mytilus edulis</u> (common mussel)	+		?	+	+	+	+	+
<u>Littorina littorea</u> (gastropod)	+		+	?	+	+		
<u>Patella vulgata</u> (limpet, gastropod)	+		+		+	+		
Muddy substrate								
<u>Scrobicularia plana</u> (da Costa) (peppery furrow bivalve)	+	+	?	+	+	+		
<u>Macoma balthica</u> (bivalve)	+	+	?	+	+	+		
<u>Nereis diversicolor</u> (annelid)	+	+	+	+	+	+		

Key: + = appears to act as good indicator
 ? = doubt about use as indicator
 HH = halogenated hydrocarbons
 PHC = petroleum hydrocarbons

NOTES: The organisms listed for muddy substrates are all deposit feeders, whilst those for rocky substrates are filter feeders or herbivores. It is unlikely that contaminant levels in the tissues of the two groups will reflect contaminant levels in the same part of the marine environment.

Annex II:

Sampling of selected marine organisms and sample preparation for trace metal analysis



*Sampling of selected marine organisms
and sample preparation for trace metal analysis*

Reference Methods for Marine Pollution Studies No. 7 Rev. 2

Prepared in co-operation with



FAO



IAEA



IOC

Note: This document has been prepared in co-operation between the Food and Agriculture Organization of the United Nations (FAO), the International Atomic Energy Agency (IAEA), the Intergovernmental Oceanographic Commission (IOC) of UNESCO and the United Nations Environment Programme (UNEP) under projects FP/ME/0503-75-07, ME/5102-81-01, FP/5102-77-03 and FP/5101-84-01.

For bibliographic purposes this document may be cited as:

UNEP/FAO/IAEA/IOC: Sampling of selected marine organisms and sample preparation for trace metal analysis. Reference Methods for Marine Pollution Studies No. 7 Rev. 2, UNEP 1984.

PREFACE

The Regional Seas Programme was initiated by UNEP in 1974. Since then the Governing Council of UNEP has repeatedly endorsed a regional approach to the control of marine pollution and the management of marine and coastal resources and has requested the development of regional action plans. The Regional Seas Programme at present ^{1/} includes ten regions and has over 120 coastal States participating in it. ^{2/}

One of the basic components of the action plans sponsored by UNEP in the framework of Regional Seas Programme is the assessment of the state of marine environment and of its resources, of the sources and trends of the pollution, and the impact of pollution on human health, marine ecosystems and amenities. In order to assist those participating in this activity and to ensure that the data obtained through this assessment can be compared on a world-wide basis and thus contribute to the Global Environment Monitoring System (GEMS) of UNEP, a set of reference methods and guidelines for marine pollution studies are being developed and are recommended to be adopted by Governments participating in the Regional Seas Programme.

The methods and guidelines are prepared in co-operation with the relevant specialized bodies of the United Nations system as well as other organizations and are tested by a number of experts competent in the field relevant to the methods described.

In the description of the methods and guidelines the style used by the International Organization for Standardization (ISO) is followed as closely as possible.

The methods and guidelines, as published in UNEP's series of Reference Methods for Marine Pollution Studies, are not considered as final. They are planned to be periodically revised taking into account the development of our understanding of the problems, of analytical instrumentation and the actual need of the users. In order to facilitate these revisions the users are invited to convey their comments and suggestions to:

International Laboratory of Marine
Radioactivity
International Atomic Energy Agency
c/o Musée Océanographique
MC98000 MONACO

which is responsible for the technical co-ordination of the development, testing and intercalibration of reference methods.

1/ UNEP: Achievements and planned development of UNEP's Regional Seas Programme and comparable programmes sponsored by other bodies. UNEP Regional Seas Reports and Studies No. 1 UNEP, 1982.

2/ P. HULM: A Strategy for the Seas. The Regional Seas Programme: Past and Future UNEP, 1983.

This issue (Rev.2) of the Reference Method for Marine Pollution Studies No. 7 was prepared in co-operation with the Food and Agriculture Organization of the United Nations (FAO), the International Atomic Energy Agency (IAEA) and the Intergovernmental Oceanographic Commission (IOC) of UNESCO. It includes comments received from IOC's GIPME Group of Experts on Methods, Standards and Intercalibration (GEMSI), from the FAO/UNEP/IAEA Experts Consultation Meeting on Reference Methods for the Determination of Chemical Contaminants in Marine Organisms (Rome, 4-8 June 1984) and from a number of scientists who reviewed and tested the method. The assistance of all those who contributed to the preparation of Revision 2 of this reference method is gratefully acknowledged.

CONTENTS

	<u>Page</u>
1. Scope and field of application	1
2. References	1
3. Principles	1
4. Reagents	1
5. Apparatus	2
6. Sampling and transport	3
7. Sample preparation	5
8. Sampling and sample preparation protocol	10
Appendix A : Preparation of plastic tweezers	14
Appendix B : Specimen identification note	15

1. SCOPE AND FIELD OF APPLICATION

This publication describes the sampling and sample preparation procedures suitable to obtain uncontaminated samples of mussels (total soft tissue), shrimps (muscles), and fish (muscles) for trace metal analysis by atomic absorption spectrophotometry.

2. REFERENCES

BERNHARD, M. (1976) Manual of methods in aquatic environment research. Part 3. Sampling and analyses of biological material. FAO Fish.Tech.Pap. No. 158 (FIRI/T158), pp. 124. FAU, Rome.

UNEP/FAO/IAEA (in preparation). Guidelines for monitoring chemical contaminants in marine organisms. Reference methods for marine pollution studies No. 6. UNEP, Geneva.

3. PRINCIPLES

Specimens of organisms selected and collected according to UNEP/FAO/IAEA (in preparation) are enclosed in plastic containers and transported to the analytical laboratory either as cooled (-2 to 4°C) or as deep-frozen (-18°C) samples. There the specimens are dissected under "clean conditions" and subsamples are prepared for the analyses of trace metals.

4. REAGENTS

4.1 Demineralized distilled water or glass distilled water of equivalent quality, with a trace metal content below detection limits when checked with this reference method.

4.2 Uncontaminated "open-ocean" subsurface (1 m below the surface) sea water.

4.3 Detergent recommended for laboratory use.

5. APPARATUS

5.1 Plastic thermo-insulated boxes (camping equipment) cooled with commercially available cooling bags. For storage and transport of mussels the boxes must be equipped with a grid in the bottom in order to avoid the mussels being submerged when moistened during transport and storage.

5.2 Refrigerator (required for 6.2, 6.3, 6.4).

5.3 Deep-freezer (-18°C).

5.4 Heavy duty, high-density polyethylene bags or suitable plastic containers for storage of specimens.

5.5 Plastic length-measuring board, length-measuring scale (ruler) or transparent Pyrex dish (cooking utensil) with centimetre scale attached underneath (for small and medium-size specimens).

5.6 Two or more plastic knives made out of high-density and purity polyethylene or similar material. Alternatively, quartz knives can be used.

5.7 Pyrex dishes or porcelain dishes (cooking utensils) as working surface for sample preparation.

5.8 Two or more pairs of plastic, commercially available or "home-made", tweezers (see Appendix A).

5.9 High density and purity polyethylene bags and airtight plastic containers with screw caps, for preservation of samples in deep-freezer, cleaned with detergent (4.3) and rinsed with distilled water (4.1) or uncontaminated sea water (4.2).

5.10 High-density polyethylene sheets for covering working bench.

5.11 Smaller polyethylene sheets to be used as "weighing plastic".

5.12 Balance (100-200 g) with a precision of 0.001 g or better, for weighing specimens and subsamples; preferably a "top-loading" balance.

5.13 Plastic wash bottle containing glass-distilled water (4.1).

5.14 Scraper (figure 1), a strong rust-free knife or similar for collecting mussels.

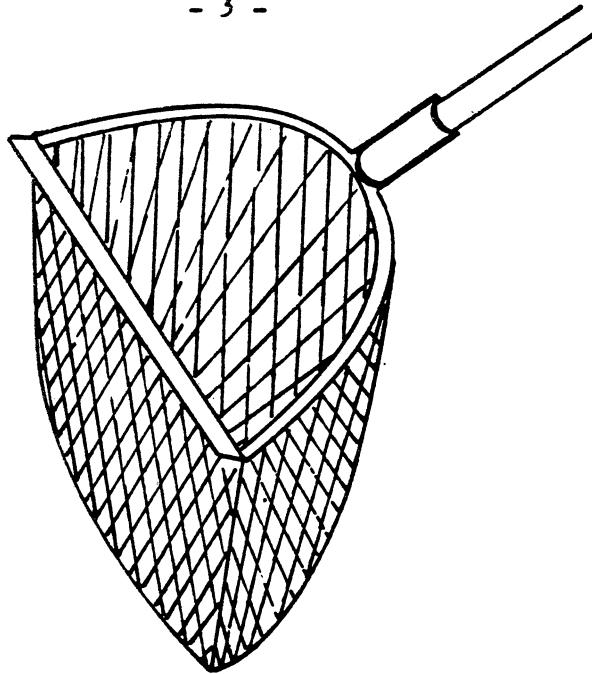

FIGURE 1 : SCRAPER FOR COLLECTING MUSSELS

5.15 Plastic tank or bottle (20 - 50 l) for the sea water (4.2) needed to moisten live mussel samples during storage and transport.

5.16 Large rust-free metal knife for cutting portions from large fishes.

5.17 Stainless steel blender or other tissue homogenizer made from glass and/or teflon. Stainless steel equipment should be tested for trace metal contamination by homogenizing reference (standard) material and comparing the analytical result obtained with same material which was not homogenized with stainless steel equipment.

5.18 Strong plastic brush for removing foreign material attached to the surface of mussels.

6. SAMPLING AND TRANSPORT

6.1 Presampling preparations

Clean the thermo-insulated boxes (5.1), the high density polyethylene bags or containers (5.4), the length-measuring board (5.5), the large rust-free knife (5.16), the scraper or the knife (5.14) with detergent (4.3) and rinse them with distilled water or, alternatively, with clean open-ocean sea water (4.2).

6.2 Sampling of mussels

Remove mussels from their attachments with the clean scraper or the rust-free knife (5.14).

Transfer a suitable number (UNEP/FAO/IAEA (in preparation)) of undamaged mussels into clean thermo-insulated boxes with grid on the bottom (5.1). Collect, from the sampling site, a clean sea water sample in a suitable container (5.15) to keep the mussels moist if a long transport (more than 2 hours in hot climates) is envisaged. Keep the mussels moist with the clean sea water without submerging them.

If the mussels have to be transported and stored before sample preparation (7) for more than 24 hours place a suitable number of mussels in plastic bag (5.9). Squeeze out the air and close the bag airtight with a knot, thermoseal, or similar. Place the bag into another bag (5.4) together with a sample identification note (see Appendix B), close airtight the second bag and deep-freeze.

This represents the "specimen sample".

NOTE: The transport of mussels collected near the laboratory will not present special transport and storage problems. Mussels should be kept exposed to air and moistured with clean sea water during the transport to the laboratory. When gathered from the intertidal zone, they will survive aerial exposure for 24 hours. Mussels submerged in sea water during transport will open their valves, start pumping water and excreting waste products, while during aerial exposure their valves will remain closed and their metabolic rate is greatly reduced; therefore their submersion in sea water during transport should be avoided.

6.3 Sampling of shrimps and small to medium-size fish

Place in a clean plastic bag (5.4) a suitable number of the undamaged specimens (select according to UNEP/FAO/IAEA (in preparation)) collected from a fishing vessel, fish market, etc., taking care that the legs, spines, etc. will not puncture the plastic. Squeeze out the air and close the bag airtight with a knot, thermoseal, or similar. Place the bag into another bag (5.4) together with a sample identification note (see Appendix B), and close the second bag airtight also. Deep-freeze (5.3) the bag whenever possible. Use a refrigerator (5.2) or a cooled thermo-insulated box (5.1) only if the storage period is not too long (48 hours in hot climates).

This represents the "specimen sample".

6.4 Sampling of large-size fish

Determine and note the fork-length, the body weight and sex of the collected specimen.

Separate with a clean rust-free metal knife (5.16) a portion of at least 100 g of muscle tissue. This portion must be at least 5 cm thick so that during sample preparation (7.3) contaminated and dirty tissue can be sliced off. Place each portion into a separate clean bag (5.4), squeeze out the air and close the bag airtight. Place it together with the sample identification note (see Appendix B) into a second bag (5.4) and close it airtight also. Deep-freeze

(5.3) the bag whenever possible, otherwise use a refrigerator (5.2) or a cooled thermo-insulated box (5.1) if the storage period is not too long (48 hours in hot climate).

This represents the "specimen sample".

7. SAMPLE PREPARATION

7.1 Preparatory activities

If necessary, partially thaw deep-frozen samples (6) by placing them overnight in a refrigerator at -2°C to 4°C (partially frozen samples are easier to cut than completely thawed or even fresh samples).

Clean the knives (5.6), the dishes (5.7), the tweezers (5.8), the length-measuring board (5.5) and "weighing plastics" (5.11) with detergent (4.3), rinse with distilled water (4.1) or clean sea water (4.2). Cover the working area with pre-cleaned plastic sheets (5.10). Clean hands carefully with detergent (4.3) and rinse them with distilled water (4.1) or clean sea water (4.2).

NOTE: If hands are cleaned and precautions are taken not to touch the dissected part with hands, bare hands are preferred to hands covered with gloves, since the operator has a much better control of instruments, etc. If possible a clean room should be used for preparatory activities.

7.2 Sample preparation of mussels

Scrape off all foreign materials attached to the outer surface of the shell with a clean plastic knife (knife no. 1) (5.6), to be used only for this purpose or with a strong plastic brush (5.18). Handle the mussels as little as possible.

Rinse each mussel with distilled water (4.1) or alternatively with clean sea water (4.2) and let the water drain off.

Pull out the byssus which extrudes from between the closed shells on the concave side of the shells.

Weigh (5.12) the whole mussel and note the weight.

Insert a second clean plastic knife (knife no. 2) (5.6) into the opening from which the byssus extrudes and cut the adductor muscles by turning the knife as indicated in figure 2 and open the mussel. Do not try to break the mussel open with the knife; if the muscles are cut, the mussel will open easily. Check if the byssus has been eliminated completely; if not, remove the remainder with clean tweezers (5.8).

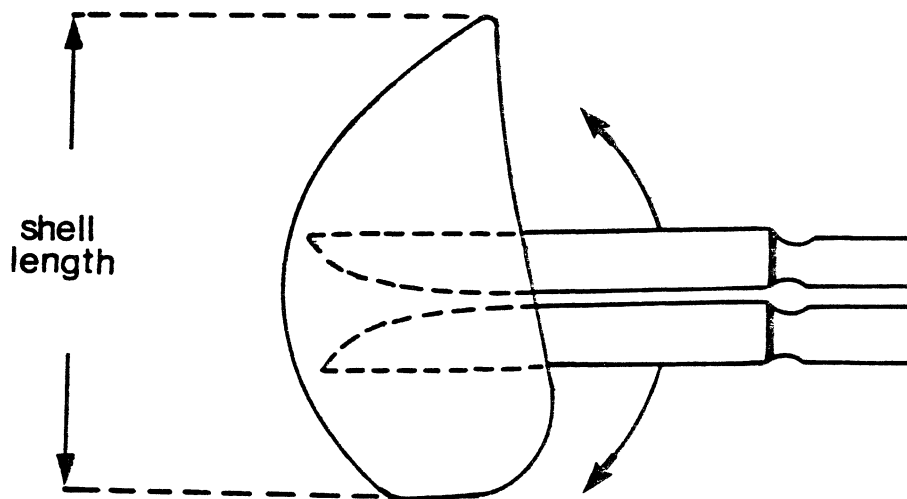

FIGURE 2 : CUTTING THE ADDUCTOR MUSCLE

Rinse the soft part of the mussel in its shells with distilled water (4.1) or clean sea water (4.2).

Loosen all tissue with the second clean knife (knife no. 2) (5.6), remove the soft tissue from the shell with a pair of clean plastic tweezers (5.8) without touching the outer part of the shells, and let all the water drain off.

(a) Single specimen sample: Weigh a clean empty container (5.9) on the balance and note the weight. Then put the soft part of the mussel in it and reweigh. Note the fresh weight of the soft part. Close the container airtight, label it with the sample preparation code. Determine the length of the mussel's shell (figure 2) by placing it with the inner part facing the cm scale (5.13). Note the length of the shell and the weight of the soft part of the mussel.

(b) Composite sample: Fill a container (5.9) of known weight with at least 10 soft parts of mussels prepared as described above. Reweigh the plastic container and note the composite fresh weight of the mussels. Homogenize the specimens in a cleaned blender (5.17), and return the homogenate in the plastic container. Note the total weight again and recalculate the fresh weight of the homogenate. Label the plastic container with the sample code.

NOTE: When preparing composite samples, use mussels of similar size. The length and weight of each specimen should be determined separately before the soft parts are pooled.

Place several plastic containers in a clean plastic bag (5.4), include an identification note with the containers sample codes, seal the bag airtight and deep-freeze.

This represents the "tissue sample".

7.3 Sample preparation of shrimps

(a) Single specimen sample: Determine the length of the shrimp from rostrum to uropod (see figure 3) using the appropriate length measuring device (5.5). Weigh the shrimp after placing a clean "weighing plastic" (5.11) on the balance (5.12) and note its length and fresh weight.

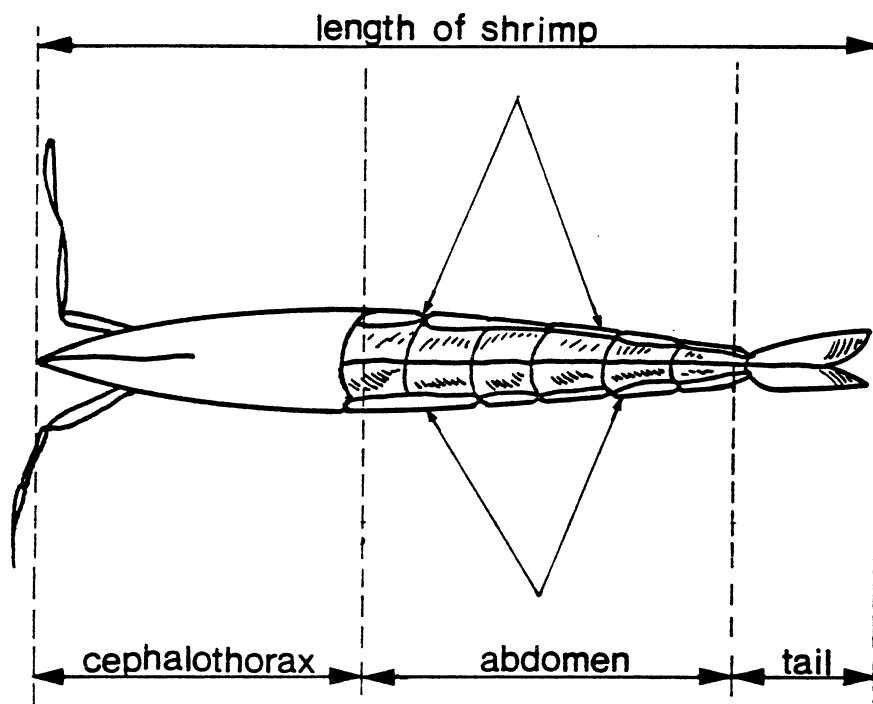

FIGURE 3 : SCHEMATIC DIAGRAM OF A SHRIMP
(arrows indicate where to cut after the legs have been removed)

Separate the abdomen from the cephalothorax and the "tail" (telson and uropod) with a first plastic knife (knife no. 1) taking care that no viscera remain in the abdomen (figure 3). Cut off all legs. Turn the abdomen with the ventral side up and cut with a plastic knife along the edges of the sterinities (ventral exoskeleton); lift the sterinities off with a pair of plastic tweezers and discard.

Loosen with a second clean knife (knife no. 2) the abdomen muscle and lift it from the exoskeleton with a clean pair of tweezers.

Determine and note the sex by examining the gonads.

Transfer the muscle with a clean pair of plastic tweezers (5.8) into a preweighed plastic container (5.9), determine and note the fresh weight of the muscle. Close the container airtight, label it with the sample code, place a suitable number of containers in a plastic bag, add a sample identification note to the containers, and close the bag airtight and deep freeze the samples.

(b) Composite sample: Start sample preparation as described for single specimen sample above taking care to record length, fresh weight, tail muscle weight and the sex of each specimen separately. Reduce the tail muscle(s) of the large specimens to the weight of the smallest tail muscle. A composite sample should not contain less than 6 tail muscles from 6 different specimens of

the same sex and size. Homogenize the tail muscles in a blender (5.17). Transfer the homogenate into a suitable clean container (5.9) which has been weighed empty. Close the container airtight, label it and weigh the container with the homogenate. Note the weight of the homogenate together with the other data in a protocol. Place a suitable number of containers in a plastic bag (5.4), add a sample identification note, close the bag airtight and deep-freeze (5.3) the containers.

This represents the "tissue sample".

NOTE: The concentration of trace metals in a composite sample should represent the mean value of metal concentrations of single specimens. In order to avoid overrepresentation of large specimens, only shrimp of similar size (age) should be used for the preparations of composite samples. In addition, the weight of the tail muscles of all specimens to be included in the composite sample should be reduced to that of the tail muscle of the smallest specimen. As there might be considerable differences in the trace metal content of male and female specimens, use them in separate composite samples.

7.4 Sample preparation for small and medium size fish

(a) Single specimen sample: Determine the fork-length (from tip of snout when the mouth is closed to the apex of the fork of the tail) of fish (figure 4) to the nearest mm on the length-measuring board (5.5). Weigh the fish on a clean "weighing plastic" (5.11) with an accuracy of 0.1% of its total weight and note both the fork-length and the fresh weight of the specimen.

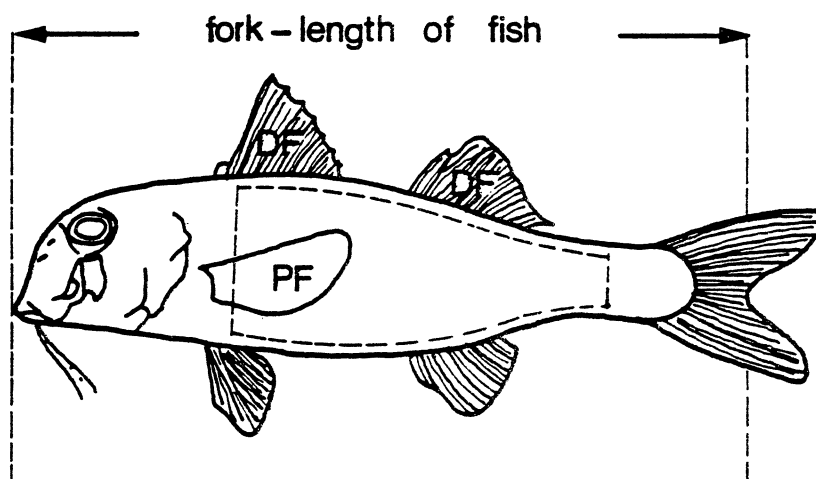

FIGURE 4 : SCHEMATIC DIAGRAM OF A FISH

(PF=pectoral fin, DF=dorsal fins, dashed line shows where the cuts should be made)

Rinse the fish with distilled water (4.1) or clean sea water (4.2) and place it on a clean working surface (5.7). Remove the pectoral fin and cut the skin of the fish with a first knife (5.6) near the dorsal fins, starting from the head to the tail (figure 4).

Cut near the gills across the body, along the ventral edge from the gills to the tail and finally across the body near the tail. These four cuts should be carried out first on one side only taking care not to cut too deep in order to avoid cutting into the viscera and thus contaminating the fillet. It is advisable that a second person hold the fish by the head and tail during this operation.

Pull the skin from the fillet with a pair of tweezers (5.8), taking care that the outer skin does not contaminate the fillet.

With a second clean knife (5.6), cut the fillet from the vertebral column (backbone) starting from the cut near the gills. Lift the fillet with a second clean pair of tweezers (5.8), so that the fillet will not touch the working surface (e.g. the Pyrex dish) or other parts of the fish.

Weigh the fillet in a clean plastic container (5.9) and note its fresh weight.

If one fillet does not yield enough material for analysis, put the fish, skin side upwards, on a clean portion of the working surface (5.3) or on a new working surface and remove the second fillet from the other side of the same fish as described above, add it to the first sample and record their total weight.

Close the container airtight. Identify the container with a code number and/or label, record all data in the protocol and deep-freeze (5.3).

This represents the "tissue sample".

Determine and note the sex of fish by examining the gonads.

NOTE: Comparing the weight of the container holding the fillet sample(s) determined at this point with the weight of the container before the digestion step will show if the tissues have lost moisture during prolonged storage.

(b) Composite sample: Start sample preparation as described for single specimen sample above taking care to record the length, the fresh weight and fillet (sample) weight of each fish separately. Determine and note by examining the gonads the sex of each specimen separately.

Reduce the fillet(s) of the large specimens to the weight of the smallest fillet. A composite sample should not contain less than 6 fillets from 6 different specimens of the same sex and size. Homogenize the fillets in a blender (5.17). Transfer the homogenate into a suitable clean container (5.9) which has been weighed empty. Close the container airtight, label it and weight the container with the homogenate. Note the weight of the homogenate together with the other data in a protocol and deep-freeze (5.3) the container.

This represents the "tissue sample".

NOTE: The concentration of trace metals in a composite sample should represent the mean value of metal concentrations of single specimens. In order to avoid overrepresentation of large specimens, only fish of similar size (age) should be used for the preparation of composite samples. In addition, the weight of the fillets of all specimens to be included in the composite sample should be reduced to that of the fillet of the smallest fish. As there might be considerable differences in the trace metal content of male and female specimens, use them in separate composite samples.

7.5 Sample preparation of large-size fish

If necessary, thaw partially, e.g. overnight in a refrigerator (-2 to 4°C), the subsample taken in the field during sampling (6.4).

Rinse the subsample with distilled water (4.1) or clean sea water (4.2) and place it on a clean working surface (5.7). Remove any skin and bone that may be present. Cut off thin slices from all surfaces with clean plastic knife (5.6) and discard them. Repeat the operation with a second clean knife (5.6) in order to obtain a clean uncontaminated block of homogeneous tissue.

NOTE: It has been recognized that differences in trace metal concentrations may exist between different muscles in large fish, therefore as much information as possible on the actual sample should be recorded.

Transfer the tissue into an airtight container (5.9), close and label it, weigh it, note all data together with data of the subsample in the protocol, and deep-freeze (5.3).

This represents the "tissue sample".

8. SAMPLING AND SAMPLE PREPARATION PROTOCOL

Fill in the sampling and sample preparation protocol (table 1) giving full details in every column. This protocol should be attached to the test report on the determination of trace metals in the analyzed sample.

The following guidelines should be kept in mind when completing the protocol (the numbers refer to those used in table 1):

1.1 Use the scientific name for the species sampled. If necessary indicate subspecies or variety.

1.2 Indicate the name under which the species is known locally.

1.3 Use any code adopted by your institution. Never use the same sample code for more than one sample.

3.2 For samples obtained on fish market, indicate the town (village) where the market is. For samples taken at standard sampling stations or areas, indicate the name (code) of the station or area.

3.3 If the sampling point does not coincide with a standard sampling station or area, it may be advisable to code (name) it, in particular when the sampling point is used more frequently (e.g. a particular fish market). Never use the same sampling point code for more than one sampling point.

3.4 and 3.5 Always indicate the longitude and latitude of the sampling point to the nearest minute. For samples obtained from fish market, enquire about their provenience and try to reflect it also as geographic co-ordinates. Circle either E or W and N or S, as appropriate.

3.6 Give any additional information which may be relevant for the interpretation of the results (e.g. sampling point in vicinity of outfalls or similar).

4.1 Indicate the difference between data given under 2 and 5.

4.2 Mark the storage conditions used. If none of them applicable, give additional explanations in 4.3.

6.2 Identify sex of the specimen whenever possible. As for specimen length, determine shell length for mussels, fork length for fish and total length for shrimp as indicated in figures 2, 3, and 4. Specimen weight always refers to the fresh weight of the whole mussel, of the whole shrimp and of the whole fish. Note that sample weight, in the case of mussels, refers to the total weight of soft tissues. In the case of shrimp, the sample weight refers only to the fresh weight of the muscle, and in the case of fish, to the fresh weight of the fillet or of the combined weight of fillets removed from the same fish.

6.3 Whenever possible use six or more specimens of the same sex and size (age) in preparing composite samples. Mean length and weight refers to the arithmetical mean of the weight and length of individual specimens, as explained above. Always calculate the standard deviations.

Table 1: Sampling and Sample Preparation Protocol

1. Sample (specimen)

1.1 Scientific name: _____

1.2 Common name: _____

1.3 Sample code: _____

2. Date of sampling: day _____; month _____; year _____

3. Sampling point

3.1 Country: _____

3.2 Type of sampling point: _____ fish market;
_____ sampling area/station

3.3 Sampling point code: _____

3.4 Longitude: _____ ° _____ ' E or W

3.5 Latitude: _____ ° _____ ' N or S

3.6 Conditions at sampling point which may be relevant for the interpretation of results:

4. Sample storage

4.1 Duration of storage: _____ hours; _____ days

4.2 Storage: deep-freezing _____; cooling _____

4.3 Factors relevant to sample storage which may be important for the interpretation of results:

5. Date of sample preparation: day _____; month _____; year _____

6. Sample preparation

6.1 Tissue type (kind) _____

6.2 Single specimen sample: sex____; specimen length_____cm;
specimen weight_____g; sample weight_____g

6.3 Composite sample:

- number of specimens _____; sex_____
- mean length of specimens_____cm; stand. dev. _____
- mean weight of specimens_____g; stand. dev. _____
- total weight of composite sample_____g
- total net weight of homogenate_____g

6.4 Factors relevant to sample preparation which may be important for the interpretation of results:

7. Full address of the institution carrying out the sampling and sample preparation:

8. Name(s) and signature(s) of the person(s) who carried out the sample preparation:

Date: _____

Appendix A

Preparing plastic tweezers

Methylmetacrylate of 4 mm thickness has been found to be very useful as it has the right elasticity. If thinner or thicker material has to be used, either the strips from which the tweezers are to be made are cut wider or narrower. The easiest way to heat the plastic and bend it is with a hot air blower used for forming plastics. A drying oven can be used also. However, it is much more difficult to make tweezers by heating the plastic in an oven since the plastic twists easily.

Materials:

- sheets of acrylic (methylmetacrylate) resin; 4 mm thick (trade names: e.g. Perspex, Flexiglas, Lucite);
- a plastic tube, about 40 mm in diameter.

Equipment:

- hot air blower (300-350°C) used for molding plastics, or Drying oven (135-140°C).

Procedure:

(a) With a hot air blower

- cut from the sheet with an electric or a hand saw strips of about 10 mm width and 250 mm length;
- heat about a 60 mm long part in the middle of the strip so that it bends easily. Bend it around the plastic tube carefully in order to make both ends meet. Cool the plastic with cold water;
- sharpen the ends with a file and roughen the inside of the tweezers so that they grip well;
- wash the tweezers carefully with detergents and rinse them with distilled water.

(b) With a drying oven

- place the plastic strip on a clean piece of wood in a drying oven (135-140°C) until it becomes soft;
- lift the strip at one end with a pair of tweezers and bend it around the plastic tube without letting the tweezer tips meet;
- cool the tips by dipping them in a beaker of clean cold water and afterwards bend the ends of the tweezer so that the tips meet;
- prepare the ends of the tweezers as described earlier.

Appendix B

Sample identification note

A standard sample identification note should contain the following data:

- sample code (the same code should be used in 1.3 of the Sampling and Sample Preparation Protocol; see table 1);
- species name (important in particular whenever storage of sample may create difficulties in determining the species);
- sampling date;
- sampling location (given as sampling point code, if possible; see 3.3 of table 1);
- collector's (sampler's) name;

Example:

AN 435
Mytillus galloprovincialis
3 March 1982
F 17
D. Degobbis

Issued and printed by:



Regional Seas Programme Activity Centre
United Nations Environment Programme

Additional copies of this and other publications issued by
the Regional Seas Programme Activity Centre of UNEP can be
obtained from:

Regional Seas Programme Activity Centre
United Nations Environment Programme
Palais des Nations
GENEVA
Switzerland

Annex III:

HELCOM

Manual for marine monitoring in the COMBINE programme.

**ANNEX B-12 Technical note on the determination of heavy metals and persistent organic
compounds in biota.**



ANNEX B-12 TECHNICAL NOTE ON THE DETERMINATION OF HEAVY METALS AND PERSISTENT ORGANIC COMPOUNDS IN BIOTA

- Appendix 1. Technical note on biological material sampling and sample handling for the analysis of persistent organic pollutants (PAHs, PCBs and OCPs) and metallic trace elements
- Appendix 2. Technical note on the determination of polycyclic aromatic hydrocarbons in biota
- Appendix 3. Technical note on the determination of chlorinated biphenyls and organochlorine pesticides in biota
- Appendix 4. Technical note on the determination of trace metallic elements in biota
- Appendix 5. Technical note on the determination of total mercury in marine biota

ANNEX B-12, APPENDIX 1. TECHNICAL NOTE ON BIOLOGICAL MATERIAL SAMPLING AND SAMPLE HANDLING FOR THE ANALYSIS OF PERSISTENT ORGANIC POLLUTANTS (PAHS, PCBs AND OCPS) AND METALLIC TRACE ELEMENTS

1. GENERAL PRINCIPLES

Muscle tissue or liver of fish have to be dissected while they are in good condition. If biological tissue deteriorates, uncontrollable losses of determinands or cross-contamination from other deteriorating tissues and organs may occur. To avoid this, individual fish specimens must be dissected at sea if adequate conditions prevail on board, or be frozen immediately after collection and transported frozen to the laboratory, where they are dissected later.

If the option chosen is dissection on board the ship, two criteria must be met:

1. The work must be carried out by personnel capable of identifying and removing the desired organs according to the requirements of the investigations; and
2. There must be no risk of contamination from working surfaces or other equipment.

2. TOOLS AND WORKING AREA

Crushed pieces of glass or quartz knives, and scalpels made of stainless steel or titanium are suitable dissection instruments.

Colourless polyethylene tweezers are recommended as tools for holding tissues during the dissection of biological tissue for metallic trace element analysis. Stainless steel tweezers are recommended if biological tissue is dissected for analysis of chlorinated biphenyls (PCBs), organochlorine pesticides (OCPs) and polynuclear aromatic hydrocarbons (PAHs). After each sample has been prepared, including the samples of different organs from the same individual, the tools should be changed and cleaned.

The following procedures are recommended for cleaning tools used for preparing samples:

1) for analysis of metallic trace elements

- a) Wash in acetone or alcohol and high purity water.
- b) Wash in HNO₃ (p.a.) diluted (1+1) with high purity water. Tweezers and haemostates in diluted (1+6) acid.

- c) Rinse with high purity water.

2) for analysis of CBs and OCPs

- a) Wash in acetone or alcohol and rinse in high purity water.

The glass plate used during dissection should be cleaned in the same manner. The tools must be stored dust-free when not in use.

The dissection room should be kept clean and the air should be free from particles. If clean benches are not available on board the ship, the dissection of fish should be carried out in the land-based laboratory under conditions of maximum protection against contamination.

3. FISH MUSCLE AND LIVER SAMPLES DISSECTION

For fish analysis, commercial catches can be used if fish transport to the laboratory does not take longer than 24 hours. The fish must be transported on ice. The dissection then takes place at the laboratory.

For analysis of **fish muscle**, the epidermis and subcutaneous tissue should be carefully removed from the fish. Samples should be taken under the red muscle layer. In order to ensure uniformity of samples, the **right side dorso-lateral muscle** should be taken as the sample. If possible, the entire right dorsal lateral filet should be used as a uniform sample, from which subsamples can be taken after homogenizing for replicate dry weight and contaminant determinations. If, however, the amount of material obtained by this procedure is too large to handle in practice, a specific portion of the dorsal musculature should be chosen for the sample. It is recommended that the portion of the muscle lying directly under the first dorsal fin should be utilised in this case. As both fat and water content vary significantly in the muscle tissue from the anterior to the caudal muscle of the fish (Oehlschläger, 1994), it is important to obtain the same portion of the muscle tissue for each sample.

To sample **liver tissue**, the liver must be identified in the presence of other organs such as the digestive system or gonads (Harms and Kanisch, 2000). The appearance of the gonads will vary according to the sex of the fish and the season. After opening the body cavity with a scalpel, the connective tissue around the liver should be cut away and as much as possible of the liver is cut out in a single piece together with the gall bladder. The bile duct is then carefully clamped and the gall bladder dissected away from the liver.

When fish samples which have been frozen at sea are brought to the laboratory for analysis, they should be dissected as soon as the tissue has thawed sufficiently. The dissection of fish is easiest when the material, at least the surface layers of the muscle tissue, is half frozen. For dissection of other organs, the thawing must proceed further, but it is an advantage if, for example, the liver is still frozen. It must be noted that any loss of liquid or fat due to improper cutting or handling of the tissue makes the determinations of dry weight and fat content, and consequently the reported concentrations of determinands, less accurate.

After muscle preparations, the liver should be completely and carefully removed while still partly frozen to avoid water and fat loss. Immediately after removing it from the fish, the liver should be returned to the freezer so that it will be completely frozen prior to further handling. This is particularly important for cod liver.

4. SHELLFISH SAMPLING

The blue mussel (*Mytilus edulis*) occurs in shallow waters along almost all coasts of the Baltic Sea. It is therefore suitable for monitoring in near shore waters. No distinction is made between

M. edulis, *M. galloprovincialis*, and *M. trossulus* because the latter species fills a similar ecological niche. A sampling size range of 20–70 mm shell length is specified to ensure availability throughout the whole maritime area.

Two alternative sampling strategies can be used: sampling to minimise natural variability and length-stratified sampling. Only details of length-stratified sampling are described in this document, as this strategy is used in monitoring programmes for temporal trends of contaminants in biota.

For shellfish, the upper limit of shell length should be chosen in such a way that at least 20 mussels in the largest length interval can easily be found. The length stratification should be determined in such a way that it can be maintained over many years for the purposes of temporal trend monitoring. The length interval shall be at least 5 mm in size. The length range should be split into at least three length intervals (small, medium, and large) which are of equal size after log transformation.

Mussels are collected by a bottom grab and selected onboard. The number of specimens selected for analysis depends on their length, e.g. 80-100 individuals are necessary to suffice material within the length range 4-5 cm.

5. STORAGE OF FISH AND MUSSEL SAMPLES

Material from single fish specimens should be packaged and stored individually.

- Samples for analysis of metallic trace elements can be stored in polyethylene, polypropylene, polystyrene or glass containers.
- Samples for analysis of CBs and OCPs should be packaged in precleaned aluminium foil or in precleaned glass containers.

Liver tissue can deteriorate rather rapidly at room temperature. Consequently, samples should be frozen as soon as possible after packaging. They can be frozen rapidly by immersion in liquid nitrogen or blast freezing, but both these techniques need care. Whatever system is used, freezing a large bulk of closely packed material must be avoided. The samples in the centre will take longer to cool and will therefore deteriorate more than those in the outer layer.

Once frozen, samples can be stored in a deep freezer at temperatures of -20°C or below.

Frozen liver tissue should not be stored longer than six months, while lean muscle tissue can be stored up to two years. Each sample should be carefully and permanently labelled. The label should contain at least the sample's identification number, the type of tissue, and the date and location of sampling.

Mussels should be shucked live and opened with minimal tissue damage by detaching the adductor muscles from the interior of at least one valve. The soft tissues should be removed and homogenised as soon as possible, and frozen in glass jars at -20 °C until analysis. Mussel tissue for trace metal determination is homogenised and decomposed in a wet state while for persistent organic pollutants determination it is homogenised and water is removed by freeze-drying. Frozen liver tissue should not be stored longer than six months, while lean muscle tissue can be stored up to two years. Each sample should be carefully and permanently labelled. The label should contain at least the sample's identification number, the type of tissue, and the date and location of sampling.

REFERENCES

Harms, U.; Kanisch, G. (2000): Intra-Individual Variability of levels of lead detected in the liver of Baltic cod (*Gadus morhua*). Mar. Poll. Bull., 40 / 8, 710-712

Oehlenschläger, J. 1994. Quality assurance during sampling onboard. *In* ICES/HELCOM Workshop on Quality Assurance of Chemical Analytical Procedures for the Baltic Monitoring Programme. Ed. by G. Topping and U. Harms. Baltic Sea Environment Proceedings No. 58: 82-84.

Last updated: 29.10.2012 (Annex number changed from Annex B 13 to Annex B 12)

Annex IV:

OSPAR COMMISSION

CEMP Guidelines for Monitoring Contaminants in Biota



CEMP Guidelines for Monitoring Contaminants in Biota

(OSPAR Agreement 1999-02)

1. Introduction

1. These guidelines concern the sampling and analysis of contaminants in fish, shellfish and seabird eggs. They are suitable for hazardous substances: trace metals and organic compounds including chlorinated compounds (such as chlorobiphenyls, DDT and metabolites, HCH isomers, HCB and dieldrin), parent and alkylated PAHs, brominated flame retardants such as polybrominated diphenyl ethers (PBDEs) and hexabromocyclododecane (HBCD), perfluorinated compounds (PFCs), organotin compounds (TBT and its breakdown products), dioxins, furans and dioxin-like PCBs. Technical details relating to sampling, analysis, QA and reporting are given in Technical Annexes 1 and 3-9 (organic contaminants) and Technical Annex 2 (metals).

2. Purposes

2. Monitoring of contaminants in marine biota in the North-east Atlantic Ocean is performed within the framework of OSPAR as the regional convention for the protection of the marine environment of this area. The objectives of monitoring and assessment are described in the Joint Assessment and Monitoring Programme (JAMP) under the Hazardous Substances Strategy, providing the basis for the monitoring programme of chemicals for priority action, and hazardous substances in general, and addressing the following issues (see JAMP Theme H):

- a. What are the concentrations of hazardous substances in the marine environment? Are those hazardous substances monitored at, or approaching, background levels for naturally occurring substances and close to zero for man-made substances? How are the concentrations changing over time? Are the concentrations of either individual substances or mixture of substances such that they are not giving rise to pollution effects?
- b. What are the sources, what are the levels of discharges, emissions and losses and what are the pathways to the marine environment for individual OSPAR chemicals for priority action and other hazardous substances listed by e.g. the Stockholm Convention and the MSFD? Are the discharges, emissions and losses from sources of these substances to the marine environment continuously decreasing, and are they moving towards the target of cessation?

3. The existing level of marine contamination in different parts of the convention area can be assessed by spatial distribution monitoring. Monitoring contaminant concentrations in fish, shellfish and seabird eggs can be used to indicate large-scale regional differences in contamination.

4. The measured levels can be compared to background or close to background reference conditions as well as to levels describing the thresholds above which negative effects on living resources and marine life are expected. OSPAR monitoring can assist member states of the European Union to fulfil their obligations under relevant EU-directives, namely the Marine Strategy Framework Directive (MSFD, 2008/56/EC) and the Water Framework Directive (WFD, 2000/60/EC) and related directives like the WFD daughter directive on Environmental Quality Standards in the field of water

policy (2008/105/EC), to assess whether certain regions or sub-regions, have reached or failed to reach Good Environmental Status.

5. The effectiveness of measures taken for the reduction of marine contamination can be assessed by performing trend monitoring. Changes in contaminant inputs are reflected in the concentrations of contaminants in biota over time. The statistical assessment of a trend over a longer period also supplies a more reliable assessment for the status within a certain period or the last measured year and therefore also for the assessment of the actual status, as the within and between year variability is thereby taken into account.

6. An integrated approach is needed to assess harm to living resources and marine life. The role of chemical measurements in integrated chemical and biological effects monitoring programmes is:

- i. to identify sites where contaminant-specific biological effects programmes should be applied;
- ii. to investigate the chemical cause of observed biological effects;
- iii. How to improve and extend OSPAR's monitoring framework and better link it with the understanding of biological effects and ecological impacts of individual substances and the cumulative impacts of mixtures of substances.

3. Quantitative objectives

3.1 Temporal trends

7. Before starting to interpret results from statistical time series analyses it is essential to know with what power temporal changes in concentration could be detected (*i.e.* the chances of revealing true trends in concentration within the matrices investigated). When no trend is found, it is essential to know whether this indicates a stable situation or that the sampling strategy is too poor to detect even major changes in the contaminant load to the environment. One approach for solving this problem would be to estimate the power of the time series based on the 'random' between-year variation. Alternatively the lowest detectable trend could be estimated at a fixed power to represent the sensitiveness of the time series. It should be stressed that the power estimate must be interpreted with great caution. A matrix showing a very high power is not necessarily a good matrix for monitoring. If the matrix analysed does not respond to the environmental changes being monitored, the between-year variation would probably be low and consequently the power high. Another problem is that a single outlier could ruin an estimate of the between-year variation. Bearing these difficulties in mind, and as an example for the purpose of trend monitoring, the quantified objective could be stated, including the following information:

- the annual change which the programme should be able to detect
- the time period
- the power at a set significance level (α) with a one-sided test.

A typical example which has been used previously is the ability to detect an annual change of 5% within a period of 10 years at a power of 90% at a significance level (α) of 5% with a one-sided test. For many areas, however, due to the decline of contaminant concentrations which has been observed this approach is no longer realistic, so that the annual change to be detected should be lower and the time period longer, e.g. a 2% fall over a time period of 30 years.

8. The necessary or possible power of a monitoring programme will vary with the purpose of the investigation and with the contaminant, matrix and area being investigated. It is thus not possible to give fixed values for all situations. It is the duty of the programme manager to specify the size of the changes the monitoring programme is expected to identify and at what power, or for the programme executor to estimate what it is possible to achieve. It is, however, essential that the quantitative objectives are determined before any monitoring programme is started.

9. Due to the decrease of concentrations of many substances in the last two decades, for certain substances and areas it is not any longer possible to detect significant changes which can be associated with a trend. Monitoring is serving in this case for the assessment of status and to detect any deterioration. Depending on the magnitude of natural variability, it may also be possible to reduce the monitoring effort and to change from annual sampling to longer intervals without loss of relevant information.

3.2 Spatial distribution

10. A spatial distribution monitoring programme should enable Contracting Parties to determine the representativeness of their monitoring stations with regard to spatial variability in contaminant concentrations. This would include a definition of the monitoring area and some understanding of the randomness of the monitoring programme. It can also deliver information useful to distinguish between areas of different character and to define water bodies or areas which should be assessed separately. The purpose and quantitative objectives could be expressed as follows, for example:

- Purpose: to identify whether an area has elevated contaminant concentrations, possibly due to anthropogenic inputs.
- Quantitative Objective: to detect a difference of 10 µg/kg between the average contaminant concentrations in area A and the average contaminant concentrations in control area B with a power of 90%.

or

- Purpose: to map the spatial distribution of contaminants.
- Quantitative Objective: for the precision of an interpolated point on the map to be at worst 10%.

or

- Purpose: to locate "hot spots".
- Quantitative Objective: for the probability of missing a circular "hot spot" of radius 0.5 km to be no greater than 5%.

11. For more detailed information about statistical analyses of monitoring data see Nicholson *et al.*, (1997).

12. Spatial distribution monitoring is supplying relevant information for assessing different water bodies and areas both for the purposes of the EU-MSFD and the EU-WFD. Following the sampling and analytical techniques as described in this guideline and its technical annexes will assist in avoiding significantly deviating monitoring results for neighbouring regions with comparable conditions, which consequently affects the assessment of the (good) environmental status.

3.3 Qualitative objectives

13. The quantitative results will be used to perform the assessment of the status of the marine environment with regard to hazardous substances. Further information on the assessment procedure,

the classification schemes and the threshold values used for distinguishing between the different classes from e.g. unacceptable to excellent or Good Environmental Status (WFD, MSFD) being achieved or not, can be found in the relevant OSPAR agreements and EC Directives and Decisions.

4. Sampling strategy

4.1 General

14. The sampling strategy should take into account the specific objectives of the monitoring programme, including the quantitative objectives. Natural variability between the samples should be reduced by an appropriate sampling design and the performance of the analytical procedures (*i.e.* the accuracy and precision) must be adequate to meet the objectives. A preliminary/exploratory sampling programme will provide useful information prior to designing the final programme. Statistical procedures must be taken into account to estimate the number of samples and sampling sites required to achieve a satisfactory level of confidence. More guidance on this topic is given by Gilbert (1987).

15. In more exploratory studies, data may be statistically analysed in several ways for several purposes. However there should still be a clear understanding of what must be measured from what population and how the samples are to be selected. The sampling strategy is an intrinsic component of the data, and may limit their use and interpretation. Quantitative objectives for a selected primary purpose should also be established for exploratory studies.

16. When conducting an integrated chemical and biological effects sampling programme, the purpose of the chemical measurements is both to be assessed against limit values and to aid the interpretation of the biological effects measurements in terms of identifying the chemical causes of the biological effects and establishing concentration responses. In such cases, the sampling strategies used should comply with those in the biological effects monitoring guidelines and the monitoring guidelines for the relevant chemical determinands. The analytical methods used should be as specified in the relevant chemical guidelines.

17. With regard to the choice of monitoring parameters, the sampling strategy should cover the demands of as many purposes as possible for both OSPAR and the EU-MFSD, and in particular the compounds determined should address the indicators under descriptor 8 of the MSFD, the species and tissues and, where possible, the selection of sampling sites in coastal areas should also meet the requirements of the EU Water Framework Directive.

4.1.1 Species

18. Prior to monitoring, it is important to be clear about:

- the target population (e.g. cod from a specified length-range caught in a specified area at a specified time);
- the sampled population, if this differs from the target population (e.g. if fishing is restricted within particular areas);
- the sampling unit (e.g. an individual fish or pooled samples);
- the observed variable (e.g. mercury concentration on a wet weight basis in a subsample of tissue from individual fish muscle).

19. When selecting the species to be monitored for chemical contaminants, some basic prerequisites should be considered. Where possible the organisms should:

- reflect changes in the concentration of contaminants in the surrounding environment;
- for a given species, have similar bioconcentration factors throughout the Maritime Area;

- accumulate the contaminant without being seriously affected by the concentrations encountered in the marine environment;
- be representative of the study area;
- be abundant throughout the study area;
- be of reasonable size, giving adequate amounts of tissue for chemical, biochemical and physiological analyses; restrictions to this may occur on different preconditions for performing the different tests and analytical methods;

in particular for shellfish and for investigations exceeding the demands of “routine” monitoring:

- be easy to sample and hardy enough to survive in the laboratory, thus allowing:
 - defecation before analysis (if desired);
 - laboratory studies of contaminant uptake;
 - studies verifying biological field observations.

4.2 Sampling strategy for temporal trend monitoring

4.2.1 Species and sampling

20. The species of interest can only be selected in the light of information on the fish and shellfish stock and on the seabird population composition and migration pattern.

21. For fish and shellfish, sampling to minimise natural variability is the preferred strategy, see table 1. Length-stratified sampling may be maintained where it has been successfully applied in the past. Recommendations for species, size etc. are given in Table 2. Where conditions have changed such that length stratified sampling cannot be sustained any longer, or the indicator species has to be changed due to changing abundance, it will be appropriate to sample with a view to minimising natural variability within the sample.

For shellfish, a sample should be collected with the number of individuals large enough to be divided into at least 3 equal pools with each pool consisting of at least 20 animals and enough soft tissue for all analyses. The length of the individuals collected should to the extent possible, be constant from year to year at each station, or should at least fall within a very narrow range, e.g. within 5 mm. To reflect recent levels of contamination, young individuals should be chosen. In selecting the sample, care should be taken that it is representative of the population and that it can be obtained annually. Recommendations for sampling to minimise natural variability are given in Table 1. If a Contracting Party decides to change its sampling strategy, data from the old and new programmes should not be compared without first checking the compatibility of the two approaches. More detailed information about length-stratified sampling and sampling to minimise natural variability is given in Technical Annexes 1 and 2 (Agreement 1999-2).

Table 1: Sampling to minimise natural variability

Species	Number	Size ¹	Age	Sex ²	Tissue
Shellfish					
Mussel <i>Mytilus edulis</i> or <i>M. galloprovincialis</i>	3 pools of 20	Narrow length range	1-2 years	-	Whole soft body
Pacific oyster <i>Crassostrea gigas</i>		Narrow length range	2 years	-	Whole soft body
Flatfish					
Dab <i>Limanda limanda</i>	At least 12	Narrow length range	1-3 years	Single sex, females*	Muscle for Hg. Liver for all other determinands
Flounder <i>Platichthys flesus</i>	At least 12	Narrow length range	1-3 years	Single sex, females*	Muscle for Hg. Liver for all other determinands
Plaice <i>Pleuronectes platessa</i>	At least 12	Narrow length range	1-3 years	Single sex, females*	Muscle for Hg. Liver for all other determinands
Roundfish					
Cod <i>Gadus morhua</i>	At least 12	Narrow length range	Preferably 1-3years**		Muscle for Hg. Liver for all other determinands
Whiting <i>Merlangius merlangus</i>	At least 12	Narrow length range	2-3 years	Single sex, preferably females	Muscle for Hg. Liver for all other determinands
Hake <i>Merluccius merluccius</i>	At least 12	Narrow length range	2-3 years	Single sex, preferably females	Muscle for Hg. Liver for all other determinands
Herring <i>Clupea harengus</i>	At least 12	Narrow length range	1-2 years		Muscle for organic contaminants and Hg. Liver for other trace metals.
Eel pout <i>Zoarces viviparus</i>	At least 12	Narrow length range	2-3 years	Single sex, preferably females	Muscle for Hg. Liver for all other determinands
Seabird eggs					

¹ "Narrow length range" means that the length of the individuals collected should be constant from year to year at each site or should at least fall within a very narrow range. The length range could however vary between sites and hence is not specified in the table.

² The same sex should be sampled each year.

Species	Number	Size ¹	Age	Sex ²	Tissue
Common tern <i>Sterna hirunda</i>	10 ^{footnote 3}	-	1-5 days incubation	-	Whole egg content
Oyster catcher <i>Haematopus ostralegus</i>	10 ^{footnote 4}	-	1-5 days incubation	-	Whole egg content
Guillemot <i>Uria aalge</i>	10 ^{footnote 4}	-	1-5 days incubation	-	Whole egg content

* As for flatfish sex can be determined easily. If possible, only females should be chosen, as males show higher variation in age distribution and contaminant concentrations at comparable length

** Smaller fish should, if possible be selected to reflect recent influence and reduce the effects of sex, as age determination without dissection is not possible, When the amount of tissue(s) needed for all investigations within an integrated chemical and biological effects monitoring programme is not sufficient, selection of larger fish may be appropriate.

Table 2: Length-stratified sampling

Species	Number	Size (cm)	Tissue
Shellfish			
Mussel <i>Mytilus edulis</i> or <i>M. galloprovincialis</i>	3 pools of 20	3-6	Whole soft body
Pacific oyster <i>Crassostrea gigas</i>	10 ± 10%	9-14 (2 years of age)	Whole soft body
Flatfish			
Dab <i>Limanda limanda</i>	25 to 20 individuals, or 15 if justified, or 5 batches of 5 individuals	18-30	Muscle for Hg. Liver for all other determinands
Plaice <i>Pleuronectes platessa</i>	25 to 20 individuals, or 15 if justified, or 5 batches of 5 individuals	20-30	Muscle for Hg. Liver for all other determinands
Flounder <i>Platichthys flesus</i>	25 to 20 individuals, or 15 if justified, or 5 batches of 5 individuals	15-35	Muscle for Hg. Liver for all other determinands
Roundfish			
Cod <i>Gadus morhua</i>	25 to 20 individuals, or 15 if justified, or 5 batches of 5 individuals	25-40	Muscle for Hg. Liver for all other determinands
Whiting <i>Merlangius merlangus</i>	25 to 20 individuals, or 15 if justified, or 5 batches of 5 individuals	20-35	Muscle for Hg. Liver for all other determinands
Hake <i>Merluccius merluccius</i>	25 to 20 individuals, or 15 if justified, or 5 batches of 5 individuals	20-35	Muscle for Hg. Liver for all other determinands

³ One egg taken randomly from each of 10 clutches.

⁴ The eggs should be collected as early as possible to avoid collecting replacement eggs.

4.2.2 Sampling area

Fish

22. To improve the power of the programme, samples should be collected from areas characterised by relatively low natural variability. The spatial representativeness of the area should be known.

Shellfish

23. The spatial representativeness of the area should be known. Samples should preferably be collected from sub-tidal regions, otherwise as near to the low water spring tide level as possible. They should be collected as near to the same depth and exposure (i.e. in terms of light and wave action) as possible in order to reduce variability in contaminant uptake. The boundary of the sampling site must be specified. At locations where suitable natural populations are not available, caged mussels may be used.

Seabird eggs

24. Sampling sites should reflect important breeding areas. To collect the necessary number of eggs over the period of the monitoring programme sampling sites should be chosen where sufficient numbers of pairs of birds can be expected to breed for the required number of years.

4.2.3 Sampling frequency

25. Sampling should be annual. In cases where no trend can still be observed, no local source is influencing the sampling site and natural variability is the dominant reason for variations in concentrations, it may also be possible to reduce the monitoring effort and to change from annual sampling to longer intervals.

4.2.4 Sampling period

Fish

26. Sampling should take place when fish are in a stable physiological state and, in any case, outside the period of spawning. See Table 3 for further guidance. Sampling should take place within a fixed time span each year (e.g. mid August-mid October for fish in the southern North Sea).

Shellfish

27. Sampling should take place during late autumn/early winter, when mussels are in a more stable physiological status, and in any case during a period before spawning. Gametogenesis and spawning generally occur in late spring to early summer, when individuals may lose up to 50% of their soft tissue weight. Table 3 give guidance on spawning periods.

Seabird eggs

28. Eggs should be sampled during the species-specific, year-specific and site-specific peak of the first laying cycle within the year. This generally occurs in May/June. Only fresh eggs should be taken from full clutches. For each species, site and year, 10 eggs should be sampled with one egg taken randomly from each of 10 clutches from the first laying cycle within the year.

4.3 Sampling strategy for spatial distribution monitoring

29. For each spatial distribution programme, the species and sampling strategy, including quantitative objectives, should be clearly defined to ensure that the purpose of the programme is fulfilled.

4.3.1 Species and sampling

30. Table 4 gives the recommended species and number of fish, shellfish and seabird eggs, the size of individual fish and shellfish and the tissue type. However, the number of fish and the number of stations as well as whether individuals or pooled samples should be analysed will depend on the specific objectives of the monitoring programme. In order to reduce the number of analyses which must be performed, pooled samples may be used. Additional, more specific, guidelines on the treatment of samples may need to be prepared by the programme managers.

Table 3: Time of spawning season. Spawning season varies regionally due to climate conditions and in the case of fish it is recommended to use FishBase (<http://www.fishbase.org/search.php>) in order to find the specific spawning time for a particular sea area.

Species	Spawning season	Reference
Shellfish		
Mussel		
<i>Mytilus edulis</i>	Spawning throughout the year but normally peaks in springtime and autumn	http://www.ukmarinesac.org.uk/communities/biogenic-reefs/br4_4.htm
<i>M. galloprovincialis</i>		
Pacific oyster	Summer months (above 20 °C)	http://www.fao.org/fishery/culturedspecies/Crassostrea_gigas/en
<i>Crassostrea gigas</i>		
Flatfish		
Dab		
<i>Limanda limanda</i>	January-August	http://www.fishbase.org/Reproduction/SpawningList.php?ID=695&GenusName=Limanda&SpeciesName=limanda&fc=440&StockCode=711
Plaice		
<i>Pleuronectes platessa</i>	January-June	http://www.fishbase.org/Reproduction/SpawningList.php?ID=1342&GenusName=Pleuronectes&SpeciesName=platessa&fc=440&StockCode=1360
Flounder		
<i>Platichthys flesus</i>	January-June	http://www.fishbase.org/Reproduction/SpawningList.php?ID=1341&GenusName=Platichthys&SpeciesName=flesus&fc=440&StockCode=1359
Roundfish		
Cod		
<i>Gadus morhua</i>	⁵	http://www.fishbase.org/Reproduction/SpawningList.php?ID=69&GenusName=Gadus&SpeciesName=morhua&fc=183&StockCode=79

⁵ Please use information on the actual timing of spawning in your sampling area. It is recommended to use Fishbase www.fishbase.org:

Whiting <i>Merlangius merlangus</i>	January-September	http://www.fishbase.org/Reproduction/SpawningList.php?ID=29&GenusName=Merlangius&SpeciesName=merlangus&fc=183&StockCode=39
Hake <i>Merluccius merluccius</i>	December-August	http://www.fishbase.org/Reproduction/SpawningList.php?ID=30&GenusName=Merluccius&SpeciesName=merluccius&fc=184&StockCode=40

Table 4: Spatial distribution sampling

When monitoring for trends at various sites, refer to tables 1 and 2

Species	Recommended Number	Size (cm)	Tissue
Shellfish			
First choice Mussel <i>Mytilus edulis</i> or <i>M. galloprovincialis</i>	50 ^{footnote 4} ± 10%	3-6	Whole soft body
Second choice ¹ Pacific oyster <i>Crassostrea gigas</i>	10 ^{footnote 4} ± 10%	9-14 (2 years of age)	Whole soft body
Flatfish			
First choice Dab <i>Limanda limanda</i>	20 to 25 individuals, or 15 if justified, or 5 batches of 5 individuals	18-30	Muscle for Hg. Liver for all other determinands
Second choice ¹ Flounder <i>Platichthys flesus</i>	20 to 25 individuals, or 15 if justified, or 5 batches of 5 individuals	15-35	Muscle for Hg. Liver for all other determinands
Roundfish			
First choice Cod <i>Gadus morhua</i>	20 to 25 individuals, or 15 if justified, or 5 batches of 5 individuals	>20	Muscle for Hg. Liver for all other determinands
Second choice ¹ Whiting <i>Merlangius merlangus</i>	20 to 25 individuals, or 15 if justified, or 5 batches of 5 individuals	20-35	Muscle for Hg. Liver for all other determinands
Hake <i>Merluccius merluccius</i>	20 to 25 individuals, or 15 if justified, or 5 batches of 5 individuals	20-35	Muscle for Hg. Liver for all other determinands
Seabird eggs			
Common tern <i>Sterna hirunda</i>	10 ^{footnote 2}	-	Whole egg content

<http://www.fishbase.org/Reproduction/SpawningList.php?ID=69&GenusName=Gadus&SpeciesName=morhua&fc=183&StockCode=79>

Oyster catcher <i>Haematopus ostralegus</i>	10 ^{footnote 2}	-	Whole egg content
Guillemot <i>Uria aalge</i>	10 ^{footnote 3}	-	Whole egg content

¹ Where first choice species is not available.

² One egg taken randomly from each of 10 clutches.

³ The eggs should be collected as early as possible to avoid collecting replacement eggs.

⁴ The number of specimens can be adjusted upwards to assure ample sample material for the expected analysis, depending on the actual size class available.

4.3.2 Sampling area

Fish

31. Samples should be collected from as many locations as necessary to fulfil the objectives of the programme, taking into account the representativeness of the area with regard to spatial variability in contaminant concentrations.

Shellfish

32. Samples should be collected from as many locations as necessary to fulfil the objectives of the programme, taking into account the representativeness of the area with regard to spatial variability in contaminant concentrations. Samples should preferably be collected from sub-tidal regions, otherwise as near to the low water spring tide level as possible. They should be collected as near to the same depth and exposure (i.e. in terms of light and wave action) as possible in order to reduce variability in contaminant uptake. The boundary of the sampling site must be specified. At those locations where suitable natural populations are not available, caged mussels may be used.

Seabird eggs

33. Sampling sites should reflect important breeding areas. To collect the necessary number of eggs over the period of the monitoring programme sampling sites should be chosen where sufficient numbers of pairs of birds can be expected to breed for the required number of years. Both coastal sites adjacent to the open sea and known “hot spots” such as estuaries should be included.

4.3.3 Sampling period

Fish

34. Sampling should take place when fish are in a stable physiological state and, in any case, outside the period of spawning. See Table 3 for further guidance.

Shellfish

35. Sampling should take place during late autumn/early winter when mussels are in a more stable physiological state and, in any case, during a period before spawning. Gametogenesis and spawning generally occur in late spring to early summer, when individuals may lose up to 50% of their soft tissue weight. Table 3 give guidance on spawning periods.

Seabird eggs

36. Eggs should be sampled during the species-specific, year-specific and site-specific peak of the first laying cycle within the year. This generally occurs in May/June. Only fresh eggs should be taken

from full clutches. For each species, site and year, 10 eggs should be sampled with one egg taken randomly from each of 10 clutches from the first laying cycle within the year.

4.4 Sampling strategy for biological effects monitoring

37. The sampling strategy will, in all cases, depend on the biological effect(s) to be studied. No general guidelines can therefore be given. For more details see specific guidelines (References: OSPAR Guidelines for General Biological Effects Monitoring. OSPAR Ref. No. 1997-7 and Guidelines for contaminant specific biological effects monitoring. OSPAR Ref. No. 2008-9).

5. Field sampling and sampling equipment

5.1 Fish

38. Fish can be sampled from either research vessels or commercial vessels. The former is the preferred option, since research vessels are likely to have better facilities for processing and storing scientific samples. In both cases, the following precautions must be taken when selecting samples from the trawl catch to ensure that contamination is kept to a minimum:

- trained personnel must be present when a trawl comes on board to ensure that the sample can be isolated from possible sources of contamination during the release of fish from the net;
- fish which are visibly damaged or in bad condition must not be selected;
- clean containers should be available on deck to hold the samples temporarily before they are taken to the ship's laboratory. Containers used for holding fish collected from the ship's normal trawling operations must not be used;
- personnel must wear clean gloves when the samples are taken from the net. The samples should be transferred to the ship's laboratory as quickly as possible and rinsed with clean sea water to remove any material adhering to the surface;
- equivalent precautions should be taken on modern fisheries research vessels, when the catch is released from the net directly into facilities below deck;
- only material suitable for the subsequent analyses should be retained for storage (see Technical Annexes 1 and 2 for guidance on appropriate storage containers).

39. Suitable fishing gear should be used to ensure that the catch reflects the target population. The trawling time should not exceed one hour and the trawling speed should be as slow as possible to reduce damage and stress to the fish. Details of the requirements for recording the relevant sampling parameters are given in Technical Annexes 1 and 2.

5.2 Shellfish

40. Only those individuals that are free of fouling and bored shells should be sampled. When collecting mussels by ship, a commercial mussel dredge can be used. When collecting mussels by hand, personnel should wear gloves. Clean containers consisting of material suitable for the subsequent

analyses should be used for transportation. Details of the requirements for recording the relevant sampling parameters and information on sampling methods are given in Technical Annexes 1 and 2.

5.3 Seabird eggs

41. The equipment required, details of the requirements for recording the relevant sampling parameters, and information on sampling methods are specified in Technical Annexes 1 and 2.

6. Storage and pre-treatment

42. Samples should be analysed as soon as practicable after sampling in order to obtain reliable results. Experience has shown that freezing will degrade soft tissues. Long-term storage and samples for biological effects studies therefore require special conditions. Further advice on archiving and storage techniques used in maintaining biological tissues and other environmental samples for future contaminant analyses can be found in Technical Annexes 1 and 2 and in Tema Nord (1995). Details of the requirements for recording the storage and pre-treatment parameters are given in Technical Annexes 1 and 2.

6.1 Fish

43. If conditions allow, samples should be dissected immediately after collection; sub-samples of particular tissue should be removed and deep-frozen. Freezing undissected fish, particularly large ones, may cause soft tissues to degrade and may result in uncontrollable losses of the determinands in the tissue or cross-contamination from other deteriorating tissues. When there are no shipboard laboratories suitable for processing work, warranting the necessary precautionary conditions or personnel on board are not trained for such work, samples of ungutted fish should be preserved by deep freezing, preferably shock freezing to -20°C or lower as soon as practicable after collection. Sub-samples for enzymatic tests to be performed in parallel with contaminant analysis, must be stored in liquid nitrogen and analysed as soon as possible after the cruise. Only materials appropriate for the intended analytical techniques should be retained for storage (see Technical Annexes 1 and 2).

44. When pooling samples, an equivalent quantity of tissue must be taken from each fish, *e.g.* a whole fillet from every fish. If the total quantity of tissue obtained would be too large to be handled conveniently, the tissue may be sub-sampled, but a fixed proportion of each tissue must then be taken, *e.g.* 10% of the whole fish for muscle or 10% of each whole liver. This may cause an increase in the inter-individual variability, as contaminants are not equally distributed across the entire tissue. So the sub-sample should be taken from the same part of the organ/muscle of each individual.

6.2 Shellfish

45. Mussels should be depurated prior to preservation and analysis. This is to facilitate the discharge of unassimilated particles in the mantle cavity or the gut that might contaminate the sample. This is especially important for mussels collected in water with high turbidity or on silt/clay bottoms. Whether or not the sample has been depurated prior to storage and analysis should be reported. Mussels should be shucked while still alive and opened with minimum tissue damage. The soft tissue samples should be analysed immediately or stored at temperatures below -20°C.

6.3 Seabird eggs

46. To avoid deterioration, eggs should be frozen soon after collection and transported frozen to the laboratory. Details of the preparation of the eggs for subsequent chemical analysis are described in Technical Annexes 1 and 2.

7. Analytical procedures

47. Details of the requirements for recording the relevant parameters are given in Technical Annexes 1 and 2.

7.1 Organic contaminants

48. Procedures for the analysis of organic contaminants in biota include homogenisation, drying, extraction with organic solvents, removal of lipids, clean up, fractionation, followed by separation and detection of single compounds by means of gas chromatography with electron capture (GC-ECD) or mass-spectrometry (GC-MS, GC-MSⁿ) or lipid chromatography coupled with mass-spectrometry (LC-MS, LC-MSⁿ). The total fat weight should be determined, where sufficient material is available. The extractable lipid weight should also be determined on the extract used for organohalogen compound analyses. For tissue containing more than 10-15% of lipids, the results of both total fat and extractable lipid weight are comparable within acceptable limits. Particularly for small amounts of tissue available for analysis, sharing the sample for separate fat determination may result in an insufficient amount for the determination of the analytes and so should be avoided.

Results should be reported on a wet weight basis, along with the total fat and/or extractable lipid weight (in percentage). This will make it possible to recalculate values on both fat and lipid bases. Detailed information is given in Technical Annex 1.

7.2 Metals

49. Analysis of trace metals in biota generally includes homogenisation, drying, decomposition, dissolution, matrix separation and detection using element-specific spectrometric instrumental procedures (*e.g.* AAS, ICP-OES, ICP-MS, TXRF,). Recently developed spectrometric devices aim to reduce the often costly and time consuming sample preparation by applying direct methods without preceding matrix separation and decomposition steps. The results should be reported on a wet weight basis along with the dry weight percentage. Detailed information is given in Technical Annex 2.

8. Quality assurance

50. Quality assurance (QA) is the relevant part of the work related to all procedures from sampling to the final instrumental analytical measurement, within a quality management system required to ensure the consistent delivery of quality controlled information. All procedures must be evaluated and controlled on a regular basis. For this purpose a QA scheme must be established in each laboratory. This includes participation in inter laboratory proficiency testing schemes, preferably at an international level, to ensure the long-term stability of the laboratory's performance, the use of reference materials and the maintenance of all required documentation.

51. To minimise the risk of contamination or the loss of determinands during sampling, storage, pre-treatment or analysis (and so to avoid the generation of false data) QA measures should be applied to the sample from first contact to final measurement and data reporting. All detailed QA data should

be recorded in accordance with the QA procedures laid down in the relevant documents. Laboratories should work according to EN 17025.

9. Data reporting

52. Data reporting, including QA information, should be in accordance with the requirements set by the relevant OSPAR bodies to ensure that all information for the assessment procedure to be applied are available, and using the latest ICES reporting formats to ensure an efficient and controlled data storage and processing procedure. Information on the ICES data base is available via the ICES-Website (see references).

10. References

EC, 2000. Directive 2000/60/EC of the European Parliament and of the Council of 23 October 2000 establishing a framework for Community action in the field of water policy. Official Journal of the European Communities L 327/1-72.

<http://eur-lex.europa.eu/LexUriServ/LexUriServ.do?uri=OJ:L:2000:327:0001:0072:EN:PDF>

EC, 2008. Directive 2008/105/EC of the European Parliament and of the Council of 16 December 2008 on environmental quality standards in the field of water policy, amending and subsequently repealing Council Directives 82/176/EEC, 83/513/EEC, 84/156/EEC, 84/491/EEC, 86/280/EEC and amending Directive 2000/60/EC of the European Parliament and of the Council. Official Journal of the European Union L 348/84-97

EC, 2008. Directive 2008/56/EC of the European Parliament and of the Council of 17 June 2008 establishing a framework for community action in the field of marine environmental policy (Marine Strategy Framework Directive). Official Journal of the European Union L164/19-40.

<http://eur-lex.europa.eu/LexUriServ/LexUriServ.do?uri=OJ:L:2008:164:0019:0040:EN:PDF>

EC, 2010. Report on the recommendations for the Good Environmental Status of European Seas regarding contaminants and pollution effects under the Marine Strategy Framework Directive. MSFD GES Task Group 8

Gilbert, R.O., 1987. Statistical Methods for Environmental Pollution Monitoring. Van Nostrand Reinhold, New York.

ICES: Data submenu under: ICES: <http://www.ices.dk/indexfla.asp>

Nicholson, M.D., Fryer, R.J. and Larsen, J.R., 1997. A Robust Method for Analysing Contaminant Trend Monitoring Data. ICES Techniques in Marine Environmental Sciences, No. 20. 12 pp.

OSPAR, 2010: Joint Assessment and Monitoring Programme 2010 – 2014. OSPAR Agreement 2010-4

OSPAR, 2009: Background Document on CEMP Assessment Criteria for the QSR 2010. Publication No. 461978-1-907390-08-1

OSPAR, 2008: CEMP Assessment Manual: Co-ordinated Environmental Monitoring Programme Assessment Manual for contaminants in sediment and biota. Publication No. 377978-1-906840-18-1

Tema Nord, 1995. Manual for Nordic Environmental Specimen Banking.

Annex V:

References

Annex V : References

1. EC (2010). Guidance Document No: 25 Guidance on chemical monitoring of sediment and biota under the Water Framework Directive
2. EC (2014). Guidance Document No: 32 Guidance on biota monitoring under the Water Framework Directive
3. EC Council Regulation No 1967/2006 concerning management measures for the sustainable exploitation of fisheries resources in the Mediterranean Sea
4. EC Directive 2008/105/EC (2008) on environmental quality standards in the field of water policy, amending and subsequently repealing Council Directives 82/176/EEC, 83/513/EEC, 84/156/EEC, 84/491/EEC, 86/280/EEC and amending Directive 2000/60/EC of the European Parliament and of the Council
5. Galgani, F., Chiffolleau, J.F., Barrah, M., Drebika, U., Tomasino, C., Andral, B. (2014). Assessment of heavy metal and organic contaminants levels along the Libyan coast using transplanted mussels (*Mytilus galloprovincialis*). *Environ. Sci. Pollut. Res.* 21, 11331–11339. <https://doi.org/10.1007/s11356-014-3079-1>.
6. Galgani, F., Martínez-Gómez, C., Giovanardi, F., Romanelli, G., Caixach, J., Cento, A., Scarpato, A., BenBrahim, S., Messaoudi, S., Deudero, S., Boulahdid, M., Benedicto, J., Andral, B. (2011). Assessment of polycyclic aromatic hydrocarbon concentrations in mussels (*Mytilus galloprovincialis*) from the western basin of the Mediterranean Sea. *Environ. Monit. Assess.* 172 (1–4), 301–317. <https://doi.org/10.1007/s10661-010-1335-5>.
7. HELCOM (2012). Annex B-12, Appendix 1. Technical note on biological material sampling and sample handling for the analysis of persistent organic pollutants (PAHs, PCBs and OCPs) and metallic trace elements
8. ICES/OSPAR (2018). CEMP Guidelines for Monitoring Contaminants in Biota. Technical Annexes: 1) organic contaminants; 2) metals; 3) parent and alkylated PAHs; 8) chlorobiphenyls
9. UNEP/MAP (2019a). UNEP/MED WG.467/5. IMAP Guidance Factsheets: Update for Common Indicators 13, 14, 17, 18, 20 and 21: New proposal for candidate indicators 26 and 27
10. UNEP (2019b). UNEP/MED WG.463/6. Monitoring Protocols for IMAP Common Indicators related to pollution
11. UNEP (2019c) UNEP/MED WG.467/8. Data Standards and Data Dictionaries for Common Indicators related to pollution and marine litter.
12. US EPA (2000). Guidance for Assessing Chemical Contaminant Data for Use in Fish Advisories Volume 1 Fish Sampling and Analysis. Third Edition.

Appendix 19

Monitoring Guidelines/Protocols for Sample Preparation and Analysis of Marine Biota for IMAP Common Indicator 17: Heavy and Trace Elements and Organic Contaminants

1. Introduction

1. Marine biota uptake contaminants from the marine environment through food and the water medium (breathing, skin exchange). Depending on their physicochemical properties and the organism's metabolism, contaminants may be bioaccumulated in the organism's body and, in some cases (such as Hg and persistent organic pollutants), they may be biomagnified in the top levels of the marine food chain. Since the establishment of the UNEP/MAP – MED POL Monitoring programme in 1981 (MED POL Phase II), the benthic fish *Mullus barbatus* and the bivalve *Mytilus galloprovincialis* have been used as sentinel species to assess the accumulation of contaminants in marine organisms of the Mediterranean Sea. In the framework of the Integrated Monitoring and Assessment Programme (IMAP) Common Indicator 17 (CI17), the same organisms are recommended for analysis, namely the benthic fish *Mullus barbatus* (muscle tissue) and the bivalves *Mytilus galloprovincialis* or *Donnax trunculus* (whole body). Parties may decide to include in their national monitoring programmes the collection and analysis of additional species of national interest. In all cases, contaminants data, along with relevant metadata, have to be reported to the UNEP/MAP Secretariat using the appropriate format.

2. Both organisms are encountered in the coastal marine environment and are absent in the offshore marine areas. Therefore, they cannot be used as sentinel organisms to assess the impact of contaminants in the offshore marine environment. For such offshore areas, appropriate sentinel species to be used for pollution assessment, will be designated by Parties at a later stage.

3. In line with IMAP requirements (UNEP 2019a²⁶², UNEP 2019b²⁶³), mandatory contaminants to be analysed in the muscle of fish and the whole body of bivalves include: heavy metals (Cadmium (Cd), Lead (Pb) and Mercury (Hg)), organochlorinated compounds (PCBs, hexachlorobenzene, lindane and ΣDDTs) and Polycyclic Aromatic Hydrocarbons (US EPA 16 Reference PAHs compounds). Also, additional parameters should be measured, such as: length, sex, and total wet weight of organism, as well as lipid content of the tissue to be analysed.

4. Heavy metals and organic contaminants are encountered in marine biota at trace levels (ng/kg - mg/kg); therefore, it is of paramount importance to avoid cross contamination from the laboratory environment (dust particles and the analyst), from sample containers or packing materials, from instruments used during sample pre-treatment and sample preparation, and from the chemical reagents used for analysis. Accordingly, sample handling and analysis should be made in a clean laboratory, to eliminate cross contamination and to control the total analytical blank. To that purpose, if the laboratory is not specifically designed as “clean lab” (class 100 US Federal Standard 209), it has to be equipped with appropriate laminar flow rooms, clean benches, and fume hoods, specifically designed for trace metal analysis.

5. The UNEP/MAP Proposed assessment criteria (Background Assessment Criteria - BAC and Environmental Assessment Criteria - EAC) for targeted heavy metals and organic contaminants in fish and bivalves are presented in the Annex XIV.

6. The Protocols on of this Guidelines, as provided here-below, aim at streamlining marine biota sample preparation and analysis for heavy metals and organic contaminants, including step-by-step guidance on the methods to be applied in the Mediterranean area for sample preparation and analysis of marine biota tissues for the determination of heavy metals and organic contaminants, in a view of assuring comparable quality assurance of the data, as well as comparability between sampling areas in different national monitoring programmes. They are not intended to be analytical training manuals, but guidelines for Mediterranean laboratories, which should be tested and modified in order to validate their final results.

²⁶² (UNEP 2019a). UNEP/MED WG.467/5. IMAP Guidance Factsheets: Update for Common Indicators 13, 14, 17, 18, 20 and 21: New proposal for candidate indicators 26 and 27;;

²⁶³ UNEP (2019b). UNEP/MED WG.463/6. Monitoring Protocols for IMAP Common Indicators related to pollution; UNEP/MAP (2019)

7. In order to avoid unnecessary repetitions, reference is also made to the protocols already published and publicly accessible, which can also be used by the Contracting Parties' competent laboratories participating in IMAP implementation. Namely, here-below elaborated IMAP Protocols build on previous UNEP/MAP - IAEA Recommended Methods, for the analysis of heavy metals and organic contaminants, such as: IAEA (2011a) IAEA (2011) Recommended method on microwave digestion of marine samples for the determination of trace element content (Annex I); IAEA (2011b) Recommended method for the determination of selected trace element in samples of marine origin by flame atomic absorption spectrometry (Annex III); IAEA (2011c) Recommended method for the determination of selected trace element in samples of marine origin by atomic absorption spectrometry using graphite furnace (Annex IV); IAEA (2012a) Recommended method on the determination of Total Mercury in marine samples by thermal decomposition, amalgamation and Atomic Absorption Spectrophotometry (Annex VI); IAEA (2012) Recommended method on the determination of Total Hg in samples of marine origin by Cold Vapour Atomic Absorption Spectrometry (Annex VII); UNEP/IAEA (2011d) Sample work-up for the analysis of selected chlorinated hydrocarbons in the marine environment: Reference Methods for Marine Pollution Studies No 71 (Annex IX);, which were prepared in the framework of the MED POL monitoring programme. They are also streamlined with similar Guidelines/Protocols for marine biota sample preparation and analysis, which were developed by other Regional Seas Organisations, such as OSPAR (Annex XI and XIII) and HECLOM (Annexes II, VIII, X, XII). The analytical method developed by US EPA is also considered (Annex V). Given the suitability of any of these Guidelines in the context of IMAP, they can be further used by competent Mediterranean laboratories for developing their lab-specific sampling and sampling processing methodologies. The Parties' laboratories should accommodate and always test and modify each step of the procedures to validate their results.

8. The below flow diagram informs on the category of this Monitoring Guideline related to sample preparation and analysis of marine biota for IMAP Common Indicator 17 within the structure of all Monitoring Guidelines prepared for IMAP Common Indicators 13, 14, 17, 18 and 20.

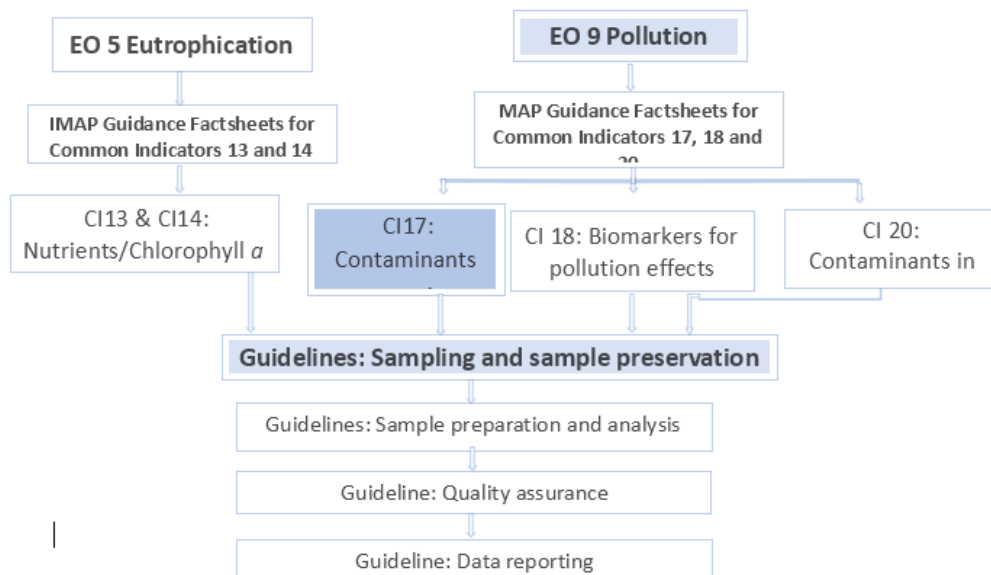

Flow Diagram: Monitoring Guidelines for IMAP Ecological Objectives 5 and 9

2. Technical note for the analysis of biota samples for heavy metals

9. Analysis of marine biota samples for the determination of heavy metals include: i) digestion of biota tissues and ii) analysis of the digested sample for heavy metals.

10. National laboratories may decide to use any validated analytical method they consider appropriate, which meets specific performance criteria (LOD, LOQ, precision, recovery and specificity). However, in order to assist analytical laboratories of Mediterranean Parties, a non-exclusive list of Protocols has been drafted to be used as guidelines for the analysis of heavy metals in marine biota samples. Analytical laboratories should accommodate, test and modify each step of the procedures presented in the Protocols in order to validate their final results. The list of methods and analytical equipment is not exhaustive, and laboratories are encouraged to use their own equipment/methods that consider adequate for the required analyses.

11. Regardless of the analytical method used, heavy metal analysis follows some procedures common to all analytical methodologies, such as the calibration of the analytical equipment and the cleaning and handling procedures to avoid the contamination of the samples from the laboratory's environment and the tools and containers used in the analysis.

a) Calibration

12. Calibration standards prepared from single standard stock solutions or multielement standards, by dilution of the stock solution using dilute acid, as required. All standard solutions have to be stored in polyethylene, borosilicate or quartz volumetric flasks, depending on the best suitability for the respective analytes. Standard solutions with lower concentrations, if prepared correctly and controlled in a QA system (checking of old versus new, and checking with standards from a different source), can be kept for a period no longer than one month.

13. The calibration procedure has to meet some basic criteria in order to give the best estimate of the true element concentration of the sample analysed (HELCOM, 2012a²⁶⁴):

- i) The concentrations of standards for the preparation of the calibration curve should cover the range of anticipated concentrations;
- ii) The required analytical precision should be known and achievable throughout the entire range of concentrations;
- iii) The measured value at the lower end of the range has to be significantly different from the procedural analytical blank;
- iv) The chemical and physical properties of the calibration standards must closely resemble those of the sample under investigation;
- v) The analytical instruments should be recalibrated regularly (every 10-20 samples) to correct for instrumental drift and analytical efficiency.

b) Avoiding contamination

14. To avoid metal contamination in the laboratory all glassware and plastic vessels used should be carefully cleaned. The general cleaning guidelines include:

- i) The vessels are allowed to soak overnight in a plastic container in an alkaline surfactant solution (e.g. Micro solution 2% in tap or even better distilled water).
- ii) Vessels are rinsed thoroughly first with tap or even better distilled water then with ultrapure deionised water (18 MΩ cm.).
- iii) Vessels are left to stand in 10% (v/v) concentrated HNO₃ solution (analytical grade) at room temperature for at least 6 days.
- iv) Vessels are thoroughly rinsed with ultrapure deionised water (at least 4 times).
- v) Vessels are allowed to dry under a laminar flow hood.
- vi) Vessels are stored in closed plastic polyethylene bags (e.g. zip-lock variety) to prevent the risk of contamination prior to use.

15. This procedure should be used for all plastic ware use in the laboratory as tips, cup for auto-sampler, plastic containers.

²⁶⁴ HELCOM (2012a). Manual for marine monitoring in the COMBINE programme. Annex B-12, Appendix 4: Technical note on the determination of trace metallic elements in biota.

16. Under this Technical Note, this Guideline for sample preparation and analysis of marine biota for IMAP Common Indicator 17 provides the following IMAP Protocols for the analysis of heavy metals in marine biota samples:

- Protocol for biota tissues digestion using nitric acid (microwave assisted digestion in closed systems and digestion on hot plate);
- Protocol for the analysis of heavy metals with Flame Atomic Absorption Spectroscopy (F-AAS);
- Protocol for the analysis of heavy metals with Graphite Furnace Atomic Absorption Spectroscopy (GF-AAS);
- Protocol for the analysis of heavy metals with Inductive Coupled Plasma – Mass Spectroscopy (ICP-MS);
- Protocol for the analysis of Total Hg by thermal decomposition, amalgamation and Atomic Absorption Spectrophotometry;
- Protocol for the analysis of Total Hg with Cold Vapour Atomic Absorption Spectrometry (CV-AAS).

17. These Protocols are based on Analytical Methods developed by IAEA (Annex I: IAEA (2011a). IAEA (2011) Recommended method on microwave digestion of marine samples for the determination of trace element content; Annex III: IAEA (2011b) Recommended method for the determination of selected trace element in samples of marine origin by flame atomic absorption spectrometry; Annex IV: IAEA (2011c) Recommended method for the determination of selected trace element in samples of marine origin by atomic absorption spectrometry using graphite furnace; Annex VI: IAEA (2012a) Recommended method on the determination of Total Mercury in marine samples by thermal decomposition, amalgamation and Atomic Absorption Spectrophotometry (AAS); Annex VII: Recommended method on the determination of Total Hg in samples of marine origin by Cold Vapour Atomic Absorption Spectrometry), HELCOM (Annex II: Manual for marine monitoring in the COMBINE programme: Technical note on the determination of trace metallic elements in biota; Annex VIII: COMBINE Programme: Technical note on the determination of Total Mercury in marine biota by Cold Vapour Atomic Absorption Spectroscopy) and US EPA (Annex V: US-EPA Method 200.8: Determination of trace elements in waters and wastes by inductively coupled plasma-mass spectrometry).

2.1. Protocol for biota tissues digestion using nitric acid

18. Biota tissues samples have to be digested (wet ashing) prior to analysis. The rate of digestion and the efficiency of acid decomposition increase substantially with elevated temperatures and pressure, therefore microwave digestion in closed vessels is the preferred method. However, in case no such equipment is available, sample digestion in open vessels over a hot plate is an alternative method. Biota samples can be digested in wet or dried condition, however regardless of the method applied, it is of paramount importance to secure the complete destruction of all organic material of the sample, as well as to avoid metals losses and the contamination of the sample (HELCOM, 2012a).

19. The existence of residual dissolved organic carbon compounds in the digested sample would change the viscosity of the solution and therefore may lead to erroneous results when calibration of the AAS instrument is made using aquatic calibration standard solutions. Also, in the GF-AAS, residual organic carbon may undergo secondary reactions with the analyte prior to or during the atomization process causing matrix interferences (Harms, 1985²⁶⁵).

- a) Microwave acid digestion in closed systems (for heavy metals analysis with AAS, GFAAS and ICP-MS analysis)

²⁶⁵ Harms, U. 1985. Possibilities of improving the determination of extremely low lead concentrations in marine fish by graphite furnace atomic absorption spectrometry. Fresenius Journal of Analytical Chemistry, 322: 53-56.

20. Biota tissue digestion can be performed in Teflon, or equal quality vessels of pure material, which are metal free and resistant to strong acids, therefore loss of elements through volatilisation and contamination by desorption of impurities from the vessel surface are significantly reduced. Also, since only small quantities of high-purity nitric acid are used, extremely low analytical blanks can be obtained. Microwave systems enable a very fast energy transfer to the sample and a very rapid build-up of high internal vessel temperature and pressure, with the advantage of an enormous reduction in digestion time occurs (HELCOM, 2012a)

Digestion reagents for the analysis of Cd, Pb and other heavy metals analysis

21. The following reagents are required:

- i) HNO_3 (65%, e.g., Suprapur);
- ii) H_2O_2 (analytical grade) to be kept in the fridge after opening;
- iii) Ultrapure deionised water ($> 18\text{M}\Omega$ cm, e.g. Millipore).

22. Dried biota tissue samples (approximately 0.2. g) are weighted in the microwave vessel and placed in a laminar hood compatible with acid fume. Approximately 5 ml of nitric acid (HNO_3) are added and each vessel and left to react for at least 1hour (or more if possible). After the room temperature pre-digestion, 2ml of hydrogen peroxide (H_2O_2) are added carefully, the vessels are closed and placed in the microwave apparatus and digestion steps are followed. Detailed methods for biota tissues microwave digestion with strong acids are presented in Annex I (IAEA 2011a²⁶⁶)and Annex II (HELCOM 2012a).

23. All chemicals used in the analysis should be kept extremely clean once opened. Double bagged and only to be opened in a clean bench or clean room. It is also strongly advised not to use any pipettes or other devices to take out chemicals from the main container, but to subsample the chemicals into pre-cleaned containers for daily use. This is paramount to avoid contamination of the very expensive ultra clean chemicals needed for this analysis.

Digestion reagents for Mercury analysis

24. For Mercury analysis the following reagents are required:

- i) HNO_3 (65%, analytical grade, certified low in mercury);
- ii) Ultrapure deionised water ($> 18\text{M}\Omega$ cm.);
- iii) 10% $\text{K}_2\text{Cr}_2\text{O}_7$ (w/v) solution (e.g. 10 g $\text{K}_2\text{Cr}_2\text{O}_7$ analytical grade diluted into 100 ml with ultrapure deionised water).
- iv) V_2O_5 analytical grade

25. Dried biota tissue samples (approximately 0.2. to 1.5 g depending of the expected concentration) are weighted in the microwave vessel and placed in a laminar hood compatible with acid fume. If processing high weight of bivalve ($> 1\text{g}$), add 40 mg of V_2O_5 to each tube (including blanks). Five ml of concentrated nitric acid (HNO_3) are added and let to react for at least 1hour. If large amount of sample is used more acid should be added until the mixture becomes liquid. To control the performance of the digestion procedure, at least 2 blanks should be prepared in a similar manner as the samples for each batch of analysis. Also at least one Certified Reference Material should be used and prepared in duplicate for each digestion batch. These digestions are prepared in a similar manner as the samples. A reference material of similar composition and concentration range should be used. After digestion, the vessels are removed from the microwave apparatus and placed in a ventilated fume hood to cool. When the pressure is adequate, the vessels are opened 1 ml of $\text{K}_2\text{Cr}_2\text{O}_7$ solution is added (final concentration should be 2% v/v) and their content is transferred to a volumetric flask, preferably of Teflon, but glass is also good, and made to a known volume.

²⁶⁶ IAEA (2011a). Recommended method on microwave digestion of marine samples for the determination of trace element content (IAEA/Marine Environmental Studies Laboratory in co-operation with UNEP/MAP MED POL)

b) Acid digestion in open systems

26. In case no microwave digestion system is available, it is possible to perform a digestion over a programmable heating plate placed inside a specially designed fume hood, allowing acid treatment. However, for the complete destruction of the organic matter, large quantities of reagents and voluminous apparatus with large surfaces are usually needed and the method is subject to contamination problems (too high blank values) if insufficiently purified acids are used. Also, the rate of reaction and efficiency of acid decomposition in open vessels is lower than in closed vessels under pressure. Therefore, digestion over a hot plate is not a recommended method and should be avoided if possible.

27. Dried biota tissue samples (approximately 0.2. g) are weighted in the microwave vessel and placed in a laminar flow hood compatible with acid fume. Approximately 5 ml of concentrated nitric acid (HNO₃) are added to each vessel and let to react at room temperature for at least 1 hour. The tubes are closed and placed in an aluminium block on a hot plate at 90°C for 3hrs. The samples are allowed to cool to room temperature, and the tubes are opened carefully, and the samples are transferred to the labelled 50 ml polypropylene graduated tubes or volumetric flasks.

28. A method for biota tissues digestion in open systems, using aqua regia, HNO₃ / HClO₄ can be found in Black et al, (2013²⁶⁷).

2.2. Protocol for the analysis of heavy metals with Flame AAS

29. Flame Atomic Absorption Spectroscopy (F-AAS) has adequate sensitivity for the determination of a wide range of metals in marine biota tissues. The sample solution is aspirated into a flame and atomized. In case of flame-AAS, a light beam is directed through the flame, into a monochromator, and onto a detector that measures the amount of light absorbed by the element in the flame. Each metal has its own characteristic wavelength, so a source hollow cathode lamp composed of that element is used. The amount of energy absorbed at the characteristic wavelength is proportional to the concentration of the element in the sample.

30. A detailed analytical protocol for the analysis of heavy metals in biota tissue samples prepared by IAEA (2011b²⁶⁸) is presented in the Annex III.

2.3. Protocol for the analysis of heavy metals with GF-AAS

31. In marine biota tissues Cd, Pb, as well as other heavy metals, can be determined by Graphite Furnace Atomic Absorption Spectroscopy (GF-AAS), which has adequate sensitivity for these determinations. For GF-AAS analysis, after the digestion of the biota sample, an aliquot of sample solution (10-50 µl) is introduced into a graphite tube of the GF-AAS and atomized by rapid heating at high temperature. A light beam is directed through the graphite tube, into a monochromator, and onto a detector that measures the amount of light absorbed by the atomized element in the tube. Each metal has its own characteristic wavelength, so a source hollow cathode lamp composed of that element is used. The amount of energy absorbed at the characteristic wavelength is proportional to the concentration of the element in the sample.

32. The AAS software generally gives typical electrothermal programs for each element for 10 µl of sample in diluted HNO₃ (0.1%) and indications concerning maximum ashing and atomization temperatures. More specific information may also be found in the literature, such as recommendations regarding matrix modifiers and the use of partition tubes or tubes with platform. When a program is optimized for the determination of an element in a specific matrix, all information should be reported in the logbook of methods of the laboratory.

²⁶⁷ Black, K., Kalantzi, I., Karakassis, I., Papageorgiou, N., Pergantis, S., Shimmield, T. (2013). Heavy metals, trace elements and sediment geochemistry at four mediterranean fish farms, Science of the Total Environment. Elsevier, 444, 128–137.

²⁶⁸ IAEA (2011b) Recommended method for the determination of selected trace element in samples of marine origin by flame atomic absorption spectrometry

33. For some elements and some matrices, the results obtained are still not satisfactory (e.g. maximum ashing temperature is not sufficient to eliminate the background), this procedure should be redone with the addition of a matrix modifier. Different matrix modifiers could be tried before finding the best solution.

34. A detailed analytical protocol for the analysis of heavy metals in sediments by GF AAS prepared by IAEA (2011c²⁶⁹) is presented in the Annex IV.

2.4. Protocol for the analysis of heavy metals with ICP-MS

35. Inductive Coupled Plasma – Mass Spectroscopy (ICP-MS) is currently state-of-the-art instrumentation for metal analysis, with the possibility to determine at sub- $\mu\text{g L}^{-1}$ concentrations of a large number of elements in acid digested biota tissue samples. ICP-MS allows a rapid analysis of a wide range of heavy metals. Most routine instruments utilize a quadrupole mass spectrometer, so mass resolution is not high enough to avoid overlap of double charged elements or multi-element ions (mainly hydrides, oxides and hydroxides) formed in the plasma. The main concern is for the Ar interferences as the plasma is usually an argon plasma, overlapping with As. Some elements are prone to memory effects (particularly Hg) and needs extra precautions to avoid carry over effects. Modern ICP-MS instruments software includes all the tuning and correction formulas needed and described above to perform the analysis (HELCOM 2012).

36. A multi-elemental determination of heavy metals by ICP-MS in water and solid samples after acid digestion, is described in the US EPA Method 200.8 (1994²⁷⁰). The method was initially intended for inorganic solid samples (soils and sediments) but can also be directly applied to organic samples. According to Enamorado-Baez et al. (2015²⁷¹), for biota tissues the digestion step could use only nitric acid (similar to the US-EPA 3051 method established for sediments, sludge, soils, and oils) but increasing the sample mass to acid volume ratio.

37. Metal species originating in a liquid are nebulized and the resulting aerosol is transported by argon gas into the plasma torch. The ions produced by high temperatures are entrained in the plasma gas and introduced, by means of an interface, into a mass spectrometer. The ions produced in the plasma are sorted according to their mass-to-charge ratios and quantified with a channel electron multiplier. Interferences must be assessed, and valid corrections applied. Interference correction must include compensation for background ions contributed by the plasma gas, reagents, and constituents of the sample matrix. The US EPA Method 200.8 is presented in Annex V.

2.5. Protocol for the analysis of Total Mercury with by thermal decomposition, amalgamation and AAS

38. Total mercury in biological tissues can be analysed by solid Hg analyser, which has adequate sensitivity for this determination. A detailed method describing the protocol for the determination of total mercury (inorganic and organic) in sediment prepared by IAEA (2012a²⁷²) (“Recommended method on the determination of Total Mercury in marine samples by thermal decomposition, amalgamation and Atomic Absorption Spectrophotometry” Annex VI). With this method, Total Hg is determined without any chemical pre-treatment of the sample, minimising possible contamination

²⁶⁹ IAEA (2011c) Recommended method for the determination of selected trace element in samples of marine origin by atomic absorption spectrometry using graphite furnace

²⁷⁰ US EPA (1994) US-EPA Method 200.8: Determination of trace elements in waters and wastes by inductively coupled plasma-mass spectrometry.

²⁷¹ Enamorado-Báez, S.M., Abril, JM and Gómez-Guzmán, JM (2013) Determination of 25 Trace Element Concentrations in Biological Reference Materials by ICP-MS following Different Microwave-Assisted Acid Digestion Methods Based on Scaling Masses of Digested Samples. Hindawi Publishing Corporation, ISRN Analytical Chemistry, Volume 2013, Article ID 851713, 14 pages. <http://dx.doi.org/10.1155/2013/851713>

²⁷² IAEA (2012a) Recommended method on the determination of Total Hg in marine samples by Thermal Decomposition Amalgamation and Atomic Absorption Spectrometry

and/or additional errors due to sample handling. The method is based on the US EPA 7473 method (US EPA, 2007²⁷³).

39. The sample is dried and then chemically decomposed under oxygen in the decomposition furnace. The decomposition products are carried out to the catalytic section of the furnace, where oxidation is completed (halogens and nitrogen/sulfur oxides are trapped). The mercury present in the remaining decomposition products is selectively trapped on an amalgamator. After flushing the system with oxygen, the mercury vapour is released by rapid heating of the amalgamator, and carried through the absorbance cell in the light path of a single wavelength atomic absorption spectrophotometer. The absorbance is measured at 253.7 nm as a function of mercury quantity (ng). The typical working range is 0.1–500 ng. The mercury vapour is carried through a long (first) and a short path length absorbance cell. The same quantity of mercury is measured twice with different sensitivity resulting in a dynamic range that spans four orders of magnitude. The typical detection limit is 0.01 ng of mercury.

2.6. Protocol for the analysis of Total Hg in samples of marine origin by CV-AAS

40. The **Cold Vapour Atomic Absorption Spectrometry (CV-AAS)** method is widely used for the determination of total mercury in biological tissues and it is simple, rapid and applicable to a large number of environmental samples. The inorganic mercury is reduced to its elemental form with stannous chloride. The cold mercury vapour is then passed through the quartz absorption cell of an AAS instrument where its concentration is measured. The light beam of Hg hollow cathode lamp is directed through the quartz cell, into a monochromator and onto a detector that measures the amount of light absorbed by the atomized vapour in the cell. The amount of energy absorbed at the characteristic wavelength is proportional to the concentration of the element in the sample.

41. The typical working range is 0.25–100 ng mL⁻¹ for direct injection of cold vapour, using “batch” system (IAEA, 2012b²⁷⁴). CV-AAS analysis can be performed manually using batch CV-AAS or automatically using flow injection (FIAS) techniques. FIAS is a very efficient approach for introducing and processing liquid samples in atomic absorption spectrometry, reduces sample and reagent consumption, and has a higher tolerance of interferences, lower determination limits and improved precision compared with conventional cold vapour techniques (HELCOM, 2012b²⁷⁵).

42. A recommended method describing the protocol for the determination of total mercury in biota prepared by IAEA (2012b) is presented in Annex VII. (Recommended method on the determination of Total Hg in samples of marine origin by Cold Vapour Atomic Absorption Spectrometry). A method for the determination of Total Hg in marine biota using CV-AAS is also proposed by HELCOM (2012b) (Annex VIII).

3. Technical note for the analysis of organic contaminants in marine biota

43. In line with IMAP requirements (UNEP/MAP, 2019; UNEP/MAP 2019a), the mandatory organic contaminants to be monitored in marine biota in the framework of the IMAP are: Organochlorinated compounds (PCBs [28, 31, 52, 101, 105, 118, 138, 153, 156, 180], Hexachlorobenzene, Lindane and ΣDDTs) and polycyclic aromatic hydrocarbons (US EPA 16 individual PAHs congeners – Acenaphene, Acenaphthylene, Anthracene, Benz(a)anthracene, Benzo(b)fluoranthene, Benzo(k)fluoranthene, Benzo(a)pyrene, Benzo(ghi)perylene, Chrysene, Dibenzo(a,h)anthracene, Fluoranthene, Indeno(1,2,3-cd)pyrene, Naphthalene, Phenanthrene, Pyrene). However, Contracting Parties to the Barcelona Convention may decide to include in their national

²⁷³ US EPA (2007). U.S. Environmental Protection Agency, EPA method 7473, Mercury in solids and solutions by thermal decomposition, amalgamation and atomic absorption spectrophotometry Rev 0.
<http://www.epa.gov/osw/hazard/testmethods/sw846/pdfs/7473.pdf>

²⁷⁴ IAEA (2012b). Recommended method on the determination of Total Hg in samples of marine origin by Cold Vapour Atomic Absorption Spectrometry.

²⁷⁵ HELCOM (2012b). COMBINE Annex B-12, Appendix 4, Attachment 1. Technical note on the determination of Total Mercury in marine biota by Cold Vapour Atomic Absorption Spectroscopy.

monitoring programmes the analysis of additional heavy organic compounds according to their national priorities.

44. Analysis of marine biota samples for the determination of organic contaminants include: i) extraction; ii) concentration; iii) clean-up; iv) fractionation; and v) quantification of contaminants.

45. National laboratories may decide to use any validated analytical method they consider appropriate, which meets specific performance criteria (LOD, LOQ, precision, recovery and specificity). However, in order to assist analytical laboratories of the Contracting Parties, the IMAP Protocols have been drafted to be used as guidelines for the analysis of organic compounds in marine biota samples. Analytical laboratories should accommodate, test and modify each step of the procedures presented in the IMAP Protocols in order to validate their final results. The list of methods and analytical equipment is not exhaustive, and laboratories are encouraged to use their own equipment/methods that consider adequate for the required analyses.

46. Under this Technical note, this Guideline for sample preparation and analysis of marine biota for IMAP Common Indicator 17 provides the following five IMAP Protocols:

- Protocol for the analysis of organochlorine pesticides and PCBs in biota using Gas Chromatography-Electron Capture Detector (GC-ECD);
- Protocol for the analysis of organochlorine pesticides and PCBs in biota using Gas Chromatography – Mass Spectrometry (GC-MS);
- Protocol for the analysis of PAHs in biota using High Performance Liquid Chromatography–Fluorescence (HPLC –UVF);
- Protocol for the analysis of PAHs in biota using Gas Chromatography – Mass Spectrometry GC-MS;
- Protocol for the normalization of organic contaminants concentrations using the lipid content .

47. These protocols are based on Analytical Methods developed by UNEP/IAEA (Annex IX: Sample work-up for the analysis of selected chlorinated hydrocarbons in the marine environment. Reference Methods for Marine Pollution Studies No 71;), HELCOM (Annex X: Manual for marine monitoring COMBINE programme. Annex B-12, Appendix 3. Technical note on the determination of chlorinated biphenyls and organochlorine pesticides in biota; Annex XII: Manual for marine monitoring in the COMBINE programme. Annex B-12, Appendix 2. Technical Note on the determination of Polycyclic Aromatic Hydrocarbons in Biota) and ICES/OSPAR (Annex XI : CEMP Guidelines for monitoring contaminants in biota and sediments. Technical Annex 8: Determination of chlorobiphenyls in biota; Annex XIII: CEMP Guidelines for monitoring contaminants in biota and sediments. Technical Annex 3: Determination of parent and alkylated PAHs in biological materials).

3.1. Protocol for the analysis of organochlorine pesticides and PCBs in marine biota using GC-ECD

48. The analysis of PCBs and organochlorine pesticides (OCPs) in marine biota samples (fish muscle and bivalve whole body) involves extraction from the matrix with organic solvents, followed by clean-up and gas chromatographic separation with electron capture (GC-ECD) or mass spectrometric (GC-MS) detection. To minimize systematic errors due to insufficiently optimized gas chromatographic conditions, determinant losses (evaporation, unsatisfactory extraction yield), and/or contamination from laboratory ware, reagents and the laboratory environment, it is essential that the sources of systematic errors are identified and eliminated as far as possible (HELCOM, 2012c²⁷⁶).

49. For analysis, the samples are prepared for solvent extraction. To achieve a satisfactory recovery of the chlorinated hydrocarbons, samples are dried by either desiccation with anhydrous sodium sulphate or by freeze-drying. Lipids are then Soxhlet extracted from biota using hexane or petroleum ether. Following initial clean-up treatments (treatment of biota extracts with concentrated

²⁷⁶ HELCOM (2012c). Manual for marine monitoring in the COMBINE programme. Annex B-12, Appendix 3. Technical note on the determination of chlorinated biphenyls and organochlorine pesticides in biota.

sulphuric acid to destroy some interfering lipids), extracts are fractionated using column chromatography.

50. All reagents, including the distilled water should be of analytical quality. Commercially available solvents like acetone, acetonitrile, dichloromethane, hexane and pentane are invariably contaminated with ECD-active substances; their concentrations vary from batch to batch and with supplier. Therefore, reagent quality should be checked by injection of 2 µl of a 100 ml batch of solvent, after concentration to 50 µl in a rotary evaporator. No peak in the GC-ECD chromatogram (90 - 250 °C) should be larger than that for 1pg of lindane. Otherwise, the solvent must be distilled.

51. The laboratory used for organic trace analysis must be a dedicated facility, isolated from other projects that could be sources of contamination. It must be properly constructed with fume hoods and benches with electric sockets that are safe for use with flammable solvents. The laboratory must have extractors and rotary evaporators cooling water to run the stills. In tropical regions and in dry climates, a refrigerated re-circulating system should be used to reduce temperatures to the required levels and/or to conserve water. Stainless steel or ceramic tiles make good non-contaminating surfaces. If necessary, benches can be coated with a hard epoxy resin and walls can be painted with epoxy paint. A sheet of aluminium foil on the workbench provides a surface which can be cleaned with solvent. A vented storage facility for solvents is essential. Benches must be fitted with frames to hold stills, extractors, etc. The emergency cut-off switch should be accessible from both inside and outside the laboratory. Firefighting equipment should be mounted in obvious places and laboratory personnel trained in their use.

52. Quantitative analysis with Electron Capture Detector (ECD) is performed by comparing the detector signal produced by the sample with that of defined standards. Due to incomplete separation, several co-eluting compounds can be present under a single detector signal, therefore, the shape and size of the signal have to be critically examined. The relative retention time and the signal size should be confirmed on columns with different polarity of their stationary phases, or by the use of multi-dimensional GC techniques. The GC should be calibrated before each batch of measurements. Since the ECD has a non-linear response curve, a multilevel calibration is strongly advised. For the purpose of determining recovery rates, an appropriate internal standard should be added to each sample at the beginning of the analytical procedure. The ideal internal standard is a PCB which is not present in the sample and which does not interfere with other PCBs (HELCOM, 2012c).

53. A step-by-step method for the determination of organochlorine pesticides and polychlorinated biphenyls in biological samples is prepared by UNEP/IAEA (2011d²⁷⁷) (Annex IX.), including the list of reagents, the solvents, standards and examples for the preparation of the stock, intermediate and working solutions. A method for the analysis of organochlorine pesticides and PCBs in biota tissues is also proposed by HELCOM (2012c) (Annex X) and OSPAR (2018a²⁷⁸) (Annex XI).

3.2. Protocol for the analysis of organochlorine pesticides and PCBs in marine biota using GC-MS

54. The analysis of PCBs and organochlorine pesticides (OCPs) in marine biota samples (fish muscle and bivalve whole body) involves extraction from the matrix with organic solvents, followed by clean-up and gas chromatographic separation with mass spectrometric (GC-MS) detection. For analysis, the samples are prepared for solvent extraction. To achieve a satisfactory recovery of the chlorinated hydrocarbons, samples are dried by either desiccation with anhydrous sodium sulphate or by freeze-drying. Lipids are then Soxhlet extracted from biota using hexane or petroleum ether. Following initial clean-up treatments (treatment of biota extracts with concentrated sulphuric acid to

²⁷⁷ IAEA (2011d). Sample work-up for the analysis of selected chlorinated hydrocarbons in the marine environment. Reference Methods for Marine Pollution Studies No 71

²⁷⁸ ICES/OSPAR (2018a). CEMP Guidelines for monitoring contaminants in biota and sediments. Technical Annex 8. Determination of chlorobiphenyls in biota

destroy some interfering lipids), extracts are fractionated using column chromatography (UNEP/IAEA, 2011d).

55. Quantitative analysis is performed by comparing the detector signal produced by the sample with that of defined standards, using a mass spectrometer (MS). Often, due to incomplete separation, several co-eluting compounds can be present under a single detector signal. Therefore, the shape and size of the signal have to be critically examined. With a MS detector, either the molecular mass or characteristic mass fragments should be recorded for that purpose. The GC should be calibrated before each batch of measurements. Since the MS has a non-linear response curve, a multilevel calibration is advised. For the purpose of determining recovery rates, an appropriate internal standard should be added to each sample at the beginning of the analytical procedure..

56. A method for extraction, concentration, clean up and fractionation for the determination of organochlorine pesticides and polychlorinated biphenyls in biological samples is prepared by UNEP/IAEA (2011d) (Annex VIII.), including the list of reagents, the solvents, standards and examples for the preparation of the stock, intermediate and working solutions. The analysis of PCBs and organochlorinated pesticides can be done by GC-ECD followed by confirmation using GC-MS. A method for the analysis of organochlorine pesticides and PCBs in biota tissues using GC-MS is also proposed by HELCOM (2012c) (Annex X) and ICES/OSPAR (2018a) (Annex XI).

3.3. Protocol for the analysis of PAHs in marine biota using HPLC-Fluorescence

57. PAHs emitted from combustion processes are predominantly parent (un-substituted) compounds, while PAHs from petroleum and its by-products contain a range of alkylated compounds in addition to the parent PAHs. HPLC has the capacity to determine parent PAHs but has not the required selectivity to be used for alkylated PAHs' determination. However, this is not a handicap for the analysis of the EPA 16 PAHs, which are parent compounds.

58. PAHs are lipophilic and so are concentrated in the lipids of an organism, therefore they have to be extracted with Soxhlet extraction, or alkaline digestion followed by liquid-liquid extraction with an organic solvent. For Soxhlet extraction, wet tissues should be dried by mixing with a chemical agent (e.g., anhydrous sodium sulphate). Non-polar solvents alone will not effectively extract all the PAHs from tissues when using Soxhlet extraction, and mixtures such as hexane/dichloromethane may be effective. Tissue extracts will always contain many compounds other than PAHs, and a clean-up is necessary to remove those compounds which may interfere with the subsequent analysis. In order to reduce the sample volume to 2 cm³ solvents are evaporated using a rotary-film evaporator at low temperature (water bath temperature of 30 °C or lower) and under controlled pressure conditions, in order to prevent losses of the more volatile PAHs such as naphthalenes. Evaporation to dryness should be avoided. When reducing the sample to final volume, solvents can be removed by a stream of clean nitrogen gas. Solvents and adsorptive materials must all be checked for the presence of PAHs and other interfering compounds. If such compounds are found, then the solvents, reagents, and adsorptive materials must be purified or cleaned using appropriate methods (HELCOM, 2012d²⁷⁹).

59. If Soxhlet extraction was used residual lipids have to be removed before the analytical determination, with an additional clean-up stage, using column chromatography with silica and alumina.

60. Detailed guidelines for the determination of Petroleum Hydrocarbons in biological samples using HPLC are prepared by HELCOM (2012d) (Annex XII) and ICES/OSPAR (2018b²⁸⁰) (Annex XIII).

²⁷⁹ HELCOM (2012d). Manual for marine monitoring in the COMBINE programme. Annexe B-12, Appendix 2. Technical Note on the determination of Polycyclic Aromatic Hydrocarbons in Biota.

²⁸⁰ ICES/OSPAR (2018b). CEMP Guidelines for monitoring contaminants in biota and sediments. Technical Annex 3. Determination of parent and alkylated PAHs in biological materials.

3.4. Protocol for the analysis of PAHs in marine biota using GC-MS

61. GC-MS analytical method has the sufficient selectivity to determine the full range of PAHs including parent (unsubstituted) PAH compounds (combustion derived) and alkylated PAH compounds (petroleum spill derived). (ICES/OSPAR, 2018).

62. Samples are Soxhlet extracted using methanol. Tissue extracts will always contain many compounds other than PAHs, and a clean-up is necessary to remove those compounds which may interfere with the subsequent analysis. In order to reduce the sample volume to 2 ml solvents are evaporated using a rotary-film evaporator at low temperature (water bath temperature of 30 °C or lower) and under controlled pressure conditions, in order to prevent losses of the more volatile PAHs such as naphthalenes. Evaporation to dryness should be avoided. When reducing the sample to final volume, solvents can be removed by a stream of clean nitrogen gas. Solvents and adsorptive materials must all be checked for the presence of PAHs and other interfering compounds. If such compounds are found, then the solvents, reagents, and adsorptive materials must be purified or cleaned using appropriate methods.

63. If Soxhlet extraction was used, residual lipids have to be removed before the analytical determination, with an additional clean-up stage, using column chromatography with silica and alumina.

64. Quantification is done by GC-MS. The two injection modes commonly used are splitless and on-column injection. Automatic sample injection should be used wherever possible to improve the reproducibility of injection and the precision of the overall method. If splitless injection is used, the liner should be of sufficient capacity to contain the injected solvent volume after evaporation. For PAH analysis, the cleanliness of the liner is also very important if adsorption effects and discrimination are to be avoided, and the analytical column should not contain active sites to which PAHs can be adsorbed. (HELCOM, 2012d).

65. Detailed methods for the determination of PAHs in biological samples using GC-MS are proposed by HELCOM (2012d) (Annex XII) and ICES/OSPAR (2018b) (Annex XIII).

3.5. Protocol for the normalization of organic contaminants concentrations using the lipid content

66. Normalisation to the total lipid content of marine biota is a means to reduce the variability of pollution level. For organic contaminants that accumulate through hydrophobic partitioning into the lipids of organisms, measured concentrations of contaminants in biota can be normalised to fish with a lipid content of 5% (European Commission 2014²⁸¹). This default lipid content of 5% has been incorporated in the OECD (1996²⁸²) 305 Guideline for bioconcentration to ensure comparability between results of bioconcentration tests. The rationale behind this lipid normalisation is that the whole body biota concentration is linearly correlated with the lipid content of the species (EC 2014). Other taxonomic groups, such as bivalves, have different lipid contents than fish. For marine bivalves a lipid content of approximately 1% is proposed (European Food Safety Authority, 2009²⁸³).

67. There is evidence that using lipid contents for normalization purpose may not always be appropriate, because it requires a linear correlation between the concentration of contaminant and the lipid content, which may not be the case for PAHs (León et al., 2013²⁸⁴). Normalization can be useful

²⁸¹ European Commission (2014). Common implementation strategy for the Water Framework Directive (2000/60/EC). Guidance Document No. 32 on Biota Monitoring (the Implementation of EQSbiota) under the Water Framework Directive. Technical Report - 2014 – 083.

²⁸² OECD (1996). OECD Guidelines for Testing Chemicals: Proposal for Updating Guideline 305. Bioconcentration: Flow-Through Fish Test Paris 1996.

²⁸³ EFSA. 2009 Guidance Document on Risk Assessment for Birds and Mammals. Parma, Italy: European Food Safety Authority. Authority EFS.358 pp.

²⁸⁴ León [V.M.](#), [Martínez-Gómez, C.](#), [García, I.](#), [Campillo, J.A.](#), [Benedicto J.](#) (2013). Spatial distribution and temporal trends of polycyclic aromatic hydrocarbons in *Mytilus galloprovincialis* from the Iberian Mediterranean coast. *Environmental Monitoring and Assessment*, 185, 2, 1055-1070.

in specific areas with similar oceanographic conditions and/or for contaminants with a predominant diffuse input in the marine environment (such as PCBs), but not to compare areas subjected to different exposition to pollutants, food availability. Therefore, normalization to lipid content is not a mandatory parameter to be reported in the framework of IMAP, but is to the Contracting Parties to decide if such an exercise is useful in facilitating pollution detection in specific areas. However it is useful to include normalization procedures in the Guidelines, making clear that the method should be tested before being applied, using sufficient data from the area under investigation.

68. In case it is decided to apply normalise measured data to lipid content, a detailed procedure is described in the EC Guidance No 32 (EC 2014) (Annex XIV.). In such cases, European Commission's suggests that contaminant concentrations are normalised to lipid contents of 5% in fish and 1% in bivalves, or to dry weight contents of 26% in fish and 8.3% in bivalves, on the basis of the measured lipid content or dry weight, or on the basis of generic values for lipid content or dry weight for the relevant species obtained from FishBase Global Information System on Fish²⁸⁵

69. To calculate the normalised concentrations *concnorm, lipid* or *concnorm, dry weight* from measured concentrations *concmeas* for a fish species x, the following equations can be used (lipid content and dry weight content expressed as mass fractions):

$$\text{concnorm, lipid} = \text{concmeas} \cdot 0.05/\text{lipid content}_x$$

or

$$\text{concnorm, dry weight} = \text{concmeas} \cdot 0.26/\text{dry weight}_x$$

70. Similarly, to calculate the normalised concentrations *concnorm, lipid* or *concnorm, dry weight* from measured concentrations *concmeas* for a bivalve species x, the following equations can be used (lipid content and dry weight content expressed as mass fractions):

$$\text{concnorm, lipid} = \text{concmeas} \cdot 0.01/\text{lipid content}_x$$

or

$$\text{concnorm, dry weight} = \text{concmeas} \cdot 0.083/\text{dry weight}_x$$

71. It is also noted that using the exact lipid or dry weight content of the biota samples is always preferred over generic values for the species (such as those available from FishBase).

72. The total lipid content of fish or bivalves can be determined using the method of Bligh and Dyer (1959²⁸⁶) using chloroform/methanol extraction techniques (OECD, 1996) or, alternatively the method proposed by Smedes (1999²⁸⁷), which has a comparable efficiency of extraction and high accuracy, but is using less toxic organic solvents (propan-2-ol–cyclohexane–water (8 + 10 + 11 v/v/v) mixture to avoid the use of chloroform).

²⁸⁵ FishBase: A global information system on fishes (www.fishbase.in)

²⁸⁶ Bligh EG, Dyer WJ: A rapid method of total lipid extraction and purification. *Can J Biochem Physiol* 1959, 37:911-917.

²⁸⁷ Smedes F (1999). Determination of total lipid using non-chlorinated solvents. *Analyst*, 124:1711-1718.

Appendix 19
Recommended Method on
MICROWAVE DIGESTION OF MARINE SAMPLES
FOR THE DETERMINATION
OF TRACE ELEMENT CONTENT



REPORT

Recommended Method on MICROWAVE DIGESTION OF MARINE SAMPLES FOR THE DETERMINATION OF TRACE ELEMENT CONTENT

IAEA/NAEL

**Marine Environmental Studies Laboratory in co-operation with
UNEP/MAP MED POL**

November 2011

For further information on this method, please contact:

IAEA-Environment Laboratories
Marine Environmental Studies Laboratory
4a Quai Antoine 1er
MC-98000 Principality of Monaco

Tel. (377) 979 772 72 Fax. (377) 979 772 73

E-mail: NAEL-MESL.Contact-Point@iaea.org

Recommended Method on
MICROWAVE DIGESTION OF MARINE SAMPLES
FOR THE DETERMINATION OF TRACE ELEMENT CONTENT

DISCLAIMER

This is not an official IAEA publication. The views expressed do not necessarily reflect those of the International Atomic Energy Agency or its Member States.

The material has not undergone an official review by the IAEA. This document should not be quoted or listed as a reference.

The use of particular designations of countries or territories does not imply any judgment by the IAEA, as to the legal status of such countries or territories, of their authorities and institutions or of the delimitation of their boundaries.

The mention of names of specific companies or products (whether or not indicated as registered) does not imply any intention to infringe proprietary rights, nor should it be construed as an endorsement or recommendation on the part of the IAEA.

Limited Distribution

Reproduced by the IAEA

TABLE OF CONTENTS

1. SCOPE	1
2. PRINCIPLE	1
3. SAMPLE PRE-TREATMENT	1
4. REAGENTS	1
5. MATERIAL	2
6. PROCEDURE	2
7. QUALITY CONTROL	5
8. REFERENCES	5

NOTE: This method is not intended to be an analytical training manual. Therefore, the method is written with the assumption that it will be performed by formally trained analytical chemist. Several stages of this procedure are potentially hazardous, especially stages with HF; users should be familiar with the necessary safety precautions.

In addition, the IAEA's recommended methods are intended to be guidance methods that can be used by laboratories as a starting point for generating their own standard operating procedure. If performance data are included in the method, they shall not be used as absolute QC acceptance criteria.

1. SCOPE

The method here below describes the protocol for dissolution of samples from marine origin. Digests are suitable for analyses of total content of trace element in sediment and biological material.

The goal of this method is the total sample decomposition with the judicious choice of acid combinations this is achievable for most matrices. The selection of reagents which give the highest recoveries for the target analytes is considered the optimum method condition.

The recommended protocol is mainly based on the EPA 3052 method; users are encouraged to consult this document (EPA, 1996).

2. PRINCIPLE

The grinded and dried samples are solubilized in an acid mixture using microwave oven apparatus.

The use of hydrofluoric acid allows the decomposition of silicates by reaction of F with Si to form the volatile SiF₄. The excess of hydrofluoric acid is either neutralized by boric acid, or digests are evaporated to dryness depending on the method used to analyze samples.

3. SAMPLE PRE-TREATMENT

Sediment samples are prepared following the recommendations of UNEP (2005).

Marine organisms are prepared following the recommendations of UNEP (1984, 1994).

4. REAGENTS

The reagents used shall meet the purity requirement of the subsequent analyses

- 4.1. ULTRAPUR WATER (type MilliQ).
- 4.2. NITRIC ACID 65%.
- 4.3. HYDROFLUORIC ACID.
- 4.4. HYDROCHLORIC ACID.
- 4.5. BORIC ACID.
- 4.6. HYDROGEN PEROXIDE.

5. MATERIAL

5.1. MICROWAVE APPARATUS

The microwave decomposition system should be temperature controlled. The temperature sensor should be accurate at $\pm 2.5^{\circ}\text{C}$. The calibration of the temperature sensor should be done at least once a year, preferably by the maintenance service of the manufacturer.

The microwave unit should be corrosion resistant.

The unit cavity should be well ventilated and connected to fume cleaner or special neutralizing system.

The method requires microwave transparent and acid resistant material (i.e. PFA, TFM) to be used as reactor. The minimal volume of the vessels should be 45 ml and it should be able to work under the pressure of 800PSI. the reactor system should be equipped with a pressure relief system.

- 5.2. ANALYTICAL BALANCE with 0.001 g precision at least.
- 5.3. FUME HOOD.
- 5.4. LAMINAR FLOW HOOD.
- 5.5. VOLUMETRIC CONTAINERS of 50 ml or 100 ml in polypropylene.
- 5.6. WEIGHING CUP in polyethylene.
- 5.7. PLASTIC SPATULAS.

6. PROCEDURE

- 6.1. All PLASTIC MATERIAL (i.e. volumetric, weighing cup...) should be acid cleaned by soaking in laboratory soap (or 10% alcohol) for at least 24h, followed by 24h of soaking in 10% nitric acid. Stronger acid cleaning protocol could be applied depending on the requirement of the subsequent analyses.
- 6.2. MICROWAVE VESSELS should be at least cleaned after each use by running the same microwave program used for samples with 5 ml of HNO_3 . If the risk of cross contamination is high (i.e. running sandy sediment after organic rich sediment) and/or in the case of long storage, the vessels should be cleaned twice. If available, an acid cleaner

(using acid vapors) can be used as a final cleaning stage. After cleaning, the vessels should be carefully rinsed with water and dried under a laminar flow hood. If a laminar flow hood is not available, vessels should be kept locked in double plastic bag; date of storage should be mentioned on the second bag.

6.3. Accurately weigh 0.1 to 0.5 g of well mixed sample in the microwave vessel.

6.4. In a fume hood, add 5 ml of nitric acid and 2 ml of hydrofluoric acid, close vessels with caps, then it is recommended to let samples react for at least 1 hour (or more if possible). Protect vessels by covering them with plastic bags or place them in a laminar flow hood compatible with acid fume. The quantity of hydrofluoric acid depends on the expected content of silicon dioxide, samples with low concentrations of silicon dioxide (< 10% like plant material to 0% like biological sample) may require less hydrofluoric acid (0.5 ml to 0 ml). Examples of acid quantities for different matrix are listed in table below.

	HF (ml)	HNO ₃ (ml)	HCl (ml)	H ₂ O ₂ (ml)	Boric (g)
Sediment	2	5	2 or 0	2	0.8
Fish	0	5	2 or 0	2	0
Sea plant	0.5	5	2 or 0	2	0

6.5. After room temperature pre-digestion, add 2 ml of hydrogen peroxide and close the reactors as recommended by the microwave manufacturer.

NOTE: The quantity and ratio of reagent can be adapted on a performance based judgment (i.e. visual total digestion, certified reference material results).

- In case of a sample containing high calcium carbonate, the hydrofluoric acid content can be set to 0 to avoid precipitation of insoluble CaF.
- A two stage digestion, using half of the hydrofluoric acid at the first stage and half at the second, could increase recovery and help achieving total decomposition.
- Additional reagent can be added depending on the sample composition to achieve complete dissolution. For example, 2±2 ml of HCl can be added to help the stabilization of As, Sb, Hg, Fe and Al at high level; however HCl might increase analytical difficulties for some techniques (i.e. ICP-MS) (Kingston 1997)
- Only one acid mixture or quantity should be used in a single batch, in the microwave, to insure consistent reaction conditions between all vessels and monitored conditions. This limitation is due to the current practice of monitoring a representative vessel, and applying a uniform microwave field to reproduce these reaction conditions within a group of vessels being simultaneously heated.

6.6. Place the closed reactor in the microwave apparatus, connect temperature and pressure control as specified by the manufacturer. The samples should be heated at 180°C

(minimum) in about 6 minutes and the temperature maintained for at least 10 minutes. The total decomposition is primarily controlled by maintaining samples at 180°C for 10 minutes. The ramping profile can be adapted, especially for safety purpose when very reactive samples are decomposed (i.e. biological material). In that case, it is recommended to increase the ramping time to 10 or 15 minutes. If possible, record temperature and pressure profile. In most samples matrices, pressure should peak between 5 and 15 minutes; profiles can be used to optimize temperature program.

- 6.7. At the end of the temperature profile, let the sample cool until the inside temperature goes down to 60°C, then remove the reactors from the microwave and place them in a ventilated fume hood. The pressure is carefully released following the manufacturer's instruction and reactors are opened.
- 6.8. In the case of removal of hydrofluoric acid excess with boric acid, 0.8 g of boric acid and 15 ml of water are added in the vessel. The quantity of boric acid is proportional to the quantity of hydrofluoric acid (usually 0.4 g for 1 ml should be sufficient). The vessels are closed again and run in the microwave with a program that heat samples at 170°C in 10 minutes and maintain this temperature for 10 minutes.
- 6.9. At the end of the temperature profile, let the sample cool until inside the temperature goes down to 60°C, then remove the reactors from the microwave and place them in a ventilated fume hood. The pressure is carefully released following the manufacturer's instruction and reactors are opened. Transfer the samples in a volumetric container and dilute them to a known volume (or a known weight, this requires to record the tare of each container before).

NOTE: An excess of boric acid will produce cloudy solutions, this might cause problem with sample introduction system of ICP. The use of boric acid will prevent measurement of boron, and possible bias introduced should be carefully investigated.

- If the use of boric acid is not possible, or if it is necessary to reduce the concentration of acid in final solutions, digest can be evaporated to incipient dryness on a hot plate at about 140°C. This stage should be performed in a controlled environment to avoid contamination and acid vapour should be treated. Some microwave oven apparatus can perform evaporation. The residue is then diluted to a known volume in nitric or hydrochloric diluted solution (usually 2% v/v) depending on the subsequent analytical method used.
- In case of insoluble precipitate or residue some extra steps can be performed like the addition of 2 ml of perchloric acid to the solution before evaporation, but this requires doing the evaporation under a specific hood for safety reason. Another option is the addition of 2 ml of concentrated hydrochloric acid, evaporation to near dryness, addition of concentrated nitric acid, evaporation to near dryness and dilution in known volume in 2% nitric acid solution.

Most samples will be totally dissolved by this method with the judicious choice of the acid combinations. A few refractory sample matrix compounds, such as TiO₂, alumina, and other oxides may not be totally dissolved, and in some cases may sequester target analyte elements.

7. QUALITY CONTROL

- 7.1. Each microwave batch should contain at the minimum one certified reference material of representative matrix.
- 7.2. A duplicate or triplicate sample should be processed on a routine basis. A duplicate sample should be processed with each analytical batch or every 10 samples. A duplicate sample should be prepared for each matrix type (i.e. sediment, sea plant, etc.).
- 7.3. A spiked sample should also be included whenever a new sample matrix is being analyzed, especially if no certified reference material is available for that matrix.
- 7.4. Blank samples should be prepared using the same reagents and quantities used in sample preparation, placed in vessels of the same type, and processed with the samples. Each microwave batch should contain at least two blank samples.

8. REFERENCES

EPA (1996) U.S. Environmental Protection Agency, EPA method 3052, Microwave assisted acid digestion of siliceous and organically based matrices Rev 0, December 2007, (<http://www.epa.gov/osw/hazard/testmethods/sw846/pdfs/3052.pdf>).

Kingston, H. M., Haswell, S (1997), Microwave Enhanced Chemistry, ACS Professional Reference.

Book Series; American Chemical Society: Washington, DC, 1997.

UNEP (2005), UNEP (DEC)/MED WG.282/inf.5/Rev1, Method for sediment sampling and analysis, February 2005, UNEP.

UNEP/IOC/IAEA (1984) reference method 7 rev2: Sampling of selected marine organisms and sample preparation for trace metal.

UNEP/IOC/IAEA (1994) reference method 57: Quality assurance and good laboratory practice, UNEP, 1994.

Annex II:

HELCOM Manual for marine monitoring in the COMBINE programme

**ANNEX B-12, APPENDIX 4: TECHNICAL NOTE ON THE DETERMINATION OF TRACE
METALLIC ELEMENTS IN BIOTA**

HELCOM Manual for marine monitoring in the COMBINE programme

ANNEX B-12, APPENDIX 4: TECHNICAL NOTE ON THE DETERMINATION OF TRACE METALLIC ELEMENTS IN BIOTA

1. INTRODUCTION

Metallic elements appear in different marine biological matrices in trace concentrations, ranging from the mg/kg through the $\mu\text{g}/\text{kg}$ to the ng/kg level. Stoeppler (1991) provided a comprehensive review of the most frequently used techniques for quantitative analysis of metallic trace elements, such as optical atomic absorption, fluorescence or emission spectrometry, anodic, cathodic or adsorptive stripping voltammetry, isotope dilution mass spectrometry and total reflection X-ray fluorescence, respectively. In spite of the powerful instrumental techniques presently in use, various analytical error sources have to be taken into consideration that may significantly influence the accuracy of the analytical data.

2. WORKING CONDITIONS

For each step of the analytical procedure, contamination of the sample may occur from the environment (laboratory air dust particles and the analyst), from sample containers or packing materials, from instruments used during sample pre-treatment and sample preparation, and from the chemical reagents used for analysis. The predominant purpose of the analytical clean laboratory is to eliminate contamination, which may be airborne or laboratory-induced, as far as possible and to control the total analytical blank.

Contamination by particles from the laboratory air may be controlled by a high-efficiency particulate filter. (A clean room is designed to maintain air with 100 particles per ft³ or 3.6.10³ per m³ of 0.5 μm particles (class 100 of U.S. Federal Standards 209), or better, preferably with a minimum of activity in the room.) U.S. Federal Standards 209 describes designs for complete laminar flow rooms, clean benches, and fume hoods, and contains information on design, testing, and maintenance of clean rooms, and should be considered an essential reference for those interested in a clean laboratory.

To control the analytical blank for analysis of metallic trace elements, one must not only maintain good laboratory air quality, but also select the appropriate composition and type of construction materials used to build the laboratory. Principally, contaminants must be effectively removed at the source to minimize their uncontrolled distribution in the analytical clean laboratory. Accordingly, the laboratory's walls should be cleaned easily and therefore painted with special metal-free wipe-resistant paints. Surfaces of working areas should be protected with, for example, disposable plastic (polyethylene, PTFE) foils. The floors should, for example, be covered with adhesive plastic mats. Details of the design that are essential for obtaining a working laboratory with low trace element blanks are described by Moody (1982), Mitchell (1982a), Boutron (1990), and Schmidt and Gerwinski (1994).

3. PRETREATMENT OF LABORATORY WARE AND REAGENTS, CONTAMINATION CONTROL

Chemically resistant materials, used in the production of high-quality laboratory ware appropriate for metallic trace element analysis, include low- and high-density polyethylene (LDPE and HDPE), polypropylene (PP), polytetrafluorethylene (PTFE), perfluoralkoxy (PFA), ethylenetetrafluorethylene (ETFE), tetrafluorethylenepolypropylene (FEP), borosilicate and quartz glass, respectively. With appropriate pretreatment and handling, these materials meet the requirements of purity necessary for the required analytical investigations.

Cleaning procedures for plastic and glass laboratory ware were comprehensively dealt with by Moody and Lindstrom (1977), Tschopel et al. (1980), Kosta (1982) and Boutron (1990). Generally, immersion in diluted (10-25 % v/v) high-purity nitric acid at room temperature for a period of one to three days, followed by repeated rinsing with high-purity water, is recommended. Steaming in high-purity acids (predominantly nitric acid) is also very effective to remove impurities from container surfaces and condition them for subsequent analysis.

The materials mentioned above for the production of laboratory ware exhibit some adsorptive or exchange properties. Boundary-surface interactions can be important, particularly when very dilute analytical solutions are being handled, since uncontrollable losses through sorption of element ions can occur (Tschopel et al., 1980; Harms, 1985). Based on this information, it is imperative that volumetric flasks, reagent vessels, pipette tips, etc., for handling samples, sample solutions and low-level reference or analyte solutions must never be used for transferring or processing stock calibration solutions, analyte solutions or concentrated reagents. Considerable quantities of analytes may be adsorbed from such solutions by the respective container surfaces, residuals of which may be leached later when dilute sample or analyte solutions are handled.

The availability of high-purity reagents is a key condition for reliable investigations of metallic trace element concentrations. For many analytical problems, the level of a specific contaminant can adequately be controlled only by applying specific purification methods. The first order of priority in regard to high-purity reagents is a sufficient supply of high-purity water. Ion-exchange units are universally accepted as an effective means of removing dissolved ionic species from water. Since high-purity water is frequently used in metallic trace element analysis, equipment for sustainable production of high-purity water by high-purity mixed-bed ion exchange resins should be available. The next most important group of reagents are mineral acids. Contamination of the sample by residual concentrations of metallic trace elements in the acids used for dissolution or decomposition represents a major problem. Purification of the acids is essential to ensure acceptable blanks.

Isothermal (isopiestic) distillation can produce volatile acids (and ammonia) of medium concentration in high-purity form. For example, pure hydrochloric acid (and ammonia) can be generated by placing an open container of concentrated reagent-grade acid adjacent to a

container of high-purity water, within a closed system (such as a desiccator) at room temperature. Acid vapours are continuously transferred into the water until equilibrium is obtained. Purification by sub-boiling distillation is based on motionless evaporation of the liquid by infrared heating at the surface to prevent violent boiling. Different purification systems are described in detail by Matthinson (1972), Kuehner et al. (1972), Dabeka et al. (1976), Tschopel et al. (1980), Mitchell (1982b), Moody and Beary (1982), Moody et al. (1989), and Paulsen et al. (1989). Acids of extremely high purity are produced by multiple batchwise distillation of reagent-grade acids in a silica apparatus, which is placed in a laminar-flow hood.

4. SAMPLE PRETREATMENT

If the determinands are heterogeneously distributed in the sample material, it may be preferable to homogenize prior to taking subsamples for analysis. However, this procedural step is problematic, since uncontrollable contamination through the homogenizing tool may occur. Cryogenic homogenization at liquid nitrogen temperature and application of high-purity material such as quartz, PTFE, titanium or stainless steel for the construction of homogenizing devices may help to minimize contamination (Iyengar, 1976; Iyengar and Kasperek, 1977; Klusmann et al., 1985).

5. SAMPLE DECOMPOSITION

For accurate direct measurements of metallic trace element contents in biological matrices, appropriate calibration (reference) standards are lacking in most instances. Therefore, multi-stage, easy to calibrate methods are still necessary, which include decomposition procedures and transformation of biological material into solution.

As a general rule wet sample is to be subject to decomposition procedures to avoid contamination or loss of determinands. A general sample decomposition procedure cannot be recommended due to the diverse composition of materials to be analysed, as well as to the different elements to be determined, and also because of the variety of possible analytical methods applied. However, the following minimum requirements should be met:

- complete destruction of all organic material of the sample,
- avoidance of determinand losses,
- avoidance of contamination.

Complete decomposition of the organic matrix is a prerequisite for a variety of the subsequently used instrumental determination techniques. Residual dissolved organic carbon from biological materials incompletely disintegrated after decomposition with nitric acid causes problems particularly in voltammetric and polarographic determinations. Both are sensitive to interference from chelating and electroactive organic components coexisting in incompletely decomposed samples during analysis (Pratt et al., 1988; Wurfels

et al., 1987, 1989). Residual dissolved organic carbon compounds even of low molecular weight can change the equilibria in the spray chambers for sample introduction in atomic emission spectrometry (AES), optical emission spectrometry (OES), and atomic absorption spectrophotometry (AAS) by changing the viscosity of the sample solution. In such cases, comparison with pure aquatic calibration standard solutions can lead to erroneous results. In graphite furnace atomic absorption spectrophotometry (GFAAS), residual organic carbon may undergo complicated secondary reactions with the analyte prior to or during the atomization process. Such 'matrix interferences' alter the rate at which atoms enter the optical path relative to that obtained for an undisturbed element standard (Harms, 1985; and other references cited there).

The comparatively simple dry ashing method using a muffle furnace is problematic, since both uncontrollable losses of the determinands and contamination through contact with the furnace material may occur.

Both, application of a carefully developed and controlled temperature programme and modifying the matrix prior to the ashing procedure (addition of ashing aids agents) may be suitable to prevent losses of volatile elements (special analytical problems concerning mercury determination are described in Attachment 1). The use of special materials (quartz, titanium, stainless steel) for the construction of sample containers may be helpful to minimise contamination.

In the widely applied wet ashing procedure in open systems, the sample is treated with acids, mainly nitric, sulphuric and perchloric acids, in different ratios and under different conditions. Usually large quantities of reagents and voluminous apparatus with large surfaces are needed for complete destruction of the organic material. Serious contamination problems (too high blank values) may arise, if insufficiently purified acids are used.

The rate of reaction and efficiency of acid decomposition increase substantially with elevated temperatures. Accordingly, closed-vessel techniques, using conventional heating or microwave energy, have an advantage over open systems. As a result of the closed systems with vessels manufactured of dense and very pure material (PTFE, PFA, quartz), loss of elements through volatilisation and contamination by desorption of impurities from the vessel surface are significantly reduced. In addition, since only small quantities of high-purity acid (usually nitric acid) need to be used, extremely low analytical blanks can be obtained. Kingston and Jassie (1986, 1988) comprehensively considered the fundamental parameters governing closed vessel acid decomposition at elevated temperatures using a microwave radiation field. Microwave systems enable a very fast energy transfer to the sample and a very rapid build up of high internal vessel temperature and pressure, with the advantage of an enormous reduction in digestion time occurs. Furthermore, a reduction of acid volume

(McCarthy and Ellis, 1991) and contamination reduction during the decomposition process were found (Dunemann, 1994; Sheppard et al., 1994).

The application of microwave energy must be carefully controlled to avoid explosions; a pressure-relief system is recommended for safe operation (Gilman and Grooms, 1988). At this stage of development, it can be concluded that advances in pressure and temperature feedback control features have contributed to the acceptance of microwave sample decomposition in analytical chemistry.

6. CALIBRATION

For calibration purposes, single element standard stock solutions at a concentration of 1000 mg/l, purchased from a qualified manufacturer, should be available. The actual concentration of the named element should be stated on the label together with the date of the preparation of the standard solution.

Fresh stock standard solutions should be compared with the old standard solutions. Traceability can be ensured by the use of CRM(s) or participation in intercomparison exercises (EURACHEM, 2003).

Single or mixed element working standard solutions for calibration purposes are prepared by dilution of the standard stock solutions using dilute acid, as required. Both stock standard and working standard solutions are stored in polyethylene, borosilicate or quartz volumetric flasks. Working standard solutions at concentrations less than 100 µg/l should be freshly prepared for every batch of samples and kept no longer than two weeks. The calibration procedure must meet some basic criteria in order to give the best estimate of the true (but unknown) element concentration of the sample analysed. These criteria are as follows:

- The amounts or concentrations of standards for the establishment of the calibration function must cover the range as related to practical conditions. The mean of the range should be roughly equal to the expected analyte concentration in the sample.
- The required analytical precision must be achievable and known throughout the entire range.
- The measured value (response) at the lower end of the range must be significantly different from the procedural analytical blank.
- The chemical and physical properties of the calibration standards must closely resemble those of the sample under investigation.
- The calibration standards must be processed through the entire analytical procedure in the same manner as the sample.

- The standard addition technique should be used only under very special circumstances (Cardone, 1986a, 1986b).

7. DETERMINATION

In an analytical series, especially with the number of samples >10, the control of calibration settings should be carried out with 2-3 calibration solution between environmental 10 samples. The analytical series should contain also a control sample of LRM or CRM.

8. REFERENCES

- Baxter, D., and Frech, W. 1990. Critical comparison of two standard digestion procedures for the determination of total mercury in natural water samples by cold vapour atomic absorption spectrometry. *Analytica Chimica Acta*, 236: 377-384.
- EURACHEM 2003. EURACHEM/CITAC Guide "Traceability in Chemical Measurement" – A guide to achieving comparable results in chemical measurement. S.L.R. Ellison, B. King, M. Rösslein, M. Salit, A. Williams (Eds.), 43 pp.
- Feldman, C. 1974. Preservation of dilute mercury solutions. *Analytical Chemistry*, 46: 99-102.
- Guo, T., and Baasner, J. 1993. Determination of mercury in urine by flow-injection cold vapour atomic absorption spectrometry. *Analytica Chimica Acta*, 278: 189-196.
- Hanna, C., and McIntosh, S. 1995. Determination of total Hg in environmental samples with on-line microwave digestion coupled to a flow injection mercury system (FIMS). *Atomic Spectroscopy*, 16: 106-114.
- Harms, U. 1988: Analytical procedures for mercury, cadmium and lead in biological material. *Baltic Sea Environment Proceedings*, No. 27C, Part CI, pp. 36-62. Helsinki Commission.
- Hatch, W., and Ott, W. 1968. Determination of sub-microgram quantities of mercury by atomic absorption spectrometry. *Analytical Chemistry*, 40: 2085-2087.
- Kaiser, G., Götz, D., Tölg, G., Knapp, G., Maichin, B., and Spitzzy, H. 1978. Untersuchung von systematischen Fehlern bei der Bestimmung von Hg-Gesamtgehalten im Bereich 10 -5 % in anorganischen und organischen Matrices mit zwei unabhängigen Verbundverfahren. *Fresenius Z. Analytical Chemistry*, 291: 278-291.
- Kingston, K., and McIntosh, S. 1995. Determination of mercury in geological samples by flow injection AAS. *Atomic Spectroscopy*, 16: 115-117.
- Landi, S., Fagioli, F., Locatelli, C., and Vecchiotti, R. 1990. Digestion method for the determination of mercury in vegetable matrices by cold vapour atomic absorption spectrometry. *Analyst*, 115: 173-177.
- Lippo, H., Jauhiainen, T., and Perämäki, P. 1997. Comparison of digestion methods for the determination of total mercury in environmental samples by flow injection CV-AAS. *Atomic Spectroscopy*, 18: 102-108.

- Navarro, M., Lopez, M., Lopez, H., and Sanchez, M. 1992. Microwave dissolution for the determination of mercury in fish by cold vapour atomic absorption spectrometry. *Analytica Chimica Acta*, 257: 155-158.
- Ping, L., and Dasgupta, P. 1989. Determination of total mercury in water and urine by gold film sensor following Fenton's Reagent digestion. *Analytical Chemistry*, 61: 1230-1235. Rokkjaer, J., Hoyer, B., and Jensen, N. 1993. Interference by volatile nitrogen oxides in the determination of mercury by flow injection cold vapour atomic absorption spectrometry. *Talanta*, 40: 729-735.
- Toffaletti, J., and Savory, J. 1975. Use of sodium borohydride for determination of total mercury in urine by atomic absorption spectrometry. *Analytical Chemistry*, 47: 2091-2095.
- Toribara, T., Shields, C., and Koval, L. 1970. Behaviour of dilute solutions of mercury. *Talanta*, 17: 1025-1028. Tsalev, D., Sperling, M., and Welz, B. 1992a: On-line microwave sample pre-treatment for hydride generation and cold vapour atomic absorption spectrometry. Part 1. The manifold. *Analyst*, 117: 1729-1733.
- Tsalev, D., Sperling, M., and Welz, B. 1992b. On-line microwave sample pre-treatment for hydride generation and cold vapour atomic absorption spectrometry. Part 2. Chemistry and application. *Analyst*, 117: 1735-1739.
- Vermeir, G., Vandecasteele, C., and Dams, R. 1989. Microwave dissolution for the determination of mercury in biological samples. *Analytica Chimica Acta*, 220: 257-261.
- Welz, B., and Melcher, M. 1984. Picotrace determination of mercury using the amalgamation technique. *Atomic Spectroscopy*, 5: 37-42.
- Welz, B., Tsalev, D., and Sperling, M. 1992. On-Line microwave sample pre-treatment for the determination of mercury in water and urine by flow-injection cold-vapour atomic absorption spectrometry. *Analytica Chimica Acta*, 261: 91-103.

Annex III:

Recommended method for the determination of selected trace element in samples of marine origin by flame atomic absorption spectrometry



Recommended method for the determination of selected trace element in samples of marine origin by flame atomic absorption spectrometry

Marine Environmental Studies Laboratory in co-operation with MED POL

November 2011

Table of Content

1. SCOPE:.....	3
2. PRINCIPLE:	4
3. SAMPLE PRE-TREATMENT:.....	4
4. REAGENT:.....	4
5. MATERIAL:.....	5
6. INTERFERENCES:.....	5
7. PROCEDURE:.....	7
8. CALCULATION OF RESULTS:	10
9. EXPRESSION OF RESULTS:.....	10
10. References:.....	11

***NOTE:** This recommended method is not intended to be an analytical training manual. Therefore the method is written with the assumption that it will be performed by formally trained analytical chemists.*

In addition the IAEA recommended methods are intended to be guidance methods that can be used by laboratories as a starting point for generating their own standard operating procedure. If performance data are included in the method they must not be used as absolute QC acceptance criteria,

The recommended protocol is mainly based on EPA 7000B method and ISO 11047 users are encouraged to consult this documents (US EPA, 2007; ISO 1998).

1. **SCOPE:**

This recommended method describes a protocol for measurement of Al, Ca, Co, Cr, Cu, Fe, Mg, Mn, Ni, Sr and Zn by flame (direct aspiration) atomic absorption spectrometry. The method is simple, rapid and applicable to a large number of environmental samples. This method is applicable when the element content in the digested solution is above the method limit. This limit will vary with the matrices and instrument model, indicative quantification limits are reported in table 1.

Table 1: Example of lower quantification limit for analyte in reagent water

Element	Lower quantification limit (mg l ⁻¹)
Al	0.5
Ca	0.02
Co	0.06
Cr	0.1
Cu	0.04
Fe	0.05
Mg	0.003
Mn	0.03
Ni	0.07
Sr	0.06
Zn	0.01

2. **PRINCIPLE:**

The method is based on the atomic absorption spectrometric measurement of the element in the mineralised solutions. In direct-aspiration atomic absorption spectrophotometry, the solution is aspirated and atomized in a flame. A light beam from a hollow cathode lamp or an electrodeless discharge lamp is directed through the flame into a monochromator, and onto a detector that measures the amount of absorbed light. Absorption depends upon the presence of free unexcited ground-state atoms in the flame. Because the wavelength of the light beam is characteristic of only the metal being determined, the light energy absorbed by the flame is a measure of the concentration of that metal in the sample. This principle is the basis of atomic absorption spectrophotometry.

3. **SAMPLE PRE-TREATMENT:**

Samples are prepared following the recommended method for microwave digestion of marine samples for determination of trace element content. (IAEA recommended method, 2011).

4. **REAGENT:**

All reagent used should be free of contamination of analyte of interest

4.1. Water: Reagent water (referenced also as water in the text) should be free of contamination

4.2. Caesium chloride solution, 4g l⁻¹: Dissolve 4g of CsCl of at least 99.999% purity in reagent water to 1 liter.

4.3. Caesium-Lanthanum solution: weigh 5.865g of La₂O₃ and 12.67g of CsCl in 100ml container, add 50ml of reagent water and 25ml of HCl and dilute to 100ml. Commercial solution specially produced for AAS may be used.

4.4. Commercial standard solution 1000µg ml⁻¹: Use a certified reference material solution; this solution should be accompanied by a certificate that should include at the minimum the traceability of the certified concentration as well as the expiration date. The density of the solution or the certified content in mg kg⁻¹ should also be defined to allow preparation of the calibration solution by weighing.

5. MATERIAL:

This section does not list common laboratory glassware

5.1. Atomic absorption spectrophotometer: This shall be equipped with: a hollow cathode lamp or an electrode-less discharge lamp appropriate to the element of interest (operated at the current recommended for the lamp by the instrument manufacturer), a background correction system, a burner suitable for an air/acetylene or nitrous oxide/acetylene flame (operated following the manufacturer's instructions). Deuterium background correction is the minimum technical specification acceptable for background correction for the measurement wavelengths below 350 nm.

5.2. Glassware: All glassware, polypropylene, or fluorocarbon (PFA or TFM) containers, including sample bottles, flasks and pipets tips, should be washed in the following sequence -- 24h soaking in laboratory soap (or 10% alcohol) followed by 24h soaking in 10% nitric acid, followed by 10% soaking in water, final rinse in water, drying under laminar flow hood. Cleaned items should be kept in double sealed plastic bags.

If it can be documented through an active analytical quality control program using spiked samples and method blanks that certain steps in the cleaning procedure are not needed for routine samples, those steps may be eliminated from the procedure (i.e. For the levels measured by flame AAS some sterile plastic containers are sufficiently free of contamination in certain analytes.)

5.3. Pipettes: microliter pipettes size ranging from 50 to 10000 μ l as needed. The accuracy and precision of the pipettes used should be checked as a routine every 6 months and obtained results should be compared with the individual certificates.

5.4. Volumetric containers preferably in polypropylene of a suitable precision and accuracy

6. INTERFERENCES:

6.1. The most troublesome type of interference in atomic absorption spectrometry is usually termed "chemical" and is caused by lack of absorption of atoms bound in molecular combination in the flame. This phenomenon can occur when the flame is not sufficiently hot to dissociate the molecule. The addition of chemical buffer (i.e. Lanthanum or calcium) or the use of nitrous oxide/acetylene gas mixture will help to prevent this interference.

6.2. The presence of high dissolved solids in the sample may result in interference from non-atomic absorbance such as light scattering. In the absence of background correction, this can result in false positive, signal contribution from uncorrected background which cannot be compensated by the method of standard addition.

6.3. Ionisation interference occurs when the flame temperature is sufficiently high to generate the removal of an electron from a neutral atom, giving a positively charged ion. This type of interference can generally be controlled by the addition of a large excess (~1mg l⁻¹) of an easily ionized element such as K or Cs.

6.4. Spectral interference can occur when an absorbing wavelength of an element present in the sample, but not being determined, falls within the width of the absorption line of the element of interest. This type of interference may sometimes be reduced by narrowing the slit width.

Specific conditions applied to individual analytes in case of known interferences are displayed in table 2.

Table 2: Instrument parameter

Element	Wavelength (nm)	Flame type	Chemical buffer*	Background	Typical calibration range (mg l ⁻¹)
Al	324.7	acetylene/NO ₂	Caesium chloride	Deuterium	1.5-40
Ca	422.7	acetylene/NO ₂	Caesium Lanthanum		0.02-1.2
Co	240.7	acetylene/air		Deuterium	0.06-4
Cr	357.9	acetylene/NO ₂			0.3-6
Cr	357.9	acetylene/air	Caesium chloride		0.1-6
Cu	324.7	acetylene/air		Deuterium	0.04-3
Fe	248.3	acetylene/air	Caesium chloride	Deuterium	0.05-3
Mg	285.2	acetylene/air	Caesium Lanthanum	Deuterium	0.003-0.3
Mn	279.5	acetylene/air	Caesium Lanthanum	Deuterium	0.03-3
Ni	232.0	acetylene/air		Deuterium	0.07-4
Sr		acetylene/NO ₂	Caesium chloride		0.06-5
Zn	213.9	acetylene/air		Deuterium	0.01-1.5

* see 4.2, 4.3 and 7.4 for use of chemical buffer

7. **PROCEDURE:**

7.1. Sample solution: Use sample prepared following the recommended method for digestion of marine samples for the determination of trace metal (IAEA, 2011)

7.2. Blank solution: Prepare at least two blank solutions with each batch of sample using same procedure than for samples

7.3. Preparation of calibration solutions:

7.3.1. Before each batch of determination prepare by appropriate dilution of $1000\mu\text{g ml}^{-1}$ stock standard solution (4.4) at least 4 standard solutions and one calibration blank solution covering the appropriate range of the linear part of the curve. The calibration standards and calibration blank should be prepared using the same type of acid or combination of acids and at the same concentration as will result in the test portion.

7.3.2. Calibration solutions should be prepared fresh each day.

7.3.3. If necessary intermediate stock standard solutions can be prepared in 10% nitric acid, these solutions should be prepared monthly.

7.3.4. All volumetric material (pipettes and containers) should be of appropriate precision and accuracy, if not available standard solution can be prepared by weighing.

7.3.5. Example of calibration curve are given in table 2.

7.4. Special case: Use of chemical buffer. If a chemical buffer is added, it should be at the same concentration as in the sample solution (7.1), the blank (7.2), calibration blank and standard solutions (7.3) following the recommendation of table 2.

For CsCl add 5ml of 4g l^{-1} for 50 ml of solution (4.2)

For CsLa solution add 0.5ml for 50ml of solution (4.3)

The chemical buffer will be added to a separate portion of sample and blank solutions that will need to be diluted to a known volume.

7.5. Calibration

7.5.1. Set up the atomic absorption spectrometer according to the manufacturer's instructions at the appropriate wavelength using appropriate conditions (see table 2), and with the suitable background correction system in operation.

7.5.2. Aspirate a calibration solution (7.3) and optimize the aspiration conditions, burner height and flame conditions to get the maximum signal.

7.5.3. Adjust the response of the instrument to zero absorbance whilst aspirating water

7.5.4. Aspirate the set of calibration solutions in ascending order and, as a zero member, the blank calibration solution (7.3).

NOTE: Care should be taken to ensure that, when using the more concentrated standards, the absorbance is < 1 , and preferably not more than 0,6.

The calibration curve is automatically plot from instrument software. The obtained curve should be linear with $r < 0.995$.

To correct for the instrumental drift the calibration should be performed every 20 samples or if the calibration verification has failed (7.8.1).

7.6. Aspirate blank (7.2) and sample solutions (7.1) and record their concentrations calculated by software using the calibration curve.

7.7. If the concentration of the test portion exceeds the calibration range dilute the test portion with the blank solution accordingly.

As an option to avoid too big dilution factors and/or to avoid a diluting large number of solutions, if all solutions are exceeding the calibration range, the burner can be turned from 0 to 90° to decrease the instrument's sensitivity. New calibration standard solutions should be prepared to match the sample range and the procedure should be repeated from (7.3).

7.8. Quality control solutions: Quality control solutions as describe below should be measured during the run.

7.8.1. Initial Calibration Verification ICV:

After initial calibration, the calibration curve must be verified by the use of initial calibration verification (ICV) standard.

The ICV standard is a standard solution made from an independent (second source) material at or near midrange. This solution as a calibration standard is prepared using the same type of acid or combination of acids and at the same concentration as will result in the test portion. If a chemical buffer is necessary it should be added in the ICV.

The acceptance criteria for the ICV standard must be $\pm 10\%$ of its true value

If the calibration curve cannot be verified within the specified limits, the cause must be determined and the instrument recalibrated before samples are analyzed. The analysis data for the ICV must be kept on file with the sample analysis

The calibration curve must also be verified at the end of each analysis batch and/or after every 10 samples. If the calibration cannot be verified within the specified limits, the sample analysis must be discontinued, the cause determined and the instrument recalibrated. All samples following the last acceptable test must be reanalyzed.

7.8.2. Blank solution (7.2): Maximum allowed blank concentration should be well documented and if blank solution exceeds this value all samples prepared along the contaminated blank should be prepared again and reanalysed.

7.8.3. Post digestion spike

Each unknown type of sample should be spike to check for potential matrix effect.

This spike is consider as a single point standard addition, and should be performed with a minimum dilution factor. The recovery of spike calculated as equation 1 should be 85-115%. If this test fails it is recommended to run analyses with standard addition method.

Spike solution: mix a fixe volume (V1) of sample solution, and a known volume (V2) of a standard solution of a known concentration (Cstandard)

Unspike solution: mix same fixe volume (V1) of sample solution, and same volume (V2) of reagent water

Measure concentration C (mg l^{-1}) in both solutions on the calibration curve (7.6), and calculate recovery as:

$$\text{Equation 1} \quad C_{\text{spike}} = \frac{C_{\text{standard}} \times V_2}{(V_1 + V_2)}$$

$$\text{Equation 2} \quad R = \frac{C_{\text{Spike Solution}} - C_{\text{Unspike solution}}}{C_{\text{spike}}} \times 100$$

To be valid concentrations of spike and unspike solutions should be in the linearity range of the calibration curve and the Spike concentration (equation 1) should be in the range of 50-150% of the concentration of unspike solution.

7.8.4. Dilution test:

If the analyte concentration is sufficiently high (minimally, a factor of 10 above the lower limit of quantitation after dilution), an analysis of a 1:5

dilution should agree within $\pm 10\%$ of the original determination. If not, then a chemical or physical interference effect should be suspected, and method of standard addition is recommended.

7.8.5. Certified Reference Material:

At least one certified reference material of a representative matrix should be prepared with each batch of sample, the calculated result should fall in the value of the certificate within the coverage uncertainty. (Linsinger, 2010), to show evidence of unbiased result.

Results of CRM should be recorded for quality control purpose and plot in control chart (UNEP/IOC/IAEA 1994).

An example of sequence order with recommended criteria and actions is given in table 3.

8. CALCULATION OF RESULTS:

Results are calculated with equation 3

$$\text{Equation 3: } w(m) = \frac{(\rho_1 - \rho_0)}{m} \times f \times V \times R$$

$w(m)$ mass fraction of element m in the sample in mg kg^{-1}

ρ_1 : concentration of element m in milligrams per liter as measured in the sample solution

ρ_0 : concentration of element m in milligrams per liter as measured in the blank solution

f : is the dilution factor calculated as

$$f = \frac{\text{final volume}}{\text{initial volume}}$$

or equal to 1 if ρ_1 is determined in undiluted solution

R : recovery calculated using CRM (see 7.8.5) or pre digestion spike

9. EXPRESSION OF RESULTS:

The rounding of values will depend of the uncertainty reported with the result; in general for this method no more than two significant figures will be reported.

Uncertainty component should be reported with all results. (ISO 2005, Nordtest 2004)

Example : $w(\text{Zn}) = 8.5 \pm 1.2 \text{ mg kg}^{-1}$

Table 3: Example of an analytical sequence:

Solutions Description	Performance	Action
Calibration blank	< maximum allowed calibration blank value	Stop until resolve
Standard solution 1 -4	$r > 0.995$	recalibrate in the linearity range
ICV	$\pm 10\%$ of true value	Stop until resolve
Sample blank	< maximum allowed blank value	
CRM	Fall in certificate value within coverage uncertainty, or fall within acceptable criteria of the QC chart	Stop until resolve, check Matrix spike and run again with standard addition method if necessary
Matrix Spike	recovery $100\% \pm 15\%$	switch to standard addition, keep record for future analyses of the same matrix
Dilution Test	sample 1 = 5x sample 1 diluted 5x within 10%	switch to standard addition, keep record for future analyses of the same matrix
Unknown Sample 1-10	should \geq standard 1 and \leq standard 4	report as <minimum quantification limit or dilute
ICV	$\pm 10\%$ of true value	Stop until resolve
Unknown Sample 11-20	should \geq standard 1 and \leq standard 4	report as <minimum quantification limit or dilute
Calibration blank	< maximum allowed calibration blank value	Stop until resolve
Standard solution 1 -4	$r > 0.995$	recalibrate in the linearity range
ICV	$\pm 10\%$ of true value	Stop until resolve
Ect....		

10. REFERENCES:

EPA (2007) U.S. Environmental Protection Agency, EPA method 7000B: Flame Atomic Absorption Spectrophotometry, Rev 2, February 2007, (<http://www.epa.gov/osw/hazard/testmethods/sw846/pdfs/7000b.pdf>)

IAEA (2011) IAEA Recommended method for microwave digestion of marines samples for the determination of trace element content, 2011, *in preparation*, available upon request

ISO (1995) Guide to the expression of uncertainty of measurements International Organisation for Standardization: Geneva

ISO (1998) International Standard Organisation 11047:1998 Soil quality- determination of Cadmium, chromium, copper, lead, manganese, nickel and zinc in aqua regia extracts of soil- flame and electrothermal atomic absorption spectrometric methods, ISO geneva

Linsinger, T. (2010), European Commission - Joint Research Centre, Institute for Reference Materials and Measurements (http://www.erm-crm.org/ERM_products/application_notes/application_note_1/Documents/erm_application_note_1_english_rev3.pdf)

Nordtest (2004) Handbook For Calculation Of Measurement Uncertainty In Environmental Laboratories Edition 2 <http://www.nordicinnovation.net/nordtestfiler/tec537.pdf>)

UNEP/IOC/IAEA (1994) reference method 57: Quality assurance and good laboratory practice, UNEP, 1994

Annex IV:

Recommended method for the determination of selected trace element in samples of marine origin by atomic absorption spectrometry using graphite furnace



Recommended method for the determination of selected trace element in samples of marine origin by atomic absorption spectrometry using graphite furnace

Marine Environmental Studies Laboratory in co-operation with MED POL

November 2011

Table of content

1. SCOPE:.....	3
2. PRINCIPLE:.....	3
3. SAMPLE PRE-TREATMENT:	4
4. REAGENTS:	4
5. MATERIALS:	6
6. INTERFERENCES:	6
7. CHEMICAL MODIFICATION:.....	7
8. PROCEDURE	8
9. CALCULATION OF RESULTS:	14
10. EXPRESSION OF RESULTS:	14
11. REFERENCES:.....	14
Table 1 Approximate characteristic masses and typical working range	3
Table 2 Recommended chemical modifiers	8
Table 3 Example of temperature program	9
Table 4 Example of analytical sequence:	12

***NOTE:** This recommended method is not intended to be an analytical training manual. Therefore the method is written with the assumption that it will be performed by formally trained analytical chemist.*

In addition, the IAEA recommended methods are intended to be guidance methods that can be used by laboratories as a starting point for generating their own standard operating procedure. If performance data are included in the method they must not be used as absolute QC acceptance criteria.

The recommended protocol is mainly based on EPA 7010 method and ISO 15586 users are encouraged to consult this documents (US EPA, 2007; ISO 2003)

1. **SCOPE:**

This International Standard includes principles and procedures for the determination of trace levels of: As, Cd, Co, Cr, Cu, Ni, Pb, and V in samples from marine origin, using atomic absorption spectrometry with electro thermal atomization in a graphite furnace. The method is applicable to the determination of low concentrations of elements. The detection limit of the method for each element depends on the sample matrix as well as the instrument, the type of atomizer and the use of chemical modifiers. Table 1 gives approximate working range and characteristic masses.

Table 1 Approximate characteristic masses and typical working range using 20µl sample volume

Element	Characteristic mass M_0^* pg	Working range ng ml ⁻¹
As	15	5-50
Cd	0.8	0.2-2
Co	10	3-30
Cr	3	2-20
Cu	10	3-30
Ni	13	5-50
Pb	15	5-50
V	35	10-100

**The characteristic mass (m_0) of an element is the mass in pg corresponding to a signal of 0.00044 unity using peak area as integration*

2. **PRINCIPLE:**

An aliquot of sample solution (5-50 μL) is introduced into a graphite tube of the GF AAS and atomized by rapid heating at high temperature. A light beam is directed through the graphite tube, into a monochromator, and onto a detector that measures the amount of light absorbed by the atomized element in the tube. Each metal has its own characteristic wavelength therefore a source hollow cathode lamp composed of that element is used. The amount of energy absorbed at the characteristic wavelength is proportional to the concentration of the element in the sample.

3. **SAMPLE PRE-TREATMENT:**

Samples are prepared following the recommended method for microwave digestion of marine samples for determination of trace element content. (IAEA recommended method, 2011)

4. **REAGENTS:**

4.1. Water: Reagent water (referenced also as water in the text) should be free of contamination

4.2. Concentrated acid solution as used for sample preparation (section 3)

4.3. Commercial standard solution $1000\mu\text{g ml}^{-1}$: Use certified reference material solution; this solution should be accompanied by a certificate that should include at least the traceability of the certified concentration as well as the expiration date. The density of the solution or the certified content in mg kg^{-1} should also be defined to allow preparation of calibration solution by weighing.

4.4. Calibration solutions: Prepare calibration solutions from the standard solutions (4.3) by appropriate dilution. Intermediate standard solutions should be prepared in 2% (v/v) nitric acid. For calibration solution use the same amount of acid as that of the samples solutions.

Calibration solutions below 1 mg/l should not be used for more than one month, and those below 100 $\mu\text{g/l}$ should not be used for more than one day.

4.5. Blank calibration solution: Prepare a blank calibration solution in the same way as the calibration solution but without adding standard. The final amount of acid will be the same as that of the sample solutions.

4.6. Palladium nitrate/magnesium nitrate modifier

Pd(NO₃)₂ solution is commercially available (10 g/l). Dissolve 0,259 g of Mg(NO₃)₂·6H₂O in 100 ml of water. Mix the palladium nitrate solution with twice as much magnesium nitrate solution. 10 µl of the mixed solution is equal to 15 µg Pd and 10 µg Mg(NO₃)₂. The mixture is also commercially available.

Prepare a fresh solution monthly.

4.7. Magnesium nitrate modifier

Dissolve 0,865 g of Mg(NO₃)₂·6H₂O in 100 ml of water. 10 µl of this solution is equal to 50 µg Mg(NO₃)₂.

4.8. Ammonium dihydrogen phosphate modifier

Dissolve 2,0 g of NH₄H₂PO₄ in 100 ml of water. 10 µl of this solution is equal to 200 µg NH₄H₂PO₄.

4.9. Ammonium dihydrogen phosphate/magnesium nitrate modifier

Dissolve 2,0 g of NH₄H₂PO₄ and 0,173 g of Mg(NO₃)₂·6H₂O in 100 ml of water. 10 µl of this solution is equal to 200 µg NH₄H₂PO₄ and 10 µg Mg(NO₃)₂.

4.10. Palladium/Ammonium dihydrogen phosphate/magnesium nitrate modifier

Mix 2ml of Pd(NO₃)₂ solution is commercially available (10 g/l), 2ml of Mg(NO₃)₂ solution prepared as (4.7), 0.5ml of NH₄H₂PO₄ prepared as (4.8) and dilute with water to 10ml. 4µl of this solution is equal to 8µg of Pd, 4µg of Mg(NO₃)₂ and 4µg of NH₄H₂PO₄.

4.11. Nickel modifier

Dissolve 0,200 g of nickel powder in 1 ml concentrated nitric acid and dilute to 100 ml with water. 10 µl of this solution is equal to 20 µg Ni. Solutions of Ni(NO₃)₂ are also commercially available.

4.12. Iridium solution 1000µg ml⁻¹

Use commercial solution (standard)

4.13. Argon

5. MATERIALS:

- 5.1. Glassware:** All glassware, polypropylene, or fluorocarbon (PFA or TFM) containers, including sample bottles, flasks and pipettes tips, should be washed in the following sequence -- 24h soaking in laboratory soap (or 10% alcohol) followed by 24h soaking in 10% nitric acid, followed by 10% soaking in water, final rinsing in water, drying under laminar flow hood. Cleaned items should be kept in double sealed plastic bags
- 5.2. Pipettes:** microliter pipettes size ranging from 50 to 10000 μ l as needed. The accuracy and precision of the pipettes used should be checked as a routine every 6 months and the obtained results should be compared with the individual certificates.
- 5.3. Volumetric containers** preferably in polypropylene of suitable precision and accuracy
- 5.4. Atomic Absorption Spectrometer** equipped with graphite furnace, background correction system and necessary hollow cathode lamp.
- 5.5. Auto sampler**
- 5.6. Polypropylene cups** for automatic sampler cleaned as explained in (5.1)
- 5.7. Graphite tubes:** pyrolytically-coated with platforms, preferably for highly and medium volatile elements, whereas elements of low volatility should be atomized from the wall. Provided satisfactory results are achieved, manufacturer's recommendations regarding the use of graphite tubes and platforms should be followed.

6. INTERFERENCES:

Some sample solutions, may contain large amounts of substances that may affect the results. High concentrations of chloride may cause low results, because the volatility of many elements is increased and analyte loss may occur during the pyrolysis step. Matrix effects may be overcome, partially or completely, by the optimization of the temperature program, the use of pyrolytically-coated tubes and platforms, the use of chemical modifiers, the standard addition technique and the use of background correction.

7. CHEMICAL MODIFICATION:

Chemical modifiers are used to overcome spectral and/or non-spectral interferences in a sample (matrix effects). In general, the aim of chemical modification is to allow a pyrolysis temperature that is high enough to remove the bulk of concomitants before the atomization step. In order to ascertain that the modification works, the spike procedures is performed with and without the addition of a chosen chemical modifier and recovery are compared

Spike experiment:

Spike solution: mix a fixe volume (V1) of sample solution, and a known volume (V2) of a standard solution of a known concentration (C_{standard})

Unspike solution: mix same fixe volume (V1) of sample solution, and same volume (V2) of reagent water

Measure concentration C (mg l⁻¹) in both solutions on the calibration curve, and calculate recovery as:

$$\text{Equation 1} \quad C_{\text{spike}} = \frac{C_{\text{standard}} \times V_2}{(V_1 + V_2)}$$

$$\text{Equation 2} \quad R = \frac{C_{\text{Spike Solution}} - C_{\text{Unspike solution}}}{C_{\text{spike}}} \times 100$$

To be valid concentrations of spike and unspike solutions should be in the linearity range of the calibration curve and Spike concentration (equation 1) should be in the range of 50-150% of the concentration of unspike solution. The recovery should be 100 ± 15%

In Table 2 some recommendations of chemical modifiers are given.

Other chemical modifiers may be used if they show consistent results. Graphite tube can also be pretreated with Iridium (Vasileva 2001) as following:

Inject 50µl of the solution and run the temperature program below

Step	Temperature (°C)	Ramp Time (s)	Hold Time (s)
1	100	5	30
2	1200	20	5
3	100	5	2
4	2500	2	10

Repeat this 3 times, the coating is stable for about 200 injections and can be repeated

If chemical modifiers are used, add them to test samples, sample blank solutions, calibration solutions, and blank calibration solutions. Preferably inject the modifier solution with the auto sampler directly into the atomizer after the sample is delivered.

Table 2 Recommended chemical modifiers

Element	Chemical modifier	Amount* µg
As	Pd + Mg(NO ₃) ₂ or NH ₄ H ₂ PO ₄	15+10 200
Cd	Pd + Mg(NO ₃) ₂ +NH ₄ H ₂ PO ₄ or Ir coating	8+4+4
Co	Pd + Mg(NO ₃) ₂	15+10
Cr	Mg(NO ₃) ₂	50
Cu	None	
Ni	Mg(NO ₃) ₂	50
Pb	Pd + Mg(NO ₃) ₂ +NH ₄ H ₂ PO ₄ or Ir coating	8+4+4
V	None	

*These amounts are only recommendation, significantly lower amounts may be required in some atomizers, see also recommendations from instrument manufacturers.

8. PROCEDURE

8.1. Switch on the instrument and perform the optimization according to the manufacturer's instructions. Install an appropriate graphite tube, and set up the auto sampler.

8.2. Program the graphite furnace and the auto sampler. Examples of temperature program are given in table 3.

Note: Method for specific element and matrix should be developed and all necessary information should be stored with at least:

- *Temperature program*
- *Matrix modifier*
- *Type of graphite tube*
- *Matrix effect*
- *Type of calibration curve*
- *Typical m_0 obtained with the program*
- *Linearity*

Table 3 Example of temperature program

Element	Cu	Cu	Cd	Cd	Pb	Pb	As	As	Cr	Cr
Sample type	Sediment	Biota	Sediment	Biota	Sediment	Biota	Sediment	Biota	Sediment	Biota
Wavelength(nm)	327.4	327.4	228.8	228.8	283.3	283.3	193.7	193.7	357.9	357.9
Graphite tube	Partition Tube	Partition Tube	platform	platform	platform	platform	platform	platform	Partition Tube	Partition Tube
Matrix Modifier	none	none	none	Pd,Mg, Amonium Phosphate	none	Pd,Mg ,Amonium Phosphate	Pd,Mg	Pd,Mg	none	none
Peak Measurement	area	area	area	area	area	area	area	area	area	area
M0(pg/0.0044 UA) on standard	13	13	1	1	16	16	15	15	2.5	2.5
Ashing T° (C°)	700	700	300	700	400	925	1400	1400	1100	1100
Atomisation T° (C°)	2300	2300	1800	1900	2100	2200	2600	2600	2600	2600
Remark							Number of Fire is critical	Standard Addition often required. Number of fire is critical	Use peak Height for lower concentration (peak shape)	Standard Addition often required. Use peak Height for lower concentration (peak shape)

8.3. Generality for measurements:

All measurements should be performed with at least duplicate injections of solutions; the relative standard deviation should be less than 5% for a signal above 0.01 unit of absorbance.

It is recommended to work in peak area.

Check the number of firing and change the graphite tube when appropriate, if graphite tube is changed during a run, the instrument needs to be recalibrated.

8.4. Run the calibration:

8.4.1. **Standard calibration technique:** Perform the calibration with a blank calibration solution (4.5) and 3 to 5 equidistant calibration solutions (4.4) for an appropriate concentration range.

To correct for the instrumental drift calibration should be performed every 10 samples (if possible the option of reslope using the middle standard point should be applied every 5 samples)

Calibration solutions can be prepared by the auto sampler from the highest standard solution, the minimum volume uptake should not be less than 4 μ l.

The blank calibration solution should be free of analyte, or below a well-documented maximum allowed calibration blank value (i.e. validation, control charts..).

It should be stressed that the linearity of the calibration curve is often limited. The calibration curve is automatically plot by instrument software, if linear regression is set checked that $r \leq 0.995$ or switch to second order equation.

8.4.2. **Standard addition method:** This technique involves preparing same aliquots of sample solution with increasing amount of analyte. As describe in section 7 for the spike experiment using an increasing concentration of standard (V1 and V2 should stay the same). The auto sampler can be prograded to perform standard addition. Determine the analyte concentration in the reagent blank solution the same way. Example of standard addition is given in figure 1. The concentration is obtained by dividing the absorbance of zero addition by the slope.

The standard addition should be performed for each type of matrix (i.e. a sediment sample solution cannot be measured with a standard addition curve done on a fish sample solution). For similar sample matrices (i.e. same fish species) the slope obtained with one sample can be used for other measurements respecting recalibration every 10 samples.

For standard addition to be valid the following limitation should be taken into consideration:

- The resulting calibration should be linear ($r \leq 0.995$), software calibration equation is a linear regression
- The additions should represent ideally 50, 100, 150 and 200% of the sample concentration
- The standard addition technic cannot be used to correct for spectral interferences, such as unspecific background absorption, and should not be used if interferences change the signal by a factor of more than three.

Figure 1 Standard addition example

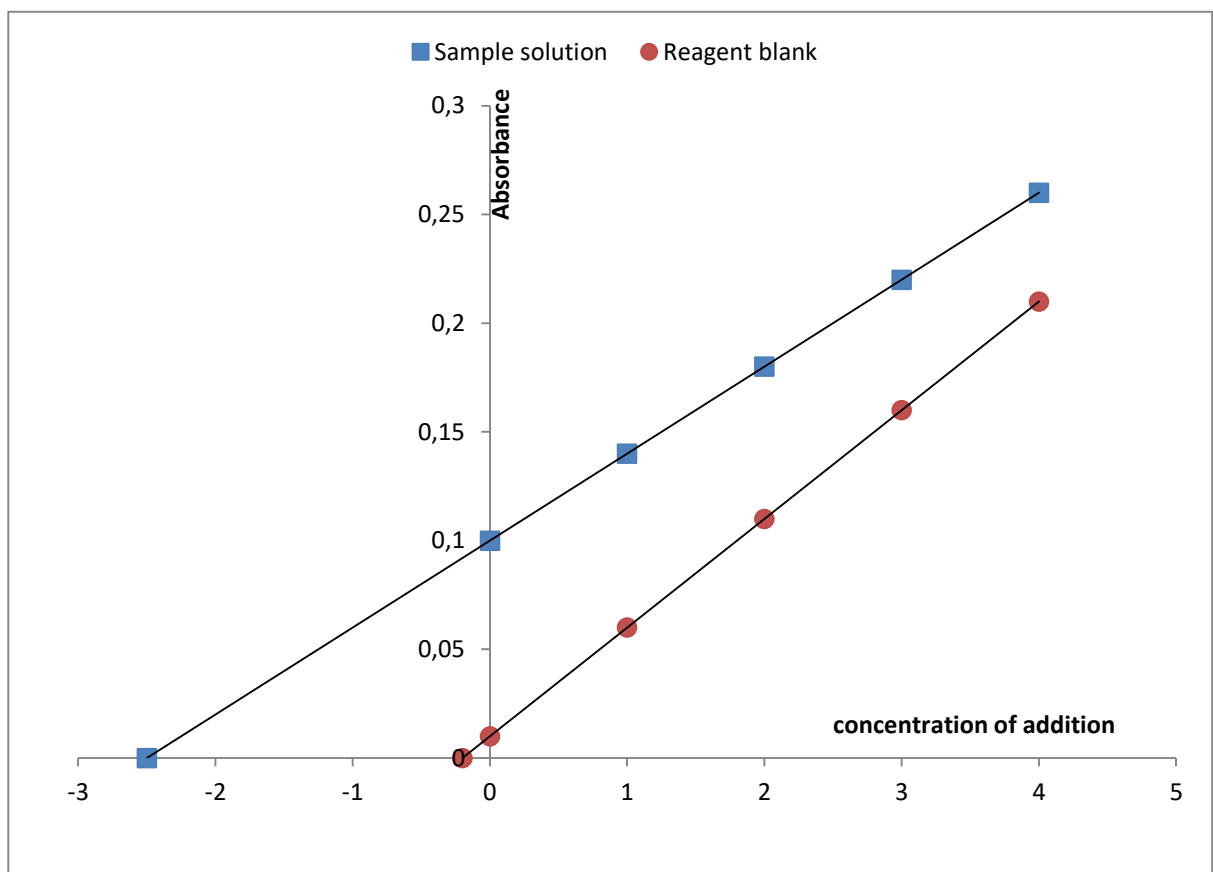

8.5. Measure sample blank and sample solutions (prepared following section 3) record the concentration as calculated by the software and calculate results following equation 3 (section 9), if samples exceed the highest point of calibration dilute appropriately. As an option a smaller volume of solution can be injected to stay under linear range of the instrument.

8.6. Quality control solutions: Quality control solutions as described below should be measured during the run. An example of a sequence order with recommended criteria and action is given in table 4.

Table 4 Example of analytical sequence:

Solutions Description	Performance	Action
Calibration blank	< maximum allowed calibration blank value	Stop until resolve
Standard solution 1 -4	$r > 0.995$	recalibrate in the linearity range
ICV	$\pm 10\%$ of true value	Stop until resolve
Sample blank	< maximum allowed blank value	
CRM	Fall in certificate value within coverage uncertainty, or fall within acceptable criteria of the QC chart	Stop until resolve, check Matrix spike and run again with standard addition method if necessary
Matrix Spike	recovery $100\% \pm 15\%$	switch to standard addition, keep record for future analyses of the same matrix
Dilution Test	sample 1 = 5x sample 1 diluted 5x within 10%	switch to standard addition, keep record for future analyses of the same matrix
Unknown Sample 1-10	should \geq standard 1 and \leq standard 4	report as <minimum quantification limit or dilute

ETC...(restart sequence from calibration blank)

8.6.1. Initial Calibration Verification ICV:

After the initial calibration, the calibration curve must be verified using the initial calibration verification (ICV) standard.

The ICV standard is a standard solution made from an independent (second source) material at or near midrange. This solution as calibration standard is prepared using the same type of acid or combination of acids and at the same concentration as will result in the test portion.

The acceptance criteria for the ICV standard must be $\pm 10\%$ of its true value

If the calibration curve cannot be verified within the specified limits, the cause must be determined and the instrument recalibrated before samples are analyzed.

The analysis data for the ICV must be kept on file with the sample analysis

The calibration curve must also be verified at the end of each analysis batch and/or after every 10 samples. If the calibration cannot be verified within the specified limits, the sample analysis must be discontinued, the cause determined and the instrument recalibrated. All samples following the last acceptable test must be reanalyzed.

8.6.2. **Blank solution (4.5):** Maximum allowed blank concentration should be well documented and if blank solution exceeds this value all samples prepared along the contaminated blank should be prepared again and re analyzed.

8.6.3. **Post digestion spike**

Each unknown type of sample should be spike to check for potential matrix effect.

This spike is consider as a single point standard addition, and should be performed with a minimum dilution factor. Recovery of spike calculated as equation 1 should be 85-115%. If this test failed it is recommended to run analyses with standard addition method. (see section 7 for detail)

8.6.4. **Dilution test:**

If the analyte concentration is sufficiently high (minimally, a factor of 10 above the lower limit of quantitation after dilution), an analysis of a 1:5 dilution should agree within $\pm 10\%$ of the original determination. If not, then a chemical or physical interference effect should be suspected, and method of standard addition is recommended.

8.6.5. **Certified reference material:**

At least one certified reference material of a representative matrix will be prepared with each batch of sample, the calculated result should be comparable with the value of the certificate within the coverage uncertainty.(Linsinger, 2010), to show evidence of unbiased result.

Results of CRM should be record for quality control purpose and plot in control chart (UNEP/IOC/IAEA 1994)

9. CALCULATION OF RESULTS:

Results are calculated with equation 3

$$\text{Equation 3: } w(m) = \frac{(\rho_1 - \rho_0)}{m} \times f \times V \times R$$

w(m) mass fraction of element m in the sample in mg kg⁻¹

ρ1: concentration of element m in milligrams per liter as measured in the sample solution

ρ0: concentration of element m in milligrams per liter as measured in the blank solution

f: is the dilution factor calculated as

$$f = \frac{\text{final volume}}{\text{initial volume}}$$

or equal to 1 if ρ1 is determined in undiluted solution

R: recovery calculated using CRM (see 8.6.5) or pre digestion spike

10. EXPRESSION OF RESULTS:

The rounding of values will depend of the uncertainty reported with the result. Uncertainty component should be reported with all results. (ISO 1995, Nordtest 2004)

Example : w(Pb) = 8.5 ± 1.2 mg kg⁻¹

11. REFERENCES:

EPA (2007) U.S. Environmental Protection Agency, EPA method 7010: Graphite furnace Atomic Absorption Spectrophotometry, Rev 0, February 2007, (<http://www.epa.gov/osw/hazard/testmethods/sw846/pdfs/7010.pdf>)

IAEA (2011) IAEA Recommended method for microwave digestion of marines samples for the determination of trace element content, 2011, *in preparation*, available upon request

ISO (1995) Guide to the expression of uncertainty of measurements International Organisation for Standardization: Geneva

ISO (1998) International Standard Organisation 11047:1998 Soil quality- determination of Cadmium, chromium, copper, lead, manganese, nickel and zinc in aqua regia extracts of soil-flame and electrothermal atomic absorption spectrometric methods, ISO geneva

Linsinger, T. (2010), European Commission - Joint Research Centre, Institute for Reference Materials and Measurements (http://www.erm-crm.org/ERM_products/application_notes/application_note_1/Documents/erm_application_note_1_english_rev3.pdf)

Nordtest (2004) Handbook For Calculation Of Measurement Uncertainty In Environmental Laboratories Edition 2 <http://www.nordicinnovation.net/nordtestfiler/tec537.pdf>

UNEP/IOC/IAEA (1994) reference method 57: Quality assurance and good laboratory practice, UNEP, 1994

Vasileva. E, Baeten. H, Hoenig. M (2001), Advantages of the iridium permanent modifier in fast programs applied to trace-element analysis of plant samples by electrothermal atomic absorption spectrometry, *Fresenius J Anal Chem* (2001) 369 :491–495

Annex V:

METHOD 200.8

DETERMINATION OF TRACE ELEMENTS IN WATERS AND WASTES

BY INDUCTIVELY COUPLED PLASMA - MASS SPECTROMETRY

Revision 5.4

EMMC Version

METHOD 200.8

**DETERMINATION OF TRACE ELEMENTS IN WATERS AND WASTES
BY INDUCTIVELY COUPLED PLASMA - MASS SPECTROMETRY**

**Revision 5.4
EMMC Version**

S.E. Long (Technology Applications Inc.), T.D. Martin, and E.R. Martin - Method 200.8,
Revisions 4.2 and 4.3 (1990)

S.E. Long (Technology Applications Inc.) and T.D. Martin - Method 200.8, Revision 4.4 (1991)

J.T. Creed, C.A. Brockhoff, and T.D. Martin - Method 200.8, Revision 5.4 (1994)

**ENVIRONMENTAL MONITORING SYSTEMS LABORATORY
OFFICE OF RESEARCH AND DEVELOPMENT
U.S. ENVIRONMENTAL PROTECTION AGENCY
CINCINNATI, OHIO 45268
METHOD 200.8**

**DETERMINATION OF TRACE ELEMENTS IN WATERS AND WASTES
BY INDUCTIVELY COUPLED PLASMA - MASS SPECTROMETRY**

1.0 SCOPE AND APPLICATION

- 1.1 This method provides procedures for determination of dissolved elements in ground waters, surface waters and drinking water. It may also be used for determination of total recoverable element concentrations in these waters as well as wastewaters, sludges and soils samples. This method is applicable to the following elements:

Analyte	Chemical Abstract Services Registry Number (CASRN)	
Aluminum	(Al)	7429-90-5
Antimony	(Sb)	7440-36-0
Arsenic	(As)	7440-38-2
Barium	(Ba)	7440-39-3
Beryllium	(Be)	7440-41-7
Cadmium	(Cd)	7440-43-9
Chromium	(Cr)	7440-47-3
Cobalt	(Co)	7440-48-4
Copper	(Cu)	7440-50-8
Lead	(Pb)	7439-92-1
Manganese	(Mn)	7439-96-5
Mercury	(Hg)	7439-97-6
Molybdenum	(Mo)	7439-98-7
Nickel	(Ni)	7440-02-0
Selenium	(Se)	7782-49-2
Silver	(Ag)	7440-22-4
Thallium	(Tl)	7440-28-0
Thorium	(Th)	7440-29-1
Uranium	(U)	7440-61-1
Vanadium	(V)	7440-62-2
Zinc	(Zn)	7440-66-6

Estimated instrument detection limits (IDLs) for these elements are listed in Table 1. These are intended as a guide to instrumental limits typical of a system optimized for multielement determinations and employing commercial instrumentation and pneumatic nebulization sample introduction. However, actual method detection limits (MDLs) and linear working ranges will be dependent on the sample matrix, instrumentation and selected operating conditions. Given in Table 7 are typical MDLs for both total recoverable determinations by "direct analysis" and where sample digestion is employed.

- 1.2 For reference where this method is approved for use in compliance monitoring programs [e.g., Clean Water Act (NPDES) or Safe Drinking Water Act (SDWA)] consult both the appropriate sections of the Code of Federal Regulation (40 CFR Part 136 Table 1B for NPDES, and Part 141 § 141.23 for drinking water), and the latest Federal Register announcements.
- 1.3 Dissolved elements are determined after suitable filtration and acid preservation. In order to reduce potential interferences, dissolved solids should not exceed 0.2% (w/v) (Section 4.1.4).
- 1.4 With the exception of silver, where this method is approved for the determination of certain metal and metalloid contaminants in drinking water, samples may be analyzed directly by pneumatic nebulization without acid digestion if the samples have been properly preserved with acid and have turbidity of <1 NTU at the time of analysis. This total recoverable determination procedure is referred to as "direct analysis".
- 1.5 For the determination of total recoverable analytes in aqueous and solid samples a digestion/extraction is required prior to analysis when the elements are not in solution (e.g., soils, sludges, sediments and aqueous samples that may contain particulate and suspended solids). Aqueous samples containing suspended or particulate material $\geq 1\%$ (w/v) should be extracted as a solid type sample (Section 11.2.2).
- 1.6 The total recoverable sample digestion procedure given in this method is not suitable for the determination of volatile organo-mercury compounds. However, for "direct analysis" of drinking water (turbidity <1 NTU), the combined concentrations of inorganic and organo-mercury in solution can be determined by "direct analysis" pneumatic nebulization provided gold is added to both samples and standards alike to eliminate memory interference effects.
- 1.7 Silver is only slightly soluble in the presence of chloride unless there is a sufficient chloride concentration to form the soluble chloride complex. Therefore, low recoveries of silver may occur in samples, fortified sample matrices and even fortified blanks if determined as a dissolved analyte or by "direct analysis" where the sample has not been processed using the total recoverable mixed acid digestion. For this reason it is recommended that samples be digested prior to the determination of silver. The total recoverable sample digestion procedure given in this method is suitable for the determination of silver in aqueous samples containing concentrations up to 0.1 mg/L. For the analysis of wastewater samples containing higher concentrations of silver, succeeding smaller volume, well mixed sample aliquots must be prepared until the analysis solution contains <0.1 mg/L silver. The extraction of solid samples containing concentrations of silver >50 mg/kg should be treated in a similar manner.
- 1.8 The total recoverable sample digestion procedure given in this method will solubilize and hold in solution only minimal concentrations of barium in the presence of free sulfate. For the analysis of barium in samples having varying

and unknown concentrations of sulfate, analysis should be completed as soon as possible after sample preparation.

- 1.9 This method should be used by analysts experienced in the use of inductively coupled plasma mass spectrometry (ICP-MS), the interpretation of spectral and matrix interferences and procedures for their correction. A minimum of six months experience with commercial instrumentation is recommended.
- 1.10 Users of the method data should state the data-quality objectives prior to analysis. Users of the method must document and have on file the required initial demonstration performance data described in Section 9.2 prior to using the method for analysis.

2.0 SUMMARY OF METHOD

- 2.1 An aliquot of a well mixed, homogeneous aqueous or solid sample is accurately weighed or measured for sample processing. For total recoverable analysis of a solid or an aqueous sample containing undissolved material, analytes are first solubilized by gentle refluxing with nitric and hydrochloric acids. After cooling, the sample is made up to volume, is mixed and centrifuged or allowed to settle overnight prior to analysis. For the determination of dissolved analytes in a filtered aqueous sample aliquot, or for the "direct analysis" total recoverable determination of analytes in drinking water where sample turbidity is <1 NTU, the sample is made ready for analysis by the appropriate addition of nitric acid, and then diluted to a predetermined volume and mixed before analysis.
- 2.2 The method describes the multi-element determination of trace elements by ICP-MS.¹⁻³ Sample material in solution is introduced by pneumatic nebulization into a radiofrequency plasma where energy transfer processes cause desolvation, atomization and ionization. The ions are extracted from the plasma through a differentially pumped vacuum interface and separated on the basis of their mass-to-charge ratio by a quadrupole mass spectrometer having a minimum resolution capability of 1 amu peak width at 5% peak height. The ions transmitted through the quadrupole are detected by an electron multiplier or Faraday detector and the ion information processed by a data handling system. Interferences relating to the technique (Section 4.0) must be recognized and corrected for. Such corrections must include compensation for isobaric elemental interferences and interferences from polyatomic ions derived from the plasma gas, reagents or sample matrix. Instrumental drift as well as suppressions or enhancements of instrument response caused by the sample matrix must be corrected for by the use of internal standards.

3.0 DEFINITIONS

- 3.1 **Calibration Blank** - A volume of reagent water acidified with the same acid matrix as in the calibration standards. The calibration blank is a zero standard and is used to calibrate the ICP instrument (Section 7.6.1).

- 3.2 **Calibration Standard (CAL)** - A solution prepared from the dilution of stock standard solutions. The CAL solutions are used to calibrate the instrument response with respect to analyte concentration (Section 7.4).
- 3.3 **Dissolved Analyte** - The concentration of analyte in an aqueous sample that will pass through a 0.45 µm membrane filter assembly prior to sample acidification (Section 11.1).
- 3.4 **Field Reagent Blank (FRB)** - An aliquot of reagent water or other blank matrix that is placed in a sample container in the laboratory and treated as a sample in all respects, including shipment to the sampling site, exposure to the sampling site conditions, storage, preservation, and all analytical procedures. The purpose of the FRB is to determine if method analytes or other interferences are present in the field environment (Section 8.5).
- 3.5 **Instrument Detection Limit (IDL)** - The concentration equivalent to the analyte signal which is equal to three times the standard deviation of a series of 10 replicate measurements of the calibration blank signal at the selected analytical mass(es). (Table 1).
- 3.6 **Internal Standard** - Pure analyte(s) added to a sample, extract, or standard solution in known amount(s) and used to measure the relative responses of other method analytes that are components of the same sample or solution. The internal standard must be an analyte that is not a sample component (Sections 7.5 and 9.4.5).
- 3.7 **Laboratory Duplicates (LD1 and LD2)** - Two aliquots of the same sample taken in the laboratory and analyzed separately with identical procedures. Analyses of LD1 and LD2 indicates precision associated with laboratory procedures, but not with sample collection, preservation, or storage procedures.
- 3.8 **Laboratory Fortified Blank (LFB)** - An aliquot of LRB to which known quantities of the method analytes are added in the laboratory. The LFB is analyzed exactly like a sample, and its purpose is to determine whether the methodology is in control and whether the laboratory is capable of making accurate and precise measurements (Sections 7.9 and 9.3.2).
- 3.9 **Laboratory Fortified Sample Matrix (LFM)** - An aliquot of an environmental sample to which known quantities of the method analytes are added in the laboratory. The LFM is analyzed exactly like a sample, and its purpose is to determine whether the sample matrix contributes bias to the analytical results. The background concentrations of the analytes in the sample matrix must be determined in a separate aliquot and the measured values in the LFM corrected for background concentrations (Section 9.4).
- 3.10 **Laboratory Reagent Blank (LRB)** - An aliquot of reagent water or other blank matrices that are treated exactly as a sample including exposure to all glassware, equipment, solvents, reagents, and internal standards that are used with other samples. The LRB is used to determine if method analytes or other interferences

are present in the laboratory environment, reagents, or apparatus (Sections 7.6.2 and 9.3.1).

- 3.11 **Linear Dynamic Range (LDR)** - The concentration range over which the instrument response to an analyte is linear (Section 9.2.2).
- 3.12 **Method Detection Limit (MDL)** - The minimum concentration of an analyte that can be identified, measured, and reported with 99% confidence that the analyte concentration is greater than zero (Section 9.2.4 and Table 7).
- 3.13 **Quality Control Sample (QCS)** - A solution of method analytes of known concentrations which is used to fortify an aliquot of LRB or sample matrix. The QCS is obtained from a source external to the laboratory and different from the source of calibration standards. It is used to check either laboratory or instrument performance (Sections 7.8 and 9.2.3).
- 3.14 **Solid Sample** - For the purpose of this method, a sample taken from material classified as either soil, sediment or sludge.
- 3.15 **Stock Standard Solution** - A concentrated solution containing one or more method analytes prepared in the laboratory using assayed reference materials or purchased from a reputable commercial source (Section 7.3).
- 3.16 **Total Recoverable Analyte** - The concentration of analyte determined either by "direct analysis" of an unfiltered acid preserved drinking water sample with turbidity of <1 NTU (Section 11.2.1), or by analysis of the solution extract of a solid sample or an unfiltered aqueous sample following digestion by refluxing with hot dilute mineral acid(s) as specified in the method (Sections 11.2 and 11.3).
- 3.17 **Tuning Solution** - A solution which is used to determine acceptable instrument performance prior to calibration and sample analyses (Section 7.7).
- 3.18 **Water Sample** - For the purpose of this method, a sample taken from one of the following sources: drinking, surface, ground, storm runoff, industrial or domestic wastewater.

4.0 INTERFERENCES

- 4.1 Several interference sources may cause inaccuracies in the determination of trace elements by ICP-MS. These are:
 - 4.1.1 Isobaric elemental interferences - Are caused by isotopes of different elements which form singly or doubly charged ions of the same nominal mass-to-charge ratio and which cannot be resolved by the mass spectrometer in use. All elements determined by this method have, at a minimum, one isotope free of isobaric elemental interference. Of the analytical isotopes recommended for use with this method (Table 4), only molybdenum-98 (ruthenium) and selenium-82 (krypton) have isobaric elemental interferences. If alternative analytical isotopes having higher

natural abundance are selected in order to achieve greater sensitivity, an isobaric interference may occur. All data obtained under such conditions must be corrected by measuring the signal from another isotope of the interfering element and subtracting the appropriate signal ratio from the isotope of interest. A record of this correction process should be included with the report of the data. It should be noted that such corrections will only be as accurate as the accuracy of the isotope ratio used in the elemental equation for data calculations. Relevant isotope ratios should be established prior to the application of any corrections.

- 4.1.2 Abundance sensitivity - Is a property defining the degree to which the wings of a mass peak contribute to adjacent masses. The abundance sensitivity is affected by ion energy and quadrupole operating pressure. Wing overlap interferences may result when a small ion peak is being measured adjacent to a large one. The potential for these interferences should be recognized and the spectrometer resolution adjusted to minimize them.
- 4.1.3 Isobaric polyatomic ion interferences - Are caused by ions consisting of more than one atom which have the same nominal mass-to-charge ratio as the isotope of interest, and which cannot be resolved by the mass spectrometer in use. These ions are commonly formed in the plasma or interface system from support gases or sample components. Most of the common interferences have been identified³, and these are listed in Table 2 together with the method elements affected. Such interferences must be recognized, and when they cannot be avoided by the selection of alternative analytical isotopes, appropriate corrections must be made to the data. Equations for the correction of data should be established at the time of the analytical run sequence as the polyatomic ion interferences will be highly dependent on the sample matrix and chosen instrument conditions. In particular, the common ⁸²Kr interference that affects the determination of both arsenic and selenium, can be greatly reduced with the use of high purity krypton free argon.
- 4.1.4 Physical interferences - Are associated with the physical processes which govern the transport of sample into the plasma, sample conversion processes in the plasma, and the transmission of ions through the plasma-mass spectrometer interface. These interferences may result in differences between instrument responses for the sample and the calibration standards. Physical interferences may occur in the transfer of solution to the nebulizer (e.g., viscosity effects), at the point of aerosol formation and transport to the plasma (e.g., surface tension), or during excitation and ionization processes within the plasma itself. High levels of dissolved solids in the sample may contribute deposits of material on the extraction and/or skimmer cones reducing the effective diameter of the orifices and therefore ion transmission. Dissolved solids levels not exceeding 0.2% (w/v) have been recommended³ to reduce such effects. Internal standardization may be effectively used to compensate for many physical interference effects.⁴ Internal standards ideally should have similar

analytical behavior to the elements being determined.

- 4.1.5 Memory interferences - Result when isotopes of elements in a previous sample contribute to the signals measured in a new sample. Memory effects can result from sample deposition on the sampler and skimmer cones, and from the buildup of sample material in the plasma torch and spray chamber. The site where these effects occur is dependent on the element and can be minimized by flushing the system with a rinse blank between samples (Section 7.6.3). The possibility of memory interferences should be recognized within an analytical run and suitable rinse times should be used to reduce them. The rinse times necessary for a particular element should be estimated prior to analysis. This may be achieved by aspirating a standard containing elements corresponding to 10 times the upper end of the linear range for a normal sample analysis period, followed by analysis of the rinse blank at designated intervals. The length of time required to reduce analyte signals to within a factor of 10 of the method detection limit, should be noted. Memory interferences may also be assessed within an analytical run by using a minimum of three replicate integrations for data acquisition. If the integrated signal values drop consecutively, the analyst should be alerted to the possibility of a memory effect, and should examine the analyte concentration in the previous sample to identify if this was high. If a memory interference is suspected, the sample should be reanalyzed after a long rinse period. In the determination of mercury, which suffers from severe memory effects, the addition of 100 µg/L gold will effectively rinse 5 µg/L mercury in approximately two minutes. Higher concentrations will require a longer rinse time.

5.0 SAFETY

- 5.1 The toxicity or carcinogenicity of reagents used in this method have not been fully established. Each chemical should be regarded as a potential health hazard and exposure to these compounds should be as low as reasonably achievable. Each laboratory is responsible for maintaining a current awareness file of OSHA regulations regarding the safe handling of the chemicals specified in this method.^{5,8} A reference file of material data handling sheets should also be available to all personnel involved in the chemical analysis. Specifically, concentrated nitric and hydrochloric acids present various hazards and are moderately toxic and extremely irritating to skin and mucus membranes. Use these reagents in a fume hood whenever possible and if eye or skin contact occurs, flush with large volumes of water. Always wear safety glasses or a shield for eye protection, protective clothing and observe proper mixing when working with these reagents.
- 5.2 The acidification of samples containing reactive materials may result in the release of toxic gases, such as cyanides or sulfides. Acidification of samples should be done in a fume hood.
- 5.3 All personnel handling environmental samples known to contain or to have been

in contact with human waste should be immunized against known disease causative agents.

- 5.4 Analytical plasma sources emit radiofrequency radiation in addition to intense UV radiation. Suitable precautions should be taken to protect personnel from such hazards. The inductively coupled plasma should only be viewed with proper eye protection from UV emissions.
- 5.5 It is the responsibility of the user of this method to comply with relevant disposal and waste regulations. For guidance see Sections 14.0 and 15.0.

6.0 EQUIPMENT AND SUPPLIES

6.1 Inductively coupled plasma mass spectrometer:

- 6.1.1 Instrument capable of scanning the mass range 5-250 amu with a minimum resolution capability of 1 amu peak width at 5% peak height. Instrument may be fitted with a conventional or extended dynamic range detection system.

Note: If an electron multiplier detector is being used, precautions should be taken, where necessary, to prevent exposure to high ion flux. Otherwise changes in instrument response or damage to the multiplier may result.

- 6.1.2 Radio-frequency generator compliant with FCC regulations.
 - 6.1.3 Argon gas supply - High purity grade (99.99%). When analyses are conducted frequently, liquid argon is more economical and requires less frequent replacement of tanks than compressed argon in conventional cylinders (Section 4.1.3).
 - 6.1.4 A variable-speed peristaltic pump is required for solution delivery to the nebulizer.
 - 6.1.5 A mass-flow controller on the nebulizer gas supply is required. A water-cooled spray chamber may be of benefit in reducing some types of interferences (e.g., from polyatomic oxide species).
 - 6.1.6 If an electron multiplier detector is being used, precautions should be taken, where necessary, to prevent exposure to high ion flux. Otherwise changes in instrument response or damage to the multiplier may result. Samples having high concentrations of elements beyond the linear range of the instrument and with isotopes falling within scanning windows should be diluted prior to analysis.
- 6.2 Analytical balance, with capability to measure to 0.1 mg, for use in weighing solids, for preparing standards, and for determining dissolved solids in digests or extracts.

- 6.3 A temperature adjustable hot plate capable of maintaining a temperature of 95°C.
- 6.4 (Optional) A temperature adjustable block digester capable of maintaining a temperature of 95°C and equipped with 250 mL constricted digestion tubes.
- 6.5 (Optional) A steel cabinet centrifuge with guard bowl, electric timer and brake.
- 6.6 A gravity convection drying oven with thermostatic control capable of maintaining 105°C ± 5°C.
- 6.7 (Optional) An air displacement pipetter capable of delivering volumes ranging from 0.1-2500 µL with an assortment of high quality disposable pipet tips.
- 6.8 Mortar and pestle, ceramic or nonmetallic material.
- 6.9 Polypropylene sieve, 5-mesh (4 mm opening).
- 6.10 Labware - For determination of trace levels of elements, contamination and loss are of prime consideration. Potential contamination sources include improperly cleaned laboratory apparatus and general contamination within the laboratory environment from dust, etc. A clean laboratory work area designated for trace element sample handling must be used. Sample containers can introduce positive and negative errors in the determination of trace elements by (1) contributing contaminants through surface desorption or leaching, (2) depleting element concentrations through adsorption processes. All reusable labware (glass, quartz, polyethylene, PTFE, FEP, etc.) should be sufficiently clean for the task objectives. Several procedures found to provide clean labware include soaking overnight and thoroughly washing with laboratory-grade detergent and water, rinsing with tap water, and soaking for four hours or more in 20% (V/V) nitric acid or a mixture of dilute nitric and hydrochloric acid (1+2+9), followed by rinsing with reagent grade water and storing clean.

Note: Chromic acid must not be used for cleaning glassware.

- 6.10.1 Glassware - Volumetric flasks, graduated cylinders, funnels and centrifuge tubes (glass and/or metal free plastic).
- 6.10.2 Assorted calibrated pipettes.
- 6.10.3 Conical Phillips beakers (Corning 1080-250 or equivalent), 250 mL with 50 mm watch glasses.
- 6.10.4 Griffin beakers, 250 mL with 75 mm watch glasses and (optional) 75 mm ribbed watch glasses.
- 6.10.5 (Optional) PTFE and/or quartz beakers, 250 mL with PTFE covers.
- 6.10.6 Evaporating dishes or high-form crucibles, porcelain, 100 mL capacity.

6.10.7 Narrow-mouth storage bottles, FEP (fluorinated ethylene propylene) with ETFE (ethylene tetrafluorethylene) screw closure, 125-250 mL capacities.

6.10.8 One-piece stem FEP wash bottle with screw closure, 125 mL capacity.

7.0 REAGENTS AND STANDARDS

7.1 Reagents may contain elemental impurities that might affect the integrity of analytical data. Owing to the high sensitivity of ICP-MS, high-purity reagents should be used whenever possible. All acids used for this method must be of ultra high-purity grade. Suitable acids are available from a number of manufacturers or may be prepared by sub-boiling distillation. Nitric acid is preferred for ICP-MS in order to minimize polyatomic ion interferences. Several polyatomic ion interferences result when hydrochloric acid is used (Table 2), however, it should be noted that hydrochloric acid is required to maintain stability in solutions containing antimony and silver. When hydrochloric acid is used, corrections for the chloride polyatomic ion interferences must be applied to all data.

7.1.1 Nitric acid, concentrated (sp.gr. 1.41).

7.1.2 Nitric acid (1+1) - Add 500 mL conc. nitric acid to 400 mL of reagent grade water and dilute to 1 L.

7.1.3 Nitric acid (1+9) - Add 100 mL conc. nitric acid to 400 mL of reagent grade water and dilute to 1 L.

7.1.4 Hydrochloric acid, concentrated (sp.gr. 1.19).

7.1.5 Hydrochloric acid (1+1) - Add 500 mL conc. hydrochloric acid to 400 mL of reagent grade water and dilute to 1 L.

7.1.6 Hydrochloric acid (1+4) - Add 200 mL conc. hydrochloric acid to 400 mL of reagent grade water and dilute to 1 L.

7.1.7 Ammonium hydroxide, concentrated (sp.gr. 0.902).

7.1.8 Tartaric acid (CASRN 87-69-4).

7.2 Reagent water - All references to reagent grade water in this method refer to ASTM Type I water (ASTM D1193).⁹ Suitable water may be prepared by passing distilled water through a mixed bed of anion and cation exchange resins.

7.3 Standard Stock Solutions - Stock standards may be purchased from a reputable commercial source or prepared from ultra high-purity grade chemicals or metals (99.99-99.999% pure). All salts should be dried for one hour at 105°C, unless otherwise specified. Stock solutions should be stored in FEP bottles. Replace stock standards when succeeding dilutions for preparation of the multielement stock standards can not be verified.

CAUTION: Many metal salts are extremely toxic if inhaled or swallowed. Wash hands thoroughly after handling.

The following procedures may be used for preparing standard stock solutions:

Note: Some metals, particularly those which form surface oxides require cleaning prior to being weighed. This may be achieved by pickling the surface of the metal in acid. An amount in excess of the desired weight should be pickled repeatedly, rinsed with water, dried and weighed until the desired weight is achieved.

- 7.3.1 Aluminum solution, stock 1 mL = 1000 µg Al: Pickle aluminum metal in warm (1+1) HCl to an exact weight of 0.100 g. Dissolve in 10 mL conc. HCl and 2 mL conc. nitric acid, heating to effect solution. Continue heating until volume is reduced to 4 mL. Cool and add 4 mL reagent grade water. Heat until the volume is reduced to 2 mL. Cool and dilute to 100 mL with reagent grade water.
- 7.3.2 Antimony solution, stock 1 mL = 1000 µg Sb: Dissolve 0.100 g antimony powder in 2 mL (1+1) nitric acid and 0.5 mL conc. hydrochloric acid, heating to effect solution. Cool, add 20 mL reagent grade water and 0.15 g tartaric acid. Warm the solution to dissolve the white precipitate. Cool and dilute to 100 mL with reagent grade water.
- 7.3.3 Arsenic solution, stock 1 mL = 1000 µg As: Dissolve 0.1320 g As₂O₃ in a mixture of 50 mL reagent grade water and 1 mL conc. ammonium hydroxide. Heat gently to dissolve. Cool and acidify the solution with 2 mL conc. nitric acid. Dilute to 100 mL with reagent grade water.
- 7.3.4 Barium solution, stock 1 mL = 1000 µg Ba: Dissolve 0.1437 g BaCO₃ in a solution mixture of 10 mL reagent grade water and 2 mL conc. nitric acid. Heat and stir to effect solution and degassing. Dilute to 100 mL with reagent grade water.
- 7.3.5 Beryllium solution, stock 1 mL = 1000 µg Be: Dissolve 1.965 g BeSO₄•4H₂O (DO NOT DRY) in 50 mL reagent grade water. Add 1 mL conc. nitric acid. Dilute to 100 mL with reagent grade water.
- 7.3.6 Bismuth solution, stock 1 mL = 1000 µg Bi: Dissolve 0.1115 g Bi₂O₃ in 5 mL conc. nitric acid. Heat to effect solution. Cool and dilute to 100 mL with reagent grade water.
- 7.3.7 Cadmium solution, stock 1 mL = 1000 µg Cd: Pickle cadmium metal in (1+9) nitric acid to an exact weight of 0.100 g. Dissolve in 5 mL (1+1) nitric acid, heating to effect solution. Cool and dilute to 100 mL with reagent grade water.
- 7.3.8 Chromium solution, stock 1 mL = 1000 µg Cr: Dissolve 0.1923 g CrO₃ in a solution mixture of 10 mL reagent grade water and 1 mL conc. nitric

acid. Dilute to 100 mL with reagent grade water.

- 7.3.9 Cobalt solution, stock 1 mL = 1000 µg Co: Pickle cobalt metal in (1+9) nitric acid to an exact weight of 0.100 g. Dissolve in 5 mL (1+1) nitric acid, heating to effect solution. Cool and dilute to 100 mL with reagent grade water.
- 7.3.10 Copper solution, stock 1 mL = 1000 µg Cu: Pickle copper metal in (1+9) nitric acid to an exact weight of 0.100 g. Dissolve in 5 mL (1+1) nitric acid, heating to effect solution. Cool and dilute to 100 mL with reagent grade water.
- 7.3.11 Gold solution, stock 1 mL = 1000 µg Au: Dissolve 0.100 g high purity (99.9999%) Au shot in 10 mL of hot conc. nitric acid by dropwise addition of 5 mL conc. HCl and then reflux to expel oxides of nitrogen and chlorine. Cool and dilute to 100 mL with reagent grade water.
- 7.3.12 Indium solution, stock 1 mL = 1000 µg In: Pickle indium metal in (1+1) nitric acid to an exact weight of 0.100 g. Dissolve in 10 mL (1+1) nitric acid, heating to effect solution. Cool and dilute to 100 mL with reagent grade water.
- 7.3.13 Lead solution, stock 1 mL = 1000 µg Pb: Dissolve 0.1599 g PbNO₃ in 5 mL (1+1) nitric acid. Dilute to 100 mL with reagent grade water.
- 7.3.14 Magnesium solution, stock 1 mL = 1000 µg Mg: Dissolve 0.1658 g MgO in 10 mL (1+1) nitric acid, heating to effect solution. Cool and dilute to 100 mL with reagent grade water.
- 7.3.15 Manganese solution, stock 1 mL = 1000 µg Mn: Pickle manganese flake in (1+9) nitric acid to an exact weight of 0.100 g. Dissolve in 5 mL (1+1) nitric acid, heating to effect solution. Cool and dilute to 100 mL with reagent grade water.
- 7.3.16 Mercury solution, stock, 1 mL = 1000 µg Hg: **DO NOT DRY**. **CAUTION:** highly toxic element. Dissolve 0.1354 g HgCl₂ in reagent water. Add 5.0 mL concentrated HNO₃ and dilute to 100 mL with reagent water.
- 7.3.17 Molybdenum solution, stock 1 mL = 1000 µg Mo: Dissolve 0.1500 g MoO₃ in a solution mixture of 10 mL reagent grade water and 1 mL conc. ammonium hydroxide., heating to effect solution. Cool and dilute to 100 mL with reagent grade water.
- 7.3.18 Nickel solution, stock 1 mL = 1000 µg Ni: Dissolve 0.100 g nickel powder in 5 mL conc. nitric acid, heating to effect solution. Cool and dilute to 100 mL with reagent grade water.
- 7.3.19 Scandium solution, stock 1 mL = 1000 µg Sc: Dissolve 0.1534 g Sc₂O₃ in 5 mL (1+1) nitric acid, heating to effect solution. Cool and dilute to

100 mL with reagent grade water.

- 7.3.20 Selenium solution, stock 1 mL = 1000 µg Se: Dissolve 0.1405 g SeO_2 in 20 mL ASTM Type I water. Dilute to 100 mL with reagent grade water.
- 7.3.21 Silver solution, stock 1 mL = 1000 µg Ag: Dissolve 0.100 g silver metal in 5 mL (1+1) nitric acid, heating to effect solution. Cool and dilute to 100 mL with reagent grade water. Store in dark container.
- 7.3.22 Terbium solution, stock 1 mL = 1000 µg Tb: Dissolve 0.1176 g Tb_4O_7 in 5 mL conc. nitric acid, heating to effect solution. Cool and dilute to 100 mL with reagent grade water.
- 7.3.23 Thallium solution, stock 1 mL = 1000 µg Tl: Dissolve 0.1303 g TlNO_3 in a solution mixture of 10 mL reagent grade water and 1 mL conc. nitric acid. Dilute to 100 mL with reagent grade water.
- 7.3.24 Thorium solution, stock 1 mL = 1000 µg Th: Dissolve 0.2380 g $\text{Th}(\text{NO}_3)_4 \cdot 4\text{H}_2\text{O}$ (DO NOT DRY) in 20 mL reagent grade water. Dilute to 100 mL with reagent grade water.
- 7.3.25 Uranium solution, stock 1 mL = 1000 µg U: Dissolve 0.2110 g $\text{UO}_2(\text{NO}_3)_2 \cdot 6\text{H}_2\text{O}$ (DO NOT DRY) in 20 mL reagent grade water and dilute to 100 mL with reagent grade water.
- 7.3.26 Vanadium solution, stock 1 mL = 1000 µg V: Pickle vanadium metal in (1+9) nitric acid to an exact weight of 0.100 g. Dissolve in 5 mL (1+1) nitric acid, heating to effect solution. Cool and dilute to 100 mL with reagent grade water.
- 7.3.27 Yttrium solution, stock 1 mL = 1000 µg Y: Dissolve 0.1270 g Y_2O_3 in 5 mL (1+1) nitric acid, heating to effect solution. Cool and dilute to 100 mL with reagent grade water.
- 7.3.28 Zinc solution, stock 1 mL = 1000 µg Zn: Pickle zinc metal in (1+9) nitric acid to an exact weight of 0.100 g. Dissolve in 5 mL (1+1) nitric acid, heating to effect solution. Cool and dilute to 100 mL with reagent grade water.
- 7.4 Multielement Stock Standard Solutions - Care must be taken in the preparation of multielement stock standards that the elements are compatible and stable. Originating element stocks should be checked for the presence of impurities which might influence the accuracy of the standard. Freshly prepared standards should be transferred to acid cleaned, not previously used FEP fluorocarbon bottles for storage and monitored periodically for stability. The following combinations of elements are suggested:

Standard Solution A		Standard Solution B
Aluminum	Mercury	Barium
Antimony	Molybdenum	Silver
Arsenic	Nickel	
Beryllium	Selenium	
Cadmium	Thallium	
Chromium	Thorium	
Cobalt	Uranium	
Copper	Vanadium	
Lead	Zinc	
Manganese		

Except for selenium and mercury, multielement stock standard solutions A and B (1 mL = 10 µg) may be prepared by diluting 1.0 mL of each single element stock standard in the combination list to 100 mL with reagent water containing 1% (v/v) nitric acid. For mercury and selenium in solution A, aliquots of 0.05 mL and 5.0 mL of the respective stock standards should be diluted to the specified 100 mL (1 mL = 0.5 µg Hg and 50 µg Se). Replace the multielement stock standards when succeeding dilutions for preparation of the calibration standards cannot be verified with the quality control sample.

7.4.1 Preparation of calibration standards - fresh multielement calibration standards should be prepared every two weeks or as needed. Dilute each of the stock multielement standard solutions A and B to levels appropriate to the operating range of the instrument using reagent water containing 1% (v/v) nitric acid. The element concentrations in the standards should be sufficiently high to produce good measurement precision and to accurately define the slope of the response curve. Depending on the sensitivity of the instrument, concentrations ranging from 10-200 µg/L are suggested, except mercury, which should be limited to ≤5 µg/L. It should be noted the selenium concentration is always a factor of 5 greater than the other analytes. If the direct addition procedure is being used (Method A, Section 10.3), add internal standards (Section 7.5) to the calibration standards and store in FEP bottles. Calibration standards should be verified initially using a quality control sample (Section 7.8).

7.5 Internal Standards Stock Solution - 1 mL = 100 µg. Dilute 10 mL of scandium, yttrium, indium, terbium and bismuth stock standards (Section 7.3) to 100 mL with reagent water, and store in a FEP bottle. Use this solution concentrate for addition to blanks, calibration standards and samples, or dilute by an appropriate amount using 1% (v/v) nitric acid, if the internal standards are being added by peristaltic pump (Method B, Section 10.3).

Note: If mercury is to be determined by the "direct analysis" procedure, add an aliquot of the gold stock standard (Section 7.3.11) to the internal standard solution sufficient to provide a concentration of 100 µg/L in final the dilution of all blanks, calibration standards, and samples.

- 7.6 Blanks - Three types of blanks are required for this method. A calibration blank is used to establish the analytical calibration curve, the laboratory reagent blank is used to assess possible contamination from the sample preparation procedure and to assess spectral background and the rinse blank is used to flush the instrument between samples in order to reduce memory interferences.
- 7.6.1 Calibration blank - Consists of 1% (v/v) nitric acid in reagent grade water. If the direct addition procedure (Method A, Section 10.3) is being used, add internal standards.
- 7.6.2 Laboratory reagent blank (LRB) - Must contain all the reagents in the same volumes as used in processing the samples. The LRB must be carried through the same entire preparation scheme as the samples including digestion, when applicable. If the direct addition procedure (Method A, Section 10.3) is being used, add internal standards to the solution after preparation is complete.
- 7.6.3 Rinse blank - Consists of 2% (v/v) nitric acid in reagent grade water.
- Note:** If mercury is to be determined by the "direct analysis" procedure, add gold (Section 7.3.11) to the rinse blank to a concentration of 100 µg/L.
- 7.7 Tuning Solution - This solution is used for instrument tuning and mass calibration prior to analysis. The solution is prepared by mixing beryllium, magnesium, cobalt, indium and lead stock solutions (Section 7.3) in 1% (v/v) nitric acid to produce a concentration of 100 µg/L of each element. Internal standards are not added to this solution. (Depending on the sensitivity of the instrument, this solution may need to be diluted 10-fold.)
- 7.8 Quality Control Sample (QCS) - The QCS should be obtained from a source outside the laboratory. The concentration of the QCS solution analyzed will depend on the sensitivity of the instrument. To prepare the QCS dilute an appropriate aliquot of analytes to a concentration ≤100 µg/L in 1% (v/v) nitric acid. Because of lower sensitivity, selenium may be diluted to a concentration of <500 µg/L, however, in all cases, mercury should be limited to a concentration of ≤5 µg/L. If the direct addition procedure (Method A, Section 10.3) is being used, add internal standards after dilution, mix and store in a FEP bottle. The QCS should be analyzed as needed to meet data-quality needs and a fresh solution should be prepared quarterly or more frequently as needed.
- 7.9 Laboratory Fortified Blank (LFB) - To an aliquot of LRB, add aliquots from multielement stock standards A and B (Section 7.4) to prepared the LFB. Depending on the sensitivity of the instrument, the fortified concentration used should range from 40-100 µg/L for each analyte, except selenium and mercury. For selenium the concentration should range from 200-500 µg/L, while the concentration range mercury should be limited to 2-5 µg/L. The LFB must be carried through the same entire preparation scheme as the samples including sample digestion, when applicable. If the direct addition procedure (Method A, Section 10.3) is being used, add internal standards to this solution after

preparation has been completed.

8.0 SAMPLE COLLECTION, PRESERVATION, AND STORAGE

- 8.1 Prior to the collection of an aqueous sample, consideration should be given to the type of data required, (i.e., dissolved or total recoverable), so that appropriate preservation and pretreatment steps can be taken. The pH of all aqueous samples **must** be tested immediately prior to aliquoting for processing or "direct analysis" to ensure the sample has been properly preserved. If properly acid preserved, the sample can be held up to 6 months before analysis.
- 8.2 For the determination of dissolved elements, the sample must be filtered through a 0.45 µm pore diameter membrane filter at the time of collection or as soon thereafter as practically possible. Use a portion of the sample to rinse the filter flask, discard this portion and collect the required volume of filtrate. Acidify the filtrate with (1+1) nitric acid immediately following filtration to pH <2.
- 8.3 For the determination of total recoverable elements in aqueous samples, samples are **not** filtered, but acidified with (1+1) nitric acid to pH <2 (normally, 3 mL of (1+1) acid per liter of sample is sufficient for most ambient and drinking water samples). Preservation may be done at the time of collection, however, to avoid the hazards of strong acids in the field, transport restrictions, and possible contamination it is recommended that the samples be returned to the laboratory within two weeks of collection and acid preserved upon receipt in the laboratory. Following acidification, the sample should be mixed, held for 16 hours, and then verified to be pH <2 just prior withdrawing an aliquot for processing or "direct analysis". If for some reason such as high alkalinity the sample pH is verified to be >2, more acid must be added and the sample held for 16 hours until verified to be pH <2. See Section 8.1.
- Note:** When the nature of the sample is either unknown or known to be hazardous, acidification should be done in a fume hood. See Section 5.2.
- 8.4 Solid samples require no preservation prior to analysis other than storage at 4°C. There is no established holding time limitation for solid samples.
- 8.5 For aqueous samples, a field blank should be prepared and analyzed as required by the data user. Use the same container and acid as used in sample collection.

9.0 QUALITY CONTROL

- 9.1 Each laboratory using this method is required to operate a formal quality control (QC) program. The minimum requirements of this program consist of an initial demonstration of laboratory capability, and the periodic analysis of laboratory reagent blanks, fortified blanks and calibration solutions as a continuing check on performance. The laboratory is required to maintain performance records that define the quality of the data thus generated.
- 9.2 Initial Demonstration of Performance (mandatory)

- 9.2.1 The initial demonstration of performance is used to characterize instrument performance (determination of linear calibration ranges and analysis of quality control samples) and laboratory performance (determination of method detection limits) prior to analyses conducted by this method.
- 9.2.2 Linear calibration ranges - Linear calibration ranges are primarily detector limited. The upper limit of the linear calibration range should be established for each analyte by determining the signal responses from a minimum of three different concentration standards, one of which is close to the upper limit of the linear range. Care should be taken to avoid potential damage to the detector during this process. The linear calibration range which may be used for the analysis of samples should be judged by the analyst from the resulting data. The upper LDR limit should be an observed signal no more than 10% below the level extrapolated from lower standards. Determined sample analyte concentrations that are greater than 90% of the determined upper LDR limit must be diluted and reanalyzed. The LDRs should be verified whenever, in the judgement of the analyst, a change in analytical performance caused by either a change in instrument hardware or operating conditions would dictate they be redetermined.
- 9.2.3 Quality control sample (QCS) - When beginning the use of this method, on a quarterly basis or as required to meet data-quality needs, verify the calibration standards and acceptable instrument performance with the preparation and analyses of a QCS (Section 7.8). To verify the calibration standards the determined mean concentration from three analyses of the QCS must be within $\pm 10\%$ of the stated QCS value. If the QCS is used for determining acceptable on-going instrument performance, analysis of the QCS prepared to a concentration of 100 $\mu\text{g/L}$ must be within $\pm 10\%$ of the stated value or within the acceptance limits listed in Table 8, whichever is the greater. (If the QCS is not within the required limits, an immediate second analysis of the QCS is recommended to confirm unacceptable performance.) If the calibration standards and/or acceptable instrument performance cannot be verified, the source of the problem must be identified and corrected before either proceeding on with the initial determination of method detection limits or continuing with on-going analyses.
- 9.2.4 Method detection limits (MDL) should be established for all analytes, using reagent water (blank) fortified at a concentration of two to five times the estimated detection limit.⁷ To determine MDL values, take seven replicate aliquots of the fortified reagent water and process through the entire analytical method. Perform all calculations defined in the method and report the concentration values in the appropriate units. Calculate the MDL as follows:

$$\text{MDL} = (t) \times (S)$$

where:

t = Student's t value for a 99% confidence level and a standard deviation estimate with n-1 degrees of freedom [t = 3.14 for seven replicates]

S = standard deviation of the replicate analyses

Note: If additional confirmation is desired, reanalyze the seven replicate aliquots on two more nonconsecutive days and again calculate the MDL values for each day. An average of the three MDL values for each analyte may provide for a more appropriate MDL estimate. If the relative standard deviation (RSD) from the analyses of the seven aliquots is <10%, the concentration used to determine the analyte MDL may have been inappropriately high for the determination. If so, this could result in the calculation of an unrealistically low MDL. Concurrently, determination of MDL in reagent water represents a best case situation and does not reflect possible matrix effects of real world samples. However, successful analyses of LFMs (Section 9.4) can give confidence to the MDL value determined in reagent water. Typical single laboratory MDL values using this method are given in Table 7.

The MDLs must be sufficient to detect analytes at the required levels according to compliance monitoring regulation (Section 1.2). MDLs should be determined annually, when a new operator begins work or whenever, in the judgement of the analyst, a change in analytical performance caused by either a change in instrument hardware or operating conditions would dictate they be redetermined.

9.3 Assessing Laboratory Performance (mandatory)

9.3.1 Laboratory reagent blank (LRB) - The laboratory must analyze at least one LRB (Section 7.6.2) with each batch of 20 or fewer of samples of the same matrix. LRB data are used to assess contamination from the laboratory environment and to characterize spectral background from the reagents used in sample processing. LRB values that exceed the MDL indicate laboratory or reagent contamination should be suspected. When LRB values constitute 10% or more of the analyte level determined for a sample or is 2.2 times the analyte MDL whichever is greater, fresh aliquots of the samples must be prepared and analyzed again for the affected analytes after the source of contamination has been corrected and acceptable LRB values have been obtained.

9.3.2 Laboratory fortified blank (LFB) - The laboratory must analyze at least one LFB (Section 7.9) with each batch of samples. Calculate accuracy as percent recovery using the following equation:

$$R = \frac{\text{LFB} - \text{LRB}}{s} \times 100$$

where:

- R = percent recovery
- LFB = laboratory fortified blank
- LRB = laboratory reagent blank
- s = concentration equivalent of analyte added to fortify the LBR solution

If the recovery of any analyte falls outside the required control limits of 85-115%, that analyte is judged out of control, and the source of the problem should be identified and resolved before continuing analyses.

- 9.3.3 The laboratory must use LFB analyses data to assess laboratory performance against the required control limits of 85-115% (Section 9.3.2). When sufficient internal performance data become available (usually a minimum of 20-30 analyses), optional control limits can be developed from the mean percent recovery (\bar{x}) and the standard deviation (S) of the mean percent recovery. These data can be used to establish the upper and lower control limits as follows:

$$\text{UPPER CONTROL LIMIT} = \bar{x} + 3S$$

$$\text{LOWER CONTROL LIMIT} = \bar{x} - 3S$$

The optional control limits must be equal to or better than the required control limits of 85-115%. After each five to ten new recovery measurements, new control limits can be calculated using only the most recent 20-30 data points. Also, the standard deviation (S) data should be used to establish an on-going precision statement for the level of concentrations included in the LFB. These data must be kept on file and be available for review.

- 9.3.4 Instrument performance - For all determinations the laboratory must check instrument performance and verify that the instrument is properly calibrated on a continuing basis. To verify calibration run the calibration blank and calibration standards as surrogate samples immediately following each calibration routine, after every ten analyses and at the end of the sample run. The results of the analyses of the standards will indicate whether the calibration remains valid. The analysis of all analytes within the standard solutions must be within $\pm 10\%$ of calibration. If the calibration cannot be verified within the specified limits, the instrument must be recalibrated. (The instrument responses from the calibration check may be used for recalibration purposes, however, it must be verified before continuing sample analysis.) If the continuing calibration check is not confirmed within $\pm 15\%$, the previous 10 samples must be reanalyzed after recalibration. If the sample matrix is responsible for the calibration drift, it is recommended that the previous 10 samples are reanalyzed in groups of five between calibration checks to prevent a similar drift situation from occurring.

9.4 Assessing Analyte Recovery and Data Quality

- 9.4.1 Sample homogeneity and the chemical nature of the sample matrix can affect analyte recovery and the quality of the data. Taking separate aliquots from the sample for replicate and fortified analyses can in some cases assess the effect. Unless otherwise specified by the data user, laboratory or program, the following laboratory fortified matrix (LFM) procedure (Section 9.4.2) is required.
- 9.4.2 The laboratory must add a known amount of analyte to a minimum of 10% of the routine samples. In each case the LFM aliquot must be a duplicate of the aliquot used for sample analysis and for total recoverable determinations added prior to sample preparation. For water samples, the added analyte concentration must be the same as that used in the laboratory fortified blank (Section 7.9). For solid samples, the concentration added should be 100 mg/kg equivalent (200 µg/L in the analysis solution) except silver which should be limited to 50 mg/kg (Section 1.8). Over time, samples from all routine sample sources should be fortified.
- 9.4.3 Calculate the percent recovery for each analyte, corrected for background concentrations measured in the unfortified sample, and compare these values to the designated LFM recovery range of 70-130%. Recovery calculations are not required if the concentration of the analyte added is less than 30% of the sample background concentration. Percent recovery may be calculated in units appropriate to the matrix, using the following equation:

$$R = \frac{C_s - C}{s} \times 100$$

where:

R = percent recovery

C_s = fortified sample concentration

C = sample background concentration

s = concentration equivalent of analyte added to fortify the sample

- 9.4.4 If recovery of any analyte falls outside the designated range and laboratory performance for that analyte is shown to be in control (Section 9.3), the recovery problem encountered with the fortified sample is judged to be matrix related, not system related. The data user should be informed that the result for that analyte in the unfortified sample is suspect due to either the heterogeneous nature of the sample or an uncorrected matrix effect.
- 9.4.5 Internal standards responses - The analyst is expected to monitor the responses from the internal standards throughout the sample set being

analyzed. Ratios of the internal standards responses against each other should also be monitored routinely. This information may be used to detect potential problems caused by mass dependent drift, errors incurred in adding the internal standards or increases in the concentrations of individual internal standards caused by background contributions from the sample. The absolute response of any one internal standard must not deviate more than 60-125% of the original response in the calibration blank. If deviations greater than these are observed, flush the instrument with the rinse blank and monitor the responses in the calibration blank. If the responses of the internal standards are now within the limit, take a fresh aliquot of the sample, dilute by a further factor of two, add the internal standards and reanalyze. If after flushing the response of the internal standards in the calibration blank are out of limits, terminate the analysis and determine the cause of the drift. Possible causes of drift may be a partially blocked sampling cone or a change in the tuning condition of the instrument.

10.0 CALIBRATION AND STANDARDIZATION

- 10.1 Operating conditions - Because of the diversity of instrument hardware, no detailed instrument operating conditions are provided. The analyst is advised to follow the recommended operating conditions provided by the manufacturer. It is the responsibility of the analyst to verify that the instrument configuration and operating conditions satisfy the analytical requirements and to maintain quality control data verifying instrument performance and analytical results. Instrument operating conditions which were used to generate precision and recovery data for this method (Section 13.0) are included in Table 6.
- 10.2 Precalibration routine - The following precalibration routine must be completed prior to calibrating the instrument until such time it can be documented with periodic performance data that the instrument meets the criteria listed below without daily tuning.
- 10.2.1 Initiate proper operating configuration of instrument and data system. Allow a period of not less than 30 minutes for the instrument to warm up. During this process conduct mass calibration and resolution checks using the tuning solution. Resolution at low mass is indicated by magnesium isotopes 24, 25, and 26. Resolution at high mass is indicated by lead isotopes 206, 207, and 208. For good performance adjust spectrometer resolution to produce a peak width of approximately 0.75 amu at 5% peak height. Adjust mass calibration if it has shifted by more than 0.1 amu from unit mass.
- 10.2.2 Instrument stability must be demonstrated by running the tuning solution (Section 7.7) a minimum of five times with resulting relative standard deviations of absolute signals for all analytes of less than 5%.
- 10.3 Internal Standardization - Internal standardization must be used in all analyses to correct for instrument drift and physical interferences. A list of acceptable

internal standards is provided in Table 3. For full mass range scans, a minimum of three internal standards must be used. Procedures described in this method for general application, detail the use of five internal standards; scandium, yttrium, indium, terbium and bismuth. These were used to generate the precision and recovery data attached to this method. Internal standards must be present in all samples, standards and blanks at identical levels. This may be achieved by directly adding an aliquot of the internal standards to the CAL standard, blank or sample solution (Method A, Section 10.3), or alternatively by mixing with the solution prior to nebulization using a second channel of the peristaltic pump and a mixing coil (Method B, Section 10.3). The concentration of the internal standard should be sufficiently high that good precision is obtained in the measurement of the isotope used for data correction and to minimize the possibility of correction errors if the internal standard is naturally present in the sample. Depending on the sensitivity of the instrument, a concentration range of 20-200 µg/L of each internal standard is recommended. Internal standards should be added to blanks, samples and standards in a like manner, so that dilution effects resulting from the addition may be disregarded.

- 10.4 Calibration - Prior to initial calibration, set up proper instrument software routines for quantitative analysis. The instrument must be calibrated using one of the internal standard routines (Method A or B) described in Section 10.3. The instrument must be calibrated for the analytes to be determined using the calibration blank (Section 7.6.1) and calibration standards A and B (Section 7.4.1) prepared at one or more concentration levels. A minimum of three replicate integrations are required for data acquisition. Use the average of the integrations for instrument calibration and data reporting.
- 10.5 The rinse blank should be used to flush the system between solution changes for blanks, standards and samples. Allow sufficient rinse time to remove traces of the previous sample (Section 4.1.5). Solutions should be aspirated for 30 seconds prior to the acquisition of data to allow equilibrium to be established.

11.0 PROCEDURE

11.1 Aqueous Sample Preparation - Dissolved Analytes

11.1.1 For the determination of dissolved analytes in ground and surface waters, pipet an aliquot (≥ 20 mL) of the filtered, acid preserved sample into a 50 mL polypropylene centrifuge tube. Add an appropriate volume of (1+1) nitric acid to adjust the acid concentration of the aliquot to approximate a 1% (v/v) nitric acid solution (e.g., add 0.4 mL (1+1) HNO₃ to a 20 mL aliquot of sample). If the direct addition procedure (Method A, Section 10.3) is being used, add internal standards, cap the tube and mix. The sample is now ready for analysis (Section 1.2). Allowance for sample dilution should be made in the calculations.

Note: If a precipitate is formed during acidification, transport, or storage, the sample aliquot must be treated using the procedure in Section 11.2 prior to analysis.

11.2 Aqueous Sample Preparation - Total Recoverable Analytes

11.2.1 For the "direct analysis" of total recoverable analytes in drinking water samples containing turbidity <1 NTU, treat an unfiltered acid preserved sample aliquot using the sample preparation procedure described in Section 11.1.1 while making allowance for sample dilution in the data calculation. For the determination of total recoverable analytes in all other aqueous samples or for preconcentrating drinking water samples prior to analysis follow the procedure given in Sections 11.2.2 through 11.2.8.

11.2.2 For the determination of total recoverable analytes in aqueous samples (other than drinking water with <1 NTU turbidity), transfer a 100 mL (± 1 mL) aliquot from a well mixed, acid preserved sample to a 250 mL Griffin beaker (Sections 1.2, 1.3, 1.7, and 1.8). (When necessary, smaller sample aliquot volumes may be used.)

Note: If the sample contains undissolved solids >1%, a well mixed, acid preserved aliquot containing no more than 1 g particulate material should be cautiously evaporated to near 10 mL and extracted using the acid-mixture procedure described in Sections 11.3.3 through 11.3.7.

11.2.3 Add 2 mL (1+1) nitric acid and 1.0 mL of (1+1) hydrochloric acid to the beaker containing the measured volume of sample. Place the beaker on the hot plate for solution evaporation. The hot plate should be located in a fume hood and previously adjusted to provide evaporation at a temperature of approximately but no higher than 85°C. (See the following note.) The beaker should be covered with an elevated watch glass or other necessary steps should be taken to prevent sample contamination from the fume hood environment.

Note: For proper heating adjust the temperature control of the hot plate such that an uncovered Griffin beaker containing 50 mL of water placed in the center of the hot plate can be maintained at a temperature approximately but no higher than 85°C. (Once the beaker is covered with a watch glass the temperature of the water will rise to approximately 95°C.)

11.2.4 Reduce the volume of the sample aliquot to about 20 mL by gentle heating at 85°C. DO NOT BOIL. This step takes about two hours for a 100 mL aliquot with the rate of evaporation rapidly increasing as the sample volume approaches 20 mL. (A spare beaker containing 20 mL of water can be used as a gauge.)

11.2.5 Cover the lip of the beaker with a watch glass to reduce additional evaporation and gently reflux the sample for 30 minutes. (Slight boiling may occur, but vigorous boiling must be avoided to prevent loss of the HCl-H₂O azeotrope.)

11.2.6 Allow the beaker to cool. Quantitatively transfer the sample solution to

a 50 mL volumetric flask or 50 mL class A stoppered graduated cylinder, make to volume with reagent water, stopper and mix.

- 11.2.7 Allow any undissolved material to settle overnight, or centrifuge a portion of the prepared sample until clear. (If after centrifuging or standing overnight the sample contains suspended solids that would clog the nebulizer, a portion of the sample may be filtered for their removal prior to analysis. However, care should be exercised to avoid potential contamination from filtration.)
- 11.2.8 Prior to analysis, adjust the chloride concentration by pipetting 20 mL of the prepared solution into a 50 mL volumetric flask, dilute to volume with reagent water and mix. (If the dissolved solids in this solution are >0.2%, additional dilution may be required to prevent clogging of the extraction and/or skimmer cones. If the direct addition procedure (Method A, Section 10.3) is being used, add internal standards and mix. The sample is now ready for analysis. Because the effects of various matrices on the stability of diluted samples cannot be characterized, all analyses should be performed as soon as possible after the completed preparation.

11.3 Solid Sample Preparation - Total Recoverable Analytes

- 11.3.1 For the determination of total recoverable analytes in solid samples, mix the sample thoroughly and transfer a portion (>20 g) to tared weighing dish, weigh the sample and record the wet weight (WW). (For samples with <35% moisture a 20 g portion is sufficient. For samples with moisture >35% a larger aliquot 50-100 g is required.) Dry the sample to a constant weight at 60°C and record the dry weight (DW) for calculation of percent solids (Section 12.6). (The sample is dried at 60°C to prevent the loss of mercury and other possible volatile metallic compounds, to facilitate sieving, and to ready the sample for grinding.)
- 11.3.2 To achieve homogeneity, sieve the dried sample using a 5-mesh polypropylene sieve and grind in a mortar and pestle. (The sieve, mortar and pestle should be cleaned between samples.) From the dried, ground material weigh accurately a representative 1.0 ± 0.01 g aliquot (W) of the sample and transfer to a 250 mL Phillips beaker for acid extraction.
- 11.3.3 To the beaker add 4 mL of (1+1) HNO₃ and 10 mL of (1+4) HCl. Cover the lip of the beaker with a watch glass. Place the beaker on a hot plate for reflux extraction of the analytes. The hot plate should be located in a fume hood and previously adjusted to provide a reflux temperature of approximately 95°C. (See the following note.)

Note: For proper heating adjust the temperature control of the hot plate such that an uncovered Griffin beaker containing 50 mL of water placed in the center of the hot plate can be maintained at a temperature approximately but no higher than 85°C. (Once the beaker is covered with a watch glass the temperature of the water will rise to approximately

95°C.) Also, a block digester capable of maintaining a temperature of 95°C and equipped with 250 mL constricted volumetric digestion tubes may be substituted for the hot plate and conical beakers in the extraction step.

- 11.3.4 Heat the sample and gently reflux for 30 minutes. Very slight boiling may occur, however vigorous boiling must be avoided to prevent loss of the HCl-H₂O azeotrope. Some solution evaporation will occur (3-4 mL).
- 11.3.5 Allow the sample to cool and quantitatively transfer the extract to a 100 mL volumetric flask. Dilute to volume with reagent water, stopper and mix.
- 11.3.6 Allow the sample extract solution to stand overnight to separate insoluble material or centrifuge a portion of the sample solution until clear. (If after centrifuging or standing overnight the extract solution contains suspended solids that would clog the nebulizer, a portion of the extract solution may be filtered for their removal prior to analysis. However, care should be exercised to avoid potential contamination from filtration.)
- 11.3.7 Prior to analysis, adjust the chloride concentration by pipetting 20 mL of the prepared solution into a 100 mL volumetric flask, dilute to volume with reagent water and mix. (If the dissolved solids in this solution are >0.2%, additional dilution may be required to prevent clogging of the extraction and/or skimmer cones. If the direct addition procedure (Method A, Section 10.3) is being used, add internal standards and mix. The sample extract is now ready for analysis. Because the effects of various matrices on the stability of diluted samples cannot be characterized, all analyses should be performed as soon as possible after the completed preparation.

Note: Determine the percent solids in the sample for use in calculations and for reporting data on a dry weight basis.

11.4 Sample Analysis

- 11.4.1 For every new or unusual matrix, it is highly recommended that a semi-quantitative analysis be carried out to screen the sample for elements at high concentration. Information gained from this may be used to prevent potential damage to the detector during sample analysis and to identify elements which may be higher than the linear range. Matrix screening may be carried out by using intelligent software, if available, or by diluting the sample by a factor of 500 and analyzing in a semi-quantitative mode. The sample should also be screened for background levels of all elements chosen for use as internal standards in order to prevent bias in the calculation of the analytical data.
- 11.4.2 Initiate instrument operating configuration. Tune and calibrate the instrument for the analytes of interest (Section 10.0).

- 11.4.3 Establish instrument software run procedures for quantitative analysis. For all sample analyses, a minimum of three replicate integrations are required for data acquisition. Use the average of the integrations for data reporting.
- 11.4.4 All masses which might affect data quality must be monitored during the analytical run. As a minimum, those masses prescribed in Table 4 must be monitored in the same scan as is used for the collection of the data. This information should be used to correct the data for identified interferences.
- 11.4.5 During the analysis of samples, the laboratory must comply with the required quality control described in Sections 9.3 and 9.4. Only for the determination of dissolved analytes or the "direct analysis" of drinking water with turbidity of <1 NTU is the sample digestion step of the LRB, LFB, and LFM not required.
- 11.4.6 The rinse blank should be used to flush the system between samples. Allow sufficient time to remove traces of the previous sample or a minimum of one minute (Section 4.1.5). Samples should be aspirated for 30 seconds prior to the collection of data.
- 11.4.7 Samples having concentrations higher than the established linear dynamic range should be diluted into range and reanalyzed. The sample should first be analyzed for the trace elements in the sample, protecting the detector from the high concentration elements, if necessary, by the selection of appropriate scanning windows. The sample should then be diluted for the determination of the remaining elements. Alternatively, the dynamic range may be adjusted by selecting an alternative isotope of lower natural abundance, provided quality control data for that isotope have been established. The dynamic range must not be adjusted by altering instrument conditions to an uncharacterized state.

12.0 DATA ANALYSIS AND CALCULATIONS

- 12.1 Elemental equations recommended for sample data calculations are listed in Table 5. Sample data should be reported in units of $\mu\text{g/L}$ for aqueous samples or mg/kg dry weight for solid samples. Do not report element concentrations below the determined MDL.
- 12.2 For data values less than 10, two significant figures should be used for reporting element concentrations. For data values greater than or equal to 10, three significant figures should be used.
- 12.3 For aqueous samples prepared by total recoverable procedure (Section 11.2), multiply solution concentrations by the dilution factor 1.25. If additional dilutions were made to any samples or an aqueous sample was prepared using the acid-mixture procedure described in Section 11.3, the appropriate factor should be applied to the calculated sample concentrations.

- 12.4 For total recoverable analytes in solid samples (Section 11.3), round the solution analyte concentrations ($\mu\text{g/L}$ in the analysis solution) as instructed in Section 12.2. Multiply the $\mu\text{g/L}$ concentrations in the analysis solution by the factor 0.005 to calculate the mg/L analyte concentration in the 100 mL extract solution. (If additional dilutions were made to any samples, the appropriate factor should be applied to calculate analyte concentrations in the extract solution.) Report the data up to three significant figures as mg/kg dry-weight basis unless specified otherwise by the program or data user. Calculate the concentration using the equation below:

$$\text{Sample Conc. (mg/kg)}_{\text{dry-weight basis}} = \frac{C \times V}{W}$$

where:

C = Concentration in the extract (mg/L)

V = Volume of extract (L, 100 mL = 0.1L)

W = Weight of sample aliquot extracted ($\text{g} \times 0.001 = \text{kg}$)

Do not report analyte data below the estimated solids MDL or an adjusted MDL because of additional dilutions required to complete the analysis.

- 12.5 To report percent solids in solid samples (Sect. 11.3) calculate as follows:

$$\% \text{ solids (S)} = \frac{DW}{WW} \times 100$$

where:

DW = Sample weight (g) dried at 60°C

WW = Sample weight (g) before drying

Note: If the data user, program or laboratory requires that the reported percent solids be determined by drying at 105°C , repeat the procedure given in Section 11.3 using a separate portion (>20 g) of the sample and dry to constant weight at $103\text{-}105^\circ\text{C}$.

- 12.6 Data values should be corrected for instrument drift or sample matrix induced interferences by the application of internal standardization. Corrections for characterized spectral interferences should be applied to the data. Chloride interference corrections should be made on all samples, regardless of the addition of hydrochloric acid, as the chloride ion is a common constituent of environmental samples.
- 12.7 If an element has more than one monitored isotope, examination of the concentration calculated for each isotope, or the isotope ratios, will provide useful information for the analyst in detecting a possible spectral interference.

Consideration should therefore be given to both primary and secondary isotopes in the evaluation of the element concentration. In some cases, secondary isotopes may be less sensitive or more prone to interferences than the primary recommended isotopes, therefore differences between the results do not necessarily indicate a problem with data calculated for the primary isotopes.

- 12.8 The QC data obtained during the analyses provide an indication of the quality of the sample data and should be provided with the sample results.

13.0 METHOD PERFORMANCE

- 13.1 Instrument operating conditions used for single laboratory testing of the method are summarized in Table 6. Total recoverable digestion and "direct analysis" MDLs determined using the procedure described in Section 9.2.4, are listed in Table 7.
- 13.2 Data obtained from single laboratory testing of the method are summarized in Table 9 for five water samples representing drinking water, surface water, ground water and waste effluent. Samples were prepared using the procedure described in Section 11.2. For each matrix, five replicates were analyzed and the average of the replicates used for determining the sample background concentration for each element. Two further pairs of duplicates were fortified at different concentration levels. For each method element, the sample background concentration, mean percent recovery, the standard deviation of the percent recovery and the relative percent difference between the duplicate fortified samples are listed in Table 8.
- 13.3 Data obtained from single laboratory testing of the method are summarized in Table 10 for three solid samples consisting of SRM 1645 River Sediment, EPA Hazardous Soil and EPA Electroplating Sludge. Samples were prepared using the procedure described in Section 11.3. For each method element, the sample background concentration, mean percent recovery, the standard deviation of the percent recovery and the relative percent difference between the duplicate fortified samples were determined as for Section 13.2.
- 13.4 Data obtained from single laboratory testing of the method for drinking water analysis using the "direct analysis" procedure (Section 11.2.1) are given in Table 11. Three drinking water samples of varying hardness collected from Regions 4, 6, and 10 were fortified to contain 1 µg/L of all metal primary contaminants, except selenium, which was added to a concentration of 20 µg/L. For each matrix, four replicate aliquots were analyzed to determine the sample background concentration of each analyte and four fortified aliquots were analyzed to determine mean percent recovery in each matrix. Listed in the Table 11 are the average mean percent recovery of each analyte in the three matrices and the standard deviation of the mean percent recoveries.
- 13.5 Listed in Table 12 are the regression equations for precision and bias developed from the joint USEPA/Association of Official Analytical Chemists (AOAC) multilaboratory validation study conducted on this method. These equations

were developed from data received from 13 laboratories on reagent water, drinking water and ground water. Listed in Tables 13 and 14, respectively, are the precision and recovery data from a wastewater digestate supplied to all laboratories and from a wastewater of the participant's choice. For a complete review of the study see Reference 11, Section 16.0 of this method.

14.0 POLLUTION PREVENTION

- 14.1 Pollution prevention encompasses any technique that reduces or eliminates the quantity or toxicity of waste at the point of generation. Numerous opportunities for pollution prevention exist in laboratory operation. The EPA has established a preferred hierarchy of environmental management techniques that places pollution prevention as the management option of first choice. Whenever feasible, laboratory personnel should use pollution prevention techniques to address their waste generation. When wastes cannot be feasibly reduced at the source, the Agency recommends recycling as the next best option.
- 14.2 For information about pollution prevention that may be applicable to laboratories and research institutions, consult "Less is Better: Laboratory Chemical Management for Waste Reduction", available from the American Chemical Society's Department of Government Relations and Science Policy, 1155 16th Street N.W., Washington D.C. 20036, (202)872-4477.

15.0 WASTE MANAGEMENT

- 15.1 The Environmental Protection Agency requires that laboratory waste management practices be conducted consistent with all applicable rules and regulations. The Agency urges laboratories to protect the air, water, and land by minimizing and controlling all releases from hoods and bench operations, complying with the letter and spirit of any sewer discharge permits and regulations, and by complying with all solid and hazardous waste regulations, particularly the hazardous waste identification rules and land disposal restrictions. For further information on waste management consult "The Waste Management Manual for Laboratory Personnel", available from the American Chemical Society at the address listed in the Section 14.2.

16.0 REFERENCES

1. Gray, A.L. and A. R. Date. Inductively Coupled Plasma Source Mass Spectrometry Using Continuum Flow Ion Extraction. *Analyst* 108 1033-1050, 1983.
2. Houk, R.S. et al. Inductively Coupled Argon Plasma as an Ion Source for Mass Spectrometric Determination of Trace Elements. *Anal Chem.* 52 2283-2289, 1980.
3. Houk, R.S. Mass Spectrometry of Inductively Coupled Plasmas. *Anal. Chem.* 58 97A-105A, 1986.
4. Thompson, J.J. and R. S. Houk. A Study of Internal Standardization in Inductively Coupled Plasma-Mass Spectrometry. *Appl. Spec.* 41 801-806, 1987.

5. Carcinogens - Working With Carcinogens, Department of Health, Education, and Welfare, Public Health Service, Center for Disease Control, National Institute for Occupational Safety and Health, Publication No. 77-206, Aug. 1977. Available from the National Technical Information Service (NTIS) as PB-277256.
6. OSHA Safety and Health Standards, General Industry, (29 CFR 1910), Occupational Safety and Health Administration, OSHA 2206, (Revised, January 1976).
7. Safety in Academic Chemistry Laboratories, American Chemical Society Publication, Committee on Chemical Safety, 3rd Edition, 1979.
8. Proposed OSHA Safety and Health Standards, Laboratories, Occupational Safety and Health Administration, Federal Register, July 24, 1986.
9. American Society for Testing and Materials. Standard Specification for Reagent Water, D1193-77. Annual Book of ASTM Standards, Vol. 11.01. Philadelphia, PA, 1991.
10. Code of Federal Regulations 40, Ch. 1, Pt. 136 Appendix B.
11. Longbottom, J.E. et. al. Determination of Trace Elements in Water by Inductively Coupled Plasma-Mass Spectrometry: Collaborative Study, Journal of AOAC International 77 1004-1023, 1994.
12. Hinnners, T.A. Interferences in ICP-MS by Bromine Species. Winter Conference on Plasma Spectrochemistry, San Diego, CA, January, 10-15, 1994.

17.0 TABLES, DIAGRAMS, FLOWCHARTS, AND VALIDATION DATA**TABLE 1: ESTIMATED INSTRUMENT DETECTION LIMITS**

Element	Recommended Analytical Mass	Scanning Mode¹	Selection Ion Monitoring Mode^{2,3}
Aluminum	27	0.05	0.02
Antimony	123	0.08	0.008
Arsenic ⁽³⁾	75	0.9	0.02
Barium	137	0.5	0.03
Beryllium	9	0.1	0.02
Cadmium	111	0.1	0.02
Chromium	52	0.07	0.04
Cobalt	59	0.03	0.002
Copper	63	0.03	0.004
Lead	206, 207, 208	0.08	0.015
Manganese	55	0.1	0.007
Mercury	202	n.a	0.2
Molybdenum	98	0.1	0.005
Nickel	60	0.2	0.07
Selenium ⁽³⁾	82	5	1.3
Silver	107	0.05	0.004
Thallium	205	0.09	0.014
Thorium	232	0.03	0.005
Uranium	238	0.02	0.005
Vanadium	51	0.02	0.006
Zinc	66	0.2	0.07

Instrument detection limits (3σ) estimated from seven replicate integrations of the blank (1% v/v nitric acid) following calibration of the instrument with three replicate integrations of a multi-element standard.

¹Instrument operating conditions and data acquisition mode are given in Table 6.

²IDLs determined using state-of-the-art instrumentation (1994). Data for ⁷⁵As, ⁷⁷Se, and ⁸²Se were acquired using a dwell time of 4.096 seconds with 1500 area count per sec ⁸³Kr present in argon supply. All other data were acquired using a dwell time of 1.024 seconds per AMU monitored.

TABLE 2: COMMON MOLECULAR ION INTERFERENCES IN ICP-MS

BACKGROUND MOLECULAR IONS

Molecular Ion	Mass	Element Interference ^a
NH ⁺	15	
OH ⁺	17	
OH ₂ ⁺	18	
C ₂ ⁺	24	
CN ⁺	26	
CO ⁺	28	
N ₂ ⁺	28	
N ₂ H ⁺	29	
NO ⁺	30	
NOH ⁺	31	
O ₂ ⁺	32	
O ₂ H ⁺	33	
³⁶ ArH ⁺	37	
³⁸ ArH ⁺	39	
⁴⁰ ArH ⁺	41	
CO ₂ ⁺	44	
CO ₂ H ⁺	45	Sc
ArC ⁺ , ArO ⁺	52	Cr
ArN ⁺	54	Cr
ArNH ⁺	55	Mn
ArO ⁺	56	
ArOH ⁺	57	
⁴⁰ Ar ³⁶ Ar ⁺	76	Se
⁴⁰ Ar ³⁸ Ar ⁺	78	Se
⁴⁰ Ar ⁺	80	Se

^amethod elements or internal standards affected by the molecular ions.

TABLE 2: COMMON MOLECULAR ION INTERFERENCES IN ICP-MS (Cont'd)

MATRIX MOLECULAR IONS		
Molecular Ion	Mass	Element Interference^a
Bromide¹²		
$^{81}\text{BrH}^+$	82	Se
$^{79}\text{BrO}^+$	95	Mo
$^{81}\text{BrO}^+$	97	Mo
$^{81}\text{BrOH}^+$	98	Mo
$\text{Ar}^{81}\text{Br}^+$	121	Sb
Chloride		
$^{35}\text{ClO}^+$	51	V
$^{35}\text{ClOH}^+$	52	Cr
$^{37}\text{ClO}^+$	53	Cr
$^{37}\text{ClOH}^+$	54	Cr
$\text{Ar}^{35}\text{Cl}^+$	75	As
$\text{Ar}^{37}\text{Cl}^+$	77	Se
Sulphate		
$^{32}\text{SO}^+$	48	
$^{32}\text{SOH}^+$	49	
$^{34}\text{SO}^+$	50	V, Cr
$^{34}\text{SOH}^+$	51	V
$\text{SO}_2^+, \text{S}_2^+$	64	Zn
Ar^{32}S^+	72	
Ar^{34}S^+	74	
Phosphate		
PO^+	47	
POH^+	48	
PO_2^+	63	Cu
ArP^+	71	
Group I, II Metals		
ArNa^+	63	Cu
ArK^+	79	
ArCa^+	80	

TABLE 2: COMMON MOLECULAR ION INTERFERENCES IN ICP-MS (Cont'd)**MATRIX MOLECULAR IONS**

Molecular Ion	Mass	Element Interference^a
Matrix Oxides [*]		
TiO	62-66	Ni, Cu, Zn
ZrO	106-112	Ag, Cd
MoO	108-116	Cd

^{*}Oxide interferences will normally be very small and will only impact the method elements when present at relatively high concentrations. Some examples of matrix oxides are listed of which the analyst should be aware. It is recommended that Ti and Zr isotopes are monitored in solid waste samples, which are likely to contain high levels of these elements. Mo is monitored as a method analyte.

TABLE 3: INTERNAL STANDARDS AND LIMITATIONS OF USE

Internal Standard	Mass	Possible Limitation
⁶ Lithium	6	a
Scandium	45	polyatomic ion interference
Yttrium	89	a,b
Rhodium	103	
Indium	115	isobaric interference by Sn
Terbium	159	
Holmium	165	
Lutetium	175	
Bismuth	209	a

a May be present in environmental samples.

b In some instruments Yttrium may form measurable amounts of YO⁺ (105 amu) and YOH⁺ (106 amu). If this is the case, care should be taken in the use of the cadmium elemental correction equation.

Internal standards recommended for use with this method are shown in bold face. Preparation procedures for these are included in Section 7.3.

TABLE 4: RECOMMENDED ANALYTICAL ISOTOPES AND ADDITIONAL MASSES WHICH MUST BE MONITORED

Isotope	Element of Interest
<u>27</u>	Aluminum
121, <u>123</u>	Antimony
<u>75</u>	Arsenic
135, <u>137</u>	Barium
<u>9</u>	Beryllium
106, 108, <u>111</u> , 114	Cadmium
<u>52</u> , 53	Chromium
<u>59</u>	Cobalt
<u>63</u> , 65	Copper
<u>206</u> , <u>207</u> , <u>208</u>	Lead
<u>55</u>	Manganese
95, 97, <u>98</u>	Molybdenum
<u>60</u> , 62	Nickel
77, <u>82</u>	Selenium
<u>107</u> , 109	Silver
<u>203</u> , <u>205</u>	Thallium
<u>232</u>	Thorium
<u>238</u>	Uranium
<u>51</u>	Vanadium
<u>66</u> , 67, 68	Zinc
83	Krypton
99	Ruthenium
105	Palladium
118	Tin

NOTE: Isotopes recommended for analytical determination are underlined.

TABLE 5: RECOMMENDED ELEMENTAL EQUATIONS FOR DATA CALCULATIONS

Element	Elemental Equation	Note
Al	(1.000) (²⁷ C)	
Sb	(1.000) (¹²³ C)	
As	(1.000) (⁷⁵ C)-(3.127) [(⁷⁷ C)-(0.815) (⁸² C)]	(1)
Ba	(1.000) (¹³⁷ C)	
Be	(1.000) (⁹ C)	
Cd	(1.000) (¹¹¹ C)-(1.073) [(¹⁰⁸ C)-(0.712) (¹⁰⁶ C)]	(2)
Cr	(1.000) (⁵² C)	(3)
Co	(1.000) (⁵⁹ C)	
Cu	(1.000) (⁶³ C)	
Pb	(1.000) (²⁰⁶ C)+(1.000) [(²⁰⁷ C)+(1.000) (²⁰⁸ C)]	(4)
Mn	(1.000) (⁵⁵ C)	
Mo	(1.000) (⁹⁸ C)-(0.146) (⁹⁹ C)	(5)
Ni	(1.000) (⁶⁰ C)	
Se	(1.000) (⁸² C)	(6)
Ag	(1.000) (¹⁰⁷ C)	
Tl	(1.000) (²⁰⁵ C)	
Th	(1.000) (²³² C)	
U	(1.000) (²³⁸ C)	
V	(1.000) (⁵¹ C)-(3.127) [(⁵³ C)-(0.113) (⁶² C)]	(7)
Zn	(1.000) (⁶⁶ C)	

TABLE 5: RECOMMENDED ELEMENTAL EQUATIONS FOR DATA CALCULATIONS

Element	Elemental Equation	Note
Bi	(1.000) (²⁰⁹ C)	
In	(1.000) (²⁰⁹ C)-(0.016) (¹¹⁸ C)	(8)
Sc	(1.000) (⁴⁵ C)	
Tb	(1.000) (¹⁵⁹ C)	
Y	(1.000) (⁸⁹ C)	

C - Calibration blank subtracted counts at specified mass.

(1) - Correction for chloride interference with adjustment for ⁷⁷Se. ArCl 75/77 ratio may be determined from the reagent blank. Isobaric mass 82 must be from Se only and not BrH⁺.

(2) - Correction for MoO interference. Isobaric mass 106 must be from Cd only not ZrO⁺. An additional isobaric elemental correction should be made if palladium is present.

(3) - In 0.4% v/v HCl, the background from ClOH will normally be small. However the contribution may be estimated from the reagent blank. Isobaric mass must be from Cr only not ArC⁺.

(4) - Allowance for isotopic variability of lead isotopes.

(5) - Isobaric elemental correction for ruthenium.

(6) - Some argon supplies contain krypton as an impurity. Selenium is corrected for ⁸²Kr by background subtraction.

(7) - Correction for chloride interference with adjustment for ⁵³Cr. ClO 51/53 ratio may be determined from the reagent blank. Isobaric mass 52 must be from Cr only not ArC⁺.

(8) - Isobaric elemental correction for tin.

**TABLE 6: INSTRUMENT OPERATING CONDITIONS FOR PRECISION
AND RECOVERY DATA¹**

Instrument	VG PlasmaQuad Type I
Plasma forward power	1.35 kW
Coolant flow rate	13.5 L/min.
Auxillary flow rate	0.6 L/min.
Nebulizer flow rate	0.78 L/min.
Solution uptake rate	0.6 mL/min.
Spray chamber temperature	15°C
Data Acquisition	
Detector mode	Pulse counting
Replicate integrations	3
Mass range	8-240 amu
Dwell time	320 µs
Number of MCA channels	2048
Number of scan sweeps	85
Total acquisition time	3 minutes per sample

¹The described instrument and operating conditions were used to determine the scanning mode MDL data listed in Table 7 and the precision and recovery data given in Tables 9 and 10.

TABLE 7: METHOD DETECTION LIMITS

AMU	Element	Scanning Mode ¹		Selection Ion Monitoring Mode ²	
		Total Recoverable		Total Recoverable	Direct Analysis ³
		Aqueous µg/L	Solids mg/kg	Aqueous µg/L	Aqueous µg/L
27	Al	1.0	0.4	1.7	0.04
123	Sb	0.4	0.2	0.04	0.02
75	As	1.4	0.6	0.4	0.1
137	Ba	0.8	0.4	0.04	0.04
9	Be	0.3	0.1	0.02	0.03
111	Cd	0.5	0.2	0.03	0.03
52	Cr	0.9	0.4	0.08	0.08
59	Co	0.09	0.04	0.004	0.003
63	Cu	0.5	0.2	0.02	0.01
206,207,208	Pb	0.6	0.3	0.05	0.02
55	Mn	0.1	0.05	0.02	0.04
202	Hg	n.a.	n.a.	n.a	0.2
98	Mo	0.3	0.1	0.01	0.01
60	Ni	0.5	0.2	0.06	0.03
82	Se	7.9	3.2	2.1	0.5
107	Ag	0.1	0.05	0.005	0.005
205	Tl	0.3	0.1	0.02	0.01
232	Th	0.1	0.05	0.02	0.01
238	U	0.1	0.05	0.01	0.01
51	V	2.5	1.0	0.9	0.05
66	Zn	1.8	0.7	0.1	0.2

¹Data acquisition mode given in Table 6. Total recoverable MDL concentrations are computed for original matrix with allowance for sample dilution during preparation. Listed MDLs for solids calculated from determined aqueous MDLs.

²MDLs determined using state-of-the-art instrumentation (1994). Data for ⁷⁵As, ⁷⁷Se, and ⁸²Se were acquired using a dwell time of 4.096 seconds with 1500 area count per seconds ⁸³Kr present in argon supply. All other data were acquired using a dwell time of 1.024 seconds per AMU monitored.

³MDLs were determined from analysis of seven undigested aqueous sample aliquots.

n.a. - Not applicable. Total recoverable digestion not suitable for organo-mercury compounds.

TABLE 8: ACCEPTANCE LIMITS FOR QC CHECK SAMPLE

METHOD PERFORMANCE ($\mu\text{g/L}$)¹

Element	QC Check Sample Conc.	Average Recovery	Standard Deviation² (S_r)	Acceptance Limits³ $\mu\text{g/L}$
Aluminum	100	100.4	5.49	84-117
Antimony	100	99.9	2.40	93-107
Arsenic	100	101.6	3.66	91-113
Barium	100	99.7	2.64	92-108
Beryllium	100	105.9	4.13	88-112 ⁴
Cadmium	100	100.8	2.32	94-108
Chromium	100	102.3	3.91	91-114
Cobalt	100	97.7	2.66	90-106
Copper	100	100.3	2.11	94-107
Lead	100	104.0	3.42	94-114
Manganese	100	98.3	2.71	90-106
Molybdenum	100	101.0	2.21	94-108
Nickel	100	100.1	2.10	94-106
Selenium	100	103.5	5.67	86-121
Silver	100	101.1	3.29	91-111 ⁵
Thallium	100	98.5	2.79	90-107
Thorium	100	101.4	2.60	94-109
Uranium	100	102.6	2.82	94-111
Vanadium	100	100.3	3.26	90-110
Zinc	100	105.1	4.57	91-119

¹Method performance characteristics calculated using regression equations from collaborative study, Reference 11.

²Single-analyst standard deviation, S_r.

³Acceptance limits calculated as average recovery \pm three standard deviations.

⁴Acceptance limits centered at 100% recovery.

⁵Statistics estimated from summary statistics at 48 and 64 $\mu\text{g/L}$.

TABLE 9: PRECISION AND RECOVERY DATA IN AQUEOUS MATRICES

DRINKING WATER									
Element	Sample	Low	Average			High	Average		
	Conc.	Spike	Recovery	S (R)	RPD	Spike	Recovery	S (R)	RPD
	µg/L	µg/L	R (%)			µg/L	R (%)		
Al	175	50	115.8	5.9	0.4	200	102.7	1.6	1.1
Sb	<0.4	10	99.1	0.7	2.0	100	100.8	0.7	2.0
As	<1.4	50	99.7	0.8	2.2	200	102.5	1.1	2.9
Ba	43.8	50	94.8	3.9	5.8	200	95.6	0.8	1.7
Be	<0.3	10	113.5	0.4	0.9	100	111.0	0.7	1.8
Cd	<0.5	10	97.0	2.8	8.3	100	101.5	0.4	1.0
Cr	<0.9	10	111.0	3.5	9.0	100	99.5	0.1	0.2
Co	0.11	10	94.4	0.4	1.1	100	93.6	0.5	1.4
Cu	3.6	10	101.8	8.8	17.4	100	91.6	0.3	0.3
Pb	0.87	10	97.8	2.0	2.8	100	99.0	0.8	2.2
Mn	0.96	10	96.9	1.8	4.7	100	95.8	0.6	1.8
Mo	1.9	10	99.4	1.6	3.4	100	98.6	0.4	1.0
Ni	1.9	10	100.2	5.7	13.5	100	95.2	0.5	1.3
Se	<7.9	50	99.0	1.8	5.3	200	93.5	3.5	10.7
Ag	<0.1	50	100.7	1.5	4.2	200	99.0	0.4	1.0
Tl	<0.3	10	97.5	0.4	1.0	100	98.5	1.7	4.9
Th	<0.1	10	109.0	0.7	1.8	100	106.0	1.4	3.8
U	0.23	10	110.7	1.4	3.5	100	107.8	0.7	1.9
V	<2.5	50	101.4	0.1	0.4	200	97.5	0.7	2.1
Zn	5.2	50	103.4	3.3	7.7	200	96.4	0.5	1.0

S (R) Standard deviation of percent recovery.

RPD Relative percent difference between duplicate spike determinations.

< Sample concentration below established method detection limit.

TABLE 9: PRECISION AND RECOVERY DATA IN AQUEOUS MATRICES (Cont'd)

<u>WELL WATER</u>									
Element	Sample	Low	Average			High	Average		
	Conc.	Spike	Recovery	S (R)	RPD	Spike	Recovery	S (R)	RPD
	µg/L	µg/L	R (%)			µg/L	R (%)		
Al	34.3	50	100.1	3.9	0.8	200	102.6	1.1	1.3
Sb	0.46	10	98.4	0.9	1.9	100	102.5	0.7	1.9
As	<1.4	50	110.0	6.4	16.4	200	101.3	0.2	0.5
Ba	106	50	95.4	3.9	3.3	200	104.9	1.0	1.6
Be	<0.3	10	104.5	0.4	1.0	100	101.4	1.2	3.3
Cd	106	10	88.6	1.7	3.8	100	98.6	0.6	1.6
Cr	<0.9	10	111.0	0.0	0.0	100	103.5	0.4	1.0
Co	2.4	10	100.6	1.0	1.6	100	104.1	0.4	0.9
Cu	37.4	10	104.3	5.1	1.5	100	100.6	0.8	1.5
Pb	3.5	10	95.2	2.5	1.5	100	99.5	1.4	3.9
Mn	2770	10	*	*	1.8	100	*	*	0.7
Mo	2.1	10	103.8	1.1	1.6	100	102.9	0.7	1.9
Ni	11.4	10	116.5	6.3	6.5	100	99.6	0.3	0.0
Se	<7.9	50	127.3	8.4	18.7	200	101.3	0.2	0.5
Ag	<0.1	50	99.2	0.4	1.0	200	101.5	1.4	3.9
Tl	<0.3	10	93.9	0.1	0.0	100	100.4	1.8	5.0
Th	<0.1	10	103.0	0.7	1.9	100	104.5	1.8	4.8
U	1.8	10	106.0	1.1	1.6	100	109.7	2.5	6.3
V	<2.5	50	105.3	0.8	2.1	200	105.8	0.2	0.5
Zn	554	50	*	*	1.2	200	102.1	5.5	3.2

S (R) Standard deviation of percent recovery.

RPD Relative percent difference between duplicate spike determinations.

< Sample concentration below established method detection limit.

* Spike concentration <10% of sample background concentration.

**TABLE 9: PRECISION AND RECOVERY DATA IN AQUEOUS
MATRICES (Cont'd)**

POND WATER									
Element	Sample	Low	Average			High	Average		
	Conc. µg/L	Spike µg/L	Recovery R (%)	S (R)	RPD	Spike µg/L	Recovery R (%)	S (R)	RPD
Al	610	50	*	*	1.7	200	78.2	9.2	5.5
Sb	<0.4	10	101.1	1.1	2.9	100	101.5	3.0	8.4
As	<1.4	50	100.8	2.0	5.6	200	96.8	0.9	2.6
Ba	28.7	50	102.1	1.8	2.4	200	102.9	3.7	9.0
Be	<0.3	10	109.1	0.4	0.9	100	114.4	3.9	9.6
Cd	<0.5	10	106.6	3.2	8.3	100	105.8	2.8	7.6
Cr	2.0	10	107.0	1.0	1.6	100	100.0	1.4	3.9
Co	0.79	10	101.6	1.1	2.7	100	101.7	1.8	4.9
Cu	5.4	10	107.5	1.4	1.9	100	98.1	2.5	6.8
Pb	1.9	10	108.4	1.5	3.2	100	106.1	0.0	0.0
Mn	617	10	*	*	1.1	100	139.0	11.1	4.0
Mo	0.98	10	104.2	1.4	3.5	100	104.0	2.1	5.7
Ni	2.5	10	102.0	2.3	4.7	100	102.5	2.1	5.7
Se	<7.9	50	102.7	5.6	15.4	200	105.5	1.4	3.8
Ag	0.12	50	102.5	0.8	2.1	200	105.2	2.7	7.1
Tl	<0.3	10	108.5	3.2	8.3	100	105.0	2.8	7.6
Th	0.19	10	93.1	3.5	10.5	100	93.9	1.6	4.8
U	0.30	10	107.0	2.8	7.3	100	107.2	1.8	4.7
V	3.5	50	96.1	5.2	14.2	200	101.5	0.2	0.5
Zn	6.8	50	99.8	1.7	3.7	200	100.1	2.8	7.7

S (R) Standard deviation of percent recovery.

RPD Relative percent difference between duplicate spike determinations.

< Sample concentration below established method detection limit.

* Spike concentration <10% of sample background concentration.

**TABLE 9: PRECISION AND RECOVERY DATA IN AQUEOUS
MATRICES (Cont'd)**

SEWAGE TREATMENT PRIMARY EFFLUENT

Element	Sample	Low	Average			High	Average		
	Conc. µg/L	Spike µg/L	Recovery R (%)	S (R)	RPD	Spike µg/L	Recovery R (%)	S (R)	RPD
Al	1150	50	*	*	3.5	200	100.0	13.8	1.5
Sb	1.5	10	95.7	0.4	0.9	100	104.5	0.7	1.9
As	<1.4	50	104.2	4.5	12.3	200	101.5	0.7	2.0
Ba	202	50	79.2	9.9	2.5	200	108.6	4.6	5.5
Be	<0.3	10	110.5	1.8	4.5	100	106.4	0.4	0.9
Cd	9.2	10	101.2	1.3	0.0	100	102.3	0.4	0.9
Cr	128	10	*	*	1.5	100	102.1	1.7	0.4
Co	13.4	10	95.1	2.7	2.2	100	99.1	1.1	2.7
Cu	171	10	*	*	2.4	100	105.2	7.1	0.7
Pb	17.8	10	95.7	3.8	1.1	100	102.7	1.1	2.5
Mn	199	10	*	*	1.5	100	103.4	2.1	0.7
Mo	136	10	*	*	1.4	100	105.7	2.4	2.1
Ni	84.0	10	88.4	16.3	4.1	100	98.0	0.9	0.0
Se	<7.9	50	112.0	10.9	27.5	200	108.8	3.0	7.8
Ag	10.9	50	97.1	0.7	1.5	200	102.6	1.4	3.7
Tl	<0.3	10	97.5	0.4	1.0	100	102.0	0.0	0.0
Th	0.11	10	15.4	1.8	30.3	100	29.3	0.8	8.2
U	0.71	10	109.4	1.8	4.3	100	109.3	0.7	1.8
V	<2.5	50	90.9	0.9	0.6	200	99.4	2.1	6.0
Zn	163	50	85.8	3.3	0.5	200	102.0	1.5	1.9

S (R) Standard deviation of percent recovery.

RPD Relative percent difference between duplicate spike determinations.

< Sample concentration below established method detection limit.

* Spike concentration <10% of sample background concentration.

**TABLE 9: PRECISION AND RECOVERY DATA IN AQUEOUS
MATRICES (Cont'd)**

INDUSTRIAL EFFLUENT									
Element	Sample	Low	Average			High	Average		
	Conc. µg/L	Spike µg/L	Recovery R (%)	S (R)	RPD	Spike µg/L	Recovery R (%)	S (R)	RPD
Al	44.7	50	98.8	8.7	5.7	200	90.4	2.1	2.2
Sb	2990	10	*	*	0.3	100	*	*	0.0
As	<1.4	50	75.1	1.8	6.7	200	75.0	0.0	0.0
Ba	100	50	96.7	5.5	3.4	200	102.9	1.1	0.7
Be	<0.3	10	103.5	1.8	4.8	100	100.0	0.0	0.0
Cd	10.1	10	106.5	4.4	2.4	100	97.4	1.1	2.8
Cr	171	10	*	*	0.0	100	127.7	2.4	1.7
Co	1.3	10	90.5	3.2	8.7	100	90.5	0.4	1.3
Cu	101	10	*	*	0.9	100	92.5	2.0	1.6
Pb	294	10	*	*	2.6	100	108.4	2.1	0.0
Mn	154	10	*	*	2.8	100	103.6	3.7	1.6
Mo	1370	10	*	*	1.4	100	*	*	0.7
Ni	17.3	10	107.4	7.4	5.0	100	88.2	0.7	1.0
Se	15.0	50	129.5	9.3	15.1	200	118.3	1.9	3.6
Ag	<0.1	50	91.8	0.6	1.7	200	87.0	4.9	16.1
Tl	<0.3	10	90.5	1.8	5.5	100	98.3	1.0	2.8
Th	0.29	10	109.6	1.2	2.7	100	108.7	0.0	0.0
U	0.17	10	104.8	2.5	6.6	100	109.3	0.4	0.9
V	<2.5	50	74.9	0.1	0.3	200	72.0	0.0	0.0
Zn	43.4	50	85.0	4.0	0.6	200	97.6	1.0	0.4

S (R) Standard deviation of percent recovery.

RPD Relative percent difference between duplicate spike determinations.

< Sample concentration below established method detection limit.

* Spike concentration <10% of sample background concentration.

TABLE 10: PRECISION AND RECOVERY DATA IN SOLID MATRICES

EPA HAZARDOUS SOIL #884

Element	Sample Conc. (mg/kg)	Low ⁺ Spike (mg/kg)	Average Recovery			High ⁺ Spike (mg/kg)	Average Recovery		
			R (%)	S (R)	RPD		R (%)	S (R)	RPD
Al	5170	20	*	*	–	100	*	*	–
Sb	5.4	20	69.8	2.5	4.7	100	70.4	1.8	6.5
As	8.8	20	104.7	5.4	9.1	100	102.2	2.2	5.4
Ba	113	20	54.9	63.6	18.6	100	91.0	9.8	0.5
Be	0.6	20	100.1	0.6	1.5	100	102.9	0.4	1.0
Cd	1.8	20	97.3	1.0	1.4	100	101.7	0.4	1.0
Cr	83.5	20	86.7	16.1	8.3	100	105.5	1.3	0.0
Co	7.1	20	98.8	1.2	1.9	100	102.9	0.7	1.8
Cu	115	20	86.3	13.8	3.4	100	151.7	4.2	4.6
Pb	152	20	85.0	45.0	13.9	100	85.2	25.7	23.7
Mn	370	20	*	*	12.7	100	95.2	10.4	2.2
Mo	4.8	20	95.4	1.5	2.9	100	102.3	0.7	2.0
Ni	19.2	20	101.7	3.8	1.0	100	100.7	0.8	0.8
Se	<3.2	20	79.5	7.4	26.4	100	94.8	9.4	26.5
Ag	1.1	20	96.1	0.6	0.5	100	97.9	0.8	2.3
Tl	0.24	20	94.3	1.1	3.1	100	76.0	1.0	2.9
Th	1.0	20	69.8	0.6	1.3	100	102.9	2.2	7.9
U	1.1	20	100.1	0.2	0.0	100	106.7	0.0	0.0
V	17.8	20	109.2	4.2	2.3	100	113.4	1.3	2.4
Zn	128	20	87.0	27.7	5.5	100		12.9	14.1

S (R) Standard deviation of percent recovery.

RPD Relative percent difference between duplicate spike determinations.

< Sample concentration below established method detection limit.

* Spike concentration <10% of sample background concentration.

– Not determined.

⁺ Equivalent.

TABLE 10: PRECISION AND RECOVERY DATA IN SOLID MATRICES

NBS 1645 RIVER SEDIMENT

Element	Sample Conc. (mg/kg)	Low ⁺ Spike (mg/kg)	Average Recovery			High ⁺ Spike (mg/kg)	Average Recovery		
			R (%)	S (R)	RPD		R (%)	S (R)	RPD
Al	5060	20	*	*	–	100	*	*	–
Sb	21.8	20	73.9	6.5	9.3	100	81.2	1.5	3.9
As	67.2	20	104.3	13.0	7.6	100	107.3	2.1	2.9
Ba	54.4	20	105.6	4.9	2.8	100	98.6	2.2	3.9
Be	0.59	20	88.8	0.2	0.5	100	87.9	0.1	0.2
Cd	8.3	20	92.9	0.4	0.0	100	95.7	1.4	3.9
Cr	29100	20	*	*	–	100	*	*	–
Co	7.9	20	97.6	1.3	2.6	100	103.1	0.0	0.0
Cu	112	20	121.0	9.1	1.5	100	105.2	2.2	1.8
Pb	742	20	*	*	–	100	–	–	–
Mn	717	20	*	*	–	100	–	–	–
Mo	17.1	20	89.8	8.1	12.0	100	98.4	0.7	0.9
Ni	41.8	20	103.7	6.5	4.8	100	102.2	0.8	0.0
Se	<3.2	20	108.3	14.3	37.4	100	93.9	5.0	15.1
Ag	1.8	20	94.8	1.6	4.3	100	96.2	0.7	1.9
Tl	1.2	20	91.2	1.3	3.6	100	94.4	0.4	1.3
Th	0.90	20	91.3	0.9	2.6	100	92.3	0.9	2.8
U	0.79	20	95.6	1.8	5.0	100	98.5	1.2	3.5
V	21.8	20	91.8	4.6	5.7	100	100.7	0.6	0.8
Zn	1780	20	*	*	–	100	*	*	–

S (R) Standard deviation of percent recovery.

RPD Relative percent difference between duplicate spike determinations.

< Sample concentration below established method detection limit.

* Spike concentration <10% of sample background concentration.

– Not determined.

⁺ Equivalent.

TABLE 10: PRECISION AND RECOVERY DATA IN SOLID MATRICES

EPA ELECTROPLATING SLUDGE #286									
Element	Sample Conc. (mg/kg)	Low ⁺ Spike (mg/kg)	Average Recovery			High ⁺ Spike (mg/kg)	Average Recovery		
			R (%)	S (R)	RPD		R (%)	S (R)	RPD
Al	5110	20	*	*	-	100	*	*	-
Sb	8.4	20	55.4	1.5	4.1	100	61.0	0.2	0.9
As	41.8	20	91.0	2.3	1.7	100	94.2	0.8	1.5
Ba	27.3	20	1.8	7.1	8.3	100	0	1.5	10.0
Be	0.25	20	92.0	0.9	2.7	100	93.4	0.3	0.9
Cd	112	20	85.0	5.2	1.6	100	88.5	0.8	0.5
Cr	7980	20	*	*	-	100	*	*	-
Co	4.1	20	89.2	1.8	4.6	100	88.7	1.5	4.6
Cu	740	20	*	*	6.0	100	61.7	20.4	5.4
Pb	1480	20	*	*	-	100	*	*	-
Mn	295	20	*	*	-	100	-	-	-
Mo	13.3	20	82.9	1.2	1.3	100	89.2	0.4	1.0
Ni	450	20	*	*	6.8	100	83.0	10.0	4.5
Se	3.5	20	89.7	3.7	4.2	100	91.0	6.0	18.0
Ag	5.9	20	89.8	2.1	4.6	100	85.1	0.4	1.1
Tl	1.9	20	96.9	0.9	2.4	100	98.9	0.9	2.4
Th	3.6	20	91.5	1.3	3.2	100	97.4	0.7	2.0
U	2.4	20	107.7	2.0	4.6	100	109.6	0.7	1.8
V	21.1	20	105.6	1.8	2.1	100	97.4	1.1	2.5
Zn	13300	20	*	*	-	100	*	*	-

S (R) Standard deviation of percent recovery.

RPD Relative percent difference between duplicate spike determinations.

< Sample concentration below established method detection limit.

* Spike concentration <10% of sample background concentration.

- Not determined.

⁺ Equivalent.

**TABLE 11: PRIMARY DRINKING WATER CONTAMINANTS
 PRECISION AND RECOVERY DATA**

Analyte	Regional Sample Background Concentration, µg/L			Average Mean ¹ % Recovery	S (R)
	(IV)	(VI)	(X)		
Antimony	0.16	0.07	0.03	114%	1.9
Arsenic	< MDL	2.4	1.0	93	8.5
Barium	4.6	280	14.3	(*)	–
Beryllium	< MDL	< MDL	< MDL	100%	8.2
Cadmium	0.05	0.05	0.03	81	4.0
Chromium	0.71	5.1	0.10	94	2.5
Copper	208	130	14.3	(*)	–
Lead	1.2	1.2	2.5	91	2.6
Mercury	< MDL	0.23	< MDL	86	11.4
Nickel	1.7	3.6	0.52	101%	11.5
Selenium	< MDL	4.3	< MDL	98	8.4
Thallium	< MDL	0.01	< MDL	100	1.4

¹The three regional waters were fortified with 1.0 µg/L of all analytes listed, except selenium, which was fortified to 20 µg/L.

(*) Recovery of barium and copper was not calculated because the analyte addition was <20% the sample background concentration in all waters. (Recovery calculations are not required if the concentration of the analyte added is less than 30% of the sample background concentration. Section 9.4.3).

S (R) Standard deviation of the mean percent recoveries.

TABLE 12: SUMMARY STATISTICS AND DESCRIPTIVE EQUATIONS FOR THE 20 ANALYTES TESTED IN THE COLLABORATIVE STUDY

Analyte	Reagent Water					Finished Drinking Water					Ground Water				
	C ^a	\bar{X}^b	S _R	S _T	Regr. Equations	\bar{X}	S _R	S _T	Regr. Equations	\bar{X}	S _R	S _T	Regr. Equations		
Aluminum	8.00	10.01	2.33	1.74	$\bar{X} = 0.992C + 1.19$	11.18	9.02	6.34	$\bar{X} = 0.954C + 2.38$	9.86	7.10	2.70	$\bar{X} = 0.946C + 2.20$		
	12.00	10.98	5.16		$S_R = 0.056\bar{X} + 2.59^c$	11.02	3.02		$S_R = 7.70^d$	13.40	10.27		$S_R = 0.169\bar{X} + 6.22^e$		
	56.00	59.13	5.55	4.19	$S_T = 0.042X + 1.27$	56.97	7.14	6.18	$S_T = 0.013X + 6.17$	51.75	10.78	16.92	$S_T = 0.172X + 0.75^f$		
	80.00	82.59	4.92			82.73	8.01			82.83	33.37				
	160.00	158.95	11.82	8.90		159.89	11.94	10.59		155.40	15.39	19.27			
	200.00	200.89	8.61			189.98	12.97			189.64	31.46				
Antimony	2.80	2.75	0.27	0.27	$\bar{X} = 0.999C + 0.04$	2.73	0.29	0.17	$\bar{X} = 0.983C + 0.03$	2.82	0.19	0.22	$\bar{X} = 1.003C + 0.01$		
	4.00	4.22	0.46		$S_R = 0.013\bar{X} + 0.61^a$	4.10	0.47		$S_R = 0.049\bar{X} + 0.19$	4.02	0.35		$S_R = 0.059\bar{X} + 0.04$		
	20.00	19.76	1.09	0.85	$S_T = 0.022X + 0.20$	19.17	1.37	0.66	$S_T = 0.026X + 0.08$	20.12	0.82	0.97	$S_T = 0.058X + 0.02$		
	28.00	27.48	1.38			26.48	1.72			27.77	1.38				
	80.00	82.52	2.24	1.76		83.43	2.05	2.46		80.34	9.14	6.80			
	100.00	98.06	1.34			97.19	5.31			101.09	2.89				
Arsenic	8.00	8.64	3.01	3.02	$\bar{X} = 1.013C + 0.50$	9.00	3.13	1.96	$\bar{X} = 0.993C + 0.57$	10.40	5.17	4.90	$\bar{X} = 0.949C + 0.91$		
	12.00	12.58	3.18		$S_R = 0.031\bar{X} + 2.74$	11.37	1.77		$S_R = 0.018\bar{X} + 2.55$	7.85	4.62		$S_R = 0.048\bar{X} + 4.52$		
	56.00	55.44	4.64	3.51	$S_T = 0.007X + 2.95$	53.77	4.12	4.07	$S_T = 0.031X + 1.65$	53.25	3.49	7.88	$S_T = 0.059X + 4.29$		
	80.00	85.15	2.54			87.72	4.14			83.60	12.46				
	160.00	161.80	11.15	3.96		157.56	4.83	6.30		159.86	11.67	14.94			
	200.00	201.52	10.81			197.99	10.66			194.41	18.24				
Barium	8.01	7.58	0.50	0.48	$\bar{X} = 1.001C - 0.36$	8.21	1.21	1.11	$\bar{X} = 0.995C + 0.37$	8.04	2.60	2.24	$\bar{X} = 1.055C - 0.21$		
	12.00	11.81	1.05		$S_R = 0.039\bar{X} + 0.31$	12.56	1.79		$S_R = 0.045\bar{X} + 0.97^c$	12.85	1.45		$S_R = 0.020\bar{X} + 2.05$		
	48.00	47.32	1.60	1.82	$S_T = 0.024X + 0.25$	49.13	3.72	3.77	$S_T = 0.040X + 0.72^c$	50.12	2.98	2.19	$S_T = 0.014X + 2.08$		
	64.00	65.52	2.90			65.30	4.16			69.53	2.66				
	160.00	157.09	6.53	4.07		155.25	7.82	5.67		164.44	8.81	6.61			
	200.00	198.53	8.28			196.52	5.70			208.32	9.22				
Beryllium	2.80	3.31	0.81	0.26	$\bar{X} = 1.056C + 0.32$	3.15	0.47	0.31	$\bar{X} = 1.055C + 0.20$	3.02	0.46	0.22	$\bar{X} = 1.049C + 0.08$		
	4.00	4.45	0.73		$S_R = 0.067\bar{X} + 0.55$	4.45	0.51		$S_R = 0.057\bar{X} + 0.28$	4.27	0.44		$S_R = 0.084\bar{X} + 0.16$		
	20.00	22.38	2.76	1.00	$S_T = 0.038X + 0.11$	21.27	1.23	0.63	$S_T = 0.016X + 0.25$	21.55	1.72	1.10	$S_T = 0.043X + 0.06$		
	28.00	30.02	2.86			29.57	1.67			29.24	2.09				
	80.00	84.18	4.79	4.02		87.59	6.89	1.88		84.23	9.05	4.32			
	100.00	102.88	5.90			102.64	6.27			103.39	10.17				
Cadmium	4.00	4.01	0.34	0.20	$\bar{X} = 1.007C + 0.07$	4.11	0.88	0.71	$\bar{X} = 0.985C + 0.10$	3.98	0.48	0.14	$\bar{X} = 0.944C + 0.11$		
	6.00	6.32	0.49		$S_R = 0.041\bar{X} + 0.19$	5.87	0.58		$S_R = 0.031\bar{X} + 0.65$	5.62	0.73		$S_R = 0.017\bar{X} + 1.09^a$		
	20.00	19.81	1.12	0.86	$S_T = 0.022X + 0.10^c$	19.57	1.45	1.26	$S_T = 0.021X + 0.61$	18.15	1.73	0.88	$S_T = 0.029X + 0.01$		
	28.00	28.33	0.94			27.68	1.27			26.86	2.59				
	80.00	81.28	4.91	1.33		80.62	4.45	2.02		77.83	3.05	1.88			
	100.00	100.11	3.24			98.15	3.60			95.31	2.04				

TABLE 12: SUMMARY STATISTICS AND DESCRIPTIVE EQUATIONS FOR THE 20 ANALYTES TESTED IN THE COLLABORATIVE STUDY

Analyte	Reagent Water					Finished Drinking Water					Ground Water				
	C ^a	\bar{X}^b	S _R	S _T	Regr. Equations	\bar{X}	S _R	S _T	Regr. Equations	\bar{X}	S _R	S _T	Regr. Equations		
Chromium	8.00	8.27	0.32	1.54	$\bar{X} = 1.017C + 0.62$	9.46	2.34	2.08	$\bar{X} = 0.990C + 1.45$	8.98	1.47	0.37	$\bar{X} = 1.026C + 0.89$		
	12.00	13.88	3.10		$S_R = 0.066\bar{X} + 0.48$	13.10	2.39		$S_R = 0.015\bar{X} + 2.19$	13.42	1.13		$S_R = 0.067\bar{X} + 0.68$		
	56.00	57.86	4.03	2.68	$S_T = 0.026\bar{X} + 1.25$	56.04	2.24	1.29	$S_T = 2.18^d$	59.35	5.99	5.42	$S_T = 0.068\bar{X} - 0.37$		
	80.00	84.73	2.65			84.38	3.18			83.90	5.70				
	160.00	157.66	13.62	6.97		158.24	5.12	3.16		164.58	14.11	9.80			
	200.00	197.43	9.47			196.72	7.47			199.88	11.19				
Cobalt	0.80	0.88	0.10	0.05	$\bar{X} = 0.977C + 0.01$	0.92	0.45	0.31	$\bar{X} = 0.964C + 0.06$	0.85	0.13	0.09	$\bar{X} = 0.989C - 0.01$		
	1.21	0.98	0.04		$S_R = 0.028\bar{X} + 0.06$	1.02	0.10		$S_R = 0.019\bar{X} + 0.32$	1.04	0.18		$S_R = 0.057\bar{X} + 0.09$		
	20.10	20.77	0.74	0.67	$S_T = 0.027\bar{X} + 0.02$	20.45	0.91	0.53	$S_T = 0.014\bar{X} + 0.30$	20.81	1.11	1.12	$S_T = 0.012\bar{X} + 0.40^e$		
	28.20	27.75	0.96			27.29	1.22			28.07	2.16				
	80.50	78.59	2.29	2.31		78.04	3.72	1.84		79.26	4.66	1.34			
	101.00	98.79	2.94			97.62	4.62			99.41	4.22				
Copper	4.00	3.88	0.73	0.59	$\bar{X} = 1.003C - 0.05$	3.33	0.85	0.99	$\bar{X} = 0.976C - 0.38$	3.86	1.40	0.71	$\bar{X} = 0.977C - 0.01$		
	6.00	6.14	1.00		$S_R = 0.037\bar{X} + 0.64$	5.95	1.78		$S_R = 0.063\bar{X} + 0.86$	5.96	0.95		$S_R = 0.073\bar{X} + 0.92$		
	20.00	20.07	1.08	0.92	$S_T = 0.016\bar{X} + 0.51$	18.90	1.64	1.51	$S_T = 0.029\bar{X} + 0.86$	18.97	1.68	2.32	$S_T = 0.077\bar{X} + 0.35$		
	28.00	27.97	1.94			27.21	2.76			27.44	2.58				
	80.00	79.80	3.22	1.91		76.64	5.30	3.42		79.30	9.05	6.54			
	100.00	99.57	4.42			96.17	5.64			97.54	11.16				
Lead	4.00	4.00	1.57	1.62	$\bar{X} = 1.043C - 0.31$	3.44	1.15	1.18	$\bar{X} = 1.032C - 0.30$	4.20	1.13	1.76	$\bar{X} = 1.012C + 0.15$		
	6.00	5.56	2.00		$S_R = 0.064\bar{X} + 1.43^c$	6.84	1.10		$S_R = 0.015\bar{X} + 1.06$	6.27	2.38		$S_R = 0.048\bar{X} + 1.27$		
	20.00	20.54	2.91	4.36	$S_T = 3.42^d$	20.18	1.20	1.44	$S_T = 0.011\bar{X} + 1.13$	19.57	2.72	0.88	$S_T = 1.78^d$		
	28.00	30.90	4.58			28.08	1.57			28.55	1.73				
	80.00	80.57	3.13	4.29		80.92	2.30	2.07		82.47	4.38	2.69			
	100.00	102.93	6.62			101.60	3.23			102.47	3.58				
Manganese	0.80	0.86	0.15	0.09	$\bar{X} = 0.983C + 0.02$	0.96	0.32	0.42	$\bar{X} = 0.989C + 0.10$	0.64	0.22	0.17	$\bar{X} = 0.954C - 0.16$		
	1.20	1.09	0.12		$S_R = 0.026\bar{X} + 0.11$	1.13	0.38		$S_R = 0.047\bar{X} + 0.29$	0.90	0.21		$S_R = 0.103\bar{X} + 0.14$		
	20.00	20.43	0.89	0.72	$S_T = 0.027\bar{X} + 0.06$	21.06	1.32	0.96	$S_T = 0.021\bar{X} + 0.40$	19.61	2.60	2.62	$S_T = 0.025\bar{X} + 0.09^e$		
	28.00	27.53	0.41			27.60	1.47			25.65	4.10				
	80.00	79.00	3.16	2.38		79.57	4.18	2.01		77.38	6.13	2.90			
	100.00	97.60	2.51			97.97	4.10			95.86	6.74				

TABLE 12: SUMMARY STATISTICS AND DESCRIPTIVE EQUATIONS FOR THE 20 ANALYTES TESTED IN THE COLLABORATIVE STUDY

Analyte	Reagent Water				Finished Drinking Water				Ground Water				
	C ^a	\bar{X}^b	S _R	S _T	Regr. Equations	\bar{X}	S _R	S _T	Regr. Equations	\bar{X}	S _R	S _T	Regr. Equations
Molybdenum	2.80	2.63	0.32	0.16	$\bar{X} = 1.012C - 0.20$	2.80	0.20	0.32	$\bar{X} = 1.013C - 0.07$	3.00	0.47	0.42	$\bar{X} = 1.032C - 0.09$
	4.00	3.85	0.31		$S_R = 0.032X + 0.22$	3.95	0.47		$S_R = 0.037X + 0.17$	3.60	0.90		$S_R = 0.55X + 0.43$
	20.00	19.75	0.64	0.64	$S_T = 0.021X + 0.09$	19.78	0.60	1.16	$S_T = 0.035X + 0.20$	20.69	1.37	1.11	$S_T = 0.042X + 0.27$
	28.00	27.87	1.07			27.87	1.51			28.80	2.01		
	80.00	83.07	3.07	1.78		85.65	3.50	3.07		84.26	4.13	4.81	
100.00	100.08	4.32			99.06	2.89			103.57	6.10			
Nickel	4.00	4.02	0.41	0.50	$\bar{X} = 1.000C + 0.12$	3.66	0.53	1.03	$\bar{X} = 0.953C - 0.19$	4.81	2.06	2.82	$\bar{X} = 1.022C + 0.66$
	6.00	6.36	0.91		$S_R = 0.051X + 0.31$	5.44	1.32		$S_R = 0.046X + 0.56$	6.67	3.66		$S_R = 0.091X + 2.03$
	20.00	19.93	1.30	0.63	$S_T = 0.017X + 0.40$	18.42	0.87	1.11	$S_T = 0.023X + 0.91$	20.58	3.71	2.37	$S_T = 0.008X + 2.75^c$
	28.00	28.02	1.25			27.09	1.68			30.73	3.75		
	80.00	79.29	2.95	2.55		75.84	4.40	3.94		82.71	9.49	5.42	
100.00	100.87	7.20			95.83	4.41			101.00	9.89			
Selenium	32.00	33.54	4.63	1.57	$\bar{X} = 1.036C - 0.06$	32.57	4.37	3.65	$\bar{X} = 1.022C + 0.14$	32.46	4.95	3.24	$\bar{X} = 1.045C - 0.83$
	40.00	41.03	6.04		$S_R = 0.051X + 3.24$	42.18	3.71		$S_R = 0.056X + 2.10$	41.46	3.30		$S_R = 0.037X + 2.97$
	80.00	81.40	5.86	5.44	$S_T = 0.061X - 0.64$	79.97	6.66	5.28	$S_T = 0.040X + 2.15$	81.63	6.94	5.65	$S_T = 0.058X + 1.02$
	96.10	98.34	8.57			94.94	7.90			98.92	4.39		
	160.00	163.58	15.69	9.86		163.48	9.17	10.06		167.54	8.69	12.98	
200.00	214.30	10.57			212.19	16.49			209.21	14.65			
Silver	0.80	0.93	0.09	0.14	$\bar{X} = 0.917C + 0.26$	0.70	0.34	0.34	$\bar{X} = 0.888C + 0.09$	0.70	0.26	0.10	$\bar{X} = 0.858C - 0.00$
	1.20	1.51	0.23		$S_R = 0.196X - 0.09$	1.37	0.33		$S_R = 0.186X + 0.17$	0.98	0.28		$S_R = 0.169X + 0.14$
	48.00	49.39	3.25	1.81	$S_T = 0.053X + 0.08$	45.43	6.78	5.15	$S_T = 0.164X + 0.18$	45.59	4.27	2.70	$S_T = 0.120X - 0.01$
	64.00	63.54	2.75			60.35	2.22			59.71	6.58		
	160.00	136.42	48.31	12.19		119.06	55.28	36.34		121.43	42.55	28.19	
200.00	153.74	57.34			172.15	31.92			160.69	27.15			
Thallium	2.80	2.89	0.23	0.22	$\bar{X} = 0.984X + 0.08$	2.88	0.40	0.16	$\bar{X} = 1.010C + 0.01$	2.88	0.14	0.12	$\bar{X} = 1.023C - 0.06$
	4.00	3.92	0.15		$S_R = 0.035X + 0.09$	3.96	0.21		$S_R = 0.040X + 0.21$	3.88	0.37		$S_R = 0.056X + 0.04$
	20.00	19.27	0.99	0.67	$S_T = 0.027X + 0.13$	19.77	1.13	0.83	$S_T = 0.039X + 0.02$	20.22	1.05	0.65	$S_T = 0.049X - 0.06$
	28.00	28.08	0.83			27.61	1.24			28.65	1.50		
	80.00	81.29	3.65	2.86		85.32	4.08	4.05		83.97	6.10	6.05	
100.00	96.69	2.86			100.07	4.33			101.09	4.15			
Thorium	0.80	0.93	0.16	0.09	$\bar{X} = 1.013C + 0.08$	0.78	0.13	0.07	$\bar{X} = 1.019C - 0.06$	0.87	0.17	0.07	$\bar{X} = 1.069C - 0.03$
	1.20	1.22	0.19		$S_R = 0.036X + 0.13$	1.09	0.19		$S_R = 0.035X + 0.12$	1.15	0.17		$S_R = 0.041X + 0.13$
	20.00	20.88	0.90	0.71	$S_T = 0.025X + 0.07$	21.66	0.94	0.54	$S_T = 0.024X + 0.05$	21.78	0.90	0.94	$S_T = 0.027X + 0.04$
	28.00	27.97	1.11			28.09	0.83			29.86	1.65		
	80.10	81.14	2.99	2.14		79.99	2.03	2.60		86.00	3.43	1.95	
100.00	102.64	3.39			100.50	4.56			107.35	4.72			

TABLE 12: SUMMARY STATISTICS AND DESCRIPTIVE EQUATIONS FOR THE 20 ANALYTES TESTED IN THE COLLABORATIVE STUDY

Analyte	Reagent Water				Finished Drinking Water				Ground Water				
	C ^a	\bar{X}^b	S _R	S _r	Regr. Equations	\bar{X}	S _R	S _r	Regr. Equations	\bar{X}	S _R	S _r	Regr. Equations
Uranium	0.80	0.86	0.05	0.08	$\bar{X} = 1.026C - 0.02$	0.85	0.15	0.09	$\bar{X} = 1.026C - 0.04$	0.84	0.23	0.19	$\bar{X} = 1.058C - 0.06$
	1.20	1.10	0.11		$S_R = 0.048\bar{X} + 0.02$	1.05	0.13		$S_R = 0.044\bar{X} + 0.11$	1.10	0.14		$S_R = 0.039\bar{X} + 0.17$
	20.10	21.38	0.99	0.82	$S_r = 0.027\bar{X} + 0.05$	22.30	1.40	0.46	$S_r = 0.022\bar{X} + 0.07$	21.56	1.11	1.08	$S_r = 0.028\bar{X} + 0.16$
	28.10	28.36	1.10			28.89	1.47			29.86	1.83		
	80.30	82.47	4.03	2.16		80.31	2.00	2.71		85.01	3.76	2.00	
	100.00	103.49	5.24			100.70	5.30			106.47	3.74		
Vanadium	32.00	31.02	2.68	2.19	$\bar{X} = 1.025C - 2.21$	33.15	2.51	2.28	$\bar{X} = 1.022C - 0.30$	33.25	3.83	1.87	$\bar{X} = 1.076C - 1.87$
	40.00	38.54	2.94		$S_R = 3.79^d$	40.20	1.88		$S_R = 0.023\bar{X} + 1.45$	40.34	3.08		$S_R = 0.033\bar{X} + 2.25$
	80.00	79.14	4.94	4.29	$S_r = 3.26^d$	77.83	4.18	2.75	$S_r = 0.023\bar{X} + 1.38$	84.42	3.97	2.93	$S_r = 0.049\bar{X} - 0.09$
	96.00	93.47	3.85			96.32	1.34			98.70	5.03		
	160.00	162.43	5.67	3.30		161.89	7.63	6.56		170.94	9.09	11.55	
	200.00	208.20	2.65			214.91	5.89			217.90	11.36		
Zinc	8.00	8.33	2.56	1.78	$\bar{X} = 1.042C + 0.87$	11.60	6.18	5.72	$\bar{X} = 0.943C + 2.54$	7.29	1.12	2.20	$\bar{X} = 0.962C + 0.07$
	12.00	15.49	4.18		$S_R = 0.041\bar{X} + 2.60$	10.21	4.96		$S_R = 0.048\bar{X} + 5.27$	12.66	3.24		$S_R = 0.093\bar{X} + 0.92$
	56.00	56.07	2.91	2.47	$S_r = 0.030\bar{X} + 1.42$	56.83	7.66	4.56	$S_r = 0.004\bar{X} + 5.66^e$	54.86	5.12	7.24	$S_r = 0.069\bar{X} + 1.55$
	80.00	85.53	5.81			82.88	8.34			78.62	8.56		
	160.00	165.17	7.78	9.87		156.69	17.01	9.48		150.12	12.52	10.84	
	200.00	207.27	14.61			191.59	17.21			184.37	16.59		

^a True Value for the concentration added (µg/L)

^b Mean Recovery (µg/L)

^c COD_r < 0.5 - Use of regression equation outside study concentration range not recommended.

^d COD_r < 0 - Mean precision is reported.

^e COD_r < 0 - Unweighted linear regression equation presented.

TABLE 13: BACKGROUND AND SPIKE MEASUREMENTS IN WASTEWATER DIGESTATE^a

	Background		Concentrate 1					Concentrate 2					
	Conc. µg/L	Std Dev µg/L	Spike µg/L	Found µg/L	Std Dev µg/L	% Rec %	RSD %	Spike µg/L	Found µg/L	Std Dev µg/L	% Rec %	RSD %	RSD_r %
Be	0.0	0.0	100	94.5	11.8	94.5	12.5	125	118.1	14.7	94.5	12.4	3.5
Al	78.2	12.4	200	260.9	41.2	91.4	15.8	250	309.1	48.5	92.4	15.7	2.7
Cr	19.5	8.1	200	222.2	23.3	101.4	10.5	250	274.3	26.6	101.9	9.7	2.0
V	1.9	2.8	250	271.8	36.5	108.0	13.4	200	219.3	30.1	108.7	13.7	2.6
Mn	296.6	24.7	125	419.0	35.7	97.9	8.5	100	397.4	34.8	100.8	8.8	1.0
Co	2.5	0.4	125	124.7	12.3	97.8	9.9	101	100.7	9.4	97.2	9.3	2.8
Ni	47.3	5.0	125	161.7	4.9	91.5	3.0	100	142.7	5.6	95.4	3.9	2.1
cu	77.4	13.2	125	194.5	29.5	93.7	15.2	100	172.3	26.6	94.9	15.4	2.2
Zn	77.4	4.9	200	257.4	16.3	90.0	6.3	250	302.5	21.1	90.0	7.0	1.8
As	0.8	1.1	200	194.9	8.0	97.1	4.1	250	244.7	12.8	97.6	5.2	3.4
Se	4.5	6.2	250	236.8	14.2	92.9	6.0	200	194.3	9.3	94.9	4.8	3.8
Mo	166.1	9.4	100	269.8	19.0	103.7	7.0	125	302.0	18.0	108.7	6.0	1.5
Ag	0.6	0.7	200	176.0	14.6	87.7	8.3	250	214.6	17.8	85.6	8.3	2.3
Cd	2.7	1.1	125	117.0	4.8	91.4	4.1	100	96.6	3.2	93.9	3.3	2.9
Sb	3.3	0.2	100	100.2	4.8	96.9	4.8	125	125.9	4.3	98.1	3.4	1.8
Ba	68.6	3.3	250	321.0	19.4	101.0	6.0	200	279.3	17.2	105.4	6.2	2.5
Tl	0.1	0.1	100	103.3	8.0	103.2	7.7	125	129.2	8.9	103.3	6.9	2.1
Pb	6.9	0.5	125	135.1	7.8	102.6	5.8	100	110.3	6.3	103.4	5.7	1.8
Th	0.1	0.1	125	140.2	19.5	112.1	13.9	100	113.3	15.4	113.2	13.6	2.7
U	0.4	0.2	125	141.2	19.3	112.6	13.7	100	113.6	16.0	113.2	14.1	2.5

^aResults from 10 participating laboratories. Wastewater digestate supplied with the study materials. Mean background concentrations determined by the participants.

TABLE 14: SPIKE MEASUREMENTS IN PARTICIPANTS WASTEWATER^a

	Concentrate 1					Concentrate 2					
	Spike µg/L	Found µg/L	Std Dev µg/L	% Rec %	RSD %	Spike µg/L	Found µg/L	Std Dev µg/L	% Rec %	RSD %	RSD _r %
Be	101	103.4	12.0	103.4	11.6	125	128.2	13.6	102.6	10.6	2.4
Al	200	198.7	23.9	99.4	12.0	250	252.4	15.5	101.0	6.1	2.9
Cr	200	205.4	12.3	102.7	6.0	250	253.4	15.4	101.4	6.1	1.1
V	250	246.5	4.4	98.6	1.8	200	196.8	2.8	98.4	1.4	2.0
Mn	125	119.0	5.4	95.2	4.5	100	95.5	4.3	95.5	4.5	0.8
Co	125	125.8	7.0	100.6	5.6	101	99.5	5.3	98.5	5.3	1.8
Ni	125	127.4	9.7	101.9	7.6	100	101.0	7.5	101.0	7.4	1.7
cu	125	126.8	5.3	101.4	4.2	100	105.3	3.6	105.3	3.4	2.8
Zn	200	201.4	36.7	100.7	18.2	250	246.4	29.7	98.6	12.1	2.6
As	200	207.3	11.9	103.7	5.7	250	263.0	2.6	105.2	1.0	3.2
Se	250	256.8	26.4	102.7	10.3	200	214.0	18.7	107.3	8.7	3.6
Mo	100	98.6	4.6	98.6	4.7	125	123.2	6.7	98.6	5.4	2.2
Ag	200	200.7	48.9	100.4	24.4	250	231.2	63.5	92.5	27.5	8.2
Cd	125	123.2	11.5	98.6	9.3	100	95.8	2.9	95.8	3.0	5.8
Sb	100	92.2	4.4	92.2	4.8	125	119.0	1.0	95.2	0.8	2.8
Ba	250	245.2	12.8	98.1	5.2	200	204.7	12.1	102.4	5.9	2.1
Tl	100	100.0	0.9	100.0	0.9	125	128.0	6.0	102.4	4.7	3.5
Pb	125	125.8	5.1	100.6	4.1	100	100.8	2.7	100.8	2.7	2.2
Th	125	124.2	7.6	99.4	6.1	100	99.8	5.7	99.8	5.7	3.2
U	125	130.4	10.3	104.3	7.9	100	106.4	6.8	106.4	6.4	2.3

^aResults from five participating laboratories. Mean concentrations before spiking are not listed because they varied considerably among the different wastewaters.

Annex VI:

**Recommended Method for the
DETERMINATION OF TOTAL MERCURY IN
MARINE SAMPLES BY THERMAL
DECOMPOSITION AMALGAMATION AND
ATOMIC ABSORPTION SPECTROPHOTOMETRY**



REPORT

Recommended Method for the DETERMINATION OF TOTAL MERCURY IN MARINE SAMPLES BY THERMAL DECOMPOSITION AMALGAMATION AND ATOMIC ABSORPTION SPECTROPHOTOMETRY

IAEA/NAEL

Marine Environmental Studies Laboratory in co-operation with

UNEP/MAP MED POL

December 2012

For further information on this method, please contact:

IAEA-Environment Laboratories
Marine Environmental Studies Laboratory
4a Quai Antoine 1er
MC-98000 Principality of Monaco

Tel. (377) 979 772 72; Fax. (377) 979 772 73

E-mail: NAEL-MESL.Contact-Point@iaea.org

Recommended Method for the
DETERMINATION OF TOTAL MERCURY IN MARINE SAMPLES BY
THERMAL DECOMPOSITION AMALGAMATION
AND ATOMIC ABSORPTION SPECTROPHOTOMETRY

DISCLAIMER

This is not an official IAEA publication. The views expressed do not necessarily reflect those of the International Atomic Energy Agency or its Member States.

The material has not undergone an official review by the IAEA. This document should not be quoted or listed as a reference.

The use of particular designations of countries or territories does not imply any judgment by the IAEA, as to the legal status of such countries or territories, of their authorities and institutions or of the delimitation of their boundaries.

The mention of names of specific companies or products (whether or not indicated as registered) does not imply any intention to infringe proprietary rights, nor should it be construed as an endorsement or recommendation on the part of the IAEA.

Limited Distribution

Reproduced by the IAEA

TABLE OF CONTENTS

1. SCOPE	1
2. PRINCIPLE.....	1
3. SAMPLE PRE-TREATMENT	1
4. REAGENTS	2
5. MATERIAL	2
6. CALIBRATION	3
7. PROCEDURE	4
8. QUALITY CONTROL.....	6
9. CALCULATION OF RESULTS	7
10. EXPRESSION OF RESULTS	8
11. REFERENCES	8

NOTE: This method is not intended to be an analytical training manual. Therefore, this method is written with the assumption that it will be performed by formally trained analytical chemist.

In addition, the IAEA recommended methods are intended to be guidance methods that can be used by laboratories as a starting point for generating their own standard operating procedure. If performance data are included in the method, they shall not be used as absolute QC acceptance criteria.

1. SCOPE

The method hereinafter describes the protocol for the determination of total mercury (inorganic and organic) in sediment and biological material.

By using this method, the total mercury in solid samples can be determined without sample chemical pre-treatment.

The recommended protocol is mainly based on the EPA 7473 method; users are encouraged to consult this document (EPA, 2007).

2. PRINCIPLE

The sample is dried and then chemically decomposed under oxygen in the decomposition furnace. The decomposition products are carried out to the catalytic section of the furnace, where oxidation is completed (halogens and nitrogen/sulfur oxides are trapped). The mercury present in the remaining decomposition products is selectively trapped on an amalgamator. After flushing the system with oxygen, the mercury vapour is released by rapid heating of the amalgamator, and carried through the absorbance cell in the light path of a single wavelength atomic absorption spectrophotometer. The absorbance is measured at 253.7 nm as a function of mercury quantity (ng).

The typical working range is 0.1–500 ng. The mercury vapour is carried through a long (first) and a short path length absorbance cell. The same quantity of mercury is measured twice with different sensitivity resulting in a dynamic range that spans four orders of magnitude.

The typical detection limit is 0.01 ng of mercury.

3. SAMPLE PRE-TREATMENT

The sediment samples are prepared following the recommendations of UNEP (2005);

The marine organisms are prepared following the recommendations of UNEP (1984, 1994).

4. REAGENTS

The reagents used shall meet the purity requirement of the subsequent analysis

4.1. ULTRAPUR WATER (type MilliQ)

4.2. NITRIC ACID 65%

4.3. POTASSIUM DICHROMATE OXIDIZING SOLUTION (10% w/v)

Weight 25 g of $K_2Cr_2O_7$ in 250 ml glass bottle, fill it up to 250 ml with water, and shake until total dissolution of solids. Keep the bottle tightly closed in a double plastic bag, and in an Hg free environment (i.e. laminar flow hood). This solution is stable indefinitely and rarely becomes contaminated.

4.4. COMMERCIAL STANDARD SOLUTION 1000 $\mu\text{g ml}^{-1}$ MERCURY

Use a certified reference material solution; this solution should be accompanied by a certificate stipulating at minimum the traceability of the certified concentration, as well as the expiry date. The density of the solution, or the certified content in mg kg^{-1} should also be defined, to allow for the preparation of the calibration solution by weighing. Stock solutions should be kept at 5°C.

5. MATERIAL

5.1. SOLID MERCURY ANALYZER

Optionally equipped with an auto-sampler.

5.2. ANALYTICAL BALANCE

With a 0.001 g precision at least.

5.3. VOLUMETRIC CONTAINERS

Preferably in Teflon or glass.

5.4. PIPETTES

Some microliter pipettes sized ranging from 50 to 10000 μl are needed. The accuracy and precision of the pipettes used should be checked as a routine every 6 months, and the results obtained should be compared with the individual certificates.

5.5. METAL SPATULA (inox).

5.6. SAMPLE BOAT

Metal or metal alloy. Before measurement, sample boats are cleaned by heating over a flame until constant "red" to remove mercury.

5.7. OXYGEN

It should be of high purity and free of mercury. If there is a possible mercury contamination from oxygen, install a gold mesh filter between the cylinder and the instrument to prevent any mercury from entering the instrument.

6. CALIBRATION

- 6.1. PRIMARY CALIBRATION. This is the calibration of the instrument working range. This calibration is performed initially (usually done by the manufacturer and stored in the instrument), and/or when any significant instrumental parameters are changed (i.e. after maintenance).
- 6.2. PREPARE STANDARD SOLUTIONS of appropriate concentration by dilution of a commercial standard (see 4.4). It is recommended to prepare standard solution in Teflon or glass container, in 1 or 0.5% HNO₃ (see 4.2) and 0.1% (v/v) potassium dichromate (see 4.3). Fresh mercury standard should be prepared daily. Prepare a zero calibration solution using the same quantity of acid and potassium dichromate.
- 6.3. START THE INSTRUMENT according to the manufacturer recommendations.
- 6.4. CLEAN THE SYSTEM. Inject 100 µl of water and start the measurement with the recommended parameters (see 7.1). Repeat the cleaning until the absorbance is below 0.001ABS.
- 6.5. SET THE INSTRUMENT PARAMETERS (see 7.1) for selected volume (usually 100 µl) and inject the zero calibration, at least three measurements should be done. The zero solution serves to correct the amount of mercury in water and reagent used for preparing the calibration curve, hence the important of keeping the injected volume equal at all points of the calibration curve. If the amount of mercury in the zero calibration is high (i.e. more than 0.01 ng), it is recommended to check for contamination sources and to prepare new standard solution with clean acid.
- 6.6. STANDARDS ARE MEASURED from the lowest to the highest at least twice. The maximum relative standard deviation between readings should be 3% (except for zero calibration); if higher it is recommended to carry out more measurements.
- 6.7. EXAMPLE OF AMOUNTS used for recalibration (primary):

First Range:

Standard (ng ml ⁻¹)	1	3	10	30	100	300
Volume injected (µl)	100	100	100	100	100	100
Quantity of Hg (ng)	0.1	0.3	1	3	10	30

Second Range:

Standard ($\mu\text{g ml}^{-1}$)	1	2	3	4	5	6
Volume injected (μl)	100	100	100	100	100	100
Quantity of Hg (ng)	100	200	300	400	500	600

Note: The calibration of the second range might induce problems for subsequent analysis, due to the relatively high quantity of mercury introduced (especially with memory effect). It should be performed only if there is a probability of using it (i.e. measuring samples with high mercury level $> 1\mu\text{g g}^{-1}$). After the reading of the last calibration point, clean the system (see 6.4).

- 6.8. ALTERNATIVE CALIBRATION CURVE can be performed using a solid certified reference material. In this case, weigh accurately a CRM onto a tare sample boat, set up the instrument according to the sample type (see 7.1) and measure the absorbance. The matrix of the CRM should be as similar as possible to the sample of interest. Repeat this procedure with different weights of the CRM and/or with different CRM, to get results in the desired working range.
- 6.9. CONSTRUCT A CALIBRATION CURVE by plotting the absorbance against Nano grams of mercury (this could be done automatically by the software). The type of equation will depend on the levels, as the response is not linear over the entire working range.
- 6.10. DAILY CALIBRATION: calibration performed every day with a minimum number of standards to ensure that the primary calibration is valid. It can be performed by using either liquid standard (see 6.2) or solid certified reference material (CRM) see 6.8. It should be performed in the range of interest, with at least two standards (or matrix CRM) and the results should agree within the acceptance criteria. The acceptance criteria should be set through the use of historical data, but the maximum deviation should not exceed 10%.

7. PROCEDURE

7.1. GENERAL ANALYTICAL PARAMETERS

The analytical parameters will depend on the sample size and matrix, and are instrument specific. It is important to follow the guidelines from the instrument manufacturer. There are three time to set: drying, decomposition and waiting.

Some typical recommended conditions below:

Drying time:

Sample type	Dry (s)	Comments
Liquid	0.7 x injected Volume (μ l)	
Dry inorganic	10	
Organic liquid	50–300	To be optimized ¹
Dry organic (i.e. fat)	50–200	To be optimized ¹
Wet (i.e. fresh)	0.7 x weight x % moisture	Example: 100 mg with 45% moisture $0.7 \times 100 \times 0.45 = 31.5\text{s}$ (35)

¹ In the case of organic, there is a risk of explosion especially with organic liquid; to optimize set the instrument at: 300s dry/ 150s decomposition/ 45s wait, do the measurement and check for possible small explosion, note the time of the phenomenon and add to the drying time 10s more.

Decomposition time:

Sample type	Decomposition (s)	Comments
Liquid	150–400	To be optimized ¹
Solid inorganic	120 + 0.4 x sample (mg)	To be optimized ¹
Solid organic	120	

¹ Set the instrument to XX (see above) dry/ 400s decomposition/ 45s wait, run a sample and observe the results. Decrease the decomposition time by 30s and repeat measurement. Continue until you observe a significant decrease, note that time and add to the decomposition time 30s more.

Waiting time:

It is recommended to use 40–45s, except for long decomposition time (over 200s) when it is beneficial to add 10s of waiting for every 100s of decomposition.

Note: These indications above are recommended by ALTECH (AMA 254).

7.2. ANALYSIS OF A SOLID SAMPLE

Weight a sample accurately onto a tare boat, insert the boat into the instrument, set the appropriate parameters (see 7.1) and start the measurements. The results can be records on absorbance, quantity or concentration depending on the instrument software. See 9: Calculation of results.

7.3. ANALYSIS OF BLANK FOR SOLID MEASUREMENT

Analyse an empty sample boat using the same instrument settings than for the sample.

7.4. ANALYSIS OF A LIQUID SAMPLE

Dose a known volume of the sample onto a sample boat, set the appropriate parameters (see 7.1) and start the measurements. The results can be records on absorbance, quantity or concentration depending on the instrument software. See the calculation section (see 9).

7.5. ANALYSIS OF BLANK FOR LIQUID

Repeat 7.4 with the same volume of blank solution (solution that contain the same reagent and chemical than the sample).

8. QUALITY CONTROL

8.1. For every day of analysis, the CALIBRATION SHOULD BE VALIDATED by doing a daily calibration (see 6.10) before starting the measurements. The results of the daily calibration should be recorded for quality control purposes.

8.2. CERTIFIED REFERENCE MATERIAL

At least one certified reference material of a representative matrix should be measured with each batch of the sample, the calculated results should fall in the value of the certificate and within the coverage uncertainty (Linsinger, 2010), to show evidence of unbiased results. The results for the CRM should be recorded for quality control purpose and plotted in a control chart (UNEP/IOC/IAEA 1994).

8.3. A DUPLICATE OR TRIPLICATE SAMPLE should be processed on a routine basis.

A duplicate sample should be processed with each analytical batch or for every 10 samples.

8.4. A SPIKED SAMPLE should also be included, whenever a new sample matrix is being analysed, especially if no certified reference material is available for that matrix. Measure a spiked sample by adding a known volume of standard solution (prepared as in paragraph 6.2) to the sample in the boat. Keep the spike volume small enough not to overspill. The recovery of spike calculated with the equation 2 should be 85–115% (this limits should be reset after collection of historical data). If the test fails, it is recommended to check the calibration (see 6.10) and/or to revise the instrument parameters (see 7.1).

$$\text{Spike (ng)} = \text{Concentration of standard (ng/ml)} \times \text{Volume of spike (ml)} \quad \text{Equation 1}$$

$$\text{Recovery (\%)} = \frac{\text{Spiked sample (ng)} - \text{Unspiked sample (ng)}}{\text{Spike (ng)}} \times 100 \quad \text{Equation 2}$$

To be valid the quantity of Spike (equation 1) should be in the range of 50–150% the quantity of unspiked sample.

9. CALCULATION OF RESULTS

9.1. SOLID SAMPLE RESULTS are calculated using equation 3

$$w(Hg) = \frac{(\rho_1 - \rho_0)}{m} \times R \quad \text{Equation 3}$$

Where:

w(Hg) is the mass fraction of element m in the sample, expressed in mg kg⁻¹;

ρ₁ is the quantity of mercury, expressed in ng as measured in the sample;

ρ₀ is the quantity of mercury expressed in ng as measured in the blank (see 7.3);

R is the recovery calculated using the CRM (see 8.2) or spike (see 8.4);

m is the amount of sample in mg.

Note: ρ₁ and ρ₀ are calculated using calibration curve equation (usually done by software).

9.2. LIQUID SAMPLE RESULTS are calculated using equation 4

$$w(Hg) = \frac{(\rho_1 - \rho_0) \times V}{V_i \times m} \times f \times R \quad \text{Equation 4}$$

Where:

w(Hg) is the mass fraction of mercury in the sample, expressed in mg kg⁻¹;

ρ₁ is the quantity of mercury, expressed in ng as measured in the sample solution;

ρ₀ is the quantity of mercury expressed in ng as measured in the blank solution (see 7.4);

R is the recovery calculated using the CRM (see 8.2) or spike (see 8.4);

V_i is the injected volume (should be the same in sample and blank solution) in ml;

m is the amount of sample in mg;

V is the volume of solution in ml;

f is the dilution factor.

Note: ρ₁ and ρ₀ are calculated using calibration curve equation (usually done by software).

10. EXPRESSION OF RESULTS

The rounding of values will depend on the uncertainty reported with the results; in general for this method two or three significant figures should be reported.

The uncertainty component should be reported with all results. (ISO 2005, Nordtest 2004)

Example: $w(\text{Hg}) = 0.512 \pm 0.065 \text{ mg kg}^{-1}$.

11. REFERENCES

- EPA (2007). U.S. Environmental Protection Agency, EPA method 7473, Mercury in solids and solutions by thermal decomposition, amalgamation and atomic absorption spectrophotometry Rev 0, February 2007:

<http://www.epa.gov/osw/hazard/testmethods/sw846/pdfs/7473.pdf>

- ISO (1995). Guide to the expression of uncertainty of measurements International Organisation for Standardization: Geneva

- Linsinger, T. (2010). European Commission - Joint Research Centre, Institute for Reference Materials and Measurements http://www.erm-crm.org/ERM_products/application_notes/application_note_1/Documents/erm_application_note_1_english_rev3.pdf

- Nordtest (2004). Handbook For Calculation Of Measurement Uncertainty In Environmental Laboratories Edition 2 <http://www.nordicinnovation.net/nordtestfiler/tec537.pdf>

- UNEP (2005). UNEP (DEC)/MED WG.282/inf.5/Rev1, Method for sediment sampling and analysis, February 2005, UNEP.

- UNEP/IOC/IAEA (1984). Reference method 7 rev2: Sampling of selected marine organisms and sample preparation for trace metal.

- UNEP/IOC/IAEA (1994). Reference method 57: Quality assurance and good laboratory practice, UNEP, 1994.

Annex VII:

**RECOMMENDED METHOD FOR THE DETERMINATION OF TOTAL MERCURY IN
SAMPLES OF MARINE ORIGIN BY COLD VAPOUR ATOMIC
ABSORPTION SPECTROMETRY**



REPORT

RECOMMENDED METHOD FOR THE DETERMINATION OF TOTAL MERCURY IN SAMPLES OF MARINE ORIGIN BY COLD VAPOUR ATOMIC ABSORPTION SPECTROMETRY

**IAEA/NAEL Marine Environmental Studies Laboratory in co-operation with
UNEP/MAP MED POL**

December 2012

For further information on this method, please contact:

IAEA-Environment Laboratories
Marine Environmental Studies Laboratory
4a Quai Antoine 1er
MC-98000 Principality of Monaco

Tel. (377) 979 772 72; Fax. (377) 979 772 76

E-mail: NAEL-MESL.Contact-Point@iaea.org

RECOMMENDED METHOD ON THE DETERMINATION OF TOTAL MERCURY
IN SAMPLES OF MARINE ORIGIN BY COLD VAPOUR ATOMIC ABSORPTION
SPECTROMETRY

DISCLAIMER

This is not an official IAEA publication. The views expressed do not necessarily reflect those of the International Atomic Energy Agency or its Member States.

The material has not undergone an official review by the IAEA. This document should not be quoted or listed as a reference.

The use of particular designations of countries or territories does not imply any judgment by the IAEA, as to the legal status of such countries or territories, of their authorities and institutions or of the delimitation of their boundaries.

The mention of names of specific companies or products (whether or not indicated as registered) does not imply any intention to infringe proprietary rights, nor should it be construed as an endorsement or recommendation on the part of the IAEA.

Limited Distribution

Reproduced by the IAEA

TABLE OF CONTENT

1. SCOPE.....	1
2. PRINCIPLE	1
3. REAGENT	2
4. MATERIAL	3
5. INTERFERENCES	4
6. SAMPLE PREPARATION.....	5
7. PROCEDURE	6
8. CALCULATION OF RESULTS	10
9. EXPRESSION OF RESULTS	10
10. REFERENCES	10

NOTE: This method is not intended to be an analytical training manual. Therefore, the method is written with the assumption that it will be used by formally trained analytical chemists.

In addition, the IAEA recommended methods are intended to be guidance methods that can be used by laboratories as a starting point for generating their own standard operating procedure. If performance data are included in the method they must not be used as absolute QC acceptance criteria.

1. SCOPE

This method describes a protocol for measurement of total mercury by cold vapour atomic absorption spectrometry (CV-AAS). The method is simple, rapid and applicable to a large number of environmental samples. This method is applicable when the element content in the digested solution is above the method limit (~ 0.15 ng ml⁻¹ depending on instrument). The typical working range is 0.25–100 ng ml⁻¹ for direct injection of cold vapour, using “batch system”; FIAS or amalgamation accessory will give better sensitivity.

2. PRINCIPLE

The sediment or biological samples are mineralized with strong acids. The inorganic mercury is reduced to its elemental form with stannous chloride. The cold mercury vapour is then passed through the quartz absorption cell of an atomic absorption spectrometer (AAS), where its concentration is measured. The light beam of Hg hollow cathode lamp is directed through the quartz cell, into a monochromator and onto a detector that measures the amount of light absorbed by the atomized vapour in the cell. The amount of energy absorbed at the characteristic wavelength is proportional to the concentration of the element in the sample.

3. REAGENT

The reagents used shall meet the purity requirement of the subsequent analysis:

3.1. WATER

Reagent water (referenced also as water in the text) should be free of contamination.

3.2. NITRIC ACID 65%

3.3. HYDROCHLORIC ACID (37%)

3.4. HYDROGEN PEROXIDE

3.5. VANADIUM PENTOXIDE (V_2O_5)

3.6. SILICON ANTI-FOAMING

3.7. HYDROXYLAMINE HYDROCHLORIDE ($NH_2OH.HCl$)

Dissolve 12.0 g of $NH_2OH.HCl$ in 100 ml reagent water. This solution may be purified by the addition of 0.1 ml of $SnCl_2$ solution and purging 1 hour with Hg-free argon.

3.8. POTASSIUM DICHROMATE OXIDIZING SOLUTION (10% w/v)

Weight 25 g of $K_2Cr_2O_7$ in a 250 ml glass bottle, fill it up to 250 ml with water, and shake until total dissolution of the solid. Keep the bottle tightly closed in a double plastic bag, and in an Hg free environment (i.e. laminar flow hood). This solution is stable indefinitely and rarely becomes contaminated.

3.9. $BrCl$ OXIDIZING SOLUTION

Weigh accurately 11 g of $KBrO_3$ and 15 g of KBr into a clean 1 liter glass bottle. Add 200 ml of Milli-Q water; add carefully 800 ml of concentrated HCl . The dilution has to be carried out in a well-ventilated fume hood to prevent exposure to toxic fumes released during dissolution of $KBrO_3$. Keep the bottle wrapped in aluminium foil, tightly closed in a double plastic bag, and in an Hg free environment (i.e. laminar flow hood). This solution is stable indefinitely but can become contaminated.

3.10. STANNOUS CHLORINE SOLUTION 20% (w/v) in 20% (w/v) HCl

Weigh 20 g of $SnCl_2$ in a 100 ml volumetric flask; add 20 ml of concentrated HCl ; dissolve the $SnCl_2$ (if needed heat at $60^\circ C$ for a few minutes on a hot plate); complete to 100 ml with water. This solution might be purified by bubbling with Hg-free argon for 15 minutes. The obtained solution should be clear and transparent, cloudy or yellow solution indicates a bad quality $SnCl_2$. This solution should be prepared fresh every day preferably, if not it should be kept in the fridge.

Note: The concentration of this solution is dependent on the type of accessory use for vapour generation, and can vary between 5 and 30%, the recommendation of the manufacturer

should be followed (i.e. the solution above is recommended for a VGA-70 from Varian). The validity of the solution (i.e. shelf-life) should be defined during method validation.

3.11. COMMERCIAL STANDARD SOLUTION 1000 $\mu\text{g ml}^{-1}$

Use a certified reference material solution; this solution should be accompanied by a certificate stipulating at minimum the traceability of the certified concentration, as well as the expiry date. The density of the solution, or the certified content in mg kg^{-1} should also be defined, to allow for the preparation of the calibration solution by weighing. Stock solutions should be kept at 5°C.

3.12. ARGON

Use of a gas purifier cartridge for removing mercury, oxygen and organic compounds is recommended.

4. MATERIAL

This section does not list the common laboratory glassware.

4.1. ATOMIC ABSORPTION SPECTROPHOTOMETER

Instrument equipped with an appropriate cold vapour generation system and a quartz or glass tube atomizer. Use a hollow cathode lamp or, preferably, an electrodeless discharge lamp (which gives a greater and more stable light intensity), operated at a current recommended for the lamp and by the instrument manufacturer. An AAS system with background correction device is recommended.

4.2. GLASSWARE

All the glassware, polypropylene, or fluorocarbon (PFA or TFM) containers, including the sample bottles, flasks and pipettes tips, should be washed in the following sequence:

- 24 hrs soaking in a laboratory soap (or 10% alcohol);
- followed by 24 hrs soaking in 10% nitric acid;
- followed by 10% soaking in water;
- final rinse in water; and
- drying under a laminar flow hood.

The cleaned items should be kept in a double sealed plastic bag. It is better to avoid storage of low level ($< 5 \text{ ng ml}^{-1}$) solution in plastic, and for this purpose glass or Teflon is recommended.

If it can be documented, through an active analytical quality control program, using spiked samples and method blanks, then certain steps in the cleaning procedure would not be needed for routine samples, those steps may be eliminated from the procedure (i.e. for the levels

measured by flame AAS, some sterile plastic containers are sufficiently free of contamination for certain analytes).

4.3. PIPETTES

Some microliter pipettes size ranging from 50 to 10000 µl are needed. The accuracy and precision of the pipettes used should be checked as a routine every 6 months, and the results obtained should be compared with the individual certificates.

4.4. VOLUMETRIC CONTAINERS of suitable precision and accuracy.

5. INTERFERENCES

- 5.1. IODIDE, GOLD AND SILVER are known interferences for mercury determination by cold vapour. In samples from marine origin (biota or sediment), the levels of those elements are low, and consequently, do not interfere in the measurement process.
- 5.2. WATER VAPOUR (moisture) should be avoided in the measurement cell, always follow the manufacturer's protocol (e.g. use of membrane drying tube, correct position of gas separator...) and check for absence of moisture in the measurement cell.
- 5.3. When using GOLD AMALGAMATION, and with certain batch systems, the excess of oxidant can cause interference or damage the gold amalgamator, it is then recommended to pre-reduce the samples with hydroxylamine ammonium (see 3.7). This is important when using large amount of digested solution in "batch system".
- 5.4. Some samples (i.e. plants or large amount of mussels) might produce FOAM during the reduction reaction. If the amount of foam is important, it can interfere with gas liquid separation, and/or leak in the measurement cell, this phenomenon can be overcome by using silicon anti-foaming inside the gas liquid separator and/or in the "batch" system. Another option is to use vanadium pentoxide during digestion (see 6.4).
- 5.5. REDUCTION of inorganic mercury will induce loss, so it is important to stabilise all the solutions by using a strong oxidant as dichromate or BrCl (see 3.8 or 3.9).

6. SAMPLE PREPARATION

- 6.1. The sample should be prepared according to the recommended method for digestion of marine samples for the determination of trace metal (IAEA, 2011), but before diluting to the final volume (or weight) with water, add an adequate volume of potassium dichromate or BrCl to get the final concentration of 2% or 1% respectively. All the samples from marine origin (sediment or biota) can be prepared using the acid mixture recommended for fish, as Hg is not attached to silicates. For microwave digestion of sample size above 0.8 g, it is strongly recommended to do cold digestion for at least 5 hours and to use a long ramping time (i.e. 25 minutes) to avoid strong reactions in the microwave vessels.
- 6.2. If other trace elements have to be determined in the digested solution prepared according to the recommended method for digestion of marine samples for the determination of trace metal (IAEA, 2011), following the dilution to the final volume or weight, transfer a quantitatively sufficient amount of digested solution (i.e. at least 10 ml) into a separate container (preferably glass or Teflon), and add an oxidising solution 1% (v/v) of BrCl (see 3.9) or 2% (v/v) of potassium dichromate (see 3.8). Record the amount of oxidising solution added in order to calculate the dilution factor (i.e. dilution factor = 1.01 for 0.1 ml of dichromate in 10 ml).
- 6.3. Alternatively, the samples can be digested using a mixture of 5 ml of HNO₃ and 2 ml of H₂O₂ at 90°C for 4 hours on a hot plate. It is recommended to leave the samples in acid at room temperature, for at least 1 hour before heating. The digestion can be performed either in a Teflon or glass closed containers. After cooling, add an adequate volume of potassium dichromate or BrCl to get the final concentration of 2% or 1% respectively, and dilute to the final volume with water (i.e. for 50 ml final volume, add 1 ml of potassium dichromate or 0.5 ml of BrCl solution). This procedure can be used with bigger sample size if needed (i.e. 2 g); in this case, the volume of nitric acid should be increased to obtain a liquid mixture.
- 6.4. In the case that the digested solution produces foam during the reduction process (see 5.4), 45 mg of vanadium pentoxide should be added in the digestion vessels before addition of the acid mixture, then follow either paragraph 6.1 or 6.3.

7. PROCEDURE

7.1. SAMPLE SOLUTION

Use the sample prepared with one option as described in section 6.

7.2. BLANK SOLUTION

Prepare at least two blank solutions with each batch of sample, using the same procedure than for the samples.

7.3. PREPARATION OF CALIBRATION SOLUTIONS

7.3.1. Before each batch of determination, prepare by the appropriate dilution of 1000 $\mu\text{g ml}^{-1}$ stock standard solution (see 3.11), at least 4 standard solutions and one calibration blank solution, covering the appropriate range of the linear part of the curve. The calibration standards and calibration blank should be prepared using the same type of acid and oxidising solution than in the test portion (the final concentration should be similar).

7.3.2. Calibration solutions should be prepared fresh each day.

7.3.3. If the necessary intermediate stock standard solutions can be prepared in 5% nitric acid and 1% BrCl or 2% $\text{K}_2\text{Cr}_2\text{O}_7$, these solutions should be prepared monthly.

7.3.4. All volumetric material (pipettes and containers) should be of appropriate precision and accuracy, if not available standard solution can be prepared by weighing.

7.4. INSTALLATION OF VAPOUR GENERATOR ACCESSORY

7.4.1. Install the accessory according to the manufacturer's instructions. Certain systems (i.e. VGA from Varian) are designed to be used for hydride generation as well, and require in the instructions to aspirate an extra HCl solution, in the case of stannous chlorine reduction this solution is to be replaced by water. It is recommended to separate the systems used for hydride and for SnCl_2 (i.e. use a spare gas liquid separator and Teflon tubing).

7.4.2. Switch on the argon. For on-line system: start the pump, check the aspiration, and verify the gas liquid separator. If needed replace the pump tubing, clean the gas liquid separator by sonication in diluted detergent.

7.4.3. Clean the system by aspirating reagent and 10% nitric acid as a sample for about 10 minutes. For batch system, perform two cycles with 10% nitric acid.

7.4.4. Set up the atomic absorption spectrometer according to the manufacturer's instructions, at the appropriate wavelength, using the appropriate conditions, and with the suitable background correction system in operation.

7.4.5. Optimise the position of the measurement cell to get the maximum signal.

7.4.6. Connect the vapour generation system to the measurement cell.

7.5. CALIBRATION

7.5.1. Adjust the response of the instrument to zero absorbance whilst aspirating water.

NOTE: if the instrument zero reading is more than 0.002 ABS, the system should be clean again and reagent should be checked.

7.5.2. Aspirate the set of calibration solutions in ascending order, and as a zero member, the blank calibration solution. After the last standard, aspirate 10% nitric acid for 1 minute to rinse the system.

NOTE: The calibration curve is automatically plotted by the instrument software. The obtained curve should be linear with $r > 0.995$.

To correct for the instrumental drift, the calibration should be performed every 20 samples or if the calibration verification has failed (see 7.8.1).

7.6. ASPIRATE SAMPLE BLANK (see 7.2) AND SAMPLE SOLUTIONS (see 7.1)

Record their concentrations as calculated by the software using the calibration curve. Rinse the system by aspirating 10% nitric acid for at least 30 s between samples.

7.7. IF THE CONCENTRATION OF THE TEST PORTION EXCEEDS THE CALIBRATION RANGE, dilute the test portion with the blank solution accordingly.

NOTE: After the measurement of high level (or over calibration) sample, measure a sample blank or water to check the absence of memory effect. If necessary, clean the system for 1 minute with 10% nitric acid.

7.8. QUALITY CONTROL SOLUTIONS

The quality control solutions as described below should be measured during the run.

7.8.1. Calibration Verification CV

After the initial calibration, the calibration curve must be verified by the use of initial calibration verification (CV) standard.

The CV standard is a standard solution made from an independent (second source) material, at/or near midrange. This solution as a calibration standard should be prepared using the same type of acid and oxidising solution than in the test portion (the final concentration should be similar).

The acceptance criteria for the CV standard must be $\pm 10\%$ of its true value.

If the calibration curve cannot be verified within the specified limits, the causes must be determined and the instrument recalibrated before the samples are analysed. The analysis data for the CV must be kept on file with the sample analysis.

The calibration curve must also be verified at the end of each analysis batch and/or after every 10 samples. If the calibration cannot be verified within the specified limits, the sample analysis must be discontinued, the causes must be determined and the instrument recalibrated. All samples following the last acceptable test must be reanalysed.

7.8.2. Blank solution (see 7.2)

The maximum allowed blank concentration should be well documented, and if the blank solution exceeds this value all samples prepared along the contaminated blank should be prepared again and reanalysed.

7.8.3. Post digestion spike

Each unknown type of sample should be spiked to check for potential matrix effect.

This spike is considered as a single point standard addition, and should be performed with a minimum dilution factor. The recovery of spike calculated with equation 1 should be 85-115%. If this test fails, it is recommended to run analysis with standard addition method.

Spike solution: mix a fix volume (V1) of the sample solution, and a known volume (V2) of a standard solution with known concentrations (Cstandard).

Unspike solution: mix the same fix volume (V1) of sample solution, and the same volume (V2) of reagent water.

Measure the concentration C (mg l⁻¹) in both solutions on the calibration curve (see 7.6), and calculate recovery as:

$$C_{spike} = \frac{C_{standard} \times V_2}{(V_1 + V_2)} \quad \text{Equation 1}$$

$$R = \frac{C_{Spike\ Solution} - C_{Unspike\ solution}}{C_{spike}} \times 100 \quad \text{Equation 2}$$

To be valid, the concentrations of spiked and unspiked solutions should be in the linearity range of the calibration curve, and the spiked concentration (equation 1) should be in the range of 50-150% of the concentration of the unspiked solution.

7.8.4. Dilution test

If the analyte concentration is sufficiently high (minimally, a factor of 10 above the lower limit of the quantitation following dilution), an analysis of a 1:5 dilution should agree within

$\pm 10\%$ of the original determination. If not, then a chemical or physical interference effect should be suspected, and method of standard addition is recommended.

7.8.5. Certified Reference Material

At least one certified reference material of a representative matrix should be prepared with each batch of sample, the calculated result should fall in the value of the certificate and within the coverage uncertainty (Linsinger, 2010), to show evidence of an unbiased result.

The results for the CRM should be recorded for quality control purpose and plotted on a control chart (UNEP/IOC/IAEA 1994).

An example of sequence order with recommended criteria and actions is given in table 1.

TABLE 1. EXAMPLE OF AN ANALYTICAL SEQUENCE:

Solutions Description	Performance	Action
Calibration blank	< maximum allowed calibration blank value	Stop until resolve
Standard solution 1–4	$r > 0.995$	recalibrate in the linearity range
CV	$\pm 10\%$ of the true value	Stop until resolve
Sample blank	< maximum allowed blank value	
CRM	Fall in the certificate value within coverage uncertainty, or fall within acceptable criteria of the QC chart	Stop until resolve, check Matrix spike and run again with standard addition method if necessary
Matrix Spike	recovery $100\% \pm 15\%$	switch to standard addition, keep records for future analysis of the same matrix
Dilution Test	sample 1 = 5x sample 1 diluted 5x within 10%	switch to standard addition, keep records for future analysis of the same matrix
Unknown Sample 1–10	should \geq standard 1 and \leq standard 4	report as <minimum quantification limit or dilute
CV	$\pm 10\%$ of the true value	Stop until resolve
Unknown Sample 11–20	should \geq standard 1 and \leq standard 4	report as <minimum quantification limit or dilute
Calibration blank	< maximum allowed calibration blank value	Stop until resolve
Standard solution 1–4	$r > 0.995$	recalibrate in the linearity range
CV	$\pm 10\%$ of the true value	Stop until resolve
Etc....		

8. CALCULATION OF RESULTS

Results are calculated using equation 3

$$w(m) = \frac{(\rho_1 - \rho_0)}{m} \times f \times V \times R \quad \text{Equation 3}$$

Where:

w(m) is the mass fraction of element m in the sample, expressed in mg kg⁻¹;

ρ1 is the concentration of element m, expressed in mg/l as measured in the sample solution;

ρ0 is the concentration of element m expressed in mg/l as measured in the blank solution;

F is the dilution factor calculated as follow:

$$f = \frac{\text{final volume}}{\text{initial volume}}$$

or equal to 1 if ρ1 is determined in undiluted solution;

R is the recovery calculated using the CRM (see 7.8.5) or the post digestion spike.

m is the mass of sample in g

V is the volume of solution in ml

9. EXPRESSION OF RESULTS

The rounding of values will depend on the uncertainty reported with the result; in general for this method two or three significant figures should be reported.

Uncertainty component should be reported with all results. (ISO 2005, Nordtest 2004)

Example: w(Hg) = 0.512 ± 0.065 mg kg⁻¹.

10. REFERENCES

- IAEA (2011). IAEA Recommended method on the microwave digestion of marines samples for the determination of trace element content, 2011, *in preparation*, available upon request
- ISO (1995). Guide to the expression of uncertainty of measurements International Organisation for Standardization: Geneva
- Linsinger T. (2010). European Commission - Joint Research Centre, Institute for Reference Materials and Measurements (http://www.erm-crm.org/ERM_products/application_notes/application_note_1/Documents/erm_application_note_1_english_rev3.pdf)

- Nordtest (2004). Handbook For Calculation Of Measurement Uncertainty In Environmental Laboratories Edition 2 <http://www.nordicinnovation.net/nordtestfiler/tec537.pdf>
- UNEP/IOC/IAEA (1994) reference method 57: Quality assurance and good laboratory practice, UNEP, 1994.

Annex VIII:

HELCOM

Manual for marine monitoring in the COMBINE programme
ATTACHMENT 1. TECHNICAL NOTE ON THE DETERMINATION OF TOTAL
MERCURY IN MARINE BIOTA BY COLD VAPOUR ATOMIC ABSORPTION
SPECTROSCOPY

HELCOM Manual for marine monitoring in the COMBINE programme

ATTACHMENT 1. TECHNICAL NOTE ON THE DETERMINATION OF TOTAL MERCURY IN MARINE BIOTA BY COLD VAPOUR ATOMIC ABSORPTION SPECTROSCOPY

1. POSSIBILITIES OF USING COLD VAPOUR ATOMIC ABSORPTION SPECTROMETRY IN TOTAL MERCURY ANALYSIS

The most widely used method for the determination of total mercury in biological tissues is cold vapour atomic absorption spectrometry (CV-AAS), based on a technique elaborated in detail by Hatch and Ott (1968). In this method, (divalent) ionic mercury is reduced to its metallic form (Hg⁰) in acidic solution using a powerful reducing agent. Subsequently, the elemental mercury is volatilized (purged) by a carrier gas and transported into an absorption cell, where the 253.65 nm wavelength absorbance of mercury atoms is measured.

CV-AAS analysis can be performed manually using batch CV-AAS or automatically using flow injection (FI) techniques. FI is a very efficient approach for introducing and processing liquid samples in atomic absorption spectrometry. The FI technique, combined with a built-in atomic absorption spectrometer optimised for mercury determination, reduces sample and reagent consumption, has a higher tolerance of interferences, lower determination limits and improved precision compared with conventional cold vapour techniques.

The efficiency of various flow injection mercury systems has been reported by several groups (Tsalev *et al.*, 1992a, 1992b; Welz *et al.*, 1992; Guo and Baasner, 1993; Hanna and McIntosh, 1995; Kingston and McIntosh, 1995; Lippo *et al.*, 1997). Better sensitivities of both conventional CV-AAS and FI-CV-AAS can be obtained by collecting mercury vapour released from the sample solution on a gold adsorber (Welz and Melcher, 1984). This so-called amalgamation technique eliminates kinetic interferences due to a different vaporization rate or a different distribution function of the elemental mercury between the liquid and the gaseous phases. The amalgamation ability of the gold adsorber must be carefully and regularly checked. Volatile compounds (in particular sulfur-containing compounds) evaporating together with the elemental mercury from the sample solution may deactivate the adsorber surface. This means an increased risk of underestimation, as unknown quantities of mercury are not collected by the adsorber.

2. SAMPLE PRETREATMENT

It is generally agreed that oxidative conversion of all forms of mercury in the sample to ionic Hg(II) is necessary prior to reduction to elemental Hg and its subsequent measurement by CV-AAS. Therefore, the initial procedural step in mercury analysis is a sample pretreatment, which is aimed at liberating the analyte element from its chemical bonding to the organic matrix and thus transforming all of the analyte species into a well-defined oxidation state. For this purpose, a wide variety of combinations of strong acids (HCl, H₂SO₄, HNO₃) and oxidants (H₂O₂, KMnO₄, K₂Cr₂O₇, K₂S₂O₈) have been tested and recommended (Kaiser *et al.*, 1978; Harms, 1988; Vermeiret *et al.*, 1989; Ping and Dasgupta, 1989; Baxter and Frech, 1990; Landi *et al.*, 1990; Navarro *et al.*, 1992; Lippo *et al.*, 1997).

A suitable sample pretreatment, which implies the complete transformation of all organomercury species into inorganic mercury ions, requires the following:

- oxidation mixtures with a high oxidation potential;
- rapid oxidation (usually promoted by high reaction temperatures), preferably in closed systems;

- compatibility with CV-AAS techniques;
- stability of sample solutions during storage (at least short term);
- no formation of solid reaction products.

On-line sample pretreatment is of particular interest in total mercury determinations because it allows reduction of the well-known problems associated with the inherent risk of contamination, and volatilization and adsorption losses. At present, suitable procedures for on-line pretreatment of solid biological samples are lacking. However, several authors (Tsalev *et al.*, 1992a 1992b; Welz *et al.*, 1992; Guo and Baasner, 1993) have demonstrated that microwave digestion coupled with FI-CV-AAS can successfully be applied to the analysis of liquid samples.

3. CONTROL OF CONTAMINATION AND ANALYTE LOSSES

Major difficulties arise due to the mobility and reactivity of mercury and its compounds, respectively, during sample preparation, sample pretreatment, and analysis. Therefore, the stability of samples and standard solutions is of prime importance, and it is advisable to test the stability of typical standard and sample solutions under typical laboratory conditions.

Mercury can disappear from solution due to several mechanisms, including volatilization of mercury compounds, reduction of such compounds followed by volatilization of elemental (metallic) mercury, adsorption on container walls, adsorption onto colloids or particles, incorporation into stable chemical complexes, or incorporation, upon reduction, into stable amalgams.

Thermodynamic considerations of Toribara *et al.* (1970) showed that loss of mercury from a solution containing the element in the monovalent form may occur readily through disproportion and subsequent loss of metallic mercury. Because of the high oxidation potential of the mercury(II)-mercury(I) system, almost any reducing substance could convert some divalent mercury ions into monovalent mercury ions, which then spontaneously disproportionate into mercury(II) and mercury(0). The latter escape as metallic vapour from the solution into the gas phase. Because of the almost impossibility of preventing the introduction of small amounts of reducing substances by reagents or solvents, the more dilute mercury(II) solutions would be less stable and lose mercury more readily. The only practical method for stabilizing such solutions is to add a small excess of an oxidising substance (such as permanganate), which has a higher oxidation potential than the mercury(II)-mercury(I) system.

Similarly, Feldman (1974) concluded from his experiments that solutions with 0.1 µg divalent Hg dm⁻³ in distilled water could be stored in glass vials for as long as five months without deteriorating if the solutions contained 5 % (v/v) HNO₃ and 0.01 % Cr₂O₇²⁻. Storage of such solutions was safe in polyethylene vials for at least 10 days if the solutions contained 5 % (v/v) HNO₃ and 0.05 % Cr₂O₇²⁻. The efficiency of this mixture was probably due to its ability to prevent the hydrolysis of dissolved mercury and prevent its reduction to valencies lower than +2.

4. REDUCING REAGENTS

Tin(II) chloride and sodium tetrahydroborate are predominantly used as reducing reagents for the determination of total mercury by CV-AAS. Sodium tetrahydroborate has been found advantageous for several applications owing to its higher reducing power and faster reaction (Toffaletti and Savory, 1975). In addition, this reductant has been successfully used even in the presence of interfering agents such as iodide and selenium (Kaiser *et al.*, 1978). However, potential interferences can occur from metal ions (e.g., Ag(I), Cu(II), Ni(II)), which are themselves reduced to the metallic state and so may occlude mercury through amalgamation.

Welz and Melcher (1984) showed that sodium tetrahydroborate could more readily attack those organic mercury compounds which were not reduced to metallic mercury by tin(II) chloride.

However, they stated that sodium tetrahydroborate could not be recommended as the reducing reagent for the amalgamation technique. They found that, due to the rather violent reaction with sodium tetrahydroborate, fine droplets of the sample solution were carried by the gas stream and contaminated or deactivated the adsorber surface. Further, they considered even more important the fact that not only mercury but all gaseous hydride-forming elements (e.g., arsenic, antimony, selenium) were volatilized when sodium tetrahydroborate was used as reductant. These hydrides reacted with the adsorber material and deactivated its surface, thus no longer permitting a sensitive and reproducible determination of mercury.

5. INTERFERENCES

Interferences by volatile nitrogen oxides in the determination of mercury by FI-CV-AAS were studied by Rokkjaer et al. (1993). The main symptom of the interference effects was a suppression, broadening or even splitting of the mercury signal. The authors postulated that volatile nitrogen oxides formed as reaction products of nitric acid during sample decomposition scavenged the reducing agent and concomitantly inhibited the reduction of mercury(II). The rate of the reaction of nitrogen oxides with the reducing agent was considered to be so fast that it was consumed before the reduction of mercury was complete. Rokkjaer et al. (1993) demonstrated that the interference could easily be remedied by purging the sample solution with an inert gas prior to the introduction of the reducing agent. Lippo et al. (1997) concluded from their experiments that nitrogen mono- and dioxide, having molecular absorption bands at 253.63 nm and 253.85 nm, respectively, might cause unspecific absorption at the specific mercury wavelength of 253.65 nm, leading to enhanced and broadened mercury signals if not properly compensated for by adequate instrumental background correction.

6. INTERNAL (ROUTINE) QUALITY CONTROL

In order to demonstrate that the analytical method applied is fit for the purpose of the investigations to be carried out, control materials should be regularly analysed alongside the test materials (cf. Chapter B.5 of the Manual).

The control materials - preferably certified reference materials (CRM) - should be typical of the test materials under investigation in terms of chemical composition, physical properties and analyte concentration. Fitness for purpose is achieved if the results obtained from the analysis of the control materials are within the defined limits of permissible tolerances in analytical error (see Chapters B.3.5, B.4.2.5 and B.4.2.5.2b of the Manual).

7. REFERENCES

- Baxter, D., and Frech, W. 1990. Critical comparison of two standard digestion procedures for the determination of total mercury in natural water samples by cold vapour atomic absorption spectrometry. *Analytica Chimica Acta*, 236: 377-384.
- EURACHEM 2003. EURACHEM/CITAC Guide "Traceability in Chemical Measurement" – A guide to achieving comparable results in chemical measurement. S.L.R. Ellison, B. King, M. Rösslein, M. Salit, A. Williams (Eds.), 43 pp.
- Feldman, C. 1974. Preservation of dilute mercury solutions. *Analytical Chemistry*, 46: 99-102.
- Guo, T., and Baasner, J. 1993. Determination of mercury in urine by flow-injection cold vapour atomic absorption spectrometry. *Analytica Chimica Acta*, 278: 189-196.
- Hanna, C., and McIntosh, S. 1995. Determination of total Hg in environmental samples with on-line microwave digestion coupled to a flow injection mercury system (FIMS). *Atomic Spectroscopy*, 16: 106-114.

- Harms, U. 1988: Analytical procedures for mercury, cadmium and lead in biological material. Baltic Sea Environment Proceedings, No. 27C, Part CI, pp. 36-62. Helsinki Commission.
- Hatch, W., and Ott, W. 1968. Determination of sub-microgram quantities of mercury by atomic absorption spectrometry. *Analytical Chemistry*, 40: 2085-2087.
- Kaiser, G., Götz, D., Tölg, G., Knapp, G., Maichin, B., and Spitzzy, H. 1978. Untersuchung von systematischen Fehlern bei der Bestimmung von Hg-Gesamtgehalten im Bereich 10 -5 % in anorganischen und organischen Matrices mit zwei unabhängigen Verbundverfahren. *Fresenius Z. Analytical Chemistry*, 291: 278-291.
- Kingston, K., and McIntosh, S. 1995. Determination of mercury in geological samples by flow injection AAS. *Atomic Spectroscopy*, 16: 115-117.
- Landi, S., Fagioli, F., Locatelli, C., and Vecchietti, R. 1990. Digestion method for the determination of mercury in vegetable matrices by cold vapour atomic absorption spectrometry. *Analyst*, 115: 173-177.
- Lippo, H., Jauhiainen, T., and Perämäki, P. 1997. Comparison of digestion methods for the determination of total mercury in environmental samples by flow injection CV-AAS. *Atomic Spectroscopy*, 18: 102-108.
- Navarro, M., Lopez, M., Lopez, H., and Sanchez, M. 1992. Microwave dissolution for the determination of mercury in fish by cold vapour atomic absorption spectrometry. *Analytica Chimica Acta*, 257: 155-158.
- Ping, L., and Dasgupta, P. 1989. Determination of total mercury in water and urine by gold film sensor following Fenton's Reagent digestion. *Analytical Chemistry*, 61: 1230-1235. Rokkjaer, J., Hoyer, B., and Jensen, N. 1993. Interference by volatile nitrogen oxides in the determination of mercury by flow injection cold vapour atomic absorption spectrometry. *Talanta*, 40: 729-735.
- Toffaletti, J., and Savory, J. 1975. Use of sodium borohydride for determination of total mercury in urine by atomic absorption spectrometry. *Analytical Chemistry*, 47: 2091-2095.
- Toribara, T., Shields, C., and Koval, L. 1970. Behaviour of dilute solutions of mercury. *Talanta*, 17: 1025-1028. Tsalev, D., Sperling, M., and Welz, B. 1992a: On-line microwave sample pre-treatment for hydride generation and cold vapour atomic absorption spectrometry. Part 1. The manifold. *Analyst*, 117: 1729-1733.
- Tsalev, D., Sperling, M., and Welz, B. 1992b. On-line microwave sample pre-treatment for hydride generation and cold vapour atomic absorption spectrometry. Part 2. Chemistry and application. *Analyst*, 117: 1735-1739.
- Vermeir, G., Vandecasteele, C., and Dams, R. 1989. Microwave dissolution for the determination of mercury in biological samples. *Analytica Chimica Acta*, 220: 257-261.
- Welz, B., and Melcher, M. 1984. Picotrace determination of mercury using the amalgamation technique. *Atomic Spectroscopy*, 5: 37-42.
- Welz, B., Tsalev, D., and Sperling, M. 1992. On-Line microwave sample pre-treatment for the determination of mercury in water and urine by flow-injection cold-vapour atomic absorption spectrometry. *Analytica Chimica Acta*, 261: 91-103.

Annex IX:

Sample work-up for the analysis of selected chlorinated hydrocarbons in the marine environment



UNITED NATIONS ENVIRONMENT PROGRAMME

November 2011

Sample work-up for the analysis of selected chlorinated hydrocarbons in the marine environment

Recommended Methods For Marine Pollution Studies 71

Prepared in co-operation with



NOTE: This recommended method is not intended to be an analytical training manual. Therefore, the method is written with the assumption that it will be used by formally trained analytical chemists. Several stages of this procedure are potentially hazardous; users should be familiar with the necessary safety precautions.

For bibliographic purposes this document may be cited as:

UNEP/IAEA: Sample work-up for the analysis of selected chlorinated hydrocarbons in the marine environment. Reference Methods for Marine Pollution Studies No 71, UNEP, 2011.

PREFACE

The Regional Seas Programme was initiated by UNEP in 1974. Since then, the Governing Council of UNEP has repeatedly endorsed a regional approach to the control of marine pollution and the management of marine and coastal resources and has requested the development of regional action plans. The Regional Seas Programme at present includes thirteen regions and has over 140 coastal States participating in it (1).

One of the basic components of the action plans sponsored by UNEP in the framework of the Regional Seas Programme is the assessment of the state of the marine environment, its resources and the sources and trends of the pollution and its impact on human health, marine ecosystems and amenities. In order to assist those participating in this activity and to ensure that the data obtained through this assessment can be compared on a world-wide basis and thus contribute to the Global Environment Monitoring System (GEMS) of UNEP, a set of Reference Methods and Guidelines for marine pollution studies are being developed as part of a programme of comprehensive technical support which includes the provision of expert advice, reference methods and materials, training and data quality assurance (2). The Methods recommended for adoption by Governments participating in the Regional Seas Programme.

The methods and guidelines are prepared in co-operation with the relevant specialised bodies of the United Nations system as well as other organisations and are tested by a number of experts competent in the field relevant to the methods described.

In the description of the methods and guidelines, the style used by the International Organisation for Standardisation (ISO) has been followed as closely as possible.

The methods and guidelines published in UNEP's series of Reference Methods for Marine Pollution Studies are not considered as definitive. They are planned to be periodically revised taking into account the new developments in analytical instrumentation, our understanding of the problems and the actual need of the users. In order to facilitate these revisions, the users are invited to convey their comments and suggestions to:

Marine Environmental Studies Laboratory
IAEA Environment Laboratories
4, Quai Antoine 1^{er}
MC 98000 MONACO

which is responsible for the technical co-ordination of the development, testing and inter-calibration of Reference Methods.

References:

(1) www.unep.org/regionalseas (2011)

(2) UNEP/IAEA/IOC: Reference Methods and Materials: A Programme of comprehensive support for regional and global marine pollution assessment. UNEP, 1990.

CONTENTS

	Page
1. Scope and field of application	1
2. Principles	1
3. Reagents, solvents, standards	1
3.1. Reagents	1
3.1.1. List of reagents	1
3.1.2. Cleaning of solvents	3
3.1.3. Cleaning of reagents and adsorbents	3
3.1.3.1. Cleaning of reagents	3
3.1.3.2. Cleaning of adsorbents	4
3.2. Apparatus and equipment	4
3.2.1. List of materials	4
3.2.2. Cleaning of glassware	5
4. Sediments	7
4.1. Sampling	7
4.2. Cleaning of extraction thimbles	7
4.3. Extraction of sediment	7
4.3.1. Extraction of freeze-dried samples	7
4.3.2. Extraction of wet samples	7
4.3.3. Example of determination of percent moisture	8
4.4. Concentration of the extract	8
4.5. Extractable organic matter	9
4.6. Clean-up procedure and fractionation	10
4.6.1. Sulphur and sulphur compounds removal	10
4.6.2. Fractionation	11
4.6.2.1. Florisil	11
4.6.2.2. Gel permeation chromatography	13
4.6.2.3. Alumina and HPLC (silica column)	13
4.6.2.4. High pressure chromatography	13
5. Biota	14
5.1. Sampling	14
5.2. Cleaning of extraction thimbles	14
5.3. Extraction of tissues	16
5.3.1. Extraction procedure for freeze-dried samples	16
5.3.2. Extraction procedure without freeze-drying	16
5.4. Concentration of the extract	16
5.5. Extractable organic matter (EOM)	16
5.6. Clean-up procedure and fractionation	16
5.6.1. Removal of lipids by concentrated sulphuric acid	16
5.6.2. Fractionation	16
6. Capillary Gas chromatographic determinations	17
6.1. Gas chromatography conditions	17
6.2. Column preparation	17
6.3. Column test	18
6.4. Electron capture detector	19
6.5. Quantification	19
7. Computerized gas chromatography/Mass spectrometry (GC/MS)	20
7.1. Operating conditions	20
7.2. Example of a selected ion monitoring programme useful for quantitative analysis of chlorinated compounds	25
8. Notes on water analysis	25
9. Alternative procedures	25
9.1. Combining sample preparation and extraction for chlorinated and petroleum hydrocarbons	25
9.2. Supercritical fluid extraction (SFE) of marine samples	26
9.3. Microwave assisted extraction for marine samples	28
9.3.1. Sediment	28
9.3.2. Biota	28

10. Data interpretation	29
10.1. DDT	29
10.2. PCBs congeners	29
10.3. Typical profiles of commercial mixtures	30
11. Quality assurance / quality control	31
11.1. Precision	31
11.2. Accuracy	31
11.3. Blanks	31
11.4. Recovery	31
11.5. Archiving and reporting of results	31
12. References	34
 Annex:	
Explanations sent to all laboratories with sets of standard provided by IAEA-EL/MESL.	36

1. SCOPE AND FIELD OF APPLICATION

This reference method is intended for use in monitoring programmes and pilot research studies. The document describes procedures for the isolation of purified fractions amenable for the determination of DDTs and PCBs in marine sediments and marine organisms by capillary GC/ECD. It is assumed that most of the participants in the UNEP Regional Seas Programmes are equipped with advanced high resolution capillary gas chromatographs and will be able to implement most, if not all, of the procedures described in Reference Method No 40, "Determination of DDTs and PCBs by capillary gas chromatography and electron capture detection" (UNEP 1988). Assuming consistent results are routinely being obtained with these methods by the analytical laboratory, the determination of specific compounds (as opposed to generic mixture of PCBs) opens up the possibility not only of identifying environmental "hot spots", but also for characterising sources, elucidating transport pathways and developing data of greater toxicological relevance. The organisation and content of this document, however, deserves further comment. Under the sections devoted to SEDIMENTS and ORGANISMS, subsections are provided relating to procedures for: 1) Sampling, 2) Extraction and 3) Clean-up and fractionation. In each subsection, several alternative procedures are described. These various procedures have been previously tested and are provided to accommodate the range of capabilities in participating laboratories. For example, laboratories which have access to an HPLC may consider the benefits of using HPLC fractionation procedures in lieu of more conventional low pressure column chromatographic method. Participants are generally encouraged to implement the most effective procedures within the constraints of their individual laboratories.

Several other halogenated pesticides and other electron capturing organic compounds may be present in environmental samples and many of these compounds could also be isolated by the methods described here. However, not all residues will be stable to the clean-up procedures applied for the determination of PCBs and DDTs. Consequently, every analyst must test for analyte recovery and analytical reproducibility prior to applying these methods for other analytes on a routine basis. Primary emphasis should be placed on obtaining the cleanest possible purified fraction for capillary GC/ECD analysis so that interferences and misidentification are minimised, if not eliminated.

2. PRINCIPLES

Following collection of sediment or biota samples using appropriate techniques, samples are stored in trace organic free vessels at -20°C until analysis. For analysis, the samples are prepared for solvent extraction. To achieve a satisfactory recovery of the chlorinated hydrocarbons, samples are dried by either desiccation with anhydrous sodium sulphate or by freeze-drying. Lipids are then Soxhlet extracted from sediments using hexane and dichloromethane, and from biota using hexane or petroleum ether. Following initial clean-up treatments (removal of sulphur from sediment extracts and treatment of biota extracts with concentrated sulphuric acid to destroy some interfering lipids), extracts are fractionated using column chromatography. Detailed protocols for absorption chromatographic fractionation are described for both low and high pressure systems, using Florisil and silica gel respectively. (Additional information concerning alternative techniques including gel permeation chromatography is provided).

3. REAGENTS, SOLVENTS, STANDARDS

3.1. Reagents

3.1.1. List of reagents

- Demineralized distilled water produced by distillation over potassium permanganate (0.1 g/l KMnO₄) or equivalent quality, demonstrated to be free from interfering substances.
- Detergent.
- Potassium dichromate.
- HCl. 32%.
- Concentrated H₂SO₄ (d 20°C: 1.84 g/ml).
- Sulfochromic cleaning solution made from concentrated sulphuric acid and potassium

- dichromate.
- KOH.
 - Anhydrous sodium sulphate.
 - Copper fine powder (particle size 63µm).
 - Carborundum boiling chips.
 - Hg.
 - Glass wool
 - Alumina (200-240).
 - Silica gel (60-100).
 - Florisil PR (60-100).
 - Bio-Beads SX-3 (200-400).
 - Sephadex LX-20.

Solvents:

- Hexane, Dichloromethane, Methanol, Pentane, Cyclohexane, Toluene and Ethyl Acetate, all "distilled in glass" quality.

Standards:

- PCB congeners: 29, 30, 121, 198.
- ε HCH.
- Endosulfan Id₄.
- n-C₁₄ d₃₀, n-C₁₉ d₄₀, n-C₃₂ d₆₆.
- Naphthalene d₈.
- Hexamethylbenzene.
- Cadalene: 1, 6-dimethyl-4-(1-methylethyl)naphthalene.
- DDT reference solutions - Prepare a stock solution of the DDT series (pp' DDT, op DDT, pp' DDD, op DDD, pp' DDE, op DDE) by dissolving 50 mg of each compound in 100 ml of hexane. Store stock solution in sealed glass ampoules.
- Other reference solutions - should be prepared if other residues are to be quantified in these procedures.

NOTES:

Working solutions obtained from the stock reference solutions should be prepared on a regular basis depending on their use and stored in clean glass volumetric flasks tightly capped with non-contaminating materials such as Teflon or glass. Extreme care must be taken to ensure that the concentrations of the standards have not altered due to solvent evaporation.

In order to achieve acceptable accuracy for the standard solutions, at least 50 mg of pure individual compound should be weighed and dissolved into 100 ml of hexane. This will give stock solutions of 500ng/µl.

Example of preparation of stock solutions:

Preparation of a stock solution of pp' DDE at approximately 500ng/µl:

The pp' DDE stock solution is prepared by dissolving approximately (but weighed accurately) 50 mg of pp' DDE in hexane in a 100 ml volumetric flask and bringing the volume to exactly 100 ml with hexane. If the actual weight of pp' DDE is 52 mg, then

$$\frac{52 \text{ mg DDE}}{100 \text{ ml solvent}} \times \frac{1000 \mu\text{g}}{\text{mg}} \times \frac{\text{ml}}{1000 \mu\text{l}} = \frac{52 \text{ mg DDE}}{100 \text{ ml of solution}}$$

$$52 \text{ mg}/100 \text{ ml} \Rightarrow 0.52 \text{ mg/ml} \Rightarrow 520 \mu\text{g/ml} \Rightarrow 520 \text{ ng}/\mu\text{l}$$

The concentration of the stock solution will be: 520ng/µl

Preparation of an intermediate solution:

Use the stock solution to prepare the intermediate solution. The concentration of pp' DDE intermediate solution should be approximately 5ng/μl. To prepare the 5ng/μl intermediate solution, transfer 1 ml of the pp' DDE stock solution into a 100 ml volumetric flask and dilute with hexane to 100 ml.

$$\frac{1 \text{ ml DDE stock solution}}{100 \text{ ml final volume}} \times \frac{520 \text{ ng DDE}}{\mu\text{l}} = \frac{5.2 \text{ ng}}{\mu\text{l intermediate solution}}$$

The concentration of the intermediate solution will be: 5.2 ng/μl

Preparation of the working solution:

Use the intermediate solution to prepare the working solution. The concentration of pp' DDE in the working solution could be approximately 50pg/μl.

To prepare the 50 pg/μl working solution, transfer 1 ml of the pp' DDE intermediate solution into a 100 ml volumetric flask and dilute with hexane to 100 ml.

$$\frac{1 \text{ ml DDE intermediate solution}}{100 \text{ ml final volume}} \times \frac{5.2 \text{ ng}}{\mu\text{l}} \times \frac{1000 \text{ pg}}{\text{ng}} = \frac{52 \text{ pg}}{\mu\text{l working solution}}$$

The concentration of the working solution will be: 52 pg/μl

3.1.2. Cleaning of solvents

All reagents, including the distilled water should be of analytical quality. Commercially available solvents like acetone, acetonitrile, dichloromethane, hexane and pentane are invariably contaminated with ECD-active substances; their concentrations vary from batch to batch and with supplier. Reagent quality should be checked by injection of 2 μl of a 100 ml batch of solvent, after concentration to 50 μl in a rotary evaporator. No peak in the GC-ECD chromatogram (90 - 250 °C) should be larger than that for 1pg of lindane. Otherwise, the solvent must be distilled. The following procedure has been found to be both efficient and cost effective, as it allows the use of technical grade solvents as the basic material (reducing the cost by one order of magnitude). 130 - 150 cm height columns are required; the packing material must be glass (to allow subsequent cleaning with an oxidising acid). The entire equipment is cleaned prior to use by 2 consecutive distillation procedures with 500 ml water in each case. It is essential that a current of nitrogen gas (15 ml/min) flows from the distillation flask during distillation of the organic solvents: the condenser serves as exhaust. Ambient air is not in contact with the solvent in this way. Problems are associated with other methods of excluding room air (e.g., active carbon or molecular sieves), the most important one being discontinuity. The condensate is distilled into a 1 litre flask at a 1:20 ratio. This large volume allows for direct transfer into the appropriate solvent containers which should be made of glass and of a sufficient size to provide solvent for not more than 6 analyses. A bottle with sufficient solvent for 10 - 15 analysis has to be opened and closed many times and even when kept closed, when not in use, contamination from the surrounding atmosphere takes place. For more detailed information, consult the Reference Method No 65: UNEP/IOC/IAEA: Reagent and laboratory ware clean-up procedures for low-level contaminant monitoring.

3.1.3. Cleaning of reagents and adsorbents**3.1.3.1. Cleaning of reagents**

Powdered or crystalline reagents, such as anhydrous sodium sulfate (Na₂SO₄)*, potassium hydroxide (KOH), glass wool * and carbon or carborundum boiling chips *, must be thoroughly cleaned before use. They should be extracted with hexane in a Soxhlet apparatus for 8 hours and then with methanol or dichloromethane for another 8 hours. For those items indicated by an *, this will require pre-combustion in a muffle furnace at approximately 400°C.

3.1.3.2. Cleaning of adsorbents

Silica gel, alumina and Florisil have to be solvent extracted. Each reagent is first refluxed with methanol or dichloromethane in a Soxhlet apparatus for 8 hours, then with n-hexane for the same period. The solvent is removed by a rotary evaporator operating at low speed, until the sorbent starts falling down as fine particles. Reagents are dried in a drying oven at 0.01 mbar. If this is not available, they are dried in a normal oven at 120°C for 4 hours. This serves to activate silica and alumina. Florisil has to be activated at 130°C for 12 hours. The sorbent is allowed to cool in the oven (if possible under vacuum to avoid uptake of contaminants from the atmosphere) or alternatively, in a dessicator. As active sorbents attract water and contaminants from the atmosphere, controlled deactivation should be carried out by adding water to the fully active sorbent (5% by weight to silica, 2% by weight to alumina, and 0.5% by weight to Florisil). The deactivation procedure should be carried out by adding the water to the sorbent and mixing by gentle shaking for a few minutes. The equilibration takes one day. The activity can be maintained for longer periods of time by sealing the required amount of sorbent in glass ampoules. Otherwise, the activation/deactivation has to be done the day before use.

3.2. Apparatus and equipment

The laboratory used for organic trace analysis must be a dedicated facility, isolated from other projects that could be sources of contamination. It must be properly constructed with fume hoods and benches with electric sockets that are safe for use with flammable solvents. The laboratory must have extractors and rotary evaporators cooling water to run the stills. In tropical regions and in dry climates, a refrigerated re-circulating system should be used to reduce temperatures to the required levels and/or to conserve water. Stainless steel or ceramic tiles make good non-contaminating surfaces. If necessary, benches can be coated with a hard epoxy resin and walls can be painted with epoxy paint. A sheet of aluminium foil on the workbench provides a surface which can be cleaned with solvent. A vented storage facility for solvents is essential. Benches must be fitted with frames to hold stills, extractors, etc. The emergency cut-off switch should be accessible from both inside and outside the laboratory. Fire fighting equipment should be mounted in obvious places and laboratory personnel trained in their use.

3.2.1. List of materials

- A coring device with liners and plunger or a grab sampler (thoroughly cleaned with detergents and solvents before use).
- Glass jars and aluminium foil, stainless steel knives, scoops, forceps, labels, marking pens, logbook.
- Insulated plastic boxes for transporting samples. Ice or dry ice.
- Deep freezer (-18 to -20°C) for sample preservation (frost free type freezers heat to above zero during frost removal cycles and they cannot be used for long term storage).
- Rotary evaporator.
- Kuderna-Danish (or similar) concentrator and heater.
- Soxhlet extraction apparatus and heaters.
- Glassware including boiling flasks, ground glass stoppers, beakers, Erlenmeyer flasks, separatory funnels, centrifuge tubes, weighing bottles, pipettes, tissue grinders.
- Drying oven (temperature range up to at least 300°C) for determining sample dry weights, baking of contaminant residues from glassware and reagents.

Note: A muffle furnace is better for baking materials at greater than 300°C, if required.

- Centrifuge and tubes.
- Freeze-dryer and porcelain pestle and mortar.
- Analytical balance with an accuracy of 0.1 mg and an electro-balance with an accuracy of at least 1 µg.
- Stainless steel tweezers and spatulas.

- Dessicator - completely free of organic contamination and with no grease applied to sealing edges.
- Supply of clean, dry nitrogen.
- Columns for silica gel, alumina and Florisil chromatography.
- Mechanical blender (food mixer).
- Vacuum pump (water-jet air pump).

3.2.2. Cleaning of glassware

Scrub all glassware vigorously with brushes in hot water and detergent. Rinse five times with tap water and twice with distilled water. Rinse with acetone or methanol followed by hexane or petroleum ether. Bake overnight in an oven at 300 °C. All glassware should be stored in dust free cabinets and tightly sealed with pre-cleaned aluminium foil when not in use. Ideally glassware should be cleaned just before use.

For more detailed information, consult Reference Method No 65: UNEP/IOC/IAEA: Reagent and laboratory ware clean-up procedures for low level contaminant monitoring.

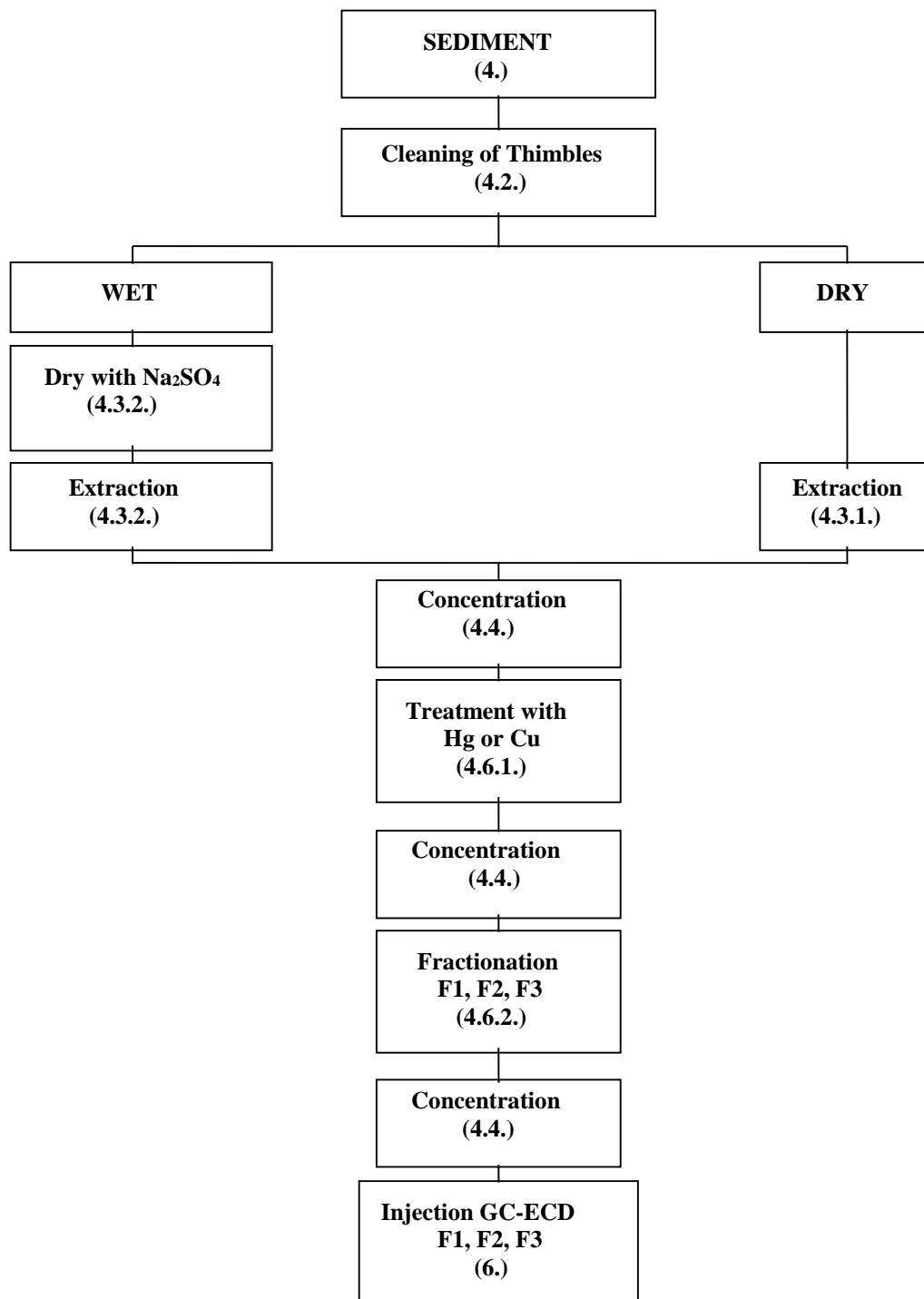

Diagram of the extraction procedure for sediment samples.

4. SEDIMENTS

4.1. Sampling

For the preparation of the samples (including selection of sites, collection of samples and storage) the reader should refer to the Reference Method N° 58: Guidelines for the use of sediments for the marine pollution monitoring programmes, to the Reference Method N° 20: UNEP/IOC/IAEA: Monitoring of petroleum hydrocarbons in sediments and to UNEP(DEC)/MEDW.C282/Inf.5/Rev1: Methods for sediment sampling and analysis (2006).

4.2. Cleaning of extraction thimbles

Paper extraction thimbles should be cleaned prior to sample extraction. For use in the extraction of sediment samples, the extraction can be performed in the Soxhlet apparatus with 250 ml of a mixture hexane / dichloromethane (50:50) for 8 hours cycling the solvent through at a rate of 4 to 5 cycles per hour. Add into the solvent a few carborundum boiling chips to get a regular ebullition.

The use of disposable paper thimbles for the extraction procedure rather than re-usable glass fibre thimbles is recommended due to the difficulties encountered in cleaning the latter.

4.3. Extraction of sediments

4.3.1. Extraction of freeze-dried samples

Select a 50-100 g sub-sample of the sediment, weigh this sub-sample and freeze-dry it. When dried, re-weigh it and calculate the dry to wet ratio. Then pulverise the sample using a pestle and mortar and sieve it using a 250 µm stainless steel sieve. Accurately weigh about 20 g of ground sample and place it in the pre-cleaned extraction thimble. Add 1 ml of a solution of 25 pg/µl of 2,4,5 trichlorobiphenyl (PCB N° 29), 20.9 pg/µl of 2,2',3,3',4,5,5',6 octachlorobiphenyl (PCB N° 198), 20 pg/µl of ε HCH and 21 pg/µl of Endosulfan Id₄ as internal standards and extract for 8 hours in a Soxhlet apparatus with 250 ml of a mixture hexane / dichloromethane (50:50), cycling the solvent through at a rate of 4 to 5 cycles per hour, add into the solvent a few carborundum boiling chips to get a regular ebullition. Alternatively (or in addition), PCB congeners No 30, 121, or octachloronaphthalene and PCB congeners can be used as internal standards. Prepare a procedural blank by extracting an empty thimble using the same procedure as for the samples.

4.3.2. Extraction of wet samples

The sediment is thawed, sieved at 250 µm and homogenised manually with a stainless steel spatula or clean glass rod. A sub-sample of 1-2 g is weighed into a flask and placed in a drying oven at 105 °C for 24 hours, then allowed to cool to room temperature and re-weighed. Calculate the dry to wet ratio and discard the dry sediment (unless it is being used for other analysis e.g. TOC, total organic carbon).

Place a 30-40 g sub-sample of thawed, homogenised sediment into a blender. Slowly, add 100g of anhydrous sodium sulphate (desiccant) and blend the mixture at high speed for 10 minutes. Transfer the dried sample quantitatively to the pre-cleaned extraction thimble in the Soxhlet apparatus, add the internal standard solution (see above) and apply the same extraction procedure as above. Extract the same amount of sodium sulphate as a procedural blank, making sure to add an appropriate amount of internal standard solution.

4.3.3. Example of determination of percent moisture

Many environmental measurements require the results to be reported on a dry weight basis. The percent moisture or water content in the sample is determined by weighing an aliquot, not used for analysis, of the sample before and after drying. The drying can be done by heating a few grams (1-2 g) of the sample in an oven to constant weight.

Weigh an empty glass beaker that will be used to hold the sample while it is dried.

Empty beaker weight = 10.4417 g

Add the wet sample to the beaker and reweigh. Calculate the wet weight of the sample.

Empty beaker weight + wet sample = 12.2972 g

Wet sample weight = 12.2972 g - 10.4417 g = 1.8555 g

Dry the sample to constant weight: dry the sample for 24 hours, weigh it, dry again for 12 hours, re-weigh it, when the difference in weight is less than 5%, it means that the sample is dried.

Empty beaker weight + dry sample weight = 10.9396 g

Dry sample weight = 10.9396 g - Empty beaker weight

Dry sample weight = 10.9396 g - 10.4417 g = 0.4979 g

Calculate the percent dry sample weight.

$$\begin{aligned} \% \text{ Sample weight} &= \frac{\text{Sample dry weight}}{\text{Sample wet weight}} \times 100 \\ &= \frac{0.4979}{1.8555} \times 100 = 26.8 \% \end{aligned}$$

Calculate the percent moisture.

$$\begin{aligned} \text{Water content} &= \text{wet weight} - \text{dry weight} \\ &= 1.855 \text{ g} - 0.4979 \text{ g} = 1.3576 \text{ g} \end{aligned}$$

$$\% \text{ Moisture} = \frac{\text{Sample water weight}}{\text{Sample wet weight}} \times 100$$

$$\% \text{ moisture} = \frac{1.3576}{1.8555} \times 100 = 73.2 \%$$

4.4. Concentration of the extract

For both extraction procedures, the extracts are concentrated in a rotary evaporator to about 15 ml. Under good vacuum conditions the temperature of the water bath must not exceed 30 °C. Dry the extract with anhydrous sodium sulphate (when the sodium sulphate moves freely in the flask it means that the extract is dried). Collect the dried extract in the graduated tube of a Kuderna-Danish concentrator. Concentrate the extract to approximately 5 ml with the Kuderna-Danish concentrator and adjust the volume to exactly 1 ml by evaporating excess solvent under a gentle stream of clean dry nitrogen. The sample extract will be analysed gravimetrically for extractable organic matter (EOM) content at the 1 ml volume as a starting point. If measurements of the EOM are outside the calibration range of the balance, the total volume of the extract is adjusted accordingly using either dilution with hexane or evaporating under a stream of nitrogen gas.

4.5. Extractable organic matter

Before carrying out the clean-up procedure, it is advisable to determine the extractable organic matter.

The EOM is determined in the following manner. On the weighing pan of an electro-balance, evaporate a known volume of the sediment or biota extract (up to 100 µl) and weigh the residue with a precision of about ± 1 µg. If the residue is less than 2 µg, pre-concentration of the original extract is required. The quantity of EOM is:

$$\text{EOM } (\mu\text{g/g}) = \frac{\text{Weight of residue } (\mu\text{g}) \times \text{volume of the extract (ml)} \times 1000}{\text{Volume evaporated } (\mu\text{l}) \times \text{quantity of sample extracted (g)}}$$

Note that extreme care must be taken to ensure balance and pans are clean, dry and stable to obtain accurate readings at the ± 1 µg level. A small hot plate is used to warm pans and forceps and thus keep these instruments dry after solvent cleaning. If no electro-balance is available, a known volume of the extract can be transferred into a clean pre-weighed beaker. The solvent is evaporated with dry and clean nitrogen until a constant weight of about 1 mg is reached. Calculate the amount of “lipids” in the sample taking into account the volume of the lipid extract which was dried.

Example of calculation of E.O.M.

The extractable organic matter content of a sample is operationally defined as the weight of material extracted with the solvent employed (H.E.O.M. in case hexane is used as solvent). An aliquot of the sample extract is taken (few µl), the solvent is evaporated and the residue is weighed to determine the quantity of lipids extracted in the aliquot and from it to the total sample. The results are normally reported in mg lipids per gram dry weight extracted.

A 1 µl aliquot is removed from a 2.5 ml sample extract for determination of E.O.M. The 1 µl aliquot is evaporated on the pan of an electro-balance and the residue is weighed. Three determinations are made and the average taken.

Measurements:

Sample dry weight extracted: 4.443 g

Total volume of the extract: 2.5 ml

Sample aliquot removed: 1 µl

(1) Weight of a 1 µl aliquot after solvent evaporation: 32.2 µg

(2) Weight of a 1 µl aliquot after solvent evaporation: 32.1 µg

(3) Weight of a 1 µl aliquot after solvent evaporation: 32.3 µg

Average weight of a 1 µl aliquot : 32.2 µg

Total volume of the extract: 2.5 ml

Total quantity of lipids in the sample:

$$32.2 \mu\text{g}/\mu\text{l} \times 2.5 \text{ ml} \times \frac{1000 \mu\text{l}}{\text{ml}} = 80500 \mu\text{g} \text{ or: } 80.5 \text{ mg}$$

With 4.443 g of sample extracted:

$$80.5 \text{ mg} / 4.443 \text{ g} = 18.1 \text{ mg lipids/g}$$

4.6. Clean-up procedure and fractionation

Purposes of the clean-up: removal of lipids, whenever present at a significant amount; removal of elementary sulphur and sulphur compounds. Both these compound classes can interfere with the gas-chromatographic separation.

4.6.1. Sulphur and sulphur compounds removal

Elementary sulphur and sulphur compounds such as mercaptans should be removed from the extract. This could be done by using either mercury or activated copper.

a) Mercury method.

Add one drop (a few ml) of mercury to the sediment extract and shake vigorously for one minute. Centrifuge and carefully recover and transfer the extract in another tube with a Pasteur pipette. If the mercury is still tarnished, repeat the treatment with another drop of mercury, shake, transfer the hexane into another tube. Repeat this treatment until the mercury stays brilliant in the extract. Rinse the mercury with 5 ml of hexane and combine the extracts. Then, concentrate the resulting solution to ca. 1 ml with a gentle stream of nitrogen.

Cleaning of mercury:

Caution: When removing mercury from the sample, always use a plastic tray to keep the glassware in and work under a fume hood.

Fit a folded filter paper in a 10 cm diameter conical glass funnel and fix the funnel over a 250 ml glass beaker. Using a needle, make a small hole in the bottom of the filter paper. Carefully put the mercury onto the funnel. The mercury flows through the small hole in the filter paper leaving the solid impurities on its surface. The mercury collected is washed three times by shaking it carefully with dichloromethane and by removing dichloromethane layer with the help of a clean glass syringe. Allow the rest of dichloromethane evaporate and store the clean mercury in a thick walled glass bottle with a ground glass stopper. In order to avoid escape of mercury vapour, store the mercury under methanol.

Another way of cleaning the mercury involves sucking the dirty mercury through a capillary tube, such as a Pasteur pipette, connected to a guard-flask and then to a vacuum pump. The mercury will pass through the Pasteur pipette and will be collected and cleaned in the guard-flask. Then it should be transferred into a thick wall glass bottle with a ground glass stopper. The mercury is covered with a layer of methanol to protect it from oxidation.

b) Activated copper method.

Transfer about 20 grams of the copper powder in an Erlenmeyer. Add enough concentrated HCl to cover the copper powder, agitate. Sonicate for 10 min., agitate, put again in ultrasonic bath and sonicate for 10 min. Throw the used HCl, add some fresh HCl, transfer in ultrasonic bath and sonicate for 20 min. repeat that procedure four times in total. Wash with distilled water, agitate, discard, add water again, transfer in ultrasonic bath and sonicate for 15 min., discard the used water, repeat that procedure again, up to pH neutral. Wash with acetone, agitate, transfer in ultrasonic bath and sonicate for 15 min. repeat that procedure four times in total. Then use the same procedure with hexane as a solvent.

Keep in hexane (use it immediately, avoids Cu to be in contact with air).

Transfer 3 to 4 Pasteur pipettes per sample in the flasks containing the hexane extracts. Let the copper react all night. The presence of sulphur compounds in the sample will be detected by the tarnishing of the copper powder. Then, concentrate the resulting solution to ca. 1 ml with a gentle stream of pure nitrogen.

4.6.2. Fractionation

An adsorption chromatography step is used to remove interfering lipids and to fractionate the extract into classes of compounds. Many variations of adsorption chromatography clean-up procedures have been published to date. Four procedures are reported here in order of increasing complexity.

Preparation of the columns: Glass burettes (1 cm diameter) with Teflon stopcocks make convenient adsorption columns. The column is plugged with pre-cleaned cotton or glass wool. Prepare separate columns for each sample and blank determination. The column is partially filled with hexane. The appropriate amount of sorbent is mixed with hexane in a small beaker to form a slurry. A glass funnel and a glass rod are used to pour the adsorbent into the column. Several rinses with hexane are necessary to fill the column to the desired height. Tap with a pencil or a hard silicone tube against the column in order to settle the adsorbent into an even bed. Flush the material adhering to the wall of the column down to the bed with solvent. Prepare each column freshly immediately before use. Never let the column get dry.

4.6.2.1. Florisil

A Florisil column is used for this fractionation, which is prepared in the following way. The Florisil should be pre-extracted in the Soxhlet apparatus to remove any contaminants, using methanol or dichloromethane for 8 hours, followed by hexane for another 8 hours. It is then dried in an oven. Activation is achieved by heating the dried Florisil at 130°C for 12 hours. It is then partially deactivated with 0.5% water by weight and stored in a tightly sealed glass jar with ground glass stopper. The water should be well mixed into the Florisil and the mixture should be allowed to equilibrate for one day before use. The activation/deactivation procedure should be carried out one day before use. A 1 cm burette with Teflon stopcock is plugged with pre-cleaned glass wool. A column with a sintered glass disk could also be used. 17 grams of Florisil are weighed out in a beaker and covered with hexane. A slurry is made by agitation and poured into the glass column. The Florisil is allowed to settle into an even bed and any Florisil adhering to the column is rinsed down with hexane. The solvent is drained to just above the Florisil bed. It should be rinsed with a further 5 ml of hexane; one gram of anhydrous sodium sulphate is added to the top of the column in order to protect the surface of the Florisil from any disturbance. The column should never run dry. Individual columns should be prepared immediately before use and a new column of Florisil used for each sample.

The extract, reduced to 1 ml, is put onto the Florisil column. It is carefully eluted with 65 ml of hexane and the first fraction collected. Then the column is eluted with 45 ml of a mixture containing 70 % of hexane and 30 % of dichloromethane and the second fraction collected. The third fraction will be eluted with 60 ml of pure dichloromethane.

Fraction one will contain the PCBs, pp' and op DDE and some other pesticides such as HCB, aldrin, heptachlor, DDMU.

Fraction two will contain the DDTs, DDDs, most of the toxaphene, and some pesticides such as the HCH isomers and chlordane components.

Fraction three will contain mainly dieldrin, endrin, heptachlor epoxide and endosulfan components. Typical chromatograms obtained are shown below.

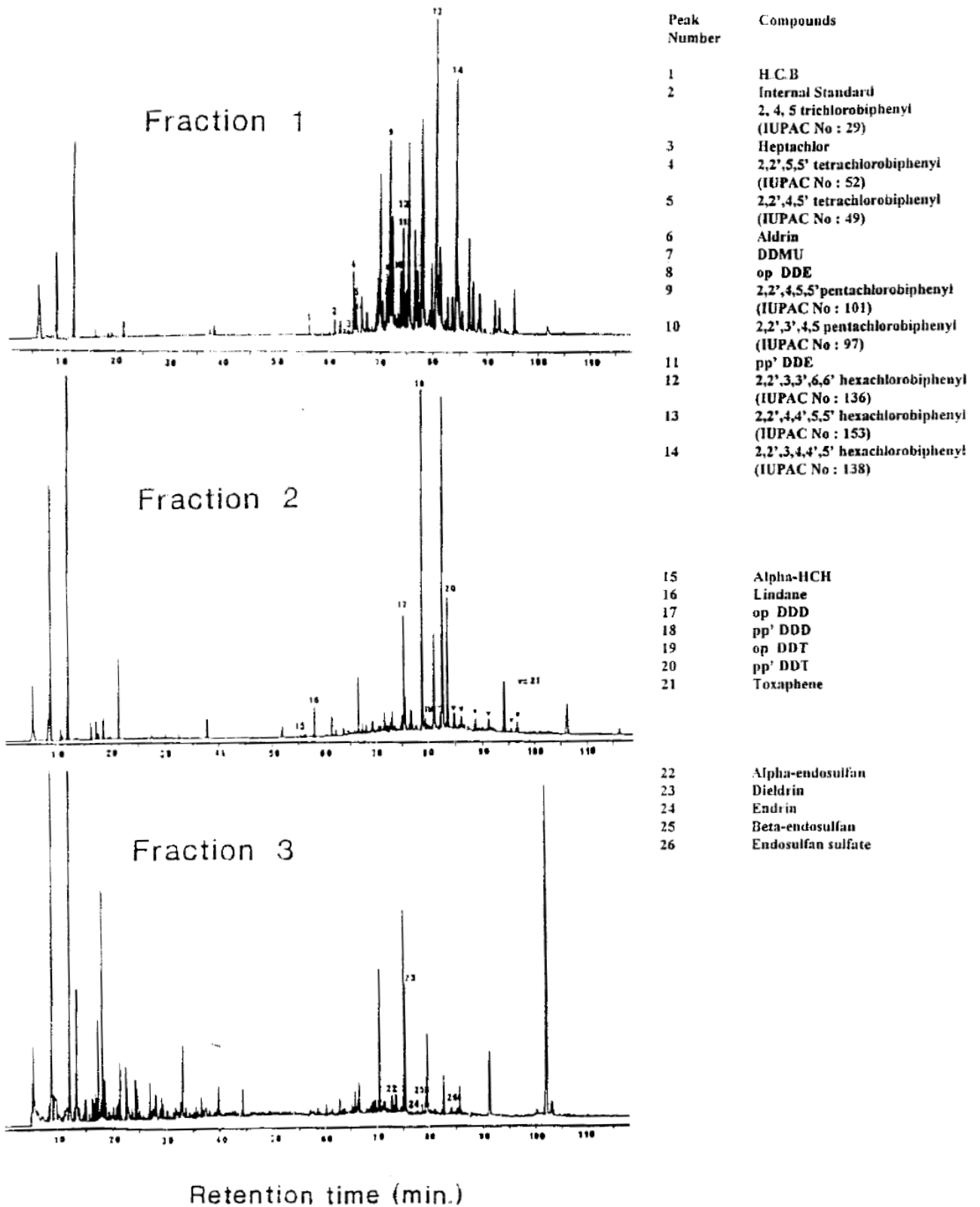

Figure 2: GC-ECD organohalogen analyses

4.6.2.2. Gel permeation chromatography

Low pressure GPC can be used as an alternative clean-up technique to remove high molecular weight co-extractable lipidic material from polycyclic aromatic compounds and halogenated aromatics. Concurrently, elemental sulphur could be also removed from the whole organic extract.

The main feature of the semi-preparative-GPC as a clean-up technique relies on the compatibility of this analytical procedure with labile components of the extract (i.e. DDTs, chlorinated cyclohexadiene derivatives), which are not stable in other types of extract clean-up procedures. Further, GPC as a clean-up technique has already been automated, enabling a high sample throughput, taking into account the short analysis time involved.

The GPC retention mechanism may involve adsorption, partition and size exclusion mechanisms. The predominance of one mechanism over the others is largely determined by the choice of the mobile phase and the pore size of the packing. In the case of GPC packings with large pore size (1000-2000 daltons) size exclusion and adsorption mechanisms prevail (Bio-Beads SX-3 using cyclohexane, dichloromethane-hexane, dichloromethane-cyclohexane, toluene-ethylacetate and ethylacetate-cyclohexane) (Ericksson *et al.*, 1986). On the other hand, when smaller pore sizes (400 daltons) are used in combination with highly polar solvents, (THF, DMF) size exclusion predominates (Lee *et al.*, 1981). While using the first approach, a chemical class fractionation could be obtained, however, if smaller pore sizes are used it should be combined with another fractionation technique (i.e. adsorption chromatography) to achieve this selectivity. It has yet to be demonstrated that using GPC as a single clean-up step produces a completely clean extract for GC-ECD determination. Nevertheless, taking into account the increasing availability of high-resolution low molecular weight exclusion packings, they could definitively integrate fractionation and clean-up in a single step.

Low resolution packing (Sephadex LH and Bio-Beads SX, 200-400 mesh size) are the most widely used because they are inexpensive and afford relatively high sample loading (500 mg in 10 mm i.d. columns). The implementation of low resolution GPC requires a solvent delivery system and a UV detector and may be useful. For method development, it is advisable to inject a broad range of standard compounds covering the whole range of molecular weights of the analytes to be determined in order to determine the cut-off points to fractionate real samples. Reported recoveries of PCBs and PAHs range from 60 to 80 % for the concentration level (ng) injected. (Fernandez and Bayona, 1992).

4.6.2.3. Alumina and HPLC (silica column)

The first step in this clean-up procedure is an adsorption step using an alumina column to remove most of the lipid material. Prepare an alumina column (4 x 0.5 cm i.d., made from a Pasteur pipette). Apply the concentrated extract to the top of the column and elute with 10 ml hexane. Concentrate the eluate to about 200 µl. It is followed by a second step to more completely remove interfering compounds and at the same time to separate the compounds of interest into different fractions, containing aliphatics, PCBs, PAHs, pesticides and toxaphene. Between 20 and 200 µl of the extract (after alumina clean-up) are eluted on a stainless steel column (200 x 4 mm i.d.), packed with Nucleosil 100-5 with n-pentane, 20 % dichloromethane in n-pentane and finally dichloromethane. The eluate is collected in fractions containing 1) n-hydrocarbons, 2) PCBs, 3) PAHs and toxaphene, 4) pesticides and toxaphene and 5) acids, etc. (polar compounds). The size of the fractions has to be determined with standard solutions containing the compounds of interest, collecting the eluate in 0.5 ml fractions. Each fraction is then analysed by GC-ECD. Full details have been given in the literature (Petrick *et al.*, 1988 and IOC, 1993).

4.6.2.4. High pressure chromatography

High pressure liquid chromatography (HPLC) columns packed with microparticles are available and have the advantages of high reproducibility, low consumption of solvents, high efficiency and high sample loading capacity.

This method can be used to separate fractions containing aliphatic hydrocarbons, PCBs and aromatic hydrocarbons from interfering compounds. These fractions can then be analysed separately for their constituents by GC-FID and/or GC-ECD.

HPLC methods have been developed using synthetic solutions of n-alkanes, PAHs, pesticides, PCBs and toxaphene and have been applied to samples in which interfering substances were present in such high concentrations as to render the analysis of HC and PCBs extremely difficult without this clean-up procedure (e.g. sediments and biological tissues with OCs in the ng/g range). The samples are eluted with n-hexane, subjected to clean-up over alumina, concentrated down to 20-200 µl and treated by HPLC. With the use of n-hexane, n-pentane and 10 %, 20 % and 50 % dichloromethane in n-hexane, respectively, the following five fractions are obtained : 1) n-hydrocarbons and alkenes, 2) PCBs and alkylbenzenes, 3) PAHs and toxaphene, 4) pesticides, 5) acids, etc.(polar compounds). (Petrick *et al.* 1988).

5. BIOTA

5.1. Sampling

Organisms accumulate many contaminants from their environment (i.e., from sea water, suspended particulate matter, sediment and food). Field and laboratory studies have shown that contaminant concentrations in some marine plants and animals reflect concentrations in their environment. Scientists use this process (termed bio-accumulation) to assess marine contamination resulting from human activity (e.g., pipeline discharges, dumping from ships).

There are problems with using biota as bio-accumulators (bio-indicators). For example, tissues from individuals of a species exposed to the same contaminant concentration may contain different levels of contamination after the same exposure time. These deviations reflect individual differences in factors such as age, sex, size, and physiological and nutritional states. Also, various species show different contaminant concentrations following identical exposure; differences in elimination rates may partially account for this. These factors must be considered when planning a monitoring programme in order to control their effects on the precision of the analysis (by reducing the variances). Variance reduction is necessary in order to detect smaller differences in mean contaminant concentrations observed in monitoring programmes.

For proper sampling and sample preparation, refer to Reference Method No 6 "Guidelines for monitoring chemical contaminants in the sea using marine organisms" and Reference Method No 12 Rev.2 "Sampling of selected marine organisms and sample preparation for the analysis of chlorinated hydrocarbons".

5.2. Cleaning of extraction thimbles

As for extraction of sediment samples, thimbles should be extracted first with the same solvent used for the extraction of the sample. As the extraction of biota sample is achieved with hexane, a pre-extraction of these thimbles is made with 250 ml of hexane for 8 hours in the Soxhlet apparatus, cycling the solvent through at a rate of 4 to 5 cycles per hour. Add into the solvent a few carborundum boiling chips to get a regular ebullition.

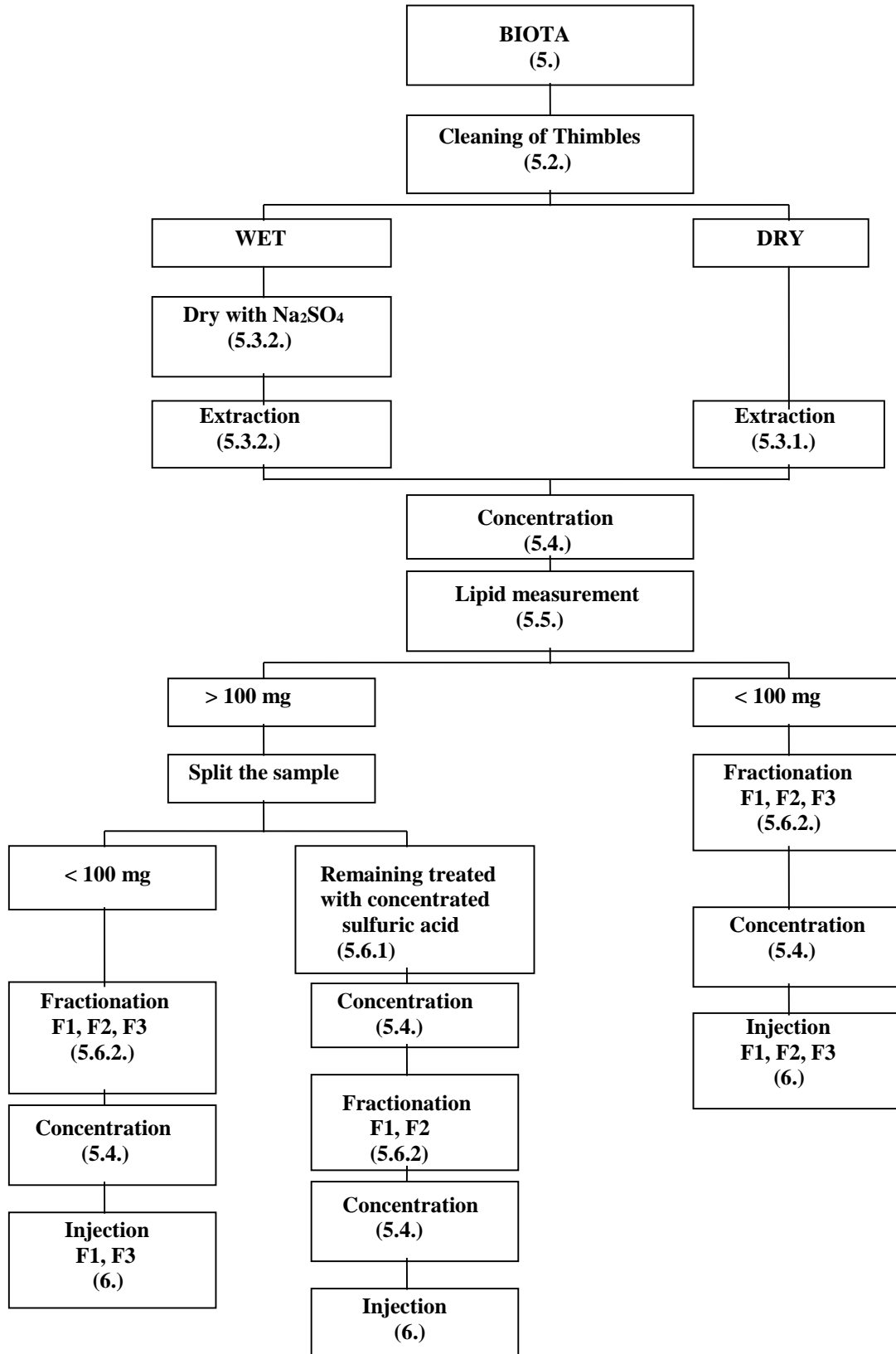

Figure 3: Diagram of the extraction procedure for biota samples.

5.3. Extraction of tissues

5.3.1. Extraction procedure for freeze-dried samples.

Take a 50 to 100 g fresh weight sub-sample from the sample. Weigh this sub-sample and freeze-dry it. When the sub-sample appears to be dry, re-weigh it and freeze-dry it for a further 24 hours and then re-weigh it. If the difference between the two dry weights is greater than 5%, continue the freeze-drying process. Special care must be taken to ensure that the freeze-drier is clean and does not contaminate the samples. The freeze drying procedure should be tested by drying 100 g Na₂SO₄ as a blank and extracting this as a sample. Pulverise the freeze-dried sub-sample carefully using a cleaned pestle and mortar. Accurately weigh about 5 to 10 g of this pulverised material, note the exact weight to be extracted, and place it into a pre-cleaned extraction thimble in a Soxhlet apparatus. The size of the sub-sample should be adjusted so that about 100 mg of extractable organic matter ("lipid") will be obtained. Smaller sub-samples should be used if residue concentrations are expected to be high. Add a known amount of internal standard to the sub-sample in the thimble before Soxhlet extraction. It is important to spike the sample at levels that are near to that of the analyte concentrations in the samples. If, in the end, the analyte and the internal standard concentrations do not fall within the established calibration range of the GC-ECD, the analysis must be repeated. Consequently, it may be advisable to perform range-finding analysis for samples of unknown character beforehand. Candidate internal standards are the same as for sediment samples (see 5.3.). Add about 200 ml of hexane or petroleum ether to the extraction flask with a few carborundum boiling chips, and extract the sample for 8 hours cycling the solvent through at a rate of 4 to 5 cycles per hour. Extract an empty thimble as a procedural blank, making sure to spike it with internal standards in the same fashion as the sample. If unacceptable procedural blanks are found, the source of contamination must be identified and eliminated rather than subtracting high blank values from the analytical results.

5.3.2. Extraction procedure without freeze-drying

Select a 25 to 100 g fresh weight sub-sample and place in a blender. Add anhydrous sodium sulphate to the sample, manually homogenise and determine whether the sample is adequately dried. If not, more sodium sulphate should be added until a dry mixture is obtained. Normally, 3 times by the sample weight used should be enough. Once this has been achieved, blend the mixture at high speed for 1 or 2 minutes until the mixture is well homogenised and the sample appears to be dry. Transfer the mixture to a pre-cleaned extraction thimble, add internal standards as described above and extract the dehydrated tissue with about 200 ml hexane or petroleum ether for 8 hours in a Soxhlet apparatus, cycling 4 to 5 times per hour. Extract the same amount of sodium sulphate as the procedural blank, making sure to add internal standards in the same fashion as the sample.

5.4. Concentration of the extract

Refer to section (4.4.)

5.5. Extractable Organic Matter (EOM)

Refer to section (4.5.)

5.6. Clean-up procedure and fractionation

5.6.1. Removal of lipids by concentrated sulphuric acid

If the lipid content of the extracts is higher than 100-150 mg, a preliminary step for the removal of the lipids is necessary before further sample purification. This can be carried out by using concentrated sulphuric acid. Treatment with sulphuric acid is used when chlorinated hydrocarbons are to be determined. However, sulphuric acid will destroy dieldrin and endrin so that an aliquot of the untreated extract must be set aside for the determination of these compounds.

CAUTION: During all this procedure it is very important to wear safety glasses.

Take an aliquot of the concentrated extract, containing about 200 mg of “lipids”, transfer into a separatory funnel and add to this extract enough hexane in order to dilute the sample (40 to 50 ml should be enough), this will allow recovery of the hexane after acid treatment, because if the sample is too concentrated, the destroyed “lipids” will become almost solid and it will be difficult then to recover the hexane from this solid mass. Add 5 ml concentrated sulphuric acid to the extract and tightly fit the glass stopper and shake vigorously. Invert the funnel and carefully vent the vapours out through the stopcock. Repeat this procedure for several minutes. Place the separatory funnel in a rack and allow the phases to separate. Four or five samples and a spiked blank are convenient to process at one time. The extract should be colourless. Recover the hexane phase into a glass beaker. Dry with sodium sulphate and transfer the hexane into a Kuderna-Danish concentrator. Reduce the volume of the extract by evaporating the solvent with a gentle stream of pure nitrogen to about 1 ml.

5.6.2. Fractionation

Refer to section (4.6.2.)

6. CAPILLARY GAS CHROMATOGRAPHIC DETERMINATIONS

6.1. Gas chromatographic conditions

- Gas chromatograph with a split/splitless injection system, separate regulation system for inlet and column pressures and temperatures; multi-ramp temperature programming facilities (preferably microprocessor controlled), electron capture detector interfaced with the column with electronic control unit and pulsed mode facilities. An integrator with a short response time (0.25 s) is essential.
- Narrow-bore (0.22 mm internal diameter), 25 m long, fused silica open tubular column, coated with SE-54 (0.17 µm film thickness, preferably chemically bonded) with sufficient resolution to separate the relevant peaks in the standards provided for PCB analysis.
- Carrier gas should be high purity H₂. If this is not available or if the GC is not equipped with a special security system for hydrogen leak, He may be used. Gas purification traps should be used with molecular sieves to remove oxygen, moisture and other interfering substances.
- High purity nitrogen gas (99.995 %) as ECD make-up gas can be used (Argon/methane high purity gas is another option).

Conditions:

- H₂ or He carrier gas at inlet pressure of 0.5 to 1 Kg/cm² to achieve a flow rate of 1 to 2 ml/min.
- Make-up gas N₂ or Ar/CH₄ at the flow rate recommended by the manufacturer (between 30 and 60 ml/min.).
- ECD temperature: 300°C

6.2. Column preparation

Fused silica columns are the columns of choice for their inertness and durability (they are extremely flexible). They are made of material that is stable up to 360 °C. The 5 % phenyl methyl silicone gum (SE-54) liquid phase, is present as a thin, (0.17 µm), uniform film which can tolerate temperatures up to 300 °C. SE-54 is relatively resistant to the detrimental effects of solvents, oxygen and water, at least at low temperatures. These columns are even more resistant and durable if the liquid phase is chemically bonded to the support by the manufacturer.

For GC/MS work, it is advised to restrict the film thickness to 0.17 µm because with thicker films some of the phase could be released, resulting in an increase of the noise signal in the GC/MS.

The flexible fused silica columns can be conveniently connected directly to the inlet and outlet systems without the transfer lines used in conventional glass capillary chromatography which often lead to increased dead volume. Low bleed graphite or vespel ferrules provide a good seal.

The presence of extraneous peaks and elevated baseline drift will result in poor detector performance. This can be caused by components which elute from the column, such as residual solvents and low molecular weight liquid phase fractions on new columns and build-up of later eluting compounds on old columns. Conditioning is a necessary step to remove these contaminants. New columns are connected to the inlet (while left unconnected to the detector). Columns are flushed with carrier gas at low temperature for 15 min. to remove the oxygen, then heated at 70-100 °C for 30 min. and finally at 170 °C overnight. The column can be then connected to the detector. Old columns can be heated directly to elevated temperatures overnight. The final temperature is selected as a compromise between time required to develop a stable baseline and expected column life. Thus, it may be necessary for older columns to be heated to the maximum temperature of the liquid phase resulting in shorter column life. The temperature of the ECD, when connected to the column, should always be at least 50 °C higher than the column, in order to avoid condensation of the material onto the detector foil. It is essential that carrier gas flows through the column at all times when at elevated temperatures. Even short exposure of the column to higher temperature without sufficient flow will ruin the column.

CAUTION: if H₂ is used as a carrier gas, position the column end outside of the oven to avoid explosion risk.

6.3. Column test

When the column has been connected to the detector, the carrier gas flow is set to 30 ml per minute for a column with 4 mm internal diameter. The column performance is then measured according to the criteria of the “number of theoretical plates” for a specific compound and can be achieved according to the following procedure.

- Set injector and detector temperatures at 200 and 300°C respectively and the column oven temperature at 180 °C.
- Inject pp’ DDT standard and measure the retention time (Tr). Adjust the column temperature to get a pp’ DDT retention time relative to Aldrin of 3.03.
- Measure the width of the pp’ DDT peak at its half height ($b_{1/2}$), in minutes and the retention time (Tr) also in minutes.
- Calculate the number of theoretical plates using the formula:

$$N = 5.54 \left(\frac{Tr}{b_{1/2}} \right)^2$$

- A parameter which is independent of the column length is the height equivalent to a theoretical plate (HETP):

$$HETP = \frac{L}{N}$$

Where L is the column length. Adjust the flow rate of the carrier gas to obtain optimum performance. The HETP should be as low as possible (i.e. the number of theoretical plates should be as great as possible).

The column remains in optimum condition as long as the liquid phase exists as a thin, uniform film. The quality of the film at the inlet side may be degraded as a result of repeated splitless

injections. Decreased column quality may be remedied by the removal of the end of the column (10 to 20 cm) at the inlet side. Chemically bonded liquid phases require less maintenance.

6.4. Electron capture detector

High-energy electrons, emitted by a radioactive source within the detector (e.g. a ^{63}Ni foil), are subject to repeated collisions with carrier gas molecules, producing secondary electrons. These electrons, upon returning to their normal state, can be captured by sample molecules, eluting from a GC column. The resulting reduction in cell current is the operating principle of an electron capture detector. The detector current produced is actually a non-linear function of the concentration of electron-capturing material. However, the useful linear range of an ECD may be greatly improved if the instrument is operated at a constant current, but in a pulsed mode, i.e. with short voltage pulses being applied to the cell electrodes. The current in the cell is kept constant by varying the frequency of the pulses.

Contamination of the detector (and thus lower sensitivity) may result from high-boiling organic compounds eluting from the column. Periodic heating to 350°C may overcome this problem. The ^{63}Ni ECD can be used at 320°C under normal operational conditions, in order to limit such contamination.

The optimum flow for an ECD (30 to 60 ml/min.) is much higher than carrier gas flow through the column of one or two ml/min. Thus an additional detector purge flow is necessary (N_2 or Ar/CH_4). Once leaving the outlet of the column, the compounds have to be taken up into an increased gas flow in order to avoid extra-volume band broadening within the detector. Thus, the detector purge flow also serves as the sweep gas.

6.5. Quantification

The most widely used information for identification of a peak is its retention time, or its relative retention time (i.e., the adjusted retention time relative to that of a selected reference compound). Retention behaviour is temperature dependent and comparison of retention times obtained at two or more temperatures may aid in determining a peak's identity. However, retention times are not specific and despite the high resolution offered by capillary columns, two compounds of interest in the same sample may have identical retention times.

One way of using retention indexes could be to inject di-n-alkyl-phthalates such as a mixture containing di-n-methyl-phthalate, di-n-ethyl-phthalate, di-n-propyl-phthalate, di-n-butyl-phthalate, di-n-hexyl-phthalate and di-n-heptyl-phthalate, which will cover the elution range from 70°C to 260°C. An arbitrary index of 100 is given to the di-n-methyl phthalate, 200 to the di-n-ethyl phthalate, and so on up to 700 to the di-n-heptyl phthalate; it is possible to identify all chlorinated pesticides by a proper retention index. This will be used also for unknown compounds which can be found easily on the GC/MS using the same index and so, identified. (Villeneuve J.P. 1986).

PCBs represent a complex mixture of compounds that cannot all be resolved on a packed column. Also there is no simple standard available for their quantification. Each peak in a sample chromatogram might correspond to a mixture of more than one individual compound. These difficulties have led to the recommendation of various quantification procedures. The usual method to quantify PCBs is to compare packed-column chromatograms of commercially available industrial formulations (Aroclors, Clophens, Phenoclor) with the sample chromatogram. Most commonly, it is possible to match one single formulation, such as Aroclor 1254 or Aroclor 1260 with the sample chromatogram. An industrial formulation (or mixture of formulations) should be chosen to be as close a match as possible and in the case of sample extracts from sediment or organisms, Aroclor 1254 and Aroclor 1260 are most frequently chosen.

For the second fraction obtained on Florisil separation, it is possible to quantify DDTs after comparison with the retention times of peaks in the sample chromatogram to those in the corresponding standard, the peak heights (or peak areas) are measured and related to the peak height (or peak area) in the standard according to the formula:

$$[\text{Concentration}] = \frac{h \times C \times V \times 1000}{h' \times V(\text{inj}) \times M \times R} \text{ ng/g (or pg/g)}$$

Where:

- V = total extract volume (ml)
- M = weight of sample extracted (g)
- H = peak height of the compound in the sample
- h' = peak height of the compound in the standard
- C = quantity of standard injected (ng or pg)
- V (inj) = volume of sample injected (µl)
- R = Recovery of the sample

7. COMPUTERIZED GAS CHROMATOGRAPHY/MASS SPECTROMETRY (GC/MS)

7.1. Operating conditions

The chemical ionisation source of a mass spectrometer can be used to produce negative ions by electron capture reactions (CI-NI-MS) using a non-reactive enhancement gas such as methane or argon. CI-NI has the advantage of being highly selective, permitting the detection of specific compounds in complex matrices. Under CI-NI conditions, methane (99.99 %) is used as the reagent gas. Samples are introduced through a SE-54, 30 m x 0.25 mm i.d., fused silica column. The film thickness used is 0.17 µm in order to minimise the bleeding of the phase into the system. Helium is used as carrier gas with an inlet pressure of 13 psi, which gives a carrier flow of 1.5 ml/min. or a gas velocity of 44 cm/sec.

The temperature of the injection port is held at 250°C.

The temperature of the source is set at 240°C, the quadrupole at 100°C and the interface at 285°C.

Injections of 1-3 µl are made in the splitless mode.

The temperature programme of the oven starts at 70°C, for 2 minutes, then it is increased at 3°C/min. to 260°C and kept under isothermal conditions for 40 minutes.

File : C:\HPCHEM\1\DATA\AR1254.D
Operator : jpv
Acquired : 12 Jul 95 8:02 am using AcqMethod OC
Instrument : 5989B
Sample Name: standard ar1254
Misc Info :
Vial Number: 1

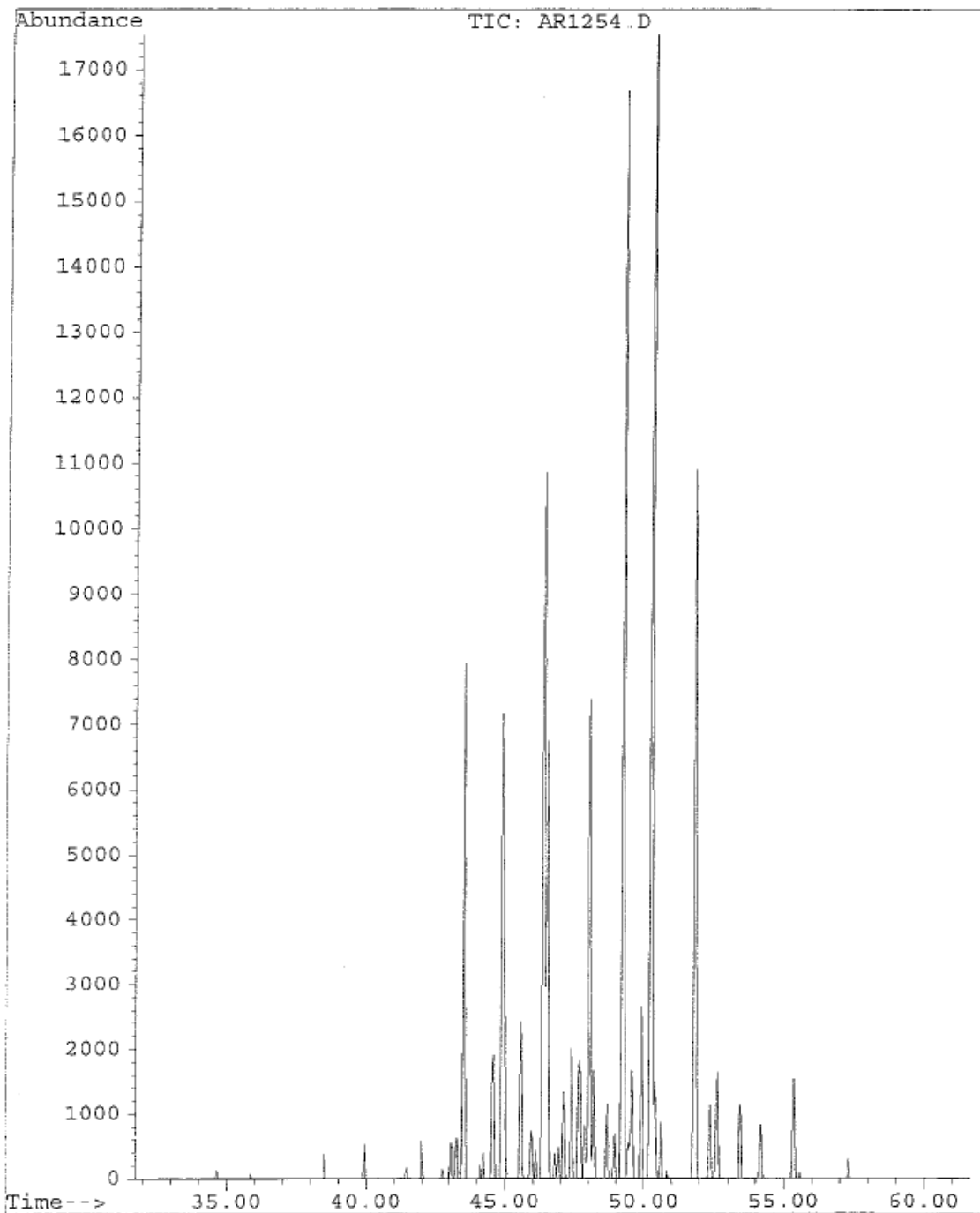

Figure 4: TIC of Aroclor 1254

File : C:\HPCHEM\1\DATA\AR1254.D
Operator : jpv
Acquired : 12 Jul 95 8:02 am using AcqMethod OC
Instrument : 5989B
Sample Name: standard ar1254
Misc Info :
Vial Number: 1

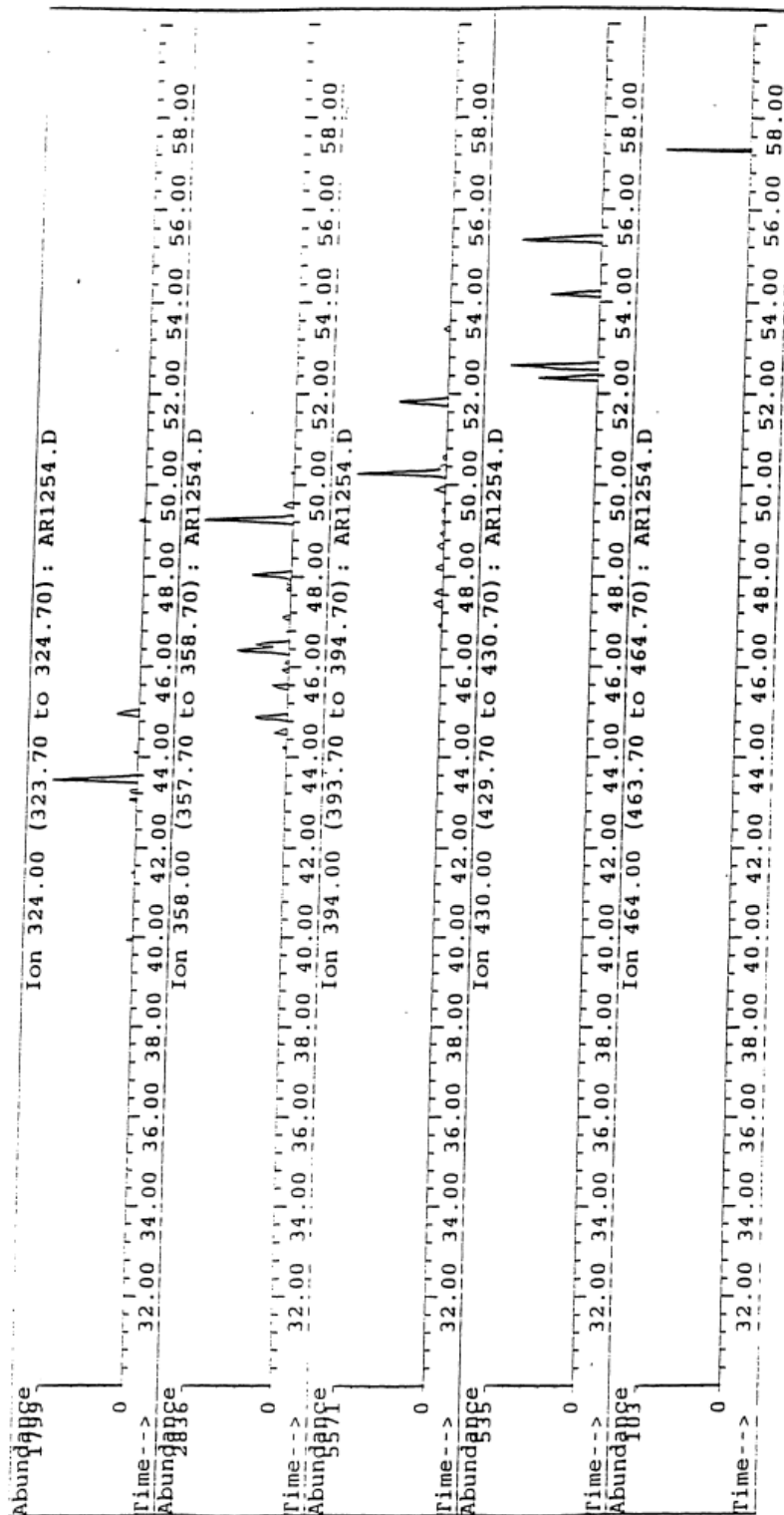

Figure 5: RIC of Aroclor 1254 main compounds

File : C:\HPCHEM\1\DATA\AR1260.D
Operator : jpv
Acquired : 12 Jul 95 9:42 am using AcqMethod OC
Instrument : 5989B
Sample Name: standard ar1260
Misc Info :
Vial Number: 1

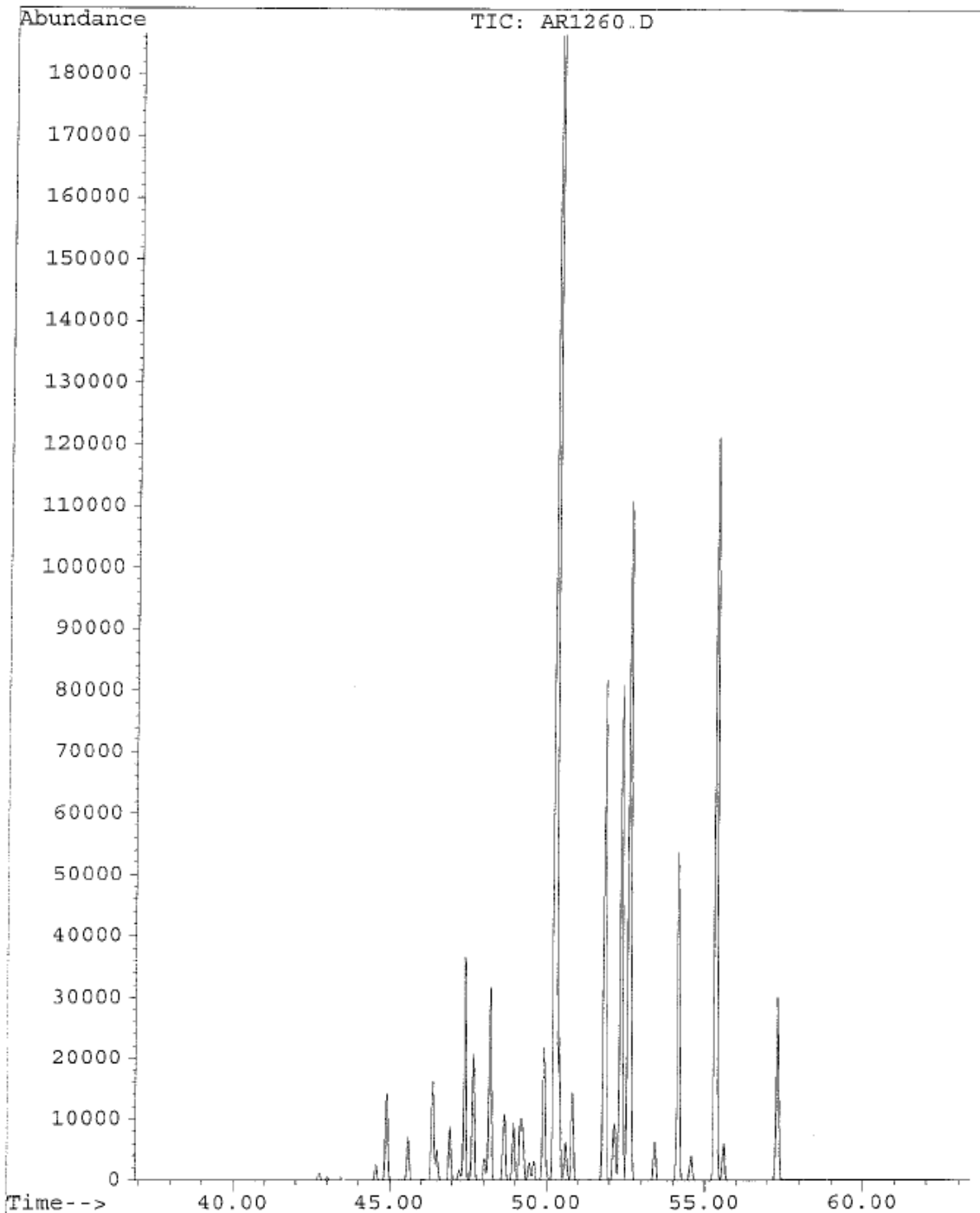

Figure 6: TIC of Aroclor 1260

File : C:\HPCHEM\1\DATA\AR1260.D
 Operator : jpv
 Acquired : 12 Jul 95 9:42 am using AcqMethod OC
 Instrument : 5989B
 Sample Name: standard ar1260
 Misc Info :
 Vial Number: 1

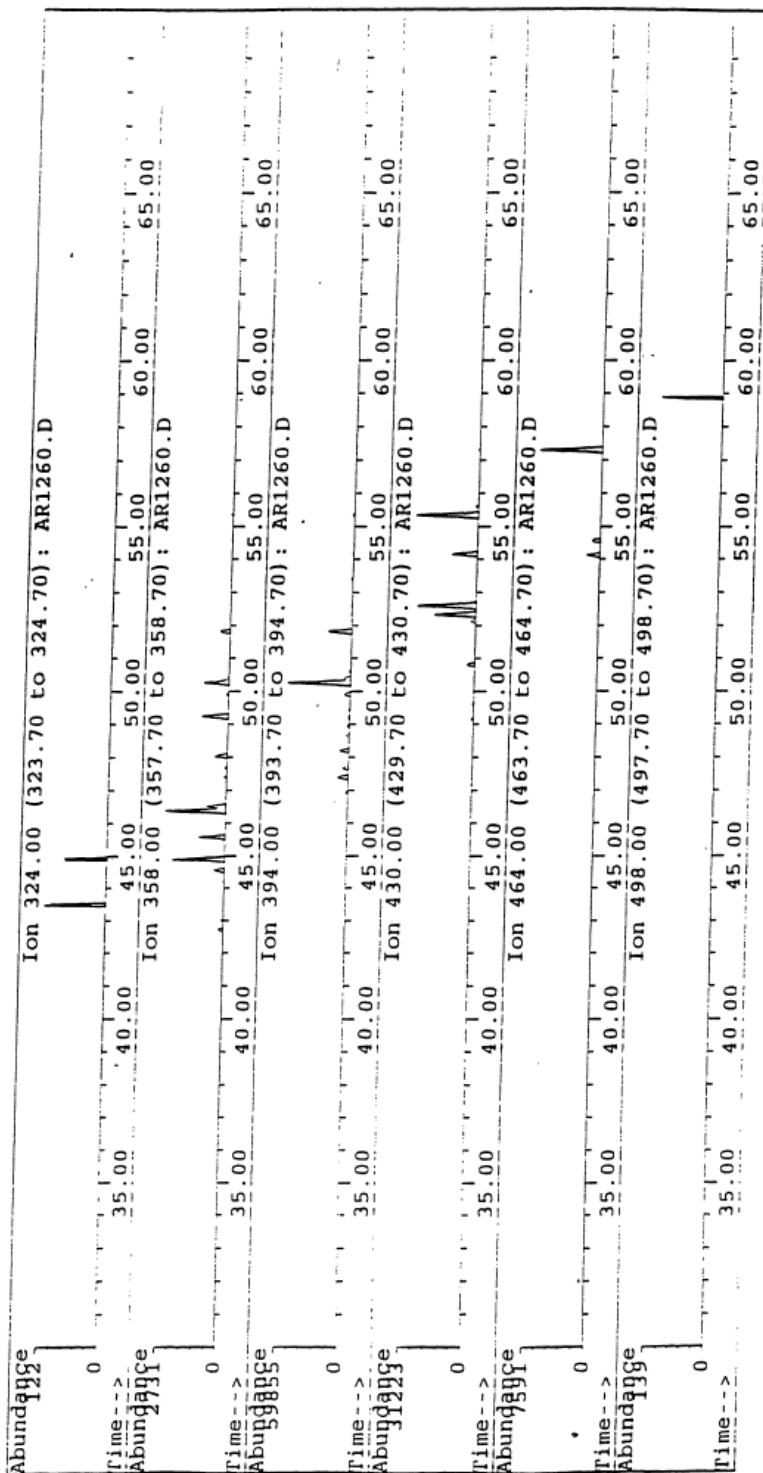

Figure 7: RIC of Aroclor 1260 main compounds

7.2. Example of a selected ion monitoring programme useful for quantitative analysis of chlorinated compounds.

Compounds	Fraction N° on Florisil	Retention Time (min.)	Target Ion (daltons)
HCB	1	37-38	284
Heptachlor	1	44-45	266
Aldrin	1	46-48	237
op DDE	1	51-53	246
Transnonachlor	1	52-54	444
pp' DDE	1	53-55	281
PCBs			
3 Cl	1		258
4 Cl	1		292
5 Cl	1	40-55	324
6 Cl	1	40-55	358
7 Cl	1	45-55	394
8 Cl	1	45-60	430
9 Cl	1	50-60	464
10 Cl	1	58-60	498
α HCH	2	37-39	255
β HCH	2	39-41	255
γ HCH (Lindane)	2	39-41	255
δ HCH	2	41-43	255
γ Chlordane	2	51-53	410
α Chlordane	2	52-54	266
op DDD	2	54-56	248
pp' DDD	2	56-58	248
op DDT	2	56-58	246
pp' DDT	2	58-60	283
Heptachlor epoxide	3	49-51	318
α Endosulfan	3	52-54	406
Dieldrin	3	53-55	346
Endrin	3	55-57	346
β Endosulfan	3	55-57	406
Endosulfan sulfate	3	58-60	386

8. NOTES ON WATER ANALYSIS

The levels of lipophilic compounds in tissues of aquatic organisms and organic fractions of sediments are determined to a large extent by the levels of these compounds in the surrounding water (marine mammals are an obvious exception). Data for CBs and hydrocarbons in sea water is therefore extremely useful for an understanding of the levels in organisms. However, the levels in sea water are extremely low and consequently, their determination needs considerable experience. Large volumes of water are required and extreme care has to be taken in order to avoid contamination during sampling, extraction and clean-up of the samples. Details are described in Manual and guide No 27 of IOC, 1993 and Villeneuve J.P. (1986).

9. ALTERNATIVE PROCEDURES

9.1. Combining sample preparation and extraction for chlorinated and petroleum hydrocarbons in sediment samples.

In the event that analyses for petroleum hydrocarbons and chlorinated compounds (and/or sterols) are of interest, the following extraction procedure can be used. To the freeze-dried sample introduce internal standards for each compound class. The following are suggested: 1) aliphatic hydrocarbons: - n-C₁₄ d₃₀, n-C₁₉ d₄₀, n-C₃₂ d₆₆, 2) polycyclic aromatic hydrocarbons: Naphthalene d₈,

Hexamethylbenzene, Cadalene (deuterated PAHs are also useful), 3) organochlorine compounds: PCB congeners 29, 30, 121 or 198, ϵ HCH and Endosulfan Id₄, 4) sterols: 5 α (H)-androstan-3 β -ol. These standards are used for quantifying the recovery of the total procedure. Samples are Soxhlet extracted for 8 hours with 250 ml of a mixture hexane / dichloromethane (50:50), cycling the solvent through at a rate of 4 to 5 cycles per hour. The solvent extract is concentrated by rotary evaporation down to 15 ml and transferred to a Kuderna-Danish tube. It is then further concentrated down to 5-6 ml under nitrogen gas. Following removal of sulphur and water, the extract is separated into aliquots: 1/3 for petroleum hydrocarbons and sterols and 2/3 for chlorinated hydrocarbons.

Note: Mercury method should be used only if chlorinated pesticides and PCBs are analysed. If the combined method is used for petroleum and chlorinated hydrocarbons, then the copper method should be used instead of mercury that will destroy some of the PAHs.

9.2. Supercritical fluid extraction (SFE) of marine samples

Sample preparation is probably the most time-consuming and labor-intensive analytical task performed in a laboratory. Studies shows that 60 % of the overall sample analysis time is spent in sample preparation which is the main source of error and of contamination. In addition, the amount of hazardous chemicals used for sample preparation is a continuous source of concern. Due to safe handling and disposal requirements, the reduction of their use is a priority for laboratories worldwide.

Supercritical fluids are gases (i.e. N₂O and CO₂) at room temperature and pressures above the critical point. The SFE technique allows an efficient extraction of a variety of contaminants with considerable reduction in the analysis cost, sample amount and allows the extraction of the thermal sensitive substances, reducing the amount of environmentally hazardous solvents.

A small change in the pressure of a supercritical fluid results in a big change in its density and the solvent strength of the fluid changes with changing density. As a result, one supercritical fluid easily performs the work of many solvents. If this is not enough, it is possible to add a modifier, such as methanol (a few per cent) to increase the solvating range of the fluid. Therefore, SFE should speed up the sample preparation process, minimising the wastes associated with the analysis.

Until now, the main fields of analytical applications of SFE are related to environmental studies and to the food-processing industry (Hawthorne, 1990, Bayona, 1993). A method using carbon dioxide (80°C-340 atm) for the extraction of total petroleum hydrocarbons has been approved as an EPA standard method. The extraction efficiency of modified CO₂ for the recovery of 41 organochlorine and 47 organophosphorus pesticides spiked on sand at different pressures and temperatures were higher than 80%. Furthermore, by increasing the extraction temperature up to 200°C, PCBs and PAHs can be extracted from naturally occurring samples with neat CO₂. Nam *et al.* (1991), have developed a method for rapid determination of polychlorinated organics in complex matrices. The method is based on direct coupling of supercritical fluid extraction with tandem supercritical fluid chromatography and gas chromatography. The on-line system permits simultaneous extraction and analysis with high reproducibility and accuracy.

**Selection guide for CO₂ extraction of common pollutants
 (from Hewlett-Packard)**

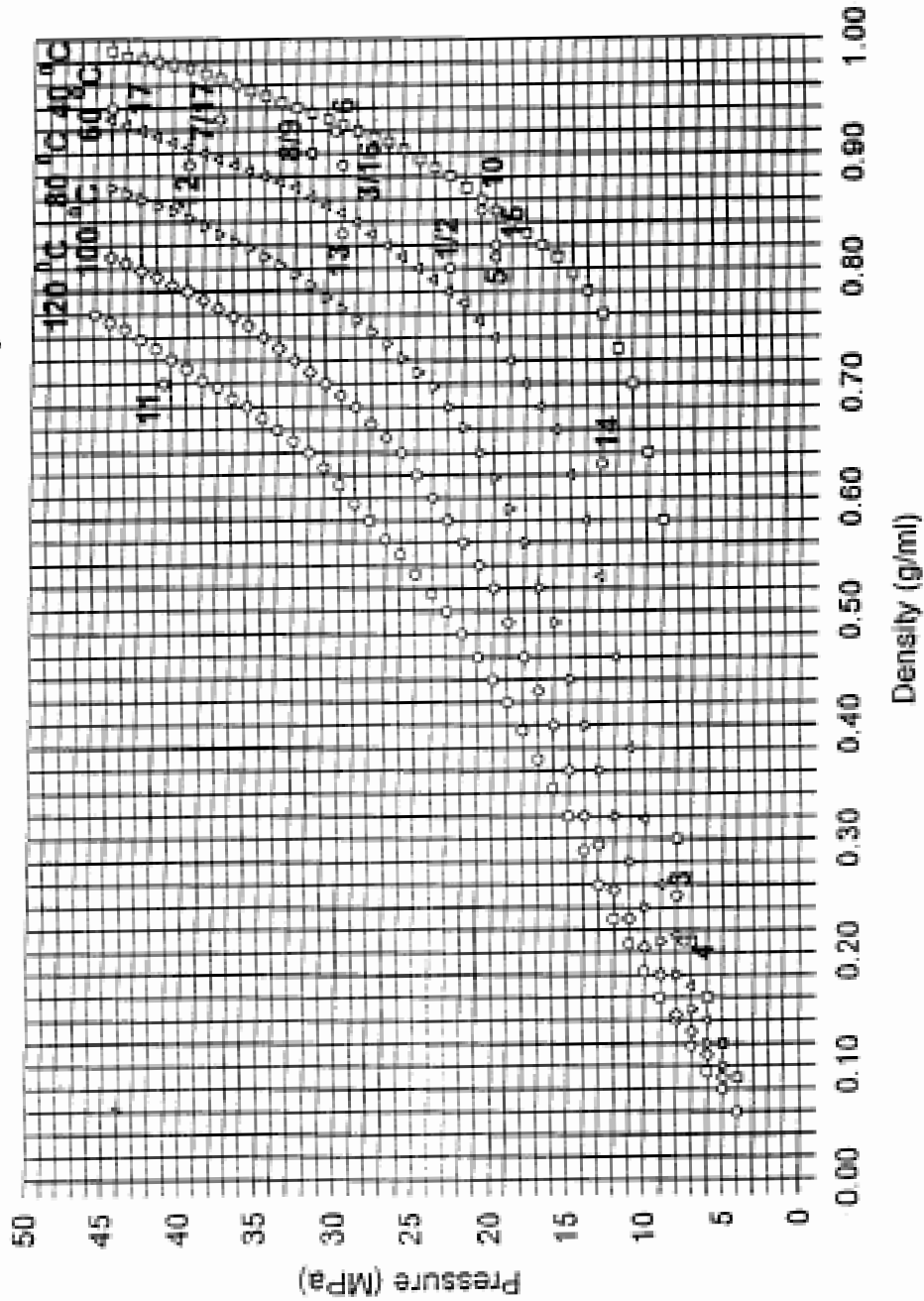

Figure 8: Guide for CO₂ extractions

9.3. Microwave assisted extraction for marine samples

9.3.1 Sediment

Another alternative method for the extraction of chlorinated hydrocarbons in sediment samples (or combined extraction for chlorinated hydrocarbons and petroleum hydrocarbons) is the use of the Microwave oven instead of the Soxhlet extractor. The main advantage of the microwave oven is the fact that, for one sample, only 40 ml of solvent mixture are used instead of 250 ml for clean-up of extraction thimbles and 250 ml for the extraction itself.

10 to 15 grams of freeze-dried sediment sample, ground and sieved at 250 µm, are put in the glass tube of the reactor. Appropriate internal standards (for OCs and/or PHs, see 10.1.) are added to the sample for recovery and samples are extracted with 40 ml of a mixture of hexane / dichloromethane (50:50).

Extraction is realised within the following cycle:

- Power of the microwaves: 1200 watts
- Temperature increase to 115 °C in 10 minutes.
- Extraction maintained at 115 °C for 30 minutes
- Cooling to ambient temperature within one hour.

The carousel containing 14 reactors, 12 samples could be extracted together with one blank and one Reference Material within 1 and half hour and with 10 times less solvent mixture than the standard Soxhlet extraction.

After cooling down to room temperature the solvent mixture is recovered in a 100 ml glass flask. The sediment is poured in a glass funnel containing a plug made of glass wool. The extracted sediment is washed with 10 - 20 ml of hexane. The extract follows then the procedure of clean-up and fractionation.

9.3.2 Biota

3 to 8 grams of freeze-dried biota sample is accurately weighted, the weight to be extracted is noted, and it is placed into the pre-cleaned glass tube of the reactor. A known amount of internal standard is added to the sub-sample in the tube before extraction. Candidate internal standards are the same than for sediment samples refers to section (5.3.1.)

Extraction is realized with 30 ml of a mixture hexane / acetone (90:10) within the following cycle:

- Power of the microwaves: 1200 watts
- Temperature increase to 115 °C in 10 minutes.
- Extraction maintained at 115 °C for 20 minutes
- Cooling to ambient temperature within one hour.

The carousel containing 14 reactors, 12 samples could be extracted with one blank and one Reference Material within 1 and half hour and with 10 times less solvent mixture than the standard Soxhlet extraction.

After cooling down to room temperature the solvent mixture is recovered in a 100 ml glass flask. The powder of biota is poured in a glass funnel containing a plug made of glass wool. The extracted biota is washed with 10 - 20 ml of hexane. The extract is then concentrated with rotary evaporator and ready for E.O.M, clean-up and fractionation procedure.

10. DATA INTERPRETATION

10.1. DDT

The residence time of total DDT in the environment is relatively short ($t_{1/2} = 3-5$ years), so, at least 75-80 % of the current total DDT should be in the form of DDE or DDD if it was introduced into the environment before the 1975 ban. Values of Henry's law constant indicate that these compounds can reach the troposphere as vapour. These vapours are little adsorbed by airborne particulate matter and represent the major component in atmospheric chlorinated hydrocarbon levels. Vapour movements of these pollutants suggest that restrictions and regulations operating in the more technically advanced countries could only be partially effective on a worldwide basis.

The presence of the *op* DDT together with anomalous *pp'* DDT values in environmental samples indicates a recent treatment with this insecticide.

10.2. PCBs congeners

Among the 209 possible PCB congeners, seven of them: 28, 52, 101, 118, 138, 153 and 180, were selected as the most relevant because of their distribution in the chromatogram and in the chlorination range.

Recently, attention has been paid to congeners having 2 para-chlorines and at least 1 meta-chlorine. These congeners are called "coplanar" PCBs. Among the 209 congeners, 20 members attain coplanarity due to non-ortho chlorine substitution in the biphenyl ring. Three of these show the same range of toxicity as the 2,3,7,8 tetrachlorodibenzo-p-dioxin and the 2,3,7,8 tetrachlorodibenzofuran, these are the IUPAC N^o: 77, 126 and 169. These compounds should be identified and quantified in the environmental samples with high priority. They can be separated using fractionation with carbon chromatography (Tanabe *et al.*, 1986).

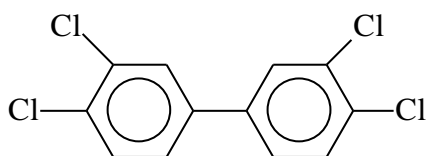

3,3',4,4' tetrachlorobiphenyl
IUPAC N^o: 77

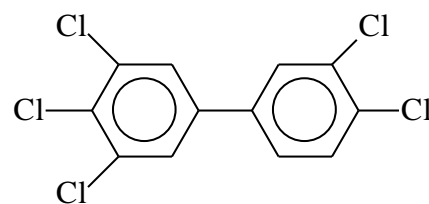

3,3',4,4',5 pentachlorobiphenyl
IUPAC N^o: 126

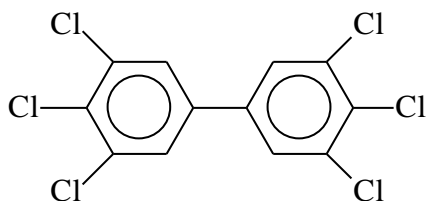

3,3',4,4',5,5' hexachlorobiphenyl
IUPAC N^o: 169

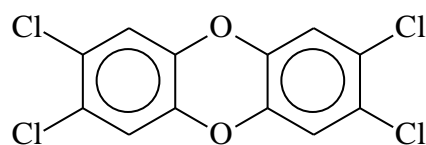

2,3,7,8 tetrachlorodibenzo-p-dioxin

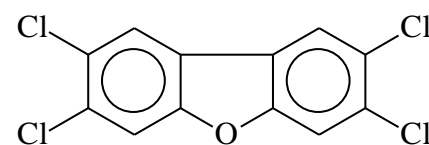

2,3,7,8 tetrachlorodibenzofuran

10.3. Typical profiles of commercial mixtures

Formulations available in different countries are slightly different in their composition (Aroclor in USA, Kanechlor in Japan, Clophen in Germany, Phenoclor in France, Fenclor in Italy or Sovol in Russia). For the same global composition, such as Aroclor 1254, KC-500 or Phenoclor DP-5, the composition of individual congeners differs by 5-10 %. If a sample is collected on the French coast (therefore, contaminated with DP-5), and is quantified with DP-5 and Aroclor 1254, the difference observed in concentration could be in the order of 5-10 %. This shows the importance of choosing one common standard for the quantification of global industrial formulations or the importance of quantifying with individual congeners.

Percent contribution of individual chlorobiphenyls to Clophen A 50 and Aroclor 1254.

PCB N°	Clophen A50	Aroclor 1254	PCB N°	Clophen A50	Aroclor 1254
17	0	0.19	115	0.28	0.3
18	0	0.41	118	10.9	6.39
28	0.05	0.25	119	0.19	0.14
31	0.05	0.22	122	0.19	0.5
33	0.11	0.14	123	0.85	0.81
40	0.28	0.2	126	0.08	0
41	0.83	0.64	128	3.04	2.07
42	0.13	0.23	129	0.83	0.23
44	2.46	2.03	130	0.83	0.63
47	0.18	0.11	131	0.06	0.16
48	0.17	0.14	132	2.57	1.98
49	1.96	1.64	134	0.52	0.49
52	5.53	5.18	135	1.61	1.62
53	0.06	0.09	136	0.91	1.12
56	0.44	0.58	137	0.25	0.25
60	0.34	0.54	138	3.61	3.2
63	0.15	0.05	141	0.98	1.04
64	0.71	0.45	146	0.8	0.83
66	0.5	0.59	149	4.5	2.21
67	0.13	0.09	151	1.22	1.17
70	3.85	3.21	153	4.17	4.26
74	1.35	0.78	156	1.43	1.62
82	1.05	0.95	157	0.31	0
83	0.53	0.45	158	0.98	0.77
84	2.08	1.95	167	0.35	0.21
85	1.85	1.66	170	0.65	0.31
87	4.22	3.78	171	0.5	0.5
90	0.85	0.93	172	0.09	0.05
91	0.92	0.83	173	0.09	0.09
92	1.53	1.58	174	0.37	0.34
95	6	6.02	175	0.11	0.05
96	0.05	0.08	176	0.43	0.32
97	2.8	2.55	177	0.21	0.21
99	4.06	3.6	178	0.19	1.35
100	0.15	0.1	179	0.2	0.21
101	7.72	7.94	180	0.53	0.38
105	1.9	3.83	183	0.21	0.17
107	0.94	0.72	187	0.3	0.32
110	6.27	5.85	190	0.05	0.08
			201	0.6	0.68

11. QUALITY ASSURANCE / QUALITY CONTROL

Guidelines on the QA/QC requirements for analysis of sediments and marine organisms are detailed in Reference Method No 57, "Contaminant monitoring programs using marine organisms: Quality assurance and good laboratory practice". Brief descriptions of issues that must be addressed in the course of understanding the procedures described here are given below.

11.1. Precision

The precision of the method should be established by replicate analysis of samples of the appropriate matrix. Estimate the precision of the entire analytical procedure by extracting five sub-samples from the same sample after homogenisation. Alternatively, perform replicate analysis of an appropriate certified reference material (RM; see below) containing the analytes of interest. The principal advantage of using a RM is that the material permits the simultaneous evaluation of accuracy while offering a well homogenised sample. Precision should be evaluated as a matter of course during the initial implementation procedure just before initiation of sample analysis.

11.2. Accuracy

The accuracy of the methods described here must be confirmed by analysis of a suitable RM (i.e. appropriate matrix, analytes) prior to initiation of sample analysis. Agreement between measured and certified concentrations for any individual analyte should be within 35 % and on average within 25%. It is advisable to introduce RMs on a regular basis (e.g. every 10-20 samples) as a method of checking the procedure. Further description of the preparation of control charts and criteria for data acceptance are discussed in Reference Method N° 57.

11.3. Blanks

Blanks represent an opportunity to evaluate and monitor the potential introduction of contaminants into samples during processing. Contributions to the analyte signal can arise from contaminants in the reagents, those arising from passive contact between the sample and the environment (e.g. the atmosphere) and those introduced during sample handling by hands, implements or glassware. It is essential to establish a consistently low (i.e. with respect to analytes) blank prior to initiating analysis or even the determination of the method detection limit. In addition, it is necessary to perform blank determinations on a regular basis (e.g. every batch of samples).

11.4. Recovery

Recovery reflects the ability of the analyst to fully recover surrogate compounds introduced to the sample matrix or blank at the beginning of the procedure. The primary criteria for selection of compounds to be used for testing recovery are that they: 1) have physical (i.e. chromatographic/partitioning) properties similar to and if necessary spanning those of the analytes of interest, 2) do not suffer from interferences during gas chromatographic analysis, 3) are baseline resolved from the analytes of interest.

Recovery should be tested on all samples and blanks as a routine matter of course. Recoveries below 70% are to be considered unacceptable. Recoveries in excess of 100 % may indicate the presence of interference.

11.5. Archiving and reporting of results

Every sample should have an associated worksheet which follows the samples and the extracts through the various stages of the procedure and upon which the analyst notes all relevant details. An example of such a worksheet is given below. Each laboratory should construct and complete such a worksheet. Relevant chromatograms should be attached to the worksheet. Analyses should be grouped

and composite or summary analysis sheets archived with each group. Final disposal of the data will depend on the reasons for which it was collected but should follow the overall plan model.

All processed samples should be archived at all steps of the procedure:

- deep frozen (in the deep-freezer as it was received).
- freeze-dried (in sealed glass container kept in a dark place).
- extracted (after injection on the GC, sample extracts should be concentrated down to 1 ml and transferred into sealed glass vials, a Pasteur pipette sealed with a butane burner is adequate and cheap).

Sample: IAEA-357 : Marine Sediment

wet wt.

----- =, % water in freeze dried sample determined by drying at 105°C :

dry wt.

.....g freeze-dried wt. extracted with hexane in Soxhlet extractor for 8 hours.

.....pg PCB N°29,pg PCB N°198,pg ϵ HCH and pg Endosulfan Id₄ were added as internal standard.

Theml extract was reduced by rotary evaporator to approximatelyml.

This was treated with sodium sulfate to dry the extract. Then treated with mercury to remove sulphur. This was further reduced toml for lipid determinations. Corrected dry wt. :g.

Lipid determinations:

.....ml total extract;

10 μ l aliquots weighed on micro-balance:mg;mg;mg.

HEOM =mg/g dry weight.

.....mg lipid subjected to column chromatography fractionation on Florisil.

F1:ml hexane

F2:ml hexane/dichloromethane (70:30)

F3:ml dichloromethane

GC determinations:

PCB N°29 :ng recovered in F1 :% Recovery.

PCB N°198 :ng recovered in F1 :% Recovery.

ϵ HCH :ng recovered in F2 :% Recovery.

Endosulfan Id₄:ng recovered in F3 :% Recovery.

Attach tabulation of individual compounds quantified in sample.

Sample worksheet for analysis of chlorinated compounds in marine sediments.

12. REFERENCES

- Bayona, J.M. (1993). The role of supercritical fluid extraction in sample preparation. *Robotics Lab. Autom.* 5, 156-187.
- Eganhouse, R.P. and Kaplan, I.R. (1988). Depositional history of recent sediments from San Pedro shelf, California: Reconstruction using elemental abundance, isotopic composition and molecular markers. *Mar. Chem.*, 24 (2), 163-191.
- Eisenreich, S.J., Capel, P.D., Robbins, J.A. and Bourbonniere, R. (1989). Accumulation and diagenesis of chlorinated hydrocarbons in lacustrine sediments. *Environ. Sci. and Technol.*, 23, 1116-1126.
- Ericksson, M.D. (1986). *Analytical Chemistry of PCBs*, Butterworth, Stonehaus, 149-153.
- Fernandez, P., Porte, C., Barcelo, D., Bayona, J.M. and Albaiges, J. (1988). Selective enrichment procedures for the determination of polychlorinated biphenyls and polycyclic aromatic hydrocarbons in environmental samples by gel permeation chromatography. *J. Chromatogr.* 456, 155-164.
- Fernandez, P. and Bayona, J.M. (1992). Use of off-line gel permeation chromatography - normal phase liquid chromatography for the determination of polycyclic aromatic compounds in environmental samples and standard reference materials (air particulate matter and marine sediment). *J. Chromatogr.*, 625, 141-149.
- Hawthorne, S.B. (1990). Analytical-scale supercritical fluid extraction, *Anal. Chem.*, 62, 633A-642A.
- Hom, W., Risebrough, R.W., Soutar, A. and Young, D.R. (1974). Deposition of DDE and polychlorinated biphenyls in dated sediments of the Santa Barbara basin. *Science*, 184, 1197-1199.
- Langenfeld, J.J., Hawthorne, S.B., Miller, D.J. and Pawliszyn, J. (1993). Effects of temperature and pressure on supercritical fluid extraction efficiencies of polycyclic aromatic hydrocarbons and polychlorinated biphenyls. *Anal. Chem.* 65, 338-344.
- Lee, M.L., Novotny, M.V. and Bartle, K.D. (1981), in *Analytical Chemistry of Polycyclic Aromatic Compounds*, Academic Press, New York, 143-152.
- Lopez-Avila, V., Dohiwala, N.S. and Beckert, W.F. (1990). "Supercritical fluid extraction and its applications to environmental analysis. *J. Chromatogr. Sci.* , 28, 468-79.
- Lopez-Avila, V., Benedicto, J., Dohiwala, N.S., Young, R. and Beckert, W.F. (1992). Development of an off-line SFR-IR method for petroleum hydrocarbons in solids. *J. Chromatogr. Sci.*, 30, 335-343.
- Manuals and Guides No 27. IOC (1993).**
- Nam, K.S., Kapila, S., Yanders, A.F. and Puri, R.K. (1991). A multiple sample extraction and on-line system for the analysis of chlorinated compounds. *Chemosphere*, 23, 1109-1116.
- Petrick, G., Schulz, D.E. and Duinker, J.C. (1988). Clean-up of environmental samples by high-performance liquid chromatography for analysis of organochlorine compounds by gas chromatography with electron-capture detection. *J. Chromatogr.*, 435, 241-248.
- Reference Method No 6, UNEP/FAO/IOC/IAEA: Guidelines for monitoring chemical contaminants in the sea using marine organisms. UNEP, 1993.
- Reference Method No 12 Rev.2, UNEP/FAO/IAEA/IOC: Sampling of selected marine organisms and sample preparation for the analysis of chlorinated hydrocarbons. UNEP, 1991.
- Reference Method No 20, UNEP/IOC/IAEA: Determination of petroleum hydrocarbons in sediments. UNEP, 1992.
- Reference Method No 57, UNEP/IOC/IAEA/FAO: Contaminant monitoring programme using marine organisms: Quality assurance and good laboratory practice. UNEP, 1990.

Reference Method No 58: Guidelines for the use of sediments for marine pollution monitoring programmes. (in preparation).

Reference Method No 65, UNEP/IOC/IAEA: Reagent and laboratory ware clean-up procedures for low-level contaminants monitoring. (in preparation).

Tanabe, S., Kannan, N., Wakimoto, T. and Tatsukawa, R. (1986). Method for the determination of three toxic non-ortho-chlorine substituted co-planar PCBs in environmental samples at part-per-trillion levels. Intern. J. Environ. Anal. Chem. Vol. 29, 199-213.

UNEP (DEC)/MED WG.282/Inf.5/Rev1: Methods for sediment sampling and analysis (2006).

Villeneuve, J.P. (1986). Géochimie des composés organochlorés dans l'environnement marin. Thèse de Doctorat de l'Université Paris VI. 180 pages.

ANNEX

**PREPARATION OF THE SOLUTION OF INTERNAL STANDARDS:
PCB No 29, PCB No 198, ϵ HCH and Endosulfan I d4**

Stock Solution of PCB No 29:

1 ml from the original vial (250ng/ μ l) should be transferred into a 100 ml volumetric flask, and then the volume is adjusted to 100 ml with hexane. This stock solution contains:

2.5 ng/ μ l of PCB No 29

Stock Solution of Endosulfan I d4:

1 ml from the original vial (250ng/ μ l) should be transferred into a 100 ml volumetric flask, and then the volume is adjusted to 100 ml with hexane. This stock solution contains:

2.5 ng/ μ l of Endosulfan I d4

Working solution of internal standards:

0.5 ml from the stock solution of PCB No 29 (2.5 ng/ μ l) should be transferred into a 50 ml volumetric flask, then, 0.5 ml from the stock solution of Endosulfan I d4 (2.5 ng/ μ l) should be transferred into the volumetric flask, then 1 ml from the original vial (1ng/ μ l) of ϵ HCH should be transferred into that volumetric flask, then 0.5 ml from the concentrated solution (2ng/ μ l) of PCB No 198, and the volume adjusted to 50 ml with hexane. This working solution contains:

25 pg/ μ l of PCB No 29

20 pg/ μ l of PCB No 198

20 pg/ μ l of ϵ HCH

25 pg/ μ l of Endosulfan I d4

CAUTION: VIALS SHOULD BE COOLED AT 20°C PRIOR TO OPENING

Preparation of the Aroclor 1254 solution

Preparation of the stock solution:

1 ml from the original vial should be transferred into a 100 ml volumetric flask, then, the volume is adjusted to 100 ml with hexane. This stock solution contains:

6.5 ng/μl of Aroclor 1254

Preparation of the working solution:

1 ml from this stock solution should be transferred into a 50 ml volumetric flask and the volume adjusted to 50 ml with hexane. This working solution contains :

0.13 ng/μl of Aroclor 1254

CAUTION : VIAL SHOULD BE COOLED TO 20 °C PRIOR TO OPENING

Preparation of the Aroclor 1260 solution

Preparation of the stock solution:

1 ml from the original vial should be transferred into a 100 ml volumetric flask, then the volume is adjusted to 100 ml with hexane. This solution contains:

5.44 ng/μl of Aroclor 1260

Preparation of the working solution:

1 ml from the stock solution should be transferred into a 50 ml volumetric flask, then the volume is adjusted to 50 ml with hexane. This working solution contains

0.1088 ng/μl of Aroclor 1260

CAUTION: VIAL SHOULD BE COOLED TO 20 °C PRIOR TO OPENING

Preparation of the pp' DDE, pp' DDD and pp' DDT solution

pp' DDE:

Stock solution: 1 ml from the original vial should be transferred into a 100 ml volumetric flask, then the volume is adjusted to 100 ml with hexane. This stock solution contains:

5 ng/μl of pp' DDE

pp' DDD:

Stock solution: 1 ml from the original vial should be transferred into a 100 ml volumetric flask, then the volume is adjusted to 100 ml with hexane. This solution contains:

5 ng/μl of pp' DDD

pp' DDT:

Stock solution: 1 ml of the original vial should be transferred into a 100 ml volumetric flask, then the volume is adjusted to 100 ml with hexane. This stock solution contains:

5 ng/μl of pp' DDT

Working solution: pp' DDE, pp' DDD and pp' DDT together.

1 ml from the stock solution of pp' DDE, 2 ml of the stock solution of pp' DDD and 3 ml of the stock solution of pp' DDT should be transferred into a 100 ml volumetric flask and the volume adjusted to 100 ml with hexane. This solution contains

- pp' DDE : 50 pg/μl
- pp' DDD : 100 pg/μl
- pp' DDT : 150 pg/μl

NOTE: Further dilution may be necessary depending on the sensitivity of the EC Detector.

CAUTION: VIAL SHOULD BE COOLED TO 20 °C PRIOR TO OPENING

Preparation of Aldrin, Dieldrin and Endrin standard solutions:

Aldrin:

Stock solution: 1 ml from the original vial should be transferred into a 100 ml volumetric flask, then the volume is adjusted to 100 ml with hexane. This solution contains:

5 ng/μl of Aldrin

Dieldrin:

Stock solution: 1 ml from the original vial should be transferred into a 100 ml volumetric flask, then the volume is adjusted to 100 ml with hexane. This solution contains:

5 ng/μl of Dieldrin

Endrin:

Stock solution: 1 ml from the original vial should be transferred into a 100 ml volumetric flask, then the volume is adjusted to 100 ml with hexane. This solution contains:

5 ng/μl of Endrin

Working solution: Aldrin, Dieldrin and Endrin together.

1 ml from the stock solution of Aldrin, 1 ml from the stock solution of Dieldrin and 1 ml from the stock solution of Endrin are transferred into a 100 ml volumetric flask and the volume is adjusted to 100 ml with hexane. This working solution contains:

Aldrin : 50 pg/μl
Dieldrin : 50 pg/μl
Endrin : 50 pg/μl

NOTE: Further dilution may be necessary depending on the sensitivity of the detector.

CAUTION: VIALS SHOULD BE COOLED TO 20 °C PRIOR TO OPENING

Preparation of the HCB and Lindane standard solutions:

HCB:

Stock solution: 1 ml from the original vial should be transferred into a 100 ml volumetric flask, then the volume is adjusted to 100 ml with hexane. This solution contains:

5 ng/μl of HCB

Lindane:

Stock solution: 1 ml from the original vial should be transferred into a 100 ml volumetric flask, then the volume is adjusted to 100 ml with hexane. This solution contains:

5 ng/μl of lindane

Working solution:

1 ml from the stock solution of HCB and 1 ml from the stock solution of Lindane are transferred into a 100 ml volumetric flask, then the volume is adjusted to 100 ml with hexane. This solution contains:

HCB : 50 pg/μl

Lindane : 50 pg/μl

NOTE: further dilution may be necessary depending on the sensitivity of the EC Detector.

CAUTION: VIALS SHOULD BE COOLED TO 20 °C PRIOR TO OPENING

Preparation of the PCB congeners solution

In a 100 ml volumetric flask, transfer 1 ml from the original vial. Adjust to 100 ml with hexane in order to obtain the working solution with the following concentrations:

CB N°:	Compounds:	Concentrations (pg/μl)
8	2,4'	17.50
18	2,2',5	12
31	2,4',5	10.6
28	2,4,4'	4.6
52	2,2',5,5'	8.6
49	2,2',4,5'	12.1
44	2,2',3,5'	10.7
66	2,3',4,4'	5.5
95	2,2',3,5',6	5.7
101	2,2',4,5,5'	9.3
110	2,3,3',4',6	11.1
149	2,2',3,4',5',6	12.1
118	2,3',4,4',5	8.5
153	2,2',4,4',5,5'	8.4
138	2,2',3,4,4',5'	13.8
183	2,2',3,4,4',5',6	10.3
174	2,2',3,3',4',5,6'	9.4
177	2,2',3,3',4',5,6	9.5
180	2,2',3,4,4',5,5'	16.3
170	2,2',3,3',4,4',5	13.4
199	2,2',3,3',4,5,5',6'	9.3
194	2,2',3,3',4,4',5,5'	12.6

Separate into 10 volumetric flasks of 10 ml, seal with Teflon tape and keep in refrigerated place in order not to evaporate them.

CAUTION: VIAL SHOULD BE COOLED TO 20 °C PRIOR TO OPENING

EUNOCI 221-02937-0, E05 SED @ BHIMADZU

14:241	15.223	15.961	17.859	18.88	21.880	21.728	22.598	25.898	27.665	48.812	48.873	44.546	45.661	50.523	8	54.133	18	56.927	31	58.927	28	52.791	52	68.927	49	62.227	44	62.877	66 + 95	65.511	101	68.326	110	71.267	118	72.791	153	74.828	183	76.747	174	78.194	177	80.298	180	82.178	199	84.751	194	86.664	194
--------	--------	--------	--------	-------	--------	--------	--------	--------	--------	--------	--------	--------	--------	--------	---	--------	----	--------	----	--------	----	--------	----	--------	----	--------	----	--------	---------	--------	-----	--------	-----	--------	-----	--------	-----	--------	-----	--------	-----	--------	-----	--------	-----	--------	-----	--------	-----	--------	-----

Issued and printed by

Oceans and Coastal Areas Programme Activity Centre
United Nations Environment Programme

Additional copies of this and other publications issued by
the Oceans and Coastal Areas Programme Activity Centre
can be obtained from:

Oceans and Coastal Areas Programme Activity Centre
United Nations Environment Programme
P.O. Box 30552
Nairobi
Kenya

Or from:

Marine Environmental Studies Laboratory
International Atomic Energy Agency
Environment Laboratories
4 Quai Antoine 1^{er}
98000 MONACO

Annex X:

HELCOM

**Manual for marine monitoring in the COMBINE programme
ANNEX B-12, APPENDIX 3. TECHNICAL NOTE ON THE DETERMINATION OF
CHLORINATED BIPHENYLS AND ORGANOCHLORINE PESTICIDES IN BIOTA**

HELCOM Manual for marine monitoring in the COMBINE programme

ANNEX B-12, APPENDIX 3. TECHNICAL NOTE ON THE DETERMINATION OF CHLORINATED BIPHENYLS AND ORGANOCHLORINE PESTICIDES IN BIOTA

1. INTRODUCTION

The analysis of chlorinated biphenyls (CBs) and organochlorine pesticides (OCPs) in fish samples generally involves extraction from the respective matrix with organic solvents, followed by clean-up and gas chromatographic separation with electron capture (GC-ECD) or mass spectrometric (GC-MS) detection.

The analytical procedure is liable to systematic errors due to insufficiently optimized gas chromatographic conditions, determinant losses (evaporation, unsatisfactory extraction yield), and/or contamination from laboratory ware, reagents and the laboratory environment. It is therefore essential that the sources of systematic errors are identified and eliminated as far as possible.

In the following paragraphs, the guidelines drafted by the OSPAR Ad Hoc Working Group on Monitoring (OSPAR, 1996) have been taken into consideration.

2. PRE-TREATMENT OF LABORATORY WARE AND REAGENTS; CONTAMINATION CONTROL

Glassware, reagents, solvents, column adsorption materials and other laboratory equipment that come into contact with the sample material to be analysed should be free of impurities that interfere with the quantitative determination of CBs and OCPs.

For cleaning purposes, the following procedures should be followed:

1. Glassware should be thoroughly washed with detergents, dried with acetone and rinsed with a non-polar solvent such as *n*-pentane, and heated to > 100 °C prior to use.
2. Glass fibre Soxhlet thimbles should be pre-extracted with an organic solvent. The use of paper Soxhlet thimbles should be avoided. Alternatively, glass fibre thimbles or full glass Soxhlet thimbles, with a G1 glass filter at the bottom, are recommended.
3. Solvents should be checked for impurities using GC after concentrating the volume normally used in the procedure to 10 % of the final volume. If necessary, solvents can be purified by controlled re-distillation and rectification over KOH in an all-glass distillation column.
4. Reagents and column adsorption materials should be checked for contamination before use by extraction with an organic solvent (e.g., *n*-pentane) and analysis by GC, using the detector which will also be used for the final determination (ECD or MS).
5. Laboratory air can also be contaminated with CBs, OCPs or compounds interfering with the CB/OCP analysis. A good estimation of the contamination of the air can be found by placing a petri dish with 2 grams of C18-bonded silica for two weeks in the laboratory. After this period, the material is transferred to a glass column and eluted with 10 ml of 10% diethylether in hexane. After concentrating the eluate, the CB concentrations can be measured. Absolute amounts of <1 ng show that the contamination of the air is at an acceptably low level in that laboratory (Smedes and de Boer, 1994).

3. SAMPLE PRETREATMENT

To ensure complete extraction of the lipophilic CBs and OCPs from biological sample matrices, it is essential to dry the material and disrupt the cell walls of the biological matrix to be analysed. This can be achieved by Ultra Turrax mixing or grinding of the sample with a dehydrating reagent, such as Na_2SO_4 , followed by multiple solid/liquid extraction with a mixture of polar and non-polar solvents (e.g., acetone/hexane or methanol/dichloromethane). It is essential to allow complete binding of the water present in the sample with the dehydrating reagent (this requires at least several hours) prior to starting the extraction step. The extraction efficiency must be checked for different types and amounts of biological matrices to be investigated (see 'recovery section').

4. CLEAN-UP

The crude extract obtained from sample pretreatment requires a clean-up in order to remove co-extracted lipophilic compounds that interfere with the gas chromatographic determination of CBs and OCPs. Normal-phase solid/liquid chromatography, using deactivated Al_2O_3 or deactivated silica as adsorbents and hexane or iso-octane as solvents, is an appropriate technique for the separation of the determinands from lipids or other interfering compounds. Effective removal of high molecular weight compounds can be achieved by gel permeation chromatography (GPC). However, GPC does not separate CBs from other compounds in the same molecular range, such as organochlorine pesticides (OCPs). Therefore, additional clean-up may be required. Treatment of the OCP fraction with concentrated H_2SO_4 can improve the quality of the subsequent gas chromatogram. However, this treatment is not recommended if determinands of the dieldrin type or heptachloroepoxides, which are easily broken down by H_2SO_4 , are to be determined.

5. DETERMINATION BY GAS CHROMATOGRAPHY

Because of the large number of organochlorine compounds to be determined, high resolution gas chromatography (GC) using, preferably narrow bore, fused silica wall-coated open-tubular (capillary) columns is necessary.

Carrier gas

Hydrogen is the preferred carrier gas and is indispensable for columns with very small inner diameters. For safety reasons, hydrogen should not be used without a safety module which is able to check for small hydrogen concentrations inside the GC oven coming from possible leakages. As a compromise to safety aspects, helium is also acceptable.

Columns

In order to achieve sufficient separation, capillary columns should have a length of >60 m, an internal diameter of < 0.25 mm (for diameters below 0.18 mm the elevated pressure of the carrier gas needs special instrumentation) and a film thickness of the stationary phase of < 0.25 μm . For routine work, the SE 54 (Ultra 2, DB 5, RTx 5, CP-Sil 8) phase (94 % dimethyl-, 5 % phenyl-, 1 % vinyl-polysiloxane) or medium polar columns (CP-Sil 19, OV-17, OV 1701, DB 17) have been shown to give satisfactory chromatograms. A second column with a stationary phase different, from that used in the first column, may be used for confirmation of the peak identification.

Injection

Splitless and on-column injection techniques may both be used. Split injection is not recommended because strong discrimination effects may occur. Other techniques such as temperature-programmed or pressure-programmed injection may have additional advantages, but should be thoroughly optimized before use.

In splitless injection, the volume of the liner should be large enough to contain the gas volume of the evaporated injected solvent. If the liner is too small, memory effects can occur due to contamination of the gas tubing attached to the injector. Very large liner volumes, in contrast, can cause a poor transfer of early eluting components.

A 1 µl injection normally requires a ca. 1 ml liner. The occurrence of memory effects should be tested by injection of iso-octane after analysis of a CB or OCP standard. The use of a light packing of silylated glass wool in the liner improves the response and reproducibility of the injection. However, some organochlorine pesticides such as DDT may disintegrate when this technique is used. In splitless injection, discrimination effects can occur.

The splitless injection time should therefore be optimized to avoid discrimination. This can be done by injecting a solution containing an early-eluting and a late-eluting CB, e.g., CB28 and CB180. Starting with a splitless injection time of 0.5 minutes, the peak height of the late-eluting compound will presumably increase relative to that of the first compound. The optimum is found at the time when the increase does not continue any further. The split ratio is normally set at 1:25 and is not really critical. The septum purge, normally approximately 2 ml min⁻¹, should be stopped during injection. This option is not standard in all GCs.

Due to the variety of on-column injectors, a detailed optimization procedure cannot be given. More information on the optimization of on-column parameters may be obtained from Snell *et al.* (1987).

The reproducibility of injection is controlled by the use of an internal standard not present in the sample.

Detector

Quantitative analysis is performed by comparing the detector signal produced by the sample with that of defined standards. The use of an electron capture detector (ECD) sensitive to chlorinated compounds or - more generally applicable - a mass selective detector (MSD) or (even) a mass spectrometer (MS) is essential.

Due to incomplete separation, several co-eluting compounds can be present under a single detector signal. Therefore, the shape and size of the signal have to be critically examined. With a MSD or MS used as detector, either the molecular mass or characteristic mass fragments should be recorded for that purpose. If only an ECD is available, the relative retention time and the signal size should be confirmed on columns with different polarity of their stationary phases, or by the use of multi-dimensional GC techniques (de Boer *et al.*, 1995; de Geus *et al.*, 1996).

Calibration

Stock solutions of individual organohalogen compounds should be prepared using iso-octane as the solvent and weighed solid individual standard compounds of high purity (> 99 %). Stock solutions can be stored in measuring flasks in a refrigerator or in a dessicator with a saturated atmosphere of iso-octane, but losses can easily occur, particularly when storing in refrigerators (Law and de Boer, 1995). Loss of solvents in stock solutions can be controlled by recording the weight and filling up the missing amount before a new aliquot is taken. However, aliquots stored in sealed glass ampoules are much more appropriate and can normally be stored for several years. Fresh stock standard solutions should be prepared in duplicate and compared with the old standard solutions. Working standards should be prepared gravimetrically from stock solutions for each sample series. All manipulations with solvents, including pipetting, diluting and concentrating, should preferably be checked by weighing. Due to day-to-day and season-to-season temperature differences in laboratories and due to the heating of glassware after cleaning, considerable errors can be made when using volumetric glassware as a basis for all calculations.

The GC should be calibrated before each batch of measurements. Since the ECD has a non-linear response curve, a multilevel calibration is strongly advised. Megginson *et al.* (1994) recommend a set of six standard solutions for CB determination or five standard solutions for OCP determination. Standards used for multilevel calibration should be regularly distributed over the sample series, so that matrix and non-matrix containing injections alternate. When concentrations of compounds in the sample fall outside either side of the calibration curve, a new dilution or concentrate should be made and the measurement repeated. Considerable errors can be made when measuring concentrations which fall outside the calibration curve.

For MS detection, a multi-level calibration is also recommended.

Recovery

For the purpose of determining recovery rates, an appropriate internal standard should be added to each sample at the beginning of the analytical procedure. The ideal internal standard is a CB which is not present in the sample and which does not interfere with other CBs. All 2,4,6-substituted CB congeners are, in principle, suitable. Alternatively, 1,2,3,4-tetrachloronaphthalene or the homologues of dichloroalkylbenzylether can be used. For GC with mass selective detection (GC-MSD), ¹³C-labelled CBs must be used as internal standards. With GC/MS, ¹³C-labelled CBs should preferably be used as internal standards.

6. REFERENCES

- de Boer, J., and Dao, Q.T. 1991. Analysis of seven chlorobiphenyl congeners by multidimensional gas chromatography. *Journal of High Resolution Chromatography*, 14: 593-596.
- de Boer, J., Dao, Q.T., Wester, P.G., Bøwadt, S., and Brinkman, U.A.Th. 1995. Determination of mono-*ortho* substituted chlorobiphenyls by multidimensional gas chromatography and their contribution to TCDD equivalents. *Analytica Chimica Acta*, 300: 155-165.
- de Geus, H.-J., de Boer, J., and Brinkman, U.A.Th. 1996. Multidimensionality in gas chromatography. *Trends in Analytical Chemistry*, 15: 398-408.
- Law, R.J., and de Boer, J. 1995. Quality assurance of organic compounds in marine matrices: application to analysis of chlorobiphenyls and polycyclic aromatic hydrocarbons. *In Quality assurance in environmental monitoring*, pp. 129-155. Edited by Ph. Quevauviller. VCH, Weinheim, Germany.
- Megginson, C., McKenzie, C., and Wells, D. 1994. Practical steps to improve the quality control of the chromatography for chlorobiphenyl and organochlorine pesticide analysis. *Marine Pollution Bulletin*, 29: 228-234.
- OSPAR. 1996. Ad Hoc Working Group on Monitoring (MON). Draft JAMP Biota Monitoring Guidelines. Doc. MON 96/9/1, Annex 5. OSPAR Commission, London, UK.
- Smedes, F., and de Boer, J. 1994. Guidelines for the determination of chlorobiphenyls in sediments. *Quimica Analytica*, 13: S100-S108.
- Snell, R.P., Danielson, J.W., and Oxborrow, G.W. 1987. Parameters affecting the quantitative performance of cold on-column and splitless injection systems used in capillary gas chromatography. *Journal of Chromatography Science*, 25: 225-230.

Annex XI:

OSPAR COMMISSION

**CEMP Guidelines for Monitoring Contaminants in Sediments
(OSPAR Agreement 1999-02)
Technical Annex 8: Determination of chlorobiphenyls in biota**



CEMP Guidelines for Monitoring Contaminants in Sediments

(OSPAR Agreement 1999-02)

Technical Annex 8: Determination of chlorobiphenyls in biota

1. Introduction

This technical annex provides advice on chlorobiphenyl (CB) analysis for all biota samples. The guideline is an update of an earlier version (OSPAR, 1999) taking into account evolutions in the field of analytical chemistry and also covering the determination of the planar CBs, i.e. the mono-*ortho* (CB105, CB114, CB118, CB123, CB156, CB157, CB167 and CB189) and non-*ortho* substituted CBs (CB81, CB77, CB126 and CB169). When reviewing the literature, it should be noted that planar, coplanar and dioxin-like CBs / PCBs are all equivalent terms.

The analysis of CBs in biota generally involves extraction with organic solvents, clean-up (removal of lipids and fractionation), and gas chromatographic separation with electron capture or mass-spectrometric detection. All stages of the procedure are susceptible to insufficient recovery and/or contamination. Where possible, quality control procedures are required in order to check the method's performance. These guidelines are intended to encourage and assist analytical chemists to reconsider their methods and to improve their procedures and/or the associated quality control measures where necessary. Due to the low concentrations of, particularly, non-*ortho* substituted CBs in biota compared to those of other CBs, their determination requires an additional separation and concentration step. Therefore, in the relevant sections a distinction will be made between the non-*ortho* CBs and the others.

These guidelines can also be used for several other groups of organochlorine compounds, e.g. DDTs and their metabolites, chlorobenzenes and hexachlorocyclohexanes. Recoveries in the clean-up procedures must be checked carefully. In particular, treatment with H₂SO₄ results in a loss of some compounds (e.g. dieldrin and endosulfan (de Boer and Wells, 1996)).

These guidelines are not intended as a complete laboratory manual. If necessary, further guidance should be sought from specialised laboratories. Whichever analytical procedure is adopted, the laboratory must demonstrate the validity of the procedure. Analyses must be carried out by trained staff.

2. Analysis

2.1. Precautionary measures

Solvents, chemicals and adsorption materials must be free of CBs or other interfering compounds. If not they should be purified using appropriate methods. Solvents should be checked by concentrating the volume normally used in the procedure to 10% of the final volume if practical and then analysing for the presence of CBs and other interfering compounds. If necessary, the solvents can be purified by

redistillation but this practice is not favoured by most analytical laboratories as they generally opt to purchase high quality solvents directly. Chemicals and adsorption materials should be purified by extraction and/or heating. Glass fibre materials (e.g. thimbles for Soxhlet extraction) should be pre-extracted. Alternatively, glass thimbles with a G1 glass filter at the bottom can be used. Generally, paper filters should be avoided in filtration and substituted for by appropriate glass filters. As all pre-cleaned materials are prone to contamination (e.g. by the adsorption of CBs and other compounds from laboratory air), materials ready for use should not be stored for long periods. All containers, tools, glassware etc. which come into contact with the sample must be made of appropriate material and must have been thoroughly pre-cleaned. Glassware should be extensively washed with detergents, heated at >250°C and rinsed immediately before use with organic solvents or mixtures such as hexane/acetone. In addition all glassware should preferably be covered with aluminium foil and stored in cupboards to keep out any dust. Old and scratched glassware is more likely to cause blank problems because of the larger surface and therefore greater chance of adsorption. Furthermore, scratched glassware can be more difficult to clean effectively, as shown during analysis of brominated flame retardants (QUASIMEME, 2007).

2.2 Lipid determination

The determination of the lipid content of tissues can be of use in characterising the samples and reporting concentrations in biota on a wet weight or lipid weight basis. The total lipid content of fish or shellfish should be determined using the method of Bligh and Dyer (1959) as modified by Hanson and Olley (1963) or an equivalent method such as Smedes (1999). Extractable lipid methods may be used, particularly if the sample size is small and lipid content is high. It has been shown that if the lipid content is high (> 5%) then the extractable lipid content will be comparable to that of the total lipid. If extraction techniques are applied which destroy or remove lipid materials (e.g., PLE with fat retainers), the lipid content should be determined on a separate subsample of the tissue homogenate. Other relevant information concerning lipid determination are provided by QUASIMEME, 1994 and Roose *et al.*, 1996.

2.3. Dry weight determination

Dry weight determinations should be carried out by drying homogenised sub-samples of the material to be analysed to constant weight at 105°C.

2.4. Homogenisation and drying

Prior to analysis, the samples should be sufficiently homogenised. Homogenisation is generally carried out on fresh tissue. Care should be taken that the sample integrity is maintained during the actual homogenisation. When the analysis is undertaken, all fluids that may initially separate on thawing should be included with the materials homogenised. Homogenisation should be performed prior to extraction and clean-up procedures. When homogenising samples after drying, classical techniques using a ball mill can be used. Cryogenic homogenisation of dried or fresh materials at liquid nitrogen temperatures using a PTFE device (*cf.* Iyengar and Kasperek, 1977) or a similar technique is also possible (*cf.* Iyengar, 1976; Klusmann *et al.*, 1985).

CBs can be extracted from either wet or dried samples, although storage, homogenisation and extraction are easier when the samples are dry. Drying the samples may, however, alter the CB concentrations e.g. by the loss of compounds through evaporation or by contamination. Potential losses and contamination should be checked as part of the method validation.

Chemical drying can be performed by grinding with e.g. Na₂SO₄ or MgSO₄ until the sample reaches a free-flowing consistency. It is essential that at least several hours elapse between grinding and extraction to allow for complete dehydration of the sample, as the presence of residual water will decrease the extraction efficiency.

Freeze-drying is also a popular technique, although its application should be carefully considered. Possible losses or contamination must be checked. Losses through evaporation are diminished by keeping the temperature in the evaporation chamber below 0°C. Contamination during freeze-drying can be reduced by putting a lid, with a hole of about 3 mm in diameter, on the sample container.

2.5. Extraction

Recovery standards should be added prior to extraction. When using Soxhlet extraction, a combination of polar and apolar solvents is recommended. Alternatively, saponification may be used. This technique is highly effective, but conditions should be controlled as saponification could result in the decomposition of some pesticides and, under certain conditions, of some CB congeners.

Although the use of binary non-polar/polar solvent mixtures and Soxhlet extraction is still the benchmark for CB extraction, there have been numerous attempts to find alternative procedures, which are less time-consuming, use less solvent and/or enable miniaturisation. Amongst these novel approaches are pressurised liquid extraction (PLE) and related subcritical water extraction (SWE), microwave-assisted extraction (MAE), matrix solid-phase dispersion (MSPD), ultrasound extraction (US) and supercritical fluid extraction (SFE).

From among the techniques mentioned, PLE or Accelerated Solvent Extraction (ASE) has – so far – been most successful. Soxhlet methods are easily translated into PLE as the same solvent compositions can be used. The method further allows interesting modifications that include in-cell clean-up of samples by adding fat retainers, such as acid-impregnated silica, florisil or alumina, to the cell. New promising techniques have been described, e.g. the use of a small carbon column in the extraction cell, which selectively adsorbs dioxin-like compounds (subsequently isolated by back-flushing with toluene), but these are not established for routine analysis (Sporring *et al.*, 2003). PLE and MAE have the shared advantage over SFE that they are matrix-independent, which facilitates method development and changing-over from the classical Soxhlet extraction. Recent years have also seen an increased use of ultrasound-based techniques for the isolation of analytes from solid samples. With most applications, extraction efficiency is satisfactory, and sonication time often is 30 min or less (Roose and Brinkman, 2005).

All the methods described above are in principle suitable for extracting CBs from biota. However, Soxhlet extraction is still the reference for alternative approaches.

2.6 Clean-up

The extraction procedures above will result in the co-extraction of lipids, which will need to be removed from the extract. Furthermore, tissue extracts will always contain many compounds other than CBs, and a suitable clean-up is necessary to remove those compounds which may interfere with the subsequent analysis. Different techniques may be used, either singly or in combination, and the choice will be influenced by the selectivity and sensitivity of the final measurement technique and also by the extraction method employed. Most CBs are stable under acid conditions; therefore treatment with sulphuric acid or acid impregnated silica columns may be used in the clean-up.

The most commonly used clean-up methods involve the use of alumina or silica adsorption chromatography, but gel permeation chromatography (GPC) is also employed. Any water residues in the extract should be removed prior to clean-up, e.g. by adding Na₂SO₄.

As CBs are apolar, clean-up using normal-phase chromatography is the most appropriate technique for their separation from other compounds. Using an apolar solvent (e.g. hexane or *iso*-octane) as an eluent, CBs normally elute very rapidly. All polar solvents used in the extraction should be removed before further clean-up. The last concentration step is usually performed by evaporation with a gentle stream of nitrogen. Evaporation to dryness should always be avoided but, for the analysis of planar CBs, very small final sample extract volumes might be necessary to achieve detectable concentrations.

Deactivated Al₂O₃ (5-10% water) is often used as a primary clean-up technique. Al₂O₃ can yield a sufficiently clean extract for a GC-ECD analysis of the sample. Al₂O₃ effectively removes lipid compounds from the extracts (although samples with a very high lipid content and low CB concentrations may require additional clean-up).

Deactivated silica (1-5% water) does not retain CBs (including non-*ortho* CBs) and only retains polycyclic aromatic hydrocarbons (PAHs) slightly when eluted with hexane or *iso*-octane. When organochlorine pesticides are also to be determined in the same extract, deactivation of the silica with a few percent of water is necessary.

For high activity silica (heated overnight at 180°C) the retention of CBs is negligible, while PAHs are more strongly retained. The CBs and a few other organochlorine compounds can be eluted with apolar solvents. More polar solvents (e.g. hexane/acetone) should be avoided as some interfering organochlorine pesticides would be eluted as well.

For the separation of CBs from lipids or oil components, reversed-phase HPLC can be used. In reversed-phase chromatography, CBs elute during a solvent gradient of 80 to 90% methanol together with numerous other compounds of the same polarity. Most of the above mentioned extraction methods and clean-up procedures yield an extract containing an apolar solvent. These cannot be injected directly for reversed-phase chromatography, and so compounds must be transferred between solvents several times e.g. before injection and after elution. When using polar solvents for extraction, reversed-phase columns could be used directly for clean-up. When eluting an acetonitrile extract from a C₁₈ solid phase extraction (SPE) column with acetonitrile, high molecular hydrocarbons are strongly retained while CBs elute in the first few column volumes.

The above mentioned normal-phase chromatographic procedures on silica and Al₂O₃ can be transferred to HPLC having the advantages of higher resolution and better reproducibility.

When using GPC, the elution of CBs should be carefully checked. Two serial columns are often used for improved lipid separation. Solvent mixtures such as dichloromethane/hexane or cyclohexane/ethyl acetate can be used as eluents for GPC. However, a second clean-up step is often required to separate the CBs from other organohalogenated compounds and/or to remove residual lipids.

One advantage of using PLE extraction is that it is possible to combine the clean-up with the extraction, especially where mass spectrometry will be used as the detection method. If Soxhlet extraction is used for biota, then there is a much greater quantity of residual lipid to be removed than in the case of PLE with fat retainers. An additional clean-up stage may therefore be necessary. Methods have been developed for online clean-up and fractionation of dioxins, furans and CBs with PLE for food, feed and

environmental samples (Sporring *et al.*, 2003), utilising a fat retainer for the on-line clean-up of fat. Silica impregnated with sulphuric acid, alumina and florisil have all been used as fat retainers. A non-polar extraction solvent such as hexane should be used if fat retainers are used during PLE.

Non-*ortho* CBs require a more specialised clean-up that is generally associated with the analysis of dioxins. Although initial clean-up may very well proceed along the lines described above, the larger sample intake results in the presence of even more co-extractive compounds and care has to be taken that the capacity of the adsorption columns is not exceeded and/or that lipids are adequately removed. Often, more rigorous procedures are applied to remove the excess material by e.g. shaking the sample with concentrated sulphuric acid. A more efficient alternative is to elute the sample over a silica column impregnated with sulphuric acid (40 % w/w).

Non-*ortho* CBs are nearly always separated from the other CBs using advanced separation techniques. One very efficient method is to inject the extracts (after concentrating them) into a HPLC system coupled to a PYE (2-(1-pyrenyl) ethyldimethylsilylated silica) column. Column dimensions are typically 4.6 x 150 mm, but combinations of several columns in-line are sometimes used. The use of PYE columns not only allow the separation of *ortho*, mono-*ortho* and non-*ortho* CBs from one another on the basis of structural polarity, but also from dibenzo-p-dioxins and dibenzofurans. The eluting solvent is an apolar solvent such as iso-hexane. Coupled to a fraction collector, the use of a HPLC system allows the automatic clean-up of a considerable number of samples at a time. Alternatively, HPLC systems equipped with porous graphitised carbon can be used. Column sizes are in the order of 50 x 4.7 mm and care has to be taken that the column is not overloaded. Similarly to PYE columns, they will separate non-*ortho* CBs from the other CBs and from dioxins. Fully automated systems, such as Powerprep™, that combine several steps are routinely used.

2.7 Pre-concentration

Evaporation of solvents using a rotary-film evaporator was, until recently, the most common method. However, evaporation of solvents using this technique should be performed at low temperature (water bath temperature of $\leq 40^{\circ}\text{C}$) and under controlled pressure conditions, in order to prevent losses of the more volatile CBs. To reduce the sample to the final volume, solvents can be removed by blowing-down with a gentle stream of nitrogen. Only nitrogen of a controlled high quality should be used.

Turbovap sample concentrators can also be used to reduce solvent volume. This is a rapid technique, but needs to be carefully optimised and monitored to prevent both losses (both of volatiles and solvent aerosols) and cross-contamination. The use of rotary-film evaporators is more time consuming but more controllable. Here also, evaporation to dryness should be avoided at all costs. Syncore™ parallel evaporators (Buchi, Switzerland) can be used with careful optimisation of the evaporation parameters. The Buchi Syncore™ Analyst also uses glass tubes but the system is sealed, avoiding contamination from the laboratory air during evaporation. It does not use a nitrogen stream, thus reducing the loss of volatiles and if the flushback module is fitted the sides of the tubes are rinsed automatically thus reducing the loss of the heavier components. Again water-bath temperatures should be minimised to prevent losses. When reducing the sample to the required final volume, solvents can be removed by a stream of clean nitrogen gas. Suitable solvents for injection into the gas chromatograph (GC) include hexane, heptane, toluene and *iso*-octane.

2.8 Calibration and preparation of calibrant solutions

Internal standards (recovery and quantification standards) should be added in a fixed volume or weight to all standards and samples. The ideal internal is a CB which is not found in the samples. All CBs with a 2,4,6-substitution (e.g. CB112, CB155, CB198) are, in principle, suitable for this purpose. Alternatively, 1,2,3,4-tetrachloronaphthalene or homologues of dichloroalkylbenzylether can be used. For GC analysis with mass selective detection (GC-MS), ¹³C labelled CBs should be used at each degree of chlorination. This is especially critical for the determination of the non-ortho CBs. If possible, the labelled calibrant solutions should correspond to the unlabelled determinants. For the non-ortho CBs, a labelled standard is available for each congener and use of all of them is recommended. When preparing a calibration solution for a new determinant for the first time, two independent stock solutions of different concentrations should always be prepared simultaneously to allow cross checking. A new calibration solution should also be cross-checked to the old standard solution. Crystalline CBs of known purity can be used for preparing calibration solutions but, for health and safety reasons, the purchase of solutions is recommended for planar CBs. In recent years, a lot of certified commercial custom made standards have become available and laboratories have been switching to these. If the quality of the standard materials is not guaranteed by the producer or supplier, it should be checked by GC preferably with mass spectrometric detection. Solid standards should be weighed to a precision of 10⁻⁵ grams. Calibration solutions should preferably be stored in ampoules in a cool and dark place. Commercially available screw-cap vials with a capillary opening (CertanTM) combine of advantages of ampoules and vials, and, have proven to be reliable. When stored in containers the weight loss during storage should be recorded.

2.9 Instrumental determination

2.9.1 Injection techniques

The two modes commonly used are splitless and on-column injection as, in split injection, strong discrimination effects may occur. The liner should possess sufficient capacity with respect to the injected volume after evaporation, but should not be oversized so as to avoid poor transfer to the column and losses by adsorption. Liners with a light packing of (silylated) glass wool may improve the performance for CBs, but may cause degradation of some organochlorine compounds like DDT, which are often included in national monitoring programmes.

Recently, other techniques such as temperature-programmed or pressure-programmed injection have become more prominent. They offer additional advantages such as an increased injection volume without the negative effects previously associated with that technique, but should be thoroughly optimised before use. Increasing the injection volume will allow either the elimination of an extra evaporation step or the lowering of the analytical detection limits, or both.

2.9.2 Carrier gas

Hydrogen is the preferred carrier gas and is indispensable for columns with very small inner diameters. Helium is also acceptable and is the standard carrier gas for use with GC-MS techniques.

2.9.3 Columns

Only capillary columns should be used. The following parameters are recommended:

Minimum Length	50 m (for microcolumns of internal diameter <0.1 mm, shorter columns can be suitable).
----------------	--

Maximum internal diameter	0.25 mm. Note that for diameters <0.15 mm the elevated pressure of the carrier gas needs special instrumental equipment as most of the instruments are limited to 400 kPa.
Film thickness	0.2 - 0.4 µm.

Columns which do not fulfil these requirements generally do not offer sufficient resolution to separate CB28, CB105 and CB156 from closely eluting CBs. A wide range of stationary phases can be used for CB separation. The chemical composition is different for columns from different producers and this influences the maximum temperature at which the column can be operated. Further advice may be found in the producers' catalogues, where compositions, applications and tables from which to compare products from different manufacturers are included.

In recent years, new chromatographic phases have become available that result in an improved separation of critical CB pairs. A good example is the HT-8 phase (1,7-dicarba-closo-dodecarborane phenylmethyl siloxane) (Larsen *et al.*, 1995) that shows a remarkable selectivity for CBs (Table 1). This column is currently recommended for CB analysis.

2.9.4 Detection

The electron capture detector (ECD) is still frequently used for CB analysis. Injection of chlorinated solvents or oxygen-containing solvents should be avoided when ECD is used due to the generation of large interfering signals. When using mass selective detectors (MSD), the electron-capture negative-ion chemical ionisation mode (ECNICI) is extremely sensitive for pentachlorinated to decachlorinated CBs, and is approximately ten fold more sensitive than ECD. However, the sensitivity of MS systems has improved considerably, allowing analysis also to be undertaken using electron impact ionisation (EI). Previously, the use of ECNICI was often necessary in order to detect the low concentrations of, in particular, the non-*ortho* CBs. Suggested target and qualifier ions for *ortho* CBs (including mono-*ortho* CBs) are shown in Table 1 and in Table 2 for non-*ortho* CBs.

Next to conventional GC-MS, the use of ion-trap with its tandem MS² option – i.e., yielding improved selectivity – is receiving increased attention. The use of GC-ITMS provides a less expensive alternative to high-resolution mass spectrometry (HRMS), which is commonly used to determine PCDD/Fs and, as such, is also ideally suited for the detection of all CB groups.

Table 1: Example of retention times for selected CB congeners using a 50 m HT8 column (0.25 mm i.d. and 0.25 µm film), along with possible target and qualifier ions. Temperature programme: 80°C, hold for 1 minute, ramp 20°C/minute, to 170 °C, hold 7.5 minutes, ramp 3 °C/minute to 300 °C, hold for 10 minutes.

CB congener	MW	RT	Target Ion	Qualifier Ion	Number of chlorines
¹³C-CB28	270	28.371	268	270	3
CB31	258	28.071	256	258	3
CB28	258	28.388	256	258	3
¹³C-CB52	304	30.317	304	302	4
CB52	292	30.336	292	290	4
CB49	292	30.698	292	290	4
CB44	292	32.024	292	290	4

CB congener	MW	RT	Target Ion	Qualifier Ion	Number of chlorines
CB74	292	34.881	292	290	4
CB70	292	35.199	292	290	4
¹³C-CB101	340	36.612	338	340	5
CB101	326	36.630	326	328	5
CB99	326	37.062	326	328	5
CB97	326	38.267	326	328	5
CB110	326	39.277	326	328	5
CB123*	326	41.2	326	328	5
CB118*	326	41.563	326	328	5
CB105*	326	43.443	326	328	5
CB114*	326	42.2	326	328	5
¹³C-CB153	374	42.567	372	374	6
CB149	362	40.328	360	362	6
CB153	362	42.584	360	362	6
CB132	362	42.236	360	362	6
CB137	362	43.744	360	362	6
¹³C-CB138	374	44.437	372	374	6
CB138	362	44.487	360	362	6
CB158	362	44.663	360	362	6
CB128	362	46.307	360	362	6
¹³C-CB156	374	48.406	372	374	6
CB156*	362	48.366	360	362	6
CB167*	362	46.2	360	362	6
CB157*	362	48.698	360	362	6
¹³C-CB180	408	48.829	406	408	7
CB187	396	44.787	394	396	7
CB183	396	45.264	394	396	7
CB180	396	48.846	394	396	7
CB170	396	50.684	394	396	7
¹³C-CB189	406	53.182	406	408	7
CB189*	396	53.196	394	396	7
¹³C - CB194	442	57.504	442	440	8
CB198	430	50.347	430	428	8
CB194	430	57.514	430	428	8

*mono-ortho CBs

Table 2: Possible target and qualifier ions for non-*ortho* CBs, including labelled internal standards

CB	Target ion (m/z)	Qualifier (m/z)	Qualifier (m/z)	Qualifier (m/z)
¹³ CB81	304	302	NA	NA
CB81	292	290	220	222
¹³ CB77	304	302	NA	NA
CB77	292	290	220	222
¹³ CB126	338	340	NA	NA
CB126	326	328	254	256
¹³ CB169	372	374	NA	NA
CB169	360	362	218	220

2.9.5 Separation, identification and quantification

When using GC-ECD and, to a certain extent, GC-MS, two columns with stationary phases of different polarity should be used, as column-specific co-elution of the target CBs with other CBs or other organochlorine compounds can occur on a single column. Using columns of differing selectivity's can resolve these co-elution problems. The temperature programme used must be optimised for each column to achieve sufficient separation of the CB congeners to be determined. An isothermal period in the programme around 200-220°C of approximately 30 minutes is recommended. Care should be taken that CBs of interest do not coelute with other CB congeners (for example CB28 and CB31). When using GC-ECD, compounds are identified by their retention time in relation to the standard solutions under the same conditions. Therefore GC conditions should be constant. Shifts in retention times should be checked for different areas of the chromatogram by identifying characteristic, unmistakable peaks (*e.g.* originating from the internal standard or higher concentrated CBs such as CB153 and CB138). Using a GC-MS system, the molecular mass or characteristic mass fragments or the ratio of two ion masses can be used to confirm the identity of resolved CBs. Since calibration curves for most CBs are usually non-linear when using GC-ECD, but should be linear when using GC-MS, a multilevel calibration of at least five concentrations is recommended. The calibration curve must be controlled and the best fit must be applied over the relevant concentration range. One should strive to work within the linear range of the detector. Analysis of the calibration solutions should be carried out in a mode encompassing the concentrations of the sample solutions (or alternatively by injecting matrix-containing sample solutions and matrix-free standard solutions distributed regularly over the series). When the chromatogram is processed with the help of automated integrators, the baseline may not always be set unambiguously and always needs to be inspected visually. When using GC-ECD, peak height is preferable to peak area for quantification purposes. From the two columns of different polarity the more reliable result (in terms of absence of co-elutions) should be reported.

Recent years have witnessed the emergence of so-called comprehensive two-dimensional gas chromatography (GC x GC) – a technique that can be used to considerably improve analyte/matrix as well as analyte/analyte separation. Briefly, a non-polar x (semi-)polar column combination is used, with a conventional 25–30 m long first-dimension, and a short, 0.5-1 m long, second-dimension column. The columns are connected via an interface called a modulator. The latter device serves to trap, and focus, each subsequent small effluent fraction from the first-dimension column and, then, to launch it into the second column. The main advantages of the comprehensive approach are that

the entire sample (and not one or a few heart-cuts, as in conventional multidimensional GC (Dallüge *et al.*, 2003) is subjected to a completely different separation, that the two-dimensional separation does not take any more time than the first-dimension run, and that the re-focusing in the modulator helps to increase analyte detectability. The most interesting additional benefit for CBs is, that structurally related as CB congeners show up as so-called ordered structures in the two-dimensional GC x GC plane. The very rapid second-dimension separation requires the use of detectors with sufficiently high data acquisition rates. Initially, only flame ionisation detectors could meet this requirement. However, today there is also a micro-ECD on the market that is widely used for GC x GC- μ ECD of halogenated compound classes. Even more importantly, analyte identification can be performed by using a time-of-flight mass spectrometer (Dallüge *et al.*, 2002) or – with a modest loss of performance, but at a much lower price – one of the very recently introduced rapid-scanning quadrupole mass spectrometers (Korytar *et al.*, 2005; Adahchour *et al.*, 2005). So far, the use of GC x GC has been limited to qualitative applications and still seems inappropriate for routine quantification of analytes.

3 Quality assurance

Planners of monitoring programmes must decide on the accuracy, precision, repeatability, and limits of detection and determination which they consider acceptable. References of relevance to QA procedures include HELCOM, 1988; QUASIMEME 1992; Wells *et al.*, 1992; Oehlenschläger, 1994; Smedes *et al.*, 1994 and ICES, 1996.

3.1 System performance

The performance of the GC system should be monitored by regularly checking the resolution of two closely eluting CBs. A decrease in resolution points to deteriorating GC conditions. The signal-to-noise ratio yields information on the condition of the detector. A dirty ECD detector or MS ion source can be recognised by the presence of an elevated background signal together with a reduced signal-to-noise ratio. Chromatograms should be inspected visually by a trained operator.

3.2 Recovery

The recovery should be checked and reported. One method is to add an internal (recovery) standard to each sample immediately before extraction and a second (quantification) standard immediately prior to injection. If smaller losses occur in extraction or clean-up, or solutions are concentrated by uncontrolled evaporation of solvents (*e.g.* because vials are not perfectly capped), such losses can be compensated for by normalisation. If major losses are recognised and the reasons are unknown, the results should not be reported, as recoveries are likely to be irreproducible. A control for the recovery standard is recommended by adding the calibration solution to a real sample. Recoveries should be between 70 and 120%, if not, analysis of samples should be repeated.

3.3 Blanks

A procedural blank should be measured for each sample series and should be prepared simultaneously using the same chemicals and solvents as for the samples. Its purpose is to indicate sample contamination by interfering compounds, which will lead to errors in quantification. Even if an internal standard has been added to the blank at the beginning of the procedure, a quantification of peaks in the blank and subtraction from the values obtained for the determinands must not be performed, as

the added internal standard cannot be adsorbed by a matrix. An alternative may be using a CB-free oil as a matrix blank.

3.4 Accuracy and precision

Analysis of a Laboratory Reference Material (LRM) should be included, at least one sample within each batch of samples. The LRM must be homogeneous, well characterised for the determinands in question and stability tests must have shown that it produces consistent results over time. The LRM should be of the same type of matrix (*e.g.* liver, muscle tissue, fat or lean fish) as the samples, and the determinant concentrations should occur in a comparable range to those of the samples. If the range of determinant concentrations in the sample is large (greater than a factor of 5) it is preferable to include two reference materials within each batch of analyses to cover the lower and upper concentrations. It is good practice to run duplicate analyses of a reference material to check within-batch analytical variability. A quality control chart should be recorded for a selected set of CBs. When introducing a new LRM or when it is suspected from the control chart that there is a systematic error possibly due to an alteration of the material, a relevant Certified Reference Material (CRM) of a similar matrix to the material analysed should be used to check the LRM. Additionally a duplicate of at least one sample should be run with every batch of samples. Each laboratory should participate in interlaboratory comparison studies and proficiency testing schemes on a regular basis, preferably at an international level.

3.5 Data collection and reporting

The calculation of results and the reporting of data can represent major sources of error. Control procedures should be established in order to ensure that data are correct and to obviate transcription errors. Data stored on databases should be checked and validated, and checks are also necessary when data are transferred between databases. If possible data should be reported in accordance with the latest ICES reporting formats.

4. References

Adahchour, M., Brandt, M., Baier, H-U., Vreuls, R.J.J., Max Batenburg, A. and Brinkman, U.A.Th. 2005. Comprehensive two-dimensional gas chromatography coupled to a rapid-scanning quadrupole mass spectrometer: principles and applications J. Chromatogr. A1067: 245-254.

Becker, P.H., 1989. Seabirds as monitor organisms of contaminants along the German North Sea Coast. Helgoländer Meeresunters. 43: 395-403.

Becker, P.H., 1991. Population and contamination studies in coastal birds: The Common Tern *Sterna hirundo*. In: Perrins, C.M., Lebreton, J.D. and Hiron, G.J.M. (Editors): Bird population studies: relevance to conservation and management. Oxford Univ. Press. Oxford: 433-460.

Becker, P.H., Koepff, C., Heidmann, W.A. and Bütke, A., 1991. Schadstoffmonitoring mit seevögeln. Forschungsbericht UBA-FB 91-081, TEXTE 2/92, Umweltbundesamt, Berlin: 260.

Becker, P.H., Heidmann, W.A., Bütke, A., Frank, D. and Koepff, 1992. Umweltchemikalien in eiern von brütvögeln der deutschen Nordseeküste: Trends 1981-1990. J. Orn. 133: 109-124.

Bignert A., Göthberg, A., Jensen, S., Litzén, K., Odsjö, T., Olsson, M. and Reuthergårdh, L., 1993. The need for adequate biological sampling in ecotoxicological investigations: a retrospective study of twenty years pollution monitoring. Sci. Tot. Environ. 128 121-139.

- Bignert, A., Olsson, M., de Wit, C., Litzén, K., Rappe, C. and Reuthergårdh, L., 1994. Biological variation – an important factor to consider in ecotoxicological studies based on environmental samples. *Fresenius J. Anal. Chem.* 348 76-85.
- Bignert, A., Litzén, K., Odsjö, T., Olsson, M., Persson, W. and Reuthergårdh, L., 1995. Time-related influence the concentrations of DDTs, PCBs and shell parameters in eggs of Baltic Guillemot (*Uria aalge*), 1861-1989. *Environ. Pollut.* 89: 27-36.
- Bligh, E.G. and Dyer, W.J., 1959. A rapid method of total lipid extraction and purification. *Can. J. Biochem. Physiol.* 37: 911-917.
- de Boer, J. and Wells, D.E., 1996. The 1994 QUASIMEME laboratory performance studies: chlorobiphenyls and organochlorine pesticides in fish and sediment. *Mar. Pollut. Bull.* 32: 654-666.
- Dallüge, J., Beens, J. and Brinkman, U.A.Th. 2003 Comprehensive two-dimensional gas chromatography: a powerful and versatile analytical tool *J. Chromatogr.*, 1000: 69-108.
- Dallüge, J., Vreuls, R.J.J., Beens, J. and Brinkman, U.A.Th. 2002 Optimization and characterization of comprehensive two-dimensional gas chromatography with time-of-flight mass spectrometric detection (GC×GC-TOF MS) *J. Sep. Sci.*, 25: 201-214.
- Gilbert, R.O., 1987. *Statistical Methods for Environmental Pollution Monitoring*. Van Nostrand Reinhold, New York.
- Gilbertson, M., Elliott, J.E. and Peakall, D.B., 1987. Seabirds as indicators of marine pollution. In: Diamond, A.W. and Filion, F.L. (Editors): *The value of birds*. ICBP Technical Publication 6: 231-248.
- Hanson, S. W. F. and Olley, J. 1963. Application of the Bligh and Dyer method of lipid extraction to tissue homogenates. *Biochem. J.*, 89: 101–102.
- HELCOM, 1988. Guidelines for the Baltic Monitoring Programme for the Third Stage (1988). Part C: Contents from Balt. Sea Environ. Proc. No. 27 C, HELCOM, Helsinki.
- ICES, 1996. Guidelines on Quality Assurance of Chemical Measurements in the Baltic Sea. In Report of the ICES/HELCOM Steering Group on Quality Assurance of Chemical Measurements in the Baltic Sea, pp. 10-28. ICES C.M. 1996/E: 4.
- Iyengar, G., 1976. Homogenised sampling of bone and other biological materials. *Radiochem. Radioanal. Letters* 24: 35.
- Iyengar, G.V. and Kasperek, K., 1977. Application of the brittle fracture technique (BFT) to homogenise biological samples and some observations regarding the distribution behaviour of trace elements at different concentration levels in a biological matrix. *J. Radioanal. Chem.* 39: 301-316.
- Klussmann, U., Strupp, D. and Ebing, W., 1985. Entwicklung einer apparatur zur homogenisierung von tiefgekühlten pflanzenproben. *Fresenius Z. Anal. Chem.* 322: 456.
- Korytar, P., Parera, J., Leonards, P.E.G., de Boer, J. and Brinkman, U.A.Th. 2005 Quadrupole mass spectrometer operating in the electron-capture negative ion mode as detector for comprehensive two-dimensional gas chromatography *J. Chromatogr. A* 1067: 255-264
- Larsen, B., Cont, M., Montanarella, L. and Platzner N., 1995. Enhanced selectivity in the analysis of chlorobiphenyls on a carborane phenylmethylsiloxane copolymer gas chromatography phase (HT-8) *J. Chromatogr. A* 708:115-129.

Nicholson, M.D. and Fryer, R.J., 1996. Contaminants in marine organisms: Pooling strategies for monitoring mean concentrations. Tech. Mar. Environ. Sci., No. 18. ICES. Copenhagen, 30.

Nicholson, M.D., Fryer, R.J. and Larsen, J.R., 1997. A robust method for analysing contaminant trend monitoring data. ICES Techniques in Marine Environmental Sciences, No. 20. 12.

Oehlenschläger, J., 1994: Quality assurance during sampling on board. In: Topping, G. and Harms, U. (Editors): ICES/HELCOM Workshop on Quality Assurance of Chemical Analytical Procedures for the Baltic Monitoring Programme, 5-8 Oct. 1993, Hamburg, Germany. HELCOM, Balt. Sea Environ. Proc. No. 58, 82-84.

QUASIMEME, 1992. Guidelines on Quality Assurance for Marine Measurements. Prepared by Topping, G., Wells, D.E. and Griepink, B. SOAFD Marine Laboratory, Aberdeen, Scotland.

QUASIMEME, 1994. Report on the Proceedings of a Workshop on: The Measurement of Lipids as a Co-factor for organic contaminants in Biota. Dublin, 13-16 October 1994. Prepared by Bailey, S. and Wells, D.E., SOAFD Marine Laboratory, Aberdeen, Scotland.

QUASIMEME, 2007. QUASIMEME Workshop on the Analysis of Brominated Flame Retardants, VU University, Institute for Environmental Studies, Amsterdam, the Netherlands, 23 – 24 April 2007.

Ramos, L., Kristenson, E. M. and Brinkman, U. A. Th., 2002. Current use of pressurised liquid extraction and subcritical water extraction in environmental analysis. J. Chromatogr. A, 975: 3-29.

Roose, P. and Brinkman, U. A. Th., 2005. Monitoring organic microcontaminants in the marine environment: principles, programmes and progress TrAC, 24: 897-926

Roose, P., Haarich, M., Nixon, E. and Abarnou, A., 1996. Lipids as a co-factor. ICES CM 1996/Env: 2 Ref. E: 22-25.

Smedes, F. 1999. Determination of total lipid using non-chlorinated solvents. Analyst, 124: 1711-1718.

Smedes, F. and de Boer, J., 1994. Guidelines for the determination of chlorobiphenyls in sediments. Quimica Analytica 13: 100-108.

Sporring, S., Wiberg, K., Bjorklund, E. and Haglund, P. 2003. Combined extraction/clean-up strategies for fast determination of PCDD/Fs and WHO PCBs in food and feed samples using accelerated solvent extraction, Organohalogen Compounds, 60-65, Dioxin 2003, Boston. Tema Nord, 1995. Manual for Nordic Environment Specimen Banking.

Walker, C.H., 1992. The exotoxicology of persistent pollutants in marine fish-eating birds. In: Walker, C.H. and Livingstone, D.R. (Editors): Persistent pollutants in marine ecosystems: 211-232, Pergamon Press, Oxford, New York, Seoul, Tokyo.

Wells, D.E., Maier, E.A. and Griepink, B., 1992. Calibrants and calibration for chlorobiphenyl analysis. Intern. Environ. Anal. Chem. 46, 255-264.

Annex XII:

HELCOM

**Manual for marine monitoring in the COMBINE programme
ANNEX B-12, APPENDIX 2. TECHNICAL NOTE ON THE DETERMINATION OF
POLYCYCLIC AROMATIC HYDROCARBONS IN BIOTA**

HELCOM Manual for marine monitoring in the COMBINE programme

ANNEX B-12, APPENDIX 2. TECHNICAL NOTE ON THE DETERMINATION OF POLYCYCLIC AROMATIC HYDROCARBONS IN BIOTA

1. INTRODUCTION

Polycyclic aromatic hydrocarbons (PAHs) consist of a variable number of fused aromatic rings. By definition, PAHs contain at least three fused rings, although in practice related compounds with two fused rings (such as naphthalene and its alkylated derivatives) are often determined and will be considered in these guidelines. PAHs arise from incomplete combustion processes and from both natural and anthropogenic sources, although the latter generally predominate. PAHs are also found in oil and oil products, and these include a wide range of alkylated PAHs formed as a result of diagenetic processes, whereas PAHs from combustion sources comprise mainly parent (non-alkylated) PAHs. PAHs are of concern in the marine environment for two main reasons: firstly, low-molecular weight (MW) PAHs can be directly toxic to marine animals; secondly, metabolites of some of the high-MW PAHs are potent animal and human carcinogens, benzo[a]pyrene is the prime example. Carcinogenic activity is closely related to structure, however, and benzo[e]pyrene and four benzofluoranthene isomers (all six compounds have a molecular weight of 252 Da) are much less potent. Some compounds (e.g., heterocyclic compounds containing sulphur, such as benzothiophenes and dibenzo-thiophenes) may also cause taint in commercially exploited fish and shellfish and render them unfit for sale. PAHs are readily taken up by marine animals both across gill surfaces and from their diet, and may bioaccumulate, particularly in shellfish. Filter-feeding organisms such as bivalve molluscs can accumulate high concentrations of PAHs, both from chronic discharges to the sea (e.g., of sewage) and following oil spills. Fish are exposed to PAHs both via uptake across gill surfaces and from their diet, but do not generally accumulate high concentrations of PAHs as they possess an effective mixed-function oxygenase (MFO) system which allows them to metabolize PAHs and to excrete them in bile. An assessment of the exposure of fish to PAHs therefore requires also the determination of PAH-metabolite concentrations in bile samples, as turnover times can be extremely rapid. Thus, the analysis of PAHs in fish muscle tissue should normally only be undertaken for food quality assurance purposes (Law and Biscaya, 1994).

There are marked differences in the behaviour of PAHs in the aquatic environment between the low-MW compounds (such as naphthalene; 128 Da) and the high-MW compounds (such as benzo[ghi]perylene; 276 Da) as a consequence of their differing physico-chemical properties. The low-MW compounds are appreciably water soluble and can be bioaccumulated from the "dissolved" phase by transfer across gill surfaces, whereas the high-MW compounds are relatively insoluble and hydrophobic, and can attach to both organic and inorganic particulates within the water column. PAHs derived from combustion sources may actually be deposited to the sea already adsorbed to atmospheric particulates, such as soot particles. The majority of PAHs in the water column will eventually be either taken up by biota or transported to the sediments, and deep-water depositional areas may generally be regarded as sinks for PAHs, particularly when they are anoxic.

2. APPROPRIATE SPECIES FOR ANALYSIS OF PAHS

2.1 Benthic fish and shellfish

All teleost fish have the capacity for rapid metabolism of PAHs, thereby limiting their usefulness for monitoring temporal or spatial trends of PAHs. Shellfish (particularly molluscs) generally

have a lesser metabolic capacity towards PAHs, and so they are preferred because PAH concentrations are generally higher in their tissues.

For the purposes of temporal trend monitoring, it is essential that long time series with either a single species or a limited number of species are obtained. Care should be taken that the sample is representative of the population and that sampling can be repeated annually. There are advantages in the use of molluscs for this purpose as they are sessile, and so reflect the degree of contamination in the local area to a greater degree than fish which are mobile. The analysis of fish tissues is often undertaken in conjunction with biomarker and disease studies, and associations have been shown between the incidence of some diseases (e.g., liver neoplasia) in flatfish and the concentrations of PAHs in the sediments over which they live and feed (Malins et al., 1988; Vethaak and Rheinallt, 1992). The exposure of fish to PAHs can be assessed by the analysis of PAH-metabolites in bile, and by measuring the induction of mixed-function oxygenase enzymes which affect the formation of these metabolites. At offshore locations, the collection of appropriate shellfish samples may be problematic if populations are absent, sparse or scattered, and the collection of fish samples may be simpler. Generally, the analysis of PAHs in fish muscle tissue should only be considered for the purposes of food quality assurance.

Recent monitoring studies have indicated a seasonal cycle in PAH concentrations (particularly for combustion-derived PAHs) in mussels, with maximum concentrations in the winter prior to spawning and minimum concentrations in the summer. It is particularly important, therefore, that samples selected for trend monitoring and spatial comparisons are collected at the same time of year, and preferably in the first months of the year before spawning.

2.2 Fish

Fish are not recommended for spatial or temporal trend monitoring of PAHs, but can be useful as part of biological effects studies or for food quality assurance purposes. The sampling strategy for biological effects monitoring is described in the OSPAR Joint Assessment and Monitoring Programme (JAMP).

3. TRANSPORTATION

Live mussels should be transported to the laboratory for sample preparation. They should be transported in closed containers at temperatures between 5 °C and 15 °C, preferably below 10 °C. For live animals it is important that the transport time is short and controlled (e.g., maximum of 24 hours).

Fish samples should be kept cool or frozen (at a temperature of -20 °C or lower) as soon as possible after collection. Frozen fish samples should be transported in closed containers at temperatures below -20 °C. If biomarker determinations are to be made, then it will be necessary to store tissue samples at lower temperatures, for example, in liquid nitrogen at -196 °C.

4. PRETREATMENT AND STORAGE

4.1 Contamination

Sample contamination may occur during sampling, sample handling, pretreatment and analysis, due to the environment, the containers or packing materials used, the instruments used during sample preparation, and from the solvents and reagents used during the analytical procedures. Controlled conditions are therefore required for all procedures, including the dissection of fish organs on-board a ship (see ANNEX B-13, Appendix 1). In the case of PAHs, particular care must be taken to avoid contamination at sea. On ships there are multiple sources of PAHs, such as the

oils used for fuel and lubrication, and the exhaust from the ship's engines. It is important that the likely sources of contamination are identified and steps taken to preclude sample handling in areas where contamination can occur. A ship is a working vessel and there can always be procedures occurring as a result of the day-to-day operations (deck cleaning, automatic overboard bilge discharges, etc.) which could affect the sampling process. One way of minimizing the risk is to conduct dissection in a clean area, such as within a laminar-flow hood away from the deck areas of the vessel. It is also advisable to collect samples of the ship's fuel, bilge water, and oils and greases used on winches, etc., which can be used as fingerprinting samples at a later date, if there are suspicions of contamination in particular instances.

4.2 Shellfish

4.2.1 Depuration

Depending upon the situation, it may be desirable to depurate shellfish so as to void the gut contents and any associated contaminants before freezing or sample preparation. This is usually applied close to point sources, where the gut contents may contain significant quantities of PAHs associated with food and sediment particles which are not truly assimilated into the tissues of the mussels. Depuration should be undertaken under controlled conditions and in filtered sea water; depuration over a period of 24 hours is usually sufficient. The aquarium should be aerated and the temperature and salinity of the water should be similar to that from which the animals were removed.

4.2.2 Dissection and storage

When samples are processed, both at sea and onshore, the dissection must be undertaken by trained personnel on a clean bench wearing clean gloves and using clean stainless steel knives and scalpels. Stainless steel tweezers are recommended for holding tissues during dissection. After each sample has been prepared, all tools and equipment (such as homogenizers) should be cleaned.

4.3 Fish

4.3.1 Dissection and storage

The dissection of fish muscle and internal organs should be carried as soon as possible after collection. The details of fish muscle and liver dissection are given in ANNEX B-13, Appendix 1. If possible, the entire right side dorsal lateral fillet should be homogenized and sub samples taken for replicate PAH determinations. If, however, the amount of material to be homogenized would be too large, a specific portion of the dorsal musculature should be chosen. It is recommended that the portion of the muscle lying directly under the first dorsal fin is used in this case.

When dissecting the liver, care should be taken to avoid contamination from the other organs. If bile samples are to be taken for PAH-metabolite determinations, then they should be collected first. If the whole liver is not to be homogenized, a specific portion should be chosen in order to ensure comparability. Freeze-drying of tissue samples cannot be recommended for PAH determination, due to the contamination which may result from back-streaming of oil from the rotary pumps used to generate the vacuum.

If plastic bags or boxes are used, then they should be used as outer containers only, and should not come into contact with tissues. Organ samples (e.g., livers) should be stored in pre-cleaned containers made of glass, stainless steel or aluminium, or should be wrapped in pre-cleaned aluminium foil and shock-frozen quickly in liquid nitrogen or in a blast freezer. In the latter case, care should be taken that the capacity of the freezer is not exceeded (Law and de Boer,

1995). Cold air should be able to circulate between the samples in order that the minimum freezing time can be attained (maximum 12 hours). The individual samples should be clearly and indelibly labelled and stored together in a suitable container at a temperature of -20 °C until analysis. If the samples are to be transported during this period (e.g., from the ship to the laboratory), then arrangements must be made which ensure that the samples do not thaw out during transport. Sub samples for biomarker determinations should be collected immediately after death in order to minimize post-mortem changes in enzymatic and somatic activities, and stored in suitable vials in liquid nitrogen until analysis.

When samples are processed, both at sea and onshore, the dissection must be undertaken by trained personnel on a clean bench wearing clean gloves and using clean stainless steel knives and scalpels. Stainless steel tweezers are recommended for holding tissues during dissection. After each sample has been prepared, all tools and equipment (such as homogenizers) should be cleaned.

When pooling of tissues is necessary, an equivalent quantity of tissue should be taken from each fish, e.g., 10 % from each whole fillet.

5. ANALYSIS

5.1 Preparation of materials

Solvents, reagents, and adsorptive materials must be free of PAHs and other interfering compounds. If not, then they must be purified using appropriate methods. Reagents and absorptive materials should be purified by solvent extraction and/or by heating in a muffle oven, as appropriate. Glass fibre materials (e.g., Soxhlet thimbles) are preferred over filter papers and should be cleaned by solvent extraction. It should be borne in mind that clean materials can be re-contaminated by exposure to laboratory air, particularly in urban locations, and so storage after cleaning is of critical importance. Ideally, materials should be prepared immediately before use, but if they are to be stored, then the conditions should be considered critically. All containers which come into contact with the sample should be made of glass, and should be pre-cleaned before use. Appropriate cleaning methods would include washing with detergents, rinsing with water, and finally solvent-rinsing immediately before use. Heating of glassware in an oven (e.g., at 400°C for 24 hours) can also be useful in removing PAH contamination.

5.2 Lipid determination

Although PAH data are not usually expressed on a lipid basis, the determination of the lipid content of tissues can be of use in characterizing the samples. The lipid content should be determined on a separate subsample of the tissue homogenate, as some of the extraction techniques used routinely for PAH determination (e.g., alkaline saponification) destroy lipid materials. The total fat weight should be determined using the method of Smedes (1999) or an equivalent method.

5.3 Dry weight determination

Generally PAH data are expressed on a wet weight basis, but sometimes it can be desirable to consider them on a dry weight basis. Again, the dry weight determination should be conducted on a separate sub sample of the tissue homogenate, which should be air-dried to constant weight at 105 °C.

5.4 Extraction and clean-up

PAHs are lipophilic and so are concentrated in the lipids of an organism, and a number of methods have been described for PAH extraction (see, e.g., Ehrhardt *et al.*, 1991). The preferred methods generally utilize either Soxhlet extraction, or alkaline digestion followed by liquid-liquid extraction with an organic solvent. Microwave-assisted solvent extraction can be mentioned as one of the modern techniques being applied to PAH analysis (Budzinski *et al.*, 2000; During and Gaath, 2000; Vázquez Blanco *et al.*, 2000; Ramil Criado *et al.*, 2002). In the case of Soxhlet extraction, the wet tissue must be dried by mixing with a chemical agent (e.g., anhydrous sodium sulphate), in which case a time period of several hours is required between mixing and extraction in order to allow complete binding of the water in the sample. Alkaline digestion is conducted on wet tissue samples, so this procedure is unnecessary. In neither case can the freeze-drying of the tissue prior to extraction be recommended, owing to the danger of contamination from oil back-streaming from the rotary pump (which provides the vacuum) into the sample. Non-polar solvents alone will not effectively extract all the PAHs from tissues when using Soxhlet extraction, and mixtures such as hexane/dichloromethane may be effective in place of solvents such as benzene and toluene, used historically for this purpose. Alkaline digestion has been extensively used in the determination of PAHs and hydrocarbons and is well documented. It is usually conducted in alcohol (methanol or ethanol), which should contain at least 10 % water, and combines disruption of the cellular matrix, lipid extraction and saponification within a single procedure, thereby reducing sample handling and treatment. For these reasons, it should be the method of choice. Solvents used for liquid-liquid extraction of the homogenate are usually non-polar, such as pentane or hexane, and they will effectively extract all PAHs.

Tissue extracts will always contain many compounds other than PAHs, and a suitable clean-up is necessary to remove those compounds which may interfere with the subsequent analysis. Different techniques may be used, both singly or in combination, and the choice will be influenced by the selectivity and sensitivity of the final measurement technique and also by the extraction method employed. If Soxhlet extraction was used, then there is a much greater quantity of residual lipid to be removed before the analytical determination can be made than in the case of alkaline digestion. An additional clean-up stage may therefore be necessary. The most commonly used clean-up methods involve the use of alumina or silica adsorption chromatography, but gel permeation chromatography and similar high performance liquid chromatography (HPLC) based methods are also employed (Nondek *et al.*, 1993; Nyman *et al.*, 1993; Perfetti *et al.*, 1992). The major advantages of using HPLC-based clean-up methods are their ease of automation and reproducibility.

5.5 Pre-concentration

The sample volume should be 2 cm³ or greater to avoid errors when transferring solvents during the clean-up stages. Evaporation of solvents using a rotary-film evaporator should be performed at low temperature (water bath temperature of 30 °C or lower) and under controlled pressure conditions, in order to prevent losses of the more volatile PAHs such as naphthalenes. For the same reasons, evaporation to dryness should be avoided. When reducing the sample to final volume, solvents can be removed by a stream of clean nitrogen gas. Suitable solvents for injection into the gas chromatograph (GC) or GC-MS include pentane, hexane, heptane and *iso*-octane, whereas for HPLC analyses acetonitrile and methanol are commonly used.

5.6 Selection of PAHs to be determined

The choice of PAHs to be analysed is not straightforward, both because of differences in the range of PAH compounds resulting from combustion processes and from oil and oil products, and also because the aims of specific monitoring programmes can require the analysis of different representative groups of compounds. PAHs arising from combustion processes are predominantly parent (unsubstituted) compounds, whereas oil and its products contain a much

wider range of alkylated compounds in addition to the parent PAHs. This has implications for the analytical determination, as both HPLC-based and GC-based techniques are adequate for the determination of a limited range of parent PAHs in samples influenced by combustion processes, whereas in areas of significant oil contamination and following oil spills only GC-MS has sufficient selectivity to determine the full range of PAHs present. The availability of pure individual PAHs for the preparation of standards is problematic and limits both the choice of determinands and, to some degree, the quantification procedures which can be used. The availability of reference materials certified for PAHs is also rather limited. A list of target parent and alkylated PAHs suitable for environmental monitoring is given in Table 1. In both cases, the list was concentrated on a subset of parent (predominantly combustion-derived) PAHs due to analytical limitations. This approach completely neglects the determination of alkylated PAHs, which allows the interpretation of PAH accumulation from multiple sources including those due to oil inputs. It will not be necessary for all of these PAH compounds and groups to be analysed in all cases, but an appropriate selection can be made from this list depending on the specific aims of the monitoring programme to be undertaken.

Table 1: Compounds of interest for environmental monitoring for which the guidelines apply			
Compound	MW	Compound	MW
Naphthalene	128	C2-Phenanthrenes/Anthracenes	206
C1-Naphthalenes	142	C3-Phenanthrenes/Anthracenes	220
C2-Naphthalenes	156	Fluoranthene	202
C3-Naphthalenes	170	Pyrene	202
C4-Naphthalenes	184	C1-Fluoranthenes/Pyrenes	216
Acenaphthylene	152	C2-Fluoranthenes/Pyrenes	230
Acenaphthene	154	Benz[a]anthracene	228
Biphenyl	154	Chrysene	228
Fluorene	166	2,3-Benzanthracene	228
C1-Fluorenes	180	Benzo[a]fluoranthene	252
C2-Fluorenes	194	Benzo[b]fluoranthene	252
C3-Fluorenes	208	Benzo[j]fluoranthene	252
Dibenzothiophene	184	Benzo[k]fluoranthene	252
C1-Dibenzothiophenes	198	Benzo[e]pyrene	252
C2-Dibenzothiophenes	212	Benzo[a]pyrene	252
C3-Dibenzothiophenes	226	Perylene	252
Phenanthrene	178	Indeno[1,2,3-cd]pyrene	276
Anthracene	178	Benzo[ghi]perylene	276
C1-Phenanthrenes/ Anthracenes	192	Dibenz[ah]anthracene	278

5.7 Instrumental determination of PAHs

Unlike the situation for chlorobiphenyls (CBs), where GC techniques (particularly GC-ECD) are used exclusively, two major approaches based on GC and HPLC are followed to an equal extent in the analysis of PAHs. The greatest sensitivity and selectivity in routine analyses are achieved by combining HPLC with fluorescence detection (HPLC-UVF) and capillary gas chromatography with mass spectrometry (GC-MS). In terms of flexibility, GC-MS is the most capable technique, as in principle it does not limit the selection of determinands in any way, while HPLC is suited only to the analysis of parent PAHs. In the past, analyses have also been conducted using HPLC with UV-absorption detection and GC with flame-ionization detection, but neither can be recommended because of their relatively poor selectivity.

Intercomparison exercises have demonstrated a serious lack of comparability between specific hydrocarbon concentrations measured in different laboratories and using both analytical approaches described above (Farrington *et al.*, 1986). An interlaboratory performance study has been carried out within the QUASIMEME laboratory testing scheme in order to assess the level of comparability among laboratories conducting PAH analyses and to identify improvements in methodology (Law and Klungsøyr, 1996; Law *et al.*, 1998, QUASIMEME). Limits of determination within the range of 0.2 to 10 µg kg⁻¹ wet weight for individual PAH compounds should be achievable by both GC-MS and HPLC-UVF techniques.

5.8 HPLC

Reversed-phase columns (e.g., octadecylsilane (RP-18)) 15–30 cm in length are used almost exclusively, in conjunction with gradient elution using mixtures of acetonitrile/water or methanol/water. A typical gradient may start as a 50 % mixture, changing to 100 % acetonitrile or methanol in 40 minutes. This flow is maintained for 20 minutes, followed by a return to the original conditions in 5 minutes and 5–10 minutes' equilibration before the next injection. The use of an automatic injector is strongly recommended. Also, the column should be maintained in a column oven heated to 10–30°C. The systems yielding the best sensitivity and selectivity utilize fluorescence detection. As different PAH compounds yield their maximum fluorescence at different wavelengths, for optimum detection of PAHs the wavelengths of the detector should be programmed so that the excitation/emission wavelengths detected are changed at pre-set times during the analytical determination. For closely eluting peaks, it may be necessary to use two detectors in series utilizing different wavelength pairs, or to affect a compromise in the selected wavelengths if a single detector is used. As the fluorescence signals of some PAHs (e.g., pyrene) are quenched by oxygen, the eluents must be degassed thoroughly. This is usually achieved by continuously bubbling a gentle stream of helium through the eluent reservoirs, but a vacuum degasser can also be used. Polytetrafluorethylene (PTFE) tubing must not then be used downstream of the reservoirs as this material is permeable to oxygen; stainless steel or polyether-etherketone (PEEK) tubing is preferred.

5.9 GC-MS

The two injection modes commonly used are splitless and on-column injection. Automatic sample injection should be used wherever possible to improve the reproducibility of injection and the precision of the overall method. If splitless injection is used, the liner should be of sufficient capacity to contain the injected solvent volume after evaporation. For PAH analysis, the cleanliness of the liner is also very important if adsorption effects and discrimination are to be avoided, and the analytical column should not contain active sites to which PAHs can be adsorbed. Helium is the preferred carrier gas, and only capillary columns should be used. Because of the wide boiling range of the PAHs to be determined and the surface-active properties of the higher PAHs, the preferred column length is 25–30 m, with an internal diameter of 0.15 mm to 0.3 mm. Film thicknesses of 0.3 µm to 1 µm are generally used; this choice has little impact on critical resolution, but thicker films are often used when one-ring aromatic compounds are to be determined alongside PAHs, or where a high sample loading is

needed. No stationary phase has been found on which all PAH isomers can be resolved; the most commonly used stationary phase for PAH analysis is 5 % phenyl methylsilicone (DB-5 or equivalent). This will not, however, resolve critical isomers such as benzo[*b*], [*j*] and [*k*]fluoranthenes, or chrysene from triphenylene. These separations can be made on other columns, if necessary. For PAHs there is no sensitivity gain from the use of chemical ionization (either positive or negative ion), so analyses are usually conducted in electron-impact mode at 70 eV. The choice of full-scan or multiple-ion detection is usually made in terms of sensitivity. Some instruments such as ion-trap mass spectrometers exhibit the same sensitivity in both modes, so full-scan spectra are collected, whereas for quadrupole instruments greater sensitivity is obtained if the number of ions scanned is limited. In that case, the masses to be detected are programmed to change during the analysis as different PAHs elute from the capillary column.

6. CALIBRATION AND QUANTIFICATION

6.1 Standards

A range of fully deuterated parent PAHs is available for use as standards in PAH analysis. The availability of pure PAH compounds is limited (Annex B-7). Although most of the parent compounds can be purchased as pure compounds, the range of possible alkyl-substituted PAHs is vast and only a limited selection of them can be obtained. In HPLC, where the resolving power of the columns is limited and the selectivity less than that which can be obtained using MS detection, only a single internal standard is normally used (e.g., phenanthrene-d10), although fluoranthene-d10 and 6-methyl chrysene, among others, have also been used. If GC-MS is used, then a wider range of deuterated PAHs can be utilized, both because of the wide boiling range of PAHs present and because that allows the use of both recovery and quantification standards. Suitable standards could range from naphthalene-d8 to perylene-d10. It is always recommended to use at least two and preferably three internal standards of hydrocarbons of small, medium, and high molecular weight (e.g., naphthalene-d8, phenanthrene-d10, perylene-d12). Crystalline PAHs of known purity should be used for the preparation of calibration standards. If the quality of the standard materials is not guaranteed by the producer or supplier (as for certified reference materials), then it should be checked by GC-MS analysis. Solid standards should be weighed to a precision of 10⁻⁵ grams. Calibration standards should be stored in the dark because some PAHs are photosensitive, and ideally solutions to be stored should be sealed in amber glass ampoules. Otherwise, they can be stored in a refrigerator in stoppered measuring cylinders or flasks that are gas tight to avoid evaporation of the solvent during storage.

6.2 Calibration

Multilevel calibration with at least five calibration levels is preferred to adequately define the calibration curve. In general, GC-MS calibration is linear over a considerable concentration range but exhibits non-linear behaviour when the mass of a compound injected is low due to adsorption. Quantification should be conducted in the linear region of the calibration curve, or the non-linear region must be well characterized during the calibration procedure. For HPLC-UVF, the linear range of the detection system should be large, and quantification should be made within the linear range. External standardization is often used with HPLC due to the relatively limited resolution obtainable with this technique as generally employed.

6.3 Recovery

The recovery of analytes should be checked and reported. Given the wide boiling range of the PAHs to be determined, the recovery may vary with compound group, from the volatile PAHs of low molecular weight to the larger compounds. For GC-MS analysis, deuterated standards can

be added in two groups: those to be used for quantification are added at the start of the analytical procedure, whilst those from which the absolute recovery will be assessed are added prior to GC-MS injection. This ensures that the calculated PAH concentrations are corrected for the recovery obtained in each case. In the case of HPLC, where only a single deuterated PAH standard is used, it is more common to assess recovery periodically by carrying a standard solution through the whole analytical procedure, then assessing recovery by reference to an external standard. This technique does not, however, correct for matrix effects, and so may be used in conjunction with the spiking of real samples.

7. ANALYTICAL QUALITY CONTROL

Planners of monitoring programmes must decide on the accuracy, precision, repeatability, and limits of detection and determination which they consider acceptable. Achievable limits of determination for each individual component are as follows:

- for GC-MS measurements: 0.2 µg kg⁻¹ ww;
- for HPLC measurements: 0.5–10 µg kg⁻¹ ww.

Further information on analytical quality control procedures for PAHs can be found elsewhere (Law and de Boer, 1995). A procedural blank should be measured with each sample batch, and should be prepared simultaneously using the same chemical reagents and solvents as for the samples. Its purpose is to indicate sample contamination by interfering compounds, which will result in errors in quantification. The procedural blank is also very important in the calculation of limits of detection and limits of quantification for the analytical method. In addition, a laboratory reference material (LRM) should be analysed within each sample batch. Test materials from the former runs of QUASIMEME Laboratory Proficiency Testing can be used as Laboratory Reference Material. The LRM must be homogeneous and well characterized for the determinands of interest within the analytical laboratory. Ideally, stability tests should have been undertaken to show that the LRM yields consistent results over time. The LRM should be of the same matrix type (e.g., liver, muscle, mussel tissue) as the samples, and the determinand concentrations should be in the same range as those in the samples. Realistically, and given the wide range of PAH concentrations encountered, particularly in oil spill investigations, this is bound to involve some compromise. The data produced for the LRM in successive sample batches should be used to prepare control charts. It is also useful to analyse the LRM in duplicate from time to time to check within-batch analytical variability. The analysis of an LRM is primarily intended as a check that the analytical method is under control and yields acceptable precision, but a certified reference material (CRM) of a similar matrix should be analysed periodically in order to check the method bias. The availability of biota CRMs certified for PAHs is very limited (Annex B-7; QUASIMEME), and in all cases the number of PAHs for which certified values are provided is small. At regular intervals, the laboratory should participate in an intercomparison or proficiency exercise in order to provide an independent check on the performance.

8. DATA REPORTING

The calculation of results and the reporting of data can represent major sources of error, as has been shown in intercomparison studies for PAHs. Control procedures should be established in order to ensure that data are correct and to obviate transcription errors. Data stored in databases should be checked and validated, and checks are also necessary when data are transferred between databases. Data should be reported in accordance with the latest ICES reporting formats.

9. REFERENCES

- Vázquez Blanco, E., López Mahía, P., Muniategui Lorenzo, S., Prada Rodríguez, D., and Fernández Fernández, E. 2000. Optimization of microwave-assisted extraction of hydrocarbons in marine sediments: comparison with the Soxhlet extraction method. *Fresenius Journal of Analytical Chemistry*, 366: 283–288.
- Budzinski, H. 2000. Combined protocol for analysis of PAHs and PCBs from sediments using focused microwave assisted (FMW) extraction at atmospheric pressure. *Fresenius Journal of Analytical Chemistry*, 367: 165–171.
- During, R.A., and Gaath, S. 2000. Microwave assisted methodology for the determination of organic pollutants in organic municipal wastes and soils: extraction of PCBs using heat transformer discs. *Fres. J. Anal.Chem.*, 368: 684–688.
- Ehrhardt, M., Klungsøyr, J., and Law, R.J. 1991. Hydrocarbons: Review of methods for analysis in sea water, biota, and sediments. *Techniques in Marine Environmental Sciences*, 12: 19–22.
- Farrington, J.W., Davis, A.C., Livramento, J.B., Clifford, C.H., Frew, N.M., and Knap, A. 1986. ICES/IOC Intercomparison Exercises on the Determination of Petroleum Hydrocarbons in Biological Tissues (mussel homogenate) - ICES (2/HC/BT). ICES Cooperative Research Report, 141: 1–75.
- Law, R.J., and Biscaya, J.L. 1994. Polycyclic aromatic hydrocarbons (PAHs)—Problems and progress in sampling, analysis and interpretation. *Marine Pollution Bulletin*, 29: 235–241.
- Law, R.J., and de Boer, J. 1995. Quality assurance of analysis of organic compounds in marine matrices: Application to analysis of chlorobiphenyls and polycyclic aromatic hydrocarbons. *In Quality Assurance in Environmental Monitoring—Sampling and Sample Pretreatment*, pp. 129–156. Ed. by P. Quevauviller. VCH Publishers, Weinheim, Germany.
- Law, R.J., Fileman, T.W., and Portmann, J.E. 1988. Methods of analysis for hydrocarbons in marine samples. *Aquatic Environment Protection: Analytical Methods*. MAFF Directorate of Fisheries Research, Lowestoft, UK. (2). 25 pp.
- Law, R.J., and Klungsøyr, J. 1996. The 1994 QUASIMEME laboratory-performance studies: Polycyclic aromatic hydrocarbons (PAHs) in standard solutions. *Marine Pollution Bulletin*, 32: 667–673.
- Law, R.J., Klungsøyr, J., and Freriks, I.L. 1998. The QUASIMEME interlaboratory testing scheme for polycyclic aromatic hydrocarbons (PAHs): assessment of the first three rounds, 1994–1995. *Marine Pollution Bulletin*, 35: 64–77.
- Law, R.J., and Nicholson, M.D. 1995. Report on the results of the Intercomparison Programme on the Analysis of PAHs in Marine Media—Stage 1. ICES Cooperative Research Report, 207: 52–104.
- Malins, D.C., McCain, B.B., Landahl, J.T., Myers, M.S., Krahn, M.M., Brown, D.W., Chan, S.-L., and Roubal, W.T. 1988. Neoplastic and other diseases in fish in relation to toxic chemicals: an overview. *Aquatic Toxicology*, 11:43–67.
- Nondek, L., Kuziiek, M., and Krupicka, S. 1993. LC clean-up and GC-MS analysis of polycyclic aromatic hydrocarbons in river sediment. *Chromatographia*, 37: 381–391.
- Nyman, P.J., Perfetti, G.A., Joe, F.L. jr., and Diachenko, G.W. 1993. Comparison of two clean-up methodologies for the gas chromatographic-mass spectrometric detection of low nanogram per gram levels of polynuclear aromatic hydrocarbons in seafood. *Food Additives and Contaminants*, 10: 489–501.
- Perfetti, G.A., Nyman, P.J., Fisher, S., Joe, F.L. jr., and Diachenko, G.W. 1992. Determination of polynuclear aromatic hydrocarbons in seafood by liquid chromatography with fluorescence detection. *Journal of the Association of Official Analytical Chemists*, 75: 872–877.
- QUASIMEME. www.quasimeme.marlab.ac.uk
- Ramil Criado M. 2002. Optimization of microwave-assisted extraction method for the analysis of PCBs in ash samples. *Journal of Chromatography A*, 1: 1–9.
- Smedes, F. 1999. Determination of total lipid using non-chlorinated solvents. *The Analyst*, 124: 1711–1718.

- Vethaak, A.D., and Rheinallt, T. 1992. Fish disease as a monitor for marine pollution: the case of the North Sea. *Review of Fish Biology and Fisheries*, 2: 1-32.

Annex XIII:

OSPAR COMMISSION

**CEMP Guidelines for Monitoring Contaminants in Biota
(OSPAR Agreement 1999-02)**

Technical Annex 3: Determination of parent and alkylated PAHs in biological materials



CEMP Guidelines for Monitoring Contaminants in Biota

(OSPAR Agreement 1999-02)

Technical Annex 3: Determination of parent and alkylated PAHs in biological materials

1. Introduction

Polycyclic aromatic hydrocarbons (PAHs) consist of a variable number of fused benzene rings. By definition, PAHs contain at least two fused rings. PAHs arise from incomplete combustion processes and from both natural and anthropogenic sources, although the latter generally predominate. PAHs are also found in oil and oil products, and these include a wide range of alkylated PAHs formed as a result of diagenetic processes, whereas PAHs from combustion sources comprise mainly parent (non-alkylated) compounds. PAHs are of concern in the marine environment for two main reasons: firstly, low molecular weight (MW) PAHs can cause tainting of fish and shellfish and render them unfit for sale; secondly, metabolites of some of the high MW PAHs are potent animal and human carcinogens — benzo[*a*]pyrene is the prime example. Carcinogenic activity is closely related to structure. Benzo[*e*]pyrene and the four benzofluoranthene isomers all have a molecular weight of 252 Da; however, they are much less potent than benzo[*a*]pyrene. Less is known about toxicity of alkylated PAHs. However, one study has demonstrated that alkylated PAHs may have increased toxicity compared to the parent compound (Marvanova *et al.*, 2008).

PAHs are readily taken up by marine animals both across gill surfaces (lower MW PAHs) and from their diet. They may bioaccumulate, particularly in shellfish. Filter-feeding organisms such as bivalve molluscs can accumulate high concentrations of PAHs, both from chronic discharges to the sea (e.g., of sewage) and following oil spills. Fish are exposed to PAHs both via uptake across gill surfaces and from their diet, but do not generally accumulate high concentrations of PAHs as they possess an effective mixed-function oxygenase (MFO) system which allows them to metabolise PAHs and to excrete them in bile. Other marine vertebrate and marine mammals also metabolise PAHs efficiently. An assessment of the exposure of fish to PAHs therefore requires the determination of PAH metabolite concentrations in bile, as turnover times can be extremely rapid.

There are marked differences in the behaviour of PAHs in the aquatic environment between the low MW compounds (such as naphthalene; 128 Da) and the high MW compounds (such as benzo[*ghi*]perylene; 276 Da) as a consequence of their differing physico-chemical properties. The low MW compounds are appreciably water soluble (e.g. naphthalene) and can be bioaccumulated from the dissolved phase by transfer across gill surfaces, whereas the high MW compounds are relatively insoluble and hydrophobic, and can attach to both organic and inorganic particulates within the water column. PAHs derived from combustion sources may actually be deposited to the sea already

adsorbed to atmospheric particulates, such as soot particles. The sediment will act as a sink for PAHs in the marine environment.

2. Appropriate species for analysis of parent and alkylated PAHs

2.1 Benthic fish and shellfish

Guidance on the selection of appropriate species for contaminant monitoring is given in the OSPAR Joint Assessment and Monitoring Programme guidelines. All teleost fish have the capacity for rapid metabolism of PAHs, thereby limiting their usefulness for monitoring temporal or spatial trends of PAHs. Shellfish (particularly molluscs) generally have a lesser metabolic capacity towards PAHs, and so they are preferred because PAH concentrations are generally higher in their tissues. The blue mussel (*Mytilus edulis*) occurs in shallow waters along almost all coasts of the Northeast Atlantic. It is therefore suitable for monitoring in near shore waters. No distinction is made between *M. edulis* and *M. galloprovincialis* because the latter species, which may occur along Spanish and Portuguese coasts, fills a similar ecological niche. A sampling size range of 30–70 mm shell length is specified to ensure availability throughout the whole maritime area. In some areas (e.g., the Barents Sea), other species may be considered. Recent monitoring studies have indicated a seasonal cycle in PAH concentrations (particularly for combustion-derived PAHs) in mussels, with maximum concentrations in the winter prior to spawning and minimum concentrations in the summer. It is particularly important, therefore, that samples selected for trend monitoring and spatial comparisons are collected at the same time of year, and preferably in the first months of the year prior to spawning.

For the purposes of temporal trend monitoring, it is essential that long time-series with either a single species or a limited number of species be obtained. Care should be taken that the sample is representative of the population and that it can be sampled annually. There are advantages in the use of molluscs for this purpose as they are sessile, and so reflect the degree of contamination in the local area to a greater degree than fish which are mobile and metabolise PAHs relatively efficiently. The analysis of fish tissues is often undertaken in conjunction with biomarker and disease studies, and associations have been shown between the incidence of some diseases (e.g., liver neoplasia) in flatfish and the concentrations of PAHs in the sediments over which they live and feed (Malins *et al.*, 1988; Vethaak and Rheinallt, 1992). The exposure of fish to PAHs can be assessed by the analysis of PAH metabolites in bile, and by measuring the induction of mixed-function oxygenase enzymes which catalyse the formation of these metabolites.

3. Transportation

Live biota should be transported in closed containers at temperatures between 5°C and 10°C. For live animals it is important that the transport time is short and controlled (e.g., maximum of 24 hours). If biomarker determinations are to be made, then it will be necessary to store tissue samples at lower temperatures, for example, in liquid nitrogen at -196°C.

4. Pre-treatment and storage

4.1 Contamination

Sample contamination may occur during sampling, sample handling, pre-treatment, and analysis, due to the environment, the containers or packing materials used, the instruments used during sample preparation, and from the solvents and reagents used during the analytical procedures. Controlled

conditions are therefore required for all procedures. In the case of PAHs, particular care must be taken to avoid contamination at sea. On ships there are multiple sources of PAHs, such as the oils used for fuel and lubrication, and the exhaust from the ship's engines. It is important that the likely sources of contamination are identified and steps taken to preclude sample handling in areas where contamination can occur. A ship is a working vessel and there can always be procedures occurring as a result of the day-to-day operations (deck cleaning, automatic overboard bilge discharges, etc.) which could affect the sampling process. One way of minimizing the risk is to conduct dissection in a clean area, such as within a laminar-flow hood away from the deck areas of the vessel. It is also advisable to collect samples of the ship's fuel, bilge water, and oils and greases used on winches, etc., which can be used as fingerprinting samples at a later date, if there are suspicions of contamination in particular instances.

Freeze-drying of tissue samples may be a source of contamination due to the back-streaming of oil vapours from the rotary vacuum pumps. Furthermore, drying the samples may result in losses of the lower molecular weight and more volatile PAHs through evaporation (Law and Biscaya, 1994).

4.2 Shellfish

4.2.1 Depuration

Depending upon the situation, it may be desirable to depurate shellfish so as to void the gut contents and any associated contaminants before freezing or sample preparation. This is usually applied close to point sources, where the gut contents may contain significant quantities of PAHs associated with food and sediment particles which are not truly assimilated into the tissues of the mussels. Depuration should be undertaken in controlled conditions and in clean seawater; depuration over a period of 24 hours is usually sufficient. The aquarium should be aerated and the temperature and salinity of the water should be similar to that from which the animals were removed.

4.2.2 Dissection and storage

Mussels should be shucked live and opened with minimal tissue damage by detaching the adductor muscles from the interior of at least one valve. The soft tissues should be removed and homogenised as soon as possible, and frozen in glass jars or aluminium cans at -20°C until analysis. Plastic materials must not be used for sampling and storage owing to possible adsorption of the PAHs onto the container material. As PAHs are sensitive to photo-degradation, exposure to direct sunlight or other strong light must be avoided during storage of the samples as well as during all steps of sample preparation, including extraction and storage of the extracts (Law and Biscaya, 1994). The use of amber glassware is strongly recommended.

When samples are processed, both at sea and onshore, the dissection must be undertaken by trained personnel on a clean bench wearing clean gloves and using PAH-free stainless steel knives and scalpels. Stainless steel tweezers are recommended for holding tissues during dissection. After each sample has been prepared, all tools and equipment (such as homogenisers) should be cleaned by wiping with tissue and rinsing with solvent.

5. Analysis

5.1 Preparation of materials

Solvents and adsorptive materials must all be checked for the presence of PAHs and other interfering compounds. If found then the solvents, reagents, and adsorptive materials must be purified or cleaned using appropriate methods. Adsorptive materials should be cleaned by solvent extraction and/or by heating in a muffle oven as appropriate. Glass fibre materials (e.g. Soxhlet thimbles and filter papers used in pressurised liquid extraction (PLE)) should be cleaned by solvent extraction or pre-baked at 450°C overnight. It should be borne in mind that clean materials can be re-contaminated by exposure to laboratory air, particularly in urban locations, and so the method of storage after cleaning is of critical importance. Ideally, materials should be prepared immediately before use, but if they are to be stored, then the conditions should be considered critically. All containers which come into contact with the sample should be made of glass or aluminium, and should be pre-cleaned before use. Appropriate cleaning methods would include washing with detergents, rinsing with water of known quality, and finally solvent rinsing immediately before use.

5.2 Lipid determination

Although PAH data are not usually expressed on a lipid basis, the determination of the lipid content of tissues can be of use in characterising the samples. This will enable reporting concentrations on a wet weight or lipid weight basis. The lipid content should be determined on a separate subsample of the tissue homogenate, as some of the extraction techniques used routinely for PAHs determination (e.g., PLE with fat retainers, alkaline saponification) destroy or remove lipid materials. The total lipid content of fish or shellfish should be determined using the method of Bligh and Dyer (1959) as modified by Hanson and Olley (1963) or an equivalent method such as Smedes (1999). Extractable lipid may be used, particularly if the sample size is small and lipid content is high. It has been shown that if the lipid content is high (>5%) then extractable lipid will be comparable to the total lipid.

5.3 Extraction

PAHs are lipophilic and so are concentrated in the lipids of an organism, and a number of methods have been described for PAH extraction (Ehrhardt *et al.*, 1991). These methods generally utilise either Soxhlet extraction, or alkaline digestion followed by liquid-liquid extraction with an organic solvent. In the case of Soxhlet extraction, the wet tissue must be dried by mixing with a chemical drying agent (e.g., anhydrous sodium sulphate), in which case a time period of several hours is required between mixing and extraction in order to allow complete binding of the water in the sample. Samples are spiked with recovery standard and should be left overnight to equilibrate. Alkaline digestion is conducted on wet tissue samples, so this procedure is unnecessary.

Apolar solvents alone will not effectively extract all the PAHs from tissues when using Soxhlet extraction, and mixtures such as hexane/dichloromethane may be effective in place of solvents such as benzene and toluene, used historically for this purpose. Alkaline digestion has been extensively used in the determination of PAHs and hydrocarbons and is well documented. It is usually conducted in alcohol (methanol or ethanol), which should contain at least 10% water, and combines disruption of the cellular matrix, lipid extraction and saponification within a single procedure, thereby reducing sample handling and treatment. Solvents used for liquid-liquid extraction of the homogenate are usually apolar, such as pentane or hexane, and they will effectively extract all PAHs.

Alternatively extraction of wet or dry samples of biota may be carried out by pressurised liquid extraction (PLE). This is a more recent method, requiring less solvent and time for the extraction process. The wet biota sample is dried by mixing with sufficient anhydrous sodium sulphate to form a free flowing mixture and is packed into stainless steel extraction cells containing a glass fibre filter and sodium sulphate or glass powder to fill the cell. To ensure a better recovery samples may be extracted twice and extractions are performed at elevated temperatures and pressure.

5.4 Clean-up

Tissue extracts will always contain many compounds other than PAHs, and a suitable clean-up is necessary to remove those compounds which may interfere with the subsequent analysis. Different techniques may be used, either singly or in combination, and the choice will be influenced by the selectivity and sensitivity of the final measurement technique and also by the extraction method employed. If Soxhlet extraction was used, then there is a much greater quantity of residual lipid to be removed before the analytical determination can be made than in the case of alkaline digestion. An additional clean-up stage may therefore be necessary. The most commonly used clean-up methods involve the use of deactivated alumina or silica adsorption chromatography. When applying fractionation, the elution pattern has to be checked frequently. This should be carried out in the presence of sample matrix, as that can partially deactivate the clean-up column, resulting in earlier elution of the PAHs than in a standard solution.

Gel permeation chromatography (GPC) and high performance liquid chromatography (HPLC) based methods are also employed (Nondek *et al.*, 1993; Nyman *et al.*, 1993; Perfetti *et al.*, 1992). The major advantages of using HPLC-based clean-up methods are their ease of automation and reproducibility.

Isocratic HPLC fractionation of the extract can be used to give separate aliphatic and aromatic fractions (Webster *et al.*, 2002). A metal-free silica column is used for the clean-up/fractionation as dibenzothiophene (DBT) can be retained on ordinary silica columns. The split time is determined by injection of a solution containing representative aliphatic and PAH standards. The silica column is regenerated by a cleaning cycle after a set number of samples. If PAHs are to be analysed by HPLC and there are significant amounts of alkylated PAHs present then the removal of the alkylated PAHs may be difficult.

5.5 Pre-concentration

In the methods suggested above, all result in an extract in which non-polar solvents are dominant. The sample volume should be 2 ml or greater to avoid errors when transferring solvents during the clean-up stages. Syncore parallel evaporators can be used with careful optimisation of the evaporation parameters. Evaporation of solvents using a rotary-film evaporator should be performed at low temperature (water bath temperature of 30°C or lower) and under controlled pressure conditions, in order to prevent losses of the more volatile PAHs such as naphthalenes. For the same reasons, evaporation to dryness must be avoided. When reducing the sample to final volume, solvents can be removed by a stream of clean nitrogen gas. Suitable solvents for injection into the GC-MS include pentane, hexane, heptane, *iso*-hexane and *iso*-octane.

5.6 Selection of PAHs to be determined

The choice of PAHs to be analysed is not straightforward, both because of differences in the range of PAH compounds resulting from combustion processes and from oil and oil products, and also because the aims of specific monitoring programmes can require the analysis of different representative

groups of compounds. PAHs arising from combustion processes are predominantly parent (unsubstituted) compounds, whereas oil and its products contain a much wider range of alkylated compounds in addition to the parent PAHs. This has implications for the analytical determination, as both HPLC-based and GC-based techniques are adequate for the determination of a limited range of parent PAHs in samples influenced by combustion processes, whereas in areas of significant oil contamination and following oil spills only GC-MS has sufficient selectivity to determine the full range of PAHs present. The availability of pure individual PAHs for the preparation of standards is problematic and limits both the choice of determinands and, to some degree, the quantification procedures which can be used. The availability of reference materials certified for PAHs is also rather limited. A list of target parent and alkylated PAHs suitable for environmental monitoring is given in Table A1.1. This differs both from the list previously developed within ICES specifically for intercomparison purposes, and the historic list of Borneff. In both cases, the lists were concentrated on a subset of parent (predominantly combustion-derived) PAHs due to analytical limitations. This approach completely neglects the determination of alkylated PAHs, which allows the interpretation of PAH accumulation from multiple sources including those due to oil inputs. It will not be necessary for all of these PAH compounds and groups to be analysed in all cases, but an appropriate selection can be made from this list depending on the specific aims of the monitoring programme to be undertaken.

Table A1.1: Compounds of interest for environmental monitoring for which the guidelines apply. For compounds in italics standards are not available for any isomers in this group.

Compound	MW	Compound	MW
Naphthalene	128	2, 3d-benzonaphthothiophene	234
C ₁ -Naphthalenes	142	C ₁ -234	248
C ₂ -Naphthalenes	156	C ₂ -Fluoranthenes/Pyrenes	230
C ₃ -Naphthalenes	170	Benz[<i>a</i>]anthracene	228
<i>C₄-Naphthalenes</i>	184	Chrysene	228
Acenaphthylene	152	2,3-Benzanthracene	228
Acenaphthene	154	C ₁ - Benz[<i>a</i>]anthracene/ Chrysene	242
Biphenyl	154	C ₂ - Benz[<i>a</i>]anthracene/ Chrysene	256
Fluorene	166	C ₃ - Benz[<i>a</i>]anthracene/ Chrysene	270
C ₁ -Fluorenes	180	Benzo[<i>a</i>]fluoranthene	252
<i>C₂-Fluorenes</i>	194	Benzo[<i>b</i>]fluoranthene	252
<i>C₃-Fluorenes</i>	208	Benzo[<i>j</i>]fluoranthene	252
Dibenzothiophene	184	Benzo[<i>k</i>]fluoranthene	252
C ₁ -Dibenzothiophenes	198	Benzo[<i>e</i>]pyrene	252
<i>C₂-Dibenzothiophenes</i>	212	Benzo[<i>a</i>]pyrene	252
<i>C₃-Dibenzothiophenes</i>	226	Perylene	252
Phenanthrene	178	Indeno[1,2,3- <i>cd</i>]pyrene	276
Anthracene	178	Benzo[<i>ghi</i>]perylene	276
C ₁ -Phenanthrenes/Anthracenes	192	Dibenz[<i>a,h</i>]anthracene	278
C ₂ -Phenanthrenes/Anthracenes	206	Benzo[<i>k</i>]fluoranthene	252
C ₃ -Phenanthrenes/Anthracenes	220	Cyclopenta[<i>cd</i>]pyrene	226
Fluoranthene	202	Naphtho[2,1- <i>a</i>]pyrene	302
Pyrene	202	Dibenz[<i>a,e</i>]pyrene	302

C ₁ -Fluoranthenes/Pyrenes	216	Dibenz[<i>a,i</i>]pyrene	302
2, 1d-benzonaphthothiophene	234	Dibenz[<i>a,l</i>]pyrene	302
1,2d-benzonaphthothiophene	234	Dibenz[<i>a,h</i>]pyrene	302

5.7 Instrumental determination of PAHs

The greatest sensitivity and selectivity in routine analysis for parent PAH is achieved by combining HPLC with fluorescence detection (HPLC-UVF) or capillary gas chromatography with mass spectrometry (GC-MS). However, for the analysis of parent and alkylated PAHs GC-MS is the method of choice. In terms of flexibility, GC-MS is the most capable technique, as in principle it does not limit the selection of determinands in any way, while HPLC is suited only to the analysis of parent PAHs. In the past, analyses have also been conducted using HPLC with UV-absorption detection and GC with flame-ionisation detection, but neither can be recommended for alkylated PAHs because of their relatively poor selectivity. Both in terms of the initial capital cost of the instrumentation, and the cost per sample analysed, HPLC-UVF is cheaper than GC-MS. With the advent of high-sensitivity benchtop GC-MS systems, however, this cost advantage is now not as marked as in the past, and the additional information regarding sources available makes GC-MS the method of choice.

Limits of determination within the range of 0.05 to 0.5 µg kg⁻¹ wet weight for individual PAH compounds should be achievable by GC-MS. However this limit can be lowered in routine analysis.

5.7.1 GC-MS

The three injection modes commonly used are splitless, on-column and PTV (programmed temperature vaporiser). Automatic sample injection should be used wherever possible to improve the reproducibility of injection and the precision of the overall method. If splitless injection is used, the liner should be of sufficient capacity to contain the injected solvent volume after evaporation. For PAH analysis, the cleanliness of the liner is also very important if adsorption effects and discrimination are to be avoided, and the analytical column should not contain active sites to which PAHs can be adsorbed. Helium is the preferred carrier gas, and only capillary columns should be used. Because of the wide boiling range of the PAHs to be determined and the surface-active properties of the higher PAHs, the preferred column length is 25–50 m, with an internal diameter of 0.15 mm to 0.3 mm. Film thicknesses of 0.2 µm to 1 µm are generally used; this choice has little impact on critical resolution, but thicker films are often used when one-ring aromatic compounds are to be determined alongside PAHs, or where a high sample loading is needed. No stationary phase has been found on which all PAH isomers can be resolved; the most commonly used stationary phase for PAH analysis is 5% phenyl methylsilicone (DB-5 or equivalent). This will not, however, resolve critical isomers such as benzo[*b*], [*j*] and [*k*]fluoranthenes, or chrysene from triphenylene. Chrysene and triphenylene can be separated on other columns, if necessary such as a 60 m non polar column such as DB5MS. For PAHs there is no sensitivity gain from the use of chemical ionisation (either positive or negative ion), so analyses are usually conducted in electron-impact mode at 70eV. Quadrupole instruments are used in single ion monitoring to achieve greater sensitivity. The masses to be detected are programmed to change during the analysis as different PAHs elute from the capillary column. In SIM the molecular ion is used for quantification. Qualifier ions can be used to confirm identification but they are limited for PAHs. Triple quadrupole mass spectrometry can also be used and will give greater sensitivity. Some instruments such as ion-trap and time of flight mass spectrometers exhibit the same sensitivity in both modes, so full scan spectra can be used for quantification.

An example of mass spectrometer operating conditions in SIM mode is given in Table A1.2. The ions are grouped and screened within GC time windows of the compounds. In general the number of ions should not be greater than 20. The dwell time is important parameter and should be close for each ion. For GC capillary column analysis a dwell time should not be shorter than 20 ms, while a sum of a dwell in each retention time windows should not be greater than 500 ms. An example of conditions that can be used along with dwell times are shown in Table A1.2.

Table A.1.2: Example of operational conditions for the GC-MS analysis of parent and alkylated PAHs.

Group N°	Retention time (min)	Dwell time (ms)	Ions in group (AMU)					
			128	136	142	170	182	184
1	8.00	100	128	136	142			
2	21.00	100	152	156	160			
3	23.70	100	154	164	168	170		
4	26.80	80	166	176	180	182	184	
5	31.60	80	178	184	188	194	196	198
6	35.30	100	192	198				
7	36.60	100	206	212				
8	39.40	80	202	206	212	216	220	226
9	44.65	100	216	220				
10	45.30	100	226	228	230	234	240	
11	48.58	90	242	248				
12	52.00	100	252	256	264	266		
13	59.00	100	266	276	278	288		

Alkylated homologues of PAHs (C1–C4), mainly associated with petrogenic sources, contain a number of different isomers that can give very complex but distinct distribution profiles when analysed by GC-MS. Integration of each isomer separately is difficult for most alkylated PAHs. 1- and 2-Methyl naphthalene give well resolved peaks that can be quantified separately. C1-Phenanthrene/anthracene gives five distinct peaks corresponding to 3-methyl phenanthrene, 2-methyl phenanthrene, 2-methyl anthracene, 4- and 9-methyl phenanthrene and 1-methyl phenanthrene. These may be integrated as a group or as separate isomers. For all other alkylated PAHs the area for all isomers may be summed and quantified against a single representative isomer. This method will lead, however, to an overestimation of the concentration as may include non-alkylated PAHs. Examples of integrations of both parent and alkylated PAHs are shown in Appendix 1.

6. Calibration and quantification

6.1 Standards

The availability of pure PAH compounds are limited. Although most of the parent compounds can be purchased as pure compounds, the range of possible alkyl-substituted PAHs is vast and only a limited selection of them can be obtained. PAH standards are available for at least one isomer of most alkyl group listed in Table A1.1. A range of deuterated PAHs (normally 5 to 7) should be used as internal standards to cover the range of PAHs being analysed in samples. A range of fully-deuterated parent PAHs is available for use as standards in PAH analysis. Suitable standards could range from d_8 -naphthalene to d_{14} -dibenz[*a,h*]anthracene. Crystalline PAHs of known purity should be used for the preparation of calibration standards. If the quality of the standard materials is not guaranteed by the producer or supplier (as for certified reference materials), then it should be checked by GC-MS analysis. Solid standards should be weighed to a precision of 10^{-5} grams. Calibration standards should

be stored in the dark because some PAHs are photosensitive, and ideally solutions to be stored should be sealed in amber glass ampoules or sealed GC vials. Otherwise, they can be stored in a refrigerator in stoppered measuring cylinders or flasks that are gas tight to avoid evaporation of the solvent during storage.

6.2 Calibration

Multilevel calibration with at least five calibration levels is preferred to adequately define the calibration curve. In general, GC-MS calibration is linear over a considerable concentration range but may exhibit a change of slope at very low concentrations. Quantification should be conducted in the linear region of the calibration curve. A separate calibration curve may be used where sample concentrations are very low. An internal standard method should be employed, using a range of deuterated PAHs as internal standards.

6.3 Recovery

The recovery of analytes should be checked and reported. Given the wide boiling range of the PAHs to be determined, the recovery may vary with compound group, from the volatile PAHs of low molecular weight to the larger compounds. Deuterated standards can be added in two groups: those to be used for quantification are added at the start of the analytical procedure, whilst those from which the absolute recovery will be assessed are added prior to GC-MS injection. This allows the recovery to be calculated.

7. Analytical Quality Control

Planners of monitoring programmes must decide on the accuracy, precision, repeatability, and limits of detection and determination which they consider acceptable. Achievable limits of determination for each individual component are as follows:

- for GC-MS measurements: $0.05 \mu\text{g kg}^{-1} \text{ ww}$;
- Further information on analytical quality control procedures for PAHs can be found elsewhere (Law and de Boer, 1995). A procedural blank should be measured with each sample batch, and should be prepared simultaneously using the same chemical reagents and solvents as for the samples. Its purpose is to indicate sample contamination by interfering compounds, which will result in errors in quantification. The procedural blank is also very important in the calculation of limits of detection and limits of quantification for the analytical method. In addition, a laboratory reference material (LRM) should be analysed within each sample batch. The LRM must be homogeneous and well-characterised for the determinands of interest within the analytical laboratory. Ideally, stability tests should have been undertaken to show that the LRM yields consistent results over time. The LRM should be of the same matrix type (e.g. mussels) as the samples, and the determinand concentrations should be in the same range as those in the samples. Realistically, and given the wide range of PAH concentrations encountered, particularly in oil spill investigations, this is bound to involve some compromise. The data produced for the LRM in successive sample batches should be used to prepare control charts. It is also useful to analyse the LRM in duplicate from time to time to check within-batch analytical variability. The analysis of an LRM is primarily intended as a check that the analytical method is under control and yields acceptable precision, but a certified reference material (CRM) of a similar matrix should be analysed periodically in order to check the method bias. The availability of biota CRMs certified for PAHs is very limited, and in all cases the number of PAHs for which certified values are

provided is small. At present, only NIST 1974a (a frozen wet mussel tissue) and NIST 2974 (a freeze-dried mussel tissue) are available. At regular intervals, the laboratory should participate in an intercomparison or proficiency exercise in which samples are circulated without knowledge of the determinand concentrations, in order to provide an independent check on performance.

8. Data reporting

The calculation of results and the reporting of data can represent major sources of error, as has been shown in intercomparison studies for PAHs. Control procedures should be established in order to ensure that data are correct and to obviate transcription errors. Data stored on databases should be checked and validated, and checks are also necessary when data are transferred between databases. Data should be reported in accordance with the latest ICES reporting formats.

9. References

Bligh, E. G., and Dyer, W. J. 1959. A rapid method of total lipid extraction and purification. *Canadian Journal of Biochemistry and Physiology*. 37: 911–917.

Ehrhardt, M., Klungsøyr, J., and Law, R. J. 1991. Hydrocarbons: Review of methods for analysis in sea water, biota, and sediments. *Techniques in Marine Environmental Sciences*. 12: 19–22.

Farrington, J. W., Davis, A. C., Livramento, J. B., Clifford, C. H., Frew, N. M., and Knap, A. 1986. ICES/IOC Intercomparison Exercises on the Determination of Petroleum Hydrocarbons in Biological Tissues (mussel homogenate) – ICES (2/HC/BT). ICES Cooperative Research Report, 141: 1–75.

Hanson, S. W. F., and Olley, J. 1963. Application of the Bligh and Dyer method of lipid extraction to tissue homogenates. *Biochem. J.*, 89: 101–102.

Law, R. J., and Biscaya, J. L. 1994. Polycyclic aromatic hydrocarbons (PAHs)—Problems and progress in sampling, analysis and interpretation. *Marine Pollution Bulletin*, 29: 235–241.

Law, R. J., and de Boer, J. 1995. Quality assurance of analysis of organic compounds in marine matrices: Application to analysis of chlorobiphenyls and polycyclic aromatic hydrocarbons. *In Quality Assurance in Environmental Monitoring—Sampling and Sample Pretreatment*. 129–156. Ed. by P. Quevauviller. VCH Publishers, Weinheim, Germany.

Law, R. J., Fileman, T. W., and Portmann, J. E. 1988. Methods of analysis for hydrocarbons in marine samples. *Aquatic Environment Protection: Analytical Methods*. MAFF Directorate of Fisheries Research, Lowestoft, UK. (2). 25.

Law, R. J., and Klungsøyr, J. 1996. The 1994 QUASIMEME laboratory-performance studies: Polycyclic aromatic hydrocarbons (PAHs) in standard solutions. *Marine Pollution Bulletin*, 32: 667–673.

Law, R. J., Klungsøyr, J., and Fredriks, I. L. 1998. The QUASIMEME interlaboratory testing scheme for polycyclic aromatic hydrocarbons (PAHs): assessment of the first three rounds, 1994–1995. *Marine Pollution Bulletin*. 35: 64–77.

Law, R. J., and Nicholson, M. D. 1995. Report on the results of the Intercomparison Programme on the Analysis of PAHs in Marine Media—Stage 1. ICES Cooperative Research Report. 207: 52–104.

Malins, D. C., McCain, B. B., Landahl, J. T., Myers, M. S., Krahn, M. M., Brown, D. W., Chan, S-L., and Roubal, W. T. 1988. Neoplastic and other diseases in fish in relation to toxic chemicals: an overview. *Aquatic Toxicology*. 11: 43–67.

Marvanova, S., Vondracek, J., Pencikova, K., Trilecova, L., Krcmar, P., Topinka, J., Novakova, Z., Milcova, A., and Machala, M. 2008. Toxic effects of methylated[a]anthracenes in liver cells. *Chemical Research in Toxicology*. In press.

Nondek, L., Kuzilek, M., and Krupicka, S. 1993. LC clean-up and GC-MS analysis of polycyclic aromatic hydrocarbons in river sediment. *Chromatographia*. 37: 381–391.

Nyman, P. J., Perfetti, G. A., Joe, F. L. jr., and Diachenko, G. W. 1993. Comparison of two clean-up methodologies for the gas chromatographic-mass spectrometric detection of low nanogram per gram levels of polynuclear aromatic hydrocarbons in seafood. *Food Additives and Contaminants*. 10: 489–501.

Perfetti, G. A., Nyman, P. J., Fisher, S., Joe, F. L. jr., and Diachenko, G. W. 1992. Determination of polynuclear aromatic hydrocarbons in seafood by liquid chromatography with fluorescence detection. *Journal of the Association of Official Analytical Chemists*. 75: 872–877.

Revision of the Nordtest Methodology for oil spill identification, <http://www.nordicinnovation.net/nordtestfiler/tec499.pdf>

Smedes, F. 1999. Determination of total lipid using non-chlorinated solvents. *Analyst*, 124: 1711-1718.

Vethaak, A. D., and Rheinallt, T. 1992. Fish disease as a monitor for marine pollution: the case of the North Sea. *Review of Fish Biology and Fisheries*. 2: 1–32.

Webster, L., McIntosh, A. D., Megginson, C., Shepherd, N. J., and Moffat, C. F. 2002. The polycyclic aromatic hydrocarbon composition of mussels (*Mytilus edulis*) from Scottish coastal waters. *Journal of Environmental Monitoring*. 5:150-159.

Annex XIV:

European Commission Guidance Document No. 32. On Biota Monitoring

Technical Report - 2014 - 083

(The implementation of EQSBIOTA) under the Water Framework Directive

ANNEX A.7 Normalisation of measured data with respect to lipid and dry weight content

European Commission Guidance Document No. 32. On Biota Monitoring

Technical Report - 2014 - 083

(The implementation of EQSBIOTA) under the Water Framework Directive

ANNEX A.7 Normalisation of measured data with respect to lipid and dry weight content

The appropriate metric to use for normalisation of contaminant concentrations in biota will usually follow from the normalisation used in the bioaccumulation studies used to derive the biota EQS.

For substances that accumulate through hydrophobic partitioning into the lipids of organisms, measured concentrations in fish should be normalised to fish with a lipid content of 5% (EC 2011). The energy content for mussels of 19.3 kJ/g dw (Smit 2005; EFSA 2009) corresponds to a lipid content of approximately 1% for freshwater and marine bivalves (Bruner et al. 1994; Lazzara et al. 2012; Pleissner et al. 2012), and measured concentrations in bivalves should therefore be normalised to bivalves with a lipid content of 1%. The rationale behind this lipid normalisation is that the whole body biota concentration is linearly correlated with the lipid content of the species for those substances.

For a substance that does not accumulate by hydrophobic partitioning into lipids, but via another mechanism of accumulation, normalisation against another parameter, such as dry weight (e.g. for mercury), may be appropriate. The default dry weight content for fish is approximately 26% (Smit 2005; EFSA 2009). For mussels, EFSA has suggested a default dry weight content of 8.3% (Smit 2005; EFSA 2009).

Based on the above, contaminant concentrations should be normalised to lipid contents of 5% in fish and 1% in bivalves, or to dry weight contents of 26% in fish and 8.3% in bivalves, on the basis of the measured lipid content or dry weight, or on the basis of generic values for lipid content or dry weight for the relevant species obtained from FishBase, for example.

To calculate the normalised concentrations $\text{conc}_{\text{norm, lipid}}$ or $\text{conc}_{\text{norm, dry weight}}$ from measured concentrations $\text{conc}_{\text{meas}}$ for a fish species x , the following equations can be used (lipid content and dry weight content expressed as mass fractions):

$$\text{conc}_{\text{norm, lipid}} = \text{conc}_{\text{meas}} \cdot 0.05 / \text{lipid content}_x$$

or

$$\text{conc}_{\text{norm, dry weight}} = \text{conc}_{\text{meas}} \cdot 0.26 / \text{dry weight}_x$$

Similarly, to calculate the normalised concentrations $\text{conc}_{\text{norm, lipid}}$ or $\text{conc}_{\text{norm, dry weight}}$ from measured concentrations $\text{conc}_{\text{meas}}$ for a bivalve species x , the following equations can be used (lipid content and dry weight content expressed as mass fractions):

$$\text{conc}_{\text{norm, lipid}} = \text{conc}_{\text{meas}} \cdot 0.01 / \text{lipid content}_x$$

or

$$\text{conc}_{\text{norm, dry weight}} = \text{conc}_{\text{meas}} \cdot 0.083 / \text{dry weight}_x$$

Using the exact lipid or dry weight content of the biota samples is always preferred over generic values for the species (such as those available from FishBase).

It is acknowledged that for the organic priority substances, e.g. dioxins, covered by both the WFD and food legislation, lipid normalisation may result in different conclusions under the MSFD for descriptors 8 and 9, even when human health is the protection goal in both cases. The discrepancy will depend upon whether the actual lipid content is greater or less than the 5% benchmark. The results should therefore be interpreted with appropriate qualification.

Annex XV:

Background Assessment Criteria recommended to be used to assess concentrations in Mediterranean sediments, mussel (*Mytilus galloprovincialis*) and fish (*Mullus barbatus*) (UNEP(DEPI)/MED WG.444/12, 6th Meeting of the Ecosystem Approach Coordination Group 2017)

Annex XV: Background Assessment Criteria recommended to be used to assess concentrations in Mediterranean sediments, mussel (*Mytilus galloprovincialis*) and fish (*Mullus barbatus*)
(UNEP(DEPI)/MED WG.444/12, 6th Meeting of the Ecosystem Approach Coordination Group 2017)

Background Assessment Criteria recommended to be used to assess concentrations in Mediterranean sediments, mussel (*Mytilus galloprovincialis*) and fish (*Mullus barbatus*)
UNEP(DEPI)/MED WG.444/12, 6th Meeting of the Ecosystem Approach Coordination Group 2017

Table of the proposed assessment criteria for trace metals (TMs)

Table A.1.1. Mediterranean Sea: Background Concentrations (Med BCs), Med BACs and EACs;
Calculation =>BC = 50th (median); BAC=1.5 x BC (mussel, sediment); BAC=2.0 x BC (fish)

Trace metal	Mussel (MG) $\mu\text{g kg}^{-1}$ d.w.			Fish (MB) $\mu\text{g kg}^{-1}$ f.w.			Sediment $\mu\text{g kg}^{-1}$ d.w.		
	BC	Med BAC	EC*	BC	Med BAC	EC*	BC	Med BAC	ERL**
Cd	730.0	1095.0	5000	(3.7) ^a	(16.0) ^b	50	85.0	127.5	1200
Hg	115.5	173.2	2500	50.6	101.2	1000	53.0	79.5	150
Pb	1542	2313	7500	(31) ^a	(40) ^b	300	16950	25425	46700

^aCd value is below the detection limit (<BDL) and Pb presents a majority of non-detected values in monitoring datasets.

^bestimated BACs from reliable limits of detection (BAC=1.5 x LOD) using analytical data and certified reference material information (DORM-2) (see also text). However, liver tissue matrix should be recommended in fish for Cd and Pb as within OSPAR Convention.

*EC/EU 1881/2006 and 629/2008 Directives for maximum levels for certain contaminants in foodstuffs

** Long et al. 1995 (idem OSPAR adopted values)

Table of the proposed assessment criteria for polycyclic aromatic hydrocarbons (PAHs)

Table A.2.1. Mediterranean Sea Background Concentrations (BCs), Med BACs and EACs;
Calculation =>BC = 50th (median); BAC=2.5 x BC (mussel); no data for sediment available

PAH compound	Mussel (MG) $\mu\text{g kg}^{-1}$ d.w.			Sediment $\mu\text{g kg}^{-1}$ d.w.		
	Med BC	Med BAC	^a OSPAR EAC	^a OSPAR BC	^a OSPAR BAC	^c ERL
F	1.0	2.5	-	-	-	-
P	7.1	17.8	1700	4.0	7.3	240
A	0.5	1.2	290	1.0	1.8	85
FL	3.0	7.4	110	7.5	14.4	600
PY	2.0	5.0	100	6.0	11.3	665
BaA	0.8	1.9	80	3.5	7.1	261
C	1.0	2.4	-	4.0	8.0	384
BkF	0.6	1.4	260	-	-	-
BaP	0.5	1.2	600	4.0	8.2	430
GHI	0.9	2.3	110	3.5	6.9	85
DA	0.5	1.3	-	-	-	-
ID	1.2	2.9	-	4.0	8.3	240

*Naphthalene, Acenaphthylene, Acenaphthene, Benz(e)pyrene and Benzo(b)fluoranthene are below detection limits (BDLs) or have limited monitoring datasets, and therefore their BACs are preliminary estimations.

^aOSPAR Commission, CEMP: 2008/2009 Assessment of trends and concentrations of selected hazardous substances in sediments and biota (OSPAR PAHs sediment datasets from Spain, not TOC corrected);

^cERL: Effect Range Low

Table of the proposed assessment criteria for organochlorinated compounds (OCs)

(Summary of OSPAR values to be used in the Mediterranean Sea) Table A.3.1. OSPAR Region (Background Concentrations (BCs), BACs and EACs)¹

OCs compound	Mussel $\mu\text{g kg}^{-1}$ d.w.			Fish $\mu\text{g kg}^{-1}$ w.w.			^d Sediment $\mu\text{g kg}^{-1}$ d.w.		
	BC/LC ^c	BA C	EAC	BC/LC ^c	BA C	EAC (lipid w.)	BC/LC ^c	BAC	EAC/ER L
CB28 ^a	0.25	0.75	3.2	0.05	0.10	64	0.05	0.22	1.7
CB52 ^a	0.25	0.75	5.4	0.05	0.08	108	0.05	0.12	2.7
CB101 ^a	0.25	0.70	6.0	0.05	0.08	120	0.05	0.14	3.0
CB105 ^a	0.25	0.75	-	0.05	0.08	-	0.05	-	-
CB118 ^a	0.25	0.60	1.2	0.05	0.10	24	0.05	0.17	0.6
CB138 ^a	0.25	0.60	15.8	0.05	0.09	316	0.05	0.15	7.9
CB153 ^a	0.25	0.60	80	0.05	0.10	1600	0.05	0.19	40
CB156 ^a	0.25	0.60	-	0.05	0.08	-	0.05	-	-
CB180 ^a	0.25	0.60	24	0.05	0.11	480	0.05	0.10	12
Σ 7CBs ICES ^b	-	-	-	-	-	-	0.20	0.46	11.5*
Lindane ^a	0.25	0.97	1.45	-	-	11**	0.05	0.13 ₊	3.0*
α -HCH ^a	0.25	0.64	-	-	-	-	-	-	-
pp'DDE ^a	0.25	0.63	5-50***	0.05	0.10	-	0.05	0.09 ₊	2.2*
HCB ^a	0.25	0.63	-	0.05	0.09	-	0.05	0.16 ₊	20.0*
Dieldrin ^a	-	-	5-50***	-	-	-	0.05	0.19 ₊	2.0*

¹OSPAR Commission, 2013.

^aOSPAR Commission, CEMP: 2008/2009 Assessment of trends and concentrations of selected hazardous substances in sediments and biota, Monitoring and Assessment Series

^bOSPAR Commission, Background document on CEMP assessment criteria for the QSR 2010, Monitoring and Assessment Series

^cLC: Low concentrations calculated from QUASIMEME; However, BC values should be considered as zero for OCs

^dTotal organic carbon (TOC) corrected values; ₊LC from Spain (OSPAR, 2013)

*ERLs values instead EACs: Effect Range Low (Long et al. 1995); ERL for ICES Σ 7CB is total CB concentration/2

**EAC for fish liver derived by applying a conversion factor of 10 on EAC for whole fish (CEMP 2008/2009)

***Ecotoxicological assessment criteria (earlier data from the QSR2000 Report-Chapter 4)

Annex XVI:

References

Annex XVI: References

- Black, K., Kalantzi, I., Karakassis, I., Papageorgiou, N., Pergantis, S., Shimmield, T. (2013). Heavy metals, trace elements and sediment geochemistry at four mediterranean fish farms, *Science of the Total Environment*. Elsevier, 444, 128–137.
- Bligh EG, Dyer WJ: A rapid method of total lipid extraction and purification. *Can J Biochem Physiol* 1959, 37:911-917.
- EFSA. 2009 Guidance Document on Risk Assessment for Birds and Mammals. Parma, Italy: European Food Safety Authority. Authority EFS.358 pp.
- Enamorado-Báez, S.M., Abril, JM and Gómez-Guzmán, JM (2013) Determination of 25 Trace Element Concentrations in Biological Reference Materials by ICP-MS following Different Microwave-Assisted Acid Digestion Methods Based on Scaling Masses of Digested Samples. *Hindawi Publishing Corporation, ISRN Analytical Chemistry, Volume 2013, Article ID 851713, 14 pages.* <http://dx.doi.org/10.1155/2013/851713>
- European Commission (2014). Common implementation strategy for the Water Framework Directive (2000/60/EC). Guidance Document No. 32 on Biota Monitoring (the Implementation of EQSbiota) under the Water Framework Directive. Technical Report - 2014 – 083.
- FishBase: A global information system on fishes (www.fishbase.in)
- Harms, U. 1985. Possibilities of improving the determination of extremely low lead concentrations in marine fish by graphite furnace atomic absorption spectrometry. *Fresenius Journal of Analytical Chemistry*, 322: 53-56.
- HELCOM (2012a). Manual for marine monitoring in the COMBINE programme. Annex B-12, Appendix 4: Technical note on the determination of trace metallic elements in biota.
- HELCOM (2012b). COMBINE Annex B-12, Appendix 4, Attachment 1. Technical note on the determination of Total Mercury in marine biota by Cold Vapour Atomic Absorption Spectroscopy.
- HELCOM (2012c). Manual for marine monitoring in the COMBINE programme. Annex B-12, Appendix 3. Technical note on the determination of chlorinated biphenyls and organochlorine pesticides in biota.
- HELCOM (2012d). Manual for marine monitoring in the COMBINE programme. Annex B-12, Appendix 2. Technical Note on the determination of Polycyclic Aromatic Hydrocarbons in Biota.
- IAEA (2011a). Recommended method on microwave digestion of marine samples for the determination of trace element content (IAEA/Marine Environmental Studies Laboratory in co-operation with UNEP/MAP MED POL)
- IAEA (2011b) Recommended method for the determination of selected trace element in samples of marine origin by flame atomic absorption spectrometry
- IAEA (2011c) Recommended method for the determination of selected trace element in samples of marine origin by atomic absorption spectrometry using graphite furnace
- IAEA (2011d). Sample work-up for the analysis of selected chlorinated hydrocarbons in the marine environment. Reference Methods for Marine Pollution Studies No 71
- IAEA (2012a) Recommended method on the determination of Total Hg in marine samples by Thermal Decomposition Amalgamation and Atomic Absorption Spectrometry

IAEA (2012b). Recommended method on the determination of Total Hg in samples of marine origin by Cold Vapour Atomic Absorption Spectrometry.

ICES/OSPAR (2018a). CEMP Guidelines for monitoring contaminants in biota and sediments. Technical Annex 8. Determination of chlorobiphenyls in biota

ICES/OSPAR (2018b). CEMP Guidelines for monitoring contaminants in biota and sediments. Technical Annex 3. Determination of parent and alkylated PAHs in biological materials.

León V.M., Martínez-Gómez, C., García, I., Campillo, J.A, Benedicto J. (2013). Spatial distribution and temporal trends of polycyclic aromatic hydrocarbons in *Mytilus galloprovincialis* from the Iberian Mediterranean coast. *Environmental Monitoring and Assessment*, 185, 2, 1055-1070.

OECD (1996). OECD Guidelines for Testing Chemicals: Proposal for Updating Guideline 305. Bioconcentration: Flow-Through Fish Test Paris 1996.

Smedes F (1999). Determination of total lipid using non-chlorinated solvents. *Analyst*, 124:1711-1718.

UNEP (2019a). UNEP/MED WG.467/5. IMAP Guidance Factsheets: Update for Common Indicators 13, 14, 17, 18, 20 and 21: New proposal for candidate indicators 26 and 27;;

UNEP (2019b). UNEP/MED WG.463/6. Monitoring Protocols for IMAP Common Indicators related to pollution; UNEP/MAP (2019)

US EPA (1994) US-EPA Method 200.8: Determination of trace elements in waters and wastes by inductively coupled plasma-mass spectrometry.

US EPA (2007). U.S. Environmental Protection Agency, EPA method 7473, Mercury in solids and solutions by thermal decomposition, amalgamation and atomic absorption spectrophotometry Rev 0. <http://www.epa.gov/osw/hazard/testmethods/sw846/pdfs/7473.pdf>

Appendix 20

**Monitoring Guidelines/Protocols for Sampling and Sample Preservation of Seawater for IMAP
Common Indicator 17: Heavy and Trace Elements and Organic Contaminants**

1. Introduction

1. Seawater is not included in the mandatory matrices to be analysed in the framework of the UNEP/MAP's Integrated Monitoring and Assessment Programme (UNEP 2019a²⁸⁸, UNEP 2019b²⁸⁹), therefore the implementation of a monitoring programme for the determination of heavy metal and organic contaminants in seawater is a country-based decision. It has to be emphasized that heavy metals and organic contaminants' concentrations in seawater are very low, especially in offshore waters, so improper sample collection and handling could easily result in loss of determinant and/or contamination of the sample before analysis. Therefore, if a country decides to implement a seawater monitoring programme, it has to develop and test a very strict sampling and preservation protocol, using appropriate equipment and shipping infrastructure. Also, laboratory facilities should be adapted accordingly for the quality assured analysis of ultra-low contaminant's concentrations in seawater samples.

2. Seawater sampling can be equally implemented in coastal and offshore marine areas, since sampling equipment and sample preservation methodologies to avoid determinant's loss and/or cross-contamination are similar for both areas. Therefore, the suggested sampling and preservation protocols are equally applicable in coastal as well as in offshore sampling stations, taking into consideration that concentrations of heavy metals and organic contaminants in offshore waters are expected to be lower than in coastal seawater samples. If transects are sampled, the sampling should be done from the open ocean to the coast and not the other way around to avoid contamination of samples from sampling equipment.

3. It is important to collect representative seawater samples from the sampling area, but it is equally important to avoid any alteration of the physical and chemical characteristics of the samples during transportation from the field to the laboratory. Therefore, seawater storage and transportation have to be done under specific procedures, in order to avoid sample alteration and cross contamination from the material of the containers and the transportation environment.

4. To assist countries which plan to include seawater monitoring in their respective national monitoring programmes for CI17, as a country-based decision, Protocols for seawater sampling and sample processing have been prepared. They are not intended to be analytical training manuals, but guidelines for Mediterranean laboratories, which should be tested and modified in order to validate their final results.

5. The Protocols aim at streamlining sampling and processing of seawater samples in a view of assuring comparable quality assurance of the data, as well as comparability between sampling areas and different national monitoring programmes. They provide a step-by-step guidance on the methods to be applied in the Mediterranean area for sampling, sample handling to avoid cross-contamination, as well as the storage conditions in a view of maintaining the sample's integrity during the transfer from the sampling site to the analytical laboratory to ensure the representativeness and the integrity of the samples for analysis.

6. In order to avoid unnecessary repetitions, reference is also made to the protocols already published and publicly accessible, which can also be used by the Contracting Parties' competent laboratories participating in IMAP implementation. Namely, the six here-below elaborated IMAP Protocols build upon the relevant Guidelines developed by GEOTRACES, ICES/OSPAR and HELCOM on seawater sampling and analysis, as provided in Annexes I to III. Given the suitability of any of these Guidelines in the context of IMAP, they can be further used by competent Mediterranean laboratories for developing their lab-specific sampling and sampling processing methodologies.

²⁸⁸ UNEP/MAP (2019). UNEP/MED WG.467/5. IMAP Guidance Factsheets: Update for Common Indicators 13, 14, 17, 18, 20 and 21: New proposal for candidate indicators 26 and 27.

²⁸⁹ UNEP (2019a). UNEP/MED WG.463/6. Monitoring Protocols for IMAP Common Indicators related to pollution.

7. The below flow diagram informs on the category of this Monitoring Guideline related to related to sampling and sample preservation of seawater for the analysis of IMAP Common Indicator 17 within the structure of all Monitoring Guidelines prepared for IMAP Common Indicators 13, 14, 17, 18 and 20.

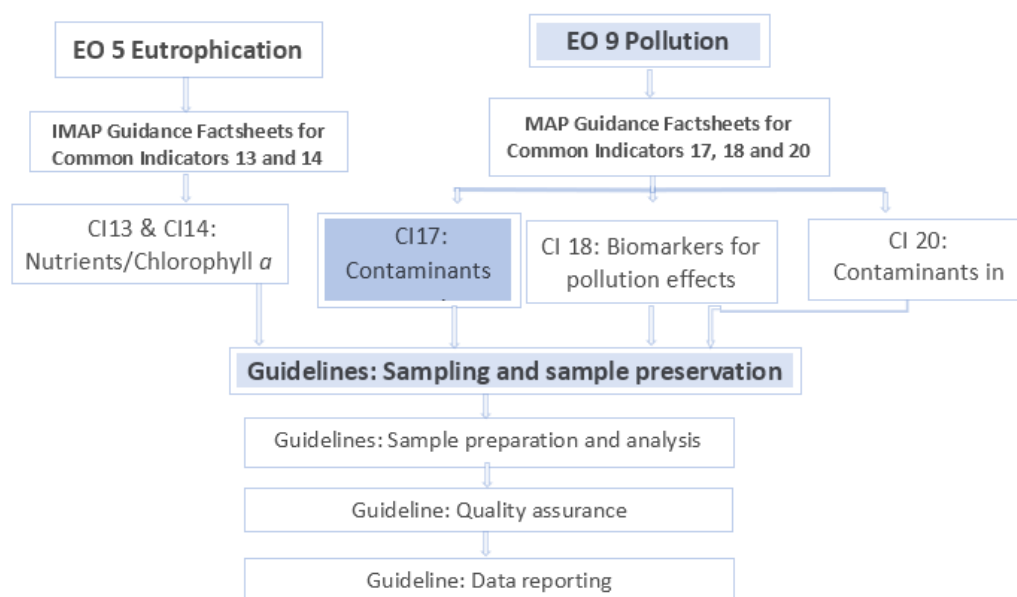

Flow Diagram: Monitoring Guidelines for IMAP Ecological Objectives 5 and 9

2. Technical note for the sampling and pretreatment of seawater for the analysis of heavy metals²⁹⁰ and organic contaminants

8. Seawater sampling should be carried out at the same time and locations as the sampling of other matrices (sediment, biota) and biological effects measurements (ICES/OSPAR, 2012²⁹¹). Sampling, pretreatment and analysis is a complex endeavour requiring careful design and implementation. Due to the very low concentrations of heavy metals in seawater (especially in open sea stations), improper sample handling could easily result in loss of determinant and/or contamination of the sample before analysis. Appropriate sampling and pretreatment protocols are therefore a crucial step in any seawater monitoring programme.

9. The size of the seawater sample has to be sufficient to support the desired detection limits for the contaminants of interest. ICES/OSPAR (2012) guidelines for seawater analysis (Annex I) suggests to collect appropriate seawater volume for analysis in relation to the contaminant's concentration in the specific station (polluted or non-polluted) in such a way that the limit of quantification (LOQ) to be equal to or below a value of 30% of the relevant assessment criterion (i.e. the Environmental Quality Standard, Commission Directive 2009/90/EC²⁹²).

10. There are two ways to approach seawater analysis: a) unfiltered seawater and b) filtered seawater. The analysis of unfiltered water samples gives results on the total concentration of contaminants in seawater, regardless of the chemical forms or particle size (i.e. dissolved, complexed and bound to colloids and to suspended particulate matter (SPM)), therefore important information on

²⁹⁰ The term "heavy metals" is used indicating both heavy metals and trace elements

²⁹¹ ICES/OSPAR (2012). JAMP guideline on monitoring of contaminants in seawater: Annex 1: Guidelines for Monitoring of Contaminants in Seawater. ICES Advice 2012, Book 1

²⁹² EC (2009). Commission Directive 2009/90/EC laying down, pursuant to Directive 2000/60/EC of the European Parliament and of the Council, technical specifications for chemical analysis and monitoring of water status.

the distribution and availability of contaminants is lost. On the other hand, filtration over 0.45 µm mesh separates the filtered seawater (i.e. freely dissolved, complexed and bound to), from the particulate phase of contaminants, which is retained in the filter. However, due to exchanges of contaminants between the chemical forms in the dissolved and particulate phases, as well as to potential influence of the sampling and filtration equipment (filters, containers walls, etc.) the equilibria between dissolved and particulate phases may be altered during the process. Therefore, filtration should be performed in such a way as to minimize the alteration of the seawater sample and the distribution of contaminants between dissolved and particulate phases. Also, in the case of organic contaminants, their distribution between the dissolved and the particulate phases is influenced by their polarity, which can be expressed by their octanol/water coefficient (log Kow; Kow = Concentration in octanol phase / Concentration in aqueous phase). The more hydrophilic compounds with log Kow values of 3 to 4 (such as 2- and 3-ring aromatics and HCH isomers) are mainly found in water, while pollutants with log Kow values >5 (4- to 6-ring aromatics, DDT group, PCBs) mainly found in suspended particulate matter (SPM). Non-polar hydrophobic compounds are associated with SPM, which are separated by filtration, but they are also present in the filtrate adsorbed on colloids. As a consequence, the validation of the phase separation procedures is very difficult.

11. Filtration could be done in-line (from the sampling bottle or the seawater pumping system) or off-line in the laboratory. In-line filtering systems have the advantage of reducing the risk of loss of determinant and/or contamination of the sample from storage bottles or the air. In all cases filtration should be done in an area free of particles as much as possible. Working in a laminar flow hood is the preferable solution. Recommended conditions for a 'clean bench' or a 'cleanlab' are ISO Class 5 (GEOTRACES, 2017²⁹³).

12. Detailed Guidelines for seawater sampling and processing can be found in documents issued by ICES/OSPAR (2012) (I), HELCOM (2012a²⁹⁴) (Annex II), HELCOM (2012b²⁹⁵) (Annex III) and GEOTRACES (2017). Further building on these documents, under this Technical Note, the Guidelines for Sampling and Sample Preservation of Seawater for IMAP Common Indicator 17 provide the following IMAP Protocols for seawater sampling that:

- Protocol for seawater sampling for heavy metals analysis;
- Protocol for seawater filtration (heavy metals);
- Protocol for the on-board storing of seawater samples for heavy metal analysis;
- Protocol for seawater sampling for organic contaminants analysis;
- Protocol for seawater filtration (organic contaminants);
- Protocol for the on-board storing of seawater samples for organic contaminants analysis.

2.1 Protocol for seawater sampling for heavy metal analysis

a) Sampling equipment for seawater collection

13. Usually for metal analysis seawater samples from different depths are collected using GO-FLO bottles (General Oceanics). The sampler consists of a cylinder with an inner Teflon-coating which can be lowered closed into the water column and opens automatically at a certain depth by hydrostatic pressure. This avoids contact of the sample with the water surface film which is enriched in contaminants. Other types of sampling bottles can also be used (such as Niskin bottles) properly modified for avoiding metal contamination.

²⁹³ GEOTRACES (2017). Sampling and Sample-handling Protocols for GEOTRACES Cruises (Version 3), edited by the 2017 GEOTRACES Standards and Intercalibration Committee.

²⁹⁴ HELCOM (2012a). Manual for marine monitoring in the COMBINE programme. Annex B-11, Appendix 1. Technical Note on the determination of trace metals (Cd, Pb, Cu, Co, Zn, Ni, Fe) including mercury in seawater.

²⁹⁵ HELCOM (2012b). Manual for marine monitoring in the COMBINE programme. Annex B-11, Appendix 2. Technical note on the determination of persistent organic pollutants in seawater.

14. All samplers have to be cleaned before the first use by rinsing the inner surfaces with diluted hydrochloric acid. In the open sea, the bottles should be rinsed with seawater between samplings, while in polluted stations they could be rinsed with deionized water.

15. The metallic hull of the ship is a potential source for metal contamination (iron and lead), as is the use of antifouling paints (copper and tin) and the ship's anodic protection (zinc). To avoid metal contamination the ship should be positioned in such a way in relation to the wind and sea current directions, as to minimize any influence from the ship's hull on the seawater samples.

16. Use sampling equipment (such as GO-FLO or Niskin style bottle with a capacity 12-30 l) attached individually at hydrographic wire or placed in a metal-free rosette system (Figure 1).



Figure 1. Individual GO FLO seawater sampler and rosette system with multiple samplers

17. The hydrographic wire should be made of Teflon coated stainless steel, polymer, or Kevlar to avoid metal contamination. All weights used as ballast for lowering the bottles/rosette should be non-metallic or coated with epoxy resins to avoid metal contamination

- i) The sampling bottles are lowered to the designated depths. A depth recorder is fitted to the individual bottles or the rosette system to monitor the sampling depth;
- ii) A non-metallic messenger (or coated with epoxy resins) is used to release the closing valves in both ends of the sampler for individual bottles or use a triggering system to close bottles in a rosette system at the ascending path;
- iii) Once seawater samples have been collected from all sampling depths, the bottles/rosette system is lifted on board;
- iv) Once the sampling equipment is lifted on board, it should be placed in a pre-cleaned plastic bag or other container and then transported to an ISO Class-5 area (or a hood with metal-free filtered air) for further handling;
- v) Seawater samples are transferred from the GO-FLO (or similar sampling equipment) to a pre-cleaned (with dilute HCl or HNO₃) Teflon (or polyethylene) bottles for total metals analysis;
- vi) In case SPM will be analysed separately from the dissolved metal fraction, seawater sample is transferred to the filtration unit, using a pre-cleaned Teflon tubing.

18. Sample contamination from the atmosphere (such as paint and rust particles, engine exhausts and atmospheric background) could be very important and measures have to be taken to avoid it. Therefore, entire seawater handling has to be performed in a dust-free and metal-free environment, under controlled conditions (ISO Class-5 area).

19. Use unpowered latex or nitrile gloves for handling seawater samples to avoid contamination.

b) In-situ seawater pumping (profiles)

20. In-situ seawater pumping from designated depths is an alternative method for seawater collection, which minimises sample's handling, which may result to loss of determinant or/and sample contamination from the air. The pumping system can optionally include in-line filtration, to separate SPM from the seawater filtrate. The method can be used for relatively shallow depths (up to 100 m) using a peristaltic pump or Teflon piston, or diaphragm pumps and tubes made of silicone, polyethylene or Teflon, in order to avoid metal contamination. Prior to use, the tubing should be cleaned by pumping diluted acid (such as HCl or HNO₃). During sampling, the first litres of seawater should be discarded in order to rinse the whole pumping system before the collection of seawater samples. The rinse volume depends on the length of tubing used and one should rinse with at least 3 times the volume of the tubing before taking the actual sample. Before its use in the field, the pump's operation and performance have to be thoroughly checked and optimized. (Figure 2)

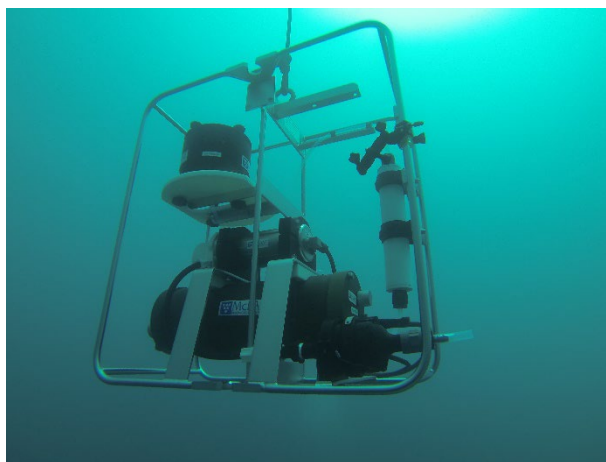

Figure 2. In-situ seawater pumping system (Marine Environmental Studies Laboratory, IAEA)

21. The outflow from the pumping system is collected in metal-free bottles (polyethylene, Teflon, glass). For Mercury analysis water should be collected in glass or quartz bottles. If an in-line system is attached to the pumping device, the filtrate should be stored in metal-free bottles (as above), while the filters with the SPM samples should also be placed in metal free containers.

c) In-situ surface seawater sampling

22. For surface sampling of seawater GEOTRACES (2017) recommends surface pump sipper/tow fish system which consists of:

- i) PTFE Teflon diaphragm pump with silicone pump tubing;
- ii) PFA Teflon sample tubing;
- iii) PVC depressor vane 1 m above a 20 kg weight enclosed in a PVC fish (alternatively a 50 kg stainless steel fish) which does not require a separate depressor;
- iv) Polyester braided line connecting the fish to the depressor (if required) and then to the ship; the Teflon sampling tubing is run along this line;
- v) PFA Teflon tubing is used on the other side of the pump to deliver seawater directly into a clean area for sampling;
- vi) For underway surface sampling at speeds from 1 to 12 knots, the sipper system is deployed off the side of the ship using the ship's crane to suspend the fish outside of the bow wake with the intake at approximately 2-m deep. Faster speeds are possible with this sipper design if there is little or no swell and the sipper remains outside of any breaking bow waves. The sipper design also allows near-stationary sampling (moving forward into clean water at 0.5 to 1 knots) in order to collect large volumes of trace metal-clean seawater at depths up to 25 m.



Figure 3. Surface pump sipper/tow fish system (GEOTRACES, 2017)

d) Cleaning of equipment and lab ware prior to sampling

23. A protocol of lab ware cleaning for seawater sampling equipment for metal analysis is proposed by HELCOM (2012a) (Annex II)

- i) Lab ware is stored in 2M HCl (high purity) for one week, rinsed with water, stored in water for one week and dried under dust-free conditions (clean bench).
- ii) Sampling devices are filled with 1% HNO₃ (high purity), stored at room temperature for three weeks, and rinsed with water.
- iii) Teflon/quartz bottles are stored in warm (40 C ±5 °C) 1:1 diluted HCl for one week. Then rinsed with water and stored with 1M HNO₃ (high purity) until the final use (a minimum of three weeks).

24. Modified cleaning procedures are required for mercury. Glass containers (borosilicate, quartz) used for the collection and storage of samples for the determination of mercury are usually cleaned using an oxidizing procedure described by Sturgeon and Berman (1987²⁹⁶). Bottles are filled with a solution of 0.1 % KMnO₄, 0.1% K₂S₂O₈ and 2.5 % HNO₃ and heated for 2 hours at 80 °C. The bottles are then rinsed with water and stored with 2 % HNO₃ containing 0.01 % K₂Cr₂O₇ or KmnO₄ until ready for use.

25. Detailed protocols for cleaning of sampling equipment and storage bottle are also proposed by GEOTRACES (2017) and ICES/OSPAR (2012) (Annex I).

2.2 Protocol for seawater filtration for heavy metals analysis

a) Filtration procedure: Seawater should be filtered as soon as possible after the samples were taken as otherwise ratio between dissolved and particulate contaminant concentration may change.

In-line filtration

26. Seawater can be directly filtered from pressurized GO-FLO bottles using a low overpressure (<50 kPa, or <7 psi, maximum) of filtered high-quality nitrogen gas or compressed air to obtain a sufficient flow across the filters (GEOTRACES, 2017). Before starting filtration, it is recommended to gentle mixing the GO-FLO bottles because particle settling can occur continuously during the period between GO-FLO closing at depth and initiation of filtration. A pre-cleaned capsule filter or membrane filter holder is connected to the GO-FLO's Teflon plug valve with Teflon PFA tubing (or clean equivalent) and the sample bottles are filled with the effluent from this filter (capsule filters should be rinsed with ca. 0.5 L of sample water prior to collection of the filtrate).

²⁹⁶ Sturgeon, R., and Berman, S. 1987. Sampling and storage of natural water for trace metals. In Critical reviews in Analytical Chemistry. 18(3): 209-244. CRC Press.

Off-line filtration

27. After collection from the GO-FLO sampling bottles, seawater is transferred to a secondary bottle, from which it is sent to the filtration equipment. Off-line filtration yields similar results than in-line filtration if strict trace metal clean working procedures are followed. Therefore it can be used if required by sample handling limitations on board of the sampling vessel. Before starting filtration, it is recommended to gently mix the GO-FLO bottles because particle settling can occur continuously during the period between GO-FLO closing at depth and initiation of filtration. Then drain the seawater into a pre-cleaned transfer bottle, which is cupped and transferred to the filtration area. Volume to filter is suggested to be 5-10 L, which is sufficient to load filters with enough material to exceed filter blanks for nearly all samples and all analytes (GEOTRACES, 2017).

28. Once filtration is completed, the residual seawater can be forced to through the filter using a polypropylene syringe filled with air. This will avoid spillage and loss of particulate material from face of filter when filter holder is opened. The filter holders can then be disassembled and filters carefully removed using Teflon forceps and stored in Petri-slide or similar suitable container and frozen at -20° C.

b) Filters

29. Polycarbonate filters (0.45 µm) are often used for seawater filtration for the analysis of heavy metals (except mercury). The main purpose for choosing a filter is low metal blanks, mechanical strength and ease of handling, relatively high particle load capacity, low tendency to clog completely, and good filtration flow rate. The filters have to be cleaned with 2M HCl (high purity) for a minimum of three weeks, rinsed with deionized water, and stored for one more week in water (HELCOM, 2012a). Then the filters have to be dried in a clean bench and stored in a desiccator until constant weight. The same procedure for drying and weighing should be applied to the filters loaded with SPM (Pohl, 1997²⁹⁷).

30. For the determination of mercury, glass fibre filters (GF/F grade, Millipore type) and Teflon filters are recommended. Cleaning of these filters is comparable to the procedure used for polycarbonate filters (Queremais and Cossa 1997²⁹⁸).

31. Filter diameters depend on the quantity of SPM in the sampling stations. While a filter diameter of 25 mm is sufficient to filter 10 L of seawater without clogging at open sea stations, 47 mm is preferred for shelf-slope stations where particle concentrations are higher. Effort is made to minimize the filter's diameter in order to maximize the particle loading per filter area, and thus lower the filter's blank in relation to the metal concentrations in the SPM.

32. Filter holders made of polypropylene are often used because they compatible with trace metal clean procedures. It important to have perfect sealing capabilities under pressure.

c) Cleaning Filters and filter holders

33. GEOTRACES (2017) proposes the following protocol for cleaning filters and filter holders for trace metal analysis in seawater samples:

- i) A 1000 mL Low Density Polyethylene (LDPE) pre-cleaned bottle is further pre-cleaned by filling with 10% (v/v, or 1.2M) of TM Grade HCl, double bagging in heavy duty (e.g. 4mm) Ziploc polyethylene bags, and placing in oven at 60°C for 4 hrs to overnight.

²⁹⁷ Pohl, C. 1997. Trace Metals (Cu, Pb, Zn, Cd, Al, Li, Fe, Mn, Ni, Co) in Marine Suspended Particulate Matter: An International ICES Intercomparison Exercise. Accreditation and Quality Assurance, 2: 2-10

²⁹⁸ Quémérais, B., and Cossa, D. 1997. Procedures for sampling and analysis of mercury in natural waters. Environment Canada-Quebec region, Environmental Conservation, St. Lawrence Centre. Scientific and Technical Report ST-31E, 34 pp.

- ii) The bottle is removed to fume hood and placed inverted so that lid is acid-leached while acid cools. Acid is poured-out and the bottle is rinsed thoroughly at least 3 times with TM-clean deionized water (e.g., Milli-Q).
- iii) The clean bottle is filled 90% full with TM-clean deionized water.

34. Filters should be removed from the original box using metal-free forceps, grasping filters only on the edge so that the sample region is not damaged, and are carefully dropped into the bottle. Make sure any separator papers from the original packaging are not included. When 100 filters have been immersed in the water, the last 10% of bottle volume are filled with concentrated TM Grade HCl, capped tightly, mixed gently so that the filters do not crease, and the double bagged bottle is placed in a 60°C oven overnight, as for bottle cleaning.

35. When bottle of filters is cool, acid is slowly poured off to waste, retaining filters with the cap held against the bottle mouth. Filters are kept in suspension by gentle hand-agitation while pouring off acid, to minimize folding and creasing while all the solution is removed. The bottle is slowly filled with DI water running gently down the inside wall, while swirling gently, and the water is poured out, retaining filters with the cap. The procedure is repeated 5 times. Leave the last rinse in the bottle and allow to sit at room temperature overnight so that any residual acid diffuses from the pore spaces of the filters. Three more rinses are repeated the next day. Always the pH has to be checked to ensure no acid remains as filters can take many rinses to remove all traces of acid. Filters can be left in the DI water suspension until used on ship, or can be loaded in advance into individual Petri-slides for easy access and storage in the same Petri-slide. Caution has to be used to avoid getting doubled filters, as the filters tend to stick to each other (GEOTRACES, 2017).

2.3 Protocol for the on-board storing of seawater samples for heavy metals analysis

36. Seawater samples should be stored in such conditions as to avoid metal loss or contamination during the transfer from the ship to the laboratory for further pre-treatment and analysis. The usual process for conserving seawater samples for the analysis of trace elements is acidification and freezing. However, any sub-sampling of the seawater samples has to be done on board immediately after sampling. If filtration is required to separate the SPM from the dissolved phase of the sample, it should also be done immediately after sampling and before any acid addition for preservation causes.

37. Seawater samples (filtered or unfiltered, if total metals are to be analysed) are acidified by adding 1.5 ml HNO₃ or HCl (high purity) per litre of seawater sample immediately after filtration, for acidification to pH 1.0-1.6. The bottles are stored at 4 °C in the dark. Filters with SPM should be stored in plastic dishes at -20 C. Under these conditions, both water samples and SPM on filters can be stored for at least one year. For Hg analysis, in addition of acidification oxidation agents should be added (such as Cr₂O₇²⁻). (HELCOM, 2012a)

38. The bottles used for seawater storage should be made of Low-Density Polyethylene (LDPE) or High-Density Polyethylene (HDPE). Bottle caps are usually made of polypropylene, which is suitable material for seawater storage. For Hg, polyethylene bottles are not recommended and instead, glass or Teflon bottles can be used (GEOTRACES, 2017).

a) Sample Bottle Cleaning

39. The cleaning of the bottles used for storage of seawater samples for trace element analysis, should be very thorough to avoid sample alteration from the container. GEOTRACES (2017) proposes a very rigorous protocol for bottle cleaning, which is used by research groups with a long history of successful trace metal clean sampling. The GEOTRACES protocols are as follows:

GEOTRACES protocol for LDPE and HDPE bottles (dissolved and dissolvable trace elements):

- i) The bottles may need to be rinsed with methanol or acetone to release oils from manufacturing.
- ii) Soak bottles for one week in an alkaline detergent (e.g. Micro, Decon). This process can be sped up by soaking at 60°C for one day

- iii) Rinse 4x with Reverse Osmosis/Deionized Water.
- iv) Rinse 3x with Ultra High Pure Water (UHPW) under clean air.
- v) Fill bottles with 6M HCl (reagent grade) and submerge in a 2M HCl (reagent grade) bath for one month. Again, this can be sped up by heating for one week.
- vi) Rinse 4x with UHPW under clean air.
- vii) Fill bottles with 1 M HCl (trace metal grade) for at least one month. Should be stored doubled bagged. Bottles should be emptied of all acid before transporting to the ship.
- viii) Rinse with UHPW and ship the bottles empty and double bagged.

GEOTRACES protocol for PFA Teflon bottles:

- i) Soak bottles for one day in an alkaline detergent;
- ii) Rinse 7x with Deionized Water (DIW) thoroughly until there is no trace of detergent;
- iii) Rinse 3x with UHPW;
- iv) Soak in 6 M reagent grade HCl bath for 1 day;
- v) Rinse 5x with UHPW;
- vi) Fill bottles with 1M nitric acid (analytical grade) and keep them at 100°C for 5 hours in a fume hood'
- vii) Rinse 5x with UHPW water inside an ISO Class-5 laminar flow hood;
- viii) Fill bottles with UHPW water and keep them at 80°C for 5 hours;
- ix) Rinse 5x with UHPW water inside an ISO Class-5 laminar flow hood. Should be stored doubled bagged.

2.4 Protocol for seawater sampling for organic contaminants analysis

a) Sampling equipment for seawater collection

40. Concentrations of organic contaminants in seawater are usually very low, therefore in order to reach the Limit of Quantification (LOQs) required for such contaminants (in pg l^{-1}) large water volumes should be collected (sometimes more than 100 litres) to be extracted to avoid interferences from the matrix background (ICES/OSPAR, 2012) (Annex I). However, large seawater volumes cannot be easily handled and transported, therefore on-board seawater extraction solves a lot of logistics' problems as well as avoids alteration of seawater samples characteristics. The in-situ filtration/extraction equipment has in addition the advantage of short exposure of the seawater sample to the atmosphere.

41. For seawater sampling or the analysis of organic contaminants, equipment is preferably made of glass or stainless steel. Teflon-coated equipment can also be used for Persistent Organic Compounds and PAHs.

42. Glass bottles are an appropriate sampling equipment for the analysis of organic contaminants. The bottles are mounted in a stainless-steel cage and are lowered on a hydrographic wire down to the desired sampling depth, opened under water and then lifted to the deck of the ship. The glass sampler can be used to a depth of 2000 m (10 l) and 100 m (100 l) (ICES, 2012) (Figure 4). For greater depth stainless steel bottles, based on the Niskin and GO-FLO design can be used. A depth recording system is fitted on the steel case, to allow seawater collection from the desired depth.



Figure 4. Glass bottle for seawater sampling for organic contaminants analysis (ICES/OSPAR 2012)

43. All samplers have to be cleaned before the first use, with appropriate organic solvents. In the open sea, the bottles should be rinsed with seawater between samplings, while in polluted stations they could be rinsed with deionized water.

44. Once the sampling equipment is lifted on-board, it should be placed immediately in an aluminium or stainless-steel container and transported to a clean-room (or a hood with dust-free filtered air) in the ship's laboratory, for further handling. Sample contamination from the atmosphere (such as PAHs from the engine exhausts) or the ship (i.e. PCBs in lubricating oil) can lead to sample contamination, therefore measures have to be taken to avoid it, including the positioning of the ship in relation to the wind and sea current directions in order to minimize any influence from the ship. All seawater handling has to be performed in a dust-free environment, under controlled conditions.

b) Sampling by pumping – *In situ* filtration and extraction

45. In-situ seawater pumping from designated depths is an alternative method for seawater collection, which minimises sample's handling that may result to loss of determinant or/and sample contamination from the air. The pumping system can optionally include in-line filtration, to separate SPM from the seawater filtrate. The in-situ filtration followed by a solid-phase extraction minimizes the risk of sample contamination during sampling. The pumping system includes a glass fibre filter (pore size 0.7 μm) to collect the particulate phase and a glass column packed with polymeric resin for the dissolved phase. The pumping system is operated in a similar manner as for heavy metal analysis (paragraph 17). Volumes of 1 to 100 l can be sampled by discrete sampling and/or pumping and are usually extracted either by liquid-liquid extraction (LLE) or solid phase extraction (SPE), while larger volumes are generally sampled by pumping and extracted by solid phase extraction (ICES/OSPAR, 2012).

46. Details on the calibration of the situ pumping system are provided by the pump's manufacturer. Before its use on the field, the pump's operation and performance has to be thoroughly checked and optimized.

2.5 Protocol for seawater filtration for organic contaminants analysis

a) Filtration/extraction procedure

47. The concentrations of organic contaminants in seawater are very low (LOQ are at the pg l^{-1} range). Therefore, large water volumes (10 to 100 l or more) need to be filtered and extracted to overcome blank problems. Because hydrophobic compounds occur in dissolved, colloidal, and particulate-bound forms, filtration should be done in such a way as to avoid the alteration of the organic compounds partitioning between dissolved and particulate phases because of handling artefacts. It is therefore preferable that filtration is done immediately after sampling.

In-situ filtration/extraction

48. In order to minimize alteration of organic contaminants partitioning between phases, as well as contamination from the air, in-situ filtration/extraction can be done with a submersible water pump. The in-situ filtration/extraction is compact and combines the advantages of small size and short exposure to the atmosphere (HELCOM, 2012b). The pump, which includes a filter holder, a polymeric resin column, a pump, and a flow-meter, is deployed at a designed depth on a hydrographic wire and the pumping is started and ended by remote control. A glass fibre filter (pore size 0.7 μm) recover the particulate phase and a glass column packed with polymeric resin the dissolved phase. Since the submersible pumps have usually some plastic parts and connections, before use the pump should be checked for targeted organic contaminants blanks, in order to make necessary replacements of parts with stainless steel or glass (if possible) to reduce contamination. Surrogate standards can be added to the resin column before sampling to control the extraction recoveries and storage. The in-situ pump sampling method has to be validated before its use (ICES/OSPAR, 2012).

Off-line filtration

49. Storage of seawater samples for the determination of organic contaminants is impractical because of the large seawater volumes required for the quantification of the determinants. Furthermore, the storage period of seawater samples before extraction should be limited (less than 2 hours, HELCOM, 2012b) and it is recommended to extract the water sample as soon as possible after sampling. Also, it is preferable to avoid transfer of seawater to another container, as well as unnecessary manipulation that may lead to the alteration of the sample's characteristics. Sampling bottles have to be carefully moved to the clean area of the on-board laboratory (IMAP Protocol 2.4. on seawater sampling for organic contaminants analysis) to proceed to filtration and extraction.

50. The sampling bottles are connected to a glass fibre filter (pore size 0.7 μm) for recovering the particulate phase and the dissolved phase in extracted on board by liquid-liquid extraction (LLE) or solid-phase extraction (SPE). The extracts or adsorbent cartridges are stored under cool ($< 4^{\circ}\text{C}$) and dark conditions.

b) Filters

51. Filtration is done using Glass Fibre filters (GF/F) (0.7 μm pore size). Flat-bed filters have a very limited capacity, therefore coiled glass fibre filters are often used for volumes larger than 10 l and water samples with high amounts of suspended matter. A pump is necessary to force the water through the filter (HELCOM, 2012b).

c) Cleaning Filters and filter holders

52. In many cases, the procedural detection limit is determined by the blank value. In order to keep the blank value as low as possible, the compounds to be analysed or other interfering compounds should be removed from the filters and all glassware and tubing used in filtration.

53. A cleaning procedure for all equipment and materials used in handling and processing seawater samples for organic contaminants analysis is proposed by HELCOM (2012b):

- i) Glassware should be thoroughly washed with detergents and rinsed with an organic solvent prior to use. Further cleaning of the glassware, other than calibrated instruments, can be carried out by heating at temperatures $> 250^{\circ}\text{C}$.
- ii) All solvents should be checked for impurities by concentrating the amount normally used to 10 % of the normal end volume. This concentrate is then analysed in the same way as a sample by HPLC or GC and should not contain significant amounts of the compounds to be analysed or other interfering compounds.
- iii) All chemicals and adsorption materials should be checked for impurities and purified (e.g., by heating or extraction), if necessary. Soxhlet thimbles should be pre-extracted. Glass fibre thimbles are preferred over paper thimbles. Alternatively, full glass Soxhlet thimbles, with a G1 coarse efficiency glass filter at the bottom, can be used. The storage of these super-cleaned materials for a long period is not recommended, as laboratory air can contain PAHs that will

be adsorbed by these materials. Blank values occurring despite all the above-mentioned precautions may be due to contamination from the air.

54. As the concentrations of the PAHs and chlorinated hydrocarbons in seawater are very low, it is very difficult to control blank and contamination problems. Therefore, it is recommended to rewash all equipment (vials, pipettes, glass bottles) with solvent just before use. If possible, critical steps should be done in a clean bench.

2.6 Protocol for on-board storage of seawater samples for organic contaminants analysis

55. Seawater can be stored in glass bottles to avoid contamination and minimize the adsorption of the organic contaminants on the surface of the bottle. However, because very lipophilic compounds such as 4- to 6-ring PAHs, DDT, PCBs, tend to adsorb on every surface, samples should be extracted as soon as possible after sampling. The best procedure is to extract the samples by liquid-liquid extraction (LLE) or solid-phase extraction (SPE) and to store the extracts or adsorbent cartridges under cool ($< 4^{\circ}\text{C}$) and dark conditions. The extracts in organic solvents are less susceptible to adsorption onto surfaces (HELCOM, 2012b). If, however, seawater samples must be stored, this should also be in the dark and in a refrigerator (4°C) (ICES/OSPAR, 2012).

56. Suspended Particulate Matter (SPM) samples after filtration should be refrigerated (-20°C) and kept stored frozen until further analysis.

Appendix 20

ICES/OSPAR (2012). JAMP guideline on monitoring of contaminants in seawater: Annex 1: Guidelines for Monitoring of Contaminants in Seawater. ICES Advice 2012, Book 1, (3.1.1)

1.5.5.4

Special request, Advice May 2012

ECOREGION **General advice**
SUBJECT **Development of a JAMP guideline on monitoring of contaminants in seawater**

Advice summary

ICES has developed a guideline document on monitoring of contaminants in seawater under the Joint Assessment and Monitoring Programme (JAMP) (Annex 1). The document also includes a technical annex on specifics of suitable sampling equipment. ICES advises that the document is included in the JAMP guidelines.

Request

Development of a JAMP guideline on monitoring of contaminants in seawater (OSPAR 2011/1)

To develop the general text for a JAMP guideline on monitoring contaminants in seawater, which could act as the overarching chapeau to technical annexes concerning specific substances. The technical annex on analysis of PFC compounds in seawater developed by ICES in 2009 is the first such document. The development of the overarching text should take into account the need to address the following issues: purposes; quantitative objectives; sampling strategy; sampling equipment; storage and pre-treatment of samples; analytical procedures; analytical quality assurance; reporting requirements.

ICES advice

ICES has developed guidelines for monitoring of contaminants in seawater (Annex 1), complementing the corresponding JAMP Guideline for Monitoring of Contaminants in Sediment and JAMP Guideline for Monitoring of Contaminants in Biota. The guideline document in Annex 1 covers monitoring for organic contaminants and trace metals and is structured along the sections outlined in the request (purposes, quantitative objectives, sampling strategy, sampling equipment, storage and pre-treatment of samples, analytical procedures, analytical quality assurance, and reporting requirements). In addition, an annex to the guideline has been developed on technical specifics of the sampling equipment suitable for subsequent analysis of organic contaminants and trace metals. The document includes references to the EU Water Framework Directive (WFD) and EU Marine Strategy Framework Directive (MSFD) where applicable.

ICES advises that this document is included in the JAMP guidelines.

Source

ICES. 2012. Report of the Marine Chemistry Working Group (MCWG), 20–24 February 2012, Southampton, UK. ICES CM 2012/SGHIE:05.

Annex 1: Guidelines for Monitoring of Contaminants in Seawater

1. Introduction

These guidelines provide advice on the sampling and analysis of seawater, for determination of trace metals and organic contaminants, including oceanic, coastal, and estuarine waters. Monitoring contaminants in seawater is a complex task which requires carefully designed and conducted sampling campaigns, appropriate sampling equipment and its correct handling, as well as suitable pre-treatment and storage methods for the analytes in question. There are numerous steps that will affect data quality prior to the chemical analysis itself.

Contaminants in seawater can originate from direct point sources, riverine discharges, and atmospheric dry and wet deposition. Their distribution in seawater depends on the physical-chemical characteristics of the compound or element, interactions with the water matrix, sediment and biota as well as hydrographical conditions, such as mixing of water masses. Organic contaminants and metals can occur freely dissolved in water, bound to colloids, or suspended particulate matter. Trace metals can form complexes with organic or inorganic material. This partitioning is the result of environmental conditions and the partitioning may change during sampling and storage, and has implications for analysis and interpretation.

These guidelines are general recommendations on contaminant monitoring in seawater. The techniques described are useful for routine monitoring and ship/campaign-based work. However, this guideline is not intended as a complete laboratory manual. Requirements for specific contaminants or contaminant groups should be further specified by expert groups, for example in associated technical annexes, in order to meet the objectives of the monitoring programme and to ensure consistent and comparable data sets.

2. Purposes

Monitoring of contaminants in seawater of the Northeast Atlantic Ocean is performed within the framework of OSPAR as the regional convention for the protection of the marine environment of this area. OSPAR monitoring also can assist member states of the European Union to fulfil their obligations under the relevant EU directives, such as the Marine Strategy Framework Directive (MSFD) (EU, 2008) and the Water Framework Directive (WFD) (EU, 2000) with its related directives such as the daughter directive on Environmental Quality Standards in the field of water policy (2008/105/EC).

One of the aims of OSPAR's Hazardous Substances Strategy is that concentrations of naturally occurring chemicals should approach background concentrations, and concentrations of man-made chemicals should be zero. Progress on the implementation of this strategy is monitored through the Joint Monitoring and Assessment Programme (JAMP) of chemicals for priority action and hazardous substances in general. The main objectives of the JAMP for the period 2010–2014, which seek to support the implementation of the OSPAR strategies and the EU MSFD are:

1. the continued implementation and development of existing OSPAR monitoring programmes and, where necessary, the development of additional coordinated monitoring programmes to take account of criteria, methodological standards and indicators for good environmental status, and the pressures and impacts of human activities;
2. development of tools for the delivery of integrated environmental assessments of the OSPAR maritime area or its regions, linking human activities, their pressures, the state of the marine environment, and management responses. Where relevant, these tools should support the exploration of new and emerging problems in the marine environment;
3. the preparation of integrated environmental assessments of the implementation of the OSPAR strategies, including in particular the assessment of the effects of relevant measures on the improvement of the quality of the marine environment. Such assessments will provide additional information and assessments in respect of the MSFD, enhance the OSPAR quality status reports (QSRs), take into account the Directive's obligations for regional cooperation, and help inform the debate on the development of further measures.

Aqueous inputs (direct or riverine) of contaminants, together with atmospheric deposition, are important sources of contaminants to OSPAR marine waters. Dynamic equilibria exist between the dissolved fractions of the total burden of contaminants, such that contaminants are partitioned between the dissolved state and particulate and colloidal phases in the water column, as well as becoming associated with bottom sediments and biota. The rates of exchange of contaminants between the water and the sediment or biota mean that changes in inputs are likely to be reflected more rapidly in the water than in, for example, bottom sediments. However, this sensitivity to change, and the partitioning between components of the aqueous phase, are also reflected in relatively high spatial and temporal variances in the observed concentrations. The selection of water as a monitoring matrix can therefore be appropriate for a number of reasons. These include the ability to observe short-term variations in contaminant pressure on organisms. Focusing on contaminants that partition strongly into the water rather than the sediment or biota can lead to water being the preferred

matrix for monitoring. OSPAR background documents on chemicals for priority action may provide valuable information with regard to the preferred monitoring matrix. In the context of the JAMP, coordinated monitoring of contaminants in seawater may be carried out in relation to the temporal changes in the degree of pollution, its spatial variation, or as an element of integrated monitoring and assessment of contaminants and biological effects.

Temporal trend monitoring can assess the effectiveness of measures taken to reduce contamination of the marine environment. The statistical assessment of a trend over a longer period also supplies a more reliable assessment for the environmental status within a certain period. The fitted value of the last year measured has been used in OSPAR CEMP assessments as the optimum value for comparing against assessment criteria and hence for assessment of the actual environmental status. In such a way, the within- and between-year variability is taken into account.

Spatial distribution monitoring can describe the existing level of marine contamination widely through the convention area. The measured levels can be compared to background or close to background concentrations, as well as to levels describing thresholds below which no chronic effects are expected to occur in marine species, i.e. environmental assessment criteria (OSPAR, 2009).

Contaminant analysis of seawater can be an element of integrated monitoring and assessment, where chemical and biological effects measurements are combined, in order to assess potential harm to living resources and marine life (OSPAR, 2012). The role of chemical measurements in integrated chemical and biological effects monitoring programmes is to support biological effects programmes by providing information to help identify the chemical causes of observed biological effects. In general, chemical measurements in seawater should contribute to improve and extend OSPAR's monitoring framework and better link it with the understanding of biological effects and ecological impacts of individual substances and the cumulative impacts of mixtures of substances.

Furthermore, beyond the objectives of the JAMP, monitoring of contaminants in water can provide information on the fate of contaminants in the environment, e.g. transformation, partitioning, and transport processes.

3. Quantitative objectives

Seawater monitoring should provide concentrations of target analytes in water, which are representative of the location and time of sampling. General considerations regarding the specification of quantitative objectives for monitoring are given in the JAMP (OSPAR, 2010). More specifically, the following issues should be considered prior to water monitoring: contaminant speciation, detection limits, detectability of temporal and spatial trends, and costs.

3.1. Contaminant speciation

Trace metals and organic contaminants can exist as freely dissolved species in water or bound to colloids and suspended particulate matter (SPM). Trace metals can also exist as inorganic and organic complexes. The targeted contaminant fraction determines which sampling and/or pre-treatment method to use:

- Analysis of unfiltered water samples yields the sum of the concentrations of contaminants that are freely dissolved, complexed, and bound to colloids and SPM. These samples are also referred to as total water or whole water samples.
- Filtered water samples can yield the concentrations in SPM (by analysis of the residue on the filter) and the concentrations of contaminants that are freely dissolved, complexed, and bound to colloids (filtrate). However, many organic contaminants are known to exchange freely between dissolved and other phases in the water. The removal of components of the particulate matter is very likely to alter the position of these equilibria, while the introduction of filter material, container walls, etc. provides additional phases taking part in the equilibration processes. The complete separation of dissolved, colloidal, particulate matter is therefore a difficult task.
- Passive sampling yields the concentrations of freely dissolved contaminants (organics) or freely dissolved and complexed contaminants (trace metals).

The choice of the targeted contaminant fraction may be pre-defined by legal obligations. For example, monitoring under the Water Framework Directive requires the monitoring of metal concentrations in filtered water, and of organic contaminants in total (i.e. unfiltered) water.

3.2. Detection limits

The sample size has to be sufficient to support the desired detection limits for the contaminants of interest, for example to enable descriptions of spatial and temporal trends. For example, one litre discrete water samples may be sufficient for time trend monitoring of PAHs in contaminated harbours, but may be insufficient for monitoring programmes in open waters. For consistency with Commission Directive 2009/90/EC, a limit of quantification (LOQ) should be equal to or below a value of 30% of the relevant assessment criterion, e.g. the Environmental Quality Standard.

3.3. Statistical significance and power

In the context of temporal trend monitoring, it is important to know the statistical power of a time-series to detect changes, i.e. the probability of detecting true trends in concentration in the presence of variance associated with sampling, analysis, and field variability. The necessary or possible power of a monitoring programme will vary with the contaminant and area being investigated. One approach would be to estimate the power of the time series based on the “random” between-year variation. Alternatively, the lowest detectable trend could be estimated at a fixed power. A quantifiable objective could be to detect an annual change (dC/dt) of 5% within a time period of 6 years with a power of 90% at a significance level (α) of 5%. In the case of an expected decrease, the null hypothesis would be chosen as $dC/dt=0$ and the alternative hypothesis as $dC/dt < 0$.

A spatial monitoring programme should enable Contracting Parties to describe the distribution of contaminant concentrations in the survey area, for example to draw maps. These data can provide information to assist in the identification of representative stations for temporal trend studies, or for refinement of spatial surveys, and to implement measures where considered necessary. Statistical procedures can be used to estimate the number of samples and sampling sites needed to meet the required confidence level (i.e. to avoid Type I errors) and statistical power (to avoid Type II errors).

3.4. Costs

The concentrations of contaminants in water, as determined by discrete sampling, are commonly found to be quite variable, both in space and time, and meeting ambitious quantitative objectives may require extensive replication. Seawater sampling for contaminant analysis often requires equipment that is expensive to buy and maintain in good condition to keep the process blanks at low levels. The need for, and cost, of replicate water samples should be carefully considered in determining achievable quantitative objectives for a water-based monitoring programme. Therefore, it is often necessary to balance the scope and performance of monitoring programmes with available budgets.

4. Sampling strategy

The sampling strategy should reflect the purpose of the monitoring programme according to the JAMP (OSPAR, 2010) in relation to the OSPAR Hazardous Substances Strategy. Where applicable, the sampling strategy should consider requirements of the EU WFD (EU, 2000) and MSFD (EU, 2008); in all cases the quantitative objectives of the monitoring programme should be met (see Section 3). In accordance with the JAMP Guideline on Integrated Monitoring of Contaminants and Their Effects, seawater sampling should be carried out at the same time and locations as the sampling of other matrices (sediment, biota) and biological effects measurements (OSPAR, 2012).

A coherent approach to the detailed definition of a sampling strategy should take into account knowledge of the physical and biological oceanography of the area and requires consideration of temporal sources of field variance, such as seasonal factors, and spatial factors, such as the changes in location and water depth within the survey area. The analyte in question (its physical-chemical characteristics and expected concentration), as well as environmental conditions and practicalities, will further determine how samples are taken, e.g. what equipment is used and what volumes are required. However, sampling strategies also include compromises between scientifically advisable approaches and the economical and logistical frames of the sampling effort (see Section 3). It is therefore important that the objectives of monitoring programmes are expressed in quantitative terms and that they are achievable.

4.1. Temporal trend monitoring

The ability of a programme to identify temporal trends strongly depends on the extent to which unwanted sources of variability can be controlled. The short-term (< 1 year) temporal variability of contaminant concentrations in water is potentially very large. Concentrations may be subject to day-night variations in input and removal processes (Jaward *et al.*, 2004). In addition, concentrations at a fixed geographical position may vary over the tidal cycle (e.g. in estuaries). Further temporal variability may arise from variation in local inputs, such as discharges from ships, seasonality in the riverine discharge, changes in atmospheric deposition during rainfall events, and seasonal differences in seawater stratification. Some measures can be taken to reduce short-term temporal variability. These include sampling at pre-defined times of the year and at the same phase of the tidal cycle (e.g. always at high tide), although for ship-based discrete sampling it should be recognized that logistic constraints do not always allow such measures to be taken.

4.2. Spatial distribution monitoring

Analyte concentrations in seawater will vary between locations and with water depth, due to various physical and biogeochemical processes and the distribution of inputs. The expected spatial variability is an important factor in the development of an adequate geographical sampling scheme, i.e. the outline of the station grid and its vertical resolution (Brügman and Kremling, 1999). It should be recognized that the identification of spatial patterns may be obscured by

temporal variability (see Section 3.1), and that the same measures to reduce this source of variability also apply here. If the aim of the programme is to identify local sources of contaminants, then the sampling grid should be denser in the vicinity of suspected sources. Often, the variability of salinity or SPM content of the water can give an indication of the variability of pollutants and may even act as "normalization" factors.

4.3. Sampling method considerations

The proportion of the total concentration of a contaminant which is freely dissolved in the water phase increases with polarity of the pollutants (see Section 3). On the other hand, non-polar pollutants sorb to SPM and sediments and are thereby removed from the water column by sedimentation. For these contaminants, additional factors that should be taken into account are the SPM content and the volume of water that is sampled (see Section 3). These factors are important in filtration-extraction methods because the particle-bound and colloiddally bound contaminant fractions that escape phase separation depend on the extent of filter clogging (Hermans *et al.*, 1992). The measurement of SPM concentrations is even more important for monitoring contaminants in total water. The required water volume should be estimated before the sampling campaign, taking into account the method detection limits (see Section 3).

4.4. Supporting data

It is important that as much information as possible is collected concerning the waterbody being sampled. This includes co-factors such as salinity, SPM concentrations, and temperature. Whenever possible, sampling should be done as part of an integrated monitoring programme that includes the measurement of biological effects. These data should be obtained at the same time and locations as sampling for contaminant analysis.

4.5. Statistical considerations

Prior to starting a full-scale monitoring study, the available information on temporal variability should be carefully evaluated, possibly amended by a small-scale pilot programme. This evaluation should include a statistical assessment certifying that the objectives of the monitoring study can be met (see Section 3).

If no previous information exists, the sampling strategy can be based on a combination of general statistical principles and expert knowledge about sources and fate of the studied substances in the investigated sea basin. The statistical approach could include the principles of stratified sampling: First, the sampling area under consideration is partitioned into smaller more homogeneous areas, so-called strata. This can be based on simple information, such as depth, distance to land, or measured or modelled salinity. A successful stratification is characterized by a small variation of the measured concentrations within each stratum and a substantial variation between strata. For optimal allocation of the samples, the size (volume or area) of each stratum should be determined. Assuming that there are m strata with volumes V_1, \dots, V_m and that the standard deviation of the target variable is about the same in all strata, the number of samples n_j in stratum j shall be taken approximately proportional to the volume V_j , i.e.

$$n_j \approx n \frac{V_j}{V}$$

where V is the total volume of the investigated sea basin and n is the total number of samples.

If the standard deviation of the target variable varies from stratum to stratum, more samples should be taken in strata with high standard deviation. More specifically, the sample numbers chosen should aim at making n_j proportional to $S_j V_j$, where S_j is the standard deviation in the j th stratum, i.e. letting

$$n_j \approx n \frac{S_j V_j}{\sum_{j=1}^m S_j V_j}$$

Finally, the average concentration in the study area is estimated to be

$$\sum_{j=1}^m V_j \bar{X}_j / V$$

where \bar{X}_j is the average observed concentration in the j th stratum.

4.6. Discrete sampling versus time-integrated sampling

Concentrations of contaminants in water respond quickly to changes in inputs and other environmental conditions, unlike concentrations in sediments and biota. This low level of time integration can be of advantage in detecting peak events but, on the other hand, concentrations in water are likely to show relatively high variability, which can have drawbacks in long-term monitoring and may require high sampling frequencies, causing high costs.

The influence of temporal variability may be reduced by time-integrated sampling. However, continuous water intake over a prolonged time period, followed by filtration and extraction, may often prove to be impractical and costly, particularly for ship-based sampling programmes. Unattended integrative devices, such as passive samplers (PSDs) also yield a time-integrated concentration if the necessary calibration parameters are available for the target analytes. Considerations for evaluating whether the necessary PSD calibration parameters are available for non-polar organic analytes are given by Lohmann *et al.* (2012). PSDs for polar contaminants (pharmaceuticals, detergents, and personal care products) are insufficiently mature for quantitative spatial and temporal trend monitoring at present, but may be useful in initial surveys. Diffusive gradients in thin films (DGT) is a mature PSD technique for trace metals, but its application in the marine environment has been quite limited so far (Mills *et al.*, 2011). All PSDs require suitable deployment sites, such as jetties, buoys, bottom landers, long-term moorings, etc, which always have to be visited twice and some losses due to other marine activities may be expected. If the monitoring programme requires sampling of total water, this will limit the applicability of PSDs.

5. Sampling equipment

The choice of sampling equipment depends on the physical-chemical properties and expected concentrations of the analytes, on the depth and location of the sampling site, and on the available infrastructure. All materials used for the sampling equipment (sample containers, tubing, connectors, valves, pumps, filters) should neither absorb nor release the target analytes, or any non-target substance that interferes with the chemical analysis. Contaminants are held in a range of dissolved, colloid, and particulate phases. These have a potential to interact differently with sampling equipment, and also for contaminants to exchange between phases during sample processing. Sampling equipment and processing therefore needs to be rigorously tested before adoption in large-scale monitoring programmes.

Since concentrations of organic contaminants and metals in seawater are usually very low, large volumes of water must be sampled. Contamination of the sample by compounds that leach out of the sampling equipment as well as analyte loss due to wall sorption are serious issues which may affect the integrity of seawater samples.

Sample contamination from the atmosphere should be avoided (e.g. paint and rust particles, engine exhausts, atmospheric background). To minimize contamination from the atmosphere, the surfaces of the sampling equipment in contact with the sample should be isolated from the atmosphere before and after the sampling, including storage of the equipment. These surfaces should be cleaned using appropriate solvents prior to sampling. Equipment blanks and recovery samples yield important quality control information that can be used to assess sample contamination and analyte losses, bearing in mind the potentially site-specific nature of airborne contamination.

Concentrations of target analytes in the water may be elevated because of leaching from the sampling platform itself (e.g. polyaromatic hydrocarbons (PAHs), organotin, polychlorinated biphenyls (PCBs), iron, and chlorofluoroalkanes can be released from the ship during ship-based sampling). The ship's keel should be at an angle of 20 to 40 degrees to any current coming from the bow at the sampling side (typically starboard side), to minimize any influence from the ship's hull.

Since the sampling equipment passes through the air-water interface, contamination from the sea surface microlayer is a significant risk. Concentrations of dissolved and particulate matter are elevated in this microlayer, and the associated analytes may therefore contaminate samples that are taken at larger depth. Sample contamination from the microlayer can be avoided by closing the sampling equipment during passage through the sea surface and only allowing sample intake at the intended depth.

5.1. Trace metals (including MeHg)

Contamination from the ship has to be avoided at all times. For analyses of trace metals, all contact between the seawater sample and metal must be avoided. On approaching a station, the sampling for trace metals has to be performed immediately. Hydrographical information about water depth and the stratification of the water column should be available.

Discrete samplers that are specially designed for trace metal analysis should be used, e.g. GO-FLO (from General Oceanic), available in sizes from 1.7 to 100 litres, or MERCOS samplers (from Hydrobios; or modified version, size 0.5 litre). They are typically operated on a Teflon, polymer, or Kevlar jacketed stainless steel hydrographic wire, tensioned

by a coated bottom weight. The messengers should also be free of metals; any essential metal parts should be of seawater resistant stainless steel (V4A).

Samples should be taken so as to avoid contamination by leachate from the hull of the ship. Sampling bottles should be made of plastic with low metal content, e.g. special low-density polyethylene (LDPE) bottles. For mercury, glass should be preferred if the samples are stored for a longer period. Teflon bottles may also be used, but they are relatively expensive and, depending on the manufacturing process, may have a relatively rough inner surface.

Pumping using metal-free devices may be an alternative to discrete sampling, e.g. for separating SPM by subsequent centrifugation, but is not preferable when sampling from a ship at distinct sampling depths or in the open sea where concentrations are very low. More details on sampler types are described in the Technical Annex.

After sampling, the sampler should be placed immediately in a plastic bag or box or an aluminium container (if aluminium is not determined), followed by transport to a clean-room or laboratory with a clean-air bench. These measures are particularly critical for open sea samples where the expected concentrations of trace metals are very low.

5.2. Organic contaminants

Concentrations of organic contaminants in seawater are usually very low. In order to reach the projected LOQs in the low pg l^{-1} range, large water volumes (10 to 100 l or more) have to be collected and extracted. With modern analytical equipment, these LOQs are often not limited by the signal intensity in the instrumental analysis, but by blank levels and interferences from the matrix background.

Hydrophobic compounds occur in a continuum of dissolved, colloidal, and particulate-bound forms. Unless a total concentration is to be determined, the compound partitioning must not be altered during sampling and subsequent treatment. This is very challenging, as the separation process must be contamination-free and should not change the concentration distribution. It should be applied during or immediately after sampling. For details, see Section 6.2.

Sometimes blank problems can only be overcome by increasing the sample size. However, the maximum sample size may be limited by operational constraints, such as container size for discrete samplers, pumping time, and the ability to process large water volumes. Blank levels can be reduced by minimizing the size of the sampling equipment (e.g. short inlet tubes) and by using sampler designs and handling procedures that minimize exposure to the atmosphere (short assembly/disassembly times). The use of *in situ* filtration/extraction equipment that is both compact and easy to operate combines the advantages of small size and short exposure to the atmosphere. This holds even stronger for passive samplers (see Section 4.6), provided that the sampling phase is sufficiently clean and that times of exposure to the atmosphere during deployment and retrieval are sufficiently short.

The materials used for the sampling equipment depend on the target contaminants. Sampling equipment for organic contaminants in seawater is preferably made of glass or stainless steel. Teflon parts are often used for legacy persistent organic pollutants (POPs), while they cannot be used for sampling of fluorinated compounds. Before use, the equipment has to be cleaned, e.g. rinsed with appropriate organic solvents. Examples of sampling equipment suitable for organic contaminants are presented in the Technical Annex.

6. Storage and pre-treatment of samples

The storage and pre-treatment of samples should be carried out in full awareness of the risks of contamination or analyte loss if samples are handled incorrectly. Appropriate measures should be taken to avoid contamination, such as wearing clean gloves, pre-cleaning equipment, etc. All storage and pre-treatment steps should be fully documented for each sample. Field control samples (for assessing sample contamination) and surrogate spikes (for assessing analyte losses) should be processed regularly as part of the quality assurance and control procedures (see Section 8). All storage and pre-treatment steps should be fully validated prior to the start of a monitoring programme.

6.1. Storage

It is advisable to process samples as soon as possible rather than store them for a longer period of time. Storage of samples increases the risk of changing concentrations, by microbial degradation or sorption processes. However, appropriate laboratory facilities for handling of samples for trace analyses need to be available. If this is not the case, samples may have to be conserved. Water samples for metal analysis are typically acidified for conservation purposes. Sub-sampling of seawater, if required, should preferably be performed immediately after sampling.

Water samples for organic pollutants generally are impractical to store because of their large volumes. Instead, they are extracted onboard by liquid-liquid extraction (LLE) or solid-phase extraction (SPE) and the extracts or adsorbent cartridges are stored under cool ($< 4^{\circ}\text{C}$) and dark conditions. If water samples must be stored, this should also be in the

dark and in a refrigerator (4°C). Preferably, internal standards (e.g. isotopically labelled analogues) should be added before extraction or/and storage. Storage times should be kept as short as possible and the stability of all compounds during storage must be checked.

Only appropriate (pre-cleaned) containers should be used for short- or long-term storage. The analytes of interest determine the appropriate container material (plastic, glass, metal), the need for acidification, and the optimal storage temperature. All storage conditions should be fully validated by the laboratory that carries out the monitoring, since sample contamination and loss of analyte may be affected by subtle changes in the materials and procedures for sample storage. SPM samples should always be stored frozen until further analysis.

6.2. Sample pre-treatment

The need for filtration of samples is mainly determined by the monitoring programme which typically will specify the analysis of either filtered or unfiltered water (total water, whole water). No pre-treatment is required for the analysis of whole water, although acidification may be necessary as part of the extraction procedure, depending on the analyte and on the extraction method used.

Filtration is the preferred technique to separate the dissolved phase from the SPM for small volume samples (e.g. for metal analysis). Polycarbonate or cellulose acetate filters with a pore size of 0.45 µm are frequently used for trace metal determinations, whereas glass fibre filters (0.7 µm or 1.2 µm pore size) are commonly used in the analysis of non-polar and polar organic contaminants. The efficiency of the separation between dissolved and particulate contaminants depends on the pore size of the filters, and may also depend on SPM content of the water and on the sample intake (see Section 4). Adsorption of dissolved analytes to the filter may be an issue for some compounds, and should be addressed during method validation.

A flow-through centrifuge is suitable for obtaining SPM from large volume samples, but less suitable for obtaining particle free water as the separation is incomplete. In general, the efficiency of the separation depends on the geometry and operating conditions of the centrifugation equipment (residence time, effective gravity force), as well as on the density and size of the SPM. Filtration is more effective in this respect, but also more susceptible to artefacts and more time consuming. Ideally, filtration should occur online while sampling or immediately after sampling.

7. Analytical procedures

Analytical methods should be specific to the target analytes and sufficiently sensitive to allow analyses of seawater samples which generally have low concentrations of contaminants. They should meet minimum performance criteria consistent with Commission Directive 2009/90/EC, including an uncertainty on measurements < 50%, estimated at the level of the relevant Environmental Quality Standard, and an LOQ ≤ 30% of the Environmental Quality Standard. If no method meets the minimal performance criteria, the best available analytical method, not entailing excessive costs, should be used. All analytical methods should be capable of being brought under statistical control to ensure adequate quality assurance and quality control. It should be noted that analyses at such low concentrations require extensive experience.

7.1. Trace metals

Analysis of trace metals in seawater generally includes pre-treatment and pre-concentration steps, followed by detection using element-specific spectrometric instrumental procedures, e.g. graphite furnace atomic absorption spectrometry (GFAAS), inductively coupled plasma mass spectrometry (ICP-MS), anodic stripping voltammetry (ASV), and total reflection x-ray fluorescence (TXRF). For mercury, further methods and instruments are used, such as cold vapour atomic absorption spectrometry (CVAAS) and cold vapour atomic fluorescence spectrometry (CVAFS). These techniques are usually combined with a pre-concentration by amalgamation. ICP-MS is also used for mercury analysis.

7.2. Organic contaminants

Organic contaminants are usually found in the water phase at low concentrations, entailing the need for an extraction and enrichment step (e.g. SPE, LLE, solid-phase micro extraction (SPME)) and a selective chromatographic/detection step (e.g. GC-MS⁽ⁿ⁾, GC-ECD, LC-MS⁽ⁿ⁾, LC-FL) within every analytical procedure. Depending on the analytes chosen, the water body studied and expected pollutant concentration, clean-up may be necessary. Although GC-MS/MS and HPLC-MS/MS are very selective techniques, it is good practice to use a second MS transition as a qualifier.

8. Quality assurance (QA)

The quality assurance programme should ensure that the data conform to the quantitative objectives of the programme (see Section 3). The laboratory must establish a quality assurance / quality control system, if necessary consistent with

requirements in Commission Directive 2009/90/EC. All field and laboratory procedures should be fully validated, and the laboratory should also participate in intercalibration exercises and proficiency testing to provide external verification of results. The quality assurance procedures should cover sampling design, sampling, sample storage, analytical procedures (including field controls, analytical blanks, and recoveries), equipment maintenance and handling, training of personnel, data management, and an audit trail.

The use of a second (and different) sampling method, carried out simultaneously to the routine procedure, can be included in the validation process. All QA and QC data should be fully documented.

Because of the extremely low concentrations of pollutants in seawater, blank problems are generally more relevant and more difficult to control than in other matrices. Even ultra-pure chemicals and solvents used sometimes have to be purified before use. Concentrations are often close to the LOQs, which means difficult calibration and integration, and reduced analytical precision.

In addition, the following problems are encountered specifically in seawater analyses of organic contaminants:

- Because of the large sample volumes, it is not possible to analyze replicate samples on a routine basis or to take samples for back-up analysis. However, it is often possible to make a plausibility check by comparing the results with those of samples taken from adjacent stations in a homogeneous water body. Homogeneity can be assessed from oceanographic parameters, like salinity.
- No certified reference materials are available for organic contaminants in seawater. Therefore, laboratory reference materials have to be used, which should preferably be a natural or spiked extract from a typical monitoring station. Extraction efficiencies should be checked by standard addition tests.
- Laboratory performance studies (e.g. by QUASIMEME) are difficult to perform and to evaluate because sample volumes in these studies (max. 1 l) differ from those used in real analysis (>10 l). Thus, concentration ranges in the tests are often higher than in real-life samples.

For temporal trend monitoring in particular, it is extremely important to perform reliable and reproducible high-quality analyses over decades. Therefore, such analyses require well-documented procedures and experienced analysts (see Section 7).

9. Reporting requirements

Secure data storage and appropriate access to the data should be ensured by submission of data to national databases and to the ICES database. Reporting requirements will depend on the database. For entry of OSPAR data into the ICES database, data of trace metals and organic contaminants should be reported in accordance with the latest ICES reporting formats.

The calculation of results and the reporting of data can be major sources of error. Control procedures should be established in order to ensure that data are correct and to avoid transcription errors. This could include comparisons with independently obtained results for the same area or with typical concentration intervals. Data stored in databases should be checked and validated, and checks are also necessary when data are transferred between databases.

Concentrations of trace metals and organic contaminants in seawater should be given in weight per volume (e.g. ng l^{-1}). To ensure correct interpretation, reporting should include information on the sampling method, filtration (filter type and pore size), storage/conservation, and analytical method. Minimum performance criteria such as LOQ and uncertainty measurement along with relevant QA/QC data such as reference material analyses should be included in the report.

The purpose of the monitoring, geographical coordinates, and the name of the sampling stations should be reported in the data as well as being defined in the OSPAR Station Dictionary (<http://www.ices.dk/datacentre/accessions/>). Sample depth, suspended particulate matter concentration, and physicochemical parameters at the time of sampling, such as air and water temperatures, salinity, pH, and weather conditions, should also be reported.

10. References

- Brügmann, L., and Kremling, K. 1999. Sampling. In Graßhoff, K., Ehrhardt, M., and Kremling, K. (Eds.). *Methods of seawater analysis*. 3rd edition. Wiley-VCH, pp. 1–26.
- EU. 2000. Directive 2000/60/EC of the European Parliament and of the Council of 23 October 2000, establishing a framework for Community action in the field of water policy (Water Framework Directive).
- EU. 2008. Directive 2008/56/EC of the European Parliament and of the Council of 17 June 2008, establishing a framework for Community action in the field of marine environmental policy (Marine Strategy Framework Directive).

- Hermans, J. H., Smedes, F., Hofstraat, J. W., and Cofino, W. P. 1992. A method for estimation of chlorinated biphenyls in surface waters: influence of sampling method on analytical results. *Journal of Environmental Science and Technology*, 26: 2028–2034.
- Jaward, F., Barber, J. L., Booij, K., Dachs, J., Lohmann, R., and Jones, K. C. 2004. Evidence for dynamic air-water coupling of persistent organic pollutants over the open Atlantic Ocean. *Journal of Environmental Science and Technology*, 38: 2617–2625.
- Lohmann, R., Booij, K., Smedes, F., and Vrana, B. 2012. Use of passive sampling devices for monitoring and compliance checking of POP concentrations in water. *Environmental Science and Pollution Research*. doi: 10.1007/s11356-012-0748-9.
- Mills, G. A., Fones, G. R., Booij, K., and Greenwood, R. 2011. Passive sampling technologies. *In* Quevauviller, P., Roose, P., and Verreet, G. (Eds.). *Chemical Marine Monitoring. Policy Framework and Analytical Trends*. John Wiley and Sons, Chichester, pp. 397–432.
- OSPAR. 2009. Background Document on CEMP Assessment Criteria for QSR 2010.
- OSPAR. 2010. Joint Assessment and Monitoring Programme 2010–2014. OSPAR Agreement 2010-4.
- OSPAR. 2012. JAMP Guideline for the Integrated Monitoring and Assessment of Contaminants and their effects. Currently in preparation. http://www.ospar.org/content/content.asp?menu=00900301400135_000000_000000.

Technical Annex: Sampling equipment for analysis of trace metals and organic contaminants in seawater

1. Trace metals

1.1 Discrete sampling

An example of a discrete sampler is the GO-FLO sampler by General Oceanics (Figure 1). This sampler consists of a cylinder with an inner Teflon-coating which can be closed and lowered into the water column and opens automatically at a certain depth (ca. 10 m) by hydrostatic pressure. This avoids contact of the sample with the water surface where some contaminants can accumulate. At the desired depth, a messenger is sent on the hydrographic wire (made of Teflon coated stainless steel, polymer, or preferably Kevlar) to release the closing valves in both ends of the sampler. Each bottle can be equipped with a second messenger that is released when the valves close. Water samples can be collected from a range of depths by mounting a series of bottles along the cable.

A variety of the GO-FLO sampler is the reversing water sampler. The messenger releases the sampler from the upper attachment, it rotates, and closes the two valves. If a special thermometer type is attached to the sampler, it fixes the actual temperature at the sampling depth, which can be determined later on board. This accessory can be used when no CTD-sensor is used to record the temperature profile.

Generally, all samplers must be cleaned before the first use by rinsing the inner surfaces with diluted hydrochloric acid. In the open sea, this may not be necessary between sampling where rinsing with deionised water is sufficient in most cases. In the open sea, seawater is sufficiently clean to rinse the outer surface. Samplers with rubber parts which cannot be acid-cleaned or cannot be closed during deployment should be avoided.



Figure 1 Picture of a GO-FLO sampler (General Oceanics; photo courtesy of IFREMER, France).

The MERCOS sampler (Hydrobios Kiel) is designed for two 500 ml thick-walled cylindrical or ball-shaped Teflon bottles, which are closed by two silicone tubes of different diameters in the water. As the bottles are filled with air, the operating depth is restricted to about 50 m for the cylindrical and about 200 m for the globular type. However, this sampler is no longer offered by the manufacturer (<http://www.hydrobios.de>, 2012).

A modified version for four bottles was developed by the Bundesamt für Seeschifffahrt und Hydrographie (BSH, Germany), maintaining the triggering device, but using LDPE bottles of low metal content material (NALGENE) that are protected against the water pressure by a polyacrylate mantle. The LDPE bottles are cheaper and easier to clean due to the smooth inner surface compared to the relatively rough texture of the thick-walled Teflon bottles. Therefore, the LDPE usually show much lower blank values.



Figure 2 Modified MERCOS water sampler of the second generation for four bottles, manufactured by BSH, Germany (photo courtesy of S. Schmolke, BSH, Germany).

1.2 Sampling by pumping

For depths down to 100 m, perhaps even 200 m, it can be practicable to pump seawater up through silicone or Teflon tubing, optionally including in-line filtration. The tubing should be cleaned by pumping acid (e.g. 10% hydrochloric acid) prior to sampling. The first litres of seawater sampled should be subsequently discarded. A peristaltic pump or Teflon piston pumps are suitable. The peristaltic pump can be placed between the sampling tube and the filter. The outflow from the in-line filter can then be collected in polyethylene bottles, Teflon bottles, or in glass or quartz bottles for mercury analyses.

2. Organic contaminants

Large volumes of seawater samples are usually needed for the analysis of organic contaminants. Sampling devices depend on the amount of sample to be processed and the method of extraction (liquid–liquid extraction (LLE) or solid-phase extraction (SPE)).

LLE and SPE do not yield exactly the same concentrations as they use different extraction principles. While SPE effectively extracts only freely dissolved compounds, LLE extracts freely dissolved compounds and also compounds complexed with humic acids and, in part, compounds bound to particles (Sturm *et al.*, 1998). Non-polar compounds can be extracted by either LLE or SPE, whereas the extraction of polar compounds generally requires SPE.

Volumes of 1 to 100 l can be sampled by discrete sampling and/or pumping and are usually extracted either by LLE or SPE. Sample volumes >100 l are generally sampled by pumping and extracted by SPE.

2.1 Discrete sampling

Several different sampling devices have been designed for discrete sampling depending on the volumes needed and the extraction techniques to be applied.

All-glass bottle samplers for volumes of 10 L and 100 L are shown in Figure 3. They are mounted in a stainless steel cage and lowered on a hydrographic wire down to the desired sampling depth and opened under water. After filling, the sampler is brought on deck of the ship and the sample can be extracted by LLE directly in the sampler (using a non-polar solvent) or by SPE. For example, non-polar pollutants like organohalogen pesticides (e.g. DDX, HCH, HCB, dieldrin, endrin) can be extracted and enriched from seawater by means of LLE using hexane or pentane.

Gaul and Ziebarth (1983) described a 10 l glass sampler allowing extraction in the sampling flask itself, thereby minimizing uncertainties arising from sample handling, blanks, adsorption, etc. Later, the same principle was expanded to a 100 l flask, thus increasing the sample volume and lowering the limit of quantification (LOQ) by a factor of 10 (Theobald *et al.*, 1990). Figure 3 shows pictures of 10 l and 100 l sampling bowls. Extraction is done by agitating the samplers with 0.2 and 1 liter of pentane, respectively, using a stirrer. The glass sampler can be used to a depth of 2000 m (10 l) and 100 m (100 l).

Collecting samples at greater depth can be done with stainless steel bottles (Figure 4) holding about 30 litres. This type of sampler was developed based on experience with Niskin and Go-Flo type bottles, and has been used in analyzing dissolved herbicides in water samples collected down to 3000 m depth.



Figure 3 Left: BSH all-glass bottle water sampler (10 l). Right: 100 l glass flask sampler for sampling seawater for the analysis of organic contaminants.

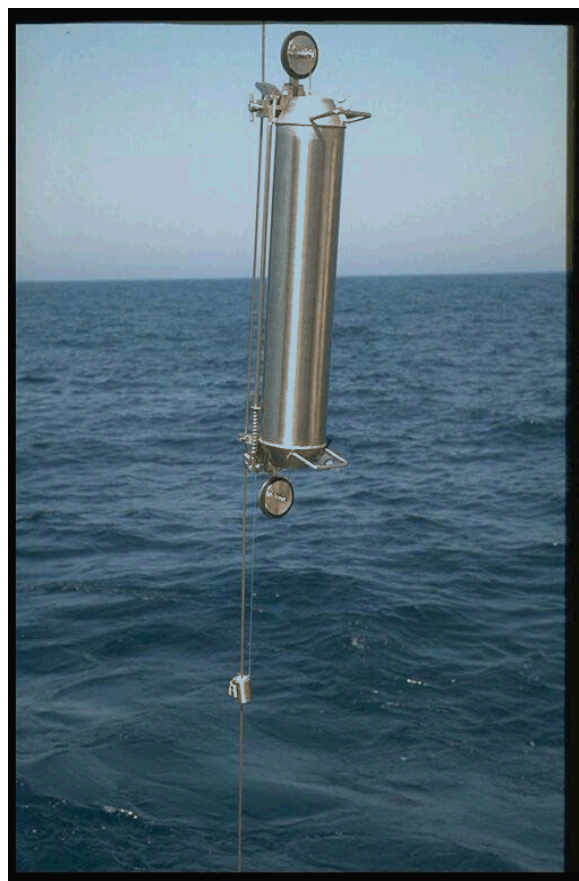

Figure 4 A stainless steel sampling bottle, for subsequent analysis of organic contaminants in seawater.

2.2 Sampling by pumping – *In situ* filtration and extraction

For larger volumes of 200 to 1000 l, Schulz-Bull *et al.* (1995) described an SPE procedure using large extraction cartridges filled with XAD resins. With this adsorbent, they obtained good extraction recoveries for PCBs, DDT, and PAHs, but not for HCH.

Sampling by pumping can be performed with compressed air Teflon pumps (not suitable for subsequent analysis of perfluorinated compounds). In order to equilibrate the system with the sampling water, the water is pumped for about ten minutes before the actual sampling begins. Then the sampling bottles are thoroughly rinsed with the sample, before beginning the sampling itself. The hose is kept away from the ship's hull while the system is being rinsed, and during the collection of the sub-surface samples.

In situ filtration and solid-phase extraction sampling devices may minimize the risk of sample contamination during sampling. A typical *in situ* pump system, the Kiel In-Situ Pump (KISP), has been widely applied to the extraction of organic contaminants in seawater (Petrick *et al.*, 1996). A modified KISP has been described for seawater sampling on-board research vessels (Ebinghaus and Xie, 2006). Briefly, as shown in Figure 5, KISP includes a filter holder, a polymeric resin column, a pump, and a flowmeter. A glass fibre filter (pore size 0.7 µm) is used to recover the particulate phase and a glass column packed with polymeric resin for the dissolved phase. The KISP can be easily operated on board by connecting it to the ship's seawater intake system for sampling seawater at certain depths. The pump system assembly with batteries can be deployed at different depths on a hydrographic wire, and the pumping can be started and ended by remote control.

The original KISP contains some plastic parts and connections, which may present a contamination risk for some organic contaminants, such as brominated flame retardants, alkylphenols, and plasticizers. Low blanks and detection limits have been obtained from KISP samples for legacy persistent organic pollutants (POPs), such as PCBs, DDTs, and HCHs (Lakaschus *et al.*, 2002; Sobek and Gustafsson, 2004). However, it is recommended that these parts are replaced by stainless steel or glass if KISP is to be applied for sampling seawater for the determination of other organic contaminants. Surrogate standards can be added to the resin column before sampling to control the extraction recoveries and storage. It should be noted that the validation of the *in situ* pump sampling method is difficult, and extraction efficiency may depend on dissolved organic matter and humic substances.

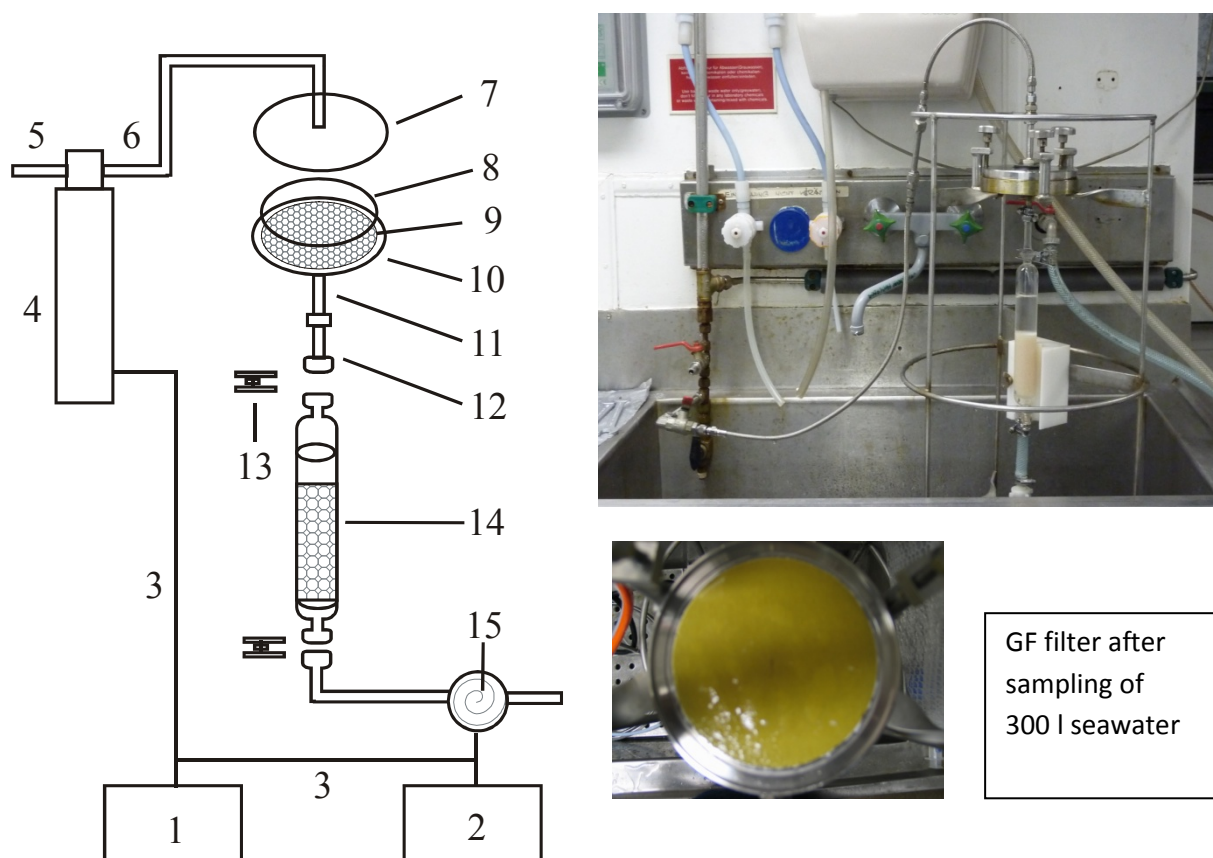

Figure 5 Schematic presentation of the Kiel In-Situ Pump (KISP). 1: flowmeter controller; 2: flowmeter; 3: cable connections; 4: pump; 5: pump inlet; 6: pump outlet; 7: stainless steel deck of filter holder; 8: GF 52 filter; 9: glass plate; 10: filter holder; 11: stainless steel tubing; 12 glass connect; 13 adjustable clip; 14: resins column; 15: counter of flow meter.

References:

- Ebinghaus, R., and Xie, Z. 2006. Occurrence and air/sea-exchange of novel organic pollutants in the marine environment. *Journal de Physique IV*, 139: 215–241.
- Gaul, H., and Ziebarth, U. 1983. Methods for the analysis of lipophilic compounds in water and results about the distribution of different organochlorine compounds in the North Sea. *Deutsche Hydrographische Zeitschrift*, 36: 191–212. (Journal now re-named *Ocean Dynamics*.)
- Lakaschus, S., Weber, K., Wania, F., Bruhn, R., and Schrems, O. 2002. The air-sea equilibrium and time trend of hexachlorocyclohexanes in the Atlantic Ocean between the Arctic and Antarctica. *Journal of Environmental Science and Technology*, 36: 138-45.
- Petrick, G., Schulz-Bull, D. E., Martens, V., Scholz, K., and Duinker, J. C. 1996. An *in-situ* filtration/extraction system for the recovery of trace organics in solution and on particles – tested in deep ocean water. *Marine Chemistry*, 54: 97–105.
- Schulz-Bull, D. E., Petrick, G., Kannan, N., and Duinker, J. C. 1995. Distribution of individual chlorobiphenyls in solution and suspension in the Baltic Sea. *Marine Chemistry*, 48: 245–270.
- Sobek, A., and Gustafsson, O. 2004. Latitudinal Fractionation of Polychlorinated Biphenyls in Surface Seawater along a 62° N–89° N Transect from the Southern Norwegian Sea to the North Pole Area. *Journal of Environmental Science and Technology*, 38(10): 2746–2751.
- Sturm, B., Knauth, H. D., Theobald, N., and Wünsch, G. 1998. Hydrophobic organic micropollutants in samples of coastal waters: efficiencies of solid phase extraction in the presence of humic substances. *Fresenius Journal of Analytical Chemistry*, 361: 803–810. (Journal now re-named *Analytical and Bioanalytical Chemistry*.)
- Theobald, N., Lange, W., Rave, A., Pohle U., and Koennecke, P. 1990. Ein 100-l-Glaskugelschöpfer zur kontaminationsfreien Entnahme von Seewasser für die Analyse lipophiler organischer Stoffe. *Deutsche Hydrographische Zeitschrift*, 43: 311–322. (Journal now re-named *Ocean Dynamics*.)

Annex II:

HELCOM (2012a). Manual for marine monitoring in the COMBINE programme. Annex B-11, Appendix 1. Technical Note on the determination of trace metals (Cd, Pb, Cu, Co, Zn, Ni, Fe) including mercury in seawater (3.1.2)

HELCOM Manual for marine monitoring in the COMBINE programme

ANNEX B-11, APPENDIX 1. TECHNICAL NOTE ON THE DETERMINATION OF TRACEMETALS (CD, PB, CU, CO, ZN, NI, FE), INCLUDING MERCURY, IN SEAWATER

Introduction

General techniques which address the questions of water sampling, storage, filtration procedures and determination of trace metals in natural sea water are described by Sturgeon and Berman (1987) and Gill and Fitzgerald (1985, 1987).

For the determination of mercury in sea water, the chemical species of this element are of importance. Therefore, a differentiation between the several Hg species, including ionic, volatile, dissolved (organic) complexes or particulate adsorbed Hg, has to be considered during sample preparation.

Several definitions of mercury compounds are common (Cossa et al., 1996, 1997), for example:

- Reactive mercury (HgR): A methodologically defined fraction consisting mostly of inorganic Hg(II).
- Total mercury (HgT): Mercury content of an unfiltered sample, after digestion with an oxidizing compound (e.g., K MnO₄).
- Total dissolved mercury: Mercury content of a filtered sample, after digestion with an oxidizing compound (e.g., K MnO₄).
- Dissolved gaseous mercury (DGM): This includes elemental mercury (Hg), monomethylmercury (MM-Hg) and dimethylmercury (DM-Hg).

1. CLEAN LABORATORY; CLEAN BENCHES

Particles are everywhere, including dust in the air or on clothes, hair or skin. Owing to the clothes, the person who is working with the samples for trace metal analysis is the main source of contamination because this person is a particle producer. One of the most important things during sample pretreatment for trace metal analysis is to eliminate particles that can contaminate the samples or the sample containers from the laboratory environment. The best way to eliminate most of this contamination is to work under a laminar flow box with a laminar horizontal flow (sample protection). Recommended conditions for a 'clean bench' or a 'clean lab' are class 100 (US Norm) which means that there are still about one hundred particles present per cubic foot or class 3 (DIN-Norm), which equals 3000 particles per m³ (corresponding to class 100 US Norm).

2. PREPARATIONS

Chemicals

High purity water (e.g., 'Milli-Q water', 18 M cm⁻¹) freshly prepared, is termed 'water' in the following text.

A sub-boiling quartz still is recommended for the distillation of highly purified acids and solvents. A teflon still is recommended for the distillation of HF.

Amalgamation (filtration of oversaturated solutions with goldnet) and volatilization (bubbling with ultrapure argon) are effective methods to purify (clean) chemicals and solutions for mercury analysis.

In order to avoid contamination problems, all plastic ware, bottles and containers must be treated with acids (HCl or HNO₃) for several weeks and then rinsed with water and covered in plastic bags until use.

The following procedures (Patterson and Settle, 1976) are suggested:

Laboratory ware

Store in 2M HCl (high purity) for one week, rinse with water, store in water for one week and dry under dust-free conditions (clean bench).

Samplers and bottles

Sampling devices: Fill with 1% HNO₃ (high purity), store at room temperature for three weeks, and rinse with water .

Teflon/quartz bottles: Store in warm (40 C ±5 C) 1:1 diluted HCl for one week. Then rinse with water and store with 1M HNO₃ (high purity) until the final use (a minimum of three weeks). Modified cleaning procedures are required for mercury. Glass containers (borosilicate, quartz) used for the collection and storage of samples for the determination of mercury are usually cleaned using an oxidizing procedure described by Sturgeon and Berman (1987). Bottles are filled with a solution of 0.1 % KMnO₄, 0.1% K₂S₂O₈ and 2.5 % HNO₃ and heated for 2 hours at 80 C. The bottles are then rinsed with water and stored with 2 % HNO₃ containing 0.01 % K₂Cr₂O₇ or KMnO₄ until ready for use.

Filters

Polycarbonate filters (e.g., Nuclepore) (0.4 m, 47 mm diameter) are recommended for trace metals except mercury. Store the filters in 2M HCl (high purity) for a minimum of three weeks. After rinsing with water, store for one more week in water.

For the determination of mercury, glass microfibre filters (GF/F grade, Millipore type) and teflon filters are recommended for the filtration of natural water samples. Cleaning of these filters is comparable to the procedure used for polycarbonate filters. For GF/F filters, an additional drying step has to be considered (450 C for 12-24 hr) to volatilize gaseous mercury. This procedure is described in detail by Queremais & Cossa (1997).

If trace metals in suspended particulate matter (SPM) are to be determined, filters have to be placed in precleaned plastic dishes, dried in a clean bench for two days, and stored in a desiccator until they are weighed using an electronic microbalance with antistatic properties. Each filter has to be weighed daily for several days until the weight is constant. The same procedure for drying and weighing should be applied to the filters loaded with SPM (Pohl, 1997).

3. SAMPLING AND SAMPLE HANDLING

The basis for the reliable measurement of extremely low concentrations of trace metals in sea water is a well-performed sampling to avoid contamination risk from the ship. Careful handling is recommended because copper and tin are still the main substances used in antifouling paints on ships and there is also a risk of contamination by zinc (anodes of the ship), iron or lead. In coastal and continental shelf waters, samples are collected using 30 l teflon-coated GO-FLO (General Oceanics, close-open-close system) bottles with teflon O-rings deployed on Kevlar or on a Hostalen coated wire. Niskin bottles deployed on rosettes using standard stainless steel hydrowire are also acceptable. For surface waters, an all-teflon MERCOS-Sampler (Hydrobios) could be chosen.

PVC gloves should be worn during subsampling into the precleaned quartz or teflon bottles (teflon has an extra low content of trace metals). Subsampling should be carried out in a clean lab or a clean-lab container, if available.

Pumping of samples using peristaltic or teflon piston pumps must be carried out using precleaned silicon- or teflon-lined tubes.

In the absence of clean-lab conditions, sampling and sample handling must be carried out in a closed system, or contamination cannot be avoided.

For mercury analysis, it should be noted that the integrity during sampling and storage may be jeopardized by the addition of mercury to the sample as well as by unexpected losses owing to volatilization.

4. FILTRATION PROCEDURE

In the environmental and geochemical scientific community concerned with water analysis, it has generally been accepted that the term 'dissolved' refers to that fraction of water and its constituents which have passed through a 0.45 µm membrane filter. This is an operationally defined fraction. Coastal and shelf water samples have to be filtered to eliminate particles from the water. A number of metal species pass through this filter pore size, including metals bound to colloids or clays or to humic, fulvic, amino, and fatty acids.

To prevent desorption of metal ions from particle surfaces or from biological degradation of SPM, separation between the dissolved phase and the particulate phase has to be done immediately after sampling by filtering the water through a 0.45 µm polycarbonate filter. This procedure should be carried out under clean conditions (clean benches are recommended on board the ship). If metals in both the dissolved and particulate phases are to be analysed, pressure filtration with nitrogen is recommended. After filtration the filter should be rinsed with high purity isotonic solution to remove sea salt residues. Only a few millilitres are necessary because a change of pH could cause desorption of metal ions from the particles. In pumping systems, on-line filtration is possible.

5. STORAGE OF SAMPLES

To avoid wall adsorption of metal ions, 1.5 ml HNO₃ or HCl (high purity) should be added per litre of seawater sample immediately after filtration for acidification to pH 1.0-1.6. The sample containers should be stored in plastic bags under controlled environmental conditions. The filters should be stored in plastic dishes at -18 °C or below. Under these conditions, both water samples and SPM on filters can be stored for at least one year.

Special consideration must be given to samples destined for Hg determinations. It is necessary to add either oxidants (Cr₂O₇²⁻) in addition to acidification or complexing agents (cysteine) to neutral or alkaline samples to prevent Hg losses during storage.

6. SAMPLE PRETREATMENT

Water samples

Depending on the expected concentration range (10^{-7} - 10^{-9} gkg⁻¹) of trace metals (dissolved) in Baltic Sea water and because of the salt matrix interfering during the measurement process, preconcentration techniques and/or the elimination of sea salt has to be carried out prior to the analytical measurement. Detailed method information is available in the open literature (e.g., Danielsson et al., 1978; Kremling et al., 1983; and Pohl, 1994).

Filters

Different methods to analyse the material on the filter are described by Hovind and Skei (1992) and Loring and Rantala (1991). Pressure decomposition with an acid mixture (HCl, HNO₃, HF) is recommended. If the silica content is high due to diatoms, the HF concentration should be increased accordingly. If the organic content increases, it is advisable to work with perchloric acid.

Depending on the digestion system used (high pressure autoclave, microwave digestion, wet ashing in an open system, or dry ashing), the completeness of the digestion is a function of temperature, time, digestion material and pressure, and has to be tested and validated in pilot studies with (certified) reference materials (see the detailed remarks in Annex B-7, Section 4.3). Digestion of samples for mercury analysis must always be carried out in a closed system to prevent losses by evaporation.

7. INSTRUMENTATION

For the analytical measurements, several analytical techniques can be used, such as GFAAS (graphite furnace atomic absorption spectrometry), electrochemical methods, ICP-MS (inductively coupled plasma-mass spectrometry), ICP-AES (inductively coupled plasma-atomic emission spectrometry), or total-reflection X-ray fluorescence (TXRF). Because of the very low mercury concentrations in sea water, the most widely used technique for mercury is the cold vapour technique (reduction of mercury with SnCl₂ to elemental Hg) and preconcentration of mercury by amalgamation on a gold trap. This is followed by atomic absorption spectrometry or by atomic fluorescence spectrometry, with detection limits adequate for the purpose. In the case of anoxic (sulfur-containing waters), see Annex B-11.

8. QUALITY CONTROL

The internal quality control is described in Chapter B.5 of the Manual.

Blank

Particularly in the case of trace metal analysis, with high contamination risks at each step of the analytical work, a satisfactory blank control is necessary. Therefore, it is important to control the blank daily, for reproducibility and constancy over a longer time. The blank should include all analytical pretreatment procedures, including the addition of the same quantities of chemical substances as for the sample.

Calibration

For calibration purposes, single element standard stock solutions at a concentration of 1000 mg dm⁻³, purchased from a qualified manufacturer, should be available. Preparation date and concentration should be marked on the bottle. From this stock solution, a multi-element working standard solution can be prepared using dilute HCl or HNO₃ as required (normally 1M acid is used).

Traceability can be ensured by the use of CRMs or participation in intercomparison exercises. The working standard should be prepared from the stock standard solution for every batch of samples and kept no longer than two weeks. Precleaned teflon containers are preferable for storage.

To evaluate effects from the matrix, the method of standard addition can be used, particularly in connection with the analytical method of voltammetric stripping. For other techniques, the method of standard addition should generally be used with care (Cardone, 1986a, 1986b).
Reference materials

Owing to problems in defining the blank, the use of a low-concentration CRM is important. Regular participation in intercomparison exercises should be considered mandatory.

REFERENCES

- Cardone, M. 1986a. New technique in chemical assay calculations. 1. A survey of calculational practices on a model problem. *Analytical Chemistry*, 58: 433-438.
- Cardone, M. 1986b. New technique in chemical assay calculations. 2. Correct solution of the model problem and related concepts. *Analytical Chemistry*, 58: 438-445.
- Cossa, D., Coquery, M., Gobeil, C., and Martin, J.M. 1996. Mercury fluxes at the ocean margins. In *Global and regional mercury cycles: sources, fluxes and mass balances*, pp. 229-247. Ed. by W. Baeyens et al. Kluwer Academic Publishers.
- Cossa, D., Martin, J.M., Takayanagi, K., and Sanjuan, J. 1997. The distribution and cycling of mercury species in the western Mediterranean. *Deep Sea Research II*, 44(3-4): 721-740.
- Danielsson, L.G., Magnusson, B., Westerlund, S. 1978. An improved metal extraction procedure for the determination of trace metals in sea-water by atomic absorption spectrometry with electrothermal atomization. *Analytica Chimica Acta*, 98: 47-57.
- Gill, G.A., Fitzgerald, W.F. 1985. Mercury sampling of open ocean waters at the picomolar level. *Deep Sea Research*, 32(3): 287-297.
- Gill, G.A., and Fitzgerald, W.F. 1987. Picomolar mercury measurements in seawater and other materials using stannous chloride reduction and two-stage gold amalgamation with gas phase detection. *Marine Chemistry*, 20: 227-243.
- Hovind, H., and Skei, J. 1992. Report of the Second ICES Intercomparison Exercise on the Determination of Trace Metals in Suspended Particulate Matter. ICES Cooperative Research Report, No.184. 31 pp.
- Kremling, K., Olafsson, I., Andreae, M., and Koroleff, F. 1983. Determination of trace metals. In *Methods of seawater analysis*. Ed. by K. Grasshoff, M. Ehrhardt, and K. Kremling. Verlag Chemie, Weinheim. 419 pp.
- Loring, D.H., and Rantala, R.T.T. 1991. Manual for the geochemical analyses of marine sediments and suspended particulate matter. *Earth Science Reviews*, 32: 235-283.
- Patterson, C., and Settle, D. 1976. The reduction of orders of magnitude errors in lead analysis of biological materials and natural waters by evaluating and controlling the extent and sources of industrial lead contamination introduced during sample collecting, handling, and analysis. In *Accuracy in trace analysis: Sampling, Sample handling, Analysis*, pp 321-351. Ed. by P. LaFleur. United States National Bureau of Standards Special Publication, No. 422.
- Pohl, C. 1994: Meerwasser-Probennahme, Anreicherung und Analytik. In *Probenahme und Aufschluß*. Ed. by M. Stoeppler. Springer-Labormanual, Heidelberg, 181 pp.
- Pohl, C. 1997. Trace Metals (Cu, Pb, Zn, Cd, Al, Li, Fe, Mn, Ni, Co) in Marine Suspended Particulate Matter: An International ICES Intercomparison Exercise. *Accreditation and Quality Assurance*, 2: 2-10.
- Quémerais, B., and Cossa, D. 1997. Procedures for sampling and analysis of mercury in natural waters. Environment Canada-Quebec region, Environmental Conservation, St. Lawrence Centre. Scientific and Technical Report ST-31E, 34 pp.

- Sturgeon, R., and Berman, S. 1987. Sampling and storage of natural water for trace metals. In *Critical reviews in Analytical Chemistry*. 18(3): 209-244. CRC Press.

Annex III:

HELCOM (2012b). Manual for marine monitoring in the COMBINE programme. Annex B-11, Appendix 2. Technical note on the determination of persistent organic pollutants in seawater. (3.1.3)

HELCOM Manual for marine monitoring in the COMBINE programme

ANNEX B-11 APPENDIX 2: TECHNICAL ANNEX ON THE DETERMINATION OF HEAVY METALS AND PERSISTENT ORGANIC COMPOUNDS IN SEAWATER

TECHNICAL NOTE ON THE DETERMINATION OF PERSISTENT ORGANIC POLLUTANTS IN SEAWATER

1. INTRODUCTION

These guidelines concentrate on the sampling and extraction of lipophilic persistent organic pollutants from seawater and special aspects of the sampling matrix. This group of pollutants comprises the group of polycyclic aromatic hydrocarbons (PAHs) and chlorinated hydrocarbons (e.g., HCH, HCB, DDT group, chlorinated biphenyls (PCBs)).

For general aspects and the analytical determination, reference is made to the following guidelines:

- "Determination of Polycyclic Aromatic Hydrocarbons (PAHs) in Sediments: Analytical Methods", ICES ACME Report 1997;
- "Guidelines for the determination of chlorobiphenyls in sediments: Analytical methods", ICES ACME Report 1996;
- "Determination of Polycyclic Aromatic Hydrocarbons (PAH)s in Biota", ICES ACME Report 1998; and
- Annex B-14 (these Guidelines).

As the same analytical methods can be used for the determination of lipophilic pollutants in extracts of water samples as are used for extracts of sediments, it is felt that it is a useful way to unify analytical procedures to refer to these publications only.

However, it should be taken into consideration (e.g., for calibration) that the relative concentrations of the individual pollutants are generally quite different in water and sediment samples. The concentration patterns of the pollutants are mainly influenced by their polarity which can be expressed by their octanol/water coefficient (log Kow; $Kow = \frac{\text{Concentration in octanol phase}}{\text{Concentration in aqueous phase}}$). Thus, in water samples the more hydrophilic compounds with log Kow values of 3 to 4 predominate (e.g., 2- and 3-ring aromatics and HCH isomers), while in sediments and biota the pollutants with log Kow values >5 are enriched (4- to 6-ring aromatics, DDT group, PCBs).

These guidelines provide advice on lipophilic persistent organic pollutant (POPs) analyses in total seawater with a log KOW > 3. The analysis of POPs generally includes:

- sampling and extraction of the water;
- clean-up; and
- analytical determination

The extraction of the POPs simultaneously enables an enrichment of the analytes. Because of the very low concentration range of 10 pg l⁻¹ to 10 ng l⁻¹, the enrichment of the contaminants is a very important step in the procedure. Extraction and enrichment can be done by solid phase extraction (SPE) or liquid-liquid extraction (LLE).

Determination depends on the chemical structure of the compounds. PAHs can be determined by high performance liquid chromatography (HPLC) with fluorescence detection or gas chromatographic (GC) separation with flame ionization (FID) or mass spectrometric (MS) detection (Fetzer and Vo-Dinh, 1989; Wise et al., 1995). Chlorinated hydrocarbons are generally analysed by gas chromatographic (GC) separation with electron capture detectors (ECD) or mass spectrometric (MS) detection.

All steps of the procedure are susceptible to insufficient recovery and/or contamination. Therefore, regular quality control procedures must be applied to check the performance of the whole method. These guidelines are intended to encourage and assist analytical chemists to critically reconsider their methods and to improve their procedures and/or the associated quality control measures, where necessary.

These guidelines are not intended as a complete laboratory manual. If necessary, guidance should be sought from specialized laboratories. Whichever procedure is adopted, each laboratory must demonstrate the validity of each step of its procedure. In addition, the use of a second (and different) method, carried out concurrently to the routine procedure, is recommended for validation. The participation in analytical proficiency tests is highly recommended.

2. SAMPLING AND STORAGE

Plastic materials must not be used for sampling and storage owing to possible adsorption on the container material or contamination. Especially the very lipophilic compounds (4- to 6-ring aromatic hydrocarbons, DDT, PCBs) tend to adsorb on every surface. Therefore, the seawater samples should not be stored longer than 2 h and should not be transferred into other containers before extraction. It is highly recommended to extract the water sample as soon as possible after sampling and to use as little manipulation as possible. It is recommended that sampling and extraction should be done in the same device. Extracts in organic solvents are less susceptible to adsorption onto surfaces.

3. BLANKS AND CONTAMINATION

In many cases, the procedural detection limit is determined by the blank value. In order to keep the blank value as low as possible, the compounds to be analysed or other interfering compounds should be removed from all glassware, solvents, chemicals, adsorption materials, etc., that are used in the analysis. The following procedures should be used:

- Glassware should be thoroughly washed with detergents and rinsed with an organic solvent prior to use. Further cleaning of the glassware, other than calibrated instruments, can be carried out by heating at temperatures > 250 °C.
- All solvents should be checked for impurities by concentrating the amount normally used to 10 % of the normal end volume. This concentrate is then analysed in the same way as a sample by HPLC or GC and should not contain significant amounts of the compounds to be analysed or other interfering compounds.
- All chemicals and adsorption materials should be checked for impurities and purified (e.g., by heating or extraction), if necessary. Soxhlet thimbles should be pre-extracted. Glassfiber thimbles are preferred over paper thimbles. Alternatively, full glass Soxhlet thimbles, with a G1 glass filter at the bottom, can be used. The storage of these supercleaned materials for a long period is not recommended, as laboratory air can contain PAHs that will be adsorbed by these materials. Blank values occurring despite all the above-mentioned precautions may be due to contamination from

the air. The most volatile compounds will usually show the highest blanks (Gremm and Frimmel, 1990).

As the concentrations of the PAHs and chlorinated hydrocarbons in seawater are very low, possible blank and contamination problems might be even more difficult to control than with sediment samples. Therefore, it is recommended to rewash all equipment (vials, pipettes, glass bottles) with solvent just before use. If possible, critical steps should be done in a clean bench.

The more volatile compounds (especially naphthalene and phenanthrene) show the largest blank problems.

4. PRE-TREATMENT

For the extraction of whole water samples, no pre-treatment is necessary.

If the suspended particulate material (SPM) will be analysed separately from the solute phase, a phase separation has to be done. Because of the necessary additional manipulation step, this is a difficult operation which affords a number of additional quality control procedures (adsorption losses, contamination problems). There are two possible ways for phase separation: filtration and centrifugation.

Filtration is done by GF/F glass fibre filters. As flat-bed filters have a very limited capacity, the use of coiled glass fibre filters is recommended for volumes larger than 10 l and water samples with high amounts of suspended matter. A pump is necessary to force the water through the filter.

Centrifugation needs a high volume centrifuge which must be operable onboard a ship. Such centrifuges with a throughput of 1 m³ h⁻¹ and more are commercially available and used for sampling SPM; however, they are expensive and generally not a standard equipment. For centrifugation, blanks and adsorption problems have to be controlled as well as the separation efficiency.

The sampled SPM is analysed like a sediment. The solute phase is analysed like the whole water sample.

Validation of the phase separation procedures is very difficult; thus, it might be wise to analyse the whole water sample for monitoring purposes and to determine separately only the amount of SPM in the water for reference or normalization purposes.

5. EXTRACTION

The volume of the water sample is the most important parameter which influences the limit of determination of the method. As POP concentrations down to 10 pg l⁻¹ and less are observed in seawater, large water volumes of 10 l to 100 l have to be sampled and extracted. Large volumes are required not only to obtain a sufficiently high detector signal, but also to discriminate from blank problems.

Principally, there are two different extraction principles in current use: solid phase extraction (SPE) and liquid-liquid extraction (LLE). Unfortunately, the two procedures do not always yield comparable results, as the physical extraction principles are quite different (Sturm et al., 1998, Gomez-Belinchon et al., 1988).

SPE has the advantage of being able to extract very large water volumes (up to 1000 l) and to incorporate a phase separation to obtain separate samples for SPM and the solute phase. The

drawbacks of the method are a longer sampling time demand, a more complex instrumentation, and problems with validation and control of the extraction efficiency.

LLE has the advantage that it can be easily validated and controlled, as internal standards can be added before extraction. Also, standard addition techniques can be used for accuracy testing. As LLE is a classical extraction technique, a great deal of experience is available and the robustness of the principle is proven. The limitation in sample volume is only relative, as techniques have been described for sampling 10 l and 100 l on a routine basis (Gaul and Ziebarth, 1993; Theobald et al., 1990). It has been shown that a sampling volume of 100 l is sufficient for nearly all monitoring tasks. Because of the robustness of the method, there is a preference LLE for routine monitoring purposes for all lipophilic organic contaminants.

5.1 Solid phase extraction

The extraction device consists of a filter holder, an adsorption column filled with an adsorbing material (e.g., XAD resin, C18 modified silica gel), a pump which forces the water sample through the column, a flow meter, an electronic control unit, and a power supply. Sampling can be done either by deploying the whole extraction device into the water (in situ pumping) or by pumping the water with a separate pump onboard a ship and then through the extraction device. A suitable in situ system is described in detail in Patrick et al. (1996). After sampling, the columns are stored at 4 °C and the filters at -20 °C.

The adsorption column is eluted with an organic solvent (acetone or acetonitril). Prior to the extraction, internal standards are added to the solvent. The extract obtained is pre-cleaned and analysed.

Analytical procedures for the use of XAD-2 adsorption resins are published by the IOC (1993), Ehrhardt (1987), and Bruhn and McLachlan (2001).

Although the SPE technique has many advantages, one has to be aware of some problems. Especially for large volume sampling, validation of the method is extremely difficult and has not yet been achieved. Some publications have shown that the extraction efficiency is dependent on, e.g., the amount and kind of humic substances which can complex lipophilic compounds (Johnson et al., 1991; Kulovaara, 1993; Sturm et al., 1998).

5.2 Liquid-liquid extraction

The decision to sample 10 l, 20 l, or 100 l of water depends on the anticipated concentrations of the compounds to be analysed in natural samples. For remote sea areas with expected concentration of 10 pg l⁻¹ or less, a volume of 100 l is recommended. The technique and principle are identical for all volumes, only the sampling bottle and the equipment are different. Details of the sampling and extraction techniques are described in Gaul and Ziebarth (1993) for the 10 l sampler and in Theobald et al. (1990) for the 100 l sampler.

The all-glass bottle sampler fixed in a stainless steel cage is lowered by a hydrographic wire down to the sampling depth and opened under water. After filling, the sampler is brought on deck of the ship and immediately extracted with a non-polar solvent such as pentane or hexane. Prior to extraction, a solution with appropriate internal standards (e.g., deuterated PAHs, e-HCH, PCB 185) is added to the water sample. After phase separation, the organic extract is dried with Na₂SO₄ and carefully concentrated to about 1 ml in a rotary evaporator. Further evaporation is done under a gentle stream of nitrogen.

Extreme care has to be taken to avoid contamination during sampling, extraction, and work up. Blank samples must be taken in every sampling campaign; this can be done, e.g., by rinsing the cleaned sampling bottle with the extraction solvent and treating this extract like a normal sample. The sampling bottle must be cleaned with detergent, water, and organic solvents (acetone and hexane or pentane) before use. After using in open sea areas, it can be of advantage not to perform the whole cleaning/washing procedure but just to use the sampler directly after emptying the glass bottle from the extracted previous water sample.

Extracts should be stored in the refrigerator and in the dark.

6. CLEAN-UP

Interferences from matrix compounds in seawater samples are generally smaller than in sediment or biota samples. Nevertheless, the crude extracts require a clean-up before chromatographic separation and determination can be done. The clean-up is dependent on the compounds to be analysed, the sample, the determination method used, and the concentration range to be analysed. For all GC methods, it is essential to remove polar and non-volatile compounds in order to protect the GC column from rapid destruction. A detection system with low selectivity (eg., GC-FID) needs a far better clean-up than a detector with a high selectivity such GC-MS or even GC-MS/MS. HPLC with fluorescence detection (for PAH analyses) has a relative high selectivity but the method will fail if petrogenic aromatic compounds (from an oil spill) are present in the sample. GC-ECD (for chlorinated compounds) has a high selectivity but some interferences (e.g., phthalate esters) may disturb the detection; therefore, for GC-ECD a good clean-up is necessary as well.

A clean-up procedure for this is presented here that uses short silica gel chromatography columns that can be applied with any determination technique: HPLC, GC or GC-MS. The method is simple and is sufficient in most cases of PAH and chlorinated hydrocarbon determinations in seawater (ICES, 1996, 1997, 1999).

A 3 ml glass column with glass fibre frit (commercially available for SPE) is filled with 500 mg silica gel (dried for 2 h at 200° C) and subsequently washed with 30 ml CH₂Cl₂ and 30 ml hexane. The hexane sample extract (concentrated to 500 µl) is applied on top of the column and eluted with 5 ml CH₂Cl₂/hexane (15/85 v/v) and then with 5 ml of acetone. Fraction 1 contains all lipophilic compounds of interest (PAHs and all chlorinated hydrocarbons (from HCB to HCH)); this fraction can be used for GC-MS determination after concentration to 50–300 µl. If the water sample has been extremely rich in biological material (algae) or if detection limits far below 10 pg l⁻¹ are requested, additional clean-up (HPLC, GPC) might become necessary.

7. CHROMATOGRAPHIC DETERMINATION

Details for the chromatographic determinations are comprehensively described in the 1996 ACME report (ICES, 1996) for chlorobiphenyls in sediments (GC-ECD and GC-MS), the 1997 ACME report (ICES, 1997) for PAHs in sediments (HPLC-Fluorescence detection, GC-FID and GC-MS), and the 1998 ACME report (ICES, 1999) for PAHs in biota (HPLC and GC-MS).

As the cleaned extracts from the seawater samples can be analysed in the same way as the extracts from sediments and biota, the above guidelines can be used. When a GC-MS system can be used, all compounds can be determined in one single GC analysis; if not, the samples have to be analysed separately for PAHs (HPLC-F, GC-FID) and chlorinated hydrocarbons (GC-ECD).

7.1 Gas chromatography-mass spectrometry

As GC-MS has the advantage of being both very selective and quite universal, it is strongly recommended to use GC-MS as the determination method. It especially has the advantage that both PAHs and chlorinated hydrocarbons can be determined in one single analysis. This is not possible with any of the other techniques.

Because of the sensitivity required, the mass spectrometric detector must be operated in the selected ion mode (SIM). By this, absolute sensitivities in the range of 1 pg to 10 pg can be achieved for most compounds. Ion-trap instruments can be operated in full-scan mode and are in principle as sensitive as quadrupole detectors; however, with real samples and matrix underground they can lose considerably sensitivity.

With GC-MS, detection limits of 5–30 pg l⁻¹ can be reached with water sample volumes of 10 l to 100 l. In most cases, it is not the absolute signal strength of the detector which limits the detection; therefore, the injection of a larger aliquot of the analysis solution would not improve it. For some compounds, blank values are the limiting parameter (especially naphthalene and phenanthrene and, to a lesser extent, other PAHs); for this, only a larger sample volume can improve the detection limits. Many other compounds do not exhibit blank problems, if appropriate care is applied; for these, matrix noise often limits the detection. For such situations, only a better clean-up (e.g., HPLC, GPC) or a more specific detection method (GC-NCI-MS or GC-MS/MS) will improve the detection limit. Negative chemical ionization (NCI) mass spectrometric detection can be used for highly chlorinated compounds (e.g., HCB, PCBs with five or more Cl atoms, HCH) and shows extremely high sensitivity and selectivity for these compounds. More universally applicable is tandem mass spectrometry (MS/MS), which yields a similar absolute sensitivity as normal MS but much higher selectivity. Some MS/MS transitions for the detection of selected chlorinated hydrocarbons are listed in Table 1 in Appendix 2 to Annex B-13: Technical note on the determination of polycyclic aromatic hydrocarbons in biota, from the full "Guidelines".

7.2 Quantification

A multilevel calibration with at least five concentration levels is recommended. The response of the FID detector is linear. For UV and fluorescence detection, the linear range is also large. The working range should be linear and must be covered by a calibration curve. Since the mass spectrometric detector often has no linear response curve, the use of stable deuterated isotopes is a prerequisite. Furthermore, the response of PAHs in standard solutions is often much lower than in sample extracts. Only a combination of different techniques, e.g., the use of internal standards and standard addition, might give reliable quantitative results.

The calibration curve can be checked by recalculating the standards as if they were samples and comparing these results with the nominal values. Deviations from the nominal values should not exceed 5%.

When chromatograms are processed using automated integrators, the baseline is not always set correctly, and always needs visual inspection. Because the separation of the peaks is often incomplete in HPLC analysis, the use of peak heights is recommended for quantification. In case of GC techniques, either peak heights or peak areas can be used.

Prior to running a series of samples and standards, the GC or HPLC systems should be equilibrated by injecting at least one sample extract, the data from which should be ignored. In addition, standards used for multilevel calibration should be regularly distributed over the sample series so matrix- and non-matrix-containing injections alternate. A sample series should include:

- a procedural blank,
- a laboratory reference material,
- at least five standards,
- one standard that has been treated similarly to the samples (recovery determination).

The limit of determination should depend on the purpose of the investigation. A limit of 2 ng g⁻¹ (dry weight) or better should be attained for single compounds. The method for calculating the limit of determination should reflect QUASIMEME advice (Topping et al., 1992). The limit of determination that can be achieved depends on the blank, the sample matrix, concentrations of interfering compounds, and the volume of water taken for analysis. The typical concentration ranges of PAHs and other POPs in seawater can be found in HELCOM assessments (HELCOM, 2003a, 2003b).

8. QUALITY ASSURANCE

A number of measures should be taken to ensure a sufficient quality of the analysis. Five main areas can be identified:

1. extraction efficiency and clean-up;
2. calibrant and calibration;
3. system performance;
4. long-term stability; and
5. internal standards.

8.1 Extraction efficiency and clean-up

A check on extraction efficiency and clean-up can be performed by analysing a reference material (Annex B-7). To determine the recovery rates of the clean-up and concentration steps, it is recommended to pass a standard solution through the entire procedure. Additionally, at least one internal standard should be added to each sample before extraction, to check for recovery during the analytical procedures. If major losses have occurred, then the results should not be reported. CB29 is suggested as a recovery standard because, owing to its high volatility, losses due to evaporation are easily detected. CB29 elutes relatively late from alumina and silica columns. Small peaks that may be present in the gas chromatogram at the retention time of CB29 do not hinder the use of this CB because the recovery standard only indicates major errors in extraction or clean-up. In case of GC/MS, labelled CBs can be used as recovery standards. This allows correction for recovery, provided that each chlorination stage is represented.

8.2 Calibrant and calibration

PAH determinations should preferably be carried out using calibration solutions prepared from certified crystalline PAHs. However, the laboratory should have the appropriate equipment and expertise to handle these hazardous crystalline substances. Alternatively, certified PAH solutions, preferably from two different suppliers, can be used. Two independent stock solutions should always be prepared simultaneously to allow cross-checks to be made. Calibration solutions should be stored in ampoules in a cool, dark place. Weight loss during storage should be recorded for all standards.

CB determinations should always be carried out using calibration solutions prepared from crystalline CBs. Preferably, certified CBs should be used. Two independent stock solutions of different concentrations should always be prepared simultaneously to allow a cross-check to be made.

Calibration solutions should preferably be stored in a cool, dark place. For all containers with standards, the weight loss during storage should be recorded.

After clean-up and before GC analysis, both in PAH and CB analysis, an additional internal standard is added for volume correction. Internal standards should be added in a fixed volume or weighted to all standards and samples.

8.3 System performance

The performance of the HPLC or GC system can be monitored by regularly checking the resolution of two closely eluting PAHs or CBs. A decrease in resolution indicates deteriorating HPLC or GC conditions. The signal-to-noise ratio of a low concentration standard yields information on the condition of the detector. For example, a dirty MS-source can be recognized by the presence of a higher background signal, together with a reduced signal-to-noise ratio. Additionally, the peak can be affected.

8.4 Long-term stability

One laboratory reference sample should be included in each series of samples. A quality control chart should be recorded for selected PAHs, e.g., fluoranthene (stable results), pyrene (sensitive to quenching), benzo[a]pyrene (sensitive to light), or, correspondingly, for selected CBs. If the warning limits are exceeded, the method should be checked for possible errors. When alarm limits are exceeded, the results obtained should not be reported. A certified reference material (CRM) should be analysed at least once a year, when available, and each time the procedure is changed. Each laboratory analysing PAHs and CBs in water should participate in interlaboratory analytical performance tests on a regular basis.

8.5 Internal standards

Internal standards should be added to all standards and samples either in a fixed volume or by weight. The PAH internal standards should preferably be non-natural PAHs which are not found in water and do not co-elute with the target PAHs; several predeuterated PAHs have proved to be suitable for GC/MS as well as for HPLC analysis. For example, for GC/MS it is recommended to add four internal standards representing different ring-sizes of PAHs.

The following compounds can be used (Wise et al., 1995):

- for HPLC analysis: phenanthrene-d10, fluoranthene-d10, perylene-d12, 6-methyl-chrysene;
- for GC/MS analysis: naphthalene-d8, phenanthrene-d10, chrysene-d12, perylene-d12;
- for GC/FID analysis: 1-butylpropylene, m-tetraphenyl.

Similarly the ideal internal standard for PCBs is a compound which is not found in the samples and does not co-elute with other CBs, e.g., CBs 29, 112, 155, 198 or all 2,4,6-substituted CB congeners. Alternatively, 1,2,3,4-tetrachloronaphthalene can be used.

9. REFERENCES

- Bruhn, R., and McLachlan, M.S. 2001: Seasonal variation of polychlorinated biphenyl concentrations in the southern part of the Baltic Sea. *Marine Pollution Bulletin*, in press
- Ehrhardt, M., 1987: Lipophilic organic material: An apparatus for extracting solids used for their concentration from sea water. *ICES Techniques in Marine Environmental Sciences*, 4.
- Fetzer, J.C., and Vo-Dinh, T. 1989: *Chemical analysis of polycyclic aromatic compounds*. Wiley, New York.

- Gaul, H., and Ziebarth, U., 1993: Method for the analysis of lipophilic compounds in water and results about the distribution of different organochlorine compounds in the North Sea. *Dt. Hydrog. Z.*, 36: 191–121.
- Gomez-Belinchon, J.I., Grimalt, J.O., and Albeiges, J. 1988, *Environmental Science and Technology*, 22: 677–685.
- HELCOM. 2003a. Fourth Periodic Assessment of the State of the Baltic Sea Environment, 1994–1998. *Baltic Sea Environmental Proceedings*, No. 82B. 218 pp.
- HELCOM. 2003b. The Baltic Marine Environment 1999–2002. *Baltic Sea Environmental Proceedings*, No. 87. 48 pp.
- ICES. 1996. Guidelines for the determination of chlorobiphenyls in sediments: Analytical methods. In *Report of the ICES Advisory Committee on the Marine Environment, 1996*. ICES Cooperative Research Report, 217: 100–104.
- ICES. 1997: Determination of polycyclic aromatic hydrocarbons (PAHs) in sediments: Analytical methods. In *Report of the ICES Advisory Committee on the Marine Environment, 1997*. ICES Cooperative Research Report, 222: 118–124.
- ICES. 1999. Determination of polycyclic aromatic hydrocarbons (PAHs) in biota In *Report of the ICES Advisory Committee on the Marine Environment, 1998*. ICES Cooperative Research Report, 233: 230–237.
- IOC. 1993: Chlorinated biphenyls in open ocean waters: sampling, extraction, clean-up and instrumental determination. *Manual and Guides No. 27*. UNESCO Press, Paris
- Johnson, W.E., Fendinger, N.J., and Plimmer, J.R. 1991: Solid-phase extraction of pesticides from water: Possible interferences from dissolved organic material. *Analytical Chemistry*, 63: 1510–1513.
- Kulovara, M., 1993. Distribution of DDT and Benzo[a]pyrene between water and dissolved organic matter in natural humic water. *Chemosphere*, 27: 2333–2340.
- Patrick, G., Schulz-Bull, D.E., Martens, V., Scholz, K., and Duinker, J.C. 1996: An in-situ filtration/extraction system for the recovery of trace organics in solution and on particles – tested in deep ocean water. *Marine Chemistry*, 54: 97–105.
- Sturm, B., Knauth, H.D., Theobald, N., and Wünsch, G. 1998. Hydrophobic organic micropollutants in samples of coastal waters: efficiencies of solid-phase extraction in the presence of humic substances. *Fresenius Journal of Analytical Chemistry*, 361: 803–810.
- Theobald, N., Lange, W., Rave, A., Pohle U., and Koennecke, P. 1990: Ein 100-l Glaskugelschöpfer zur kontaminationsfreien Entnahme von Seewasser für die Analyse lipophiler organischer Stoffe. *Dt. Hydrogr. Z.*, 43: 311.
- Topping G. 1992: The role and application of quality assurance in marine environmental protection. *Marine Pollution Bulletin*, 25(1-4): 61–66.
- Wise, S.A., Schantz, M.M., Brenner, B.A., Hays, M.J., and Schiller, S.B. 1995: Certification of polycyclic aromatic hydrocarbons in a marine sediment standard reference material. *Analytical Chemistry*, 67: 1171–1178.

Annex IV:

References

EC (2009). Commission Directive 2009/90/EC laying down, pursuant to Directive 2000/60/EC of the European Parliament and of the Council, technical specifications for chemical analysis and monitoring of water status.

GEOTRACES (2017). Sampling and Sample-handling Protocols for GEOTRACES Cruises (Version 3), edited by the 2017 GEOTRACES Standards and Intercalibration Committee.

HELCOM (2012a). Manual for marine monitoring in the COMBINE programme. Annex B-11, Appendix 1. Technical Note on the determination of trace metals (Cd, Pb, Cu, Co, Zn, Ni, Fe) including mercury in seawater.

HELCOM (2012b). Manual for marine monitoring in the COMBINE programme. Annex B-11, Appendix 2. Technical note on the determination of persistent organic pollutants in seawater.

ICES/OSPAR (2012). JAMP guideline on monitoring of contaminants in seawater: Annex 1: Guidelines for Monitoring of Contaminants in Seawater. ICES Advice 2012, Book 1

Pohl, C. 1997. Trace Metals (Cu, Pb, Zn, Cd, Al, Li, Fe, Mn, Ni, Co) in Marine Suspended Particulate Matter: An International ICES Intercomparison Exercise. Accreditation and Quality Assurance, 2: 2-10

Quémerais, B., and Cossa, D. 1997. Procedures for sampling and analysis of mercury in natural waters. Environment Canada-Quebec region, Environmental Conservation, St. Lawrence Centre. Scientific and Technical Report ST-31E, 34 pp.

Sturgeon, R., and Berman, S. 1987. Sampling and storage of natural water for trace metals. In Critical reviews in Analytical Chemistry. 18(3): 209-244. CRC Press.

UNEP/MAP (2019) UNEP/MED WG.467/5. IMAP Guidance Factsheets: Update for Common Indicators 13, 14, 17, 18, 20 and 21: New proposal for candidate indicators 26 and 27.

UNEP (2019a) UNEP/MED WG.463/6. Monitoring Protocols for IMAP Common Indicators related to pollution.

Appendix 21

Monitoring Guidelines/Protocols for Sample Preparation and Analysis of Seawater for IMAP Common Indicator 17: Heavy and Trace Elements and Organic Contaminants

1. Introduction

1. According to IMAP requirements (UNEP/MAP, 2019a²⁹⁹ and UNEP/MAP, 2019b³⁰⁰) seawater is not included in the mandatory matrices to be analysed in the framework of the UNEP/MAP's Integrated Monitoring and Assessment Programme (IMAP), therefore no list of contaminants has been designated as mandatory for analysis. However, seawater pollution is an issue of concern that might be introduced at latter stage of the IMAP implementation. Therefore, at this stage of IMAP implementation, it is recommended that seawater monitoring is carried out on a country decision basis, including contaminants that countries consider more appropriate and technically feasible to be monitored.

2. Seawater analysis is a complex endeavour including sampling, sample processing and analysis, requiring careful design and implementation. The major analytical challenge of heavy metals and organic contaminants analysis in seawater, is their extremely low concentrations (especially in offshore areas), which requires an ultra-clean laboratory's environment to avoid cross-contamination of the samples, appropriate analytical equipment to accurately measure ultra-low concentration and appropriate staff expertise for this kind of analysis.

3. The Protocols prepared in the framework of this Monitoring Guidelines for Sample Preparation and Analysis of Seawater for IMAP Common Indicator 17, as provided here-below, describe appropriate methodologies for the analysis of seawater for the determination of heavy metals and organic contaminants, in order to ensure quality assured data. They are not intended to be analytical training manuals, but guidelines for Mediterranean laboratories, which should be tested and modified in order to validate their final results. These Protocols aim at streamlining marine seawater sample preparation and analysis for heavy metals and organic contaminants in a view of assuring comparable quality assurance of the data, as well as comparability between sampling areas and different national monitoring programmes, by providing a step-by-step guidance on the methods to be applied in the Mediterranean.

4. In order to avoid unnecessary repetitions, reference is also made to the protocols already published and publicly accessible, which can also be used by the Contracting Parties' competent laboratories participating in IMAP implementation. Regarding the analysis of heavy metals, here-below elaborated IMAP Protocols build on the Guidelines/Protocols developed by GEOTRACES, HELCOM (Annexes I and V), ICES/OSPAR (Annex VII) and US EPA (Annex IV), as well as on analytical methods which have been developed by IAEA for sediment (Annexes II and III and VI). Given the suitability of any of these Guidelines in the context of IMAP, they could be further used by interested IMAP competent Mediterranean laboratories for developing their laboratory specific sampling and sample processing methodologies. The Contracting Parties' laboratories should accommodate and always test and modify each step of the procedures to validate their results.

5. The below flow diagram informs on the category of this Monitoring Guideline related to sample preparation and analysis of seawater for IMAP Common Indicator 17 within the structure of all Monitoring Guidelines prepared for IMAP Common Indicators 13, 14, 17, 18 and 20.

²⁹⁹ UNEP/MAP (2019a). UNEP/MED WG.467/5. IMAP Guidance Factsheets: Update for Common Indicators 13, 14, 17, 18, 20 and 21: New proposal for candidate indicators 26 and 27;

³⁰⁰ UNEP (2019b). UNEP/MED WG.463/6. Monitoring Protocols for IMAP Common Indicators related to pollution;

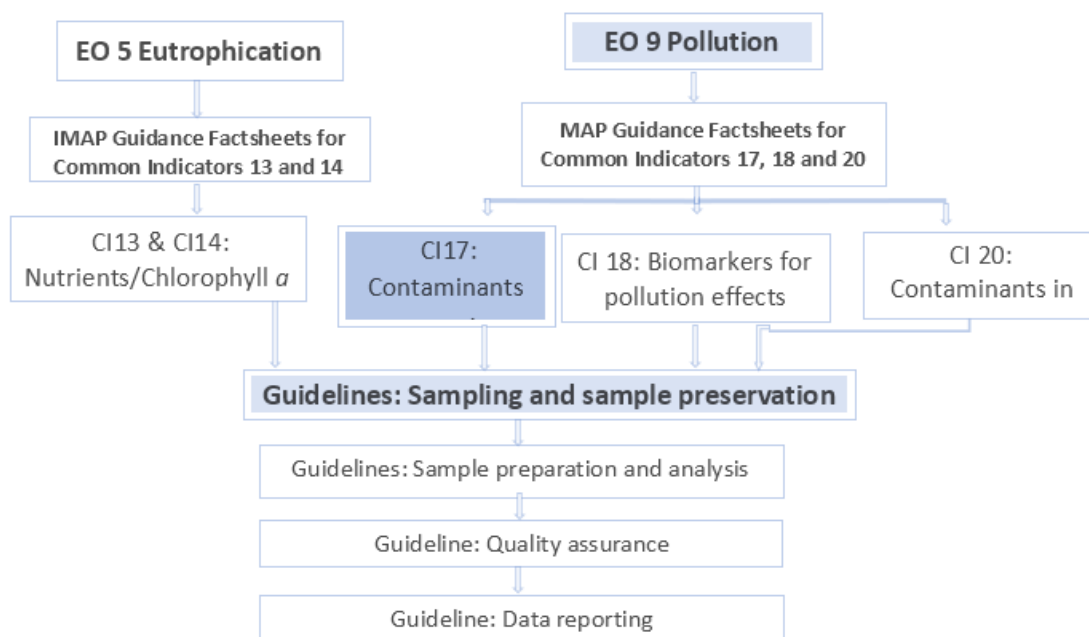

Flow Diagram: Monitoring Guidelines for IMAP Ecological Objectives 5 and 9

2. Technical note for the preparation and analysis of seawater samples for heavy metals³⁰¹

6. Given no list of heavy metals has been agreed as mandatory for analysis in seawater, at this stage of IMAP implementation, Contracting Parties to the Barcelona Convention may decide to include in their seawater monitoring programmes the analysis of metals according to their national priorities. However, since Cadmium (Cd), Lead (Pb) and Total Mercury (THg) are the mandatory metals to be determined in marine sediment and biota samples in the framework of IMAP (UNEP/MAP, 2019a), it makes sense to include these contaminants in any voluntary seawater monitoring programme.

7. National laboratories may decide to use any validated analytical method they consider appropriate, which meets specific performance criteria (LOD, LOQ, precision, recovery and specificity). However, in order to assist analytical laboratories of the Contracting Parties, the IMAP Protocols were developed in order to be used as guidelines for the analysis of heavy metals in seawater samples. Analytical laboratories should accommodate, test and modify each step of the procedures presented in the Protocols in order to validate their final results. The list of methods and analytical equipment is not exhaustive, and laboratories are encouraged to use their own equipment/methods that consider adequate for the required analyses.

a) Analysis of heavy metals

8. Seawater analysis could be performed using unfiltered or filtered (0.45 µm) seawater samples. If the analysis is performed on unfiltered seawater, the sample is analysed following directly the appropriate protocol. In this case a seawater sub-sample has to be filtered to record the suspended particulate matter (SPM) content. If both the filtered seawater and the relative SPM are analysed, the

³⁰¹ The term “heavy metals” used in the Guideline refers to both heavy metals and trace elements

later has to be digested following the protocols for sediment digestion, as presented in Protocol for SPM digestion using nitric acid and hydrofluoric acid of the present Guideline.

9. Because of the expected dissolved metal concentration range (10^{-4} - 10^{-6} mg kg⁻¹) and the salt matrix interference during the measurement process, preconcentration techniques and/or the elimination of sea salt has to be carried out prior to the analysis of the dissolved phase. For the analysis of the SPM retained in the filter, a first step of digestion is required, using an acid mixture (HCl, HNO₃ and HF). The determination of metals in seawater and digested SPM samples could be done with analytical techniques, such as GF-AAS, ICP-MS, ICP-AES (ICP-atomic emission spectrometry), electrochemical methods, or total-reflection X-ray fluorescence (TXRF).

10. Regardless of the analytical method used, heavy metal analysis follow some procedures common to all analytical methodologies, such as the calibration of the analytical equipment and the cleaning and handling procedures to avoid the contamination of the samples from the laboratory's environment and the tools and containers used in the analysis.

b) Calibration

11. Calibration standards should be prepared from single standard stock solutions or multielement standards by dilution of the stock solution using dilute acid, as required. All standard solutions have to be stored in polyethylene, borosilicate or quartz volumetric flasks. Standard solutions with lower concentrations, if prepared correctly and controlled in a QA system (checking of old versus new standards, and checking with standards from a different source), can be kept for a period no longer than one month.

12. The calibration procedure has to meet some basic criteria in order to give the best estimate of the true element concentration of the sample analysed (HELCOM, 2012a³⁰²) (Annex I):

- i) The concentrations of standards for the preparation of the calibration curve (function) should cover the range of concentrations as related to practical conditions; the mean of the range should be roughly equal to the expected analyte concentration in the sample;
- ii) The required analytical precision should be known and achievable throughout the entire range of concentrations;
- iii) The measured value (instrument signal) at the lower end of the range has to be significantly different from the procedural analytical blank;
- iv) The chemical and physical properties of the calibration standards must closely resemble those of the sample under investigation, i.e. the difference in density between the standard and environmental sample should be minimized (this is of particular importance in flame atomic absorption determinations);

13. The concentrations of standards for the preparation of the calibration curve should cover the range of concentrations as related to practical conditions; the mean of the range should be roughly equal to the expected analyte concentration in the sample.

c) Avoiding sample contamination

14. To avoid metal contamination in the laboratory all glassware and plastic vessels used should be carefully cleaned. The general cleaning guidelines include:

³⁰² HELCOM (2012a). Manual for marine monitoring in the COMBINE programme. Annex B-11, Appendix 1. Technical Note on the determination of trace metals (Cd, Pb, Cu, Co, Zn, Ni, Fe) including mercury in seawater.

- i) Allow the vessels to soak overnight in a plastic container in an alkaline surfactant solution (e.g., Micro solution 2% in tap or distilled water).
- ii) Rinse thoroughly first with tap water then with ultrapure deionised water.
- iii) Leave the vessels to stand in 10% (v/v) concentrated analytical grade HNO₃ solution at room temperature for at least 6 days.
- iv) Rinse thoroughly with ultrapure deionised water (at least 4 times).
- v) Allow the vessels to dry under a laminar flow hood.
- vi) Store the vessels in closed plastic polyethylene zip-lock bags to prevent the risk of contamination prior to use.

15. This procedure should be used for all plastic ware use in the laboratory as tips, cup for autosampler, plastic containers.

16. Under this Technical Note, this Guidelines for sample preparation and analysis of sea water samples for heavy metals provides the following IMAP Protocols:

- Protocol for SPM digestion using nitric acid and hydrofluoric acid;
- Protocol for the analysis of heavy metals in seawater with Graphite Furnace Atomic Absorption Spectroscopy (GF-AAS);
- Protocol for the analysis of heavy metals in seawater with Inductive Coupled Plasma – Mass Spectroscopy (ICP-MS);
- Protocol for the analysis of THg in seawater with Cold Vapour- Atomic Fluorescence Spectroscopy (CV-AFS).

17. These Protocols are based on Guidelines developed by GEOTRACES³⁰³, HELCOM (2012a) (Annex I), ICES/OSPAR (2012³⁰⁴) (Annex VII) and US EPA (1995³⁰⁵) (Annex IV). Analytical methods are also based on similar methods, which have been developed for other media (sediment) (IAEA, 2011a³⁰⁶ (Annex II) and 2011b³⁰⁷ (Annex III).

2.1 Protocol for SPM digestion using nitric acid and hydrofluoric acid

18. Suspended Particulate Matter (SPM) samples have to be digested prior to analysis. The rate of digestion and the efficiency of acid decomposition increase substantially with elevated temperatures and pressure, therefore microwave digestion in closed vessels is the preferred method. However, in case no such equipment is available, sample digestion over a hot plate is an alternative method. The digestion method dissolves completely the filter material, therefore it is of paramount importance to use a filter material with very low metal content, to avoid misinterpretation of the results (polycarbonate or cellulose acetate).

³⁰³ GEOTRACES (2017). Sampling and Sample-handling Protocols for GEOTRACES Cruises (Version 3), edited by the 2017 GEOTRACES Standards and Intercalibration Committee.

³⁰⁴ ICES/OSPAR (2012). JAMP guideline on monitoring of contaminants in seawater: Annex 1: Guidelines for Monitoring of Contaminants in Seawater. ICES Advice 2012, Book 1

³⁰⁵ US EPA (1995). Method 1640: Determination of trace elements in ambient waters by on-line chelation preconcentration and Inductively Coupled Plasma Mass Spectrometry.

³⁰⁶ IAEA (2011a). Recommended method on microwave digestion of marine samples for the determination of trace element content

³⁰⁷ IAEA (2011b) Recommended method for the determination of selected trace element in samples of marine origin by atomic absorption spectrometry using graphite furnace

19. The use of hydrofluoric acid (HF) is required for a complete disintegration of the silicate matter of SPM and the determination of the total metal load. Furthermore, Certified Reference Materials (CRMs) of sediments, which can be used also for SPM analysis, provide certified values for total metal concentrations, therefore their use to strengthen data quality assurance requires the measurement of the total metal content in SPM samples.

a) Microwave acid digestion in closed systems (for heavy metals for GFAAS and ICP-MS analysis)

20. SPM digestion can be performed in Teflon closed vials, under heat and pressure, following the methodology proposed for sediments (Loring and Rantala, 1991³⁰⁸). Filters with SPM, with already known weight of SPM, are transferred to a Teflon vial inside a laminar hood compatible with acid fume. Then the protocol for sediment digestion is followed (IAEA, 2011a). Approximately 5 ml of nitric acid and 2 ml of hydrofluoric acid are added and each vessel and let to react for at least 1 hour (or more if possible). After the room temperature pre-digestion, 2ml of hydrogen peroxide are added carefully, the vessels are closed and placed in the microwave apparatus and digestion steps are followed, following the IAEA's "Recommended method on microwave digestion of marine samples for the determination of trace element content" (Annex II, IAEA 2011a). Because closed vessels retain the HF, boric acid is added after the HF digestion to complex the remaining HF and make the resulting solution less hazardous, as well as preventing aluminium fluoride precipitation. After digestion the vessels are removed from the microwave apparatus and placed in a ventilated fume hood to cool. When the pressure is adequate, the vessels are opened, and their content is transferred to a volumetric flask and made to a known volume. All reagents used are analytical grade.

b) Acid digestion on a hot plate

21. A method for the digestion of filters and SPM using HF and HNO₃ in Teflon containers on a hot plate are proposed by GEOTRACES (2017). The use of HF is essential because it is the only acid that completely dissolves the silicate lattices and releases all the metals.

22. Digestion procedure with complete destruction of the filter material

- i) Ideally, one filter is to be digested per digestion vial.
- ii) 10% HF/50% HNO₃ (v/v) digest solution is recommended in order to achieve complete dissolution of all particle types, and in particular to bring all lithogenic material in solution.
- iii) MF-Millipore filters are placed in the bottom of the vial because a complete digestion of the cellulose filter is achieved in under these conditions.
- iv) 47 mm filters are cleanly cut in half using a ceramic blade scalpel, or rotary cutter and the halves placed on opposite sides of the vial for refluxing.
- v) Typically, for a 25 mm diameter filter, add 1 mL of 50% HNO₃/10% HF solution to each vial. Roll acid around inside vial to ensure full contact with filter.
- vi) Close the caps tightly and place vials on a Teflon or silicone surface hot plate at 130° C for 4 hours.
- vii) After a cool down period, collect all the droplets from the cap and inside of the vials down to the bottom of the vial by either tapping the sealed vials or rolling the solution around.
- viii) Dry down the solution on the hot plate at 130° C. Watch it until near dryness, reducing heat as necessary. Remove when droplet is reduced to <5 µL volume.
- ix) This step reduces the HF in the sample and allows the matrix to be switched to dilute nitric acid for analysis. Heat lamps cleanly mounted above the hot plate may help prevent condensation on vial walls.

³⁰⁸ Loring DH and Rantala RTT (1991). Manual for the geochemical analyses of marine sediments and suspended particulate matter. Earth-Science Review, 32: 235:283. Elsevier Science Publishers B.V

- x) If desired, add 100 µL concentrated HNO₃, directly onto residual droplet, and dry down again to same size droplet. This ensures sufficient HF removal so that glass and quartz components of the introduction system of the analytical instrument are not etched or degraded.

2.2 Protocol for the analysis of heavy metals in seawater with GF-AAS

23. In seawater Al, Cd, Pb, Cu, Cr, Ni, as well as other metals, can be determined by Graphite Furnace Atomic Absorption Spectroscopy (GF-AAS), which has adequate sensitivity for these determinations. Direct analysis of seawater is limited by very low metal concentrations and spectral and non-spectral interferences caused by the sea water matrix, therefore a preconcentration step for matrix removal is often used before analysis.

24. Prior to analysis, dissolved metals can be pre-concentrated on Chelex-100 resin (Kingston, et al, 1978³⁰⁹). The pH of the seawater samples is adjusted to 5 – 5.5 and the sample is passed through a Chelex-100 resin. Alkali and alkaline earth metals are then eluted from the resin with ammonium acetate (CH₃COONH₄) and the trace elements are eluted with two 5 ml aliquots of 2.5 M HNO₃. The whole processing of seawater samples, including metal pre-concentration has to be done under clean conditions (ISO Class 5 clean room) taking precautions to avoid any metal contamination of the samples (appropriate clothing including gloves). All reagents are analytical grade. The pre-concentration system consists of a column of a chelating resin, a sample loop constructed for a narrow-bore, high pressure inert tubing (such as ethylene tetra-fluoroethylene - ETFE), an eluent pumping system to deliver one or two eluents, argon gas supply and solution reservoirs (US EPA Method 1640, 1995; Annex III).

25. Automatic pre-concentration of metals in seawater can be achieved using the SeaFAST system, which improves elemental detection limits in undiluted seawater by both preconcentrating analyte and eliminating matrix components. The system can be operated off-line using a chelation column to pre-concentrate metals prior to analysis.

26. The pre-concentrated seawater sample is then analysed for heavy metals by GF-AAS, following the analytical protocol prepared by IAEA (2011) presented in the Annex III. Analysis of trace metals in biological and sediment samples

2.3 Protocol for the analysis of heavy metals in seawater with ICP-MS

27. Inductive Coupled Plasma – Mass Spectroscopy (ICP-MS) is currently state-of-the-art instrumentation for metal analysis, with the possibility to determine at sub-µg/L concentrations of a large number of elements in water. However, direct analysis of seawater is limited by spectral and non-spectral interferences caused by the sea water matrix, therefore a preconcentration step for matrix removal is often used before analysis.

28. ICP-MS allows a rapid analysis of a wide range of heavy metals. Most routine instruments utilize a quadrupole mass spectrometer, so mass resolution is not high enough to avoid overlap of double charged elements or multi-element ions (mainly hydrides, oxides and hydroxides) formed in the plasma. The main concern is for the Argon (Ar) interferences as the plasma is usually an argon plasma, overlapping with As. Some elements are prone to memory effects (particularly Hg) and needs extra precautions to avoid carry over effects (HELCOM 2012a).

³⁰⁹ Kingston, H.M., Barnes, I.L., Brady, T.J., Rains, T.C., and Champ, M.A. (1978). Separation of eight transition elements from alkali and alkaline earth elements in estuarine and seawater with chelating resin and their determination by graphite furnace atomic absorption spectrometry. *Analytical Chemistry*, 50 (14): 2064-2070.

29. A multi-elemental determination of heavy metals by ICP-MS in water samples is described in the US EPA Method 1640 (1994). The method includes a first preconcentration step with a chelating resin (i.e. Chelex 100) using a system consisting of a column with the chelating resin, a sample loop constructed for a narrow-bore, high pressure inert tubing, an eluent pumping system to deliver one or two eluents, argon gas supply and solution reservoirs. The preconcentration system is linked with the ICP-MS for metal determination. The US EPA Method 1640 is presented in Annex IV. . The automate SeaFAST metal preconcentration system can be operated in-line, linked to the ICP-MS.

2.4 Protocol for the analysis of Total Mercury in seawater with CV-AFS

30. Total mercury in seawater can be analysed efficiently using Cold Vapour Atomic Fluorescence Spectroscopic (CV- AFS) and Inductively Coupled Plasma-Mass Spectrometry (ICP-MS) (with isotope dilution). Cold Vapour Atomic Absorption Spectrometry (CV-AAS) is not a preferable method for Mercury analysis because according to GEOTRACES's (2017) intercalibration exercises, the method does not exhibit adequate sensitivity to detect total Hg. CV-AFS has the advantage to allow rapid determination of total Hg and DGM ($\text{Hg}^0 + (\text{CH}_3)_2\text{Hg}$) at sea, while ICP-MS has the potential for a lower absolute detection limit. A recommended Hg workflow for the determination of total Hg in seawater with CV-AFS is presented in the Sampling and Sample-handling Protocols for GEOTRACES Cruises (GEOTRACES, 2017).

3. Technical note for the preparation and analysis of seawater samples for organic contaminants

31. As already elaborated above for metals, the Contracting Parties to the Barcelona Convention may decide to include in their seawater monitoring programmes the analysis of organic contaminants according to their national priorities, given no list of organic contaminants has been agreed as mandatory for analysis in seawater, at this stage of IMAP implementation. However, since chlorinated hydrocarbons and PAHs are mandatory contaminants to be determined in marine sediments and biota in the framework of IMAP (UNEP/MAP, 2019a; UNEP/MAP 2019b), it makes sense to include these contaminants in any voluntary seawater monitoring programme.

32. Same analytical methods can be used for the determination of lipophilic pollutants in extracts of water samples as are used for extracts of sediments. However, the distribution of contaminants in seawater are influenced by their polarity. Therefore, more hydrophilic organic compounds (such as 2- and 3-ring PAHs and HCH isomers) are distributed in the dissolved phase, while more lipophilic compounds (such as 4- to 6-ring PSHs, DDT group and PCBs) are mainly found in SPM.

33. In monitoring programmes, total seawater (unfiltered) is usually analysed for organic contaminants. The analytical procedure includes the simultaneous extraction of organic contaminants from seawater, clean-up and analytical determination. The extraction of the organic contaminants is also concentrating the compounds enabling their enrichment in the solution to be analysed. This is an important step, since the concentrations of the organic contaminants in total seawater are extremely low (from 10 pg L^{-1} to 10 ng L^{-1} , HELCOM, 2012b³¹⁰). Extraction can be done by liquid-liquid extraction (LLE) (using a non-polar solvent such as hexane) or by solid-phase extraction (SPE). It has to be emphasized that all steps of the procedure are susceptible to insufficient recovery and/or contamination. Therefore, regular quality control procedures must be applied to check the performance of the whole method.

34. A description of the procedures for the extraction seawater by liquid-liquid extraction (LLE) and solid-phase extraction (SPE) are presented in the "Technical Note on the determination of

³¹⁰ HELCOM (2012b). Manual for marine monitoring in the COMBINE programme. Annex B-11 Appendix 2: Technical annex on the determination of heavy metals and persistent organic compounds in seawater. Appendix 2. Technical note on the determination of persistent organic compounds in seawater

persistent organic pollutants in seawater” of HELCOM (2012b) (Annex V). It is noted that the SPE has the advantage of being able to extract very large water volumes (up to 1000 l) and to incorporate a phase separation to obtain separate samples for SPM and the solute phase. However, the method requires longer sampling time, more complex instrumentation, and problems with validation and control of the extraction efficiency. On the other hand, the LLE has the advantage that it can be easily validated and controlled, as internal standards can be added before extraction. The limitation in sample volume is only relative, since sampling volume of 100 l is sufficient for nearly all monitoring tasks. HELCOM (2012b) concludes that “Because of the robustness of the method, there is a preference LLE for routine monitoring purposes for all lipophilic organic contaminants”.

35. Although there are less interferences from matrix compounds in seawater samples than in sediments or biota, extracts require a clean-up before the chromatographic separation and determination. A clean-up procedure using short silica gel chromatography columns that can be applied with GC-ECD and GC-MS methods, is proposed by HELCOM (2012b), using silica dried at 200° C and subsequently washed with CH₂Cl₂ and hexane. The hexane sample extract is applied on top of the column and eluted with CH₂Cl₂/hexane and then with acetone. Fraction 1 contains all lipophilic compounds of interest (PAHs and all chlorinated hydrocarbons (from HCB to HCH)); this fraction can be used for GC-MS determination after concentration to 50–300 µl. All reagents are of analytical grade.

36. Following the simultaneous extraction and clean-up, the determination of organochlorine pesticides - PCBs and PAHs will be done following the respective analytical procedures. National laboratories may decide to use any validated analytical method they consider appropriate, which meets specific performance criteria (LOD, LOQ, precision, recovery and specificity). The here-below proposed IMAP analytical Protocols are based on the HELCOM (2012b) (Annex V) guidelines for organic contaminants (chlorinated hydrocarbons and PAHs) analysis in seawater and the analytical method developed by UNEP/IAEA (2011³¹¹) (Annex VI), for the analysis of chlorinated hydrocarbons in sediment. Analytical laboratories should accommodate, test and modify each step of the procedures presented in here-below provided IMAP Protocols in order to validate their final results. The list of methods and analytical equipment is not exhaustive, and laboratories are encouraged to use their own equipment/methods that consider adequate for the required analyses.

37. Under this Technical Note, this Guidelines for sample preparation and analysis of sea water samples for organic compounds provides the following IMAP Protocols:

- Protocol for the analysis of organochlorine pesticides and PCBs in seawater using Gas Chromatography - Electron Capture Detector (GC-ECD) or Gas Chromatography - Mass Spectroscopy (GC-MS);
- Protocol for the analysis of PAHs in seawater using Gas Chromatography - Mass Spectroscopy (GC-MS).

38. These protocols are based on Analytical Methods developed by UNEP/IAEA (2011): Sample work-up for the analysis of selected chlorinated hydrocarbons in the marine environment. Reference Methods for Marine Pollution Studies No 71, HELCOM (2012b): Manual for marine monitoring in the COMBINE programme. Annex B-11, Appendix 2. Technical note on the determination of persistent organic pollutants in seawater and ICES/OSPAR (2012): JAMP Guidelines for monitoring contaminants in seawater.

³¹¹ UNEP/IAEA (2011). Sample work-up for the analysis of selected chlorinated hydrocarbons in the marine environment. Reference Methods for Marine Pollution Studies No 71

3.1 Protocol for the analysis of organochlorine pesticides and PCBs in seawater using GC-ECD or GC-MS

39. Following extraction and clean-up, as described in the Technical Note for the preparation and analysis of seawater samples for organic contaminants, organochlorine pesticides and PCBs can be analysed by GC-ECD or GC-MS following the guidelines for the analysis of sediment and biota matrices proposed by UNEP/IAEA (2011) (Annex VI), HELCOME (2012b) (Annexes V) and ICES/OSPAR (Annex VII).

3.2 Protocol for the analysis of PAHs in seawater using GC-MS

40. Following extraction and clean-up, as described in the Technical Note for the preparation and analysis of seawater samples for organic contaminants, PAHs can be analysed by GC-MS following the guidelines for the analysis of sediment and biota matrices proposed by HELCOME (2012b) (Annex V) or ICES/OSPAR (Annex VII).

Appendix 21
HELCOM

Manual for marine monitoring in the COMBINE programme

**ANNEX B-11 TECHNICAL NOTE ON THE DETERMINATION OF HEAVY METALS AND
PERSISTENT ORGANIC COMPOUNDS IN SEAWATER**

**ANNEX B-11, APPENDIX 1. TECHNICAL NOTE ON THE DETERMINATION OF TRACE
METALS (CD, PB, CU, CO, ZN, NI, FE), INCLUDING MERCURY, IN SEAWATER**

HELCOM Manual for marine monitoring in the COMBINE programme

ANNEX B-11 TECHNICAL NOTE ON THE DETERMINATION OF HEAVY METALS AND PERSISTENT ORGANIC COMPOUNDS IN SEAWATER

ANNEX B-11, APPENDIX 1. TECHNICAL NOTE ON THE DETERMINATION OF TRACE METALS (CD, PB, CU, CO, ZN, NI, FE), INCLUDING MERCURY, IN SEAWATER

Introduction

General techniques which address the questions of water sampling, storage, filtration procedures and determination of trace metals in natural sea water are described by Sturgeon and Berman (1987) and Gill and Fitzgerald (1985, 1987).

For the determination of mercury in sea water, the chemical species of this element are of importance. Therefore, a differentiation between the several Hg species, including ionic, volatile, dissolved (organic) complexes or particulate adsorbed Hg, has to be considered during sample preparation.

Several definitions of mercury compounds are common (Cossa et al., 1996, 1997), for example:

Reactive mercury (HgR): A methodologically defined fraction consisting mostly of inorganic Hg(II).

Total mercury (HgT): Mercury content of an unfiltered sample, after digestion with an oxidizing compound (e.g., K MnO₄).

Total dissolved mercury: Mercury content of a filtered sample, after digestion with an oxidizing compound (e.g., K MnO₄).

Dissolved gaseous mercury (DGM): This includes elemental mercury (Hg), monomethylmercury (MM-Hg) and dimethylmercury (DM-Hg).

1. CLEAN LABORATORY; CLEAN BENCHES

Particles are everywhere, including dust in the air or on clothes, hair or skin. Owing to the clothes, the person who is working with the samples for trace metal analysis is the main source of contamination because this person is a particle producer. One of the most important things during sample pretreatment for trace metal analysis is to eliminate particles that can contaminate the samples or the sample containers from the laboratory environment.

The best way to eliminate most of this contamination is to work under a laminar flow box with a laminar horizontal flow (sample protection). Recommended conditions for a 'clean bench' or a 'clean lab' are class 100 (US Norm) which means that there are still about one hundred particles present per cubic foot or class 3 (DIN-Norm), which equals 3000 particles per m³ (corresponding to class 100 US Norm).

2. PREPARATIONS

Chemicals

High purity water (e.g., 'Milli-Q water', 18 M cm⁻¹) freshly prepared, is termed 'water' in the following text.

A sub-boiling quartz still is recommended for the distillation of highly purified acids and solvents. A teflon still is recommended for the distillation of HF.

Amalgamation (filtration of oversaturated solutions with goldnet) and volatilization (bubbling with ultrapure argon) are effective methods to purify (clean) chemicals and solutions for mercury analysis.

In order to avoid contamination problems, all plastic ware, bottles and containers must be treated with acids (HCl or HNO₃) for several weeks and then rinsed with water and covered in plastic bags until use.

The following procedures (Patterson and Settle, 1976) are suggested:

Laboratory ware

Store in 2M HCl (high purity) for one week, rinse with water, store in water for one week and dry under dust-free conditions (clean bench).

Samplers and bottles

Sampling devices: Fill with 1% HNO₃ (high purity), store at room temperature for three weeks, and rinse with water .

Teflon/quartz bottles: Store in warm (40 C ±5 C) 1:1 diluted HCl for one week. Then rinse with water and store with 1M HNO₃ (high purity) until the final use (a minimum of three weeks).

Modified cleaning procedures are required for mercury. Glass containers (borosilicate, quartz) used for the collection and storage of samples for the determination of mercury are usually cleaned using an oxidizing procedure described by Sturgeon and Berman (1987). Bottles are filled with a solution of 0.1 % KMnO₄, 0.1% K₂S₂O₈ and 2.5 % HNO₃ and heated for 2 hours at 80 C. The bottles are then rinsed with water and stored with 2 % HNO₃ containing 0.01 % K₂Cr₂O₇ or KMnO₄ until ready for use.

Filters

Polycarbonate filters (e.g., Nuclepore) (0.4 m, 47 mm diameter) are recommended for trace metals except mercury. Store the filters in 2M HCl (high purity) for a minimum of three weeks. After rinsing with water, store for one more week in water.

For the determination of mercury, glass microfibre filters (GF/F grade, Millipore type) and teflon filters are recommended for the filtration of natural water samples. Cleaning of these filters is comparable to the procedure used for polycarbonate filters. For GF/F filters, an additional drying step has to be considered (450 C for 12-24 hr) to volatilize gaseous mercury. This procedure is described in detail by Queremais & Cossa (1997).

If trace metals in suspended particulate matter (SPM) are to be determined, filters have to be placed in precleaned plastic dishes, dried in a clean bench for two days, and stored in a desiccator until they are weighed using an electronic microbalance with antistatic properties. Each filter has to be weighed daily for several days until the weight is constant. The same procedure for drying and weighing should be applied to the filters loaded with SPM (Pohl, 1997).

3. SAMPLING AND SAMPLE HANDLING

The basis for the reliable measurement of extremely low concentrations of trace metals in sea water is a well-performed sampling to avoid contamination risk from the ship. Careful handling is recommended because copper and tin are still the main substances used in antifouling paints on ships and there is also a risk of contamination by zinc (anodes of the ship), iron or lead.

In coastal and continental shelf waters, samples are collected using 30 l teflon-coated GO-FLO (General Oceanics, close-open-close system) bottles with teflon O-rings deployed on Kevlar or on a Hostalen coated wire. Niskin bottles deployed on rosettes using standard stainless steel hydrowire are also acceptable. For surface waters, an all-teflon MERCOS-Sampler (Hydrobios) could be chosen.

PVC gloves should be worn during subsampling into the precleaned quartz or teflon bottles (teflon has an extra low content of trace metals). Subsampling should be carried out in a clean lab or a clean-lab container, if available.

Pumping of samples using peristaltic or teflon piston pumps must be carried out using precleaned silicon- or teflon-lined tubes.

In the absence of clean-lab conditions, sampling and sample handling must be carried out in a closed system, or contamination cannot be avoided.

For mercury analysis, it should be noted that the integrity during sampling and storage may be jeopardized by the addition of mercury to the sample as well as by unexpected losses owing to volatilization.

4. FILTRATION PROCEDURE

In the environmental and geochemical scientific community concerned with water analysis, it has generally been accepted that the term 'dissolved' refers to that fraction of water and its constituents which have passed through a 0.45 µm membrane filter. This is an operationally defined fraction. Coastal and shelf water samples have to be filtered to eliminate particles from the water. A number of metal species pass through this filter pore size, including metals bound to colloids or clays or to humic, fulvic, amino, and fatty acids.

To prevent desorption of metal ions from particle surfaces or from biological degradation of SPM, separation between the dissolved phase and the particulate phase has to be done immediately after sampling by filtering the water through a 0.45 µm polycarbonate filter. This procedure should be carried out under clean conditions (clean benches are recommended on board the ship).

If metals in both the dissolved and particulate phases are to be analysed, pressure filtration with nitrogen is recommended. After filtration the filter should be rinsed with high purity isotonic solution to remove sea salt residues. Only a few millilitres are necessary because a change of pH could cause desorption of metal ions from the particles. In pumping systems, on-line filtration is possible.

5. STORAGE OF SAMPLES

To avoid wall adsorption of metal ions, 1.5 ml HNO₃ or HCl (high purity) should be added per litre of seawater sample immediately after filtration for acidification to pH 1.0-1.6. The sample containers should be stored in plastic bags under controlled environmental conditions. The filters should be stored in plastic dishes at -18 °C or below. Under these conditions, both water samples and SPM on filters can be stored for at least one year.

Special consideration must be given to samples destined for Hg determinations. It is necessary to add either oxidants (Cr₂O₇²⁻) in addition to acidification or complexing agents (cysteine) to neutral or alkaline samples to prevent Hg losses during storage.

6. SAMPLE PRETREATMENT

Water samples

Depending on the expected concentration range (10⁻⁷-10⁻⁹ g kg⁻¹) of trace metals (dissolved) in Baltic Sea water and because of the salt matrix interfering during the measurement process, preconcentration techniques and/or the elimination of sea salt has to be carried out prior to the analytical measurement. Detailed method information is available in the open literature (e.g., Danielsson et al., 1978; Kremling et al., 1983; and Pohl, 1994).

Filters

Different methods to analyse the material on the filter are described by Hovind and Skei (1992) and Loring and Rantala (1991). Pressure decomposition with an acid mixture (HCl, HNO₃, HF) is recommended. If the silica content is high due to diatoms, the HF concentration should be increased accordingly. If the organic content increases, it is advisable to work with perchloric acid.

Depending on the digestion system used (high pressure autoclave, microwave digestion, wet ashing in an open system, or dry ashing), the completeness of the digestion is a function of temperature, time, digestion material and pressure, and has to be tested and validated in pilot studies with (certified) reference materials (see the detailed remarks in Annex B-7, Section 4.3).

Digestion of samples for mercury analysis must always be carried out in a closed system to prevent losses by evaporation.

7. INSTRUMENTATION

For the analytical measurements, several analytical techniques can be used, such as GFAAS (graphite furnace atomic absorption spectrometry), electrochemical methods, ICP-MS (inductively coupled plasma-mass spectrometry), ICP-AES (inductively coupled plasma-atomic emission spectrometry), or total-reflection X-ray fluorescence (TXRF).

Because of the very low mercury concentrations in sea water, the most widely used technique for mercury is the cold vapour technique (reduction of mercury with SnCl₂ to elemental Hg) and preconcentration of mercury by amalgamation on a gold trap. This is followed by atomic absorption spectrometry or by atomic fluorescence spectrometry, with detection limits adequate for the purpose. In the case of anoxic (sulfur-containing waters), see Annex B-11.

8. QUALITY CONTROL

The internal quality control is described in Chapter B.5 of the Manual.

Blank

Particularly in the case of trace metal analysis, with high contamination risks at each step of the analytical work, a satisfactory blank control is necessary. Therefore, it is important to control the blank daily, for reproducibility and constancy over a longer time. The blank should include all analytical pretreatment procedures, including the addition of the same quantities of chemical substances as for the sample.

Calibration

For calibration purposes, single element standard stock solutions at a concentration of 1000 mg dm⁻³, purchased from a qualified manufacturer, should be available. Preparation date and concentration should be marked on the bottle. From this stock solution, a multi-element working standard solution can be prepared using dilute HCl or HNO₃ as required (normally 1M acid is used).

Traceability can be ensured by the use of CRMs or participation in intercomparison exercises.

The working standard should be prepared from the stock standard solution for every batch of samples and kept no longer than two weeks. Precleaned teflon containers are preferable for storage.

To evaluate effects from the matrix, the method of standard addition can be used, particularly in connection with the analytical method of voltammetric stripping. For other techniques, the method of standard addition should generally be used with care (Cardone, 1986a, 1986b).

Reference materials

Owing to problems in defining the blank, the use of a low-concentration CRM is important. Regular participation in intercomparison exercises should be considered mandatory.

REFERENCES

Cardone, M. 1986a. New technique in chemical assay calculations. 1. A survey of calculational practices on a model problem. *Analytical Chemistry*, 58: 433-438.

Cardone, M. 1986b. New technique in chemical assay calculations. 2. Correct solution of the model problem and related concepts. *Analytical Chemistry*, 58: 438-445.

Cossa, D., Coquery, M., Gobeil, C., and Martin, J.M. 1996. Mercury fluxes at the ocean margins. In *Global and regional mercury cycles: sources, fluxes and mass balances*, pp. 229-247. Ed. by W. Baeyens et al. Kluwer Academic Publishers.

Cossa, D., Martin, J.M., Takayanagi, K., and Sanjuan, J. 1997. The distribution and cycling of mercury species in the western Mediterranean. *Deep Sea Research II*, 44(3-4): 721-740.

Danielsson, L.G., Magnusson, B., Westerlund, S. 1978. An improved metal extraction procedure for the determination of trace metals in sea-water by atomic absorption spectrometry with electrothermal atomization. *Analytica Chimica Acta*, 98: 47-57.

Gill, G.A., Fitzgerald, W.F. 1985. Mercury sampling of open ocean waters at the picomolar level. *Deep Sea Research*, 32(3): 287-297.

Gill, G.A., and Fitzgerald, W.F. 1987. Picomolar mercury measurements in seawater and other materials using stannous chloride reduction and two-stage gold amalgamation with gas phase detection. *Marine Chemistry*, 20: 227-243.

Hovind, H., and Skei, J. 1992. Report of the Second ICES Intercomparison Exercise on the Determination of Trace Metals in Suspended Particulate Matter. ICES Cooperative Research Report, No.184. 31 pp.

Kremling, K., Olafsson, I., Andreae, M., and Koroleff, F. 1983. Determination of trace metals. In *Methods of seawater analysis*. Ed. by K. Grasshoff, M. Ehrhardt, and K. Kremling. Verlag Chemie, Weinheim. 419 pp.

Loring, D.H., and Rantala, R.T.T. 1991. Manual for the geochemical analyses of marine sediments and suspended particulate matter. *Earth Science Reviews*, 32: 235-283.

Patterson, C., and Settle, D. 1976. The reduction of orders of magnitude errors in lead analysis of biological materials and natural waters by evaluating and controlling the extent and sources of industrial lead contamination introduced during sample collecting, handling, and analysis. In *Accuracy in trace analysis: Sampling, Sample handling, Analysis*, pp 321-351. Ed. by P. LaFleur. United States National Bureau of Standards Special Publication, No. 422.

Pohl, C. 1994: Meerwasser-Probennahme, Anreicherung und Analytik. In *Probenahme und Aufschluß*. Ed. by M. Stoeppler. Springer-Labormanual, Heidelberg, 181 pp.

Pohl, C. 1997. Trace Metals (Cu, Pb, Zn, Cd, Al, Li, Fe, Mn, Ni, Co) in Marine Suspended Particulate Matter: An International ICES Intercomparison Exercise. *Accreditation and Quality Assurance*, 2: 2-10.

Quémerais, B., and Cossa, D. 1997. Procedures for sampling and analysis of mercury in natural waters. Environment Canada-Quebec region, Environmental Conservation, St. Lawrence Centre. Scientific and Technical Report ST-31E, 34 pp.

Sturgeon, R., and Berman, S. 1987. Sampling and storage of natural water for trace metals. In *Critical reviews in Analytical Chemistry*. 18(3): 209-244. CRC Press.

Last updated: 29.10.2012 (Annex number changed from Annex B 12 to Annex B 11)

Annex II:

**Recommended Method on
MICROWAVE DIGESTION OF MARINE SAMPLES
FOR THE DETERMINATION
OF TRACE ELEMENT CONTENT**



REPORT

Recommended Method on MICROWAVE DIGESTION OF MARINE SAMPLES FOR THE DETERMINATION OF TRACE ELEMENT CONTENT

IAEA/NAEL

**Marine Environmental Studies Laboratory in co-operation with
UNEP/MAP MED POL**

November 2011

For further information on this method, please contact:

IAEA-Environment Laboratories
Marine Environmental Studies Laboratory
4a Quai Antoine 1er
MC-98000 Principality of Monaco

Tel. (377) 979 772 72 Fax. (377) 979 772 73

E-mail: NAEL-MESL.Contact-Point@iaea.org

Recommended Method on
MICROWAVE DIGESTION OF MARINE SAMPLES
FOR THE DETERMINATION OF TRACE ELEMENT CONTENT

DISCLAIMER

This is not an official IAEA publication. The views expressed do not necessarily reflect those of the International Atomic Energy Agency or its Member States.

The material has not undergone an official review by the IAEA. This document should not be quoted or listed as a reference.

The use of particular designations of countries or territories does not imply any judgment by the IAEA, as to the legal status of such countries or territories, of their authorities and institutions or of the delimitation of their boundaries.

The mention of names of specific companies or products (whether or not indicated as registered) does not imply any intention to infringe proprietary rights, nor should it be construed as an endorsement or recommendation on the part of the IAEA.

Limited Distribution

Reproduced by the IAEA

TABLE OF CONTENTS

1. SCOPE	1
2. PRINCIPLE	1
3. SAMPLE PRE-TREATMENT	1
4. REAGENTS	1
5. MATERIAL	2
6. PROCEDURE	2
7. QUALITY CONTROL	5
8. REFERENCES	5

NOTE: This method is not intended to be an analytical training manual. Therefore, the method is written with the assumption that it will be performed by formally trained analytical chemist. Several stages of this procedure are potentially hazardous, especially stages with HF; users should be familiar with the necessary safety precautions.

In addition, the IAEA's recommended methods are intended to be guidance methods that can be used by laboratories as a starting point for generating their own standard operating procedure. If performance data are included in the method, they shall not be used as absolute QC acceptance criteria.

1. SCOPE

The method here below describes the protocol for dissolution of samples from marine origin. Digests are suitable for analyses of total content of trace element in sediment and biological material.

The goal of this method is the total sample decomposition with the judicious choice of acid combinations this is achievable for most matrices. The selection of reagents which give the highest recoveries for the target analytes is considered the optimum method condition.

The recommended protocol is mainly based on the EPA 3052 method; users are encouraged to consult this document (EPA, 1996).

2. PRINCIPLE

The grinded and dried samples are solubilized in an acid mixture using microwave oven apparatus.

The use of hydrofluoric acid allows the decomposition of silicates by reaction of F with Si to form the volatile SiF₄. The excess of hydrofluoric acid is either neutralized by boric acid, or digests are evaporated to dryness depending on the method used to analyze samples.

3. SAMPLE PRE-TREATMENT

Sediment samples are prepared following the recommendations of UNEP (2005).

Marine organisms are prepared following the recommendations of UNEP (1984, 1994).

4. REAGENTS

The reagents used shall meet the purity requirement of the subsequent analyses

- 4.1. ULTRAPUR WATER (type MilliQ).
- 4.2. NITRIC ACID 65%.
- 4.3. HYDROFLUORIC ACID.
- 4.4. HYDROCHLORIC ACID.
- 4.5. BORIC ACID.
- 4.6. HYDROGEN PEROXIDE.

5. MATERIAL

5.1. MICROWAVE APPARATUS

The microwave decomposition system should be temperature controlled. The temperature sensor should be accurate at $\pm 2.5^{\circ}\text{C}$. The calibration of the temperature sensor should be done at least once a year, preferably by the maintenance service of the manufacturer.

The microwave unit should be corrosion resistant.

The unit cavity should be well ventilated and connected to fume cleaner or special neutralizing system.

The method requires microwave transparent and acid resistant material (i.e. PFA, TFM) to be used as reactor. The minimal volume of the vessels should be 45 ml and it should be able to work under the pressure of 800PSI. the reactor system should be equipped with a pressure relief system.

- 5.2. ANALYTICAL BALANCE with 0.001 g precision at least.
- 5.3. FUME HOOD.
- 5.4. LAMINAR FLOW HOOD.
- 5.5. VOLUMETRIC CONTAINERS of 50 ml or 100 ml in polypropylene.
- 5.6. WEIGHING CUP in polyethylene.
- 5.7. PLASTIC SPATULAS.

6. PROCEDURE

- 6.1. All PLASTIC MATERIAL (i.e. volumetric, weighing cup...) should be acid cleaned by soaking in laboratory soap (or 10% alcohol) for at least 24h, followed by 24h of soaking in 10% nitric acid. Stronger acid cleaning protocol could be applied depending on the requirement of the subsequent analyses.
- 6.2. MICROWAVE VESSELS should be at least cleaned after each use by running the same microwave program used for samples with 5 ml of HNO_3 . If the risk of cross contamination is high (i.e. running sandy sediment after organic rich sediment) and/or in the case of long storage, the vessels should be cleaned twice. If available, an acid cleaner

(using acid vapors) can be used as a final cleaning stage. After cleaning, the vessels should be carefully rinsed with water and dried under a laminar flow hood. If a laminar flow hood is not available, vessels should be kept locked in double plastic bag; date of storage should be mentioned on the second bag.

6.3. Accurately weigh 0.1 to 0.5 g of well mixed sample in the microwave vessel.

6.4. In a fume hood, add 5 ml of nitric acid and 2 ml of hydrofluoric acid, close vessels with caps, then it is recommended to let samples react for at least 1 hour (or more if possible). Protect vessels by covering them with plastic bags or place them in a laminar flow hood compatible with acid fume. The quantity of hydrofluoric acid depends on the expected content of silicon dioxide, samples with low concentrations of silicon dioxide (< 10% like plant material to 0% like biological sample) may require less hydrofluoric acid (0.5 ml to 0 ml). Examples of acid quantities for different matrix are listed in table below.

	HF (ml)	HNO ₃ (ml)	HCl (ml)	H ₂ O ₂ (ml)	Boric (g)
Sediment	2	5	2 or 0	2	0.8
Fish	0	5	2 or 0	2	0
Sea plant	0.5	5	2 or 0	2	0

6.5. After room temperature pre-digestion, add 2 ml of hydrogen peroxide and close the reactors as recommended by the microwave manufacturer.

NOTE: The quantity and ratio of reagent can be adapted on a performance based judgment (i.e. visual total digestion, certified reference material results).

- In case of a sample containing high calcium carbonate, the hydrofluoric acid content can be set to 0 to avoid precipitation of insoluble CaF.
- A two stage digestion, using half of the hydrofluoric acid at the first stage and half at the second, could increase recovery and help achieving total decomposition.
- Additional reagent can be added depending on the sample composition to achieve complete dissolution. For example, 2±2 ml of HCl can be added to help the stabilization of As, Sb, Hg, Fe and Al at high level; however HCl might increase analytical difficulties for some techniques (i.e. ICP-MS) (Kingston 1997)
- Only one acid mixture or quantity should be used in a single batch, in the microwave, to insure consistent reaction conditions between all vessels and monitored conditions. This limitation is due to the current practice of monitoring a representative vessel, and applying a uniform microwave field to reproduce these reaction conditions within a group of vessels being simultaneously heated.

6.6. Place the closed reactor in the microwave apparatus, connect temperature and pressure control as specified by the manufacturer. The samples should be heated at 180°C

(minimum) in about 6 minutes and the temperature maintained for at least 10 minutes. The total decomposition is primarily controlled by maintaining samples at 180°C for 10 minutes. The ramping profile can be adapted, especially for safety purpose when very reactive samples are decomposed (i.e. biological material). In that case, it is recommended to increase the ramping time to 10 or 15 minutes. If possible, record temperature and pressure profile. In most samples matrices, pressure should peak between 5 and 15 minutes; profiles can be used to optimize temperature program.

- 6.7. At the end of the temperature profile, let the sample cool until the inside temperature goes down to 60°C, then remove the reactors from the microwave and place them in a ventilated fume hood. The pressure is carefully released following the manufacturer's instruction and reactors are opened.
- 6.8. In the case of removal of hydrofluoric acid excess with boric acid, 0.8 g of boric acid and 15 ml of water are added in the vessel. The quantity of boric acid is proportional to the quantity of hydrofluoric acid (usually 0.4 g for 1 ml should be sufficient). The vessels are closed again and run in the microwave with a program that heat samples at 170°C in 10 minutes and maintain this temperature for 10 minutes.
- 6.9. At the end of the temperature profile, let the sample cool until inside the temperature goes down to 60°C, then remove the reactors from the microwave and place them in a ventilated fume hood. The pressure is carefully released following the manufacturer's instruction and reactors are opened. Transfer the samples in a volumetric container and dilute them to a known volume (or a known weight, this requires to record the tare of each container before).

NOTE: An excess of boric acid will produce cloudy solutions, this might cause problem with sample introduction system of ICP. The use of boric acid will prevent measurement of boron, and possible bias introduced should be carefully investigated.

- If the use of boric acid is not possible, or if it is necessary to reduce the concentration of acid in final solutions, digest can be evaporated to incipient dryness on a hot plate at about 140°C. This stage should be performed in a controlled environment to avoid contamination and acid vapour should be treated. Some microwave oven apparatus can perform evaporation. The residue is then diluted to a known volume in nitric or hydrochloric diluted solution (usually 2% v/v) depending on the subsequent analytical method used.
- In case of insoluble precipitate or residue some extra steps can be performed like the addition of 2 ml of perchloric acid to the solution before evaporation, but this requires doing the evaporation under a specific hood for safety reason. Another option is the addition of 2 ml of concentrated hydrochloric acid, evaporation to near dryness, addition of concentrated nitric acid, evaporation to near dryness and dilution in known volume in 2% nitric acid solution.

Most samples will be totally dissolved by this method with the judicious choice of the acid combinations. A few refractory sample matrix compounds, such as TiO₂, alumina, and other oxides may not be totally dissolved, and in some cases may sequester target analyte elements.

7. QUALITY CONTROL

- 7.1. Each microwave batch should contain at the minimum one certified reference material of representative matrix.
- 7.2. A duplicate or triplicate sample should be processed on a routine basis. A duplicate sample should be processed with each analytical batch or every 10 samples. A duplicate sample should be prepared for each matrix type (i.e. sediment, sea plant, etc.).
- 7.3. A spiked sample should also be included whenever a new sample matrix is being analyzed, especially if no certified reference material is available for that matrix.
- 7.4. Blank samples should be prepared using the same reagents and quantities used in sample preparation, placed in vessels of the same type, and processed with the samples. Each microwave batch should contain at least two blank samples.

8. REFERENCES

EPA (1996) U.S. Environmental Protection Agency, EPA method 3052, Microwave assisted acid digestion of siliceous and organically based matrices Rev 0, December 2007, (<http://www.epa.gov/osw/hazard/testmethods/sw846/pdfs/3052.pdf>).

Kingston, H. M., Haswell, S (1997), Microwave Enhanced Chemistry, ACS Professional Reference.

Book Series; American Chemical Society: Washington, DC, 1997.

UNEP (2005), UNEP (DEC)/MED WG.282/inf.5/Rev1, Method for sediment sampling and analysis, February 2005, UNEP.

UNEP/IOC/IAEA (1984) reference method 7 rev2: Sampling of selected marine organisms and sample preparation for trace metal.

UNEP/IOC/IAEA (1994) reference method 57: Quality assurance and good laboratory practice, UNEP, 1994.

Annex III:

Recommended method for the determination of selected trace element in samples of marine origin by atomic absorption spectrometry using graphite furnace



Recommended method for the determination of selected trace element in samples of marine origin by atomic absorption spectrometry using graphite furnace

Marine Environmental Studies Laboratory in co-operation with MED POL

November 2011

Table of content

1. SCOPE:.....	3
2. PRINCIPLE:.....	3
3. SAMPLE PRE-TREATMENT:	4
4. REAGENTS:	4
5. MATERIALS:	6
6. INTERFERENCES:	6
7. CHEMICAL MODIFICATION:.....	7
8. PROCEDURE	8
9. CALCULATION OF RESULTS:	14
10. EXPRESSION OF RESULTS:	14
11. REFERENCES:.....	14
Table 1 Approximate characteristic masses and typical working range	3
Table 2 Recommended chemical modifiers	8
Table 3 Example of temperature program	9
Table 4 Example of analytical sequence:	12

***NOTE:** This recommended method is not intended to be an analytical training manual. Therefore the method is written with the assumption that it will be performed by formally trained analytical chemist.*

In addition, the IAEA recommended methods are intended to be guidance methods that can be used by laboratories as a starting point for generating their own standard operating procedure. If performance data are included in the method they must not be used as absolute QC acceptance criteria.

The recommended protocol is mainly based on EPA 7010 method and ISO 15586 users are encouraged to consult this documents (US EPA, 2007; ISO 2003)

1. **SCOPE:**

This International Standard includes principles and procedures for the determination of trace levels of: As, Cd, Co, Cr, Cu, Ni, Pb, and V in samples from marine origin, using atomic absorption spectrometry with electro thermal atomization in a graphite furnace. The method is applicable to the determination of low concentrations of elements. The detection limit of the method for each element depends on the sample matrix as well as the instrument, the type of atomizer and the use of chemical modifiers. Table 1 gives approximate working range and characteristic masses.

Table 1 Approximate characteristic masses and typical working range using 20µl sample volume

Element	Characteristic mass M_0^* pg	Working range ng ml ⁻¹
As	15	5-50
Cd	0.8	0.2-2
Co	10	3-30
Cr	3	2-20
Cu	10	3-30
Ni	13	5-50
Pb	15	5-50
V	35	10-100

**The characteristic mass (m_0) of an element is the mass in pg corresponding to a signal of 0.00044 unity using peak area as integration*

2. **PRINCIPLE:**

An aliquot of sample solution (5-50 μL) is introduced into a graphite tube of the GF AAS and atomized by rapid heating at high temperature. A light beam is directed through the graphite tube, into a monochromator, and onto a detector that measures the amount of light absorbed by the atomized element in the tube. Each metal has its own characteristic wavelength therefore a source hollow cathode lamp composed of that element is used. The amount of energy absorbed at the characteristic wavelength is proportional to the concentration of the element in the sample.

3. **SAMPLE PRE-TREATMENT:**

Samples are prepared following the recommended method for microwave digestion of marine samples for determination of trace element content. (IAEA recommended method, 2011)

4. **REAGENTS:**

4.1. Water: Reagent water (referenced also as water in the text) should be free of contamination

4.2. Concentrated acid solution as used for sample preparation (section 3)

4.3. Commercial standard solution $1000\mu\text{g ml}^{-1}$: Use certified reference material solution; this solution should be accompanied by a certificate that should include at least the traceability of the certified concentration as well as the expiration date. The density of the solution or the certified content in mg kg^{-1} should also be defined to allow preparation of calibration solution by weighing.

4.4. Calibration solutions: Prepare calibration solutions from the standard solutions (4.3) by appropriate dilution. Intermediate standard solutions should be prepared in 2% (v/v) nitric acid. For calibration solution use the same amount of acid as that of the samples solutions.

Calibration solutions below 1 mg/l should not be used for more than one month, and those below 100 $\mu\text{g/l}$ should not be used for more than one day.

4.5. Blank calibration solution: Prepare a blank calibration solution in the same way as the calibration solution but without adding standard. The final amount of acid will be the same as that of the sample solutions.

4.6. Palladium nitrate/magnesium nitrate modifier

Pd(NO₃)₂ solution is commercially available (10 g/l). Dissolve 0,259 g of Mg(NO₃)₂·6H₂O in 100 ml of water. Mix the palladium nitrate solution with twice as much magnesium nitrate solution. 10 µl of the mixed solution is equal to 15 µg Pd and 10 µg Mg(NO₃)₂. The mixture is also commercially available.

Prepare a fresh solution monthly.

4.7. Magnesium nitrate modifier

Dissolve 0,865 g of Mg(NO₃)₂·6H₂O in 100 ml of water. 10 µl of this solution is equal to 50 µg Mg(NO₃)₂.

4.8. Ammonium dihydrogen phosphate modifier

Dissolve 2,0 g of NH₄H₂PO₄ in 100 ml of water. 10 µl of this solution is equal to 200 µg NH₄H₂PO₄.

4.9. Ammonium dihydrogen phosphate/magnesium nitrate modifier

Dissolve 2,0 g of NH₄H₂PO₄ and 0,173 g of Mg(NO₃)₂·6H₂O in 100 ml of water. 10 µl of this solution is equal to 200 µg NH₄H₂PO₄ and 10 µg Mg(NO₃)₂.

4.10. Palladium/Ammonium dihydrogen phosphate/magnesium nitrate modifier

Mix 2ml of Pd(NO₃)₂ solution is commercially available (10 g/l), 2ml of Mg(NO₃)₂ solution prepared as (4.7), 0.5ml of NH₄H₂PO₄ prepared as (4.8) and dilute with water to 10ml. 4µl of this solution is equal to 8µg of Pd, 4µg of Mg(NO₃)₂ and 4µg of NH₄H₂PO₄.

4.11. Nickel modifier

Dissolve 0,200 g of nickel powder in 1 ml concentrated nitric acid and dilute to 100 ml with water. 10 µl of this solution is equal to 20 µg Ni. Solutions of Ni(NO₃)₂ are also commercially available.

4.12. Iridium solution 1000µg ml⁻¹

Use commercial solution (standard)

4.13. Argon

5. MATERIALS:

5.1. Glassware: All glassware, polypropylene, or fluorocarbon (PFA or TFM) containers, including sample bottles, flasks and pipettes tips, should be washed in the following sequence -- 24h soaking in laboratory soap (or 10% alcohol) followed by 24h soaking in 10% nitric acid, followed by 10% soaking in water, final rinsing in water, drying under laminar flow hood. Cleaned items should be kept in double sealed plastic bags

5.2. Pipettes: microliter pipettes size ranging from 50 to 10000 μ l as needed. The accuracy and precision of the pipettes used should be checked as a routine every 6 months and the obtained results should be compared with the individual certificates.

5.3. Volumetric containers preferably in polypropylene of suitable precision and accuracy

5.4. Atomic Absorption Spectrometer equipped with graphite furnace, background correction system and necessary hollow cathode lamp.

5.5. Auto sampler

5.6. Polypropylene cups for automatic sampler cleaned as explained in (5.1)

5.7. Graphite tubes: pyrolytically-coated with platforms, preferably for highly and medium volatile elements, whereas elements of low volatility should be atomized from the wall. Provided satisfactory results are achieved, manufacturer's recommendations regarding the use of graphite tubes and platforms should be followed.

6. INTERFERENCES:

Some sample solutions, may contain large amounts of substances that may affect the results. High concentrations of chloride may cause low results, because the volatility of many elements is increased and analyte loss may occur during the pyrolysis step. Matrix effects may be overcome, partially or completely, by the optimization of the temperature program, the use of pyrolytically-coated tubes and platforms, the use of chemical modifiers, the standard addition technique and the use of background correction.

7. CHEMICAL MODIFICATION:

Chemical modifiers are used to overcome spectral and/or non-spectral interferences in a sample (matrix effects). In general, the aim of chemical modification is to allow a pyrolysis temperature that is high enough to remove the bulk of concomitants before the atomization step. In order to ascertain that the modification works, the spike procedures is performed with and without the addition of a chosen chemical modifier and recovery are compared

Spike experiment:

Spike solution: mix a fixe volume (V1) of sample solution, and a known volume (V2) of a standard solution of a known concentration (C_{standard})

Unspike solution: mix same fixe volume (V1) of sample solution, and same volume (V2) of reagent water

Measure concentration C (mg l⁻¹) in both solutions on the calibration curve, and calculate recovery as:

$$\text{Equation 1} \quad C_{\text{spike}} = \frac{C_{\text{standard}} \times V_2}{(V_1 + V_2)}$$

$$\text{Equation 2} \quad R = \frac{C_{\text{Spike Solution}} - C_{\text{Unspike solution}}}{C_{\text{spike}}} \times 100$$

To be valid concentrations of spike and unspike solutions should be in the linearity range of the calibration curve and Spike concentration (equation 1) should be in the range of 50-150% of the concentration of unspike solution. The recovery should be 100 ± 15%

In Table 2 some recommendations of chemical modifiers are given.

Other chemical modifiers may be used if they show consistent results. Graphite tube can also be pretreated with Iridium (Vasileva 2001) as following:

Inject 50µl of the solution and run the temperature program below

Step	Temperature (°C)	Ramp Time (s)	Hold Time (s)
1	100	5	30
2	1200	20	5
3	100	5	2
4	2500	2	10

Repeat this 3 times, the coating is stable for about 200 injections and can be repeated

If chemical modifiers are used, add them to test samples, sample blank solutions, calibration solutions, and blank calibration solutions. Preferably inject the modifier solution with the auto sampler directly into the atomizer after the sample is delivered.

Table 2 Recommended chemical modifiers

Element	Chemical modifier	Amount* µg
As	Pd + Mg(NO ₃) ₂ or NH ₄ H ₂ PO ₄	15+10 200
Cd	Pd + Mg(NO ₃) ₂ +NH ₄ H ₂ PO ₄ or Ir coating	8+4+4
Co	Pd + Mg(NO ₃) ₂	15+10
Cr	Mg(NO ₃) ₂	50
Cu	None	
Ni	Mg(NO ₃) ₂	50
Pb	Pd + Mg(NO ₃) ₂ +NH ₄ H ₂ PO ₄ or Ir coating	8+4+4
V	None	

*These amounts are only recommendation, significantly lower amounts may be required in some atomizers, see also recommendations from instrument manufacturers.

8. PROCEDURE

8.1. Switch on the instrument and perform the optimization according to the manufacturer's instructions. Install an appropriate graphite tube, and set up the auto sampler.

8.2. Program the graphite furnace and the auto sampler. Examples of temperature program are given in table 3.

Note: Method for specific element and matrix should be developed and all necessary information should be stored with at least:

- *Temperature program*
- *Matrix modifier*
- *Type of graphite tube*
- *Matrix effect*
- *Type of calibration curve*
- *Typical m_0 obtained with the program*
- *Linearity*

Table 3 Example of temperature program

Element	Cu	Cu	Cd	Cd	Pb	Pb	As	As	Cr	Cr
Sample type	Sediment	Biota	Sediment	Biota	Sediment	Biota	Sediment	Biota	Sediment	Biota
Wavelength(nm)	327.4	327.4	228.8	228.8	283.3	283.3	193.7	193.7	357.9	357.9
Graphite tube	Partition Tube	Partition Tube	platform	platform	platform	platform	platform	platform	Partition Tube	Partition Tube
Matrix Modifier	none	none	none	Pd,Mg, Amonium Phosphate	none	Pd,Mg ,Amonium Phosphate	Pd,Mg	Pd,Mg	none	none
Peak Measurement	area	area	area	area	area	area	area	area	area	area
M0(pg/0.0044 UA) on standard	13	13	1	1	16	16	15	15	2.5	2.5
Ashing T° (C°)	700	700	300	700	400	925	1400	1400	1100	1100
Atomisation T° (C°)	2300	2300	1800	1900	2100	2200	2600	2600	2600	2600
Remark							Number of Fire is critical	Standard Addition often required. Number of fire is critical	Use peak Height for lower concentration (peak shape)	Standard Addition often required. Use peak Height for lower concentration (peak shape)

8.3. Generality for measurements:

All measurements should be performed with at least duplicate injections of solutions; the relative standard deviation should be less than 5% for a signal above 0.01 unit of absorbance.

It is recommended to work in peak area.

Check the number of firing and change the graphite tube when appropriate, if graphite tube is changed during a run, the instrument needs to be recalibrated.

8.4. Run the calibration:

8.4.1. **Standard calibration technique:** Perform the calibration with a blank calibration solution (4.5) and 3 to 5 equidistant calibration solutions (4.4) for an appropriate concentration range.

To correct for the instrumental drift calibration should be performed every 10 samples (if possible the option of reslope using the middle standard point should be applied every 5 samples)

Calibration solutions can be prepared by the auto sampler from the highest standard solution, the minimum volume uptake should not be less than 4 μ l.

The blank calibration solution should be free of analyte, or below a well-documented maximum allowed calibration blank value (i.e. validation, control charts..).

It should be stressed that the linearity of the calibration curve is often limited. The calibration curve is automatically plot by instrument software, if linear regression is set checked that $r \leq 0.995$ or switch to second order equation.

8.4.2. **Standard addition method:** This technique involves preparing same aliquots of sample solution with increasing amount of analyte. As describe in section 7 for the spike experiment using an increasing concentration of standard (V1 and V2 should stay the same). The auto sampler can be prograded to perform standard addition. Determine the analyte concentration in the reagent blank solution the same way. Example of standard addition is given in figure 1. The concentration is obtained by dividing the absorbance of zero addition by the slope.

The standard addition should be performed for each type of matrix (i.e. a sediment sample solution cannot be measured with a standard addition curve done on a fish sample solution). For similar sample matrices (i.e. same fish species) the slope obtained with one sample can be used for other measurements respecting recalibration every 10 samples.

For standard addition to be valid the following limitation should be taken into consideration:

- The resulting calibration should be linear ($r \leq 0.995$), software calibration equation is a linear regression
- The additions should represent ideally 50, 100, 150 and 200% of the sample concentration
- The standard addition technic cannot be used to correct for spectral interferences, such as unspecific background absorption, and should not be used if interferences change the signal by a factor of more than three.

Figure 1 Standard addition example

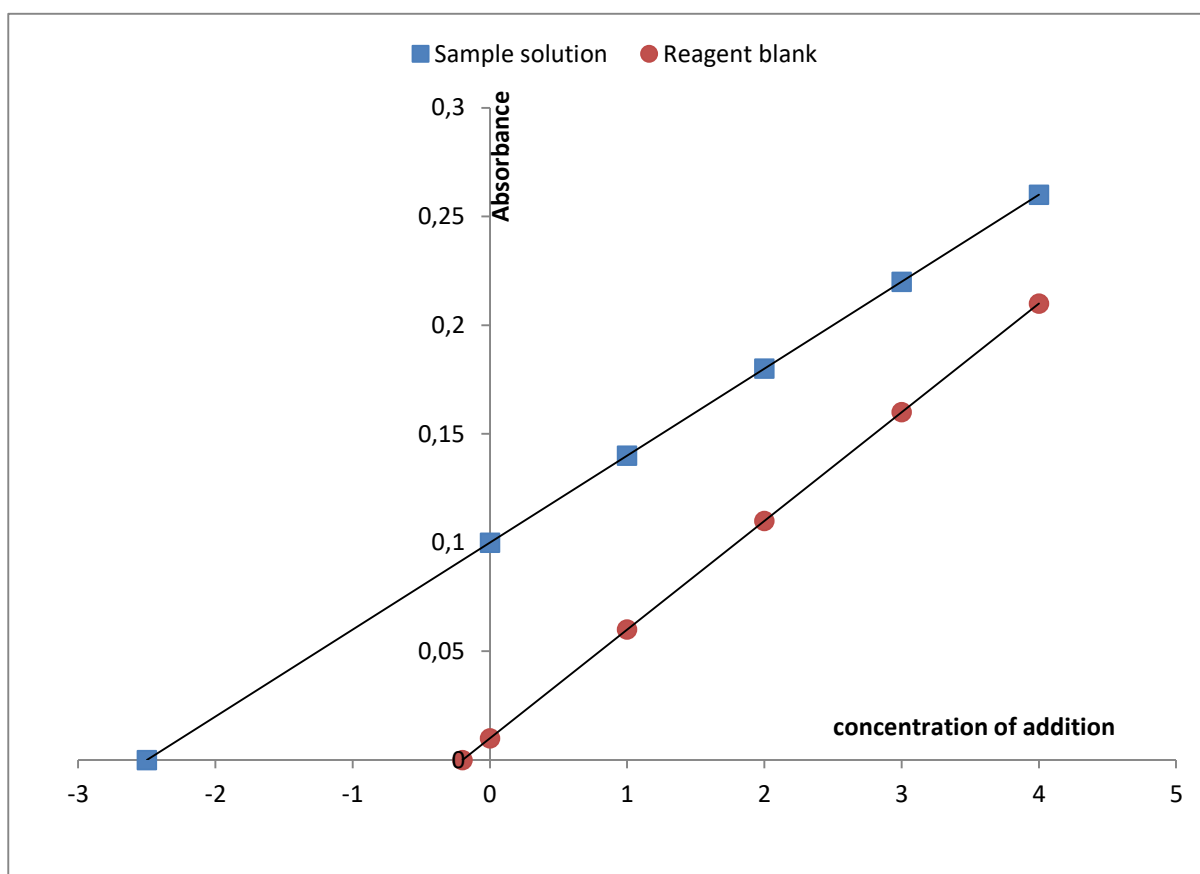

8.5. Measure sample blank and sample solutions (prepared following section 3) record the concentration as calculated by the software and calculate results following equation 3 (section 9), if samples exceed the highest point of calibration dilute appropriately. As an option a smaller volume of solution can be injected to stay under linear range of the instrument.

8.6. Quality control solutions: Quality control solutions as described below should be measured during the run. An example of a sequence order with recommended criteria and action is given in table 4.

Table 4 Example of analytical sequence:

Solutions Description	Performance	Action
Calibration blank	< maximum allowed calibration blank value	Stop until resolve
Standard solution 1 -4	$r > 0.995$	recalibrate in the linearity range
ICV	$\pm 10\%$ of true value	Stop until resolve
Sample blank	< maximum allowed blank value	
CRM	Fall in certificate value within coverage uncertainty, or fall within acceptable criteria of the QC chart	Stop until resolve, check Matrix spike and run again with standard addition method if necessary
Matrix Spike	recovery $100\% \pm 15\%$	switch to standard addition, keep record for future analyses of the same matrix
Dilution Test	sample 1 = 5x sample 1 diluted 5x within 10%	switch to standard addition, keep record for future analyses of the same matrix
Unknown Sample 1-10	should \geq standard 1 and \leq standard 4	report as <minimum quantification limit or dilute

ETC...(restart sequence from calibration blank)

8.6.1. Initial Calibration Verification ICV:

After the initial calibration, the calibration curve must be verified using the initial calibration verification (ICV) standard.

The ICV standard is a standard solution made from an independent (second source) material at or near midrange. This solution as calibration standard is prepared using the same type of acid or combination of acids and at the same concentration as will result in the test portion.

The acceptance criteria for the ICV standard must be $\pm 10\%$ of its true value

If the calibration curve cannot be verified within the specified limits, the cause must be determined and the instrument recalibrated before samples are analyzed.

The analysis data for the ICV must be kept on file with the sample analysis

The calibration curve must also be verified at the end of each analysis batch and/or after every 10 samples. If the calibration cannot be verified within the specified limits, the sample analysis must be discontinued, the cause determined and the instrument recalibrated. All samples following the last acceptable test must be reanalyzed.

8.6.2. **Blank solution (4.5):** Maximum allowed blank concentration should be well documented and if blank solution exceeds this value all samples prepared along the contaminated blank should be prepared again and re analyzed.

8.6.3. **Post digestion spike**

Each unknown type of sample should be spike to check for potential matrix effect.

This spike is consider as a single point standard addition, and should be performed with a minimum dilution factor. Recovery of spike calculated as equation 1 should be 85-115%. If this test failed it is recommended to run analyses with standard addition method. (see section 7 for detail)

8.6.4. **Dilution test:**

If the analyte concentration is sufficiently high (minimally, a factor of 10 above the lower limit of quantitation after dilution), an analysis of a 1:5 dilution should agree within $\pm 10\%$ of the original determination. If not, then a chemical or physical interference effect should be suspected, and method of standard addition is recommended.

8.6.5. **Certified reference material:**

At least one certified reference material of a representative matrix will be prepared with each batch of sample, the calculated result should be comparable with the value of the certificate within the coverage uncertainty.(Linsinger, 2010), to show evidence of unbiased result.

Results of CRM should be record for quality control purpose and plot in control chart (UNEP/IOC/IAEA 1994)

9. CALCULATION OF RESULTS:

Results are calculated with equation 3

$$\text{Equation 3: } w(m) = \frac{(\rho_1 - \rho_0)}{m} \times f \times V \times R$$

w(m) mass fraction of element m in the sample in mg kg⁻¹

ρ1: concentration of element m in milligrams per liter as measured in the sample solution

ρ0: concentration of element m in milligrams per liter as measured in the blank solution

f: is the dilution factor calculated as

$$f = \frac{\text{final volume}}{\text{initial volume}}$$

or equal to 1 if ρ1 is determined in undiluted solution

R: recovery calculated using CRM (see 8.6.5) or pre digestion spike

10. EXPRESSION OF RESULTS:

The rounding of values will depend of the uncertainty reported with the result. Uncertainty component should be reported with all results. (ISO 1995, Nordtest 2004)

Example : w(Pb) = 8.5 ± 1.2 mg kg⁻¹

11. REFERENCES:

EPA (2007) U.S. Environmental Protection Agency, EPA method 7010: Graphite furnace Atomic Absorption Spectrophotometry, Rev 0, February 2007, (<http://www.epa.gov/osw/hazard/testmethods/sw846/pdfs/7010.pdf>)

IAEA (2011) IAEA Recommended method for microwave digestion of marines samples for the determination of trace element content, 2011, *in preparation*, available upon request

ISO (1995) Guide to the expression of uncertainty of measurements International Organisation for Standardization: Geneva

ISO (1998) International Standard Organisation 11047:1998 Soil quality- determination of Cadmium, chromium, copper, lead, manganese, nickel and zinc in aqua regia extracts of soil-flame and electrothermal atomic absorption spectrometric methods, ISO geneva

Linsinger, T. (2010), European Commission - Joint Research Centre, Institute for Reference Materials and Measurements (http://www.erm-crm.org/ERM_products/application_notes/application_note_1/Documents/erm_application_note_1_english_rev3.pdf)

Nordtest (2004) Handbook For Calculation Of Measurement Uncertainty In Environmental Laboratories Edition 2 <http://www.nordicinnovation.net/nordtestfiler/tec537.pdf>)

UNEP/IOC/IAEA (1994) reference method 57: Quality assurance and good laboratory practice, UNEP, 1994

Vasileva. E, Baeten. H, Hoenig. M (2001), Advantages of the iridium permanent modifier in fast programs applied to trace-element analysis of plant samples by electrothermal atomic absorption spectrometry, Fresenius J Anal Chem (2001) 369 :491–495

Annex IV:

**Method 1640: Determination of Trace Elements in Ambient Waters by on-Line Chelation
Preconcentration and Inductively Coupled Plasma-Mass Spectrometry**



Method 1640: Determination of Trace Elements in Ambient Waters by On-Line Chelation Preconcentration and Inductively Coupled Plasma-Mass Spectrometry

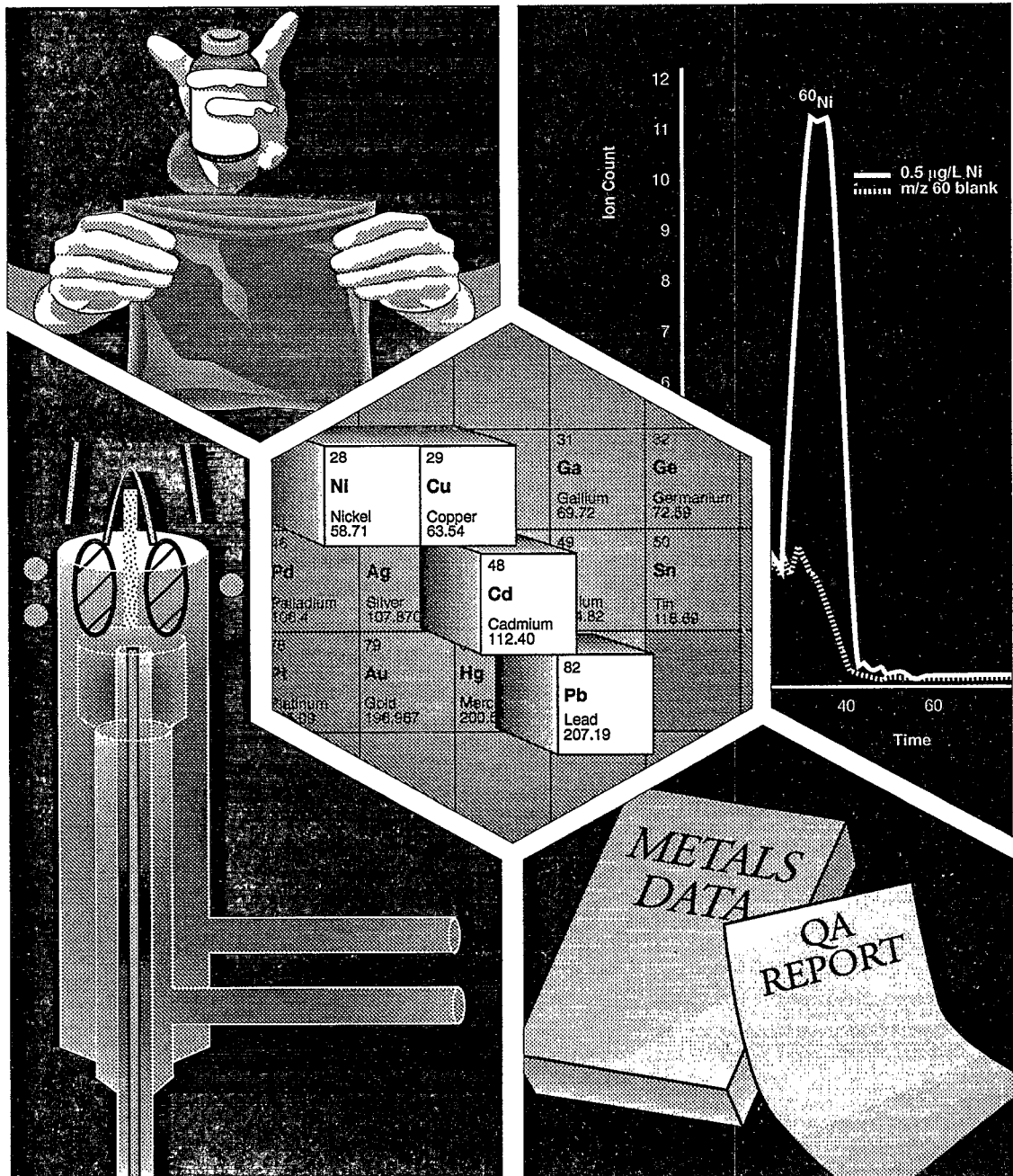



Method 1640: Determination of Trace Elements in Ambient Waters by On-Line Chelation Preconcentration and Inductively Coupled Plasma-Mass Spectrometry

Acknowledgments

Method 1640 was prepared under the direction of William A. Telliard of the U.S. Environmental Protection Agency's (EPA's) Office of Water (OW), Engineering and Analysis Division (EAD). The method was prepared under EPA Contract 68-C3-0337 by the DynCorp Environmental Programs Division with assistance from Interface, Inc.

The following researchers contributed to the philosophy behind this method. Their contribution is gratefully acknowledged:

Shier Berman, National Research Council, Ottawa, Ontario, Canada
Nicholas Bloom, Frontier Geosciences Inc, Seattle, Washington
Paul Boothe and Gary Steinmetz, Texas A&M University, College Station, Texas
Eric Crecelius, Battelle Marine Sciences Laboratory, Sequim, Washington
Russell Flegal, University of California/Santa Cruz, California
Gary Gill, Texas A&M University at Galveston, Texas
Carlton Hunt and Dion Lewis, Battelle Ocean Sciences, Duxbury, Massachusetts
Carl Watras, Wisconsin Department of Natural Resources, Boulder Junction, Wisconsin
Herb Windom and Ralph Smith, Skidaway Institute of Oceanography, Savannah, Georgia

In addition, the following personnel at the EPA Office of Research and Development's Environmental Monitoring Systems Laboratory in Cincinnati, Ohio, are gratefully acknowledged for the development of the analytical procedures described in this method:

J.T. Creed
T.D. Martin
S.E. Long (DynCorp, formerly Technology Applications, Inc.)

Disclaimer

This method has been reviewed and approved for publication by the Engineering and Analysis Division of the U.S. Environmental Protection Agency. Mention of trade names or commercial products does not constitute endorsement or recommendation for use.

Questions concerning this method or its application should be addressed to:

W.A. Telliard
USEPA Office of Water
Analytical Methods Staff
Mail Code 4303
401 M Street, SW
Washington, DC 20460
Phone: 202/260-7120
Fax: 202/260-7185

Introduction

This analytical method was designed to support water quality monitoring programs authorized under the Clean Water Act. Section 304(a) of the Clean Water Act requires EPA to publish water quality criteria that reflect the latest scientific knowledge concerning the physical fate (e.g., concentration and dispersal) of pollutants, the effects of pollutants on ecological and human health, and the effect of pollutants on biological community diversity, productivity, and stability.

Section 303 of the Clean Water Act requires states to set a water quality standard for each body of water within its boundaries. A state water quality standard consists of a designated use or uses of a waterbody or a segment of a waterbody, the water quality criteria that are necessary to protect the designated use or uses, and an antidegradation policy. These water quality standards serve two purposes: (1) they establish the water quality goals for a specific waterbody, and (2) they are the basis for establishing water quality-based treatment controls and strategies beyond the technology-based controls required by Sections 301(b) and 306 of the Clean Water Act.

In defining water quality standards, the state may use narrative criteria, numeric criteria, or both. However, the 1987 amendments to the Clean Water Act required states to adopt numeric criteria for toxic pollutants (designated in Section 307(a) of the Act) based on EPA Section 304(a) criteria or other scientific data, when the discharge or presence of those toxic pollutants could reasonably be expected to interfere with designated uses.

In some cases, these water quality criteria are as much as 280 times lower than those that can be achieved using existing EPA methods and required to support technology-based permits. Therefore, EPA developed new sampling and analysis methods to specifically address state needs for measuring toxic metals at water quality criteria levels, when such measurements are necessary to protect designated uses in state water quality standards. The latest criteria published by EPA are those listed in the National Toxics Rule (57 *FR* 60848). This rule includes water quality criteria for 13 metals, and it is these criteria on which the new sampling and analysis methods are based. Method 1640 was specifically developed to provide reliable measurements of four of these metals at EPA WQC levels using on-line chelation preconcentration and inductively coupled plasma-mass spectrometry techniques.

In developing these methods, EPA found that one of the greatest difficulties in measuring pollutants at these levels was precluding sample contamination during collection, transport, and analysis. The degree of difficulty, however, is highly dependent on the metal and site-specific conditions. This analytical method, therefore, is designed to provide the level of protection necessary to preclude contamination in nearly all situations. It is also designed to provide the procedures necessary to produce reliable results at the lowest possible water quality criteria published by EPA. In recognition of the variety of situations to which this method may be applied, and in recognition of continuing technological advances, the method is performance-based. Alternative procedures may be used, so long as those procedures are demonstrated to yield reliable results.

Requests for additional copies should be directed to:

U.S. EPA NCEPI
11029 Kenwood Road
Cincinnati, OH 45242
513/489-8190

Note: This method is intended to be performance based, and the laboratory is permitted to omit any step or modify any procedure provided that *all* performance requirements set forth in this method are met. The laboratory is *not* allowed to omit any quality control analyses. The terms "must," "may," and "should" are included throughout this method and are intended to illustrate the importance of the procedures in producing verifiable data at water quality criteria levels. The term "must" is used to indicate that researchers in trace metals analysis have found certain procedures essential in successfully analyzing samples and avoiding contamination; however, these procedures can be modified or omitted if the laboratory can show that data quality is not affected.

Method 1640

Determination of Trace Elements in Ambient Waters by On-Line Chelation Preconcentration and Inductively Coupled Plasma-Mass Spectrometry

1.0 Scope and Application

- 1.1 This method is for the determination of dissolved elements in ambient waters at EPA water quality criteria (WQC) levels using on-line chelation preconcentration and inductively coupled plasma-mass spectrometry (ICP-MS). It may also be used for determination of total recoverable element concentrations in these waters. This method was developed by integrating the analytical procedures contained in EPA Method 200.10 with the quality control (QC) and sample handling procedures necessary to avoid contamination and ensure the validity of analytical results during sampling and analysis for metals at EPA WQC levels. This method contains QC procedures that will assure that contamination will be detected when blanks accompanying samples are analyzed. This method is accompanied by Method 1669: *Sampling Ambient Water for Determination of Trace Metals at EPA Water Quality Criteria Levels* (the "Sampling Method"). The Sampling Method is necessary to ensure that contamination will not compromise trace metals determinations during the sampling process.
- 1.2 This method is applicable to the following elements:

<i>Analyte</i>	<i>Symbol</i>	<i>Chemical Abstract Services Registry Number (CASRN)</i>
Cadmium	(Cd)	7440-43-9
Copper	(Cu)	7440-50-8
Lead	(Pb)	7439-92-1
Nickel	(Ni)	7440-02-0

Table 1 lists the EPA WQC levels, the method detection limit (MDL) for each metal, and the minimum level (ML) for each metal in this method. Linear working ranges will be dependent on the instrumentation and selected operating conditions but should be essentially independent of the matrix because elimination of the matrix is a feature of the method.

- 1.3 This method is not intended for determination of metals at concentrations normally found in treated and untreated discharges from industrial facilities. Existing regulations (40 CFR Parts 400-500) typically limit concentrations in industrial discharges to the mid to high part-per-billion (ppb) range, whereas ambient metals concentrations are normally in the low part-per-trillion (ppt) to low ppb range.

- 1.4 The ease of contaminating ambient water samples with the metal(s) of interest and interfering substances cannot be overemphasized. This method includes suggestions for improvements in facilities and analytical techniques that should maximize the ability of the laboratory to make reliable trace metals determinations and minimize contamination. These suggestions are given in Section 4.0 and are based on findings of researchers performing trace metals analyses (References 1-8). Additional suggestions for improvement of existing facilities may be found in EPA's *Guidance for Establishing Trace Metals Clean Rooms in Existing Facilities*, which is available from the National Center for Environmental Publications and Information (NCEPI) at the address listed in the introduction to this document.
- 1.5 Clean and ultraclean—The terms "clean" and "ultraclean" have been applied to the techniques needed to reduce or eliminate contamination in trace metals determinations. These terms are not used in this method because they lack an exact definition. However, the information provided in this method is consistent with the summary guidance on clean and ultraclean techniques (Reference 9).
- 1.6 This method follows the EPA Environmental Methods Management Council's "Format for Method Documentation" (Reference 10).
- 1.7 This method is "performance based"; i.e., an alternate procedure or technique may be used, as long as the performance requirements in the method are met. Section 9.1.2 gives details of the tests and documentation required to support and document equivalent performance.
- 1.8 For dissolved metal determinations, samples must be filtered through a 0.45- μ m capsule filter at the field site. The Sampling Method describes the filtering procedures. The filtered samples may be preserved in the field or transported to the laboratory for preservation. Procedures for field preservation are detailed in the Sampling Method; provides procedures for laboratory preservation are provided in this method.
- 1.9 Acid solubilization is required before the determination of total recoverable elements to aid breakdown of complexes or colloids that might influence trace element recoveries.
- 1.10 This method should be used by analysts experienced in the use of inductively coupled plasma mass spectrometry (ICP-MS), including the interpretation of spectral and matrix interferences and procedures for their correction; and should be used only by personnel thoroughly trained in the handling and analysis of samples for determination of metals at EPA WQC levels. A minimum of six months' experience with commercial instrumentation is recommended.
- 1.11 This method is accompanied by a data verification and validation guidance document, *Guidance on the Documentation and Evaluation of Trace Metals Data Collected for CWA Compliance Monitoring*. Before using this method, data users should state the data quality objectives (DQOs) required for a project.

2.0 Summary of Method

- 2.1 This method is used to preconcentrate trace elements using an iminodiacetate functionalized chelating resin (References 11-12). Following acid solubilization, the sample is buffered prior to the chelating column using an on-line system. Group I and II metals, as well as most

anions, are selectively separated from the analytes by elution with ammonium acetate at pH 5.5. The analytes are subsequently eluted into a simplified matrix consisting of dilute nitric acid and are determined by ICP-MS using a directly coupled on-line configuration.

- 2.2 The determinative step in this method is ICP-MS (Reference 13-15). Sample material in solution is introduced by pneumatic nebulization into a radiofrequency plasma where energy transfer processes cause desolvation, atomization, and ionization. The ions are extracted from the plasma through a differentially pumped vacuum interface and separated on the basis of their mass-to-charge (m/z) ratio by a mass spectrometer having a minimum resolution capability of 1 amu peak width at 5% peak height at m/z 300. An electron multiplier or Faraday detector detects ions transmitted through the mass analyzer, and a data handling system processes the resulting current. Interferences relating to the technique (Section 4) must be recognized and corrected. Such corrections must include compensation for isobaric elemental interferences and interferences from polyatomic ions derived from the plasma gas, reagents, or sample matrix. Instrumental drift must be corrected for by the use of internal standardization.

3.0 Definitions

- 3.1 Apparatus—Throughout this method, the sample containers, sampling devices, instrumentation, and all other materials and devices used in sample collection, sample processing, and sample analysis activities will be referred to collectively as the Apparatus.
- 3.2 Other definitions of terms are given in the glossary (Section 18) at the end of this method.

4.0 Contamination and Interferences

- 4.1 Preventing ambient water samples from becoming contaminated during the sampling and analytical process constitutes one of the greatest difficulties encountered in trace metals determinations. Over the last two decades, marine chemists have come to recognize that much of the historical data on the concentrations of dissolved trace metals in seawater are erroneously high because the concentrations reflect contamination from sampling and analysis rather than ambient levels. More recently, historical trace metals data collected from freshwater rivers and streams have been shown to be similarly biased because of contamination during sampling and analysis (Reference 16). Therefore, it is imperative that extreme care be taken to avoid contamination when collecting and analyzing ambient water samples for trace metals.
- 4.2 There are numerous routes by which samples may become contaminated. Potential sources of trace metals contamination during sampling include metallic or metal-containing labware (e.g., talc gloves that contain high levels of zinc), containers, sampling equipment, reagents, and reagent water; improperly cleaned and stored equipment, labware, and reagents; and atmospheric inputs such as dirt and dust. Even human contact can be a source of trace metals contamination. For example, it has been demonstrated that dental work (e.g., mercury amalgam fillings) in the mouths of laboratory personnel can contaminate samples that are directly exposed to exhalation (Reference 3).

4.3 Contamination Control

- 4.3.1 **Philosophy**—The philosophy behind contamination control is to ensure that any object or substance that contacts the sample is metal free and free from any material that may contain metals.
- 4.3.1.1 The integrity of the results produced cannot be compromised by contamination of samples. Requirements and suggestions for control of sample contamination are given in this method and the Sampling Method.
- 4.3.1.2 Substances in a sample cannot be allowed to contaminate the laboratory work area or instrumentation used for trace metals measurements. Requirements and suggestions for protecting the laboratory are given in this method.
- 4.3.1.3 Although contamination control is essential, personnel health and safety remain the highest priority. Requirements and suggestions for personnel safety are given in Section 5 of this method and the Sampling Method.
- 4.3.2 **Avoiding contamination**—The best way to control contamination is to completely avoid exposure of the sample to contamination in the first place. Avoiding exposure means performing operations in an area known to be free from contamination. Two of the most important factors in avoiding/reducing sample contamination are (1) an awareness of potential sources of contamination and (2) strict attention to work being done. Therefore it is imperative that the procedures described in this method be carried out by well-trained, experienced personnel.
- 4.3.3 **Use a clean environment**—The ideal environment for processing samples is a class 100 clean room (Section 6.1.1). If a clean room is not available, all sample preparation should be performed in a class 100 clean bench or a nonmetal glove box fed by particle-free air or nitrogen. Digestions should be performed in a nonmetal fume hood situated, ideally, in the clean room.
- 4.3.4 **Minimize exposure**—The Apparatus that will contact samples, blanks, or standard solutions should be opened or exposed only in a clean room, clean bench, or glove box so that exposure to an uncontrolled atmosphere is minimized. When not being used, the Apparatus should be covered with clean plastic wrap, stored in the clean bench or in a plastic box or glove box, or bagged in clean zip-type bags. Minimizing the time between cleaning and use will also minimize contamination.
- 4.3.5 **Clean work surfaces**—Before a given batch of samples is processed, all work surfaces in the hood, clean bench, or glove box in which the samples will be processed should be cleaned by wiping with a lint-free cloth or wipe soaked with reagent water.
- 4.3.6 **Wear gloves**—Sampling personnel must wear clean, nontalc gloves (Section 6.10.7) during all operations involving handling of the Apparatus, samples, and blanks. Only clean gloves may touch the Apparatus. If another object or substance is touched, the glove(s) must be changed before again handling the Apparatus. If it is even suspected that gloves have become contaminated, work must be halted, the contaminated gloves removed, and a new pair of clean gloves put on. Wearing multiple layers of clean

gloves will allow the old pair to be quickly stripped with minimal disruption to the work activity.

- 4.3.7 Use metal-free Apparatus—All Apparatus used for determination of metals at ambient water quality criteria levels must be nonmetallic, free of material that may contain metals, or both.
- 4.3.7.1 Construction materials—Only the following materials should come in contact with samples: fluoropolymer (FEP, PTFE), conventional or linear polyethylene, polycarbonate, polypropylene, polysulfone, or ultrapure quartz. PTFE is less desirable than FEP because the sintered material in PTFE may contain contaminants and is susceptible to serious memory contamination (Reference 6). Fluoropolymer or glass containers should be used for samples that will be analyzed for mercury because mercury vapors can diffuse in or out of the other materials resulting either in contamination or low-biased results (Reference 3). All materials, regardless of construction, that will directly or indirectly contact the sample must be cleaned using the procedures described in Section 11 and must be known to be clean and metal-free before proceeding.
- 4.3.7.2 The following materials have been found to contain trace metals and should not contact the sample or be used to hold liquids that contact the sample, *unless* these materials have been shown to be free of the metals of interest at the desired level: Pyrex, Kimax, methacrylate, polyvinylchloride, nylon, and Vycor (Reference 6). In addition, highly colored plastics, paper cap liners, pigments used to mark increments on plastics, and rubber all contain trace levels of metals and must be avoided (Reference 17).
- 4.3.7.3 Serialization—It is recommended that serial numbers be indelibly marked or etched on each piece of Apparatus so that contamination can be traced, and logbooks should be maintained to track the sample from the container through the labware to injection into the instrument. It may be useful to dedicate separate sets of labware to different sample types; e.g., receiving waters vs. effluents. However, the Apparatus used for processing blanks and standards must be mixed with the Apparatus used to process samples so that contamination of all labware can be detected.
- 4.3.7.4 The laboratory or cleaning facility is responsible for cleaning the Apparatus used by the sampling team. If there are any indications that the Apparatus is not clean when received by the sampling team (e.g., ripped storage bags), an assessment of the likelihood of contamination must be made. Sampling must not proceed if it is possible that the Apparatus is contaminated. If the Apparatus is contaminated, it must be returned to the laboratory or cleaning facility for proper cleaning before any sampling activity resumes.
- 4.3.8 Avoid Sources of Contamination—Avoid contamination by being aware of potential sources and routes of contamination.

- 4.3.8.1 Contamination by carryover—Contamination may occur when a sample containing low concentrations of metals is processed immediately after a sample containing relatively high concentrations of these metals. To reduce carryover, the sample introduction system may be rinsed between samples with dilute acid and reagent water. When an unusually concentrated sample is encountered, it is followed by analysis of a laboratory blank to check for carryover. For samples containing high levels of metals, it may be necessary to acid-clean or replace the connecting tubing or inlet system to ensure that contamination will not affect subsequent measurements. Samples known or suspected to contain the lowest concentration of metals should be analyzed first followed by samples containing higher levels. For instruments containing autosamplers, the laboratory should keep track of which station is used for a given sample. When an unusually high concentration of a metal is detected in a sample, the station used for that sample should be cleaned more thoroughly to prevent contamination of subsequent samples, and the results for subsequent samples should be checked for evidence of the metal(s) that occurred in high concentration.
- 4.3.8.2 Contamination by samples—Significant laboratory or instrument contamination may result when untreated effluents, in-process waters, landfill leachates, and other samples containing high concentrations of inorganic substances are processed and analyzed. As stated in Section 1.0, this method is not intended for application to these samples, and samples containing high concentrations should not be permitted into the clean room and laboratory dedicated for processing trace metals samples.
- 4.3.8.3 Contamination by indirect contact—Apparatus that may not directly come in contact with the samples may still be a source of contamination. For example, clean tubing placed in a dirty plastic bag may pick up contamination from the bag and then subsequently transfer the contamination to the sample. Therefore, it is imperative that every piece of the Apparatus that is directly or indirectly used in the collection, processing, and analysis of ambient water samples be cleaned as specified in Section 11.
- 4.3.8.4 Contamination by airborne particulate matter—Less obvious substances capable of contaminating samples include airborne particles. Samples may be contaminated by airborne dust, dirt, particles, or vapors from: unfiltered air supplies; nearby corroded or rusted pipes, wires, or other fixtures; or metal-containing paint. Whenever possible, sample processing and analysis should occur as far as possible from sources of airborne contamination.
- 4.4 Interferences—Interference sources that may cause inaccuracies in the determination of trace elements by ICP-MS are given below and must be recognized and corrected for. Internal standards should be used to correct for instrumental drift as well as suppressions or enhancements of instrument response caused by the sample matrix.
- 4.4.1 Isobaric elemental interferences—Are caused by isotopes of different elements that form singly or doubly charged ions of the same nominal m/z and that cannot be resolved by the mass spectrometer. All elements determined by this method have, at a

minimum, one isotope free of isobaric elemental interferences. If an alternative isotope that has a higher natural abundance is selected to achieve greater sensitivity, an isobaric interference may occur. All data obtained under such conditions must be corrected by measuring the signal from another isotope of the interfering element and subtracting the contribution the isotope of interest based on the relative abundance of the alternate isotope and isotope of interest. A record of this correction process should be included with the report of the data. It should be noted that such corrections will only be as accurate as the accuracy of the relative abundance used in the equation for data calculations. Relative abundances should be established before any corrections are applied.

- 4.4.2 Abundance sensitivity—Is a property defining the degree to which the wings of a mass peak contribute to adjacent m/z 's. Ion energy and quadrupole operating pressure affect the abundance sensitivity. Wing overlap interferences may result when a small m/z peak is being measured adjacent to a large one. The potential for these interferences should be recognized and the spectrometer resolution adjusted to minimize them.
- 4.4.3 Isobaric polyatomic ion interferences—Are caused by ions consisting of more than one atom which have the same nominal m/z as the isotope of interest, and which cannot be resolved by the mass spectrometer in use. These ions are commonly formed in the plasma or interface system from support gases or sample components. Such interferences must be recognized, and when they cannot be avoided by selecting alternative analytical isotopes, appropriate corrections must be made to the data. Equations for the correction of data should be established at the time of the analytical run sequence because the polyatomic ion interferences will be highly dependent on the sample matrix and chosen instrument conditions.
- 4.4.4 Physical interferences—Are associated with the physical processes that govern the transport of sample into the plasma, sample conversion processes in the plasma, and the transmission of ions through the plasma-mass spectrometer interface. These interferences may result in differences between instrument responses for the sample and the calibration standards. Physical interferences may occur in the transfer of solution to the nebulizer (e.g., viscosity effects), at the point of aerosol formation and transport to the plasma (e.g., surface tension), or during excitation and ionization processes within the plasma itself. Internal standardization may be effectively used to compensate for many physical interference effects (Reference 18). Internal standards ideally should have similar analytical behavior to the elements being determined.
- 4.4.5 Memory interferences—Result when isotopes of elements in a previous sample contribute to the signals measured in a new sample. Memory effects can result from sample deposition on the sampler and skimmer cones, and from the buildup of sample material in the plasma torch and spray chamber. The site where these effects occur depends on the element and can be minimized by flushing the system with a rinse blank between samples (Section 7.6.3). The possibility of memory interferences should be recognized within an analytical run and suitable rinse times should be used to reduce them. The rinse times necessary for a particular element should be estimated before it is analyzed. This estimation may be achieved by aspirating a standard containing elements corresponding to ten times the upper end of the linear range for a normal sample analysis period, followed by analysis of the rinse blank at designated

intervals. The length of time required to reduce analyte signals below the ML should be noted. Memory interferences may also be assessed within an analytical run by using a minimum of three replicate integrations for data acquisition. If the integrated signal values drop consecutively, the analyst should be alerted to the possibility of a memory effect, and should examine the analyte concentration in the previous sample to identify if the memory effect was high. If a memory interference is suspected, the sample should be reanalyzed after a long rinse period.

- 4.4.6 A principal advantage of this method is the selective elimination of species giving rise to polyatomic spectral interferences on certain transition metals (e.g., removal of the chloride interference on vanadium). As most of the sample matrix is removed, matrix-induced physical interferences are also substantially reduced.
- 4.4.7 Low recoveries may be encountered in the preconcentration cycle if the trace elements are complexed by competing chelators in the sample or are present as colloidal material. Acid solubilization pretreatment is used to improve analyte recovery and to minimize adsorption, hydrolysis, and precipitation effects.

5.0 Safety

- 5.1 The toxicity or carcinogenicity of reagents used in this method have not been fully established. Each chemical should be regarded as a potential health hazard and exposure to these compounds should be as low as reasonably achievable.
- 5.1.1 Each laboratory is responsible for maintaining a current awareness file of OSHA regulations for the safe handling of the chemicals specified in this method (References 19–22). A reference file of material safety data sheets (MSDSs) should also be available to all personnel involved in the chemical analysis. It is also suggested that the laboratory perform personal hygiene monitoring of each analyst who uses this method and that the results of this monitoring be made available to the analyst. The references and bibliography at the end of Reference 22 are particularly comprehensive in dealing with the general subject of laboratory safety.
- 5.1.2 Concentrated nitric and hydrochloric acids present various hazards and are moderately toxic and extremely irritating to skin and mucous membranes. Use these reagents in a fume hood whenever possible and if eye or skin contact occurs, flush with large volumes of water. Always wear protective clothing and safety glasses or a shield for eye protection, and observe proper mixing when working with these reagents.
- 5.2 The acidification of samples containing reactive materials may result in the release of toxic gases such as cyanides or sulfides. Samples should be acidified in a fume hood.
- 5.3 All personnel handling environmental samples known to contain or to have been in contact with human waste should be immunized against known disease-causative agents.
- 5.4 Analytical plasma sources emit radiofrequency radiation in addition to intense UV radiation. Suitable precautions should be taken to protect personnel from such hazards. The inductively coupled plasma should only be viewed with proper eye protection from UV emissions.

6.0 Apparatus, Equipment, and Supplies

Disclaimer: The mention of trade names or commercial products in this method is for illustrative purposes only and does not constitute endorsement or recommendation for use by the Environmental Protection Agency. Equivalent performance may be achievable using apparatus and materials other than those suggested here. The laboratory is responsible for demonstrating equivalent performance.

6.1 Facility

6.1.1 Clean room—Class 100, 200-ft² minimum, with down-flow, positive-pressure ventilation, air-lock entrances, and pass-through doors.

6.1.1.1 Construction materials—Nonmetallic, preferably plastic sheeting attached without metal fasteners. If painted, paints that do not contain the metal(s) of interest should be used.

6.1.1.2 Adhesive mats—for use at entry points to control dust and dirt from shoes.

6.1.2 Fume hoods—nonmetallic, two minimum, with one installed internal to the clean room.

6.1.3 Clean benches—class 100, one installed in the clean room; the other adjacent to the analytical instrument(s) for preparation of samples and standards.

6.2 Preconcentration system—System containing no metal parts in the analyte flow path, configured as shown in Figure 1.

NOTE: *An alternate preconcentration system to the one described below may be used provided that all performance criteria listed in this method can be met. If low recoveries are encountered in the preconcentration cycle for a particular analyte, it may be necessary to use an alternate preconcentration system.*

6.2.1 Column—Macroporous iminodiacetate chelating resin (Dionex Metpac CC-1 or equivalent).

6.2.2 Sample loop—10-mL loop constructed from narrow-bore, high-pressure inert tubing, Tefzel ETFE (ethylene tetra-fluoroethylene) or equivalent.

6.2.3 Eluent pumping system (P1)—Programmable-flow, high-pressure pumping system, capable of delivering either one of two eluents at a pressure up to 2000 psi and a flow rate of 1–5 mL/min.

6.2.4 Auxiliary pumps

- 6.2.4.1 On-line buffer pump (P2)—Piston pump (Dionex QIC pump or equivalent) for delivering 2M ammonium acetate buffer solution.
 - 6.2.4.2 Carrier pump (P3)—Peristaltic pump (Gilson Minipuls or equivalent) for delivering 1% nitric acid carrier solution.
 - 6.2.4.3 Sample pump (P4)—Peristaltic pump for loading sample loop.
 - 6.2.5 Control valves—Inert, double-stack, pneumatically operated four-way slider valves with connectors.
 - 6.2.6 Argon gas supply regulated at 80–100 psi
 - 6.2.7 Solution reservoirs—Inert containers, e.g., high density polyethylene (HDPE), for holding eluent and carrier reagents.
 - 6.2.8 Tubing—High pressure, narrow bore, inert tubing (e.g., Tefzel ETFE or equivalent) for interconnection of pumps and valve assemblies and a minimum length for connection of the preconcentration system to the ICP-MS instrument.
- 6.3 Inductively coupled plasma mass spectrometer
- 6.3.1 Instrument capable of scanning the mass range 5–250 amu with a minimum resolution capability of 1-amu peak width at 5% peak height. Instrument may be fitted with a conventional or extended dynamic range detection system.
 - 6.3.2 Radio-frequency generator compliant with FCC regulations.
 - 6.3.3 Argon gas supply—High-purity grade (99.99%). When analyses are conducted frequently, liquid argon is more economical and requires less frequent replacement of tanks than compressed argon in conventional cylinders.
 - 6.3.4 A variable-speed peristaltic pump is required for solution delivery to the nebulizer.
 - 6.3.5 A mass-flow controller on the nebulizer gas supply is required. A water-cooled spray chamber may be of benefit in reducing some types of interferences (e.g., from polyatomic oxide species).
 - 6.3.6 If an electron multiplier detector is being used, precautions should be taken, where necessary, to prevent exposure to high ion flux. Otherwise changes in instrument response or damage to the multiplier may result. Samples having high concentrations of elements beyond the linear range of the instrument and with isotopes falling within scanning windows should be diluted before analysis.
- 6.4 Analytical balance—with capability to measure to 0.1 mg, for use in weighing solids and for preparing standards.
- 6.5 Temperature-adjustable hot plate—capable of maintaining a temperature of 95°C.

- 6.6 Centrifuge with guard bowl, electric timer, and brake (optional)
- 6.7 Drying oven—gravity convection, with thermostatic control capable of maintaining 105°C (\pm 5°C).
- 6.8 Alkaline detergent—Liquinox®, Alconox®, or equivalent.
- 6.9 pH meter or pH paper
- 6.10 Labware—For determination of trace levels of elements, contamination and loss are of prime consideration. Potential contamination sources include improperly cleaned laboratory apparatus and general contamination within the laboratory environment from dust, etc. A clean laboratory work area should be designated for handling trace element samples. Sample containers can introduce positive and negative errors in the determination of trace elements by (1) contributing contaminants through surface desorption or leaching, and (2) depleting element concentrations through adsorption processes. All labware must be metal free. Suitable construction materials are fluoropolymer (FEP, PTFE), conventional or linear polyethylene, polycarbonate, and polypropylene. Fluoropolymer should be used when samples are to be analyzed for mercury. All labware should be cleaned according to the procedure in Section 11.4. Gloves, plastic wrap, storage bags, and filters may all be used new without additional cleaning unless results of the equipment blank pinpoint any of these materials as a source of contamination. In this case, either an alternate supplier must be obtained or the materials must be cleaned.

NOTE: *Chromic acid must not be used for cleaning glassware.*

- 6.10.1 Volumetric flasks, graduated cylinders, funnels, and centrifuge tubes
- 6.10.2 Assorted calibrated pipets
- 6.10.3 Beakers—fluoropolymer (or other suitable material), 250-mL with fluoropolymer covers.
- 6.10.4 Storage bottles—Narrow-mouth, fluoropolymer with fluoropolymer screw closure, 125- to 250-mL capacities.
- 6.10.5 Wash bottle—One-piece stem fluoropolymer, with screw closure, 125-mL capacity.
- 6.10.6 Tongs—For removal of Apparatus from acid baths. Coated metal tongs may not be used.
- 6.10.7 Gloves—clean, nontalc polyethylene, latex, or vinyl; various lengths. Heavy gloves should be worn when working in acid baths since baths will contain hot, strong acids.
- 6.10.8 Buckets or basins—5- to 50-L capacity, for acid soaking of the Apparatus.
- 6.10.9 Brushes—Nonmetallic, for scrubbing Apparatus.

- 6.10.10 Storage bags—Clean, zip-type, nonvented, colorless polyethylene (various sizes) for storage of Apparatus.
- 6.10.11 Plastic wrap—Clean, colorless polyethylene for storage of Apparatus.
- 6.11 Sampling Equipment—The sampling team may contract with the laboratory or a cleaning facility that is responsible for cleaning, storing, and shipping all sampling devices, sample bottles, filtration equipment, and all other Apparatus used for the collection of ambient water samples. Before the equipment is shipped to the field site, the laboratory or facility must generate an acceptable equipment blank (Section 9.6.3) to demonstrate that the sampling equipment is free from contamination.
- 6.11.1 Sampling Devices—Before ambient water samples are collected, consideration should be given to the type of sample to be collected and the devices to be used (grab, surface, or subsurface samplers). The laboratory or cleaning facility must clean all devices used for sample collection. Various types of samplers are described in the Sampling Method. Cleaned sampling devices should be stored in polyethylene bags or wrap.
- 6.11.2 Sample bottles—Fluoropolymer, conventional or linear polyethylene, polycarbonate, or polypropylene; 500-mL with lids. Cleaned sample bottles should be filled with 0.1% HCl (v/v) until use.

NOTE: *If mercury is a target analyte, fluoropolymer or glass bottles must be used.*

6.11.3 Filtration Apparatus

- 6.11.3.1 Filter—Gelman Supor 0.45- μ m, 15-mm diameter capsule filter (Gelman 12175, or equivalent).
- 6.11.3.2 Peristaltic pump—115-V a.c., 12-V d.c., internal battery, variable speed, single-head (Cole-Parmer, portable, "Masterflex L/S," Catalog No. H-07570-10 drive with Quick Load pump head, Catalog No. H-07021-24, or equivalent).
- 6.11.3.3 Tubing for use with peristaltic pump—styrene/ethylene/butylene/silicone (SEBS) resin, approx 3/8-in i.d. by approximately 3 ft (Cole-Parmer size 18, Catalog No. G-06464-18, or approximately 1/4-in i.d., Cole-Parmer size 17, Catalog No. G-06464-17, or equivalent). Tubing is cleaned by soaking in 5–10% HCl solution for 8–24 h, rinsing with reagent water in a clean bench in a clean room, and drying in the clean bench by purging with metal-free air or nitrogen. After drying, the tubing is double-bagged in clear polyethylene bags, serialized with a unique number, and stored until use.

7.0 Reagents and Standards

Reagents may contain elemental impurities that might affect the integrity of analytical data. Because of the high sensitivity of ICP-MS, high-purity reagents should be used. Each reagent lot should be tested for the metals of interest by diluting and analyzing an aliquot from the lot using the techniques and instrumentation to be used for analysis of samples. The lot will be acceptable if the concentration of the metal of interest is below the MDL listed in this method. All acids used for this method must be ultra high-purity grade. Suitable acids are available from a number of manufacturers or may be prepared by sub-boiling distillation.

- 7.1 Reagents for cleaning Apparatus, sample bottle storage, and sample preservation and analysis
- 7.1.1 Nitric acid—concentrated (sp gr 1.41), Seastar or equivalent
 - 7.1.2 Nitric acid (1+1)—Add 500 mL concentrated nitric acid to 400 mL of reagent water and dilute to 1 L.
 - 7.1.3 Nitric acid (1+9)—Add 100 mL concentrated nitric acid to 400 mL of reagent water and dilute to 1 L.
 - 7.1.4 Nitric acid 1.25M—Dilute 79 mL (112 g) concentrated nitric acid to 1000 mL with reagent water.
 - 7.1.5 Nitric acid 1%—Dilute 10 mL concentrated nitric acid to 1000 mL with reagent water.
 - 7.1.6 Hydrochloric acid—concentrated (sp gr 1.19).
 - 7.1.7 Hydrochloric acid (1+1)—Add 500 mL concentrated hydrochloric acid to 400 mL of reagent water and dilute to 1 L.
 - 7.1.8 Hydrochloric acid (1+4)—Add 200 mL concentrated hydrochloric acid to 400 mL of reagent water and dilute to 1 L.
 - 7.1.9 Hydrochloric acid (HCl)—1N trace metal grade
 - 7.1.10 Hydrochloric acid (HCl)—10% wt, trace metal grade
 - 7.1.11 Hydrochloric acid (HCl)—1% wt, trace metal grade
 - 7.1.12 Hydrochloric acid (HCl)—0.5% (v/v), trace metal grade
 - 7.1.13 Hydrochloric acid (HCl)—0.1% (v/v) ultrapure grade
 - 7.1.14 Acetic acid, glacial (sp gr 1.05)
 - 7.1.15 Ammonium hydroxide (20%)

7.1.16 Ammonium acetate buffer 1M, pH 5.5—Add 58 mL (60.5 g) of glacial acetic acid to 600 mL of reagent water. Add 65 mL (60 g) of 20% ammonium hydroxide and mix. Check the pH of the resulting solution by withdrawing a small aliquot and testing with a calibrated pH meter, adjusting the solution to pH 5.5 (± 0.1) with small volumes of acetic acid or ammonium hydroxide as necessary. Cool and dilute to 1 L with reagent water.

7.1.17 Ammonium acetate buffer 2M, pH 5.5—Prepare as for Section 7.1.16 using 116 mL (121 g) glacial acetic acid and 130 mL (120 g) 20% ammonium hydroxide, diluted to 1000 mL with reagent water.

NOTE: *The ammonium acetate buffer solutions may be further purified by passing them through the chelating column at a flow rate of 5.0 mL/min. With reference to Figure 1, pump the buffer solution through the column using pump P1, with valves A and B off and valve C on. Collect the purified solution in a container at the waste outlet. Then elute the collected contaminants from the column using 1.25M nitric acid for 5 min at a flow rate of 4.0 mL/min.*

7.1.18 Oxalic acid dihydrate (CASRN 6153-56-6), 0.2M—Dissolve 25.2 g reagent grade $C_2H_2O_4 \cdot 2H_2O$ in 250 mL reagent water and dilute to 1000 mL with reagent water.

CAUTION: *Oxalic acid is toxic; handle with care.*

7.2 Reagent water—Water demonstrated to be free from the metal(s) of interest and potentially interfering substances at the MDL for that metal listed in Table 1. Prepared by distillation, deionization, reverse osmosis, anodic/cathodic stripping voltammetry, or other technique that removes the metal(s) and potential interferent(s).

7.3 Standard stock solutions—May be purchased from a reputable commercial source or prepared from ultra high-purity grade chemicals or metals (99.99–99.999% pure). All salts should be dried for 1 h at 105°C, unless otherwise specified.

CAUTION: *Many metal salts are extremely toxic if inhaled or swallowed. (Wash hands thoroughly after handling.) Stock solutions should be stored in plastic bottles.*

The following procedures may be used for preparing standard stock solutions:

NOTE: *Some metals, particularly those that form surface oxides, require cleaning before they are weighed. This may be achieved by pickling the surface of the metal in acid. An amount over the desired weight should be pickled repeatedly, rinsed with water, dried, and weighed until the desired weight is achieved.*

- 7.3.1 Bismuth solution, stock 1 mL = 1000 µg Bi—Dissolve 0.1115 g Bi₂O₃ in 5 mL concentrated nitric acid. Heat to effect solution. Cool and dilute to 100 mL with reagent water.
- 7.3.2 Cadmium solution, stock 1 mL = 1000 µg Cd: Pickle cadmium metal in (1+9) nitric acid to an exact weight of 0.100 g. Dissolve in 5 mL (1+1) nitric acid, heating to effect solution. Cool and dilute to 100 mL with reagent water.
- 7.3.3 Copper solution, stock 1 mL = 1000 µg Cu: Pickle copper metal in (1+9) nitric acid to an exact weight of 0.100 g. Dissolve in 5 mL (1+1) nitric acid, heating to effect solution. Cool and dilute to 100 mL with reagent water.
- 7.3.4 Indium solution, stock 1 mL = 1000 µg In: Pickle indium metal in (1+1) nitric acid to an exact weight of 0.100 g. Dissolve in 10 mL (1+1) nitric acid, heating to effect solution. Cool and dilute to 100 mL with reagent water.
- 7.3.5 Lead solution, stock 1 mL = 1000 µg Pb: Dissolve 0.1599 g PbNO₃ in 5 mL (1+1) nitric acid. Dilute to 100 mL with reagent water.
- 7.3.6 Nickel solution, stock 1 mL = 1000 µg Ni: Dissolve 0.100 g nickel powder in 5 mL concentrated nitric acid, heating to effect solution. Cool and dilute to 100 mL with reagent water.
- 7.3.7 Scandium solution, stock 1 mL = 1000 µg Sc: Dissolve 0.1534 g Sc₂O₃ in 5 mL (1+1) nitric acid, heating to effect solution. Cool and dilute to 100 mL with reagent water.
- 7.3.8 Terbium solution, stock 1 mL = 1000 µg Tb: Dissolve 0.1176 g Tb₄O₇ in 5 mL concentrated nitric acid, heating to effect solution. Cool and dilute to 100 mL with reagent water.
- 7.3.9 Yttrium solution, stock 1 mL = 1000 µg Y—Dissolve 0.1270 g Y₂O₃ in 5 mL (1+1) nitric acid, heating to effect solution. Cool and dilute to 100 mL with reagent water.
- 7.4 Multielement stock standard solution—When multielement stock standards are prepared, care must be taken that the elements are compatible and stable. Originating element stocks should be checked for the presence of impurities that might influence the accuracy of the standard. Freshly prepared standards should be transferred to acid-cleaned, new FEP or HDPE bottles for storage and monitored periodically for stability. A multielement stock standard solution containing cadmium, copper, lead, and nickel (1 mL = 10 µg) may be prepared by diluting 1 mL of each single element stock in the list to 100 mL with reagent water containing 1% (v/v) nitric acid.
- 7.4.1 Preparation of calibration standards—Fresh multielement calibration standards should be prepared every 2 weeks or as needed. Dilute the stock multielement standard solution to levels appropriate to the operating range of the instrument using reagent water containing 1% (v/v) nitric acid. Calibration standards should be prepared at a minimum of three concentrations, one of which must be at the ML (Table 1), and another that must be near the upper end of the linear dynamic range. If the direct addition procedure is being used (Method A, Section 10.3), add internal standards

(Section 7.5) to the calibration standards and store in fluoropolymer bottles. Calibration standards should be verified initially using a quality control sample (Section 7.8).

- 7.5 Internal standard stock solution—1 mL = 100 µg. Dilute 10 mL of scandium, yttrium, indium, terbium and bismuth stock standards (Section 7.3) to 100 mL with reagent water, and store in a FEP bottle. Use this solution concentrate for addition to blanks, calibration standards and samples, or dilute by an appropriate amount using 1% (v/v) nitric acid, if the internal standards are being added by peristaltic pump (Method B, Section 10.3).

NOTE: *Bismuth should not be used as an internal standard using the direct addition method (Method A, Section 10.3) because it is not efficiently concentrated on the iminodiacetate column.*

- 7.6 Blanks—The laboratory should prepare the following types of blanks. A calibration blank is used to establish the analytical calibration curve; the laboratory (method) blank is used to assess possible contamination from the sample preparation procedure and to assess spectral background; and the rinse blank is used to flush the instrument between samples in order to reduce memory interferences. In addition to these blanks, the laboratory may be required to analyze field blanks (Section 9.6.2) and equipment blanks (Section 9.6.3).
- 7.6.1 Calibration blank—Consists of 1% (v/v) nitric acid in reagent water. If the direct addition procedure (Method A, Section 10.3) is being used, add internal standards.
- 7.6.2 Laboratory blank—Must contain all the reagents in the same volumes as used in processing the samples. The laboratory blank must be carried through the same entire preparation scheme as the samples including digestion, when applicable (Section 9.6.1). If the direct addition procedure (Method A, Section 10.3) is being used, add internal standards to the solution after preparation is complete.
- 7.6.3 Rinse blank—Consists of 1% (v/v) nitric acid in reagent water.
- 7.7 Tuning solution—This solution is used for instrument tuning and mass calibration before analysis (Section 10.2). The solution is prepared by mixing nickel, yttrium, indium, terbium, and lead stock solutions (Section 7.3) in 1% (v/v) nitric acid to produce a concentration of 100 µg/L of each element. Internal standards are not added to this solution. (Depending on the sensitivity of the instrument, this solution may need to be diluted 10-fold.)
- 7.8 Quality control sample (QCS)—The QCS should be obtained from a source outside the laboratory. The concentration of the QCS solution analyzed will depend on the sensitivity of the instrument. To prepare the QCS, dilute an appropriate aliquot of analytes to a concentration ≤ 100 µg/L in 1% (v/v) nitric acid. Because of lower sensitivity, selenium may be diluted to a concentration of < 500 µg/L. If the direct addition procedure (Method A, Section 10.3) is being used, add internal standards after dilution, mix, and store in a FEP bottle. The QCS should be analyzed as needed to meet data quality needs and a fresh solution should be prepared quarterly or more frequently as needed.

- 7.9 Ongoing precision and recovery (OPR) Sample—To an aliquot of reagent water, add aliquots of the multielement stock standard (Section 7.4) to prepare the OPR. The OPR must be carried through the same entire preparation scheme as the samples including sample digestion, when applicable (Section 9.7). If the direct addition procedure (Method A, Section 10.3) is being used, add internal standards to this solution after preparation has been completed.

8.0 Sample Collection, Filtration, Preservation, and Storage

- 8.1 Before an aqueous sample is collected, consideration should be given to the type of data required, (i.e., dissolved or total recoverable), so that appropriate preservation and pretreatment steps can be taken. The pH of all aqueous samples must be tested immediately before they are aliquotted for processing or direct analysis to ensure the sample has been properly preserved. If properly acid-preserved, the sample can be held up to 6 months before analysis.
- 8.2 Sample collection—Samples are collected as described in the Sampling Method.
- 8.3 Sample filtration—For dissolved metals, samples and field blanks are filtered through a 0.45- μm capsule filter at the field site. Filtering procedures are described in the Sampling Method. For the determination of total recoverable elements, samples are not filtered but should be preserved according to the procedures in Section 8.4.
- 8.4 Sample preservation—Preservation of samples and field blanks for both dissolved and total recoverable elements may be performed in the field when the samples are collected or in the laboratory. However, to avoid the hazards of strong acids in the field and transport restrictions, to minimize the potential for sample contamination, and to expedite field operations, the sampling team may prefer to ship the samples to the laboratory within 2 weeks of collection. Samples and field blanks should be preserved at the laboratory immediately when they are received. For all metals, preservation involves the addition of 10% HNO_3 (Section 7.1.3) to bring the sample to pH <2. For samples received at neutral pH, approx 5 mL of 10% HNO_3 per liter will be required.
- 8.4.1 Wearing clean gloves, remove the cap from the sample bottle, add the volume of reagent grade acid that will bring the pH to <2, and recap the bottle immediately. If the bottle is full, withdraw the necessary volume using a precleaned pipet and then add the acid. Record the volume withdrawn and the amount of acid used.

NOTE: Do not dip pH paper or a pH meter into the sample; remove a small aliquot with a clean pipet and test the aliquot. When the nature of the sample is either unknown or known to be hazardous, the sample should be acidified in a fume hood. See Section 5.2.

- 8.4.2 Store the preserved sample for a minimum of 48 h at 0–4°C to allow the acid to completely dissolve the metal(s) adsorbed on the container walls. The sample pH should be verified as <2 immediately before an aliquot is withdrawn for processing or direct analysis. If, for some reason such as high alkalinity, the sample pH is verified to be >2, more acid must be added and the sample held for 16 h until verified to be pH <2. See Section 8.1.

8.4.3 With each sample batch, preserve a method blank and an OPR sample in the same way as the sample(s).

8.4.4 Sample bottles should be stored in polyethylene bags at 0–4°C until analysis.

9.0 Quality Assurance/Quality Control

9.1 Each laboratory that uses this method is required to operate a formal quality assurance program (Reference 23). The minimum requirements of this program consist of an initial demonstration of laboratory capability, analysis of samples spiked with metals of interest to evaluate and document data quality, and analysis of standards and blanks as tests of continued performance. Laboratory performance is compared to established performance criteria to determine that results of the analysis meet the performance characteristics of the method.

9.1.1 The analyst shall make an initial demonstration of the ability to generate acceptable accuracy and precision with this method. This ability is established as described in Section 9.2.

9.1.2 In recognition of advances that are occurring in analytical technology, the analyst is permitted to exercise certain options to eliminate interferences or lower the costs of measurements. These options include alternate digestion, preconcentration, cleanup procedures, and changes in instrumentation. Alternate determinative techniques, such as the substitution of a colorimetric technique or changes that degrade method performance, are not allowed. If an analytical technique other than the techniques specified in the method is used, then that technique must have a specificity equal to or better than the specificity of the techniques in the method for the analytes of interest.

9.1.2.1 Each time the method is modified, the analyst is required to repeat the procedure in Section 9.2. If the change will affect the detection limit of the method, the laboratory is required to demonstrate that the MDL (40 *CFR* Part 136, Appendix B) is lower than the MDL for that analyte in this method, or one-third the regulatory compliance level, whichever is higher. If the change will affect calibration, the analyst must recalibrate the instrument according to Section 10.

9.1.2.2 The laboratory is required to maintain records of modifications made to this method. These records include the following, at a minimum:

9.1.2.2.1 The names, titles, addresses, and telephone numbers of the analyst(s) who performed the analyses and modification, and of the quality control officer who witnessed and will verify the analyses and modification.

9.1.2.2.2 A listing of metals measured, by name and CAS Registry number.

9.1.2.2.3 A narrative stating reason(s) for the modification(s).

- 9.1.2.2.4 Results from all quality control (QC) tests comparing the modified method to this method, including:
- (a) Calibration
 - (b) Calibration verification
 - (c) Initial precision and recovery (Section 9.2)
 - (d) Analysis of blanks
 - (e) Accuracy assessment
- 9.1.2.2.5 Data that will allow an independent reviewer to validate each determination by tracing the instrument output (peak height, area, or other signal) to the final result. These data are to include, where possible:
- (a) Sample numbers and other identifiers
 - (b) Digestion/preparation or extraction dates
 - (c) Analysis dates and times
 - (d) Analysis sequence/run chronology
 - (e) Sample weight or volume
 - (f) Volume before the extraction/concentration step
 - (g) Volume after each extraction/concentration step
 - (h) Final volume before analysis
 - (i) Injection volume
 - (j) Dilution data, differentiating between dilution of a sample or extract
 - (k) Instrument and operating conditions (make, model, revision, modifications)
 - (l) Sample introduction system (ultrasonic nebulizer, flow injection system, etc.)
 - (m) Preconcentration system
 - (n) Operating conditions (background corrections, temperature program, flow rates, etc.)
 - (o) Detector (type, operating conditions, etc.)
 - (p) Mass spectra, printer tapes, and other recordings of raw data
 - (q) Quantitation reports, data system outputs, and other data to link raw data to results reported
- 9.1.3 Analyses of blanks are required to demonstrate freedom from contamination. Section 9.6 describes the required types, procedures, and criteria for analysis of blanks.
- 9.1.4 The laboratory shall spike at least 10% of the samples with the metal(s) of interest to monitor method performance. Section 9.3 describes this test. When results of these spikes indicate atypical method performance for samples, an alternative extraction or cleanup technique must be used to bring method performance within acceptable limits. If method performance for spikes cannot be brought within the limits given in this method, the result may not be reported for regulatory compliance purposes.

- 9.1.5 The laboratory shall, on an ongoing basis, demonstrate through calibration verification and through analysis of the ongoing precision and recovery aliquot that the analytical system is in control. These procedures are described in Sections 10.5 and 9.7 of this method.
- 9.1.6 The laboratory shall maintain records to define the quality of data that are generated. Development of accuracy statements is described in Section 9.3.4.

9.2 Initial demonstration of laboratory capability

9.2.1 **Method detection limit**—To establish the ability to detect the trace metals of interest, the analyst shall determine the MDL for each analyte according to the procedure in 40 *CFR* 136, Appendix B using the apparatus, reagents, and standards that will be used in the practice of this method. The laboratory must produce an MDL that is less than or equal to the MDL listed in Table 1, or one-third the regulatory compliance limit, whichever is greater. MDLs should be determined when a new operator begins work or whenever, in the judgment of the analyst, a change in instrument hardware or operating conditions would dictate that they be redetermined.

9.2.2 **Initial precision and recovery (IPR)**—To establish the ability to generate acceptable precision and recovery, the analyst shall perform the following operations.

9.2.2.1 Analyze four aliquots of reagent water spiked with the metal(s) of interest at 2–3 times the ML (Table 1), according to the procedures in Section 12. All digestion, extraction, and concentration steps, and the containers, labware, and reagents that will be used with samples must be used in this test.

9.2.2.2 Using results of the set of four analyses, compute the average percent recovery (X) for the metal(s) in each aliquot and the standard deviation of the recovery (s) for each metal.

9.2.2.3 For each metal, compare s and X with the corresponding limits for initial precision and recovery in Table 2. If s and X for all metal(s) meet the acceptance criteria, system performance is acceptable and analysis of blanks and samples may begin. If, however, any individual s exceeds the precision limit or any individual X falls outside the range for accuracy, system performance is unacceptable for that metal. Correct the problem and repeat the test (Section 9.2.2.1).

9.2.3 **Linear calibration ranges**—Linear calibration ranges are primarily detector limited. The upper limit of the linear calibration range should be established for each analyte by determining the signal responses from a minimum of three different concentration standards, one of which is close to the upper limit of the linear range. Care should be taken to avoid potential damage to the detector during this process. The analyst should judge the linear calibration range that may be used for the analysis of samples from the resulting data. The upper limit should be an observed signal no more than 10% below the level extrapolated from lower standards. Determined sample analyte concentrations that are greater than 90% of the determined upper limit must be diluted and reanalyzed. The upper limits should be verified whenever, in the judgement of the

analyst, a change in analytical performance caused by either a change in instrument hardware or operating conditions would dictate they be redetermined.

9.2.4 Quality control sample (QCS)—When beginning the use of this method, quarterly or as required to meet data quality needs, verify the calibration standards and acceptable instrument performance with the preparation and analyses of a QCS (Section 7.8). To verify the calibration standards the determined mean concentration from 3 analyses of the QCS must be within $\pm 10\%$ of the stated QCS value. If the QCS is not within the required limits, an immediate second analysis of the QCS is recommended to confirm unacceptable performance. If the calibration standards, acceptable instrument performance, or both cannot be verified, the source of the problem must be identified and corrected before proceeding with further analyses.

9.3 Method accuracy—To assess the performance of the method on a given sample matrix, the laboratory must perform matrix spike (MS) and matrix spike duplicate (MSD) sample analyses on 10% of the samples from each site being monitored, or at least one MS sample analysis and one MSD sample analysis must be performed for each sample batch (samples collected from the same site at the same time, to a maximum of 10 samples), whichever is more frequent. Blanks (e.g., field blanks) may not be used for MS/MSD analysis.

9.3.1 The concentration of the MS and MSD is determined as follows:

9.3.1.1 If, as in compliance monitoring, the concentration of a specific metal in the sample is being checked against a regulatory concentration limit, the spike must be at that limit or at 1–5 times the background concentration, whichever is greater.

9.3.1.2 If the concentration is not being checked against a regulatory limit, the concentration must be at 1–5 times the background concentration or at 1–5 times the ML in Table 1, whichever is greater.

9.3.2 Assessing spike recovery

9.3.2.1 Determine the background concentration (B) of each metal by analyzing one sample aliquot according to the procedure in Section 12.

9.3.2.2 If necessary, prepare a QC check sample concentrate that will produce the appropriate level (Section 9.3.1) in the sample when the concentrate is added.

9.3.2.3 Spike a second sample aliquot with the QC check sample concentrate and analyze it to determine the concentration after spiking (A) of each metal.

9.3.2.4 Calculate each percent recovery (P) as $100(A - B)/T$, where T is the known true value of the spike.

9.3.3 Compare the percent recovery (P) for each metal with the corresponding QC acceptance criteria found in Table 2. If any individual P falls outside the designated range for recovery, that metal has failed the acceptance criteria.

- 9.3.3.1 For a metal that has failed the acceptance criteria, analyze the ongoing precision and recovery standard (Section 9.7). If the OPR is within its respective limit for the metal(s) that failed (Table 2), the analytical system is in control and the problem can be attributed to the sample matrix.
- 9.3.3.2 For samples that exhibit matrix problems, further isolate the metal(s) from the sample matrix using dilution, chelation, extraction, concentration, hydride generation, or other means, and repeat the accuracy test (Section 9.3.2).
- 9.3.3.3 If the recovery for the metal remains outside the acceptance criteria, the analytical result for that metal in the unspiked sample is suspect and may not be reported for regulatory compliance purposes.
- 9.3.4 Recovery for samples should be assessed and records maintained.
- 9.3.4.1 After the analysis of five samples of a given matrix type (river water, lake water, etc.) for which the metal(s) pass the tests in Section 9.3.3, compute the average percent recovery (R) and the standard deviation of the percent recovery (SR) for the metal(s). Express the accuracy assessment as a percent recovery interval from $R - 2SR$ to $R + 2SR$ for each matrix. For example, if $R = 90\%$ and $SR = 10\%$ for five analyses of river water, the accuracy interval is expressed as 70–110%.
- 9.3.4.2 Update the accuracy assessment for each metal in each matrix on a regular basis (e.g., after each five to ten new measurements).
- 9.4 Precision of matrix spike and duplicate
- 9.4.1 Calculate the relative percent difference (RPD) between the MS and MSD per the equation below using the concentrations found in the MS and MSD. Do not use the recoveries calculated in Section 9.3.2.4 for this calculation because the RPD is inflated when the background concentration is near the spike concentration.

$$RPD = 100 \frac{(|D1 - D2|)}{(D1 + D2)/2}$$

Where:

D1 = concentration of the analyte in the MS sample

D2 = concentration of the analyte in the MSD sample

- 9.4.2 The relative percent difference between the matrix spike and the matrix spike duplicate must be less than 20%. If this criterion is not met, the analytical system is judged to be out of control. In this case, correct the problem and reanalyze all samples in the sample batch associated with the MS/MSD that failed the RPD test.

- 9.5 Internal standards responses—The analyst is expected to monitor the responses from the internal standards throughout the sample batch being analyzed. Ratios of the internal standards responses against each other should also be monitored routinely. This information may be used to detect potential problems caused by mass dependent drift, errors incurred in adding the internal standards, or increases in the concentrations of individual internal standards caused by background contributions from the sample. The absolute response of any one internal standard must not deviate more than 60–125% of the original response in the calibration blank. If deviations greater than these are observed, flush the instrument with the rinse blank and monitor the responses in the calibration blank. If the responses of the internal standards are now within the limit, take a fresh aliquot of the sample, dilute by a further factor of 2, add the internal standards, and reanalyze. If, after flushing, the response of the internal standards in the calibration blank are out of limits, terminate the analysis and determine the cause of the drift. Possible causes of drift may be a partially blocked sampling cone or a change in the tuning condition of the instrument.
- 9.6 Blanks—Blanks are analyzed to demonstrate freedom from contamination.
- 9.6.1 Laboratory (method) blank
- 9.6.1.1 Prepare a method blank with each sample batch (samples of the same matrix started through the sample preparation process (Section 12) on the same 12-hour shift, to a maximum of 10 samples). Analyze the blank immediately after the OPR is analyzed (Section 9.7) to demonstrate freedom from contamination.
- 9.6.1.2 If the metal of interest or any potentially interfering substance is found in the blank at a concentration equal to or greater than the MDL (Table 1), sample analysis must be halted, the source of the contamination determined, the samples and a new method blank prepared, and the sample batch and fresh method blank reanalyzed.
- 9.6.1.3 Alternatively, if a sufficient number of blanks (3 minimum) are analyzed to characterize the nature of a blank, the average concentration plus two standard deviations must be less than the regulatory compliance level.
- 9.6.1.4 If the result for a single blank remains above the MDL or if the result for the average concentration plus two standard deviations of three or more blanks exceeds the regulatory compliance level, results for samples associated with those blanks may not be reported for regulatory compliance purposes. Stated another way, results for all initial precision and recovery tests (Section 9.2) and all samples must be associated with an uncontaminated method blank before these results may be reported for regulatory compliance purposes.
- 9.6.2 Field blank
- 9.6.2.1 Analyze the field blank(s) shipped with each set of samples (samples collected from the same site at the same time, to a maximum of 10 samples). Analyze the blank immediately before analyzing the samples in the batch.

- 9.6.2.2 If the metal of interest or any potentially interfering substance is found in the field blank at a concentration equal to or greater than the ML (Table 1) or greater than one-fifth the level in the associated sample, whichever is greater, results for associated samples may be the result of contamination and may not be reported for regulatory compliance purposes.
- 9.6.2.3 Alternatively, if a sufficient number of field blanks (3 minimum) are analyzed to characterize the nature of the field blank, the average concentration plus two standard deviations must be less than the regulatory compliance level or less than one-half the level in the associated sample, whichever is greater.
- 9.6.2.4 If contamination of the field blanks and associated samples is known or suspected, the laboratory should communicate this to the sampling team so that the source of contamination can be identified and corrective measures taken prior to the next sampling event.
- 9.6.3 Equipment Blanks—Before any sampling equipment is used at a given site, the laboratory or cleaning facility is required to generate equipment blanks to demonstrate that the sampling equipment is free from contamination. Two types of equipment blanks are required: bottle blanks and sampler check blanks.
- 9.6.3.1 Bottle blanks—After undergoing appropriate cleaning procedures (Section 11.4), bottles should be subjected to conditions of use to verify the effectiveness of the cleaning procedures. A representative set of sample bottles should be filled with reagent water acidified to $\text{pH} < 2$ and allowed to stand for a minimum of 24 h. Ideally, the time that the bottles are allowed to stand should be as close as possible to the actual time that sample will be in contact with the bottle. After standing, the water should be analyzed for any signs of contamination. If any bottle shows signs of contamination, the problem must be identified, the cleaning procedures corrected or cleaning solutions changed, and all affected bottles recleaned.
- 9.6.3.2 Sampler check blanks—Sampler check blanks are generated in the laboratory or at the equipment cleaning contractor's facility by processing reagent water through the sampling devices using the same procedures that are used in the field (see Sampling Method). Therefore, the "clean hands/dirty hands" technique used during field sampling should be followed when preparing sampler check blanks at the laboratory or cleaning facility.
- 9.6.3.2.1 Sampler check blanks are generated by filling a large carboy or other container with reagent water (Section 7.2) and processing the reagent water through the equipment using the same procedures that are used in the field (see Sampling Method). For example, manual grab sampler check blanks are collected by directly submerging a sample bottle into the water, filling the bottle, and capping. Subsurface sampler check blanks are collected by immersing the sampler into the water and pumping water into a sample container.

9.6.3.2.2 The sampler check blank must be analyzed using the procedures given in this method. If any metal of interest or any potentially interfering substance is detected in the blank, the source of contamination or interference must be identified and the problem corrected. The equipment must be demonstrated to be free from the metal(s) of interest before the equipment may be used in the field.

9.6.3.2.3 Sampler check blanks must be run on all equipment that will be used in the field. If, for example, samples are to be collected using both a grab sampling device and a subsurface sampling device, a sampler check blank must be run on both pieces of equipment.

9.7 Ongoing precision and recovery

9.7.1 Prepare an ongoing precision and recovery sample (laboratory fortified method blank) identical to the initial precision and recovery aliquots (Section 9.2) with each sample batch (samples of the same matrix started through the sample preparation process (Section 12) on the same 12-hour shift, to a maximum of 10 samples) by spiking an aliquot of reagent water with the metal(s) of interest.

9.7.2 Analyze the OPR sample before the method blank and samples from the same batch are analyzed.

9.7.3 Compute the percent recovery of each metal in the OPR sample.

9.7.4 For each metal, compare the concentration to the limits for ongoing recovery in Table 2. If all metals meet the acceptance criteria, system performance is acceptable and analysis of blanks and samples may proceed. If, however, any individual recovery falls outside of the range given, the analytical processes are not being performed properly for that metal. Correct the problem, reprepare the sample batch, and repeat the ongoing precision and recovery test (Section 9.7).

9.7.5 Add results that pass the specifications in Section 9.7.4 to initial and previous ongoing data for each metal in each matrix. Update QC charts to form a graphic representation of continued laboratory performance. Develop a statement of laboratory accuracy for each metal in each matrix type by calculating the average percent recovery (R) and the standard deviation of percent recovery (SR). Express the accuracy as a recovery interval from $R - 2SR$ to $R + 2SR$. For example, if $R = 95\%$ and $SR = 5\%$, the accuracy is 85–105%.

9.8 The specifications contained in this method can be met if the instrument used is calibrated properly and then maintained in a calibrated state. A given instrument will provide the most reproducible results if dedicated to the settings and conditions required for the analyses of metals by this method.

9.9 Depending on specific program requirements, the laboratory may be required to analyze field duplicates collected to determine the precision of the sampling technique. The relative percent

difference (RPD) between field duplicates should be less than 20%. If the RPD of the field duplicates exceeds 20%, the laboratory should communicate this to the sampling team so that the source of error can be identified and corrective measures taken before the next sampling event.

10.0 Calibration and Standardization

10.1 Operating conditions—Because of the diversity of instrument hardware, no detailed instrument operating conditions are provided. The analyst is advised to follow the recommended operating conditions provided by the manufacturer. The analyst is responsible for verifying that the instrument configuration and operating conditions satisfy the quality control requirements in this method. Table 5 lists instrument operating conditions that may be used as a guide for analysts in determining instrument configuration and operating conditions.

10.2 Precalibration routine—The following precalibration routine should be completed before calibrating the instrument until it can be documented with periodic performance data that the instrument meets the criteria listed below without daily tuning.

10.2.1 Initiate proper operating configuration of instrument and data system. Allow a period of not less than 30 min for the instrument to warm up. During this period, conduct mass calibration and resolution checks using the tuning solution. Resolution at low mass is indicated by nickel isotopes 60, 61, 62. Resolution at high mass is indicated by lead isotopes 206, 207, 208. For good performance, adjust the spectrometer resolution to produce a peak width of approximately 0.75 amu at 5% peak height. Adjust mass calibration if it has shifted by more than 0.1 amu from unit mass.

10.2.2 Instrument stability must be demonstrated by running the tuning solution (Section 7.7) a minimum of five times with resulting relative standard deviations of absolute signals for all analytes of less than 10%.

10.3 Internal standardization—Internal standardization must be used in all analyses to correct for instrument drift and physical interferences. For full mass range scans, a minimum of three internal standards must be used. Internal standards must be present in all samples, standards, and blanks at identical levels. This may be achieved by directly adding an aliquot of the internal standards to the CAL standard, blank, or sample solution (Method A), or alternatively by mixing with the solution before nebulization using a second channel of the peristaltic pump and a mixing coil (Method B). The concentration of the internal standard should be sufficiently high that good precision is obtained in the measurement of the isotope used for data correction and to minimize the possibility of correction errors if the internal standard is naturally present in the sample. Internal standards should be added to blanks, samples, and standards in a like way so that dilution effects resulting from the addition may be disregarded.

NOTE: *Bismuth should not be used as an internal standard using the direct addition method (Method A, Section 10.3) because it is not efficiently concentrated on the iminodiacetate column.*

10.4 Calibration—Before initial calibration, set up proper instrument software routines for quantitative analysis and connect the ICP-MS instrument to the preconcentration apparatus.

The instrument must be calibrated at a minimum of three points for each analyte to be determined.

10.4.1 Inject the calibration blank (Section 7.6.1) and calibration standards A and B (Section 7.4.1) prepared at three or more concentrations, one of which must be at the ML (Table 1), and another that must be near the upper end of the linear dynamic range. The calibration solutions should be processed through the preconcentration system using the procedures described in Section 12. A minimum of three replicate integrations are required for data acquisition. Use the average of the integrations for instrument calibration and data reporting.

10.4.2 Compute the response factor at each concentration, as follows:

$$RF = \frac{A_s \times C_{is}}{A_{is} \times C_s}$$

Where:

C_s = concentration of the analyte in the standard or blank solution

C_{is} = concentration of the internal standard in the solution

A_s = height or area of the response at the m/z for the analyte

A_{is} = height or area of the m/z for the internal standard

10.4.3 Using the individual response factors at each concentration, compute the mean RF for each analyte.

10.4.4 Linearity—If the RF over the calibration range is constant (< 20% RSD), the RF can be assumed to be invariant and the mean RF can be used for calculations.

Alternatively, the results can be used to plot a calibration curve of response ratios, A_s/A_{is} , vs. RF.

10.5 Calibration verification—Immediately following calibration, an initial calibration verification should be performed. Adjustment of the instrument is performed until verification criteria are met. Only after these criteria are met may blanks and samples be analyzed.

10.5.1 Analyze the mid-point calibration standard (Section 10.4).

10.5.2 Compute the percent recovery of each metal using the mean RF or calibration curve obtained in the initial calibration.

10.5.3 For each metal, compare the recovery with the corresponding limit for calibration verification in Table 2. If all metals meet the acceptance criteria, system performance is acceptable and analysis of blanks and samples may continue using the response from the initial calibration. If any individual value falls outside the range given, system performance is unacceptable for that compound. In this event, locate and correct the problem and/or prepare a new calibration check standard and repeat the test (Sections 10.5.1–10.5.3), or recalibrate the system according to Section 10.4.

- 10.5.4 Calibration must be verified following every ten samples by analyzing the mid-point calibration standard. If the recovery does not meet the acceptance criteria specified in Table 2, analysis must be halted, the problem corrected, and the instrument recalibrated. All samples after the last acceptable calibration verification must be reanalyzed.
- 10.6 A calibration blank must be analyzed following every calibration verification to demonstrate that there is no carryover of the analytes of interest and that the analytical system is free from contamination. If the concentration of an analyte in the blank result exceeds the MDL, correct the problem, verify the calibration (Section 10.5), and repeat the analysis of the calibration blank.

11.0 Procedures for Cleaning the Apparatus

- 11.1 All sampling equipment, sample containers, and labware should be cleaned in a designated cleaning area that has been demonstrated to be free of trace element contaminants. Such areas may include class 100 clean rooms as described by Moody (Reference 24), labware cleaning areas as described by Patterson and Settle (Reference 6), or clean benches.
- 11.2 Materials, such as gloves (Section 6.10.7), storage bags (Section 6.10.10), and plastic wrap (Section 6.10.11), may be used new without additional cleaning unless the results of the equipment blank pinpoint any of these materials as a source of contamination. In this case, either an alternate supplier must be obtained or the materials must be cleaned.
- 11.3 Cleaning procedures—Proper cleaning of the Apparatus is extremely important, because the Apparatus may not only contaminate the samples but may also remove the analytes of interest by adsorption onto the container surface.

NOTE: *If laboratory, field, and equipment blanks (Section 9.6) from the Apparatus cleaned with fewer cleaning steps than those detailed below show no levels of analytes above the MDL, those cleaning steps that do not eliminate these artifacts may be omitted if all performance criteria outlined in Section 9 are met.*

11.3.1 Bottles, labware, and sampling equipment

- 11.3.1.1 Fill a precleaned basin (Section 6.10.8) with a sufficient quantity of a 0.5% solution of liquid detergent (Section 6.8), and completely immerse each piece of ware. Allow to soak in the detergent for at least 30 min.
- 11.3.1.2 Using a pair of clean gloves (Section 6.10.7) and clean nonmetallic brushes (Section 6.10.9), thoroughly scrub down all materials with the detergent.
- 11.3.1.3 Place the scrubbed materials in a precleaned basin. Change gloves.

- 11.3.1.4 Thoroughly rinse the inside and outside of each piece with reagent water until there is no sign of detergent residue (e.g., until all soap bubbles disappear).
- 11.3.1.5 Change gloves, immerse the rinsed equipment in a hot (50–60°C) bath of concentrated reagent grade HNO₃ (Section 7.1.1) and allow to soak for at least 2 h.
- 11.3.1.6 After soaking, use clean gloves and tongs to remove the Apparatus and thoroughly rinse with distilled, deionized water (Section 7.2).
- 11.3.1.7 Change gloves and immerse the Apparatus in a hot (50–60°C) bath of 1N trace metal grade HCl (Section 7.1.9), and allow to soak for at least 48 h.
- 11.3.1.8 Thoroughly rinse all equipment and bottles with reagent water. Proceed with Section 11.3.2 for labware and sampling equipment. Proceed with Section 11.3.3 for sample bottles.
- 11.3.2 Labware and sampling equipment
- 11.3.2.1 After cleaning, air-dry in a class 100 clean air bench.
- 11.3.2.2 After drying, wrap each piece of ware or equipment in two layers of polyethylene film.
- 11.3.3 Fluoropolymer sample bottles—These bottles should be used if mercury is a target analyte.
- 11.3.3.1 After cleaning, fill sample bottles with 0.1% (v/v) ultrapure HCl (Section 7.1.13) and cap tightly. It may be necessary to use a strap wrench to assure a tight seal.
- 11.3.3.2 After capping, double-bag each bottle in polyethylene zip-type bags. Store at room temperature until sample collection.
- 11.3.4 Bottles, labware, and sampling equipment (polyethylene or material other than fluoropolymer)
- 11.3.4.1 Apply the steps outlined in Sections 11.3.1.1–11.3.1.8 to all bottles, labware, and sampling equipment. Proceed with Section 11.3.4.2 for bottles or Section 11.3.4.3 for labware and sampling equipment.
- 11.3.4.2 After cleaning, fill each bottle with 0.1% (v/v) ultrapure HCl (Section 7.1.13). Double-bag each bottle in a polyethylene bag to prevent contamination of the surfaces with dust and dirt. Store at room temperature until sample collection.

- 11.3.4.3 After rinsing labware and sampling equipment, air-dry in a class 100 clean air bench. After drying, wrap each piece of ware or equipment in two layers of polyethylene film.

NOTE: Polyethylene bottles cannot be used to collect samples that will be analyzed for mercury at trace (e.g., 0.012 µg/L) levels because of the potential for vapors to diffuse through the polyethylene.

- 11.3.4.4 Polyethylene bags—If polyethylene bags need to be cleaned, clean according to the following procedure:

11.3.4.4.1 Partially fill with cold, (1+1) HNO₃ (Section 7.1.2) and rinse with distilled deionized water (Section 7.2).

11.3.4.4.2 Dry by hanging upside down from a plastic line with a plastic clip.

11.3.5 Silicone tubing, fluoropolymer tubing, and other sampling apparatus—Clean any silicone, fluoropolymer, or other tubing used to collect samples by rinsing with 10% HCl (Section 7.1.10) and flushing with water from the site before sample collection.

11.3.6 Extension pole—Because of its length, it is impractical to submerge the 2-m polyethylene extension pole (used in with the optional grab sampling device) in acid solutions as described above. If such an extension pole is used, a nonmetallic brush (Section 6.10.9) should be used to scrub the pole with reagent water and the pole wiped down with acids described in Section 11.3.4. After cleaning, the pole should be wrapped in polyethylene film.

11.4 Storage—Store each piece or assembly of the Apparatus in a clean, single polyethylene zip-type bag. If shipment is required, place the bagged apparatus in a second polyethylene zip-type bag.

11.5 All cleaning solutions and acid baths should be periodically monitored for accumulation of metals that could lead to contamination. When levels of metals in the solutions become too high, the solutions and baths should be changed and the old solutions neutralized and discarded in compliance with state and federal regulations.

12.0 Procedures for Sample Preparation and Analysis

12.1 Aqueous sample preparation—dissolved analytes

12.1.1 For determination of dissolved analytes in ground and surface waters, pipet an aliquot (≥ 20 mL) of the filtered, acid-preserved sample into a clean 50-mL polypropylene centrifuge tube. Add an appropriate volume of (1+1) nitric acid to adjust the acid concentration of the aliquot to approximate a 1% (v/v) nitric acid solution (e.g., add 0.4 mL (1+1) HNO₃ to a 20-mL aliquot of sample). Add the internal standards, cap the tube, and mix. The sample is now ready for analysis. Allowance for sample dilution should be made in the calculations.

12.2 Aqueous sample preparation—total recoverable analytes

NOTE: To preclude contamination during sample digestion, it may be necessary to perform the open-beaker, total-recoverable digestion procedure described in Sections 12.2.1–12.2.6 in a fume hood that is located in a clean room. An alternate digestion procedure is provided in Section 12.2.7; however, this procedure has not undergone interlaboratory testing.

12.2.1 For the determination of total recoverable analytes in ambient water samples, transfer a 100-mL (± 1 mL) aliquot from a well-mixed, acid-preserved sample to a 250-mL Griffin beaker (Section 6.10.3). If appropriate, a smaller sample volume may be used.

12.2.2 Add 2 mL (1+1) nitric acid to the beaker and place the beaker on the hot plate for digestion. The hot plate should be located in a fume hood and previously adjusted to provide evaporation at a temperature of approximately but no higher than 85°C. (See the following note.) The beaker should be covered or other necessary steps should be taken to prevent sample contamination from the fume hood environment.

NOTE: For proper heating, adjust the temperature control of the hot plate so that an uncovered Griffin beaker containing 50 mL of water placed in the center of the hot plate can be maintained at a temperature approximately but no higher than 85°C. (Once the beaker is covered with a watch glass, the temperature of the water will rise to approximately 95°C.)

12.2.3 Reduce the volume of the sample aliquot to about 20 mL by gentle heating at 85°C. Do not boil. This step takes about 2 h for a 100-mL aliquot with the rate of evaporation rapidly increasing as the sample volume approaches 20 mL. (A spare beaker containing 20 mL of water can be used as a gauge.)

12.2.4 Cover the lip of the beaker with a watch glass to reduce additional evaporation and gently reflux the sample for 30 min. (Slight boiling may occur, but vigorous boiling must be avoided.)

12.2.5 Allow the beaker to cool. Quantitatively transfer the sample solution to a 100-mL volumetric flask, make to volume with reagent water, stopper, and mix.

12.2.6 Allow any undissolved material to settle overnight, or centrifuge a portion of the prepared sample until clear. (If, after centrifuging or standing overnight, the sample contains suspended solids that would clog the nebulizer, a portion of the sample may be filtered to remove the solids before analysis. However, care should be exercised to avoid potential contamination from filtration.) The sample is now ready for analysis. Because the effects of various matrices on the stability of diluted samples cannot be characterized, all analyses should be performed as soon as possible after the completed preparation.

12.2.7 Alternate total recoverable digestion procedure

- 12.2.7.1 Open the preserved sample under clean conditions. Add ultrapure nitric acid at the rate of 10 mL/L. Remove the cap from the original container only long enough to add the aliquot of acid. The sample container should not be filled to the lip by the addition of the acid. However, only minimal headspace is needed to avoid leakage during heating.
- 12.2.7.2 Tightly recap the container and shake thoroughly. Place the container in an oven preheated to 85°C. The container should be placed on an insulating piece of material such as wood rather than directly on the typical metal grating. After the samples have reached 85°C, heat for 2 h. (Total time will be 2.5–3 h depending on the sample size). Temperature can be monitored using an identical sample container with distilled water and a thermocouple to standardize heating time.
- 12.2.7.3 Allow the sample to cool. Add the internal standards and mix. The sample is now ready for analysis. Remove aliquots for analysis under clean conditions.
- 12.3 Before first use, the preconcentration system should be thoroughly cleaned and decontaminated using 0.2M oxalic acid.
- 12.3.1 Place approximately 500 mL 0.2M oxalic acid in all the eluent/solution containers and fill the sample loop with 0.2M oxalic acid using the sample pump (P4) at a flow rate of 3–5 mL/min. With the preconcentration system disconnected from the ICP-MS instrument, use the pump program sequence listed in Table 3, to flush the complete system with oxalic acid. Repeat the flush sequence three times.
- 12.3.2 Repeat the sequence described in Section 12.3.1 using 1.25M nitric acid and again using reagent water in place of the 0.2M oxalic acid.
- 12.3.3 Rinse the containers thoroughly with reagent water, fill them with their designated reagents (see Figure 1), and run through the sequence in Table 3 once to prime the pump and all eluent lines with the correct reagents.
- 12.4 Sample Analysis
- 12.4.1 Initiate ICP-MS instrument operating configuration. Tune the instrument for the analytes of interest (Section 10).
- 12.4.2 Establish instrument software run procedures for quantitative analysis. Because the analytes are eluted from the preconcentration column in a transient manner, it is recommended that the instrument software be configured in a rapid scan/peak hopping mode. The instrument is now ready to be calibrated.
- 12.4.3 Reconnect the preconcentration system to the ICP-MS instrument. With valves A and B in the off position and valve C in the on position, load the sample through the sample loop to waste using pump P4 for 4 min at 4 mL/min. Switch on the carrier

pump (P3) and pump 1% nitric acid to the nebulizer of the ICP-MS instrument at a flow rate of 0.8–1.0 mL/min.

- 12.4.4 Switch on the buffer pump (P2), and pump 2M ammonium acetate at a flow rate of 1.0 mL/min.
- 12.4.5 Preconcentration of the sample may be achieved by running through an eluent pump program (P1) sequence similar to that illustrated in Table 3. The exact timing of this sequence should be modified according to the internal volume of the connecting tubing and the specific hardware configuration used.
- 12.4.5.1 Inject sample—With valves A, B and C on, load sample from the loop onto the column using 1M ammonium acetate for 4.5 min at 4.0 mL/min. The analytes are retained on the column, while most of the matrix is passed through to waste.
- 12.4.5.2 Elute analytes—Turn off valves A and B and begin eluting the analytes by pumping 1.25M nitric acid through the column at 4.0 mL/min, then turn off valve C and pump the eluted analytes into the ICP-MS instrument at 1.0 mL/min. Initiate ICP-MS software data acquisition and integrate the eluted analyte profiles.
- 12.4.5.3 Column Reconditioning—Turn on valve C to direct column effluent to waste, and pump 1.25M nitric acid, 1M ammonium acetate, 1.25M nitric acid and 1M ammonium acetate alternately through the column at 4.0 mL/min. During this process, the next sample can be loaded into the sample loop using the sample pump (P4).
- 12.4.6 Repeat the sequence described in Section 12.4.5 for each sample to be analyzed. At the end of the analytical run, leave the column filled with 1M ammonium acetate buffer until it is next used.
- 12.4.7 Samples having concentrations higher than the established linear dynamic range should be diluted into range with 1% HNO₃ (v/v) and reanalyzed.

13.0 Data Analysis and Calculations

- 13.1 Elemental equations recommended for sample data calculations are listed in Table 4. Sample data should be reported in units of µg/L (parts-per-billion; ppb). Report results at or above the ML for metals found in samples and determined in standards. Report all results for metals found in blanks, regardless of level.
- 13.2 For data values less than the ML, two significant figures should be used for reporting element concentrations. For data values greater than or equal to the ML, three significant figures should be used.
- 13.3 Compute the concentration of each analyte in the sample using the response factor determined from calibration data (Section 10.4) and the following equation:

$$C_s \text{ (mg/L)} = \frac{A_s \times C_{is}}{A_{is} \times RF}$$

Where the terms are as defined in Section 10.4.2.

- 13.4 Corrections for characterized spectral interferences should be applied to the data. Chloride interference corrections should be made on all samples, regardless of the addition of hydrochloric acid, because the chloride ion is a common constituent of environmental samples.
- 13.5 If an element has more than one monitored m/z, examination of the concentration calculated for each m/z, or the relative abundances, will provide useful information for the analyst in detecting a possible spectral interference. Consideration should therefore be given to both primary and secondary m/z's in the evaluation of the element concentration. In some cases, the secondary m/z may be less sensitive or more prone to interferences than the primary recommended m/z; therefore, differences between the results do not necessarily indicate a problem with data calculated for the primary m/z.
- 13.6 The QC data obtained during the analyses provide an indication of the quality of the sample data and should be provided with the sample results.
- 13.7 Do not perform blank subtraction on the sample results. Report results for samples and accompanying blanks.

14.0 Method Performance

- 14.1 The method detection limits (MDLs) listed in Table 1 and the quality control acceptance criteria listed in Table 2 were validated in two laboratories (Reference 25) for dissolved analytes.

15.0 Pollution Prevention

- 15.1 Pollution prevention encompasses any technique that reduces or eliminates the quantity or toxicity of waste at the point of generation. Many opportunities for pollution prevention exist in laboratory operation. The EPA has established a preferred hierarchy of environmental management techniques that places pollution prevention as the management option of first choice. Whenever feasible, laboratory personnel should use pollution prevention techniques to address their waste generation. When wastes cannot be feasibly reduced at the source, the Agency recommends recycling as the next best option. The acids used in this method should be reused as practicable by purifying by electrochemical techniques. The only other chemicals used in this method are the neat materials used in preparing standards. These standards are used in extremely small amounts and pose little threat to the environment when managed properly. Standards should be prepared in volumes consistent with laboratory use to minimize the volume of expired standards to be disposed.

- 15.2 For information about pollution prevention that may be applicable to laboratories and research institutions, consult *Less is Better: Laboratory Chemical Management for Waste Reduction*, available from the American Chemical Society's Department of Government Relations and Science Policy, 1155 16th Street NW, Washington DC 20036, 202/872-4477.

16.0 Waste Management

- 16.1 The Environmental Protection Agency requires that laboratory waste management practices be conducted consistent with all applicable rules and regulations. The Agency urges laboratories to protect the air, water, and land by minimizing and controlling all releases from hoods and bench operations, complying with the letter and spirit of any sewer discharge permits and regulations, and by complying with all solid and hazardous waste regulations, particularly the hazardous waste identification rules and land disposal restrictions. For further information on waste management consult *The Waste Management Manual for Laboratory Personnel*, available from the American Chemical Society at the address listed in the Section 15.2.

17.0 References

- 1 Adeloju, S.B.; Bond, A.M. "Influence of Laboratory Environment on the Precision and Accuracy of Trace Element Analysis," *Anal. Chem.* **1985**, *57*, 1728.
- 2 Berman, S.S.; Yeats, P.A. "Sampling of Seawater for Trace Metals," *CRC Reviews in Analytical Chemistry* **1985**, *16*, 1.
- 3 Bloom, N.S. "Ultra-Clean Sampling, Storage, and Analytical Strategies for the Accurate Determination of Trace Metals in Natural Waters"; Presented at the 16th Annual EPA Conference on the Analysis of Pollutants in the Environment, Norfolk, VA, May 5, 1993.
- 4 Bruland, K.W. "Trace Elements in Seawater," *Chemical Oceanography* **1983**, *8*, 157.
- 5 Nriagu, J.O.; Larson, G.; Wong, H.K.T.; Azcue, J.M. "A Protocol for Minimizing Contamination in the Analysis of Trace Metals in Great Lakes Waters," *J. Great Lakes Research* **1993**, *19*, 175.
- 6 Patterson, C.C.; Settle, D.M. "Accuracy in Trace Analysis"; In *National Bureau of Standards Special Publication 422*; LaFleur, P.D., Ed., U.S. Government Printing Office, Washington, DC, 1976.
- 7 Fitzgerald, W.F.; Watras, C.J. *Science of the Total Environment* **1989**, *87/88*, 223.
- 8 Gill, G.A.; Fitzgerald, W.F. *Deep Sea Res.* **1985**, *32*, 287.
- 9 Prothro, Martha G., "Office of Water Policy and Technical Guidance on Interpretation and Implementation of Aquatic Life Metals Criteria," EPA Memorandum to Regional Water Management and Environmental Services Division Directors, Oct. 1, 1993.

- 10 "Format for Method Documentation", Distributed by the EPA Environmental Monitoring Management Council, Washington, DC, Nov. 18, 1993.
- 11 Siraraks, A.; Kingston, H.M.; Riviello, J.M. *Anal Chem.* **1990**, *62*, 1185.
- 12 Heithmar, E.M., Hinnars, T.A.; Rowan, J.T.; Riviello, J.M. *Anal Chem.* **1990**, *62*, 857.
- 13 Gray, A.L.; Date, A.R. *Analyst*, **1983**, *108*, 1033.
- 14 Houk, R.S. et al. *Anal Chem.* **1980**, *52*, 2283.
- 15 Houk, R.S. *Anal. Chem.* **1986**, *58*, 97A.
- 16 Windom, H.L; Byrd, J.T.; Smith, R.G., Jr.; Huan, F. "Inadequacy of NASQAN Data for Assessing Metal Trends in the Nation's Rivers," *Environ. Sci. Technol.* **1991**, *25*, 1137.
- 17 Zief, M.; Mitchell, J.W. "Contamination Control in Trace Metals Analysis"; In *Chemical Analysis 1976*, Vol. 47, Chapter 6.
- 18 Thompson, J.J.; Houk, R.S. *Appl. Spec.* **1987**, *41*, 801.
- 19 *Carcinogens - Working With Carcinogens*; Department of Health, Education, and Welfare, Public Health Service. Centers for Disease Control. National Institute for Occupational Safety and Health Publication No. 77-206, Aug. 1977. Available from the National Technical Information Service (NTIS) as PB-277256.
- 20 "OSHA Safety and Health Standards, General Industry," 29 *CFR* 1910, Occupational Safety and Health Administration, OSHA 2206 (revised January 1976).
- 21 *Safety in Academic Chemistry Laboratories*, American Chemical Society Publication, Committee on Chemical Safety, 3rd Edition, 1979.
- 22 "Proposed OSHA Safety and Health Standards, Laboratories, Occupational Safety and Health Administration," *Fed. Regist.*, July 24, 1986.
- 23 *Handbook of Analytical Quality Control in Water and Wastewater Laboratories*; U.S. Environmental Protection Agency. EMSL-Cincinnati, OH, March 1979; EPA-600/4-79-019.
- 24 Moody, J.R. "NBS Clean Laboratories for Trace Element Analysis," *Anal. Chem.* **1982**, *54*, 1358A.
- 25 "Results of the Validation Study for Determination of Trace Metals at EPA Water Quality Criteria Levels," April 1995. Available from the Sample Control Center (operated by DynCorp), 300 N. Lee Street, Alexandria, VA 22314, 703/519-1140.

18.0 Glossary

Many of the terms and definitions listed below are used in the EPA 1600-series methods, but terms have been cross-referenced to terms commonly used in other methods where possible.

- 18.1 **Ambient Water**—Waters in the natural environment (e.g., rivers, lakes, streams, and other receiving waters), as opposed to effluent discharges.
- 18.2 **Analyte**—A metal tested for by the methods referenced in this method. The analytes are listed in Table 1.
- 18.3 **Apparatus**—The sample container and other containers, filters, filter holders, labware, tubing, pipets, and other materials and devices used for sample collection or sample preparation, and that will contact samples, blanks, or analytical standards.
- 18.4 **Calibration Blank**—A volume of reagent water acidified with the same acid matrix as in the calibration standards. The calibration blank is a zero standard and is used to calibrate the ICP instrument (Section 7.6.1).
- 18.5 **Calibration Standard (CAL)**—A solution prepared from a dilute mixed standard and/or stock solutions and used to calibrate the response of the instrument with respect to analyte concentration.
- 18.6 **Dissolved Analyte**—The concentration of analyte in an aqueous sample that will pass through a 0.45- μm membrane filter assembly prior to sample acidification (Section 8.3).
- 18.7 **Equipment Blank**—An aliquot of reagent water that is subjected in the laboratory to all aspects of sample collection and analysis, including contact with all sampling devices and apparatus. The purpose of the equipment blank is to determine if the sampling devices and apparatus for sample collection have been adequately cleaned before they are shipped to the field site. An acceptable equipment blank must be achieved before the sampling devices and apparatus are used for sample collection. In addition, equipment blanks should be run on random, representative sets of gloves, storage bags, and plastic wrap for each lot to determine if these materials are free from contamination before they are used.
- 18.8 **Field Blank**—An aliquot of reagent water that is placed in a sample container in the laboratory, shipped to the field, and treated as a sample in all respects, including contact with the sampling devices and exposure to sampling site conditions, storage, preservation, and all analytical procedures, which may include filtration. The purpose of the field blank is to determine if the field or sample transporting procedures and environments have contaminated the sample.
- 18.9 **Field Duplicates (FD1 and FD2)**—Two separate samples collected in separate sample bottles at the same time and place under identical circumstances and treated exactly the same throughout field and laboratory procedures. Analyses of FD1 and FD2 give a measure of the precision associated with sample collection, preservation, and storage, as well as with laboratory procedures.

- 18.10 **Initial Precision and Recovery (IPR)**—Four aliquots of the OPR standard analyzed to establish the ability to generate acceptable precision and accuracy. IPRs are performed before the first time a method is used and any time the method or instrumentation is modified.
- 18.11 **Instrument Detection Limit (IDL)**—The concentration equivalent to the analyte signal which is equal to three times the standard deviation of a series of ten replicate measurements of the calibration blank signal at the selected analytical mass(es).
- 18.12 **Internal Standard**—Pure analyte(s) added to a sample, extract, or standard solution in known amount(s) and used to measure the relative responses of other method analytes that are components of the same sample or solution. The internal standard must be an analyte that is not a sample component (Sections 7.5 and 9.5).
- 18.13 **Laboratory Blank**—An aliquot of reagent water that is treated exactly as a sample including exposure to all glassware, equipment, solvents, reagents, internal standards, and surrogates that are used with samples. The laboratory blank is used to determine if method analytes or interferences are present in the laboratory environment, the reagents, or the apparatus (Sections 7.6.2 and 9.6.1).
- 18.14 **Laboratory Control Sample (LCS)**—See Ongoing Precision and Recovery (OPR) Standard.
- 18.15 **Laboratory Duplicates (LD1 and LD2)**—Two aliquots of the same sample taken in the laboratory and analyzed separately with identical procedures. Analyses of LD1 and LD2 indicates precision associated with laboratory procedures, but not with sample collection, preservation, or storage procedures.
- 18.16 **Laboratory Fortified Blank (LFB)**—See Ongoing Precision and Recovery (OPR) Standard.
- 18.17 **Laboratory Fortified Sample Matrix (LFM)**—See Matrix Spike (MS) and Matrix Spike Duplicate (MSD).
- 18.18 **Laboratory Reagent Blank (LRB)**—See Laboratory Blank.
- 18.19 **Linear Dynamic Range (LDR)**—The concentration range over which the instrument response to an analyte is linear (Section 9.2.3).
- 18.20 **Matrix Spike (MS) and Matrix Spike Duplicate (MSD)**—Aliquots of an environmental sample to which known quantities of the method analytes are added in the laboratory. The MS and MSD are analyzed exactly like a sample. Their purpose is to quantify the bias and precision caused by the sample matrix. The background concentrations of the analytes in the sample matrix must be determined in a separate aliquot and the measured values in the MS and MSD corrected for background concentrations (Section 9.3).
- 18.21 **m/z**—mass-to-charge ratio
- 18.22 **May**—This action, activity, or procedural step is optional.
- 18.23 **May Not**—This action, activity, or procedural step is prohibited.

- 18.24 **Method Blank**—See Laboratory Blank.
- 18.25 **Method Detection Limit (MDL)**—The minimum concentration of an analyte that can be identified, measured, and reported with 99% confidence that the analyte concentration is greater than zero (Section 9.2.1 and Table 1).
- 18.26 **Minimum Level (ML)**—The lowest level at which the entire analytical system gives a recognizable signal and acceptable calibration point (Reference 9).
- 18.27 **Must**—This action, activity, or procedural step is required.
- 18.28 **Ongoing Precision and Recovery (OPR) Standard**—A laboratory blank spiked with known quantities of the method analytes. The OPR is analyzed exactly like a sample. Its purpose is to determine whether the methodology is in control and to assure that the results produced by the laboratory remain within the method-specified limits for precision and accuracy (Sections 7.9 and 9.7).
- 18.29 **Preparation Blank**—See Laboratory Blank.
- 18.30 **Primary Dilution Standard**—A solution containing the analytes that is purchased or prepared from stock solutions and diluted as needed to prepare calibration solutions and other solutions.
- 18.31 **Quality Control Sample (QCS)**—A sample containing all or a subset of the method analytes at known concentrations. The QCS is obtained from a source external to the laboratory or is prepared from a source of standards different from the source of calibration standards. It is used to check laboratory performance with test materials prepared external to the normal preparation process.
- 18.32 **Reagent Water**—Water demonstrated to be free from the method analytes and potentially interfering substances at the MDL for that metal in the method.
- 18.33 **Should**—This action, activity, or procedural step is suggested but not required.
- 18.34 **Stock Standard Solution**—A solution containing one or more method analytes that is prepared using a reference material traceable to EPA, the National Institute of Science and Technology (NIST), or a source that will attest to the purity and authenticity of the reference material.
- 18.35 **Total Recoverable Analyte**—The concentration of analyte determined by analysis of the solution extract of an unfiltered aqueous sample following digestion by refluxing with hot dilute mineral acid(s) as specified in the method (Section 12.2).
- 18.36 **Tuning Solution**—A solution used to determine acceptable instrument performance before calibration and sample analyses (Section 7.7).

Table 1

List of Analytes Amenable to Analysis Using Method 1640: Lowest Water Quality Criterion for Each Metal Species, Method Detection Limits, Minimum Levels, and Recommended Analytical Masses

Metal	Lowest Ambient Water Quality Criterion ($\mu\text{g/L}$) ¹	Method Detection Limit (MDL) and Minimum Level (ML); $\mu\text{g/L}$		Recommended Analytical m/z
		MDL ²	ML ³	
Cadmium	0.32	0.0024	0.01	111
Copper	2.5	0.024	0.1	63
Lead	0.14	0.0081	0.02	206, 207, 208
Nickel	7.1	0.029	0.1	60

1. Lowest of the freshwater, marine, and human health WQC promulgated by EPA for 14 states at 40 *CFR* Part 131 (57 *FR* 60848), with hardness-dependent freshwater aquatic life criteria adjusted in accordance with 57 *FR* 60848 to reflect the worst case hardness of 25 mg/L CaCO₃, and all aquatic life criteria adjusted in accordance with the Oct. 1, 1993 Office of Water guidance to reflect dissolved metals criteria.
2. Method Detection Limit as determined by 40 *CFR* Part 136, Appendix B.
3. Minimum Level (ML) calculated by multiplying laboratory-determined MDL by 3.18 and rounding result to nearest multiple of 1, 2, 5, 10, etc. in accordance with procedures used by EAD and described in the EPA Draft National Guidance for the Permitting, Monitoring, and Enforcement of Water Quality-Based Effluent Limitations Set Below Analytical Detection/Quantitation Levels, March 22, 1994.

**TABLE 2: QUALITY CONTROL ACCEPTANCE CRITERIA FOR PERFORMANCE TESTS
IN EPA METHOD 1640¹**

Metal	Initial Precision and Recovery (Section 9.2)		Calibration Verification (Section 10.5)	Ongoing Precision and Recovery (Section 9.7)	Spike Recovery (Section 9.3)
	s	X			
Cadmium	23	75-121	86-110	73-123	73-123
Copper	43	67-154	77-119	63-159	63-159
Lead	44	56-144	78-122	52-144	52-144
Nickel	27	74-128	87-115	71-130	71-130

1. All specifications expressed as percent.

TABLE 3: ELUENT PUMP PROGRAMMING SEQUENCE FOR PRECONCENTRATION OF TRACE ELEMENTS

Time (min)	Flow (mL/min)	Eluent	Valve A,B	Valve C
0.0	4.0	1M ammonium acetate	ON	ON
4.5	4.0	1.25M HNO ₃	ON	ON
5.1	1.0	1.25M HNO ₃	OFF	ON
5.5	1.0	1.25M HNO ₃	OFF	OFF
7.5	4.0	1.25M HNO ₃	OFF	ON
8.0	4.0	1M ammonium acetate	OFF	ON
10.0	4.0	1.25M HNO ₃	OFF	ON
11.0	4.0	1M ammonium acetate	OFF	ON
12.5	0.0		OFF	ON

TABLE 4: RECOMMENDED ANALYTICAL ISOTOPES AND ELEMENTAL EQUATIONS FOR DATA CALCULATIONS

Element	Isotope	Elemental Equation	Note
Cd	106,108, <u>111</u> ,114	$(1.000)(^{111}\text{C}) - (1.073)[(^{108}\text{C}) - (0.712)(^{106}\text{C})]$	(1)
Cu	<u>63</u> ,65	$(1.000)(^{63}\text{C})$	
Pb	<u>206</u> , <u>207</u> , <u>208</u>	$(1.000)(^{206}\text{C}) + (1.000)(^{207}\text{C}) + (1.000)(^{208}\text{C})$	(2)
Ni	60	$(1.000)(^{60}\text{C})$	

C—counts at specified m/Z.

(1)—correction for MoO interference. An additional isobaric elemental correction should be made if palladium is present.

(2)—allowance for variability of lead isotopes.

NOTE: As a minimum, all isotopes listed should be monitored. Isotopes recommended for analytical determination are underlined.

TABLE 5: RECOMMENDED INSTRUMENTAL OPERATING CONDITIONS

Chromatography

Instrument	Dionex chelation system
Preconcentration column	Dionex MetPac CC-1

ICP-MS Instrument Conditions

Instrument	VG PlasmaQuad Type I
Plasma forward power	1.35 kW
Coolant flow rate	13.5 L/min
Auxiliary flow rate	0.6 L/min
Nebulizer flow rate	0.78 L/min

Internal standards	Sc, Y, In, Tb
--------------------	---------------

Data Acquisition

Detector mode	Pulse counting
Mass range	45–240 amu
Dwell time	160 μ s
Number of MCA channels	2048
Number of scan sweeps	250

Figure 1. Configuration of Preconcentration System

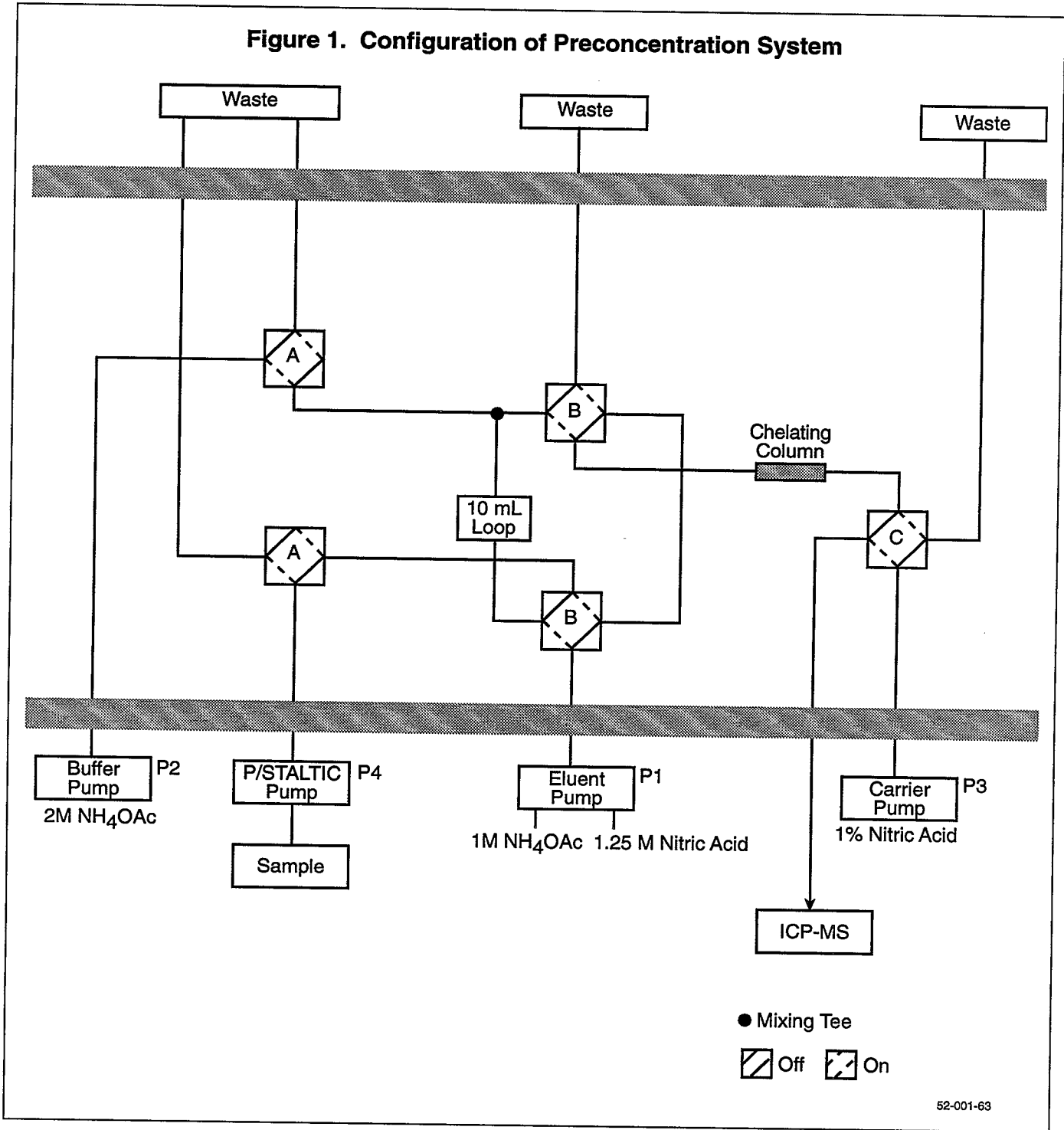

52-001-63

Annex V:

HELCOM

Manual for marine monitoring in the COMBINE programme

**ANNEX B-11 APPENDIX 2: TECHNICAL ANNEX ON THE DETERMINATION OF
HEAVY METALS AND PERSISTENT ORGANIC COMPOUNDS IN SEAWATER
TECHNICAL NOTE ON THE DETERMINATION OF PERSISTENT ORGANIC
POLLUTANTS IN SEAWATER**

HELCOM Manual for marine monitoring in the COMBINE programme**ANNEX B-11 APPENDIX 2: TECHNICAL ANNEX ON THE DETERMINATION OF HEAVY METALS AND PERSISTENT ORGANIC COMPOUNDS IN SEAWATER****TECHNICAL NOTE ON THE DETERMINATION OF PERSISTENT ORGANIC POLLUTANTS IN SEAWATER****1. INTRODUCTION**

These guidelines concentrate on the sampling and extraction of lipophilic persistent organic pollutants from seawater and special aspects of the sampling matrix. This group of pollutants comprises the group of polycyclic aromatic hydrocarbons (PAHs) and chlorinated hydrocarbons (e.g., HCH, HCB, DDT group, chlorinated biphenyls (PCBs)).

For general aspects and the analytical determination, reference is made to the following guidelines:

- "Determination of Polycyclic Aromatic Hydrocarbons (PAHs) in Sediments: Analytical Methods", ICES ACME Report 1997;
- "Guidelines for the determination of chlorobiphenyls in sediments: Analytical methods", ICES ACME Report 1996;
- "Determination of Polycyclic Aromatic Hydrocarbons (PAH)s in Biota", ICES ACME Report 1998; and
- Annex B-14 (these Guidelines).

As the same analytical methods can be used for the determination of lipophilic pollutants in extracts of water samples as are used for extracts of sediments, it is felt that it is a useful way to unify analytical procedures to refer to these publications only.

However, it should be taken into consideration (e.g., for calibration) that the relative concentrations of the individual pollutants are generally quite different in water and sediment samples. The concentration patterns of the pollutants are mainly influenced by their polarity which can be expressed by their octanol/water coefficient ($\log K_{ow}$; $K_{ow} = \text{Concentration in octanol phase} / \text{Concentration in aqueous phase}$). Thus, in water samples the more hydrophilic compounds with $\log K_{ow}$ values of 3 to 4 predominate (e.g., 2- and 3-ring aromatics and HCH isomers), while in sediments and biota the pollutants with $\log K_{ow}$ values >5 are enriched (4- to 6-ring aromatics, DDT group, PCBs).

These guidelines provide advice on lipophilic persistent organic pollutant (POPs) analyses in total seawater with a $\log K_{ow} > 3$. The analysis of POPs generally includes:

1. • sampling and extraction of the water;
2. • clean-up; and
3. • analytical determination.

The extraction of the POPs simultaneously enables an enrichment of the analytes. Because of the very low concentration range of 10 pg l^{-1} to 10 ng l^{-1} , the enrichment of the contaminants is a very important step in the procedure. Extraction and enrichment can be done by solid phase extraction (SPE) or liquid-liquid extraction (LLE).

Determination depends on the chemical structure of the compounds. PAHs can be determined by high performance liquid chromatography (HPLC) with fluorescence detection or gas chromatographic (GC) separation with flame ionization (FID) or mass spectrometric (MS) detection (Fetzer and Vo-Dinh, 1989; Wise et al., 1995). Chlorinated hydrocarbons are generally analysed by gas

chromatographic (GC) separation with electron capture detectors (ECD) or mass spectrometric (MS) detection.

All steps of the procedure are susceptible to insufficient recovery and/or contamination. Therefore, regular quality control procedures must be applied to check the performance of the whole method. These guidelines are intended to encourage and assist analytical chemists to critically reconsider their methods and to improve their procedures and/or the associated quality control measures, where necessary.

These guidelines are not intended as a complete laboratory manual. If necessary, guidance should be sought from specialized laboratories. Whichever procedure is adopted, each laboratory must demonstrate the validity of each step of its procedure. In addition, the use of a second (and different) method, carried out concurrently to the routine procedure, is recommended for validation. The participation in analytical proficiency tests is highly recommended.

2. SAMPLING AND STORAGE

Plastic materials must not be used for sampling and storage owing to possible adsorption on the container material or contamination. Especially the very lipophilic compounds (4- to 6-ring aromatic hydrocarbons, DDT, PCBs) tend to adsorb on every surface. Therefore, the seawater samples should not be stored longer than 2 h and should not be transferred into other containers before extraction. It is highly recommended to extract the water sample as soon as possible after sampling and to use as little manipulation as possible. It is recommended that sampling and extraction should be done in the same device. Extracts in organic solvents are less susceptible to adsorption onto surfaces.

3. BLANKS AND CONTAMINATION

In many cases, the procedural detection limit is determined by the blank value. In order to keep the blank value as low as possible, the compounds to be analysed or other interfering compounds should be removed from all glassware, solvents, chemicals, adsorption materials, etc., that are used in the analysis. The following procedures should be used:

- Glassware should be thoroughly washed with detergents and rinsed with an organic solvent prior to use. Further cleaning of the glassware, other than calibrated instruments, can be carried out by heating at temperatures > 250 °C.
- All solvents should be checked for impurities by concentrating the amount normally used to 10 % of the normal end volume. This concentrate is then analysed in the same way as a sample by HPLC or GC and should not contain significant amounts of the compounds to be analysed or other interfering compounds.
- All chemicals and adsorption materials should be checked for impurities and purified (e.g., by heating or extraction), if necessary. Soxhlet thimbles should be pre-extracted. Glassfiber thimbles are preferred over paper thimbles. Alternatively, full glass Soxhlet thimbles, with a G1 glass filter at the bottom, can be used. The storage of these supercleaned materials for a long period is not recommended, as laboratory air can contain PAHs that will be adsorbed by these materials. Blank values occurring despite all the above-mentioned precautions may be due to contamination from the air. The most volatile compounds will usually show the highest blanks (Gremm and Frimmel, 1990).

As the concentrations of the PAHs and chlorinated hydrocarbons in seawater are very low, possible blank and contamination problems might be even more difficult to control than with sediment samples. Therefore, it is recommended to rewash all equipment (vials, pipettes, glass bottles) with solvent just before use. If possible, critical steps should be done in a clean bench.

The more volatile compounds (especially naphthalene and phenanthrene) show the largest blank problems.

4. PRE-TREATMENT

For the extraction of whole water samples, no pre-treatment is necessary.

If the suspended particulate material (SPM) will be analysed separately from the solute phase, a phase separation has to be done. Because of the necessary additional manipulation step, this is a difficult operation which affords a number of additional quality control procedures (adsorption losses, contamination problems). There are two possible ways for phase separation: filtration and centrifugation.

Filtration is done by GF/F glass fibre filters. As flat-bed filters have a very limited capacity, the use of coiled glass fibre filters is recommended for volumes larger than 10 l and water samples with high amounts of suspended matter. A pump is necessary to force the water through the filter.

Centrifugation needs a high volume centrifuge which must be operable onboard a ship. Such centrifuges with a throughput of 1 m³ h⁻¹ and more are commercially available and used for sampling SPM; however, they are expensive and generally not a standard equipment. For centrifugation, blanks and adsorption problems have to be controlled as well as the separation efficiency.

The sampled SPM is analysed like a sediment. The solute phase is analysed like the whole water sample.

Validation of the phase separation procedures is very difficult; thus, it might be wise to analyse the whole water sample for monitoring purposes and to determine separately only the amount of SPM in the water for reference or normalization purposes.

5. EXTRACTION

The volume of the water sample is the most important parameter which influences the limit of determination of the method. As POP concentrations down to 10 pg l⁻¹ and less are observed in seawater, large water volumes of 10 l to 100 l have to be sampled and extracted. Large volumes are required not only to obtain a sufficiently high detector signal, but also to discriminate from blank problems.

Principally, there are two different extraction principles in current use: solid phase extraction (SPE) and liquid-liquid extraction (LLE). Unfortunately, the two procedures do not always yield comparable results, as the physical extraction principles are quite different (Sturm et al., 1998, Gomez-Belinchon et al., 1988).

SPE has the advantage of being able to extract very large water volumes (up to 1000 l) and to incorporate a phase separation to obtain separate samples for SPM and the solute phase. The drawbacks of the method are a longer sampling time demand, a more complex instrumentation, and problems with validation and control of the extraction efficiency.

LLE has the advantage that it can be easily validated and controlled, as internal standards can be added before extraction. Also, standard addition techniques can be used for accuracy testing. As LLE is a classical extraction technique, a great deal of experience is available and the robustness of the principle is proven. The limitation in sample volume is only relative, as techniques have been described for sampling 10 l and 100 l on a routine basis (Gaul and Ziebarth, 1993; Theobald et al., 1990). It has been shown that a sampling volume of 100 l is sufficient for nearly all monitoring tasks.

Because of the robustness of the method, there is a preference LLE for routine monitoring purposes for all lipophilic organic contaminants.

5.1 Solid phase extraction

The extraction device consists of a filter holder, an adsorption column filled with an adsorbing material (e.g., XAD resin, C18 modified silica gel), a pump which forces the water sample through the column, a flow meter, an electronic control unit, and a power supply. Sampling can be done either by deploying the whole extraction device into the water (in situ pumping) or by pumping the water with a separate pump onboard a ship and then through the extraction device. A suitable in situ system is described in detail in Patrick et al. (1996). After sampling, the columns are stored at 4 °C and the filters at -20 °C.

The adsorption column is eluted with an organic solvent (acetone or acetonitril). Prior to the extraction, internal standards are added to the solvent. The extract obtained is pre-cleaned and analysed.

Analytical procedures for the use of XAD-2 adsorption resins are published by the IOC (1993), Ehrhardt (1987), and Bruhn and McLachlan (2001).

Although the SPE technique has many advantages, one has to be aware of some problems. Especially for large volume sampling, validation of the method is extremely difficult and has not yet been achieved. Some publications have shown that the extraction efficiency is dependent on, e.g., the amount and kind of humic substances which can complex lipophilic compounds (Johnson et al., 1991; Kulovaara, 1993; Sturm et al., 1998).

5.2 Liquid-liquid extraction

The decision to sample 10 l, 20 l, or 100 l of water depends on the anticipated concentrations of the compounds to be analysed in natural samples. For remote sea areas with expected concentration of pg l^{-1} or less, a volume of 100 l is recommended. The technique and principle are identical for all volumes, only the sampling bottle and the equipment are different. Details of the sampling and extraction techniques are described in Gaul and Ziebarth (1993) for the 10 l sampler and in Theobald et al. (1990) for the 100 l sampler.

The all-glass bottle sampler fixed in a stainless steel cage is lowered by a hydrographic wire down to the sampling depth and opened under water. After filling, the sampler is brought on deck of the ship and immediately extracted with a non-polar solvent such as pentane or hexane. Prior to extraction, a solution with appropriate internal standards (e.g., deuterated PAHs, e-HCH, PCB 185) is added to the water sample. After phase separation, the organic extract is dried with Na_2SO_4 and carefully concentrated to about 1 ml in a rotary evaporator. Further evaporation is done under a gentle stream of nitrogen.

Extreme care has to be taken to avoid contamination during sampling, extraction, and work up. Blank samples must be taken in every sampling campaign; this can be done, e.g., by rinsing the cleaned sampling bottle with the extraction solvent and treating this extract like a normal sample. The sampling bottle must be cleaned with detergent, water, and organic solvents (acetone and hexane or pentane) before use. After using in open sea areas, it can be of advantage not to perform the whole cleaning/washing procedure but just to use the sampler directly after emptying the glass bottle from the extracted previous water sample.

Extracts should be stored in the refrigerator and in the dark.

6. CLEAN-UP

Interferences from matrix compounds in seawater samples are generally smaller than in sediment or biota samples. Nevertheless, the crude extracts require a clean-up before chromatographic separation and determination can be done. The clean-up is dependent on the compounds to be analysed, the

sample, the determination method used, and the concentration range to be analysed. For all GC methods, it is essential to remove polar and non-volatile compounds in order to protect the GC column from rapid destruction. A detection system with low selectivity (eg., GC-FID) needs a far better clean-up than a detector with a high selectivity such GC-MS or even GC-MS/MS. HPLC with fluorescence detection (for PAH analyses) has a relative high selectivity but the method will fail if petrogenic aromatic compounds (from an oil spill) are present in the sample. GC-ECD (for chlorinated compounds) has a high selectivity but some interferences (e.g., phthalate esters) may disturb the detection; therefore, for GC-ECD a good clean-up is necessary as well.

A clean-up procedure for this is presented here that uses short silica gel chromatography columns that can be applied with any determination technique: HPLC, GC or GC-MS. The method is simple and is sufficient in most cases of PAH and chlorinated hydrocarbon determinations in seawater (ICES, 1996, 1997, 1999).

A 3 ml glass column with glass fibre frit (commercially available for SPE) is filled with 500 mg silica gel (dried for 2 h at 200° C) and subsequently washed with 30 ml CH₂Cl₂ and 30 ml hexane. The hexane sample extract (concentrated to 500 µl) is applied on top of the column and eluted with 5 ml CH₂Cl₂/hexane (15/85 v/v) and then with 5 ml of acetone. Fraction 1 contains all lipophilic compounds of interest (PAHs and all chlorinated hydrocarbons (from HCB to HCH)); this fraction can be used for GC-MS determination after concentration to 50–300 µl.

If the water sample has been extremely rich in biological material (algae) or if detection limits far below 10 pg l⁻¹ are requested, additional clean-up (HPLC, GPC) might become necessary.

7. CHROMATOGRAPHIC DETERMINATION

Details for the chromatographic determinations are comprehensively described in the 1996 ACME report (ICES, 1996) for chlorobiphenyls in sediments (GC-ECD and GC-MS), the 1997 ACME report (ICES, 1997) for PAHs in sediments (HPLC-Fluorescence detection, GC-FID and GC-MS), and the 1998 ACME report (ICES, 1999) for PAHs in biota (HPLC and GC-MS).

As the cleaned extracts from the seawater samples can be analysed in the same way as the extracts from sediments and biota, the above guidelines can be used. When a GC-MS system can be used, all compounds can be determined in one single GC analysis; if not, the samples have to be analysed separately for PAHs (HPLC-F, GC-FID) and chlorinated hydrocarbons (GC-ECD).

7.1 Gas chromatography-mass spectrometry

As GC-MS has the advantage of being both very selective and quite universal, it is strongly recommended to use GC-MS as the determination method. It especially has the advantage that both PAHs and chlorinated hydrocarbons can be determined in one single analysis. This is not possible with any of the other techniques.

Because of the sensitivity required, the mass spectrometric detector must be operated in the selected ion mode (SIM). By this, absolute sensitivities in the range of 1 pg to 10 pg can be achieved for most compounds. Ion-trap instruments can be operated in full-scan mode and are in principle as sensitive as quadrupole detectors; however, with real samples and matrix underground they can lose considerably sensitivity.

With GC-MS, detection limits of 5–30 pg l⁻¹ can be reached with water sample volumes of 10 l to 100 l. In most cases, it is not the absolute signal strength of the detector which limits the detection; therefore, the injection of a larger aliquot of the analysis solution would not improve it. For some compounds, blank values are the limiting parameter (especially naphthalene and phenanthrene and, to a lesser extent, other PAHs); for this, only a larger sample volume can improve the detection limits. Many other compounds do not exhibit blank problems, if appropriate care is applied; for these, matrix

noise often limits the detection. For such situations, only a better clean-up (e.g., HPLC, GPC) or a more specific detection method (GC-NCI-MS or GC-MS/MS) will improve the detection limit. Negative chemical ionization (NCI) mass spectrometric detection can be used for highly chlorinated compounds (e.g., HCB, PCBs with five or more Cl atoms, HCH) and shows extremely high sensitivity and selectivity for these compounds. More universally applicable is tandem mass spectrometry (MS/MS), which yields a similar absolute sensitivity as normal MS but much higher selectivity. Some MS/MS transitions for the detection of selected chlorinated hydrocarbons are listed in Table 1 in Appendix 2 to Annex B-13: Technical note on the determination of polycyclic aromatic hydrocarbons in biota, from the full "Guidelines".

7.2 Quantification

A multilevel calibration with at least five concentration levels is recommended. The response of the FID detector is linear. For UV and fluorescence detection, the linear range is also large. The working range should be linear and must be covered by a calibration curve.

Since the mass spectrometric detector often has no linear response curve, the use of stable deuterated isotopes is a prerequisite. Furthermore, the response of PAHs in standard solutions is often much lower than in sample extracts. Only a combination of different techniques, e.g., the use of internal standards and standard addition, might give reliable quantitative results.

The calibration curve can be checked by recalculating the standards as if they were samples and comparing these results with the nominal values. Deviations from the nominal values should not exceed 5%.

When chromatograms are processed using automated integrators, the baseline is not always set correctly, and always needs visual inspection. Because the separation of the peaks is often incomplete in HPLC analysis, the use of peak heights is recommended for quantification. In case of GC techniques, either peak heights or peak areas can be used.

Prior to running a series of samples and standards, the GC or HPLC systems should be equilibrated by injecting at least one sample extract, the data from which should be ignored. In addition, standards used for multilevel calibration should be regularly distributed over the sample series so matrix- and non-matrix-containing injections alternate. A sample series should include:

- a procedural blank,
- a laboratory reference material,
- at least five standards,
- one standard that has been treated similarly to the samples (recovery determination).

The limit of determination should depend on the purpose of the investigation. A limit of 2 ng g⁻¹ (dry weight) or better should be attained for single compounds. The method for calculating the limit of determination should reflect QUASIMEME advice (Topping et al., 1992). The limit of determination that can be achieved depends on the blank, the sample matrix, concentrations of interfering compounds, and the volume of water taken for analysis. The typical concentration ranges of PAHs and other POPs in seawater can be found in HELCOM assessments (HELCOM, 2003a, 2003b).

8. QUALITY ASSURANCE

A number of measures should be taken to ensure a sufficient quality of the analysis. Five main areas can be identified:

1. extraction efficiency and clean-up;

2. calibrant and calibration;
3. system performance;
4. long-term stability; and
5. internal standards.

8.1 Extraction efficiency and clean-up

A check on extraction efficiency and clean-up can be performed by analysing a reference material (Annex B-7). To determine the recovery rates of the clean-up and concentration steps, it is recommended to pass a standard solution through the entire procedure. Additionally, at least one internal standard should be added to each sample before extraction, to check for recovery during the analytical procedures. If major losses have occurred, then the results should not be reported. CB29 is suggested as a recovery standard because, owing to its high volatility, losses due to evaporation are easily detected. CB29 elutes relatively late from alumina and silica columns. Small peaks that may be present in the gas chromatogram at the retention time of CB29 do not hinder the use of this CB because the recovery standard only indicates major errors in extraction or clean-up. In case of GC/MS, labelled CBs can be used as recovery standards. This allows correction for recovery, provided that each chlorination stage is represented.

8.2 Calibrant and calibration

PAH determinations should preferably be carried out using calibration solutions prepared from certified crystalline PAHs. However, the laboratory should have the appropriate equipment and expertise to handle these hazardous crystalline substances. Alternatively, certified PAH solutions, preferably from two different suppliers, can be used. Two independent stock solutions should always be prepared simultaneously to allow cross-checks to be made. Calibration solutions should be stored in ampoules in a cool, dark place. Weight loss during storage should be recorded for all standards.

CB determinations should always be carried out using calibration solutions prepared from crystalline CBs. Preferably, certified CBs should be used. Two independent stock solutions of different concentrations should always be prepared simultaneously to allow a cross-check to be made. Calibration solutions should preferably be stored in a cool, dark place. For all containers with standards, the weight loss during storage should be recorded.

After clean-up and before GC analysis, both in PAH and CB analysis, an additional internal standard is added for volume correction. Internal standards should be added in a fixed volume or weighted to all standards and samples.

8.3 System performance

The performance of the HPLC or GC system can be monitored by regularly checking the resolution of two closely eluting PAHs or CBs. A decrease in resolution indicates deteriorating HPLC or GC conditions. The signal-to-noise ratio of a low concentration standard yields information on the condition of the detector. For example, a dirty MS-source can be recognized by the presence of a higher background signal, together with a reduced signal-to-noise ratio. Additionally, the peak can be affected.

8.4 Long-term stability

One laboratory reference sample should be included in each series of samples. A quality control chart should be recorded for selected PAHs, e.g., fluoranthene (stable results), pyrene (sensitive to quenching), benzo[a]pyrene (sensitive to light), or, correspondingly, for selected CBs. If the warning

limits are exceeded, the method should be checked for possible errors. When alarm limits are exceeded, the results obtained should not be reported.

A certified reference material (CRM) should be analysed at least once a year, when available, and each time the procedure is changed. Each laboratory analysing PAHs and CBs in water should participate in interlaboratory analytical performance tests on a regular basis.

8.5 Internal standards

Internal standards should be added to all standards and samples either in a fixed volume or by weight. The PAH internal standards should preferably be non-natural PAHs which are not found in water and do not co-elute with the target PAHs; several predeuterated PAHs have proved to be suitable for GC/MS as well as for HPLC analysis. For example, for GC/MS it is recommended to add four internal standards representing different ring-sizes of PAHs.

The following compounds can be used (Wise et al., 1995):

- for HPLC analysis: phenanthrene-d10, fluoranthene-d10, perylene-d12, 6-methyl-chrysene;
- for GC/MS analysis: naphthalene-d8, phenanthrene-d10, chrysene-d12, perylene-d12;
- for GC/FID analysis: 1-butylpropylene, m-tetraphenyl.

Similarly the ideal internal standard for PCBs is a compound which is not found in the samples and does not co-elute with other CBs, e.g., CBs 29, 112, 155, 198 or all 2,4,6-substituted CB congeners. Alternatively, 1,2,3,4-tetrachloronaphthalene can be used.

9. REFERENCES

Bruhn, R., and McLachlan, M.S. 2001: Seasonal variation of polychlorinated biphenyl concentrations in the southern part of the Baltic Sea. *Marine Pollution Bulletin*, in press

Ehrhardt, M., 1987: Lipophilic organic material: An apparatus for extracting solids used for their concentration from sea water. *ICES Techniques in Marine Environmental Sciences*, 4.

Fetzer, J.C., and Vo-Dinh, T. 1989: *Chemical analysis of polycyclic aromatic compounds*. Wiley, New York.

Gaul, H., and Ziebarth, U., 1993: Method for the analysis of lipophilic compounds in water and results about the distribution of different organochlorine compounds in the North Sea. *Dt. Hydrog. Z.*, 36: 191–121.

Gomez-Belinchon, J.I., Grimalt, J.O., and Albeiges, J. 1988, *Environmental Science and Technology*, 22: 677–685.

HELCOM. 2003a. Fourth Periodic Assessment of the State of the Baltic Sea Environment, 1994–1998. *Baltic Sea Environmental Proceedings*, No. 82B. 218 pp.

HELCOM. 2003b. The Baltic Marine Environment 1999–2002. *Baltic Sea Environmental Proceedings*, No. 87. 48 pp.

ICES. 1996. Guidelines for the determination of chlorobiphenyls in sediments: Analytical methods. In *Report of the ICES Advisory Committee on the Marine Environment, 1996*. ICES Cooperative Research Report, 217: 100–104. Manual for marine monitoring in the COMBINE programme 128

ICES. 1997: Determination of polycyclic aromatic hydrocarbons (PAHs) in sediments: Analytical methods. In *Report of the ICES Advisory Committee on the Marine Environment, 1997*. ICES Cooperative Research Report, 222: 118–124.

ICES. 1999. Determination of polycyclic aromatic hydrocarbons (PAHs) in biota In Report of the ICES Advisory Committee on the Marine Environment, 1998. ICES Cooperative Research Report, 233: 230–237.

IOC. 1993: Chlorinated biphenyls in open ocean waters: sampling, extraction, clean-up and instrumental determination. Manual and Guides No. 27. UNESCO Press, Paris

Johnson, W.E., Fendinger, N.J., and Plimmer, J.R. 1991: Solid-phase extraction of pesticides from water: Possible interferences from dissolved organic material. *Analytical Chemistry*, 63: 1510–1513.

Kulovara, M., 1993. Distribution of DDT and Benzo[a]pyrene between water and dissolved organic matter in natural humic water. *Chemosphere*, 27: 2333–2340.

Patrick, G., Schulz-Bull, D.E., Martens, V., Scholz, K., and Duinker, J.C. 1996: An in-situ filtration/extraction system for the recovery of trace organics in solution and on particles – tested in deep ocean water. *Marine Chemistry*, 54: 97–105.

Sturm, B., Knauth, H.D., Theobald, N., and Wünsch, G. 1998. Hydrophobic organic micropollutants in samples of coastal waters: efficiencies of solid-phase extraction in the presence of humic substances. *Fresenius Journal of Analytical Chemistry*, 361: 803–810.

Theobald, N., Lange, W., Rave, A., Pohle U., and Koennecke, P. 1990: Ein 100-l Glaskugelschöpfer zur kontaminationsfreien Entnahme von Seewasser für die Analyse lipophiler organischer Stoffe. *Dt. Hydrogr. Z.*, 43: 311.

Topping G. 1992: The role and application of quality assurance in marine environmental protection. *Marine Pollution Bulletin*, 25(1-4): 61–66.

Wise, S.A., Schantz, M.M., Brenner, B.A., Hays, M.J., and Schiller, S.B. 1995: Certification of polycyclic aromatic hydrocarbons in a marine sediment standard reference material. *Analytical Chemistry*, 67: 1171–1178.

Last updated: 29.10.2012 (Annex number changed from Annex B 12 to Annex B 11)

Annex VI:

**Sample work-up for the analysis of selected chlorinated
hydrocarbons in the marine environment**



UNITED NATIONS ENVIRONMENT PROGRAMME

November 2011

Sample work-up for the analysis of selected chlorinated hydrocarbons in the marine environment

Recommended Methods For Marine Pollution Studies 71

Prepared in co-operation with



NOTE: This recommended method is not intended to be an analytical training manual. Therefore, the method is written with the assumption that it will be used by formally trained analytical chemists. Several stages of this procedure are potentially hazardous; users should be familiar with the necessary safety precautions.

For bibliographic purposes this document may be cited as:

UNEP/IAEA: Sample work-up for the analysis of selected chlorinated hydrocarbons in the marine environment. Reference Methods for Marine Pollution Studies No 71, UNEP, 2011.

PREFACE

The Regional Seas Programme was initiated by UNEP in 1974. Since then, the Governing Council of UNEP has repeatedly endorsed a regional approach to the control of marine pollution and the management of marine and coastal resources and has requested the development of regional action plans. The Regional Seas Programme at present includes thirteen regions and has over 140 coastal States participating in it (1).

One of the basic components of the action plans sponsored by UNEP in the framework of the Regional Seas Programme is the assessment of the state of the marine environment, its resources and the sources and trends of the pollution and its impact on human health, marine ecosystems and amenities. In order to assist those participating in this activity and to ensure that the data obtained through this assessment can be compared on a world-wide basis and thus contribute to the Global Environment Monitoring System (GEMS) of UNEP, a set of Reference Methods and Guidelines for marine pollution studies are being developed as part of a programme of comprehensive technical support which includes the provision of expert advice, reference methods and materials, training and data quality assurance (2). The Methods recommended for adoption by Governments participating in the Regional Seas Programme.

The methods and guidelines are prepared in co-operation with the relevant specialised bodies of the United Nations system as well as other organisations and are tested by a number of experts competent in the field relevant to the methods described.

In the description of the methods and guidelines, the style used by the International Organisation for Standardisation (ISO) has been followed as closely as possible.

The methods and guidelines published in UNEP's series of Reference Methods for Marine Pollution Studies are not considered as definitive. They are planned to be periodically revised taking into account the new developments in analytical instrumentation, our understanding of the problems and the actual need of the users. In order to facilitate these revisions, the users are invited to convey their comments and suggestions to:

Marine Environmental Studies Laboratory
IAEA Environment Laboratories
4, Quai Antoine 1^{er}
MC 98000 MONACO

which is responsible for the technical co-ordination of the development, testing and inter-calibration of Reference Methods.

References:

(1) www.unep.org/regionalseas (2011)

(2) UNEP/IAEA/IOC: Reference Methods and Materials: A Programme of comprehensive support for regional and global marine pollution assessment. UNEP, 1990.

CONTENTS

	Page
1. Scope and field of application	1
2. Principles	1
3. Reagents, solvents, standards	1
3.1. Reagents	1
3.1.1. List of reagents	1
3.1.2. Cleaning of solvents	3
3.1.3. Cleaning of reagents and adsorbents	3
3.1.3.1. Cleaning of reagents	3
3.1.3.2. Cleaning of adsorbents	4
3.2. Apparatus and equipment	4
3.2.1. List of materials	4
3.2.2. Cleaning of glassware	5
4. Sediments	7
4.1. Sampling	7
4.2. Cleaning of extraction thimbles	7
4.3. Extraction of sediment	7
4.3.1. Extraction of freeze-dried samples	7
4.3.2. Extraction of wet samples	7
4.3.3. Example of determination of percent moisture	8
4.4. Concentration of the extract	8
4.5. Extractable organic matter	9
4.6. Clean-up procedure and fractionation	10
4.6.1. Sulphur and sulphur compounds removal	10
4.6.2. Fractionation	11
4.6.2.1. Florisil	11
4.6.2.2. Gel permeation chromatography	13
4.6.2.3. Alumina and HPLC (silica column)	13
4.6.2.4. High pressure chromatography	13
5. Biota	14
5.1. Sampling	14
5.2. Cleaning of extraction thimbles	14
5.3. Extraction of tissues	16
5.3.1. Extraction procedure for freeze-dried samples	16
5.3.2. Extraction procedure without freeze-drying	16
5.4. Concentration of the extract	16
5.5. Extractable organic matter (EOM)	16
5.6. Clean-up procedure and fractionation	16
5.6.1. Removal of lipids by concentrated sulphuric acid	16
5.6.2. Fractionation	16
6. Capillary Gas chromatographic determinations	17
6.1. Gas chromatography conditions	17
6.2. Column preparation	17
6.3. Column test	18
6.4. Electron capture detector	19
6.5. Quantification	19
7. Computerized gas chromatography/Mass spectrometry (GC/MS)	20
7.1. Operating conditions	20
7.2. Example of a selected ion monitoring programme useful for quantitative analysis of chlorinated compounds	25
8. Notes on water analysis	25
9. Alternative procedures	25
9.1. Combining sample preparation and extraction for chlorinated and petroleum hydrocarbons	25
9.2. Supercritical fluid extraction (SFE) of marine samples	26
9.3. Microwave assisted extraction for marine samples	28
9.3.1. Sediment	28
9.3.2. Biota	28

10. Data interpretation	29
10.1. DDT	29
10.2. PCBs congeners	29
10.3. Typical profiles of commercial mixtures	30
11. Quality assurance / quality control	31
11.1. Precision	31
11.2. Accuracy	31
11.3. Blanks	31
11.4. Recovery	31
11.5. Archiving and reporting of results	31
12. References	34
Annex:	
Explanations sent to all laboratories with sets of standard provided by IAEA-EL/MESL.	36

1. SCOPE AND FIELD OF APPLICATION

This reference method is intended for use in monitoring programmes and pilot research studies. The document describes procedures for the isolation of purified fractions amenable for the determination of DDTs and PCBs in marine sediments and marine organisms by capillary GC/ECD. It is assumed that most of the participants in the UNEP Regional Seas Programmes are equipped with advanced high resolution capillary gas chromatographs and will be able to implement most, if not all, of the procedures described in Reference Method No 40, "Determination of DDTs and PCBs by capillary gas chromatography and electron capture detection" (UNEP 1988). Assuming consistent results are routinely being obtained with these methods by the analytical laboratory, the determination of specific compounds (as opposed to generic mixture of PCBs) opens up the possibility not only of identifying environmental "hot spots", but also for characterising sources, elucidating transport pathways and developing data of greater toxicological relevance. The organisation and content of this document, however, deserves further comment. Under the sections devoted to SEDIMENTS and ORGANISMS, subsections are provided relating to procedures for: 1) Sampling, 2) Extraction and 3) Clean-up and fractionation. In each subsection, several alternative procedures are described. These various procedures have been previously tested and are provided to accommodate the range of capabilities in participating laboratories. For example, laboratories which have access to an HPLC may consider the benefits of using HPLC fractionation procedures in lieu of more conventional low pressure column chromatographic method. Participants are generally encouraged to implement the most effective procedures within the constraints of their individual laboratories.

Several other halogenated pesticides and other electron capturing organic compounds may be present in environmental samples and many of these compounds could also be isolated by the methods described here. However, not all residues will be stable to the clean-up procedures applied for the determination of PCBs and DDTs. Consequently, every analyst must test for analyte recovery and analytical reproducibility prior to applying these methods for other analytes on a routine basis. Primary emphasis should be placed on obtaining the cleanest possible purified fraction for capillary GC/ECD analysis so that interferences and misidentification are minimised, if not eliminated.

2. PRINCIPLES

Following collection of sediment or biota samples using appropriate techniques, samples are stored in trace organic free vessels at -20°C until analysis. For analysis, the samples are prepared for solvent extraction. To achieve a satisfactory recovery of the chlorinated hydrocarbons, samples are dried by either desiccation with anhydrous sodium sulphate or by freeze-drying. Lipids are then Soxhlet extracted from sediments using hexane and dichloromethane, and from biota using hexane or petroleum ether. Following initial clean-up treatments (removal of sulphur from sediment extracts and treatment of biota extracts with concentrated sulphuric acid to destroy some interfering lipids), extracts are fractionated using column chromatography. Detailed protocols for absorption chromatographic fractionation are described for both low and high pressure systems, using Florisil and silica gel respectively. (Additional information concerning alternative techniques including gel permeation chromatography is provided).

3. REAGENTS, SOLVENTS, STANDARDS

3.1. Reagents

3.1.1. List of reagents

- Demineralized distilled water produced by distillation over potassium permanganate (0.1 g/l KMnO₄) or equivalent quality, demonstrated to be free from interfering substances.
- Detergent.
- Potassium dichromate.
- HCl. 32%.
- Concentrated H₂SO₄ (d 20°C: 1.84 g/ml).
- Sulfochromic cleaning solution made from concentrated sulphuric acid and potassium

- dichromate.
- KOH.
 - Anhydrous sodium sulphate.
 - Copper fine powder (particle size 63µm).
 - Carborundum boiling chips.
 - Hg.
 - Glass wool
 - Alumina (200-240).
 - Silica gel (60-100).
 - Florisil PR (60-100).
 - Bio-Beads SX-3 (200-400).
 - Sephadex LX-20.

Solvents:

- Hexane, Dichloromethane, Methanol, Pentane, Cyclohexane, Toluene and Ethyl Acetate, all "distilled in glass" quality.

Standards:

- PCB congeners: 29, 30, 121, 198.
- ε HCH.
- Endosulfan Id₄.
- n-C₁₄ d₃₀, n-C₁₉ d₄₀, n-C₃₂ d₆₆.
- Naphthalene d₈.
- Hexamethylbenzene.
- Cadalene: 1, 6-dimethyl-4-(1-methylethyl)naphthalene.
- DDT reference solutions - Prepare a stock solution of the DDT series (pp' DDT, op DDT, pp' DDD, op DDD, pp' DDE, op DDE) by dissolving 50 mg of each compound in 100 ml of hexane. Store stock solution in sealed glass ampoules.
- Other reference solutions - should be prepared if other residues are to be quantified in these procedures.

NOTES:

Working solutions obtained from the stock reference solutions should be prepared on a regular basis depending on their use and stored in clean glass volumetric flasks tightly capped with non-contaminating materials such as Teflon or glass. Extreme care must be taken to ensure that the concentrations of the standards have not altered due to solvent evaporation.

In order to achieve acceptable accuracy for the standard solutions, at least 50 mg of pure individual compound should be weighed and dissolved into 100 ml of hexane. This will give stock solutions of 500ng/µl.

Example of preparation of stock solutions:

Preparation of a stock solution of pp' DDE at approximately 500ng/µl:

The pp' DDE stock solution is prepared by dissolving approximately (but weighed accurately) 50 mg of pp' DDE in hexane in a 100 ml volumetric flask and bringing the volume to exactly 100 ml with hexane. If the actual weight of pp' DDE is 52 mg, then

$$\frac{52 \text{ mg DDE}}{100 \text{ ml solvent}} \times \frac{1000 \mu\text{g}}{\text{mg}} \times \frac{\text{ml}}{1000 \mu\text{l}} = \frac{52 \text{ mg DDE}}{100 \text{ ml of solution}}$$

$$52 \text{ mg}/100 \text{ ml} \Rightarrow 0.52 \text{ mg/ml} \Rightarrow 520 \mu\text{g/ml} \Rightarrow 520 \text{ ng}/\mu\text{l}$$

The concentration of the stock solution will be: 520ng/µl

Preparation of an intermediate solution:

Use the stock solution to prepare the intermediate solution. The concentration of pp' DDE intermediate solution should be approximately 5ng/μl. To prepare the 5ng/μl intermediate solution, transfer 1 ml of the pp' DDE stock solution into a 100 ml volumetric flask and dilute with hexane to 100 ml.

$$\frac{1 \text{ ml DDE stock solution}}{100 \text{ ml final volume}} \times \frac{520 \text{ ng DDE}}{\mu\text{l}} = \frac{5.2 \text{ ng}}{\mu\text{l intermediate solution}}$$

The concentration of the intermediate solution will be: 5.2 ng/μl

Preparation of the working solution:

Use the intermediate solution to prepare the working solution. The concentration of pp' DDE in the working solution could be approximately 50pg/μl.

To prepare the 50 pg/μl working solution, transfer 1 ml of the pp' DDE intermediate solution into a 100 ml volumetric flask and dilute with hexane to 100 ml.

$$\frac{1 \text{ ml DDE intermediate solution}}{100 \text{ ml final volume}} \times \frac{5.2 \text{ ng}}{\mu\text{l}} \times \frac{1000 \text{ pg}}{\text{ng}} = \frac{52 \text{ pg}}{\mu\text{l working solution}}$$

The concentration of the working solution will be: 52 pg/μl

3.1.2. Cleaning of solvents

All reagents, including the distilled water should be of analytical quality. Commercially available solvents like acetone, acetonitrile, dichloromethane, hexane and pentane are invariably contaminated with ECD-active substances; their concentrations vary from batch to batch and with supplier. Reagent quality should be checked by injection of 2 μl of a 100 ml batch of solvent, after concentration to 50 μl in a rotary evaporator. No peak in the GC-ECD chromatogram (90 - 250 °C) should be larger than that for 1pg of lindane. Otherwise, the solvent must be distilled. The following procedure has been found to be both efficient and cost effective, as it allows the use of technical grade solvents as the basic material (reducing the cost by one order of magnitude). 130 - 150 cm height columns are required; the packing material must be glass (to allow subsequent cleaning with an oxidising acid). The entire equipment is cleaned prior to use by 2 consecutive distillation procedures with 500 ml water in each case. It is essential that a current of nitrogen gas (15 ml/min) flows from the distillation flask during distillation of the organic solvents: the condenser serves as exhaust. Ambient air is not in contact with the solvent in this way. Problems are associated with other methods of excluding room air (e.g., active carbon or molecular sieves), the most important one being discontinuity. The condensate is distilled into a 1 litre flask at a 1:20 ratio. This large volume allows for direct transfer into the appropriate solvent containers which should be made of glass and of a sufficient size to provide solvent for not more than 6 analyses. A bottle with sufficient solvent for 10 - 15 analysis has to be opened and closed many times and even when kept closed, when not in use, contamination from the surrounding atmosphere takes place. For more detailed information, consult the Reference Method No 65: UNEP/IOC/IAEA: Reagent and laboratory ware clean-up procedures for low-level contaminant monitoring.

3.1.3. Cleaning of reagents and adsorbents**3.1.3.1. Cleaning of reagents**

Powdered or crystalline reagents, such as anhydrous sodium sulfate (Na₂SO₄)*, potassium hydroxide (KOH), glass wool * and carbon or carborundum boiling chips *, must be thoroughly cleaned before use. They should be extracted with hexane in a Soxhlet apparatus for 8 hours and then with methanol or dichloromethane for another 8 hours. For those items indicated by an *, this will require pre-combustion in a muffle furnace at approximately 400°C.

3.1.3.2. Cleaning of adsorbents

Silica gel, alumina and Florisil have to be solvent extracted. Each reagent is first refluxed with methanol or dichloromethane in a Soxhlet apparatus for 8 hours, then with n-hexane for the same period. The solvent is removed by a rotary evaporator operating at low speed, until the sorbent starts falling down as fine particles. Reagents are dried in a drying oven at 0.01 mbar. If this is not available, they are dried in a normal oven at 120°C for 4 hours. This serves to activate silica and alumina. Florisil has to be activated at 130°C for 12 hours. The sorbent is allowed to cool in the oven (if possible under vacuum to avoid uptake of contaminants from the atmosphere) or alternatively, in a dessicator. As active sorbents attract water and contaminants from the atmosphere, controlled deactivation should be carried out by adding water to the fully active sorbent (5% by weight to silica, 2% by weight to alumina, and 0.5% by weight to Florisil). The deactivation procedure should be carried out by adding the water to the sorbent and mixing by gentle shaking for a few minutes. The equilibration takes one day. The activity can be maintained for longer periods of time by sealing the required amount of sorbent in glass ampoules. Otherwise, the activation/deactivation has to be done the day before use.

3.2. Apparatus and equipment

The laboratory used for organic trace analysis must be a dedicated facility, isolated from other projects that could be sources of contamination. It must be properly constructed with fume hoods and benches with electric sockets that are safe for use with flammable solvents. The laboratory must have extractors and rotary evaporators cooling water to run the stills. In tropical regions and in dry climates, a refrigerated re-circulating system should be used to reduce temperatures to the required levels and/or to conserve water. Stainless steel or ceramic tiles make good non-contaminating surfaces. If necessary, benches can be coated with a hard epoxy resin and walls can be painted with epoxy paint. A sheet of aluminium foil on the workbench provides a surface which can be cleaned with solvent. A vented storage facility for solvents is essential. Benches must be fitted with frames to hold stills, extractors, etc. The emergency cut-off switch should be accessible from both inside and outside the laboratory. Fire fighting equipment should be mounted in obvious places and laboratory personnel trained in their use.

3.2.1. List of materials

- A coring device with liners and plunger or a grab sampler (thoroughly cleaned with detergents and solvents before use).
- Glass jars and aluminium foil, stainless steel knives, scoops, forceps, labels, marking pens, logbook.
- Insulated plastic boxes for transporting samples. Ice or dry ice.
- Deep freezer (-18 to -20°C) for sample preservation (frost free type freezers heat to above zero during frost removal cycles and they cannot be used for long term storage).
- Rotary evaporator.
- Kuderna-Danish (or similar) concentrator and heater.
- Soxhlet extraction apparatus and heaters.
- Glassware including boiling flasks, ground glass stoppers, beakers, Erlenmeyer flasks, separatory funnels, centrifuge tubes, weighing bottles, pipettes, tissue grinders.
- Drying oven (temperature range up to at least 300°C) for determining sample dry weights, baking of contaminant residues from glassware and reagents.

Note: A muffle furnace is better for baking materials at greater than 300°C, if required.

- Centrifuge and tubes.
- Freeze-dryer and porcelain pestle and mortar.
- Analytical balance with an accuracy of 0.1 mg and an electro-balance with an accuracy of at least 1 µg.
- Stainless steel tweezers and spatulas.

- Dessicator - completely free of organic contamination and with no grease applied to sealing edges.
- Supply of clean, dry nitrogen.
- Columns for silica gel, alumina and Florisil chromatography.
- Mechanical blender (food mixer).
- Vacuum pump (water-jet air pump).

3.2.2. Cleaning of glassware

Scrub all glassware vigorously with brushes in hot water and detergent. Rinse five times with tap water and twice with distilled water. Rinse with acetone or methanol followed by hexane or petroleum ether. Bake overnight in an oven at 300 °C. All glassware should be stored in dust free cabinets and tightly sealed with pre-cleaned aluminium foil when not in use. Ideally glassware should be cleaned just before use.

For more detailed information, consult Reference Method No 65: UNEP/IOC/IAEA: Reagent and laboratory ware clean-up procedures for low level contaminant monitoring.

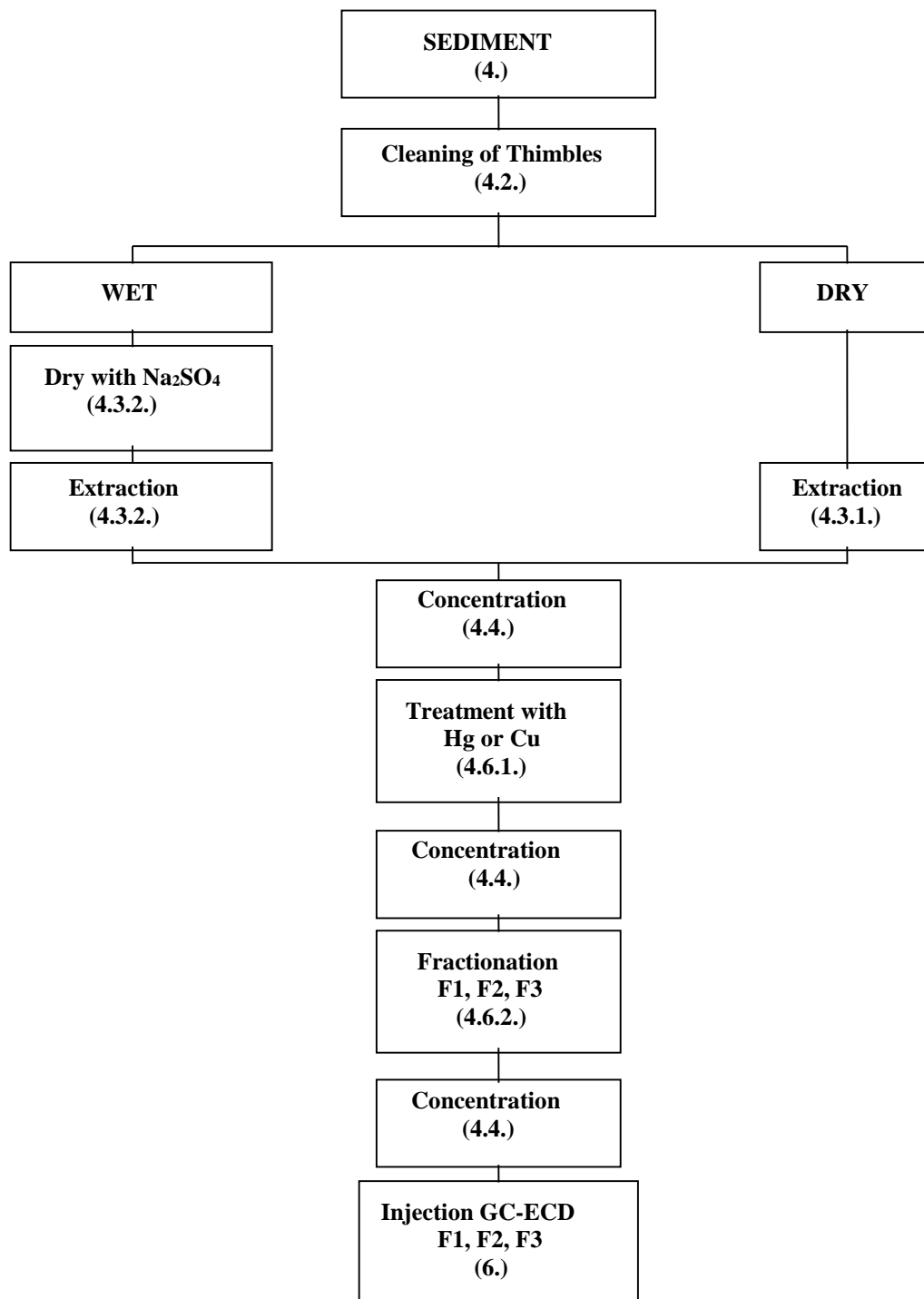

Diagram of the extraction procedure for sediment samples.

4. SEDIMENTS

4.1. Sampling

For the preparation of the samples (including selection of sites, collection of samples and storage) the reader should refer to the Reference Method N° 58: Guidelines for the use of sediments for the marine pollution monitoring programmes, to the Reference Method N° 20: UNEP/IOC/IAEA: Monitoring of petroleum hydrocarbons in sediments and to UNEP(DEC)/MEDW.C282/Inf.5/Rev1: Methods for sediment sampling and analysis (2006).

4.2. Cleaning of extraction thimbles

Paper extraction thimbles should be cleaned prior to sample extraction. For use in the extraction of sediment samples, the extraction can be performed in the Soxhlet apparatus with 250 ml of a mixture hexane / dichloromethane (50:50) for 8 hours cycling the solvent through at a rate of 4 to 5 cycles per hour. Add into the solvent a few carborundum boiling chips to get a regular ebullition.

The use of disposable paper thimbles for the extraction procedure rather than re-usable glass fibre thimbles is recommended due to the difficulties encountered in cleaning the latter.

4.3. Extraction of sediments

4.3.1. Extraction of freeze-dried samples

Select a 50-100 g sub-sample of the sediment, weigh this sub-sample and freeze-dry it. When dried, re-weigh it and calculate the dry to wet ratio. Then pulverise the sample using a pestle and mortar and sieve it using a 250 µm stainless steel sieve. Accurately weigh about 20 g of ground sample and place it in the pre-cleaned extraction thimble. Add 1 ml of a solution of 25 pg/µl of 2,4,5 trichlorobiphenyl (PCB N° 29), 20.9 pg/µl of 2,2',3,3',4,5,5',6 octachlorobiphenyl (PCB N° 198), 20 pg/µl of ε HCH and 21 pg/µl of Endosulfan Id₄ as internal standards and extract for 8 hours in a Soxhlet apparatus with 250 ml of a mixture hexane / dichloromethane (50:50), cycling the solvent through at a rate of 4 to 5 cycles per hour, add into the solvent a few carborundum boiling chips to get a regular ebullition. Alternatively (or in addition), PCB congeners No 30, 121, or octachloronaphthalene and PCB congeners can be used as internal standards. Prepare a procedural blank by extracting an empty thimble using the same procedure as for the samples.

4.3.2. Extraction of wet samples

The sediment is thawed, sieved at 250 µm and homogenised manually with a stainless steel spatula or clean glass rod. A sub-sample of 1-2 g is weighed into a flask and placed in a drying oven at 105 °C for 24 hours, then allowed to cool to room temperature and re-weighed. Calculate the dry to wet ratio and discard the dry sediment (unless it is being used for other analysis e.g. TOC, total organic carbon).

Place a 30-40 g sub-sample of thawed, homogenised sediment into a blender. Slowly, add 100g of anhydrous sodium sulphate (desiccant) and blend the mixture at high speed for 10 minutes. Transfer the dried sample quantitatively to the pre-cleaned extraction thimble in the Soxhlet apparatus, add the internal standard solution (see above) and apply the same extraction procedure as above. Extract the same amount of sodium sulphate as a procedural blank, making sure to add an appropriate amount of internal standard solution.

4.3.3. Example of determination of percent moisture

Many environmental measurements require the results to be reported on a dry weight basis. The percent moisture or water content in the sample is determined by weighing an aliquot, not used for analysis, of the sample before and after drying. The drying can be done by heating a few grams (1-2 g) of the sample in an oven to constant weight.

Weigh an empty glass beaker that will be used to hold the sample while it is dried.

Empty beaker weight = 10.4417 g

Add the wet sample to the beaker and reweigh. Calculate the wet weight of the sample.

Empty beaker weight + wet sample = 12.2972 g

Wet sample weight = 12.2972 g - 10.4417 g = 1.8555 g

Dry the sample to constant weight: dry the sample for 24 hours, weigh it, dry again for 12 hours, re-weigh it, when the difference in weight is less than 5%, it means that the sample is dried.

Empty beaker weight + dry sample weight = 10.9396 g

Dry sample weight = 10.9396 g - Empty beaker weight

Dry sample weight = 10.9396 g - 10.4417 g = 0.4979 g

Calculate the percent dry sample weight.

$$\begin{aligned} \% \text{ Sample weight} &= \frac{\text{Sample dry weight}}{\text{Sample wet weight}} \times 100 \\ &= \frac{0.4979}{1.8555} \times 100 = 26.8 \% \end{aligned}$$

Calculate the percent moisture.

$$\begin{aligned} \text{Water content} &= \text{wet weight} - \text{dry weight} \\ &= 1.855 \text{ g} - 0.4979 \text{ g} = 1.3576 \text{ g} \end{aligned}$$

$$\% \text{ Moisture} = \frac{\text{Sample water weight}}{\text{Sample wet weight}} \times 100$$

$$\% \text{ moisture} = \frac{1.3576}{1.8555} \times 100 = 73.2 \%$$

4.4. Concentration of the extract

For both extraction procedures, the extracts are concentrated in a rotary evaporator to about 15 ml. Under good vacuum conditions the temperature of the water bath must not exceed 30 °C. Dry the extract with anhydrous sodium sulphate (when the sodium sulphate moves freely in the flask it means that the extract is dried). Collect the dried extract in the graduated tube of a Kuderna-Danish concentrator. Concentrate the extract to approximately 5 ml with the Kuderna-Danish concentrator and adjust the volume to exactly 1 ml by evaporating excess solvent under a gentle stream of clean dry nitrogen. The sample extract will be analysed gravimetrically for extractable organic matter (EOM) content at the 1 ml volume as a starting point. If measurements of the EOM are outside the calibration range of the balance, the total volume of the extract is adjusted accordingly using either dilution with hexane or evaporating under a stream of nitrogen gas.

4.5. Extractable organic matter

Before carrying out the clean-up procedure, it is advisable to determine the extractable organic matter.

The EOM is determined in the following manner. On the weighing pan of an electro-balance, evaporate a known volume of the sediment or biota extract (up to 100 µl) and weigh the residue with a precision of about ± 1 µg. If the residue is less than 2 µg, pre-concentration of the original extract is required. The quantity of EOM is:

$$\text{EOM } (\mu\text{g/g}) = \frac{\text{Weight of residue } (\mu\text{g}) \times \text{volume of the extract (ml)} \times 1000}{\text{Volume evaporated } (\mu\text{l}) \times \text{quantity of sample extracted (g)}}$$

Note that extreme care must be taken to ensure balance and pans are clean, dry and stable to obtain accurate readings at the ± 1 µg level. A small hot plate is used to warm pans and forceps and thus keep these instruments dry after solvent cleaning. If no electro-balance is available, a known volume of the extract can be transferred into a clean pre-weighed beaker. The solvent is evaporated with dry and clean nitrogen until a constant weight of about 1 mg is reached. Calculate the amount of “lipids” in the sample taking into account the volume of the lipid extract which was dried.

Example of calculation of E.O.M.

The extractable organic matter content of a sample is operationally defined as the weight of material extracted with the solvent employed (H.E.O.M. in case hexane is used as solvent). An aliquot of the sample extract is taken (few µl), the solvent is evaporated and the residue is weighed to determine the quantity of lipids extracted in the aliquot and from it to the total sample. The results are normally reported in mg lipids per gram dry weight extracted.

A 1 µl aliquot is removed from a 2.5 ml sample extract for determination of E.O.M. The 1 µl aliquot is evaporated on the pan of an electro-balance and the residue is weighed. Three determinations are made and the average taken.

Measurements:

Sample dry weight extracted: 4.443 g

Total volume of the extract: 2.5 ml

Sample aliquot removed: 1 µl

(1) Weight of a 1 µl aliquot after solvent evaporation: 32.2 µg

(2) Weight of a 1 µl aliquot after solvent evaporation: 32.1 µg

(3) Weight of a 1 µl aliquot after solvent evaporation: 32.3 µg

Average weight of a 1 µl aliquot : 32.2 µg

Total volume of the extract: 2.5 ml

Total quantity of lipids in the sample:

$$32.2 \mu\text{g}/\mu\text{l} \times 2.5 \text{ ml} \times \frac{1000 \mu\text{l}}{\text{ml}} = 80500 \mu\text{g} \text{ or: } 80.5 \text{ mg}$$

With 4.443 g of sample extracted:

$$80.5 \text{ mg} / 4.443 \text{ g} = 18.1 \text{ mg lipids/g}$$

4.6. Clean-up procedure and fractionation

Purposes of the clean-up: removal of lipids, whenever present at a significant amount; removal of elementary sulphur and sulphur compounds. Both these compound classes can interfere with the gas-chromatographic separation.

4.6.1. Sulphur and sulphur compounds removal

Elementary sulphur and sulphur compounds such as mercaptans should be removed from the extract. This could be done by using either mercury or activated copper.

a) Mercury method.

Add one drop (a few ml) of mercury to the sediment extract and shake vigorously for one minute. Centrifuge and carefully recover and transfer the extract in another tube with a Pasteur pipette. If the mercury is still tarnished, repeat the treatment with another drop of mercury, shake, transfer the hexane into another tube. Repeat this treatment until the mercury stays brilliant in the extract. Rinse the mercury with 5 ml of hexane and combine the extracts. Then, concentrate the resulting solution to ca. 1 ml with a gentle stream of nitrogen.

Cleaning of mercury:

Caution: When removing mercury from the sample, always use a plastic tray to keep the glassware in and work under a fume hood.

Fit a folded filter paper in a 10 cm diameter conical glass funnel and fix the funnel over a 250 ml glass beaker. Using a needle, make a small hole in the bottom of the filter paper. Carefully put the mercury onto the funnel. The mercury flows through the small hole in the filter paper leaving the solid impurities on its surface. The mercury collected is washed three times by shaking it carefully with dichloromethane and by removing dichloromethane layer with the help of a clean glass syringe. Allow the rest of dichloromethane evaporate and store the clean mercury in a thick walled glass bottle with a ground glass stopper. In order to avoid escape of mercury vapour, store the mercury under methanol.

Another way of cleaning the mercury involves sucking the dirty mercury through a capillary tube, such as a Pasteur pipette, connected to a guard-flask and then to a vacuum pump. The mercury will pass through the Pasteur pipette and will be collected and cleaned in the guard-flask. Then it should be transferred into a thick wall glass bottle with a ground glass stopper. The mercury is covered with a layer of methanol to protect it from oxidation.

b) Activated copper method.

Transfer about 20 grams of the copper powder in an Erlenmeyer. Add enough concentrated HCl to cover the copper powder, agitate. Sonicate for 10 min., agitate, put again in ultrasonic bath and sonicate for 10 min. Throw the used HCl, add some fresh HCl, transfer in ultrasonic bath and sonicate for 20 min. repeat that procedure four times in total. Wash with distilled water, agitate, discard, add water again, transfer in ultrasonic bath and sonicate for 15 min., discard the used water, repeat that procedure again, up to pH neutral. Wash with acetone, agitate, transfer in ultrasonic bath and sonicate for 15 min. repeat that procedure four times in total. Then use the same procedure with hexane as a solvent.

Keep in hexane (use it immediately, avoids Cu to be in contact with air).

Transfer 3 to 4 Pasteur pipettes per sample in the flasks containing the hexane extracts. Let the copper react all night. The presence of sulphur compounds in the sample will be detected by the tarnishing of the copper powder. Then, concentrate the resulting solution to ca. 1 ml with a gentle stream of pure nitrogen.

4.6.2. Fractionation

An adsorption chromatography step is used to remove interfering lipids and to fractionate the extract into classes of compounds. Many variations of adsorption chromatography clean-up procedures have been published to date. Four procedures are reported here in order of increasing complexity.

Preparation of the columns: Glass burettes (1 cm diameter) with Teflon stopcocks make convenient adsorption columns. The column is plugged with pre-cleaned cotton or glass wool. Prepare separate columns for each sample and blank determination. The column is partially filled with hexane. The appropriate amount of sorbent is mixed with hexane in a small beaker to form a slurry. A glass funnel and a glass rod are used to pour the adsorbent into the column. Several rinses with hexane are necessary to fill the column to the desired height. Tap with a pencil or a hard silicone tube against the column in order to settle the adsorbent into an even bed. Flush the material adhering to the wall of the column down to the bed with solvent. Prepare each column freshly immediately before use. Never let the column get dry.

4.6.2.1. Florisil

A Florisil column is used for this fractionation, which is prepared in the following way. The Florisil should be pre-extracted in the Soxhlet apparatus to remove any contaminants, using methanol or dichloromethane for 8 hours, followed by hexane for another 8 hours. It is then dried in an oven. Activation is achieved by heating the dried Florisil at 130°C for 12 hours. It is then partially deactivated with 0.5% water by weight and stored in a tightly sealed glass jar with ground glass stopper. The water should be well mixed into the Florisil and the mixture should be allowed to equilibrate for one day before use. The activation/deactivation procedure should be carried out one day before use. A 1 cm burette with Teflon stopcock is plugged with pre-cleaned glass wool. A column with a sintered glass disk could also be used. 17 grams of Florisil are weighed out in a beaker and covered with hexane. A slurry is made by agitation and poured into the glass column. The Florisil is allowed to settle into an even bed and any Florisil adhering to the column is rinsed down with hexane. The solvent is drained to just above the Florisil bed. It should be rinsed with a further 5 ml of hexane; one gram of anhydrous sodium sulphate is added to the top of the column in order to protect the surface of the Florisil from any disturbance. The column should never run dry. Individual columns should be prepared immediately before use and a new column of Florisil used for each sample.

The extract, reduced to 1 ml, is put onto the Florisil column. It is carefully eluted with 65 ml of hexane and the first fraction collected. Then the column is eluted with 45 ml of a mixture containing 70 % of hexane and 30 % of dichloromethane and the second fraction collected. The third fraction will be eluted with 60 ml of pure dichloromethane.

Fraction one will contain the PCBs, pp' and op DDE and some other pesticides such as HCB, aldrin, heptachlor, DDMU.

Fraction two will contain the DDTs, DDDs, most of the toxaphene, and some pesticides such as the HCH isomers and chlordane components.

Fraction three will contain mainly dieldrin, endrin, heptachlor epoxide and endosulfan components. Typical chromatograms obtained are shown below.

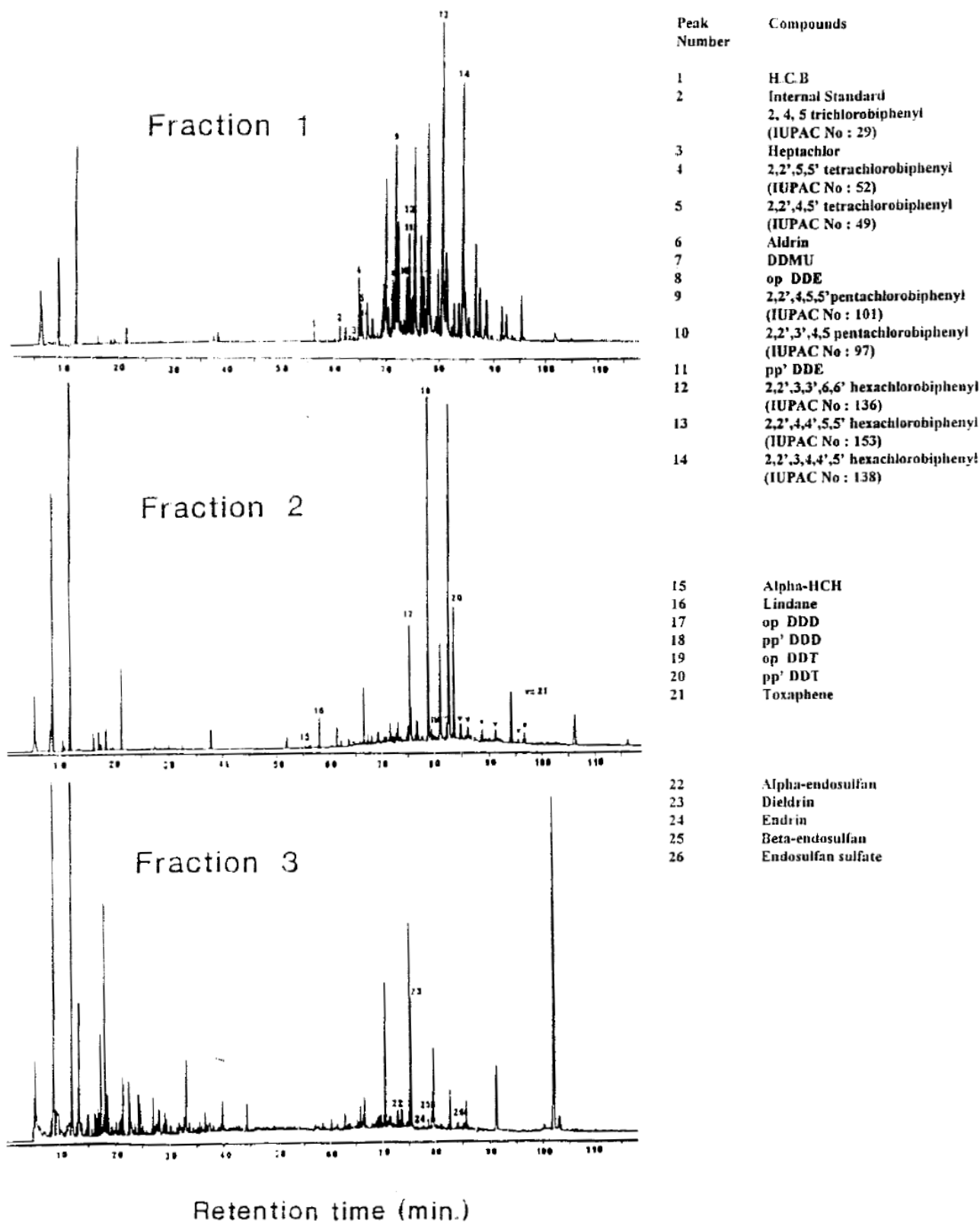

Figure 2: GC-ECD organohalogen analyses

4.6.2.2. Gel permeation chromatography

Low pressure GPC can be used as an alternative clean-up technique to remove high molecular weight co-extractable lipidic material from polycyclic aromatic compounds and halogenated aromatics. Concurrently, elemental sulphur could be also removed from the whole organic extract.

The main feature of the semi-preparative-GPC as a clean-up technique relies on the compatibility of this analytical procedure with labile components of the extract (i.e. DDTs, chlorinated cyclohexadiene derivatives), which are not stable in other types of extract clean-up procedures. Further, GPC as a clean-up technique has already been automated, enabling a high sample throughput, taking into account the short analysis time involved.

The GPC retention mechanism may involve adsorption, partition and size exclusion mechanisms. The predominance of one mechanism over the others is largely determined by the choice of the mobile phase and the pore size of the packing. In the case of GPC packings with large pore size (1000-2000 daltons) size exclusion and adsorption mechanisms prevail (Bio-Beads SX-3 using cyclohexane, dichloromethane-hexane, dichloromethane-cyclohexane, toluene-ethylacetate and ethylacetate-cyclohexane) (Ericksson *et al.*, 1986). On the other hand, when smaller pore sizes (400 daltons) are used in combination with highly polar solvents, (THF, DMF) size exclusion predominates (Lee *et al.*, 1981). While using the first approach, a chemical class fractionation could be obtained, however, if smaller pore sizes are used it should be combined with another fractionation technique (i.e. adsorption chromatography) to achieve this selectivity. It has yet to be demonstrated that using GPC as a single clean-up step produces a completely clean extract for GC-ECD determination. Nevertheless, taking into account the increasing availability of high-resolution low molecular weight exclusion packings, they could definitively integrate fractionation and clean-up in a single step.

Low resolution packing (Sephadex LH and Bio-Beads SX, 200-400 mesh size) are the most widely used because they are inexpensive and afford relatively high sample loading (500 mg in 10 mm i.d. columns). The implementation of low resolution GPC requires a solvent delivery system and a UV detector and may be useful. For method development, it is advisable to inject a broad range of standard compounds covering the whole range of molecular weights of the analytes to be determined in order to determine the cut-off points to fractionate real samples. Reported recoveries of PCBs and PAHs range from 60 to 80 % for the concentration level (ng) injected. (Fernandez and Bayona, 1992).

4.6.2.3. Alumina and HPLC (silica column)

The first step in this clean-up procedure is an adsorption step using an alumina column to remove most of the lipid material. Prepare an alumina column (4 x 0.5 cm i.d., made from a Pasteur pipette). Apply the concentrated extract to the top of the column and elute with 10 ml hexane. Concentrate the eluate to about 200 µl. It is followed by a second step to more completely remove interfering compounds and at the same time to separate the compounds of interest into different fractions, containing aliphatics, PCBs, PAHs, pesticides and toxaphene. Between 20 and 200 µl of the extract (after alumina clean-up) are eluted on a stainless steel column (200 x 4 mm i.d.), packed with Nucleosil 100-5 with n-pentane, 20 % dichloromethane in n-pentane and finally dichloromethane. The eluate is collected in fractions containing 1) n-hydrocarbons, 2) PCBs, 3) PAHs and toxaphene, 4) pesticides and toxaphene and 5) acids, etc. (polar compounds). The size of the fractions has to be determined with standard solutions containing the compounds of interest, collecting the eluate in 0.5 ml fractions. Each fraction is then analysed by GC-ECD. Full details have been given in the literature (Petrick *et al.*, 1988 and IOC, 1993).

4.6.2.4. High pressure chromatography

High pressure liquid chromatography (HPLC) columns packed with microparticles are available and have the advantages of high reproducibility, low consumption of solvents, high efficiency and high sample loading capacity.

This method can be used to separate fractions containing aliphatic hydrocarbons, PCBs and aromatic hydrocarbons from interfering compounds. These fractions can then be analysed separately for their constituents by GC-FID and/or GC-ECD.

HPLC methods have been developed using synthetic solutions of n-alkanes, PAHs, pesticides, PCBs and toxaphene and have been applied to samples in which interfering substances were present in such high concentrations as to render the analysis of HC and PCBs extremely difficult without this clean-up procedure (e.g. sediments and biological tissues with OCs in the ng/g range). The samples are eluted with n-hexane, subjected to clean-up over alumina, concentrated down to 20-200 µl and treated by HPLC. With the use of n-hexane, n-pentane and 10 %, 20 % and 50 % dichloromethane in n-hexane, respectively, the following five fractions are obtained : 1) n-hydrocarbons and alkenes, 2) PCBs and alkylbenzenes, 3) PAHs and toxaphene, 4) pesticides, 5) acids, etc.(polar compounds). (Petrick *et al.* 1988).

5. BIOTA

5.1. Sampling

Organisms accumulate many contaminants from their environment (i.e., from sea water, suspended particulate matter, sediment and food). Field and laboratory studies have shown that contaminant concentrations in some marine plants and animals reflect concentrations in their environment. Scientists use this process (termed bio-accumulation) to assess marine contamination resulting from human activity (e.g., pipeline discharges, dumping from ships).

There are problems with using biota as bio-accumulators (bio-indicators). For example, tissues from individuals of a species exposed to the same contaminant concentration may contain different levels of contamination after the same exposure time. These deviations reflect individual differences in factors such as age, sex, size, and physiological and nutritional states. Also, various species show different contaminant concentrations following identical exposure; differences in elimination rates may partially account for this. These factors must be considered when planning a monitoring programme in order to control their effects on the precision of the analysis (by reducing the variances). Variance reduction is necessary in order to detect smaller differences in mean contaminant concentrations observed in monitoring programmes.

For proper sampling and sample preparation, refer to Reference Method No 6 “Guidelines for monitoring chemical contaminants in the sea using marine organisms” and Reference Method No 12 Rev.2 “Sampling of selected marine organisms and sample preparation for the analysis of chlorinated hydrocarbons”.

5.2. Cleaning of extraction thimbles

As for extraction of sediment samples, thimbles should be extracted first with the same solvent used for the extraction of the sample. As the extraction of biota sample is achieved with hexane, a pre-extraction of these thimbles is made with 250 ml of hexane for 8 hours in the Soxhlet apparatus, cycling the solvent through at a rate of 4 to 5 cycles per hour. Add into the solvent a few carborundum boiling chips to get a regular ebullition.

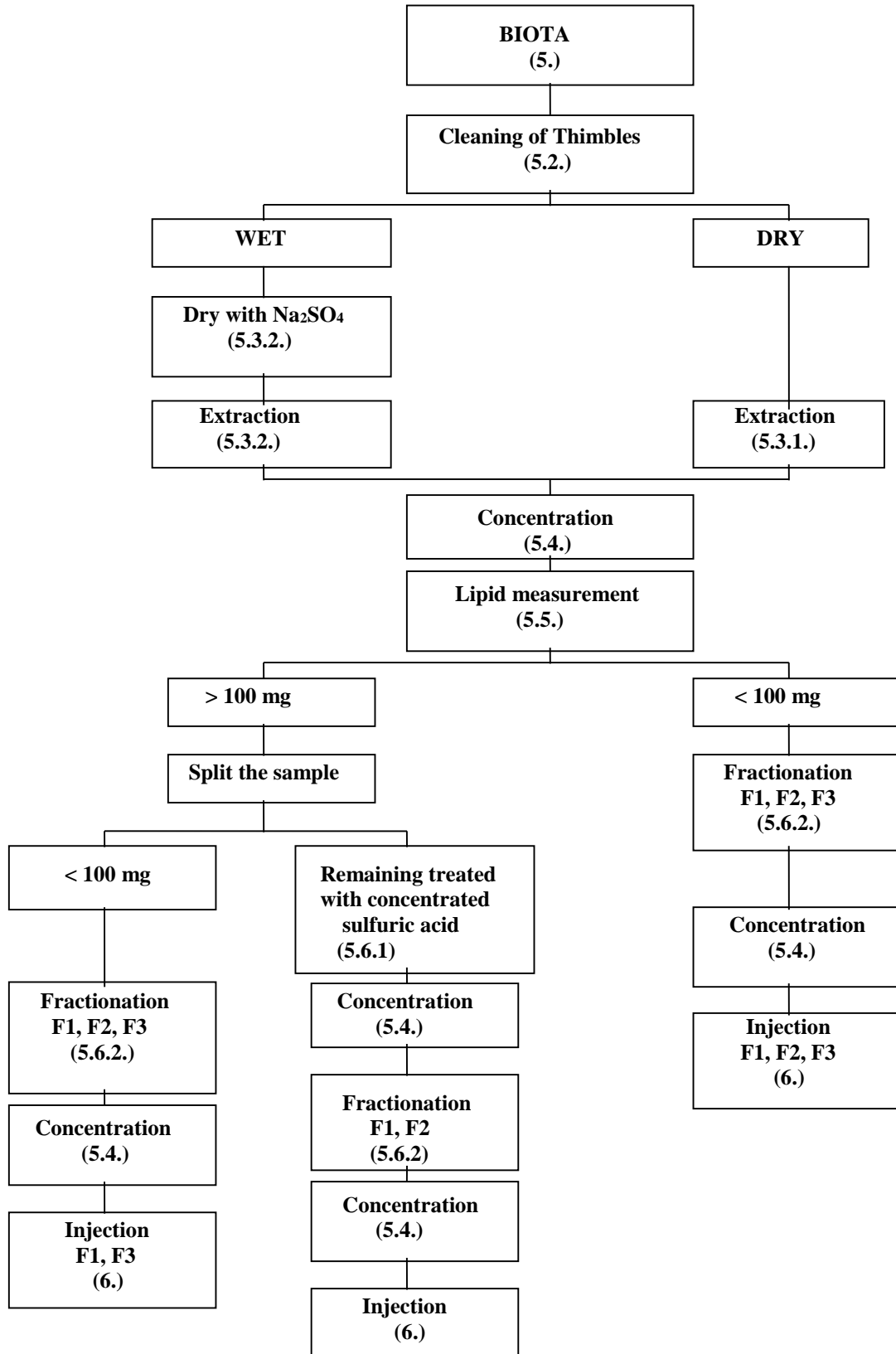

Figure 3: Diagram of the extraction procedure for biota samples.

5.3. Extraction of tissues

5.3.1. Extraction procedure for freeze-dried samples.

Take a 50 to 100 g fresh weight sub-sample from the sample. Weigh this sub-sample and freeze-dry it. When the sub-sample appears to be dry, re-weigh it and freeze-dry it for a further 24 hours and then re-weigh it. If the difference between the two dry weights is greater than 5%, continue the freeze-drying process. Special care must be taken to ensure that the freeze-drier is clean and does not contaminate the samples. The freeze drying procedure should be tested by drying 100 g Na₂SO₄ as a blank and extracting this as a sample. Pulverise the freeze-dried sub-sample carefully using a cleaned pestle and mortar. Accurately weigh about 5 to 10 g of this pulverised material, note the exact weight to be extracted, and place it into a pre-cleaned extraction thimble in a Soxhlet apparatus. The size of the sub-sample should be adjusted so that about 100 mg of extractable organic matter ("lipid") will be obtained. Smaller sub-samples should be used if residue concentrations are expected to be high. Add a known amount of internal standard to the sub-sample in the thimble before Soxhlet extraction. It is important to spike the sample at levels that are near to that of the analyte concentrations in the samples. If, in the end, the analyte and the internal standard concentrations do not fall within the established calibration range of the GC-ECD, the analysis must be repeated. Consequently, it may be advisable to perform range-finding analysis for samples of unknown character beforehand. Candidate internal standards are the same as for sediment samples (see 5.3.). Add about 200 ml of hexane or petroleum ether to the extraction flask with a few carborundum boiling chips, and extract the sample for 8 hours cycling the solvent through at a rate of 4 to 5 cycles per hour. Extract an empty thimble as a procedural blank, making sure to spike it with internal standards in the same fashion as the sample. If unacceptable procedural blanks are found, the source of contamination must be identified and eliminated rather than subtracting high blank values from the analytical results.

5.3.2. Extraction procedure without freeze-drying

Select a 25 to 100 g fresh weight sub-sample and place in a blender. Add anhydrous sodium sulphate to the sample, manually homogenise and determine whether the sample is adequately dried. If not, more sodium sulphate should be added until a dry mixture is obtained. Normally, 3 times by the sample weight used should be enough. Once this has been achieved, blend the mixture at high speed for 1 or 2 minutes until the mixture is well homogenised and the sample appears to be dry. Transfer the mixture to a pre-cleaned extraction thimble, add internal standards as described above and extract the dehydrated tissue with about 200 ml hexane or petroleum ether for 8 hours in a Soxhlet apparatus, cycling 4 to 5 times per hour. Extract the same amount of sodium sulphate as the procedural blank, making sure to add internal standards in the same fashion as the sample.

5.4. Concentration of the extract

Refer to section (4.4.)

5.5. Extractable Organic Matter (EOM)

Refer to section (4.5.)

5.6. Clean-up procedure and fractionation

5.6.1. Removal of lipids by concentrated sulphuric acid

If the lipid content of the extracts is higher than 100-150 mg, a preliminary step for the removal of the lipids is necessary before further sample purification. This can be carried out by using concentrated sulphuric acid. Treatment with sulphuric acid is used when chlorinated hydrocarbons are to be determined. However, sulphuric acid will destroy dieldrin and endrin so that an aliquot of the untreated extract must be set aside for the determination of these compounds.

CAUTION: During all this procedure it is very important to wear safety glasses.

Take an aliquot of the concentrated extract, containing about 200 mg of “lipids”, transfer into a separatory funnel and add to this extract enough hexane in order to dilute the sample (40 to 50 ml should be enough), this will allow recovery of the hexane after acid treatment, because if the sample is too concentrated, the destroyed “lipids” will become almost solid and it will be difficult then to recover the hexane from this solid mass. Add 5 ml concentrated sulphuric acid to the extract and tightly fit the glass stopper and shake vigorously. Invert the funnel and carefully vent the vapours out through the stopcock. Repeat this procedure for several minutes. Place the separatory funnel in a rack and allow the phases to separate. Four or five samples and a spiked blank are convenient to process at one time. The extract should be colourless. Recover the hexane phase into a glass beaker. Dry with sodium sulphate and transfer the hexane into a Kuderna-Danish concentrator. Reduce the volume of the extract by evaporating the solvent with a gentle stream of pure nitrogen to about 1 ml.

5.6.2. Fractionation

Refer to section (4.6.2.)

6. CAPILLARY GAS CHROMATOGRAPHIC DETERMINATIONS

6.1. Gas chromatographic conditions

- Gas chromatograph with a split/splitless injection system, separate regulation system for inlet and column pressures and temperatures; multi-ramp temperature programming facilities (preferably microprocessor controlled), electron capture detector interfaced with the column with electronic control unit and pulsed mode facilities. An integrator with a short response time (0.25 s) is essential.
- Narrow-bore (0.22 mm internal diameter), 25 m long, fused silica open tubular column, coated with SE-54 (0.17 µm film thickness, preferably chemically bonded) with sufficient resolution to separate the relevant peaks in the standards provided for PCB analysis.
- Carrier gas should be high purity H₂. If this is not available or if the GC is not equipped with a special security system for hydrogen leak, He may be used. Gas purification traps should be used with molecular sieves to remove oxygen, moisture and other interfering substances.
- High purity nitrogen gas (99.995 %) as ECD make-up gas can be used (Argon/methane high purity gas is another option).

Conditions:

- H₂ or He carrier gas at inlet pressure of 0.5 to 1 Kg/cm² to achieve a flow rate of 1 to 2 ml/min.
- Make-up gas N₂ or Ar/CH₄ at the flow rate recommended by the manufacturer (between 30 and 60 ml/min.).
- ECD temperature: 300°C

6.2. Column preparation

Fused silica columns are the columns of choice for their inertness and durability (they are extremely flexible). They are made of material that is stable up to 360 °C. The 5 % phenyl methyl silicone gum (SE-54) liquid phase, is present as a thin, (0.17 µm), uniform film which can tolerate temperatures up to 300 °C. SE-54 is relatively resistant to the detrimental effects of solvents, oxygen and water, at least at low temperatures. These columns are even more resistant and durable if the liquid phase is chemically bonded to the support by the manufacturer.

For GC/MS work, it is advised to restrict the film thickness to 0.17 µm because with thicker films some of the phase could be released, resulting in an increase of the noise signal in the GC/MS.

The flexible fused silica columns can be conveniently connected directly to the inlet and outlet systems without the transfer lines used in conventional glass capillary chromatography which often lead to increased dead volume. Low bleed graphite or vespel ferrules provide a good seal.

The presence of extraneous peaks and elevated baseline drift will result in poor detector performance. This can be caused by components which elute from the column, such as residual solvents and low molecular weight liquid phase fractions on new columns and build-up of later eluting compounds on old columns. Conditioning is a necessary step to remove these contaminants. New columns are connected to the inlet (while left unconnected to the detector). Columns are flushed with carrier gas at low temperature for 15 min. to remove the oxygen, then heated at 70-100 °C for 30 min. and finally at 170 °C overnight. The column can be then connected to the detector. Old columns can be heated directly to elevated temperatures overnight. The final temperature is selected as a compromise between time required to develop a stable baseline and expected column life. Thus, it may be necessary for older columns to be heated to the maximum temperature of the liquid phase resulting in shorter column life. The temperature of the ECD, when connected to the column, should always be at least 50 °C higher than the column, in order to avoid condensation of the material onto the detector foil. It is essential that carrier gas flows through the column at all times when at elevated temperatures. Even short exposure of the column to higher temperature without sufficient flow will ruin the column.

CAUTION: if H₂ is used as a carrier gas, position the column end outside of the oven to avoid explosion risk.

6.3. Column test

When the column has been connected to the detector, the carrier gas flow is set to 30 ml per minute for a column with 4 mm internal diameter. The column performance is then measured according to the criteria of the “number of theoretical plates” for a specific compound and can be achieved according to the following procedure.

- Set injector and detector temperatures at 200 and 300°C respectively and the column oven temperature at 180 °C.
- Inject pp’ DDT standard and measure the retention time (Tr). Adjust the column temperature to get a pp’ DDT retention time relative to Aldrin of 3.03.
- Measure the width of the pp’ DDT peak at its half height ($b_{1/2}$), in minutes and the retention time (Tr) also in minutes.
- Calculate the number of theoretical plates using the formula:

$$N = 5.54 \left(\frac{Tr}{b_{1/2}} \right)^2$$

- A parameter which is independent of the column length is the height equivalent to a theoretical plate (HETP):

$$HEPT = \frac{L}{N}$$

Where L is the column length. Adjust the flow rate of the carrier gas to obtain optimum performance. The HETP should be as low as possible (i.e. the number of theoretical plates should be as great as possible).

The column remains in optimum condition as long as the liquid phase exists as a thin, uniform film. The quality of the film at the inlet side may be degraded as a result of repeated splitless

injections. Decreased column quality may be remedied by the removal of the end of the column (10 to 20 cm) at the inlet side. Chemically bonded liquid phases require less maintenance.

6.4. Electron capture detector

High-energy electrons, emitted by a radioactive source within the detector (e.g. a ^{63}Ni foil), are subject to repeated collisions with carrier gas molecules, producing secondary electrons. These electrons, upon returning to their normal state, can be captured by sample molecules, eluting from a GC column. The resulting reduction in cell current is the operating principle of an electron capture detector. The detector current produced is actually a non-linear function of the concentration of electron-capturing material. However, the useful linear range of an ECD may be greatly improved if the instrument is operated at a constant current, but in a pulsed mode, i.e. with short voltage pulses being applied to the cell electrodes. The current in the cell is kept constant by varying the frequency of the pulses.

Contamination of the detector (and thus lower sensitivity) may result from high-boiling organic compounds eluting from the column. Periodic heating to 350°C may overcome this problem. The ^{63}Ni ECD can be used at 320°C under normal operational conditions, in order to limit such contamination.

The optimum flow for an ECD (30 to 60 ml/min.) is much higher than carrier gas flow through the column of one or two ml/min. Thus an additional detector purge flow is necessary (N_2 or Ar/CH_4). Once leaving the outlet of the column, the compounds have to be taken up into an increased gas flow in order to avoid extra-volume band broadening within the detector. Thus, the detector purge flow also serves as the sweep gas.

6.5. Quantification

The most widely used information for identification of a peak is its retention time, or its relative retention time (i.e., the adjusted retention time relative to that of a selected reference compound). Retention behaviour is temperature dependent and comparison of retention times obtained at two or more temperatures may aid in determining a peak's identity. However, retention times are not specific and despite the high resolution offered by capillary columns, two compounds of interest in the same sample may have identical retention times.

One way of using retention indexes could be to inject di-n-alkyl-phthalates such as a mixture containing di-n-methyl-phthalate, di-n-ethyl-phthalate, di-n-propyl-phthalate, di-n-butyl-phthalate, di-n-hexyl-phthalate and di-n-heptyl-phthalate, which will cover the elution range from 70°C to 260°C. An arbitrary index of 100 is given to the di-n-methyl phthalate, 200 to the di-n-ethyl phthalate, and so on up to 700 to the di-n-heptyl phthalate; it is possible to identify all chlorinated pesticides by a proper retention index. This will be used also for unknown compounds which can be found easily on the GC/MS using the same index and so, identified. (Villeneuve J.P. 1986).

PCBs represent a complex mixture of compounds that cannot all be resolved on a packed column. Also there is no simple standard available for their quantification. Each peak in a sample chromatogram might correspond to a mixture of more than one individual compound. These difficulties have led to the recommendation of various quantification procedures. The usual method to quantify PCBs is to compare packed-column chromatograms of commercially available industrial formulations (Aroclors, Clophens, Phenoclor) with the sample chromatogram. Most commonly, it is possible to match one single formulation, such as Aroclor 1254 or Aroclor 1260 with the sample chromatogram. An industrial formulation (or mixture of formulations) should be chosen to be as close a match as possible and in the case of sample extracts from sediment or organisms, Aroclor 1254 and Aroclor 1260 are most frequently chosen.

For the second fraction obtained on Florisil separation, it is possible to quantify DDTs after comparison with the retention times of peaks in the sample chromatogram to those in the corresponding standard, the peak heights (or peak areas) are measured and related to the peak height (or peak area) in the standard according to the formula:

$$[\text{Concentration}] = \frac{h \times C \times V \times 1000}{h' \times V(\text{inj}) \times M \times R} \text{ ng/g (or pg/g)}$$

Where:

- V = total extract volume (ml)
- M = weight of sample extracted (g)
- H = peak height of the compound in the sample
- h' = peak height of the compound in the standard
- C = quantity of standard injected (ng or pg)
- V (inj) = volume of sample injected (µl)
- R = Recovery of the sample

7. COMPUTERIZED GAS CHROMATOGRAPHY/MASS SPECTROMETRY (GC/MS)

7.1. Operating conditions

The chemical ionisation source of a mass spectrometer can be used to produce negative ions by electron capture reactions (CI-NI-MS) using a non-reactive enhancement gas such as methane or argon. CI-NI has the advantage of being highly selective, permitting the detection of specific compounds in complex matrices. Under CI-NI conditions, methane (99.99 %) is used as the reagent gas. Samples are introduced through a SE-54, 30 m x 0.25 mm i.d., fused silica column. The film thickness used is 0.17 µm in order to minimise the bleeding of the phase into the system. Helium is used as carrier gas with an inlet pressure of 13 psi, which gives a carrier flow of 1.5 ml/min. or a gas velocity of 44 cm/sec.

The temperature of the injection port is held at 250°C.

The temperature of the source is set at 240°C, the quadrupole at 100°C and the interface at 285°C.

Injections of 1-3 µl are made in the splitless mode.

The temperature programme of the oven starts at 70°C, for 2 minutes, then it is increased at 3°C/min. to 260°C and kept under isothermal conditions for 40 minutes.

File : C:\HPCHEM\1\DATA\AR1254.D
Operator : jpv
Acquired : 12 Jul 95 8:02 am using AcqMethod OC
Instrument : 5989B
Sample Name: standard ar1254
Misc Info :
Vial Number: 1

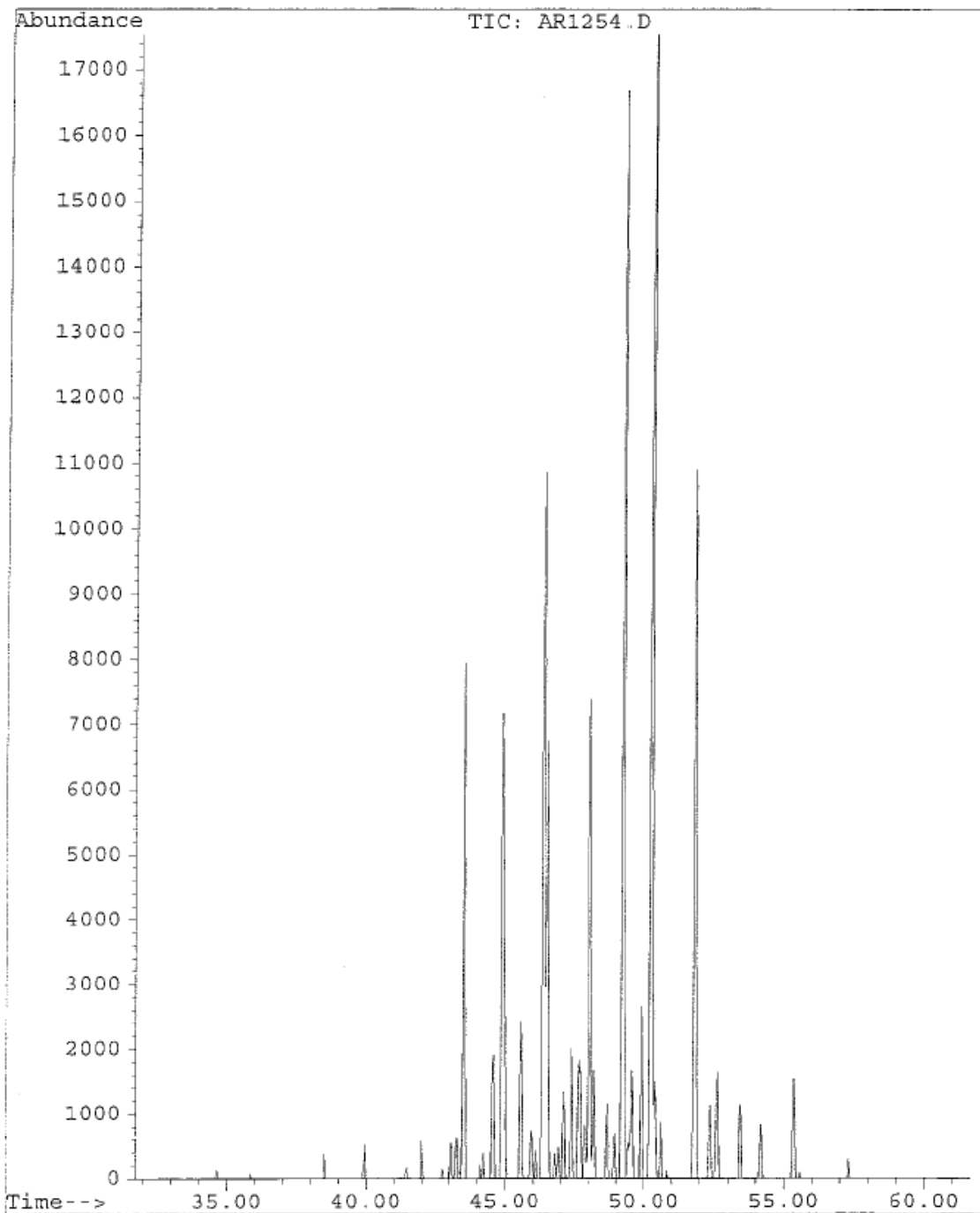

Figure 4: TIC of Aroclor 1254

File : C:\HPCHEM\1\DATA\AR1254.D
Operator : jpv
Acquired : 12 Jul 95 8:02 am using AcqMethod OC
Instrument : 5989B
Sample Name: standard ar1254
Misc Info :
Vial Number: 1

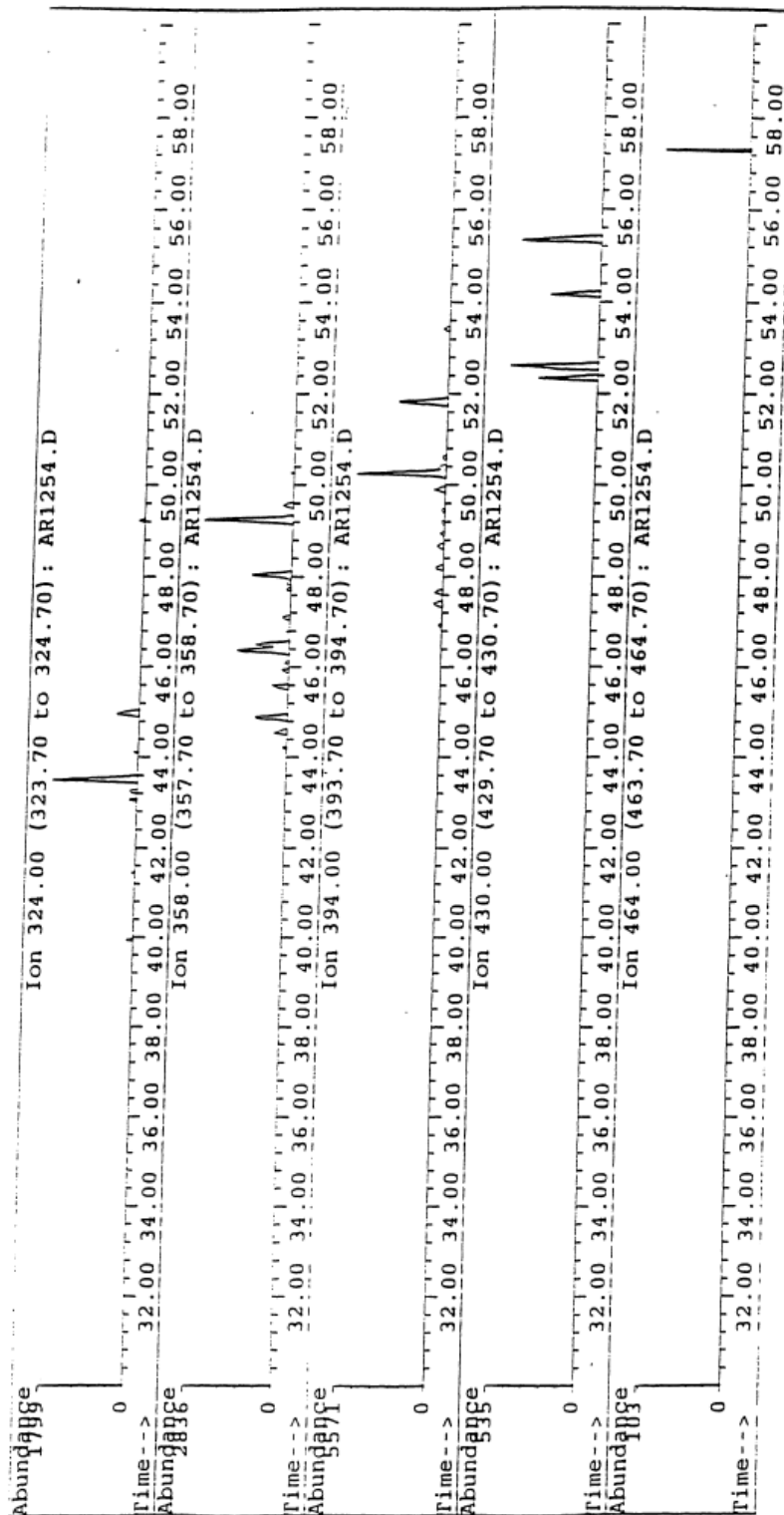

Figure 5: RIC of Aroclor 1254 main compounds

File : C:\HPCHEM\1\DATA\AR1260.D
Operator : jpv
Acquired : 12 Jul 95 9:42 am using AcqMethod OC
Instrument : 5989B
Sample Name: standard ar1260
Misc Info :
Vial Number: 1

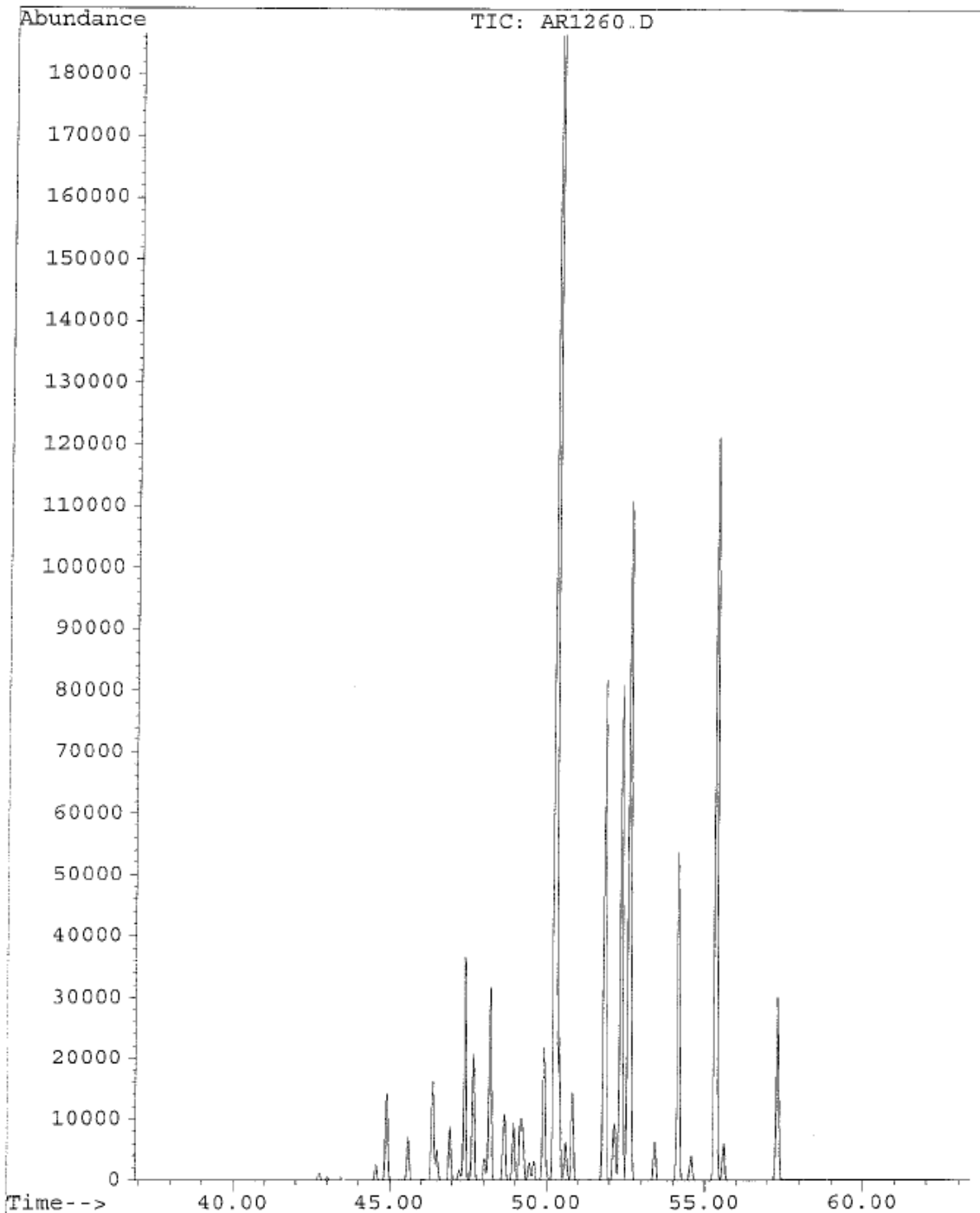

Figure 6: TIC of Aroclor 1260

File : C:\HPCHEM\1\DATA\AR1260.D
 Operator : jpv
 Acquired : 12 Jul 95 9:42 am using AcqMethod OC
 Instrument : 5989B
 Sample Name: standard ar1260
 Misc Info :
 Vial Number: 1

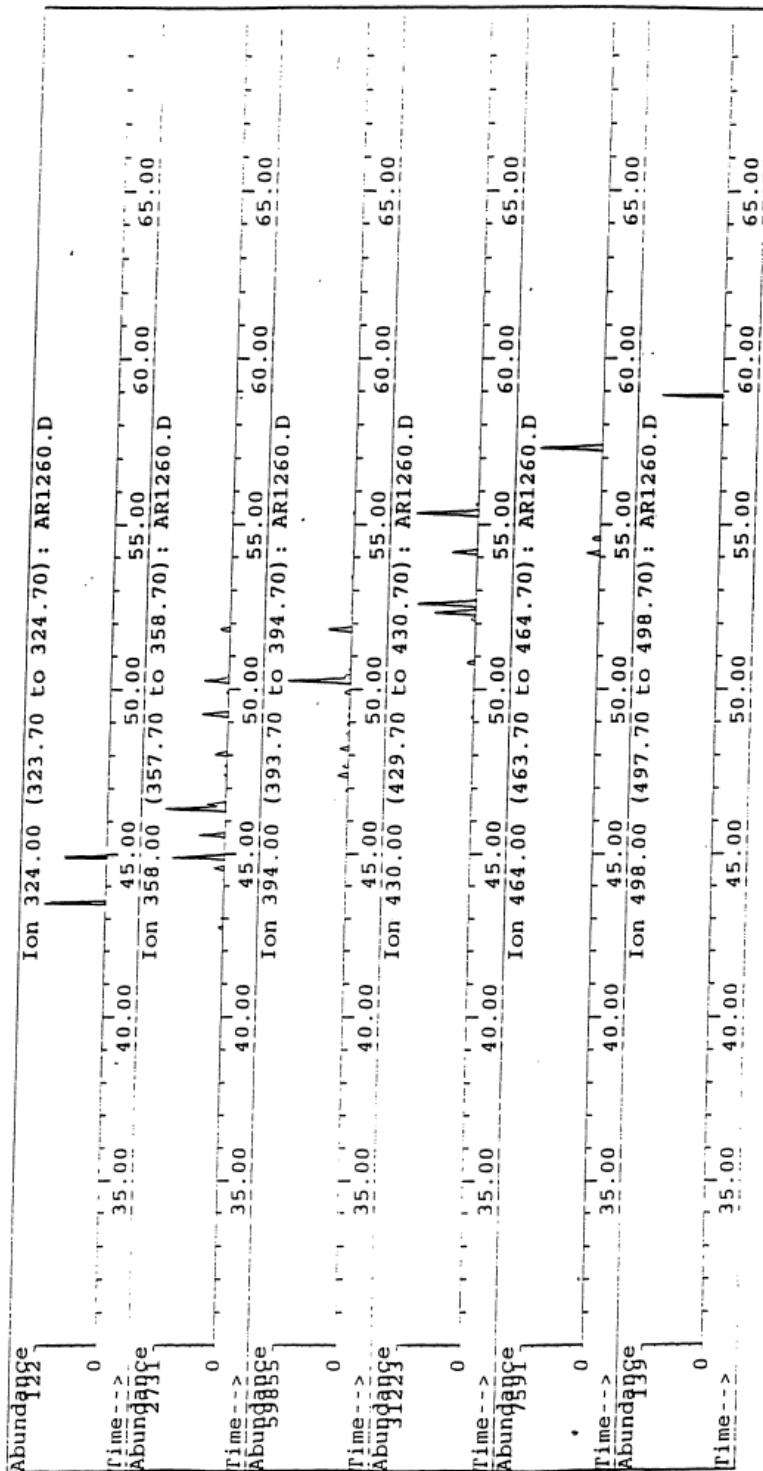

Figure 7: RIC of Aroclor 1260 main compounds

7.2. Example of a selected ion monitoring programme useful for quantitative analysis of chlorinated compounds.

Compounds	Fraction N° on Florisil	Retention Time (min.)	Target Ion (daltons)
HCB	1	37-38	284
Heptachlor	1	44-45	266
Aldrin	1	46-48	237
op DDE	1	51-53	246
Transnonachlor	1	52-54	444
pp' DDE	1	53-55	281
PCBs			
3 Cl	1		258
4 Cl	1		292
5 Cl	1	40-55	324
6 Cl	1	40-55	358
7 Cl	1	45-55	394
8 Cl	1	45-60	430
9 Cl	1	50-60	464
10 Cl	1	58-60	498
α HCH	2	37-39	255
β HCH	2	39-41	255
γ HCH (Lindane)	2	39-41	255
δ HCH	2	41-43	255
γ Chlordane	2	51-53	410
α Chlordane	2	52-54	266
op DDD	2	54-56	248
pp' DDD	2	56-58	248
op DDT	2	56-58	246
pp' DDT	2	58-60	283
Heptachlor epoxide	3	49-51	318
α Endosulfan	3	52-54	406
Dieldrin	3	53-55	346
Endrin	3	55-57	346
β Endosulfan	3	55-57	406
Endosulfan sulfate	3	58-60	386

8. NOTES ON WATER ANALYSIS

The levels of lipophilic compounds in tissues of aquatic organisms and organic fractions of sediments are determined to a large extent by the levels of these compounds in the surrounding water (marine mammals are an obvious exception). Data for CBs and hydrocarbons in sea water is therefore extremely useful for an understanding of the levels in organisms. However, the levels in sea water are extremely low and consequently, their determination needs considerable experience. Large volumes of water are required and extreme care has to be taken in order to avoid contamination during sampling, extraction and clean-up of the samples. Details are described in Manual and guide No 27 of IOC, 1993 and Villeneuve J.P. (1986).

9. ALTERNATIVE PROCEDURES

9.1. Combining sample preparation and extraction for chlorinated and petroleum hydrocarbons in sediment samples.

In the event that analyses for petroleum hydrocarbons and chlorinated compounds (and/or sterols) are of interest, the following extraction procedure can be used. To the freeze-dried sample introduce internal standards for each compound class. The following are suggested: 1) aliphatic hydrocarbons: - n-C₁₄ d₃₀, n-C₁₉ d₄₀, n-C₃₂ d₆₆, 2) polycyclic aromatic hydrocarbons: Naphthalene d₈,

Hexamethylbenzene, Cadalene (deuterated PAHs are also useful), 3) organochlorine compounds: PCB congeners 29, 30, 121 or 198, ϵ HCH and Endosulfan Id₄, 4) sterols: 5 α (H)-androstan-3 β -ol. These standards are used for quantifying the recovery of the total procedure. Samples are Soxhlet extracted for 8 hours with 250 ml of a mixture hexane / dichloromethane (50:50), cycling the solvent through at a rate of 4 to 5 cycles per hour. The solvent extract is concentrated by rotary evaporation down to 15 ml and transferred to a Kuderna-Danish tube. It is then further concentrated down to 5-6 ml under nitrogen gas. Following removal of sulphur and water, the extract is separated into aliquots: 1/3 for petroleum hydrocarbons and sterols and 2/3 for chlorinated hydrocarbons.

Note: Mercury method should be used only if chlorinated pesticides and PCBs are analysed. If the combined method is used for petroleum and chlorinated hydrocarbons, then the copper method should be used instead of mercury that will destroy some of the PAHs.

9.2. Supercritical fluid extraction (SFE) of marine samples

Sample preparation is probably the most time-consuming and labor-intensive analytical task performed in a laboratory. Studies shows that 60 % of the overall sample analysis time is spent in sample preparation which is the main source of error and of contamination. In addition, the amount of hazardous chemicals used for sample preparation is a continuous source of concern. Due to safe handling and disposal requirements, the reduction of their use is a priority for laboratories worldwide.

Supercritical fluids are gases (i.e. N₂O and CO₂) at room temperature and pressures above the critical point. The SFE technique allows an efficient extraction of a variety of contaminants with considerable reduction in the analysis cost, sample amount and allows the extraction of the thermal sensitive substances, reducing the amount of environmentally hazardous solvents.

A small change in the pressure of a supercritical fluid results in a big change in its density and the solvent strength of the fluid changes with changing density. As a result, one supercritical fluid easily performs the work of many solvents. If this is not enough, it is possible to add a modifier, such as methanol (a few per cent) to increase the solvating range of the fluid. Therefore, SFE should speed up the sample preparation process, minimising the wastes associated with the analysis.

Until now, the main fields of analytical applications of SFE are related to environmental studies and to the food-processing industry (Hawthorne, 1990, Bayona, 1993). A method using carbon dioxide (80°C-340 atm) for the extraction of total petroleum hydrocarbons has been approved as an EPA standard method. The extraction efficiency of modified CO₂ for the recovery of 41 organochlorine and 47 organophosphorus pesticides spiked on sand at different pressures and temperatures were higher than 80%. Furthermore, by increasing the extraction temperature up to 200°C, PCBs and PAHs can be extracted from naturally occurring samples with neat CO₂. Nam *et al.* (1991), have developed a method for rapid determination of polychlorinated organics in complex matrices. The method is based on direct coupling of supercritical fluid extraction with tandem supercritical fluid chromatography and gas chromatography. The on-line system permits simultaneous extraction and analysis with high reproducibility and accuracy.

**Selection guide for CO₂ extraction of common pollutants
 (from Hewlett-Packard)**

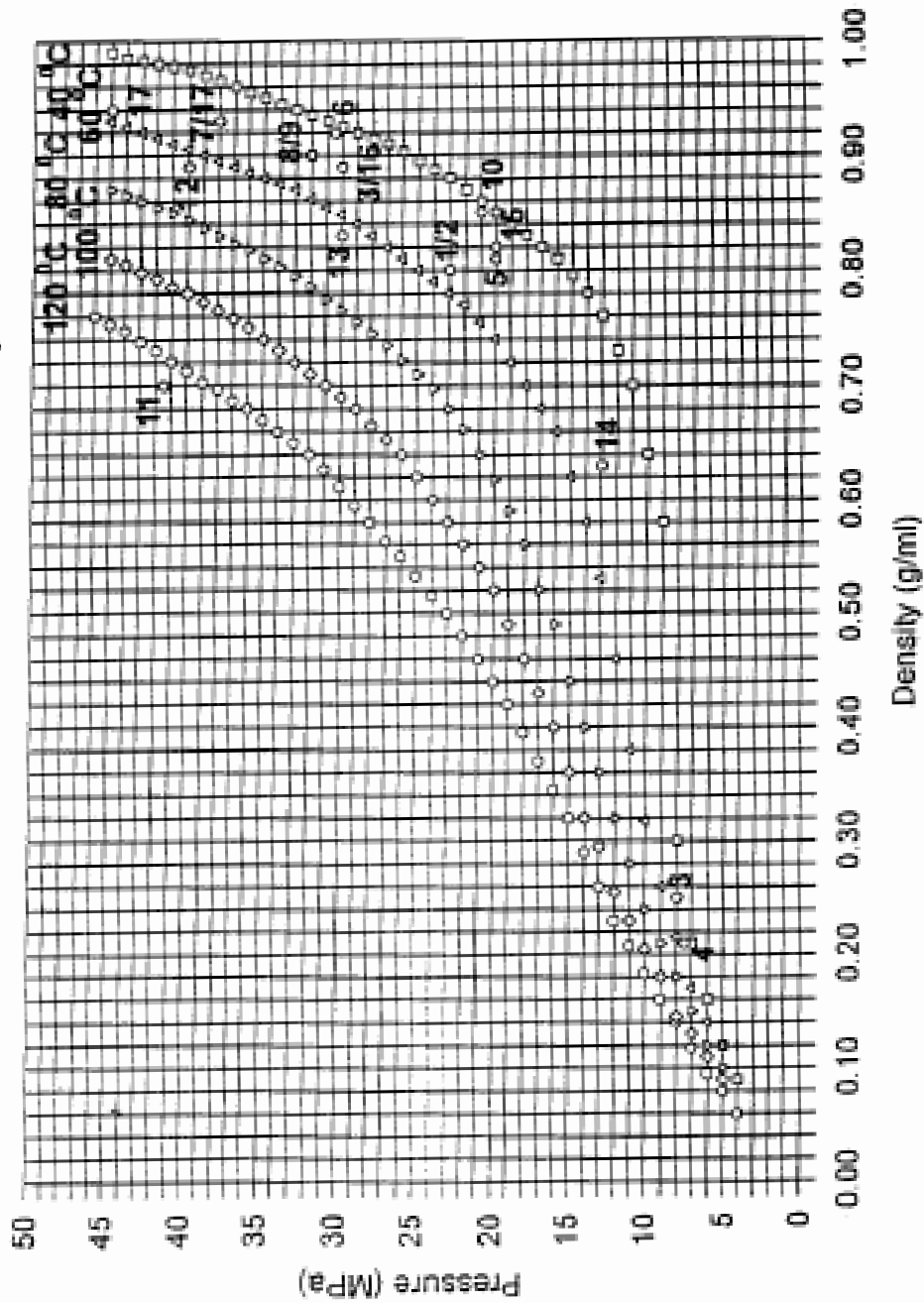

Figure 8: Guide for CO₂ extractions

9.3. Microwave assisted extraction for marine samples

9.3.1 Sediment

Another alternative method for the extraction of chlorinated hydrocarbons in sediment samples (or combined extraction for chlorinated hydrocarbons and petroleum hydrocarbons) is the use of the Microwave oven instead of the Soxhlet extractor. The main advantage of the microwave oven is the fact that, for one sample, only 40 ml of solvent mixture are used instead of 250 ml for clean-up of extraction thimbles and 250 ml for the extraction itself.

10 to 15 grams of freeze-dried sediment sample, ground and sieved at 250 µm, are put in the glass tube of the reactor. Appropriate internal standards (for OCs and/or PHs, see 10.1.) are added to the sample for recovery and samples are extracted with 40 ml of a mixture of hexane / dichloromethane (50:50).

Extraction is realised within the following cycle:

- Power of the microwaves: 1200 watts
- Temperature increase to 115 °C in 10 minutes.
- Extraction maintained at 115 °C for 30 minutes
- Cooling to ambient temperature within one hour.

The carousel containing 14 reactors, 12 samples could be extracted together with one blank and one Reference Material within 1 and half hour and with 10 times less solvent mixture than the standard Soxhlet extraction.

After cooling down to room temperature the solvent mixture is recovered in a 100 ml glass flask. The sediment is poured in a glass funnel containing a plug made of glass wool. The extracted sediment is washed with 10 - 20 ml of hexane. The extract follows then the procedure of clean-up and fractionation.

9.3.2 Biota

3 to 8 grams of freeze-dried biota sample is accurately weighted, the weight to be extracted is noted, and it is placed into the pre-cleaned glass tube of the reactor. A known amount of internal standard is added to the sub-sample in the tube before extraction. Candidate internal standards are the same than for sediment samples refers to section (5.3.1.)

Extraction is realized with 30 ml of a mixture hexane / acetone (90:10) within the following cycle:

- Power of the microwaves: 1200 watts
- Temperature increase to 115 °C in 10 minutes.
- Extraction maintained at 115 °C for 20 minutes
- Cooling to ambient temperature within one hour.

The carousel containing 14 reactors, 12 samples could be extracted with one blank and one Reference Material within 1 and half hour and with 10 times less solvent mixture than the standard Soxhlet extraction.

After cooling down to room temperature the solvent mixture is recovered in a 100 ml glass flask. The powder of biota is poured in a glass funnel containing a plug made of glass wool. The extracted biota is washed with 10 - 20 ml of hexane. The extract is then concentrated with rotary evaporator and ready for E.O.M, clean-up and fractionation procedure.

10. DATA INTERPRETATION

10.1. DDT

The residence time of total DDT in the environment is relatively short ($t_{1/2} = 3-5$ years), so, at least 75-80 % of the current total DDT should be in the form of DDE or DDD if it was introduced into the environment before the 1975 ban. Values of Henry's law constant indicate that these compounds can reach the troposphere as vapour. These vapours are little adsorbed by airborne particulate matter and represent the major component in atmospheric chlorinated hydrocarbon levels. Vapour movements of these pollutants suggest that restrictions and regulations operating in the more technically advanced countries could only be partially effective on a worldwide basis.

The presence of the *op* DDT together with anomalous *pp'* DDT values in environmental samples indicates a recent treatment with this insecticide.

10.2. PCBs congeners

Among the 209 possible PCB congeners, seven of them: 28, 52, 101, 118, 138, 153 and 180, were selected as the most relevant because of their distribution in the chromatogram and in the chlorination range.

Recently, attention has been paid to congeners having 2 para-chlorines and at least 1 meta-chlorine. These congeners are called "coplanar" PCBs. Among the 209 congeners, 20 members attain coplanarity due to non-ortho chlorine substitution in the biphenyl ring. Three of these show the same range of toxicity as the 2,3,7,8 tetrachlorodibenzo-p-dioxin and the 2,3,7,8 tetrachlorodibenzofuran, these are the IUPAC N^o: 77, 126 and 169. These compounds should be identified and quantified in the environmental samples with high priority. They can be separated using fractionation with carbon chromatography (Tanabe *et al.*, 1986).

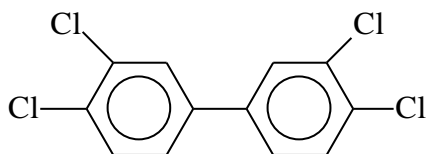

3,3',4,4' tetrachlorobiphenyl
IUPAC N^o: 77

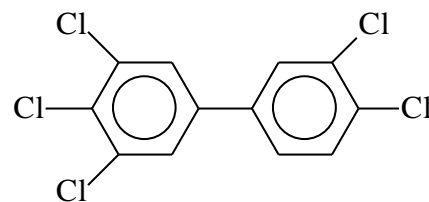

3,3',4,4',5 pentachlorobiphenyl
IUPAC N^o: 126

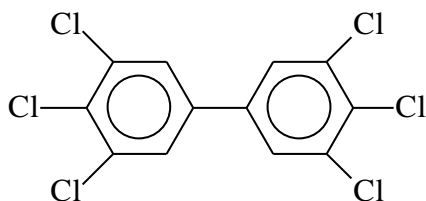

3,3',4,4',5,5' hexachlorobiphenyl
IUPAC N^o: 169

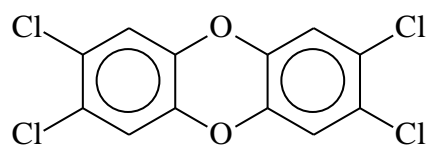

2,3,7,8 tetrachlorodibenzo-p-dioxin

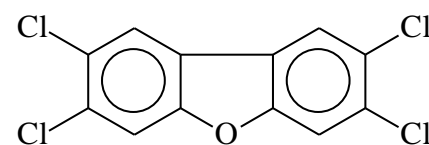

2,3,7,8 tetrachlorodibenzofuran

10.3. Typical profiles of commercial mixtures

Formulations available in different countries are slightly different in their composition (Aroclor in USA, Kanechlor in Japan, Clophen in Germany, Phenoclor in France, Fenclor in Italy or Sovol in Russia). For the same global composition, such as Aroclor 1254, KC-500 or Phenoclor DP-5, the composition of individual congeners differs by 5-10 %. If a sample is collected on the French coast (therefore, contaminated with DP-5), and is quantified with DP-5 and Aroclor 1254, the difference observed in concentration could be in the order of 5-10 %. This shows the importance of choosing one common standard for the quantification of global industrial formulations or the importance of quantifying with individual congeners.

Percent contribution of individual chlorobiphenyls to Clophen A 50 and Aroclor 1254.

PCB N°	Clophen A50	Aroclor 1254	PCB N°	Clophen A50	Aroclor 1254
17	0	0.19	115	0.28	0.3
18	0	0.41	118	10.9	6.39
28	0.05	0.25	119	0.19	0.14
31	0.05	0.22	122	0.19	0.5
33	0.11	0.14	123	0.85	0.81
40	0.28	0.2	126	0.08	0
41	0.83	0.64	128	3.04	2.07
42	0.13	0.23	129	0.83	0.23
44	2.46	2.03	130	0.83	0.63
47	0.18	0.11	131	0.06	0.16
48	0.17	0.14	132	2.57	1.98
49	1.96	1.64	134	0.52	0.49
52	5.53	5.18	135	1.61	1.62
53	0.06	0.09	136	0.91	1.12
56	0.44	0.58	137	0.25	0.25
60	0.34	0.54	138	3.61	3.2
63	0.15	0.05	141	0.98	1.04
64	0.71	0.45	146	0.8	0.83
66	0.5	0.59	149	4.5	2.21
67	0.13	0.09	151	1.22	1.17
70	3.85	3.21	153	4.17	4.26
74	1.35	0.78	156	1.43	1.62
82	1.05	0.95	157	0.31	0
83	0.53	0.45	158	0.98	0.77
84	2.08	1.95	167	0.35	0.21
85	1.85	1.66	170	0.65	0.31
87	4.22	3.78	171	0.5	0.5
90	0.85	0.93	172	0.09	0.05
91	0.92	0.83	173	0.09	0.09
92	1.53	1.58	174	0.37	0.34
95	6	6.02	175	0.11	0.05
96	0.05	0.08	176	0.43	0.32
97	2.8	2.55	177	0.21	0.21
99	4.06	3.6	178	0.19	1.35
100	0.15	0.1	179	0.2	0.21
101	7.72	7.94	180	0.53	0.38
105	1.9	3.83	183	0.21	0.17
107	0.94	0.72	187	0.3	0.32
110	6.27	5.85	190	0.05	0.08
			201	0.6	0.68

11. QUALITY ASSURANCE / QUALITY CONTROL

Guidelines on the QA/QC requirements for analysis of sediments and marine organisms are detailed in Reference Method No 57, "Contaminant monitoring programs using marine organisms: Quality assurance and good laboratory practice". Brief descriptions of issues that must be addressed in the course of understanding the procedures described here are given below.

11.1. Precision

The precision of the method should be established by replicate analysis of samples of the appropriate matrix. Estimate the precision of the entire analytical procedure by extracting five sub-samples from the same sample after homogenisation. Alternatively, perform replicate analysis of an appropriate certified reference material (RM; see below) containing the analytes of interest. The principal advantage of using a RM is that the material permits the simultaneous evaluation of accuracy while offering a well homogenised sample. Precision should be evaluated as a matter of course during the initial implementation procedure just before initiation of sample analysis.

11.2. Accuracy

The accuracy of the methods described here must be confirmed by analysis of a suitable RM (i.e. appropriate matrix, analytes) prior to initiation of sample analysis. Agreement between measured and certified concentrations for any individual analyte should be within 35 % and on average within 25%. It is advisable to introduce RMs on a regular basis (e.g. every 10-20 samples) as a method of checking the procedure. Further description of the preparation of control charts and criteria for data acceptance are discussed in Reference Method N° 57.

11.3. Blanks

Blanks represent an opportunity to evaluate and monitor the potential introduction of contaminants into samples during processing. Contributions to the analyte signal can arise from contaminants in the reagents, those arising from passive contact between the sample and the environment (e.g. the atmosphere) and those introduced during sample handling by hands, implements or glassware. It is essential to establish a consistently low (i.e. with respect to analytes) blank prior to initiating analysis or even the determination of the method detection limit. In addition, it is necessary to perform blank determinations on a regular basis (e.g. every batch of samples).

11.4. Recovery

Recovery reflects the ability of the analyst to fully recover surrogate compounds introduced to the sample matrix or blank at the beginning of the procedure. The primary criteria for selection of compounds to be used for testing recovery are that they: 1) have physical (i.e. chromatographic/partitioning) properties similar to and if necessary spanning those of the analytes of interest, 2) do not suffer from interferences during gas chromatographic analysis, 3) are baseline resolved from the analytes of interest.

Recovery should be tested on all samples and blanks as a routine matter of course. Recoveries below 70% are to be considered unacceptable. Recoveries in excess of 100 % may indicate the presence of interference.

11.5. Archiving and reporting of results

Every sample should have an associated worksheet which follows the samples and the extracts through the various stages of the procedure and upon which the analyst notes all relevant details. An example of such a worksheet is given below. Each laboratory should construct and complete such a worksheet. Relevant chromatograms should be attached to the worksheet. Analyses should be grouped

and composite or summary analysis sheets archived with each group. Final disposal of the data will depend on the reasons for which it was collected but should follow the overall plan model.

All processed samples should be archived at all steps of the procedure:

- deep frozen (in the deep-freezer as it was received).
- freeze-dried (in sealed glass container kept in a dark place).
- extracted (after injection on the GC, sample extracts should be concentrated down to 1 ml and transferred into sealed glass vials, a Pasteur pipette sealed with a butane burner is adequate and cheap).

Sample: IAEA-357 : Marine Sediment

wet wt.

----- =, % water in freeze dried sample determined by drying at 105°C :
dry wt.

.....g freeze-dried wt. extracted with hexane in Soxhlet extractor for 8 hours.

.....pg PCB N°29,pg PCB N°198,pg ϵ HCH and pg Endosulfan Id₄ were added as internal standard.

Theml extract was reduced by rotary evaporator to approximatelyml.

This was treated with sodium sulfate to dry the extract. Then treated with mercury to remove sulphur. This was further reduced toml for lipid determinations. Corrected dry wt. :g.

Lipid determinations:

.....ml total extract;

10 μ l aliquots weighed on micro-balance:mg;mg;mg.

HEOM =mg/g dry weight.

.....mg lipid subjected to column chromatography fractionation on Florisil.

F1:ml hexane

F2:ml hexane/dichloromethane (70:30)

F3:ml dichloromethane

GC determinations:

PCB N°29 :ng recovered in F1 :% Recovery.

PCB N°198 :ng recovered in F1 :% Recovery.

ϵ HCH :ng recovered in F2 :% Recovery.

Endosulfan Id₄:ng recovered in F3 :% Recovery.

Attach tabulation of individual compounds quantified in sample.

Sample worksheet for analysis of chlorinated compounds in marine sediments.

12. REFERENCES

- Bayona, J.M. (1993). The role of supercritical fluid extraction in sample preparation. *Robotics Lab. Autom.* 5, 156-187.
- Eganhouse, R.P. and Kaplan, I.R. (1988). Depositional history of recent sediments from San Pedro shelf, California: Reconstruction using elemental abundance, isotopic composition and molecular markers. *Mar. Chem.*, 24 (2), 163-191.
- Eisenreich, S.J., Capel, P.D., Robbins, J.A. and Bourbonniere, R. (1989). Accumulation and diagenesis of chlorinated hydrocarbons in lacustrine sediments. *Environ. Sci. and Technol.*, 23, 1116-1126.
- Ericksson, M.D. (1986). *Analytical Chemistry of PCBs*, Butterworth, Stonehaus, 149-153.
- Fernandez, P., Porte, C., Barcelo, D., Bayona, J.M. and Albaiges, J. (1988). Selective enrichment procedures for the determination of polychlorinated biphenyls and polycyclic aromatic hydrocarbons in environmental samples by gel permeation chromatography. *J. Chromatogr.* 456, 155-164.
- Fernandez, P. and Bayona, J.M. (1992). Use of off-line gel permeation chromatography - normal phase liquid chromatography for the determination of polycyclic aromatic compounds in environmental samples and standard reference materials (air particulate matter and marine sediment). *J. Chromatogr.*, 625, 141-149.
- Hawthorne, S.B. (1990). Analytical-scale supercritical fluid extraction, *Anal. Chem.*, 62, 633A-642A.
- Hom, W., Risebrough, R.W., Soutar, A. and Young, D.R. (1974). Deposition of DDE and polychlorinated biphenyls in dated sediments of the Santa Barbara basin. *Science*, 184, 1197-1199.
- Langenfeld, J.J., Hawthorne, S.B., Miller, D.J. and Pawliszyn, J. (1993). Effects of temperature and pressure on supercritical fluid extraction efficiencies of polycyclic aromatic hydrocarbons and polychlorinated biphenyls. *Anal. Chem.* 65, 338-344.
- Lee, M.L., Novotny, M.V. and Bartle, K.D. (1981), in *Analytical Chemistry of Polycyclic Aromatic Compounds*, Academic Press, New York, 143-152.
- Lopez-Avila, V., Dohiwala, N.S. and Beckert, W.F. (1990). "Supercritical fluid extraction and its applications to environmental analysis. *J. Chromatogr. Sci.* , 28, 468-79.
- Lopez-Avila, V., Benedicto, J., Dohiwala, N.S., Young, R. and Beckert, W.F. (1992). Development of an off-line SFR-IR method for petroleum hydrocarbons in solids. *J. Chromatogr. Sci.*, 30, 335-343.

Manuals and Guides No 27. IOC (1993).

- Nam, K.S., Kapila, S., Yanders, A.F. and Puri, R.K. (1991). A multiple sample extraction and on-line system for the analysis of chlorinated compounds. *Chemosphere*, 23, 1109-1116.
- Petrick, G., Schulz, D.E. and Duinker, J.C. (1988). Clean-up of environmental samples by high-performance liquid chromatography for analysis of organochlorine compounds by gas chromatography with electron-capture detection. *J. Chromatogr.*, 435, 241-248.
- Reference Method No 6, UNEP/FAO/IOC/IAEA: Guidelines for monitoring chemical contaminants in the sea using marine organisms. UNEP, 1993.
- Reference Method No 12 Rev.2, UNEP/FAO/IOC/IAEA: Sampling of selected marine organisms and sample preparation for the analysis of chlorinated hydrocarbons. UNEP, 1991.
- Reference Method No 20, UNEP/IOC/IAEA: Determination of petroleum hydrocarbons in sediments. UNEP, 1992.
- Reference Method No 57, UNEP/IOC/IAEA/FAO: Contaminant monitoring programme using marine organisms: Quality assurance and good laboratory practice. UNEP, 1990.

Reference Method No 58: Guidelines for the use of sediments for marine pollution monitoring programmes. (in preparation).

Reference Method No 65, UNEP/IOC/IAEA: Reagent and laboratory ware clean-up procedures for low-level contaminants monitoring. (in preparation).

Tanabe, S., Kannan, N., Wakimoto, T. and Tatsukawa, R. (1986). Method for the determination of three toxic non-ortho-chlorine substituted co-planar PCBs in environmental samples at part-per-trillion levels. Intern. J. Environ. Anal. Chem. Vol. 29, 199-213.

UNEP (DEC)/MED WG.282/Inf.5/Rev1: Methods for sediment sampling and analysis (2006).

Villeneuve, J.P. (1986). Géochimie des composés organochlorés dans l'environnement marin. Thèse de Doctorat de l'Université Paris VI. 180 pages.

ANNEX

**PREPARATION OF THE SOLUTION OF INTERNAL STANDARDS:
PCB No 29, PCB No 198, ε HCH and Endosulfan I d4**

Stock Solution of PCB No 29:

1 ml from the original vial (250ng/μl) should be transferred into a 100 ml volumetric flask, and then the volume is adjusted to 100 ml with hexane. This stock solution contains:

2.5 ng/μl of PCB No 29

Stock Solution of Endosulfan I d4:

1 ml from the original vial (250ng/μl) should be transferred into a 100 ml volumetric flask, and then the volume is adjusted to 100 ml with hexane. This stock solution contains:

2.5 ng/μl of Endosulfan I d₄

Working solution of internal standards:

0.5 ml from the stock solution of PCB No 29 (2.5 ng/μl) should be transferred into a 50 ml volumetric flask, then, 0.5 ml from the stock solution of Endosulfan I d₄ (2.5 ng/μl) should be transferred into the volumetric flask, then 1 ml from the original vial (1ng/μl) of ε HCH should be transferred into that volumetric flask, then 0.5 ml from the concentrated solution (2ng/μl) of PCB No 198, and the volume adjusted to 50 ml with hexane. This working solution contains:

25 pg/μl of PCB No 29

20 pg/μl of PCB No 198

20 pg/μl of ε HCH

25 pg/μl of Endosulfan I d₄

CAUTION: VIALS SHOULD BE COOLED AT 20°C PRIOR TO OPENING

Preparation of the Aroclor 1254 solution

Preparation of the stock solution:

1 ml from the original vial should be transferred into a 100 ml volumetric flask, then, the volume is adjusted to 100 ml with hexane. This stock solution contains:

6.5 ng/μl of Aroclor 1254

Preparation of the working solution:

1 ml from this stock solution should be transferred into a 50 ml volumetric flask and the volume adjusted to 50 ml with hexane. This working solution contains :

0.13 ng/μl of Aroclor 1254

CAUTION : VIAL SHOULD BE COOLED TO 20 °C PRIOR TO OPENING

Preparation of the Aroclor 1260 solution

Preparation of the stock solution:

1 ml from the original vial should be transferred into a 100 ml volumetric flask, then the volume is adjusted to 100 ml with hexane. This solution contains:

5.44 ng/μl of Aroclor 1260

Preparation of the working solution:

1 ml from the stock solution should be transferred into a 50 ml volumetric flask, then the volume is adjusted to 50 ml with hexane. This working solution contains

0.1088 ng/μl of Aroclor 1260

CAUTION: VIAL SHOULD BE COOLED TO 20 °C PRIOR TO OPENING

Preparation of the pp' DDE, pp' DDD and pp' DDT solution

pp' DDE:

Stock solution: 1 ml from the original vial should be transferred into a 100 ml volumetric flask, then the volume is adjusted to 100 ml with hexane. This stock solution contains:

5 ng/μl of pp' DDE

pp' DDD:

Stock solution: 1 ml from the original vial should be transferred into a 100 ml volumetric flask, then the volume is adjusted to 100 ml with hexane. This solution contains:

5 ng/μl of pp' DDD

pp' DDT:

Stock solution: 1 ml of the original vial should be transferred into a 100 ml volumetric flask, then the volume is adjusted to 100 ml with hexane. This stock solution contains:

5 ng/μl of pp' DDT

Working solution: pp' DDE, pp' DDD and pp' DDT together.

1 ml from the stock solution of pp' DDE, 2 ml of the stock solution of pp' DDD and 3 ml of the stock solution of pp' DDT should be transferred into a 100 ml volumetric flask and the volume adjusted to 100 ml with hexane. This solution contains

- pp' DDE : 50 pg/μl
- pp' DDD : 100 pg/μl
- pp' DDT : 150 pg/μl

NOTE: Further dilution may be necessary depending on the sensitivity of the EC Detector.

CAUTION: VIAL SHOULD BE COOLED TO 20 °C PRIOR TO OPENING

Preparation of Aldrin, Dieldrin and Endrin standard solutions:

Aldrin:

Stock solution: 1 ml from the original vial should be transferred into a 100 ml volumetric flask, then the volume is adjusted to 100 ml with hexane. This solution contains:

5 ng/μl of Aldrin

Dieldrin:

Stock solution: 1 ml from the original vial should be transferred into a 100 ml volumetric flask, then the volume is adjusted to 100 ml with hexane. This solution contains:

5 ng/μl of Dieldrin

Endrin:

Stock solution: 1 ml from the original vial should be transferred into a 100 ml volumetric flask, then the volume is adjusted to 100 ml with hexane. This solution contains:

5 ng/μl of Endrin

Working solution: Aldrin, Dieldrin and Endrin together.

1 ml from the stock solution of Aldrin, 1 ml from the stock solution of Dieldrin and 1 ml from the stock solution of Endrin are transferred into a 100 ml volumetric flask and the volume is adjusted to 100 ml with hexane. This working solution contains:

Aldrin : 50 pg/μl

Dieldrin : 50 pg/μl

Endrin : 50 pg/μl

NOTE: Further dilution may be necessary depending on the sensitivity of the detector.

CAUTION: VIALS SHOULD BE COOLED TO 20 °C PRIOR TO OPENING

Preparation of the HCB and Lindane standard solutions:

HCB:

Stock solution: 1 ml from the original vial should be transferred into a 100 ml volumetric flask, then the volume is adjusted to 100 ml with hexane. This solution contains:

5 ng/μl of HCB

Lindane:

Stock solution: 1 ml from the original vial should be transferred into a 100 ml volumetric flask, then the volume is adjusted to 100 ml with hexane. This solution contains:

5 ng/μl of lindane

Working solution:

1 ml from the stock solution of HCB and 1 ml from the stock solution of Lindane are transferred into a 100 ml volumetric flask, then the volume is adjusted to 100 ml with hexane. This solution contains:

HCB : 50 pg/μl

Lindane : 50 pg/μl

NOTE: further dilution may be necessary depending on the sensitivity of the EC Detector.

CAUTION: VIALS SHOULD BE COOLED TO 20 °C PRIOR TO OPENING

Preparation of the PCB congeners solution

In a 100 ml volumetric flask, transfer 1 ml from the original vial. Adjust to 100 ml with hexane in order to obtain the working solution with the following concentrations:

CB N°:	Compounds:	Concentrations (pg/μl)
8	2,4'	17.50
18	2,2',5	12
31	2,4',5	10.6
28	2,4,4'	4.6
52	2,2',5,5'	8.6
49	2,2',4,5'	12.1
44	2,2',3,5'	10.7
66	2,3',4,4'	5.5
95	2,2',3,5',6	5.7
101	2,2',4,5,5'	9.3
110	2,3,3',4',6	11.1
149	2,2',3,4',5',6	12.1
118	2,3',4,4',5	8.5
153	2,2',4,4',5,5'	8.4
138	2,2',3,4,4',5'	13.8
183	2,2',3,4,4',5',6	10.3
174	2,2',3,3',4',5,6'	9.4
177	2,2',3,3',4',5,6	9.5
180	2,2',3,4,4',5,5'	16.3
170	2,2',3,3',4,4',5	13.4
199	2,2',3,3',4,5,5',6'	9.3
194	2,2',3,3',4,4',5,5'	12.6

Separate into 10 volumetric flasks of 10 ml, seal with Teflon tape and keep in refrigerated place in order not to evaporate them.

CAUTION: VIAL SHOULD BE COOLED TO 20 °C PRIOR TO OPENING

EUNOCI 221-02937-0, E05 SED @ BHIMADZU

14:241	15.223	15.961	17.859	18.88	21.880	21.728	22.598	27.665	48.812	48.873	44.546	45.661	50.523	8	54.133	18	56.927	31	58.927	28	52.791	52	68.927	49	62.227	44	62.877	66 + 95	65.511	101	68.326	110	71.267	118	72.791	153	74.828	183	76.194	174	78.194	177	80.298	170	82.178	199	84.751	194	86.664	194
--------	--------	--------	--------	-------	--------	--------	--------	--------	--------	--------	--------	--------	--------	---	--------	----	--------	----	--------	----	--------	----	--------	----	--------	----	--------	---------	--------	-----	--------	-----	--------	-----	--------	-----	--------	-----	--------	-----	--------	-----	--------	-----	--------	-----	--------	-----	--------	-----

Issued and printed by

Oceans and Coastal Areas Programme Activity Centre
United Nations Environment Programme

Additional copies of this and other publications issued by
the Oceans and Coastal Areas Programme Activity Centre
can be obtained from:

Oceans and Coastal Areas Programme Activity Centre
United Nations Environment Programme
P.O. Box 30552
Nairobi
Kenya

Or from:

Marine Environmental Studies Laboratory
International Atomic Energy Agency
Environment Laboratories
4 Quai Antoine 1^{er}
98000 MONACO

Annex VII:

Development of a JAMP guideline on monitoring of contaminants in seawater

1.5.5.4**Special request, Advice May 2012**

ECOREGION **General advice**
SUBJECT **Development of a JAMP guideline on monitoring of contaminants in seawater**

Advice summary

ICES has developed a guideline document on monitoring of contaminants in seawater under the Joint Assessment and Monitoring Programme (JAMP) (Annex 1). The document also includes a technical annex on specifics of suitable sampling equipment. ICES advises that the document is included in the JAMP guidelines.

Request***Development of a JAMP guideline on monitoring of contaminants in seawater (OSPAR 2011/1)***

To develop the general text for a JAMP guideline on monitoring contaminants in seawater, which could act as the overarching chapeau to technical annexes concerning specific substances. The technical annex on analysis of PFC compounds in seawater developed by ICES in 2009 is the first such document. The development of the overarching text should take into account the need to address the following issues: purposes; quantitative objectives; sampling strategy; sampling equipment; storage and pre-treatment of samples; analytical procedures; analytical quality assurance; reporting requirements.

ICES advice

ICES has developed guidelines for monitoring of contaminants in seawater (Annex 1), complementing the corresponding JAMP Guideline for Monitoring of Contaminants in Sediment and JAMP Guideline for Monitoring of Contaminants in Biota. The guideline document in Annex 1 covers monitoring for organic contaminants and trace metals and is structured along the sections outlined in the request (purposes, quantitative objectives, sampling strategy, sampling equipment, storage and pre-treatment of samples, analytical procedures, analytical quality assurance, and reporting requirements). In addition, an annex to the guideline has been developed on technical specifics of the sampling equipment suitable for subsequent analysis of organic contaminants and trace metals. The document includes references to the EU Water Framework Directive (WFD) and EU Marine Strategy Framework Directive (MSFD) where applicable.

ICES advises that this document is included in the JAMP guidelines.

Source

ICES. 2012. Report of the Marine Chemistry Working Group (MCWG), 20–24 February 2012, Southampton, UK. ICES CM 2012/SGHIE:05.

Annex 1: Guidelines for Monitoring of Contaminants in Seawater

1. Introduction

These guidelines provide advice on the sampling and analysis of seawater, for determination of trace metals and organic contaminants, including oceanic, coastal, and estuarine waters. Monitoring contaminants in seawater is a complex task which requires carefully designed and conducted sampling campaigns, appropriate sampling equipment and its correct handling, as well as suitable pre-treatment and storage methods for the analytes in question. There are numerous steps that will affect data quality prior to the chemical analysis itself.

Contaminants in seawater can originate from direct point sources, riverine discharges, and atmospheric dry and wet deposition. Their distribution in seawater depends on the physical-chemical characteristics of the compound or element, interactions with the water matrix, sediment and biota as well as hydrographical conditions, such as mixing of water masses. Organic contaminants and metals can occur freely dissolved in water, bound to colloids, or suspended particulate matter. Trace metals can form complexes with organic or inorganic material. This partitioning is the result of environmental conditions and the partitioning may change during sampling and storage, and has implications for analysis and interpretation.

These guidelines are general recommendations on contaminant monitoring in seawater. The techniques described are useful for routine monitoring and ship/campaign-based work. However, this guideline is not intended as a complete laboratory manual. Requirements for specific contaminants or contaminant groups should be further specified by expert groups, for example in associated technical annexes, in order to meet the objectives of the monitoring programme and to ensure consistent and comparable data sets.

2. Purposes

Monitoring of contaminants in seawater of the Northeast Atlantic Ocean is performed within the framework of OSPAR as the regional convention for the protection of the marine environment of this area. OSPAR monitoring also can assist member states of the European Union to fulfil their obligations under the relevant EU directives, such as the Marine Strategy Framework Directive (MSFD) (EU, 2008) and the Water Framework Directive (WFD) (EU, 2000) with its related directives such as the daughter directive on Environmental Quality Standards in the field of water policy (2008/105/EC).

One of the aims of OSPAR's Hazardous Substances Strategy is that concentrations of naturally occurring chemicals should approach background concentrations, and concentrations of man-made chemicals should be zero. Progress on the implementation of this strategy is monitored through the Joint Monitoring and Assessment Programme (JAMP) of chemicals for priority action and hazardous substances in general. The main objectives of the JAMP for the period 2010–2014, which seek to support the implementation of the OSPAR strategies and the EU MSFD are:

1. the continued implementation and development of existing OSPAR monitoring programmes and, where necessary, the development of additional coordinated monitoring programmes to take account of criteria, methodological standards and indicators for good environmental status, and the pressures and impacts of human activities;
2. development of tools for the delivery of integrated environmental assessments of the OSPAR maritime area or its regions, linking human activities, their pressures, the state of the marine environment, and management responses. Where relevant, these tools should support the exploration of new and emerging problems in the marine environment;
3. the preparation of integrated environmental assessments of the implementation of the OSPAR strategies, including in particular the assessment of the effects of relevant measures on the improvement of the quality of the marine environment. Such assessments will provide additional information and assessments in respect of the MSFD, enhance the OSPAR quality status reports (QSRs), take into account the Directive's obligations for regional cooperation, and help inform the debate on the development of further measures.

Aqueous inputs (direct or riverine) of contaminants, together with atmospheric deposition, are important sources of contaminants to OSPAR marine waters. Dynamic equilibria exist between the dissolved fractions of the total burden of contaminants, such that contaminants are partitioned between the dissolved state and particulate and colloidal phases in the water column, as well as becoming associated with bottom sediments and biota. The rates of exchange of contaminants between the water and the sediment or biota mean that changes in inputs are likely to be reflected more rapidly in the water than in, for example, bottom sediments. However, this sensitivity to change, and the partitioning between components of the aqueous phase, are also reflected in relatively high spatial and temporal variances in the observed concentrations. The selection of water as a monitoring matrix can therefore be appropriate for a number of reasons. These include the ability to observe short-term variations in contaminant pressure on organisms. Focusing on contaminants that partition strongly into the water rather than the sediment or biota can lead to water being the preferred

matrix for monitoring. OSPAR background documents on chemicals for priority action may provide valuable information with regard to the preferred monitoring matrix. In the context of the JAMP, coordinated monitoring of contaminants in seawater may be carried out in relation to the temporal changes in the degree of pollution, its spatial variation, or as an element of integrated monitoring and assessment of contaminants and biological effects.

Temporal trend monitoring can assess the effectiveness of measures taken to reduce contamination of the marine environment. The statistical assessment of a trend over a longer period also supplies a more reliable assessment for the environmental status within a certain period. The fitted value of the last year measured has been used in OSPAR CEMP assessments as the optimum value for comparing against assessment criteria and hence for assessment of the actual environmental status. In such a way, the within- and between-year variability is taken into account.

Spatial distribution monitoring can describe the existing level of marine contamination widely through the convention area. The measured levels can be compared to background or close to background concentrations, as well as to levels describing thresholds below which no chronic effects are expected to occur in marine species, i.e. environmental assessment criteria (OSPAR, 2009).

Contaminant analysis of seawater can be an element of integrated monitoring and assessment, where chemical and biological effects measurements are combined, in order to assess potential harm to living resources and marine life (OSPAR, 2012). The role of chemical measurements in integrated chemical and biological effects monitoring programmes is to support biological effects programmes by providing information to help identify the chemical causes of observed biological effects. In general, chemical measurements in seawater should contribute to improve and extend OSPAR's monitoring framework and better link it with the understanding of biological effects and ecological impacts of individual substances and the cumulative impacts of mixtures of substances.

Furthermore, beyond the objectives of the JAMP, monitoring of contaminants in water can provide information on the fate of contaminants in the environment, e.g. transformation, partitioning, and transport processes.

3. Quantitative objectives

Seawater monitoring should provide concentrations of target analytes in water, which are representative of the location and time of sampling. General considerations regarding the specification of quantitative objectives for monitoring are given in the JAMP (OSPAR, 2010). More specifically, the following issues should be considered prior to water monitoring: contaminant speciation, detection limits, detectability of temporal and spatial trends, and costs.

3.1. Contaminant speciation

Trace metals and organic contaminants can exist as freely dissolved species in water or bound to colloids and suspended particulate matter (SPM). Trace metals can also exist as inorganic and organic complexes. The targeted contaminant fraction determines which sampling and/or pre-treatment method to use:

- Analysis of unfiltered water samples yields the sum of the concentrations of contaminants that are freely dissolved, complexed, and bound to colloids and SPM. These samples are also referred to as total water or whole water samples.
- Filtered water samples can yield the concentrations in SPM (by analysis of the residue on the filter) and the concentrations of contaminants that are freely dissolved, complexed, and bound to colloids (filtrate). However, many organic contaminants are known to exchange freely between dissolved and other phases in the water. The removal of components of the particulate matter is very likely to alter the position of these equilibria, while the introduction of filter material, container walls, etc. provides additional phases taking part in the equilibration processes. The complete separation of dissolved, colloidal, particulate matter is therefore a difficult task.
- Passive sampling yields the concentrations of freely dissolved contaminants (organics) or freely dissolved and complexed contaminants (trace metals).

The choice of the targeted contaminant fraction may be pre-defined by legal obligations. For example, monitoring under the Water Framework Directive requires the monitoring of metal concentrations in filtered water, and of organic contaminants in total (i.e. unfiltered) water.

3.2. Detection limits

The sample size has to be sufficient to support the desired detection limits for the contaminants of interest, for example to enable descriptions of spatial and temporal trends. For example, one litre discrete water samples may be sufficient for time trend monitoring of PAHs in contaminated harbours, but may be insufficient for monitoring programmes in open waters. For consistency with Commission Directive 2009/90/EC, a limit of quantification (LOQ) should be equal to or below a value of 30% of the relevant assessment criterion, e.g. the Environmental Quality Standard.

3.3. Statistical significance and power

In the context of temporal trend monitoring, it is important to know the statistical power of a time-series to detect changes, i.e. the probability of detecting true trends in concentration in the presence of variance associated with sampling, analysis, and field variability. The necessary or possible power of a monitoring programme will vary with the contaminant and area being investigated. One approach would be to estimate the power of the time series based on the “random” between-year variation. Alternatively, the lowest detectable trend could be estimated at a fixed power. A quantifiable objective could be to detect an annual change (dC/dt) of 5% within a time period of 6 years with a power of 90% at a significance level (α) of 5%. In the case of an expected decrease, the null hypothesis would be chosen as $dC/dt=0$ and the alternative hypothesis as $dC/dt < 0$.

A spatial monitoring programme should enable Contracting Parties to describe the distribution of contaminant concentrations in the survey area, for example to draw maps. These data can provide information to assist in the identification of representative stations for temporal trend studies, or for refinement of spatial surveys, and to implement measures where considered necessary. Statistical procedures can be used to estimate the number of samples and sampling sites needed to meet the required confidence level (i.e. to avoid Type I errors) and statistical power (to avoid Type II errors).

3.4. Costs

The concentrations of contaminants in water, as determined by discrete sampling, are commonly found to be quite variable, both in space and time, and meeting ambitious quantitative objectives may require extensive replication. Seawater sampling for contaminant analysis often requires equipment that is expensive to buy and maintain in good condition to keep the process blanks at low levels. The need for, and cost, of replicate water samples should be carefully considered in determining achievable quantitative objectives for a water-based monitoring programme. Therefore, it is often necessary to balance the scope and performance of monitoring programmes with available budgets.

4. Sampling strategy

The sampling strategy should reflect the purpose of the monitoring programme according to the JAMP (OSPAR, 2010) in relation to the OSPAR Hazardous Substances Strategy. Where applicable, the sampling strategy should consider requirements of the EU WFD (EU, 2000) and MSFD (EU, 2008); in all cases the quantitative objectives of the monitoring programme should be met (see Section 3). In accordance with the JAMP Guideline on Integrated Monitoring of Contaminants and Their Effects, seawater sampling should be carried out at the same time and locations as the sampling of other matrices (sediment, biota) and biological effects measurements (OSPAR, 2012).

A coherent approach to the detailed definition of a sampling strategy should take into account knowledge of the physical and biological oceanography of the area and requires consideration of temporal sources of field variance, such as seasonal factors, and spatial factors, such as the changes in location and water depth within the survey area. The analyte in question (its physical-chemical characteristics and expected concentration), as well as environmental conditions and practicalities, will further determine how samples are taken, e.g. what equipment is used and what volumes are required. However, sampling strategies also include compromises between scientifically advisable approaches and the economical and logistical frames of the sampling effort (see Section 3). It is therefore important that the objectives of monitoring programmes are expressed in quantitative terms and that they are achievable.

4.1. Temporal trend monitoring

The ability of a programme to identify temporal trends strongly depends on the extent to which unwanted sources of variability can be controlled. The short-term (< 1 year) temporal variability of contaminant concentrations in water is potentially very large. Concentrations may be subject to day-night variations in input and removal processes (Jaward *et al.*, 2004). In addition, concentrations at a fixed geographical position may vary over the tidal cycle (e.g. in estuaries). Further temporal variability may arise from variation in local inputs, such as discharges from ships, seasonality in the riverine discharge, changes in atmospheric deposition during rainfall events, and seasonal differences in seawater stratification. Some measures can be taken to reduce short-term temporal variability. These include sampling at pre-defined times of the year and at the same phase of the tidal cycle (e.g. always at high tide), although for ship-based discrete sampling it should be recognized that logistic constraints do not always allow such measures to be taken.

4.2. Spatial distribution monitoring

Analyte concentrations in seawater will vary between locations and with water depth, due to various physical and biogeochemical processes and the distribution of inputs. The expected spatial variability is an important factor in the development of an adequate geographical sampling scheme, i.e. the outline of the station grid and its vertical resolution (Brügman and Kremling, 1999). It should be recognized that the identification of spatial patterns may be obscured by

temporal variability (see Section 3.1), and that the same measures to reduce this source of variability also apply here. If the aim of the programme is to identify local sources of contaminants, then the sampling grid should be denser in the vicinity of suspected sources. Often, the variability of salinity or SPM content of the water can give an indication of the variability of pollutants and may even act as "normalization" factors.

4.3. Sampling method considerations

The proportion of the total concentration of a contaminant which is freely dissolved in the water phase increases with polarity of the pollutants (see Section 3). On the other hand, non-polar pollutants sorb to SPM and sediments and are thereby removed from the water column by sedimentation. For these contaminants, additional factors that should be taken into account are the SPM content and the volume of water that is sampled (see Section 3). These factors are important in filtration-extraction methods because the particle-bound and colloiddally bound contaminant fractions that escape phase separation depend on the extent of filter clogging (Hermans *et al.*, 1992). The measurement of SPM concentrations is even more important for monitoring contaminants in total water. The required water volume should be estimated before the sampling campaign, taking into account the method detection limits (see Section 3).

4.4. Supporting data

It is important that as much information as possible is collected concerning the waterbody being sampled. This includes co-factors such as salinity, SPM concentrations, and temperature. Whenever possible, sampling should be done as part of an integrated monitoring programme that includes the measurement of biological effects. These data should be obtained at the same time and locations as sampling for contaminant analysis.

4.5. Statistical considerations

Prior to starting a full-scale monitoring study, the available information on temporal variability should be carefully evaluated, possibly amended by a small-scale pilot programme. This evaluation should include a statistical assessment certifying that the objectives of the monitoring study can be met (see Section 3).

If no previous information exists, the sampling strategy can be based on a combination of general statistical principles and expert knowledge about sources and fate of the studied substances in the investigated sea basin. The statistical approach could include the principles of stratified sampling: First, the sampling area under consideration is partitioned into smaller more homogeneous areas, so-called strata. This can be based on simple information, such as depth, distance to land, or measured or modelled salinity. A successful stratification is characterized by a small variation of the measured concentrations within each stratum and a substantial variation between strata. For optimal allocation of the samples, the size (volume or area) of each stratum should be determined. Assuming that there are m strata with volumes V_1, \dots, V_m and that the standard deviation of the target variable is about the same in all strata, the number of samples n_j in stratum j shall be taken approximately proportional to the volume V_j , i.e.

$$n_j \approx n \frac{V_j}{V}$$

where V is the total volume of the investigated sea basin and n is the total number of samples.

If the standard deviation of the target variable varies from stratum to stratum, more samples should be taken in strata with high standard deviation. More specifically, the sample numbers chosen should aim at making n_j proportional to $S_j V_j$, where S_j is the standard deviation in the j th stratum, i.e. letting

$$n_j \approx n \frac{S_j V_j}{\sum_{j=1}^m S_j V_j}$$

Finally, the average concentration in the study area is estimated to be

$$\sum_{j=1}^m V_j \bar{X}_j / V$$

where \bar{X}_j is the average observed concentration in the j th stratum.

4.6. Discrete sampling versus time-integrated sampling

Concentrations of contaminants in water respond quickly to changes in inputs and other environmental conditions, unlike concentrations in sediments and biota. This low level of time integration can be of advantage in detecting peak events but, on the other hand, concentrations in water are likely to show relatively high variability, which can have drawbacks in long-term monitoring and may require high sampling frequencies, causing high costs.

The influence of temporal variability may be reduced by time-integrated sampling. However, continuous water intake over a prolonged time period, followed by filtration and extraction, may often prove to be impractical and costly, particularly for ship-based sampling programmes. Unattended integrative devices, such as passive samplers (PSDs) also yield a time-integrated concentration if the necessary calibration parameters are available for the target analytes. Considerations for evaluating whether the necessary PSD calibration parameters are available for non-polar organic analytes are given by Lohmann *et al.* (2012). PSDs for polar contaminants (pharmaceuticals, detergents, and personal care products) are insufficiently mature for quantitative spatial and temporal trend monitoring at present, but may be useful in initial surveys. Diffusive gradients in thin films (DGT) is a mature PSD technique for trace metals, but its application in the marine environment has been quite limited so far (Mills *et al.*, 2011). All PSDs require suitable deployment sites, such as jetties, buoys, bottom landers, long-term moorings, etc, which always have to be visited twice and some losses due to other marine activities may be expected. If the monitoring programme requires sampling of total water, this will limit the applicability of PSDs.

5. Sampling equipment

The choice of sampling equipment depends on the physical-chemical properties and expected concentrations of the analytes, on the depth and location of the sampling site, and on the available infrastructure. All materials used for the sampling equipment (sample containers, tubing, connectors, valves, pumps, filters) should neither absorb nor release the target analytes, or any non-target substance that interferes with the chemical analysis. Contaminants are held in a range of dissolved, colloid, and particulate phases. These have a potential to interact differently with sampling equipment, and also for contaminants to exchange between phases during sample processing. Sampling equipment and processing therefore needs to be rigorously tested before adoption in large-scale monitoring programmes.

Since concentrations of organic contaminants and metals in seawater are usually very low, large volumes of water must be sampled. Contamination of the sample by compounds that leach out of the sampling equipment as well as analyte loss due to wall sorption are serious issues which may affect the integrity of seawater samples.

Sample contamination from the atmosphere should be avoided (e.g. paint and rust particles, engine exhausts, atmospheric background). To minimize contamination from the atmosphere, the surfaces of the sampling equipment in contact with the sample should be isolated from the atmosphere before and after the sampling, including storage of the equipment. These surfaces should be cleaned using appropriate solvents prior to sampling. Equipment blanks and recovery samples yield important quality control information that can be used to assess sample contamination and analyte losses, bearing in mind the potentially site-specific nature of airborne contamination.

Concentrations of target analytes in the water may be elevated because of leaching from the sampling platform itself (e.g. polyaromatic hydrocarbons (PAHs), organotin, polychlorinated biphenyls (PCBs), iron, and chlorofluoroalkanes can be released from the ship during ship-based sampling). The ship's keel should be at an angle of 20 to 40 degrees to any current coming from the bow at the sampling side (typically starboard side), to minimize any influence from the ship's hull.

Since the sampling equipment passes through the air-water interface, contamination from the sea surface microlayer is a significant risk. Concentrations of dissolved and particulate matter are elevated in this microlayer, and the associated analytes may therefore contaminate samples that are taken at larger depth. Sample contamination from the microlayer can be avoided by closing the sampling equipment during passage through the sea surface and only allowing sample intake at the intended depth.

5.1. Trace metals (including MeHg)

Contamination from the ship has to be avoided at all times. For analyses of trace metals, all contact between the seawater sample and metal must be avoided. On approaching a station, the sampling for trace metals has to be performed immediately. Hydrographical information about water depth and the stratification of the water column should be available.

Discrete samplers that are specially designed for trace metal analysis should be used, e.g. GO-FLO (from General Oceanic), available in sizes from 1.7 to 100 litres, or MERCOS samplers (from Hydrobios; or modified version, size 0.5 litre). They are typically operated on a Teflon, polymer, or Kevlar jacketed stainless steel hydrographic wire, tensioned

by a coated bottom weight. The messengers should also be free of metals; any essential metal parts should be of seawater resistant stainless steel (V4A).

Samples should be taken so as to avoid contamination by leachate from the hull of the ship. Sampling bottles should be made of plastic with low metal content, e.g. special low-density polyethylene (LDPE) bottles. For mercury, glass should be preferred if the samples are stored for a longer period. Teflon bottles may also be used, but they are relatively expensive and, depending on the manufacturing process, may have a relatively rough inner surface.

Pumping using metal-free devices may be an alternative to discrete sampling, e.g. for separating SPM by subsequent centrifugation, but is not preferable when sampling from a ship at distinct sampling depths or in the open sea where concentrations are very low. More details on sampler types are described in the Technical Annex.

After sampling, the sampler should be placed immediately in a plastic bag or box or an aluminium container (if aluminium is not determined), followed by transport to a clean-room or laboratory with a clean-air bench. These measures are particularly critical for open sea samples where the expected concentrations of trace metals are very low.

5.2. Organic contaminants

Concentrations of organic contaminants in seawater are usually very low. In order to reach the projected LOQs in the low pg l^{-1} range, large water volumes (10 to 100 l or more) have to be collected and extracted. With modern analytical equipment, these LOQs are often not limited by the signal intensity in the instrumental analysis, but by blank levels and interferences from the matrix background.

Hydrophobic compounds occur in a continuum of dissolved, colloidal, and particulate-bound forms. Unless a total concentration is to be determined, the compound partitioning must not be altered during sampling and subsequent treatment. This is very challenging, as the separation process must be contamination-free and should not change the concentration distribution. It should be applied during or immediately after sampling. For details, see Section 6.2.

Sometimes blank problems can only be overcome by increasing the sample size. However, the maximum sample size may be limited by operational constraints, such as container size for discrete samplers, pumping time, and the ability to process large water volumes. Blank levels can be reduced by minimizing the size of the sampling equipment (e.g. short inlet tubes) and by using sampler designs and handling procedures that minimize exposure to the atmosphere (short assembly/disassembly times). The use of *in situ* filtration/extraction equipment that is both compact and easy to operate combines the advantages of small size and short exposure to the atmosphere. This holds even stronger for passive samplers (see Section 4.6), provided that the sampling phase is sufficiently clean and that times of exposure to the atmosphere during deployment and retrieval are sufficiently short.

The materials used for the sampling equipment depend on the target contaminants. Sampling equipment for organic contaminants in seawater is preferably made of glass or stainless steel. Teflon parts are often used for legacy persistent organic pollutants (POPs), while they cannot be used for sampling of fluorinated compounds. Before use, the equipment has to be cleaned, e.g. rinsed with appropriate organic solvents. Examples of sampling equipment suitable for organic contaminants are presented in the Technical Annex.

6. Storage and pre-treatment of samples

The storage and pre-treatment of samples should be carried out in full awareness of the risks of contamination or analyte loss if samples are handled incorrectly. Appropriate measures should be taken to avoid contamination, such as wearing clean gloves, pre-cleaning equipment, etc. All storage and pre-treatment steps should be fully documented for each sample. Field control samples (for assessing sample contamination) and surrogate spikes (for assessing analyte losses) should be processed regularly as part of the quality assurance and control procedures (see Section 8). All storage and pre-treatment steps should be fully validated prior to the start of a monitoring programme.

6.1. Storage

It is advisable to process samples as soon as possible rather than store them for a longer period of time. Storage of samples increases the risk of changing concentrations, by microbial degradation or sorption processes. However, appropriate laboratory facilities for handling of samples for trace analyses need to be available. If this is not the case, samples may have to be conserved. Water samples for metal analysis are typically acidified for conservation purposes. Sub-sampling of seawater, if required, should preferably be performed immediately after sampling.

Water samples for organic pollutants generally are impractical to store because of their large volumes. Instead, they are extracted onboard by liquid-liquid extraction (LLE) or solid-phase extraction (SPE) and the extracts or adsorbent cartridges are stored under cool ($< 4^{\circ}\text{C}$) and dark conditions. If water samples must be stored, this should also be in the

dark and in a refrigerator (4°C). Preferably, internal standards (e.g. isotopically labelled analogues) should be added before extraction or/and storage. Storage times should be kept as short as possible and the stability of all compounds during storage must be checked.

Only appropriate (pre-cleaned) containers should be used for short- or long-term storage. The analytes of interest determine the appropriate container material (plastic, glass, metal), the need for acidification, and the optimal storage temperature. All storage conditions should be fully validated by the laboratory that carries out the monitoring, since sample contamination and loss of analyte may be affected by subtle changes in the materials and procedures for sample storage. SPM samples should always be stored frozen until further analysis.

6.2. Sample pre-treatment

The need for filtration of samples is mainly determined by the monitoring programme which typically will specify the analysis of either filtered or unfiltered water (total water, whole water). No pre-treatment is required for the analysis of whole water, although acidification may be necessary as part of the extraction procedure, depending on the analyte and on the extraction method used.

Filtration is the preferred technique to separate the dissolved phase from the SPM for small volume samples (e.g. for metal analysis). Polycarbonate or cellulose acetate filters with a pore size of 0.45 µm are frequently used for trace metal determinations, whereas glass fibre filters (0.7 µm or 1.2 µm pore size) are commonly used in the analysis of non-polar and polar organic contaminants. The efficiency of the separation between dissolved and particulate contaminants depends on the pore size of the filters, and may also depend on SPM content of the water and on the sample intake (see Section 4). Adsorption of dissolved analytes to the filter may be an issue for some compounds, and should be addressed during method validation.

A flow-through centrifuge is suitable for obtaining SPM from large volume samples, but less suitable for obtaining particle free water as the separation is incomplete. In general, the efficiency of the separation depends on the geometry and operating conditions of the centrifugation equipment (residence time, effective gravity force), as well as on the density and size of the SPM. Filtration is more effective in this respect, but also more susceptible to artefacts and more time consuming. Ideally, filtration should occur online while sampling or immediately after sampling.

7. Analytical procedures

Analytical methods should be specific to the target analytes and sufficiently sensitive to allow analyses of seawater samples which generally have low concentrations of contaminants. They should meet minimum performance criteria consistent with Commission Directive 2009/90/EC, including an uncertainty on measurements < 50%, estimated at the level of the relevant Environmental Quality Standard, and an LOQ ≤ 30% of the Environmental Quality Standard. If no method meets the minimal performance criteria, the best available analytical method, not entailing excessive costs, should be used. All analytical methods should be capable of being brought under statistical control to ensure adequate quality assurance and quality control. It should be noted that analyses at such low concentrations require extensive experience.

7.1. Trace metals

Analysis of trace metals in seawater generally includes pre-treatment and pre-concentration steps, followed by detection using element-specific spectrometric instrumental procedures, e.g. graphite furnace atomic absorption spectrometry (GFAAS), inductively coupled plasma mass spectrometry (ICP-MS), anodic stripping voltammetry (ASV), and total reflection x-ray fluorescence (TXRF). For mercury, further methods and instruments are used, such as cold vapour atomic absorption spectrometry (CVAAS) and cold vapour atomic fluorescence spectrometry (CVAFS). These techniques are usually combined with a pre-concentration by amalgamation. ICP-MS is also used for mercury analysis.

7.2. Organic contaminants

Organic contaminants are usually found in the water phase at low concentrations, entailing the need for an extraction and enrichment step (e.g. SPE, LLE, solid-phase micro extraction (SPME)) and a selective chromatographic/detection step (e.g. GC-MS⁽ⁿ⁾, GC-ECD, LC-MS⁽ⁿ⁾, LC-FL) within every analytical procedure. Depending on the analytes chosen, the water body studied and expected pollutant concentration, clean-up may be necessary. Although GC-MS/MS and HPLC-MS/MS are very selective techniques, it is good practice to use a second MS transition as a qualifier.

8. Quality assurance (QA)

The quality assurance programme should ensure that the data conform to the quantitative objectives of the programme (see Section 3). The laboratory must establish a quality assurance / quality control system, if necessary consistent with

requirements in Commission Directive 2009/90/EC. All field and laboratory procedures should be fully validated, and the laboratory should also participate in intercalibration exercises and proficiency testing to provide external verification of results. The quality assurance procedures should cover sampling design, sampling, sample storage, analytical procedures (including field controls, analytical blanks, and recoveries), equipment maintenance and handling, training of personnel, data management, and an audit trail.

The use of a second (and different) sampling method, carried out simultaneously to the routine procedure, can be included in the validation process. All QA and QC data should be fully documented.

Because of the extremely low concentrations of pollutants in seawater, blank problems are generally more relevant and more difficult to control than in other matrices. Even ultra-pure chemicals and solvents used sometimes have to be purified before use. Concentrations are often close to the LOQs, which means difficult calibration and integration, and reduced analytical precision.

In addition, the following problems are encountered specifically in seawater analyses of organic contaminants:

- Because of the large sample volumes, it is not possible to analyze replicate samples on a routine basis or to take samples for back-up analysis. However, it is often possible to make a plausibility check by comparing the results with those of samples taken from adjacent stations in a homogeneous water body. Homogeneity can be assessed from oceanographic parameters, like salinity.
- No certified reference materials are available for organic contaminants in seawater. Therefore, laboratory reference materials have to be used, which should preferably be a natural or spiked extract from a typical monitoring station. Extraction efficiencies should be checked by standard addition tests.
- Laboratory performance studies (e.g. by QUASIMEME) are difficult to perform and to evaluate because sample volumes in these studies (max. 1 l) differ from those used in real analysis (>10 l). Thus, concentration ranges in the tests are often higher than in real-life samples.

For temporal trend monitoring in particular, it is extremely important to perform reliable and reproducible high-quality analyses over decades. Therefore, such analyses require well-documented procedures and experienced analysts (see Section 7).

9. Reporting requirements

Secure data storage and appropriate access to the data should be ensured by submission of data to national databases and to the ICES database. Reporting requirements will depend on the database. For entry of OSPAR data into the ICES database, data of trace metals and organic contaminants should be reported in accordance with the latest ICES reporting formats.

The calculation of results and the reporting of data can be major sources of error. Control procedures should be established in order to ensure that data are correct and to avoid transcription errors. This could include comparisons with independently obtained results for the same area or with typical concentration intervals. Data stored in databases should be checked and validated, and checks are also necessary when data are transferred between databases.

Concentrations of trace metals and organic contaminants in seawater should be given in weight per volume (e.g. ng l^{-1}). To ensure correct interpretation, reporting should include information on the sampling method, filtration (filter type and pore size), storage/conservation, and analytical method. Minimum performance criteria such as LOQ and uncertainty measurement along with relevant QA/QC data such as reference material analyses should be included in the report.

The purpose of the monitoring, geographical coordinates, and the name of the sampling stations should be reported in the data as well as being defined in the OSPAR Station Dictionary (<http://www.ices.dk/datacentre/accessions/>). Sample depth, suspended particulate matter concentration, and physicochemical parameters at the time of sampling, such as air and water temperatures, salinity, pH, and weather conditions, should also be reported.

10. References

- Brügmann, L., and Kremling, K. 1999. Sampling. In Graßhoff, K., Ehrhardt, M., and Kremling, K. (Eds.). *Methods of seawater analysis*. 3rd edition. Wiley-VCH, pp. 1–26.
- EU. 2000. Directive 2000/60/EC of the European Parliament and of the Council of 23 October 2000, establishing a framework for Community action in the field of water policy (Water Framework Directive).
- EU. 2008. Directive 2008/56/EC of the European Parliament and of the Council of 17 June 2008, establishing a framework for Community action in the field of marine environmental policy (Marine Strategy Framework Directive).

- Hermans, J. H., Smedes, F., Hofstraat, J. W., and Cofino, W. P. 1992. A method for estimation of chlorinated biphenyls in surface waters: influence of sampling method on analytical results. *Journal of Environmental Science and Technology*, 26: 2028–2034.
- Jaward, F., Barber, J. L., Booij, K., Dachs, J., Lohmann, R., and Jones, K. C. 2004. Evidence for dynamic air-water coupling of persistent organic pollutants over the open Atlantic Ocean. *Journal of Environmental Science and Technology*, 38: 2617–2625.
- Lohmann, R., Booij, K., Smedes, F., and Vrana, B. 2012. Use of passive sampling devices for monitoring and compliance checking of POP concentrations in water. *Environmental Science and Pollution Research*. doi: 10.1007/s11356-012-0748-9.
- Mills, G. A., Fones, G. R., Booij, K., and Greenwood, R. 2011. Passive sampling technologies. *In* Quevauviller, P., Roose, P., and Verreet, G. (Eds.). *Chemical Marine Monitoring. Policy Framework and Analytical Trends*. John Wiley and Sons, Chichester, pp. 397–432.
- OSPAR. 2009. Background Document on CEMP Assessment Criteria for QSR 2010.
- OSPAR. 2010. Joint Assessment and Monitoring Programme 2010–2014. OSPAR Agreement 2010-4.
- OSPAR. 2012. JAMP Guideline for the Integrated Monitoring and Assessment of Contaminants and their effects. Currently in preparation. http://www.ospar.org/content/content.asp?menu=00900301400135_000000_000000.

Technical Annex: Sampling equipment for analysis of trace metals and organic contaminants in seawater

1. Trace metals

1.1 Discrete sampling

An example of a discrete sampler is the GO-FLO sampler by General Oceanics (Figure 1). This sampler consists of a cylinder with an inner Teflon-coating which can be closed and lowered into the water column and opens automatically at a certain depth (ca. 10 m) by hydrostatic pressure. This avoids contact of the sample with the water surface where some contaminants can accumulate. At the desired depth, a messenger is sent on the hydrographic wire (made of Teflon coated stainless steel, polymer, or preferably Kevlar) to release the closing valves in both ends of the sampler. Each bottle can be equipped with a second messenger that is released when the valves close. Water samples can be collected from a range of depths by mounting a series of bottles along the cable.

A variety of the GO-FLO sampler is the reversing water sampler. The messenger releases the sampler from the upper attachment, it rotates, and closes the two valves. If a special thermometer type is attached to the sampler, it fixes the actual temperature at the sampling depth, which can be determined later on board. This accessory can be used when no CTD-sensor is used to record the temperature profile.

Generally, all samplers must be cleaned before the first use by rinsing the inner surfaces with diluted hydrochloric acid. In the open sea, this may not be necessary between sampling where rinsing with deionised water is sufficient in most cases. In the open sea, seawater is sufficiently clean to rinse the outer surface. Samplers with rubber parts which cannot be acid-cleaned or cannot be closed during deployment should be avoided.



Figure 1 Picture of a GO-FLO sampler (General Oceanics; photo courtesy of IFREMER, France).

The MERCOS sampler (Hydrobios Kiel) is designed for two 500 ml thick-walled cylindrical or ball-shaped Teflon bottles, which are closed by two silicone tubes of different diameters in the water. As the bottles are filled with air, the operating depth is restricted to about 50 m for the cylindrical and about 200 m for the globular type. However, this sampler is no longer offered by the manufacturer (<http://www.hydrobios.de>, 2012).

A modified version for four bottles was developed by the Bundesamt für Seeschifffahrt und Hydrographie (BSH, Germany), maintaining the triggering device, but using LDPE bottles of low metal content material (NALGENE) that are protected against the water pressure by a polyacrylate mantle. The LDPE bottles are cheaper and easier to clean due to the smooth inner surface compared to the relatively rough texture of the thick-walled Teflon bottles. Therefore, the LDPE usually show much lower blank values.



Figure 2 Modified MERCOS water sampler of the second generation for four bottles, manufactured by BSH, Germany (photo courtesy of S. Schmolke, BSH, Germany).

1.2 Sampling by pumping

For depths down to 100 m, perhaps even 200 m, it can be practicable to pump seawater up through silicone or Teflon tubing, optionally including in-line filtration. The tubing should be cleaned by pumping acid (e.g. 10% hydrochloric acid) prior to sampling. The first litres of seawater sampled should be subsequently discarded. A peristaltic pump or Teflon piston pumps are suitable. The peristaltic pump can be placed between the sampling tube and the filter. The outflow from the in-line filter can then be collected in polyethylene bottles, Teflon bottles, or in glass or quartz bottles for mercury analyses.

2. Organic contaminants

Large volumes of seawater samples are usually needed for the analysis of organic contaminants. Sampling devices depend on the amount of sample to be processed and the method of extraction (liquid–liquid extraction (LLE) or solid-phase extraction (SPE)).

LLE and SPE do not yield exactly the same concentrations as they use different extraction principles. While SPE effectively extracts only freely dissolved compounds, LLE extracts freely dissolved compounds and also compounds complexed with humic acids and, in part, compounds bound to particles (Sturm *et al.*, 1998). Non-polar compounds can be extracted by either LLE or SPE, whereas the extraction of polar compounds generally requires SPE.

Volumes of 1 to 100 l can be sampled by discrete sampling and/or pumping and are usually extracted either by LLE or SPE. Sample volumes >100 l are generally sampled by pumping and extracted by SPE.

2.1 Discrete sampling

Several different sampling devices have been designed for discrete sampling depending on the volumes needed and the extraction techniques to be applied.

All-glass bottle samplers for volumes of 10 L and 100 L are shown in Figure 3. They are mounted in a stainless steel cage and lowered on a hydrographic wire down to the desired sampling depth and opened under water. After filling, the sampler is brought on deck of the ship and the sample can be extracted by LLE directly in the sampler (using a non-polar solvent) or by SPE. For example, non-polar pollutants like organohalogen pesticides (e.g. DDX, HCH, HCB, dieldrin, endrin) can be extracted and enriched from seawater by means of LLE using hexane or pentane.

Gaul and Ziebarth (1983) described a 10 l glass sampler allowing extraction in the sampling flask itself, thereby minimizing uncertainties arising from sample handling, blanks, adsorption, etc. Later, the same principle was expanded to a 100 l flask, thus increasing the sample volume and lowering the limit of quantification (LOQ) by a factor of 10 (Theobald *et al.*, 1990). Figure 3 shows pictures of 10 l and 100 l sampling bowls. Extraction is done by agitating the samplers with 0.2 and 1 liter of pentane, respectively, using a stirrer. The glass sampler can be used to a depth of 2000 m (10 l) and 100 m (100 l).

Collecting samples at greater depth can be done with stainless steel bottles (Figure 4) holding about 30 litres. This type of sampler was developed based on experience with Niskin and Go-Flo type bottles, and has been used in analyzing dissolved herbicides in water samples collected down to 3000 m depth.



Figure 3 Left: BSH all-glass bottle water sampler (10 l). Right: 100 l glass flask sampler for sampling seawater for the analysis of organic contaminants.



Figure 4 A stainless steel sampling bottle, for subsequent analysis of organic contaminants in seawater.

2.2 Sampling by pumping – *In situ* filtration and extraction

For larger volumes of 200 to 1000 l, Schulz-Bull *et al.* (1995) described an SPE procedure using large extraction cartridges filled with XAD resins. With this adsorbent, they obtained good extraction recoveries for PCBs, DDT, and PAHs, but not for HCH.

Sampling by pumping can be performed with compressed air Teflon pumps (not suitable for subsequent analysis of perfluorinated compounds). In order to equilibrate the system with the sampling water, the water is pumped for about ten minutes before the actual sampling begins. Then the sampling bottles are thoroughly rinsed with the sample, before beginning the sampling itself. The hose is kept away from the ship's hull while the system is being rinsed, and during the collection of the sub-surface samples.

In situ filtration and solid-phase extraction sampling devices may minimize the risk of sample contamination during sampling. A typical *in situ* pump system, the Kiel In-Situ Pump (KISP), has been widely applied to the extraction of organic contaminants in seawater (Petrick *et al.*, 1996). A modified KISP has been described for seawater sampling on-board research vessels (Ebinghaus and Xie, 2006). Briefly, as shown in Figure 5, KISP includes a filter holder, a polymeric resin column, a pump, and a flowmeter. A glass fibre filter (pore size 0.7 μm) is used to recover the particulate phase and a glass column packed with polymeric resin for the dissolved phase. The KISP can be easily operated on board by connecting it to the ship's seawater intake system for sampling seawater at certain depths. The pump system assembly with batteries can be deployed at different depths on a hydrographic wire, and the pumping can be started and ended by remote control.

The original KISP contains some plastic parts and connections, which may present a contamination risk for some organic contaminants, such as brominated flame retardants, alkylphenols, and plasticizers. Low blanks and detection limits have been obtained from KISP samples for legacy persistent organic pollutants (POPs), such as PCBs, DDTs, and HCHs (Lakaschus *et al.*, 2002; Sobek and Gustafsson, 2004). However, it is recommended that these parts are replaced by stainless steel or glass if KISP is to be applied for sampling seawater for the determination of other organic contaminants. Surrogate standards can be added to the resin column before sampling to control the extraction recoveries and storage. It should be noted that the validation of the *in situ* pump sampling method is difficult, and extraction efficiency may depend on dissolved organic matter and humic substances.

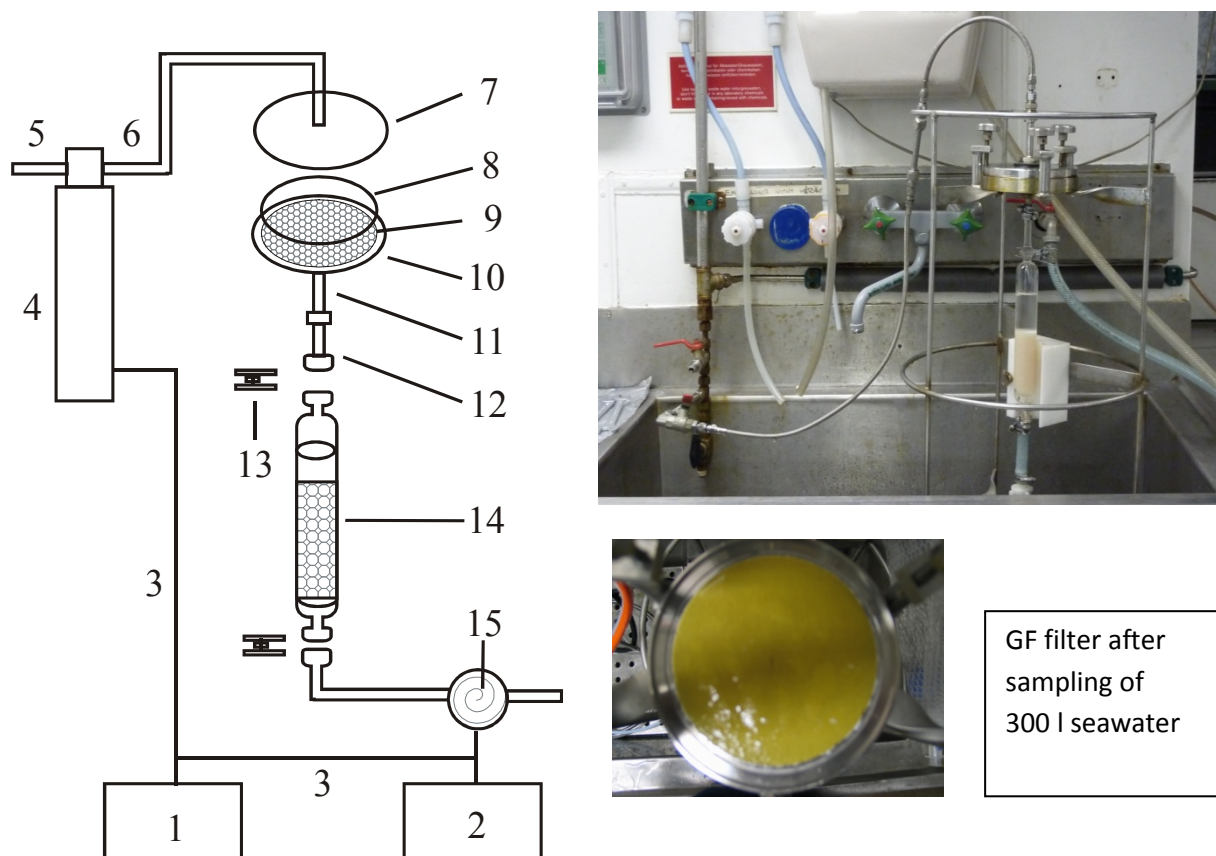

Figure 5 Schematic presentation of the Kiel In-Situ Pump (KISP). 1: flowmeter controller; 2: flowmeter; 3: cable connections; 4: pump; 5: pump inlet; 6: pump outlet; 7: stainless steel deck of filter holder; 8: GF 52 filter; 9: glass plate; 10: filter holder; 11: stainless steel tubing; 12 glass connect; 13 adjustable clip; 14: resins column; 15: counter of flow meter.

References:

- Ebinghaus, R., and Xie, Z. 2006. Occurrence and air/sea-exchange of novel organic pollutants in the marine environment. *Journal de Physique IV*, 139: 215–241.
- Gaul, H., and Ziebarth, U. 1983. Methods for the analysis of lipophilic compounds in water and results about the distribution of different organochlorine compounds in the North Sea. *Deutsche Hydrographische Zeitschrift*, 36: 191–212. (Journal now re-named *Ocean Dynamics*.)
- Lakaschus, S., Weber, K., Wania, F., Bruhn, R., and Schrems, O. 2002. The air-sea equilibrium and time trend of hexachlorocyclohexanes in the Atlantic Ocean between the Arctic and Antarctica. *Journal of Environmental Science and Technology*, 36: 138-45.
- Petrick, G., Schulz-Bull, D. E., Martens, V., Scholz, K., and Duinker, J. C. 1996. An *in-situ* filtration/extraction system for the recovery of trace organics in solution and on particles – tested in deep ocean water. *Marine Chemistry*, 54: 97–105.
- Schulz-Bull, D. E., Petrick, G., Kannan, N., and Duinker, J. C. 1995. Distribution of individual chlorobiphenyls in solution and suspension in the Baltic Sea. *Marine Chemistry*, 48: 245–270.
- Sobek, A., and Gustafsson, O. 2004. Latitudinal Fractionation of Polychlorinated Biphenyls in Surface Seawater along a 62° N–89° N Transect from the Southern Norwegian Sea to the North Pole Area. *Journal of Environmental Science and Technology*, 38(10): 2746–2751.
- Sturm, B., Knauth, H. D., Theobald, N., and Wünsch, G. 1998. Hydrophobic organic micropollutants in samples of coastal waters: efficiencies of solid phase extraction in the presence of humic substances. *Fresenius Journal of Analytical Chemistry*, 361: 803–810. (Journal now re-named *Analytical and Bioanalytical Chemistry*.)
- Theobald, N., Lange, W., Rave, A., Pohle U., and Koennecke, P. 1990. Ein 100-l-Glaskugelschöpfer zur kontaminationsfreien Entnahme von Seewasser für die Analyse lipophiler organischer Stoffe. *Deutsche Hydrographische Zeitschrift*, 43: 311–322. (Journal now re-named *Ocean Dynamics*.)

Annex VIII:

References

Annex VIII: References

GEOTRACES (2017). Sampling and Sample-handling Protocols for GEOTRACES Cruises (Version 3), edited by the 2017 GEOTRACES Standards and Intercalibration Committee.

HELCOM (2012a). Manual for marine monitoring in the COMBINE programme. Annex B-11, Appendix 1. Technical Note on the determination of trace metals (Cd, Pb, Cu, Co, Zn, Ni, Fe) including mercury in seawater.

HELCOM (2012b). Manual for marine monitoring in the COMBINE programme. Annex B-11 Appendix 2: Technical annex on the determination of heavy metals and persistent organic compounds in seawater. Appendix 2. Technical note on the determination of persistent organic compounds in seawater

IAEA (2011a). Recommended method on microwave digestion of marine samples for the determination of trace element content

IAEA (2011b) Recommended method for the determination of selected trace element in samples of marine origin by atomic absorption spectrometry using graphite furnace

ICES/OSPAR (2012). JAMP guideline on monitoring of contaminants in seawater: Annex 1: Guidelines for Monitoring of Contaminants in Seawater. ICES Advice 2012, Book 1

Kingston, H.M., Barnes, I.L., Brady, T.J., Rains, T.C., and Champ, M.A. (1978). Separation of eight transition elements from alkali and alkaline earth elements in estuarine and seawater with chelating resin and their determination by graphite furnace atomic absorption spectrometry. *Analytical Chemistry*, 50 (14): 2064-2070.

Loring DH and Rantala RTT (1991). Manual for the geochemical analyses of marine sediments and suspended particulate matter. *Earth-Science Review*, 32: 235:283. Elsevier Science Publishers B.V

UNEP/IAEA (2011). Sample work-up for the analysis of selected chlorinated hydrocarbons in the marine environment. Reference Methods for Marine Pollution Studies No 71

UNEP/MAP (2019a). UNEP/MED WG.467/5. IMAP Guidance Factsheets: Update for Common Indicators 13, 14, 17, 18, 20 and 21: New proposal for candidate indicators 26 and 27;

UNEP (2019b). UNEP/MED WG.463/6. Monitoring Protocols for IMAP Common Indicators related to pollution;

US EPA (1995). Method 1640: Determination of trace elements in ambient waters by on-line chelation preconcentration and Inductively Coupled Plasma Mass Spectrometry.

Appendix 22

**Monitoring Guidelines/Protocols for Sampling and Sample Preservation of Marine Molluscs
(such as *Mytilus* sp.) and Fish (such as *Mullus barbatus*) for IMAP Common Indicator 18**

1. Introduction

1. A fundamental aspect related to IMAP Ecological Objective 9 concerns the monitoring of the concentrations of different classes of harmful chemicals evaluated in relevant matrices i.e. sediment, sea water, and biota (CI17). These data need to be associated to the results concerning the level of the biological effects of the toxic contaminants that may be present in the marine environment where a cause and effect relationship has been established (CI18).
2. From the initial phase of the UNEP/MAP-MED POL Monitoring Programme, it was decided to attempt to highlight the early effects of the toxic contaminants on the marine life using biomarkers i.e. biological parameters which variations may highlight a pollutant-induced stress syndrome in the studied organisms.
3. At the present stage of IMAP implementation the following biomarkers are selected for regular monitoring³¹²: a) lysosomal membrane stability (LMS), a biomarker able to highlight an increased autophagy, diagnostic of the effects of toxic chemicals and prognostic of possible effects at population level; b) acetylcholinesterase (AChE) activity, a biomarker diagnostic of possible neurotoxic effects; c) micronuclei (MNi) frequency, a biomarker able to highlight the genotoxic effects of the contaminants; d) Stress on stress (SoS), a not mandatory biomarker suitable to reveal the reduced capacity of the organisms to survive to the action of further environmental stressors.
4. These biomarkers can be used in many different organisms. However, to ensure a comparability of the obtained results, the Molluscs (such as *Mytilus* sp.) and the fish (such as *Mullus barbatus*) were therefore selected for the biomarkers analysis². It should be noted that LMS in *Mullus barbatus* may be considered for inclusion as a mandatory parameter only if the capacities will be strengthened enough through the Inter-laboratory comparison to guarantee the correct use of this biomarker.
5. An important aspect for the collection of the animals is that both molluscs and fish must be living organisms, unstressed by the collection procedure and the handling/transport, before being dissected to obtain the tissues used for the biological analysis.
6. This Monitoring Guideline/ Protocols provides appropriate methodologies for sampling and transport of *Mytilus* sp. and *Mullus barbatus*, as well as for their tissue preparation under controlled conditions to ensure the representativeness and the integrity of the biological samples used for the analysis of the different biomarkers as provided in UNEP/MED WG.509/28 and UNEP/MED WG.509/29.

³¹² UNEP/MAP (2019) UNEP/MED WG.467/5. IMAP Guidance Factsheets: Update for Common Indicators 13,14, 17, 18, 20 and 21: New proposal for candidate indicators 26 and 27.

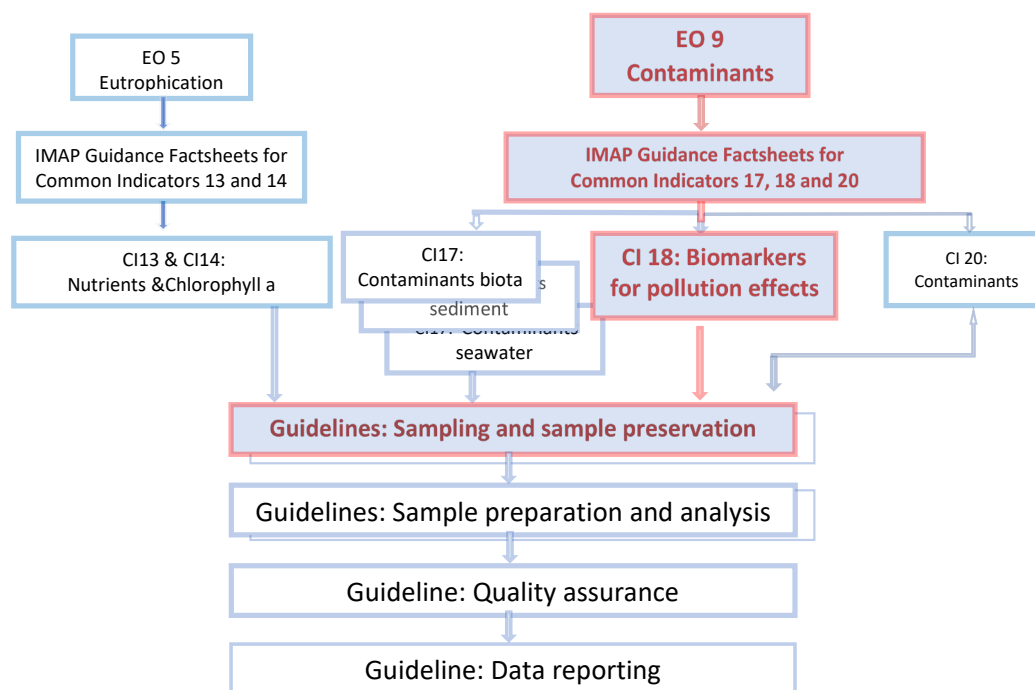

Flow Diagram: Monitoring Guidelines for IMAP Ecological Objectives 5 and 9

2. Technical note for the sampling and sample preservation of marine molluscs (such as *Mytilus* sp.) for biomarker analysis

7. The marine molluscs used to perform the biomarker toxicological evaluations should be also used for the chemical analysis as described in the Monitoring Guidelines/Protocols for Sampling and Sample Preservation of Marine Biota for IMAP Common Indicator 17: Heavy and Trace Elements and Organic Contaminants (UNEP/MAP WG. 509/23). Whenever possible the biomarkers and chemical analysis should be done on the same samples. This will allow better integration of biological effects and contaminants monitoring. The molluscs must be alive and maintained in good conditions. Molluscs (*Mytilus* sp.) are internationally recognized for decades of research and biomonitoring as ideal organisms for monitoring the marine coastal environment (OSPAR 1997³¹³; UNEP, 1997³¹⁴; UNEP/RAMOG, 1999³¹⁵; Moore et al., 2004³¹⁶; Martínez-Gómez et al., 2015³¹⁷; Hansson et al., 2017³¹⁸; etc.). Mussels are sessile, filter-feeding intertidal molluscs able to continuously sample the

³¹³ OSPAR, 1997. JAMP Guidelines for General Biological Effects Monitoring (OSPAR Agreement 1997-7). OSPAR Commission, Monitoring guidelines. Ref. No: 1997-7. 20 pp.

³¹⁴ UNEP, 1997. The MED POL Biomonitoring Programme Concerning the Effects of Pollutants on Marine Organisms Along the Mediterranean Coasts. UNEP(OCA)/MED WG.132/3, Athens.

³¹⁵ UNEP/RAMOG: Manual on the Biomarkers Recommended for the MED POL Biomonitoring Programme. UNEP, Athens, 1999

³¹⁶ Moore, M.N., Lowe, D. and Köhler, A. 2004. Biological effects of contaminants: Measurement of lysosomal membrane stability. ICES Techniques in Marine Environmental Sciences. No. 36. 39 pp.

³¹⁷ Martínez-Gómez, C., Bignell, J. and Lowe, D., 2015. Lysosomal membrane stability in mussels. ICES Techniques in Marine Environmental Sciences No. 56. 41

³¹⁸ Hansson, T., Thain, J., Martínez-Gómez, C., Hylland, K., Gubbins, M., Balk L., 2017. Supporting variables for biological effects measurements in fish and blue mussel. ICES Techniques in Marine Environmental Sciences. No. 60. 22 pp. <http://doi.org/10.17895/ices.pub.2903>.

water column; and to accumulate in their tissues the chemicals present in the dissolved and the particulate fraction (Goldberg et al., 1978³¹⁹; Bayne, 2009³²⁰; Viarengo et al., 2000³²¹).

8. In biomonitoring programmes, wild native mussels sampling can be organized; however, in this case, it is important to know that the chemicals accumulated in the tissues may reflect pollution events happened months or years prior to the sampling. Moreover, in the case of a large monitoring programme it is also important to take into account the fact that mussels from different populations may have different growth rates and gonad maturation stages due to the specific environmental conditions of the sampling areas (i.e. food availability, sea water temperature, salinity, etc.). Consequently, when wild mussels are used, it is recommended to evaluate the stage of gonadal development in the sampled molluscs, a parameter that can greatly change the physiological status of the organism.

9. In order to reduce the sampling problems that can occur from the use of wild organisms, it is possible to use caged farmed mussels instead (Viarengo et al., 2007³²²). The animals will be genetically homogeneous (being collected in the same farm) and at a similar stage of gonad development as they come from the same population; and the same size will correspond to the same age of the animals. Moreover, the contaminant background will be minimal and similar in all the animals. After a month of caging at the sampling site (i.e. a period of time that guarantees a quite similar stage of gonadal development in the mussels caged in the various sites along the coast), the toxic effects observed in the mussels will be directly related to the amount of harmful chemicals accumulated in the mussel tissues. For these reasons, the use of caged organisms, when possible, is highly recommended; however, this does not eliminate sampling of wild native mussels. A longer time of exposure (2 months or longer) may be applied; however, in this case it is necessary to evaluate the stage of gonad development to reduce the effects of the confounding factors. In this regard, it is important to highlight that the use of caged mussels also allows the evaluation of their survival rate after one month of exposure in the polluted areas: the incidence of mussel death is a very important parameter to readily identify extremely polluted areas, where the high concentration of toxic chemicals may cause lethal pathological alterations in the animals.³²³

10. The mussels have to be caged in containment structures (e.g. polyethylene bags, or better, non plastic bags, mounted on PVC tubing) for a period of at least of 30 days³²⁴ (Sforzini et al., 2018³²⁵). It is important that the mussels used for caging experiments are collected from a clean site, and that before to start the experiment.

11. Under this Technical Note, the Monitoring Guidelines for Sampling and Sample Preservation of Marine Molluscs (such as *Mytilus* sp.) and Fish (*Mullus barbatus*) for IMAP Common Indicator 18 provides the following two Protocols: i) Protocol for the collection and transport of marine molluscs

³¹⁹ Goldberg, E.D., Bowen, V.T., Farrington, J.W., Harvey, G., Martin, J.H., Parker P.L., Risebrough, R.W., Robertson, W., Schneider, E., Gamble, E., 1978. The Mussel Watch. *Environmental Conservation* 5, 101-125.

³²⁰ Bayne, B.L., 2009. *Marine Mussels: Their Ecology and Physiology*. Cambridge University Press 528 p.

³²¹ Viarengo, A.; Lafaurie, M.; Gabrielides, G.P.; Fabbri, R.; Marro, A., Roméo, M., 2000. Critical evaluation of an intercalibration exercise undertaken in the framework of the MED POL biomonitoring program. *Mar. Environ. Res.* 49, 1-18.

³²² Viarengo, A., Dondero, F., Pampanin, D.M., Fabbri, R., Poggi, E., Malizia, M., Bolognesi, C., Perrone, E., Gollo, E., Cossa, G.P., 2007. A biomonitoring study assessing the residual biological effects of pollution caused by the HAVEN wreck on marine organisms in the Ligurian Sea (Italy). *Arch Environ Contam Toxicol.* 53, 607-616.

³²³ It should be noted that a stress due to the caging bags was not found during realization of MEDPOL IV biomonitoring activities.

³²⁴ A period of 30 days is best for collecting data related to the analysis of biomarkers only; however, if samples are also taken for chemical analysis a period of at least 60 days should be ensured, along with providing information on gonad development.

³²⁵ Sforzini S, Oliveri C, Orrù A, Chessa G, Jha A, Viarengo A, Banni M., 2018. Application of a new targeted low density microarray and conventional biomarkers to evaluate the health status of marine mussels: A field study in Sardinian coast, Italy. *Sci. Total Environ.* 628-629, 319-328.

(such as *Mytilus* sp.) and ii) Protocol for the dissection and storage of tissue samples from marine molluscs (such as *Mytilus* sp.).

2.1 Protocol for the collection and transport of marine molluscs (such as *Mytilus* sp.)

a. Mussel collection

12. Mussels are intertidal organisms and, therefore, the sampling area may cover the entire length of the coastline if caged mussels are used. In the case of the sampling of mussels from wild populations, only the rocky zones will be adequate for the settlement of these bivalve molluscs.

13. The mussel sampling frequency suggested is once a year; the most adequate sampling periods are during the post winter months, but before or after the spawning period. Usually, in most Mediterranean coastal areas, the two periods are April-June and September-November; but the sampling periods may vary depending on the climatic characteristics of the various Mediterranean regions (ICES, 2011³²⁶; Moore et al., 2004). The selected frequency for the biomonitoring activities is also in line with the practice exercised during MEDPOL IV Biomonitoring.

14. *M. galloprovincialis* is a eurythermal species displaying a tolerance to a wide range of temperatures (from near-freezing to ~ 31 °C). Physiological studies of *M. galloprovincialis* indicate its acute upper thermal tolerance (e.g., as indicated by cardiac failure) can range from 26 °C to 31 °C, depending on the acclimation temperature and salinity (Braby and Somero, 2006³²⁷). Therefore, the sampling period should avoid periods when the ambient seawater temperature is above 24 °C.

15. Divers must collect the live mussels (wild or caged) manually at 5-7 m water depth. Mussel byssus threads should be cut from the substrate, since pulling the animals from the rocks (threading) can result in damage to internal tissues and induce an additional stress response in mussels. In case mussels living at the water/air interface are used, the contamination by lipophilic contaminants present in the water surface may alter the evaluation of the chemicals contents in the mussels soft tissues; moreover, the higher variability of this environment may influence the physiological status of the molluscs.

16. Mussel batches (both wild or caged animals) must consist of a standardized shell size usually 4-5 cm. A sufficient number of mussels is required to allow for biomarker analysis; the collection of 80-100 animals is suggested for the analysis of Lysosomal membrane stability (LMS), Micronuclei (MNi) frequency, Acetylcholinesterase (AChE) activity and Stress on Stress (SoS).

17. During the mussel collection a report should be prepared containing all sampling information data related to a) the sampling data as day, month and year, b) the number of molluscs sampled, c) the depth of collection (m), d) the georeferencing as Lat.-Long. (decimal degrees), e) location on the shoreline and the type of coast, f) type of site as reference or pollution gradient as distance from a polluted site (km), g) environmental data such as water temperature (C°), salinity (dimensionless) and dissolved oxygen ($\mu\text{mol L}^{-1}$); when possible, the data of the Chla concentration in the water may be also evaluated. If necessary, tidal values (m) should be also reported. All the information should be related to the sampling day.

18. For caged mussels it is necessary to include information on depth of deployment (m), time of immersion (days), water column depth (m) and source of mussels.

19. For the interpretation of the biological effects of the chemical contaminants, it is important not only to evaluate their concentrations in the environmental matrices but also to estimate the amount of priority contaminants accumulated in the mollusc tissues. In that respect it is recommended to monitor

³²⁶ ICES, 2011. Report of the Study Group on Integrated Monitoring of Contaminants and Biological Effects (SGIMC), 14–18 March 2011, Copenhagen, Denmark. ICES CM 2011/ACOM:30. 265 pp

³²⁷ Braby, C.E., Somero, G.N., 2006. Following the heart: temperature and salinity effects on heart rate in native and invasive species of blue mussels (genus *Mytilus*). J. Exp. Biol. 209, 2554-2566.

same priority contaminants for CI 18 as they have been agreed for monitoring of CI 17 in biota matrix respectively Cd, HgT, Pb, PAHs, PCBs, Hexachlorobenzene, Lindane and Σ DDTs³²⁸. 50 additional mussels should be collected for the chemical analysis, taken to the laboratory, and maintained at the field T, in clean, aerated seawater (at least 1 L/animal) for 24 h to eliminate gut contents. Then the soft tissues should be processed as described in the protocols related to the different chemical analysis reported in the Guidelines for sample preparation and analysis of marine biota for the analysis of CI17: heavy and trace elements and organic contaminants³²⁹. In this regard it should be noted that additional chemical analysis is not necessary, but the integrative approach uses the data obtained during the chemical monitoring activities.

b. Mussel transport

20. After collection, the animals can be used for sample preparation directly in the field; therefore, on board clean space/laboratory facilities are necessary; however, the most usual procedure is to transport them to the laboratory. In this case, the animals are transported in a thermal insulated bag containing some ice cubes, the molluscs themselves being enveloped in a cotton tissue soaked with sea water; this ensures that the temperature in the container remains around 0-4 °C with a high humidity level. The transport should be undertaken within a period of 8 hrs; however, it should be noted that in some cases transportation cannot be completed within this period of time. In this case the laboratory should collect some preliminary data showing that no changes occur in control animals maintained for the selected period of time in the transport conditions. A specific common testing of the period of transportation should be exercised between the Parties.

21. In the laboratory, the Collection Report must be placed in the Biomarker Analysis Register; the animals must be immediately sampled by the researcher(s) in charge of the biomonitoring programme and the samples adequately coded. In the Register the names of the researchers involved must be reported together with all the information concerning the location of the fridge in which the samples are stored.

22. Finally, it is also important to take into account that in the south-east of the Mediterranean basin there are coastal areas where *Mytilus* sp. are not present. In these areas, the use of the clams *Paratapes textilis* or *Pinctada radiata* is recommended. These bivalve molluscs are benthic organisms that live in sand and, therefore, will give broadly similar information, as would be obtained from mussels, about the effects of the contaminants present in the suspended organic material (the most important component of the diet of these filter-feeding molluscs) and those released from the sediments into the interstitial water. Although not exactly the same as the information obtained with mussels (i.e., intertidal organisms exposed to the contaminants present in the water column), the analysis of the biomarkers in these organisms will also permit the measurement of the harmful biological effects of the complex contaminant mixtures present in the marine coastal environment.

23. The integrated chemical-biological assessments of the effects of the contaminants present in the marine environment supports provision of data needed for GES assessment. As for the chemical monitoring, sample collection for biomarkers should be focused on selected locations such as hotspots and control or reference sites.

2.2 Protocol for the dissection and storage of tissue samples from marine molluscs (such as *Mytilus* sp.)

a) Materials

³²⁸ UNEP/MAP (2019). UNEP/MED WG.467/5. IMAF Guidance Fact Sheets: Update for Common Indicators 13, 14,18, 18, 20 and 21: Nes proposal for Candidate Indicators 26 and 27

³²⁹ It should be noted that in some cases the logistic problems and physiological impacts on animals may be caused by maintaining mussels for 24 h in clean, aerated seawater to eliminate gut contents

24. Application of this protocol requires availability of the following materials: Scalpel blades and handles; Dissecting forceps, fine and medium; Dissecting fine scissors; 1 mL syringes; 20 mL syringes with 21G (40 mm) needle; Syringe filters 0.45 µm; 15 mL centrifuge tubes, polypropylene, sterile, conical bottom; Microcentrifuge tubes, snap cap, 2.0 mL; Volume adjustable pipette, 20-200 µL and 200-1000 µL; Pipette tips, 20-200 µL and 200-1000 µL; 2 L glass beaker; Ice and ice bucket; Thermos ice packs; Cryostat chucks; Aluminum foil / Parafilm; Plastic container (200-400 mL); Thermostatic plastic container (3-4 L); Labeling tape; Permanent marker; Paper sheets and pen.

b) Equipment

25. The following equipment is needed: pH meter; Magnetic stirrer; Aquarium air pump and bubbler; Liquid nitrogen storage container (Dewar); Freezers -80°C; Ruler; Weight scale (readability 0.1 g - 0.01 g).

c) Solutions and chemicals

26. The use of filtered sea water (0.45 µm) collected at the animals' sampling sites is recommended; alternatively, it is possible to use a physiological saline where the salinity and pH is the same as the conditions at the sampling sites. The salinity of the solution described below is about 30.5 PSU, however, in the Mediterranean Sea the salinity can reach up to 44 PSU³³⁰.

27. The chemicals and solution³³¹ needed for application of this protocol are as follows: Physiological saline: 20 mM (4.7 g) HEPES; 436 mM (25.48 g) NaCl; 53 mM (13.06 g) MgSO₄; 10 mM (0.75 g) KCl; 10 mM (1.47 g) CaCl₂. The NaCl concentration should be adjusted to take into account the sea water salinity at the sampling site. These components need to be dissolved in 1 litre of deionised water (using 2 L glass beaker and a magnetic stirrer). Then air bubble of the solution for 10 minutes is needed, and then adjustment to pH 7.9 (or to the sampling site's sea water pH) with 1M NaOH. There is a need to store the solution in a refrigerator, but to use it at room temperature.

28. Additionally, liquid nitrogen and n-Hexane are needed as reagents.

d) Tissue dissection

29. As mentioned above, preservation, storage and transportation to the laboratory from remote locations are key factors to undertake toxicological measurements in living organisms.

30. Molluscs (where possible *Mytilus* sp.) are opened by insert a scalpel halfway along their ventral surface; tissues are removed by using dissecting fine scissors and dissecting forceps and the tissues utilised for biomarker analysis. When possible, this rapid dissection should be done as soon as possible shortly after molluscs sampling (this should be done on board in clean condition).

31. Gills for the evaluation of AChE activity may be used as fresh tissue or rapidly frozen in liquid nitrogen and stored at -80 °C until the time of the analysis (Bocquené and Galgani, F. 1998³³²; UNEP/RAMOGÉ, 1999); gills for the evaluation of MNi frequency are removed, places in 15 mL centrifuge tubes and immediately processed (UNEP/RAMOGÉ, 1999; Barsiene et al., 2006³³³; Bolognesi and Fenech, 2012³³⁴).

³³⁰In line with present experience of Spain, alternatively use of filtered sea water, collected at the clean/reference sites in national coastal waters, at the salinity found at the sampling site, can be considered

³³¹ If not specified, the reagents must be of analytical grade

³³² Bocquené, G., Galgani, F. 1998. Biological effects of contaminants: Cholinesterase inhibition by organophosphate and carbamate compounds. ICES Techniques in Marine Environmental Sciences, No. 22

³³³ Barsiene, J., Schiedek, D., Rybakovas, A., Syvokiene, J., Kopecka, J., Forlin, L., 2006. Cytogenetic and cytotoxic effects in gill cells of the blue mussel *Mytilus* spp. from different zones of the Baltic Sea. Mar. Pollut. Bull. 53, 469-478

³³⁴ Bolognesi, C., Fenech, M., 2012. Mussel micronucleus cytome assay, Nat. Protoc. 17, 1125-1137.

32. Haemolymph cells for the evaluation of LMS (NRRT assay -Lowe et al., 1995³³⁵; UNEP/RAMOGÉ, 1999; Moore et al., 2004; Martínez-Gómez et al., 2015) are prepared in the following analytical procedure: a scalpel halfway is inserted along the ventral surface of the mussel and the valves are partially opened; a pipette tip (1000 µL) is inserted to allow the inset of the insulin syringe in the posterior adductor muscle of the mussel (Fig. 1A). N.B. it needs to remove the needle from the 1 mL syringe: the syringe needs to be fitted with a 21 G (0.5 mm inner diameter), 40 mm needle (a needle from a 20 mL syringe). The water is drained from the shells. The syringe is filled with 0.5 mL of physiological saline and then 0.5 mL of haemolymph are aspirated from the posterior adductor muscle of the mussel. After obtaining the haemolymph sample, the needle is discharged and the contents is expelled into 2 mL microcentrifuge tube.

33. Haemolymph cells for the evaluation of MNi frequency are obtained as described above for LMS (UNEP/RAMOGÉ, 1999; Bolognesi and Fenech, 2012).

34. Digestive glands for the evaluation of LMS (cytochemical assay on cryostat sections -Moore, 1976³³⁶, UNEP/RAMOGÉ, 1999; Moore et al., 2004; Martínez-Gómez et al., 2015) are obtained following this procedure: 5 small pieces of digestive gland (4-5 mm³) are rapidly excised from the mid part of the organ obtained from five different animals and placed on an aluminium cryostat chuck (aligned in a straight row across the center). The chuck should be pre-labelled and pre-cooled in ice. 10 animals will be analysed by preparing 2 chucks for the same field sample. While dissecting the tissue, the chuck must be leaved on ice. Then the chuck is placed for 40 seconds in a small plastic box (200-400 mL) containing pre-cooled n-hexane (hexane super-cooling prevents the formation of ice in the tissues and, hence, it reduces structural damage to the subcellular components) at -70 °C using liquid nitrogen filled in a thermostatic plastic container (3-4 L) (the temperature of about -70 °C is visualized by the solidification of the n-hexane, a certain amount of liquid n-hexane in the presence of a solid component will ensure the correct temperature for the sample treatment). The chuck is sealed with 2-3 pieces of Parafilm/aluminium foils and immediately stored at -70 °C (at this temperature the tissue preparations maintain their integrity for months).

e) Additional parameters to be recorded in this step (in the field or at the laboratory)

35. The following additional parameters need to be recorded in this step both in the field or at the laboratory:

- Mussels biometrics: length (to 0.1 cm), weight (to 0.1 g), soft tissue weight (to 0.1 g); dry soft tissue mass (to 0.1 g), dry shell mass (to 0.1 g);
- Condition Index (CInd): this parameter should be evaluated in a simple way as: $CInd = 100 \times \text{Dry soft tissue weight (to 0.01 g)} / \text{Whole animal dryweight (to 0.1 g)}$; alternatively, dry soft tissues mass / dry shell mass. More accurate (and complex) approaches are available such as: $CInd = 100 \times \text{Dry weight (to 0.1 g)} / \text{Internal shell volume (to 0.1 cm}^3\text{)}$ (ICES, 2011; Lutz, 1980³³⁷; Aldrich and Crowley; 1986³³⁸; Davenport and Chen, 1987³³⁹; Hansson et al., 2017).

³³⁵ Lowe, D.M., Soverchia C., Moore M.N., 1995. Lysosomal membrane responses in the blood and digestive cells of mussels experimentally exposed to fluoranthene. *Aquatic Toxicol.* 33, 105-112.

³³⁶ Moore, M.N., 1976. Cytochemical demonstration of latency of lysosomal hydrolases in digestive gland cells of the common mussel *Mytilus edulis*, and changes induced by thermal stress. *Cell Tissue Res.* 175, 279-287.

³³⁷ Lutz, R.A. 1980. *Mussel Culture and Harvest: A North American Perspective*, Elsevier Science Publishers, B.V. Amsterdam, 305pp.

³³⁸ Aldrich, J.C., Crowley, M. 1986. Conditions and variability in *Mytilus edulis* L. from different habitats in Ireland. *Aquaculture* 52: 273-286.

³³⁹ Davenport, J., Chen, X. 1987. A comparison of methods for the assessment of condition in the mussel (*Mytilus edulis* L.). *J. Molluscan Stud.*, 53: 293-297.

36. The presence of parasites in the soft tissues should be also reported (Francisco, C. J et al. 2010³⁴⁰, Robledo, J. A. F et al. 1994³⁴¹, Figueras, A. J et al. 1991³⁴²).

37. Sampled molluscs and their gonads should be recorded by a high-definition video camera (or smartphone video camera) to document the reproductive status of the animals. Samples of gonads should be frozen in liquid nitrogen and stored at -70 °C to be available, if necessary, for examination.

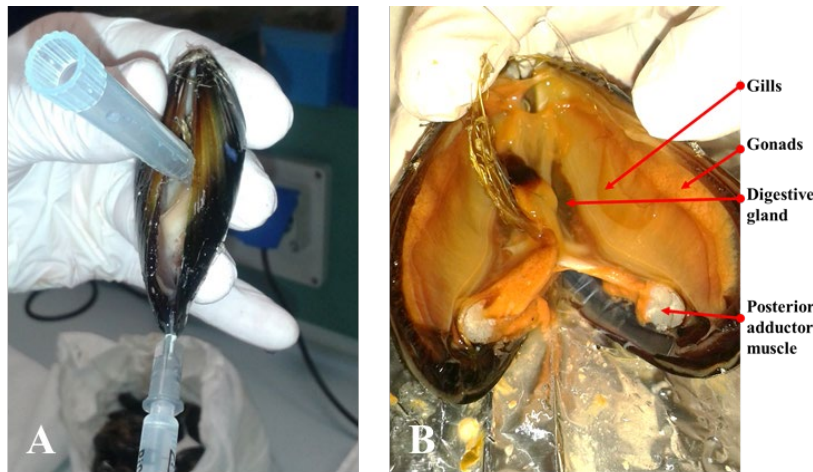

Fig. 1. A) Haemolymph extraction from mussel posterior adductor muscle; B) mussel tissue identification.

38. At the end of the procedure related to sample preparation and storage, a report must be prepared indicating the list and the code of the samples for the different biomarker analysis, the -80 °C fridge used for the storage of the samples and the location in the fridge of the different samples, as well as the list reporting the data related to all the additional parameters evaluated. The report must be added to the Register for the Biomarker Analysis. In the Report, it needs also to indicate the data of the samples' preparation and storage and the name of the researchers involved in the work.

3. Technical note for the sampling and sample preservation of marine fish (*Mullus barbatus*) for biomarker analysis

39. The aim of the MED POL Biomonitoring Programme is to provide a clear picture of the quality of the marine coastal environment in the Mediterranean area. An important aspect for achieving this target is the selection of the sentinel organisms to be used for the evaluation of the toxic effects of the marine contaminants.

40. The use of the same organisms throughout the different Mediterranean areas ensures more comparable ecotoxicological results. *Mullus barbatus* was selected as sentinel organisms on the basis of the results of numerous studies and of the previous activities in the framework of the MED POL biomonitoring programmes (UNEP/RAMOGÉ, 1999).

³⁴⁰ Francisco, C. J., Hermida, M. A., & Santos, M. J. (2010). Parasites and symbionts from *Mytilus galloprovincialis* (Lamarck, 1819) (Bivalves: Mytilidae) of the Aveiro estuary Portugal. *Journal of Parasitology*, 96(1), 200-205

³⁴¹ Robledo, J. A. F., Santarém, M. M., & Figueras, A. (1994). Parasite loads of rafted blue mussels (*Mytilus galloprovincialis*) in Spain with special reference to the copepod, *Mytilicola intestinalis*. *Aquaculture*, 127(4), 287-302

³⁴² Figueras, A. J., Jardon, C. F., & Caldas, J. R. (1991). Diseases and parasites of rafted mussels (*Mytilus galloprovincialis* Lmk): preliminary results. *Aquaculture*, 99(1-2), 17-33

41. The marine fish *M. barbatus* sampled to perform the biomarker toxicological evaluations should be also used for the chemical analysis as described in the Monitoring Guidelines/Protocols for Sampling and Sample Preservation of Marine Biota for IMAP Common Indicator 17: Heavy and Trace Elements and Organic Contaminants for CI17 (UNEP/MAP WG.509/23). The sampled fish have to be alive and in good conditions. Whenever possible, it is recommendable that once fish is on board, to keep it alive in aerated tanks using clean sea water before tissue dissection processing takes place.

42. The red mullet, *Mullus barbatus* (L.), is a fish that is widely distributed along all Mediterranean coast (www.fao.org/fishery/species/3208/en) and it was used in past years as a sentinel organism to evaluate the accumulation of toxic chemicals, as well as to study the harmful biological effects of environmental pollutants (Mathieu et al., 1991³⁴³; Porte et al., 2002³⁴⁴; Regoli et al., 2002³⁴⁵; Viarengo et al., 2007³⁴⁶; Martínez-Gómez et al., 2012³⁴⁷, 2017³⁴⁸) In this regard, it should be considered that the sex difference is essential for contaminants analysis and these analyses, when possible, should be done on same sex pooled samples. Its lifestyle (i.e. non-migratory animals, relatively localised in the coastal areas) and its feeding habits (e.g. their diet consists mainly of small benthic organisms such as crustaceans, molluscs and worms - www.fao.org/fishery/species/3208/en) render this fish as a suitable sentinel organism. *M. barbatus* is a batch spawner; the existence of a seasonal, depth-related movement in this species has been well described (Machias and Labropoulou, 2002³⁴⁹). Their toxic chemical intake reflects well the pollution level of the sediment from the inner and medium continental shelves and of the overlaying water column.

43. Under this Technical Note, the Monitoring Guidelines for Sampling and Sample Preservation of Marine Molluscs (such as *Mytilus* sp.) and Fish (*Mullus barbatus*) for IMAP Common Indicator 18 provides the following two Protocols: i) Protocol for the collection of marine fish (*Mullus barbatus*) and ii) Protocol for the dissection and storage of tissue samples from marine fish (*Mullus barbatus*).

3.1 Protocol for the collection of marine fish (*Mullus barbatus*)

a. Selection of the sampling areas and sampling frequency

44. *M. barbatus* is a benthic species that inhabits the sandy and muddy bottoms of the Mediterranean continental shelf (www.fao.org/fishery/species/3208/en). The mature organisms are

³⁴³ Mathieu, A., Lemaire, P., Carriere, S., Draï, P., Giudicelli, J., Lafaurie, M., 1991. Seasonal and sex-linked variations in hepatic and extrahepatic biotransformation activities in striped mullet (*Mullus barbatus*). *Ecotoxicol. Environ. Saf.* 22, 45-57.

³⁴⁴ Porte, C., Escartín, E., García de la Parra, L.M., Biosca, X., Albaigés, J., 2002. Assessment of coastal pollution by combined determination of chemical and biochemical markers in *Mullus barbatus*. *Mar. Ecol. Prog. Ser.* 235, 205-216.

³⁴⁵ Regoli, F., Pellegrini, D., Winston, G.W., Gorbi, S., Giuliani, S., Virno-Lamberti, C., Bompadre, S., 2002. Application of biomarkers for assessing the biological impact of dredged materials in the Mediterranean: the relationship between antioxidant responses and susceptibility to oxidative stress in the red mullet (*Mullus barbatus*). *Mar. Pollut. Bull.* 44, 912-922.

³⁴⁶ Viarengo, A., Lowe, D., Bolognesi, C., Fabbri, E., Koehler, A., 2007. The use of biomarkers in biomonitoring: a 2-tier approach assessing the level of pollutant-induced stress syndrome in sentinel organisms. *Comp. Biochem. Physiol. C* 146, 281-300.

³⁴⁷ Martínez-Gómez, C., Fernández, B., Benedicto, J., Valdés, J., Campillo, J. A., León, V. M., Vethaak, A. D., 2012. Health status of red mullets from polluted areas of the Spanish Mediterranean coast, with special reference to Portmán (SE Spain). *Mar. Environ. Res.* 77, 50-59.

³⁴⁸ Martínez-Gómez, C., Fernández, B., Robinson, C. D., Campillo, J. A., León, V. M., Benedicto, J., ... & Vethaak, A. D. (2017). Assessing environmental quality status by integrating chemical and biological effect data: The Cartagena coastal zone 26as a case. *Marine environmental research*, 124, 106-117.

³⁴⁹ Machias, A., Labropoulou, M., 2002. Intra-specific variation in resource use by red mullet, *Mullus barbatus*. *Estuar. Coast. Shelf Sci.* 55, 565-578.

usually distributed in the first 3-5 km from the coast at depths ranging from a few meters to 500 meters (Carlucci et al., 2009³⁵⁰; Follesa and Carbonara, 2019³⁵¹).

45. Although the sex difference can influence various physiological parameters, the biomarkers selected for environmental assessment may be evaluated using both male and female fish, as long as the specimens used are sampled according to a standardised sampling protocol in order to minimise confounding factors. However, the animals should always be sampled outside the reproductive periods (i.e. September-October or March-April –see the Guidelines for biomarker analysis CI18) (Carbonara et al., 2015³⁵²; Ferrer-Maza et al., 2015³⁵³).

b. Fish collection

46. *M. barbatus* are collected by gill net fishing or trawling using a square-meshed net of 40 mm or, if justified, by a diamond meshed net of 50 mm as required by the EU legislation (EC 1967/2006³⁵⁴; Sieli et al., 2011³⁵⁵). The gill net fishing time should be no longer of 30 min; and the trawling time no longer of 15 minutes using a speed ≤ 3 knots in order to minimise possible alterations of the physiological status of living fish. Fish having a length of 12-16 cm should be selected for the biomarker analysis.

47. Fish are killed on board and the tissues for the biomarker analysis are sampled as described in the Protocol for the dissection and storage of tissue samples from marine fish (*Mullus barbatus*).

48. For the interpretation of the biological effects of the chemical contaminants, it is important not only to evaluate their concentrations in the environmental matrices but also to estimate the amount of prioritized contaminants accumulated in fish tissues or whole body. In that respect it is recommended to monitor same priority contaminants for CI 18 as they have been agreed for monitoring of CI 17 in biota matrix respectively Cd, HgT, Pb, PAHs, PCBs, Hexachlorobenzene, Lindane and Σ DDTs³⁵⁶. In this last case, fish should be collected, taken to the laboratory and processed as described in the protocols related to the different chemical analysis for CI 17 as reported in the Guidelines for sample preparation and analysis of marine biota for the analysis of CI17: heavy and trace elements and organic contaminants.

49. The integrated chemical-biological assessments of the effects of the contaminants present in the marine environment supports provision of data for GES assessment. As for the chemical monitoring, sample collection should be focused on selected locations such as hotspots and reference stations. Whenever possible, same specimen should be used for biomarker and chemical analysis.

³⁵⁰ Carlucci, R., Lembo, G., Maiorano, P., Capezzuto, F., Marano, C.A., Sion, L., Spedicato, M.T., Ungaro, N., Tursi, A., Gianfranco, D., 2009. Nursery areas of red mullet (*Mullus barbatus*), hake (*Merluccius merluccius*) and deep-water rose shrimp (*Parapenaeus longirostris*) in the Eastern-Central Mediterranean Sea. Estuar. Coast. Shelf Sci. 83, 529-538

³⁵¹ Follesa, M.C., Carbonara, P., eds. 2019. Atlas of the maturity stages of Mediterranean fishery resources. Studies and Reviews n. 99. Rome, FAO. 268 pp.

³⁵² Carbonara, P., Intini, S., Modugno, E., Maradonna, F., Spedicato, M. T., Lembo, G., Zupa, W., Carnevali, O., 2015. Reproductive biology characteristics of red mullet (*Mullus barbatus* L., 1758) in Southern Adriatic Sea and management implications. Aquat. Living Resour. 28, 21-31.

³⁵³ Ferrer-Maza, D., Muñoz, M., Lloret, J., Faliex, E., Vila, S., Sasal, P., 2015. Health and reproduction of red mullet, *Mullus barbatus*, in the western Mediterranean Sea. Hydrobiologia 753, 189-204.

³⁵⁴ EC COUNCIL REGULATION No 1967/2006 of 21 December 2006 concerning management measures for the sustainable exploitation of fishery resources in the Mediterranean Sea, amending Regulation (EEC) No 2847/93 and repealing Regulation (EC) No 1626/94

³⁵⁵ Sieli, G., Badalucco, C., Di Stefano, G., Rizzo, P., D'Anna, G., Fiorentino, F. 2011. Biology of red mullet, *Mullus barbatus* (L. 1758), in the Gulf of Castellammare (NW Sicily, Mediterranean Sea) subject to a trawling ban. J Appl Ichthyol. 27:1218-1225.

³⁵⁶ UNEP/MAP (2019). UNEP/MED WG.467/5. IMAP Guidance Factsheets: Update for Common Indicators 13, 14, 17, 18, 20 and 21: New proposal for Candidate indicators 26 and 27.

However, it must also be considered that the research team responsible for chemical analysis sampling is usually different from the one responsible for biomarker analysis sampling.

50. During the fish collection a report (Collection Report) should be prepared containing sampling information data related to a) the sampling data as day, month and year, b) the number of fish sampled, c) the depth of collection (m), d) the georeferencing as Lat.-Long (decimal degrees), e) type of bottom, f) type of site as reference or pollution gradient as distance from a polluted site (km), g) environmental data such as water temperature(C°), salinity (dimensionless) and dissolved oxygen ($\mu\text{mol L}^{-1}$). It should be noted that the environmental data (water temperature, salinity and dissolved oxygen should be recorded at the same depth that fish have been collected. Whenever possible, the use of a CTD device is highly recommended.

51. In the lab, the Collection Report must be left in the Biomarker Analysis Register; the Report should also contain the names of the researchers involved in fish collection.

3.2 Protocol for the dissection and storage of tissue samples from marine fish (*Mullus barbatus*)

a. Materials

52. Application of this protocol requires availability of the following materials: Dissecting forceps, fine and medium; Dissecting robust and fine scissors; Single-use syringe, 5 ml; Volume adjustable pipette, 20-200 μl and 200-1000 μl ; Pipette tips, 20-200 μl and 200-1000 μl ; Microscope slides, 76x26 mm, 1 mm thick, pre cleaned/ready to use, Menzel-Gläser, Superfrost, wiped with ethanol and allowed to dry before use; Ice and ice bucket; Thermos ice packs; Cryostat chucks (anodized-aluminium support to cut cryostat sections of the biological samples); Aluminium foil / Parafilm; Thermostatic plastic container (200-400 ml); Labelling tape; Permanent marker; Paper sheets and pen.

b. Equipment

53. The following equipment is needed: Liquid nitrogen storage container (Dewar); Freezers - 80°C; Ruler; Weight scale (readability 0.1 g - 0.01 g); Video camera / Smartphone video camera.

c. Chemicals and solutions

54. The chemicals and solution needed for application of this protocol are as follows: Sodium heparin; Methanol, Methyl alcohol, absolute, Assay: 99,8%; Ethanol; Liquid nitrogen.

N.B. If not specified, the reagents must be of analytical grade.

d. Tissue dissection

55. Immediately after collection, living fish (*Mullus barbatus*) are killed on board by severing the spinal cord and rapidly dissected to obtain the tissues for the selected biomarker analysis. To successfully obtain blood cells from the caudal vein it is recommendable to extract them immediately after collection, once the fish are on board and before any other tissue sampling has been conducted and before blood starts clotting. Fish are opened by robust scissors and the tissues are removed by using dissecting fine scissors and dissecting forceps.

56. Liver samples for the evaluation of Lysosomal membrane stability (cytochemical assay of LMS on cryostat sections -Köhler, 1991³⁵⁷; Köhler and Pluta, 1995³⁵⁸; UNEP/RAMOGGE, 1999; Martínez-Gómez et al., 2015) are processed essentially as described for mussel digestive glands (Protocol for the dissection and storage of tissue samples from marine molluscs (such as *Mytilus* sp.)).

57. The only difference is that chunks are frozen directly in liquid nitrogen for 40 s. Rapidly excise 5 small pieces (4-5 mm³) from the mid part of the organ obtained from five different animals and place them on an aluminium cryostat chuck (aligned in a straight row across the centre). The chuck should be pre-labelled and pre-cooled in ices. 10 animals will be analysed by preparing 2 chunks for the same field sample. While dissecting the tissue, leave the chuck on ice. Then place it for 40 s in a small thermostatic plastic box containing liquid nitrogen. Seal the chuck with 2-3 pieces of Parafilm/aluminium foil and immediately store at -70 °C (at this temperature the tissue preparations maintain their integrity for months). LMS is a very sensitive parameter: a special attention should be given to use fish undergoing a minimal stress during fishing.

58. Muscle for the evaluation of AChE activity may be used as fresh tissue or rapidly frozen in liquid nitrogen and stored at -70 °C before the analysis (at this temperature the tissue preparations maintain their integrity for months). The brain tissue of *Mullus barbatus* can be considered as an additional tissue for evaluation of AChE activity, but not as an alternative to evaluation of AChE activity in muscle. However, it should be noted that the preliminary studies and available scientific literature confirm a high activity in brain tissue of *Mullus barbatus*.

59. Immediately after fish sampling, blood cells for the evaluation of Micronuclei frequency are collected from the caudal vein of intact fish using a syringe containing sodium heparin (1000 units/mL), mixed and immediately smeared on clean glass slides (Bolognesi and Hayashi, 2011³⁵⁹). The slides are dried overnight and subsequently fixed with methanol for at least 20 min.

e. Additional parameters to be recorded in this step (in the field or at the laboratory)

60. The following additional parameters need to be recorded in this step both in the field or at the laboratory:

- Fish biometrics: total length (to 0.1cm), total weight (to 0.1 g), eviscerated weight (to 0,1 g);
- Fulton's condition factor, K (Bagenal and Tesch, 1978³⁶⁰). $K = 100 \times \text{body eviscerated weight (to 0.1 g)} / \text{total length}^3(\text{to 0.1 cm})$.³⁶¹ The condition factor reflects the nutritional state or "well-being" of an individual fish and is sometimes interpreted as an index of growth rate (Bagenal and Tesch, 1978; ICES, 2011);
- Measurement of GSI: $GSI = (\text{gonad weight (to 0.01 g)} \times 100) / \text{eviscerated weight (to 0.1 g)}$, where eviscerated weight corresponds to the total weight without all internal organs (stomach, liver, gonad, intestine). The gonad size is an important indicator of the reproductive status and GSI allows to evaluate when fish, in relation to their size (or age), are sexually immature or adult, or if the animals show retarded gonad development as compared to normal sexual development (Hansson et al., 2017; ICES, 2011);
- Liver Somatic Index (LSI or HSI). $LSI = (\text{liver weight (to 0.1g)} \times 100) / \text{eviscerated weight (to 0.1 g)}$). As known, liver plays a central role in fish metabolism and numerous studies have

³⁵⁷ Köhler, A., 1991. Lysosomal perturbations in fish liver as indicators for toxic effects of environmental pollution. Comp. Biochem. Physiol. 100C, 123-127.

³⁵⁸ Köhler, A. Pluta, H.J., 1995. Lysosomal injury and MFO activity in the liver of flounder (*Platichthys flesus* L.) in relation to histopathology of hepatic degeneration and carcinogenesis. Mar. Environ. Res. 39, 255-260.

³⁵⁹ Bolognesi, C., Hayashi, M., 2011. Micronucleus assay in aquatic animals. Mutagenesis 26, 205-213.

³⁶⁰ Bagenal, T.B. and Tesch, F.W. 1978. Age and Growth. Pages 101-136, in T.B. Bagenal, edit. Methods for assessment of fish production in freshwaters, 3rd edition. Blackwell Scientific Publications, Oxford, England.

³⁶¹ see also Martinez-Gomez et al., 2012.

highlighted that toxic chemicals may affect liver size and its functions. It has been also demonstrated in numerous field studies that fish accumulation of contaminants may affect the LSI value (Hansson et al., 2017; ICES, 2011).

- Age: 12-16 cm length is a dimension typical of 1-2 years old fish (Carbonara et al. 2018³⁶²). To establish *M. barbatus* age in a more precise manner it is necessary to evaluate the otoliths as described by ICES (2017³⁶³) and Carbonara et al. (2018).

61. Sampled fish and their gonads should be recorded by a high definition video camera (or smartphone video camera) to document the reproductive status of the animals. Samples of gonads should be frozen in liquid nitrogen and stored at -70 °C to be available, when necessary, for examination.

62. At the end of the procedure related to samples preparation and storage, a report must be prepared indicating the list and the code of the samples for the different biomarker analysis, the -80 °C freezer used for the storage of the samples including the exact location in the freezer, as well as the list reporting the auxiliary data related to all the additional parameters evaluated. The report must be added to the Register for the Biomarker Analysis. The Report must also include the data of the sample preparation and storage and the name of the researchers involved in the work.

³⁶² Carbonara P., Intini S., Kolutari J., et al. 2018. A holistic approach to the age validation of *Mullus barbatus* L., 1758 in the Southern Adriatic Sea (Central Mediterranean). Sci. Rep. 8: 13219.

³⁶³ ICES, 2017. Workshop on Ageing Validation methodology of *Mullus* species (WKVALMU), 15-19 May 2017, Conversano, Italy. ICES CM 2017/ SSGIEOM:31. 74 pp.

References

- Aldrich, J.C., Crowly, M. 1986. Conditions and variability in *Mytilus edulis* L. from different habitats in Ireland. *Aquaculture* 52: 273–286.
- Bagenal, T.B. and Tesch, F.W. 1978. Age and Growth. Pages 101-136, in T.B. Bagenal, edit. *Methods for assessment of fish production in freshwaters*, 3rd edition. Blackwell Scientific Publications, Oxford, England.
- Barsiene, J., Schiedek, D., Rybakovas, A., Syvokiene, J., Kopecka, J., Forlin, L., 2006. Cytogenetic and cytotoxic effects in gill cells of the blue mussel *Mytilus* spp. from different zones of the Baltic Sea. *Mar. Pollut. Bull.* 53, 469-478.
- Bayne, B.L., 2009. *Marine Mussels: Their Ecology and Physiology*. Cambridge University Press 528 p.
- Bocquené, G., Galgani, F. 1998. Biological effects of contaminants: Cholinesterase inhibition by organophosphate and carbamate compounds. *ICES Techniques in Marine Environmental Sciences*, No. 22.
- Bolognesi, C., Fenech, M., 2012. Mussel micronucleus cytome assay, *Nat. Protoc.* 17, 1125-1137.
- Bolognesi, C., Hayashi, M., 2011. Micronucleus assay in aquatic animals. *Mutagenesis* 26, 205-213.
- Braby, C.E., Somero, G.N., 2006. Following the heart: temperature and salinity effects on heart rate in native and invasive species of blue mussels (genus *Mytilus*). *J. Exp. Biol.* 209, 2554-2566.
- Carbonara P., Intini S., Kolutari J., et al. 2018. A holistic approach to the age validation of *Mullus barbatus* L., 1758 in the Southern Adriatic Sea (Central Mediterranean). *Sci. Rep.* 8: 13219.
- Carbonara, P., Intini, S., Modugno, E., Maradonna, F., Spedicato, M. T., Lembo, G., Zupa, W., Carnevali, O., 2015. Reproductive biology characteristics of red mullet (*Mullus barbatus* L., 1758) in Southern Adriatic Sea and management implications. *Aquat. Living Resour.* 28, 21-31.
- Carlucci, R., Lembo, G., Maiorano, P., Capezzuto, F., Marano, C.A., Sion, L., Spedicato, M.T., Ungaro, N., Tursi, A., Gianfranco, D., 2009. Nursery areas of red mullet (*Mullus barbatus*), hake (*Merluccius merluccius*) and deep-water rose shrimp (*Parapenaeus longirostris*) in the Eastern-Central Mediterranean Sea. *Estuar. Coast. Shelf Sci.* 83, 529-538.
- Davenport, J., Chen, X. 1987. A comparison of methods for the assessment of condition in the mussel (*Mytilus edulis* L.). *J. Molluscan Stud.*, 53: 293–297.
- EC COUNCIL REGULATION No 1967/2006 of 21 December 2006 concerning management measures for the sustainable exploitation of fishery resources in the Mediterranean Sea, amending Regulation (EEC) No 2847/93 and repealing Regulation (EC) No 1626/94.
- Ferrer-Maza, D., Muñoz, M., Lloret, J., Faliex, E., Vila, S., Sasal, P., 2015. Health and reproduction of red mullet, *Mullus barbatus*, in the western Mediterranean Sea. *Hydrobiologia* 753, 189-204.
- Figueras, A. J., Jardon, C. F., & Caldas, J. R. (1991). Diseases and parasites of rafted mussels (*Mytilus galloprovincialis* Lmk): preliminary results. *Aquaculture*, 99(1-2), 17-33. Follesa, M.C., Carbonara, P., eds. 2019. *Atlas of the maturity stages of Mediterranean fishery resources*. Studies and Reviews n. 99. Rome, FAO. 268 pp.
- Francisco, C. J., Hermida, M. A., & Santos, M. J. (2010). Parasites and symbionts from *Mytilus galloprovincialis* (Lamarck, 1819) (Bivalves: Mytilidae) of the Aveiro estuary Portugal. *Journal of Parasitology*, 96(1), 200-205.
- Goldberg, E.D., Bowen, V.T., Farrington, J.W., Harvey, G., Martin, J.H., Parker P.L., Risebrough, R.W., Robertson, W., Schneider, E., Gamble, E., 1978. The Mussel Watch. *Environmental Conservation* 5, 101-125.
- Hansson, T., Thain, J., Martínez-Gómez, C., Hylland, K., Gubbins, M., Balk L., 2017. Supporting variables for biological effects measurements in fish and blue mussel. *ICES Techniques in Marine Environmental Sciences*. No. 60. 22 pp. <http://doi.org/10.17895/ices.pub.2903>.

- ICES, 2011. Report of the Study Group on Integrated Monitoring of Contaminants and Biological Effects (SGIMC), 14–18 March 2011, Copenhagen, Denmark. ICES CM 2011/ACOM:30. 265 pp.
- ICES, 2017. Workshop on Ageing Validation methodology of *Mullus* species (WKVALMU), 15-19 May 2017, Conversano, Italy. ICES CM 2017/ SSGIEOM:31. 74 pp.
- Köhler, A., 1991. Lysosomal perturbations in fish liver as indicators for toxic effects of environmental pollution. *Comp. Biochem. Physiol.* 100C, 123-127.
- Köhler, A. Pluta, H.J., 1995. Lysosomal injury and MFO activity in the liver of flounder (*Platichthys flesus* L.) in relation to histopathology of hepatic degeneration and carcinogenesis. *Mar. Environ. Res.* 39, 255-260.
- Lowe, D.M., Soverchia C., Moore M.N., 1995. Lysosomal membrane responses in the blood and digestive cells of mussels experimentally exposed to fluoranthene. *Aquatic Toxicol.* 33, 105-112.
- Lutz, R.A. 1980. *Mussel Culture and Harvest: A North American Perspective*, Elsevier Science Publishers, B.V. Amsterdam, 305pp.
- Machias, A., Labropoulou, M., 2002. Intra-specific variation in resource use by red mullet, *Mullus barbatus*. *Estuar. Coast. Shelf Sci.* 55, 565-578.
- Martínez-Gómez, C., Bignell, J. and Lowe, D., 2015. Lysosomal membrane stability in mussels. *ICES Techniques in Marine Environmental Sciences* No. 56. 41 pp.
- Martínez-Gómez, C., Fernández, B., Benedicto, J., Valdés, J., Campillo, J. A., León, V. M., Vethaak, A. D., 2012. Health status of red mullets from polluted areas of the Spanish Mediterranean coast, with special reference to Portmán (SE Spain). *Mar. Environ. Res.* 77, 50-59.
- Martínez-Gómez, C., Fernández, B., Robinson, C. D., Campillo, J. A., León, V. M., Benedicto, J., & Vethaak, A. D. (2017). Assessing environmental quality status by integrating chemical and biological effect data: The Cartagena coastal zone as a case. *Marine Environ. Res.* 124, 106-117.
- Mathieu, A., Lemaire, P., Carriere, S., Draï, P., Giudicelli, J., Lafaurie, M., 1991. Seasonal and sex-linked variations in hepatic and extrahepatic biotransformation activities in striped mullet (*Mullus barbatus*). *Ecotoxicol. Environ. Saf.* 22, 45-57.
- Moore, M.N., 1976. Cytochemical demonstration of latency of lysosomal hydrolases in digestive gland cells of the common mussel *Mytilus edulis*, and changes induced by thermal stress. *Cell Tissue Res.* 175, 279-287.
- Moore, M.N., Lowe, D. and Köhler, A. 2004. Biological effects of contaminants: Measurement of lysosomal membrane stability. *ICES Techniques in Marine Environmental Sciences*. No. 36. 39 pp.
- OSPAR, 1997. JAMP Guidelines for General Biological Effects Monitoring (OSPAR Agreement 1997-7). OSPAR Commission, Monitoring guidelines. Ref. No: 1997-7. 20 pp.
- Porte, C., Escartín, E., García de la Parra, L.M., Biosca, X., Albaigés, J., 2002. Assessment of coastal pollution by combined determination of chemical and biochemical markers in *Mullus barbatus*. *Mar. Ecol. Prog. Ser.* 235, 205-216.
- Regoli, F., Pellegrini, D., Winston, G.W., Gorbi, S., Giuliani, S., Virno-Lamberti, C., Bompadre, S., 2002. Application of biomarkers for assessing the biological impact of dredged materials in the Mediterranean: the relationship between antioxidant responses and susceptibility to oxidative stress in the red mullet (*Mullus barbatus*). *Mar. Pollut. Bull.* 44, 912-922.
- Robledo, J. A. F., Santarém, M. M., & Figueras, A. (1994). Parasite loads of rafted blue mussels (*Mytilus galloprovincialis*) in Spain with special reference to the copepod, *Mytilicola intestinalis*. *Aquaculture*, 127(4), 287-302.
- Sforzini S, Oliveri C, Orrù A, Chessa G, Jha A, Viarengo A, Banni M., 2018. Application of a new targeted low density microarray and conventional biomarkers to evaluate the health status of marine mussels: A field study in Sardinian coast, Italy. *Sci. Total Environ.* 628-629, 319-328.

- Sieli, G., Badalucco, C., Di Stefano, G., Rizzo, P., D'Anna, G., Fiorentino, F. 2011. Biology of red mullet, *Mullus barbatus* (L. 1758), in the Gulf of Castellammare (NW Sicily, Mediterranean Sea) subject to a trawling ban. *J Appl Ichthyol.* 27:1218-1225.
- UNEP, 1997. The MED POL Biomonitoring Programme Concerning the Effects of Pollutants on Marine Organisms Along the Mediterranean Coasts. UNEP(OCA)/MED WG.132/3, Athens.
- UNEP/RAMOG: Manual on the Biomarkers Recommended for the MED POL Biomonitoring Programme. UNEP, Athens, 1999.
- UNEP/MAP (2019) UNEP/MED WG.467/5. IMAP Guidance Factsheets: Update for Common Indicators 13,14, 17, 18, 20 and 21: New proposal for candidate indicators 26 and 27.
- Viarengo, A., Dondero, F., Pampanin, D.M., Fabbri, R., Poggi, E., Malizia, M., Bolognesi, C., Perrone, E., Gollo, E., Cossa, G.P., 2007. A biomonitoring study assessing the residual biological effects of pollution caused by the HAVEN wreck on marine organisms in the Ligurian Sea (Italy). *Arch Environ Contam Toxicol.* 53, 607-616.
- Viarengo, A., Lowe, D., Bolognesi, C., Fabbri, E., Koehler, A., 2007. The use of biomarkers in biomonitoring: a 2-tier approach assessing the level of pollutant-induced stress syndrome in sentinel organisms. *Comp. Biochem. Physiol. C* 146, 281-300.
- Viarengo, A.; Lafaurie, M.; Gabrielides, G.P.; Fabbri, R.; Marro, A., Roméo, M., 2000. Critical evaluation of an intercalibration exercise undertaken in the framework of the MED POL biomonitoring program. *Mar. Environ. Res.* 49, 1-18.
- Francisco, C. J., Hermida, M. A., & Santos, M. J. (2010). Parasites and symbionts from *Mytilus galloprovincialis* (Lamarck, 1819) (Bivalves: Mytilidae) of the Aveiro estuary Portugal. *Journal of Parasitology*, 96(1), 200-205.
- Robledo, J. A. F., Santarém, M. M., & Figueras, A. (1994). Parasite loads of rafted blue mussels (*Mytilus galloprovincialis*) in Spain with special reference to the copepod, *Mytilicola intestinalis*. *Aquaculture*, 127(4), 287-302.
- Figueras, A. J., Jardon, C. F., & Caldas, J. R. (1991). Diseases and parasites of rafted mussels (*Mytilus galloprovincialis* Lmk): preliminary results. *Aquaculture*, 99(1-2)

Appendix 23

Monitoring Guidelines/Protocols for Biomarker Analysis of Marine Molluscs (such as *Mytilus* sp.) and Fish (such as *Mullus barbatus*) for IMAP Common Indicator 18 – Analysis of Lysosomal membrane stability (LMS)

1. Introduction

1. A fundamental aspect related to IMAP Ecological Objective 9 concerns the monitoring of the concentrations of different classes of harmful chemicals evaluated in relevant matrices, i.e. sediment, sea water, and biota (CI17). These data need to be associated to the results concerning the level of the biological effects of the toxic contaminants where a cause-and-effect relationship has been established (CI18).
2. There are different approaches for the study of the biological effects of the contaminants usually categorized on the basis of the level of biological organisation. For IMAP Common Indicator 18 the optimal approach is based on a use of biomarkers on selected organisms typical of the marine coastal waters. Biomarkers are biological parameters which changes may identify a pollutant-induced stress syndrome. The advantage of the use of biomarkers is that these sublethal parameters are early-warning indicators of the effects of the chemical contamination; therefore, it is possible to highlight the initial noxious effects of contaminants on organisms, before any effects at the population/community level are evident. The use of biomarkers allows to provide valuable information to decision makers to promptly implement the necessary measures to reduce damage at the ecosystem level.
3. The Monitoring Guidelines/ Protocols related to the biomarker analysis in marine molluscs (such as *Mytilus* sp.) and fish (such as *Mullus barbatus*) provide a step-by-step guidance on the methodologies for the evaluation of the selected biomarkers, as well as for the interpretation of the results related to sample preparation and analysis of biomarkers. They are aimed at supporting comparable quality assurance of the data, as well as comparability between sampling areas in different national monitoring programmes.
4. The Monitoring Guidelines/ Protocols related to the biomarker analysis in marine molluscs (such as *Mytilus* sp.) and fish (such as *Mullus barbatus*) follow on UNEP/MAP Manual for biomarker analysis (UNEP/RAMOG, 1999). They are also aligned with the Guidelines for biomarker analysis, which were developed by other Regional Organisations, such as OSPAR (2013³⁶⁴) and ICES (Davies & Vethaak, 2012³⁶⁵).
5. The below flow diagram informs on the category of this Monitoring Guideline related to sample preparation and analysis of biomarkers for IMAP Common Indicator 18 within the structure of all Monitoring Guidelines prepared for IMAP Common Indicators 13, 14, 17, 18 and 20.

³⁶⁴ OSPAR Commission, 2013. Background document and technical annexes for biological effects monitoring, Update 2013. 239 pp.

³⁶⁵ Davies, I.M.; Vethaak, D. (Ed.) (2012). Integrated marine environmental monitoring of chemicals and their effects. ICES Cooperative Research Report, 315. ICES: Copenhagen. ISBN 978-87-7482-120-5. 277 pp. Part of: ICES Cooperative Research Report. ICES: Copenhagen. ISSN 1017-6195.

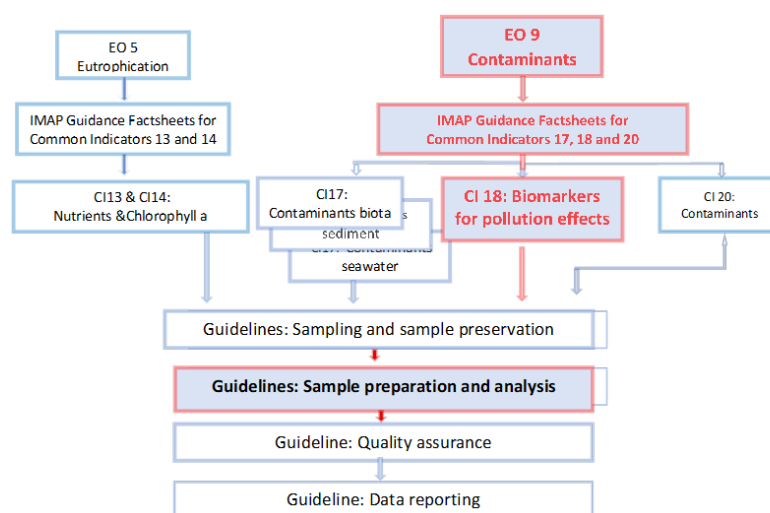

Flow Diagram: Monitoring Guidelines for IMAP Ecological Objectives 5 and 9

2. Technical note for the analysis of Lysosomal membrane stability (LMS) a) on cryostat sections in mussel digestive gland and fish liver and b) *in vivo* evaluation in mollusc haemocytes

6. Lysosomes are cytoplasmic vesicles; these single membrane organelles are characterized by their content of more than 50 types of acid hydrolases that are able to catabolise almost all of the different cellular components. The acidic pH of the lysosomal matrix is maintained by the activity of a proton pump present in the lysosomal membrane, and by the presence of an internal component of acidic proteins (Alberts et al., 2002³⁶⁶). The lysosomal vacuolar system comprises: newly formed (from the Golgi apparatus) Primary lysosomes (matrix pH ~ 6) of about 0.5 µm dimension within which the hydrolytic enzymes are not active; Secondary, active, lysosomes (matrix pH 4-5) that may reach dimensions of several µm; and Tertiary lysosomes with reduced size and hydrolytic activity, containing non-degradable residues (often reported as Ceroid-Lipofuscin or Lipofuscin) that can be eliminated by exocytosis from cells that have this capacity.

7. The lysosomes have various functions in different cell types, and in different organisms; but they are always involved in the digestion of the nutritional components ingested into the cells by endocytosis or phagocytosis, and in autophagic activity (self-digestion) in relation to protein turnover and the degradation of damaged cellular components (Klionsky and Emr, 2000³⁶⁷; Cuervo, 2004³⁶⁸; Moore, 2008³⁶⁹; Moore et al., 2015³⁷⁰). The lysosomal vacuolar system can accumulate both organic lipophilic xenobiotics, and inorganic hydrophilic chemicals (Viarengo, 1989³⁷¹; Moore et al., 2007³⁷²; Sforzini et al., 2018a³⁷³). It should be noted that the toxic chemicals that penetrate into the cells may damage membranes, organelles, soluble proteins etc. As mentioned above, lysosomes are normally involved in the removal and degradation of damaged cellular components; and, therefore, for this

³⁶⁶ Alberts, B., Johnson, A., Lewis, J., Raff, M., Roberts, K., Walter, P., 2002. Molecular Biology of the Cell, 4th edition. New York: Garland Science.

³⁶⁷ Klionsky, D.J., Emr, S.D., 2000. Autophagy as a regulated pathway of cellular degradation. Science 290, 1717-1721

³⁶⁸ Cuervo, A.M., 2004. Autophagy: in sickness and in health. Trends Cell Biol. 14, 70-77.

³⁶⁹ Moore, M.N., 2008. Autophagy as a second level protective process in conferring resistance to environmentally induced oxidative stress. Autophagy 4, 254-256

³⁷⁰ Moore, M.N., Shaw, J.P., Ferrar Adams, D.R., Viarengo, A., 2015. Anti-oxidative cellular protection effect of fasting-induced autophagy as a mechanism for hormesis. Mar. Environ. Res. 107, 35-44.

³⁷¹ Viarengo, A., 1989. Heavy metals in marine invertebrates: mechanisms of regulation and toxicity at the cellular level. Aquat. Sci. Review 1, 295-317.

³⁷² Moore, M.N., Viarengo, A., Donkin, P., Hawkins, A.J., 2007. Autophagic and lysosomal reactions to stress in the hepatopancreas of blue mussels. Aquat. Toxicol. 84, 80-91.

³⁷³ Sforzini, S., Moore, M.N., Oliveri, C., Volta, A., Jha, A., Banni, M., Viarengo, A., 2018a. Role of mTOR in autophagic and lysosomal reactions to environmental stressors in molluscs. Aquat. Toxicol. 195, 114-128.

reason, toxic chemicals will contribute to increasing the autophagic activity. This pathophysiological reaction represents a fairly standard aspect of the toxic effects of the contaminants at cellular level; and may be highlighted by various parameters, such as changes in the number of lysosomes and their enzyme content, changes in fusion events and consequent increase of the lysosomal volume, as well as changes in the matrix pH and membrane permeability. This latter effect, if severe, may lead to the release of acidic hydrolases into the cytosol, an event that could, as an extreme consequence, provoke cell death.

8. Among the numerous biomarkers developed to study the effects of the toxic chemicals on the lysosomal vascular system, the evaluation of the lysosomal membrane stability (LMS) was found to represent the best choice (Viarengo et al., 2007a³⁷⁴; Moore et al., 2008³⁷⁵). This biomarker is considered to have an excellent dose-response relationship, a high sensitivity, minimal chemical specificity (most toxic chemicals affect LMS) and there are no methodological concerns for both the methods proposed (Neutral Red Retention Time, NRRT, as well as cytochemical analysis of frozen cryostat sections) that are very simple and robust (Moore et al., 2008). Confounding factors usually do not represent a serious problem (Svendsen et al., 2004³⁷⁶); however, taking into account that the lysosomal vascular system is responsive to the variations of environmental parameters (such as sudden temperature and salinity changes, food availability and hypoxia/anoxia – Moore et al., 2008) and to the physiological changes related to gonad maturation in the spawning period, awareness and adequate precautions need to be considered in the realization of a biomonitoring programme (see Confounding factors).

9. Finally, it is important to highlight that LMS is not only an internationally recognised biomarker of stress, diagnostic of pathophysiological alterations at the cellular tissue level, but is also the only cellular biomarker found to be prognostic for possible effects at the population level (Moore et al., 2012³⁷⁷). In fact, Allen and Moore (2004³⁷⁸) have clearly shown the existence of a direct relationship between LMS and the Scope for Growth (SFG) of mussels. SFG is a parameter that evaluates the capability of the animals to adequately utilize the energy from food for growth and reproduction; therefore, as demonstrated by Widdows et al. (1981³⁷⁹), a decrease of this parameter reflects possible changes at the population level. The data reported in Fig. 1 clearly show that the decrease of LMS is associated to a decrease in the SFG of the organisms, a precursor of possible effects at population level.

³⁷⁴ Viarengo, A., Lowe, D., Bolognesi, C., Fabbri, E., Koehler, A., 2007a. The use of biomarkers in biomonitoring: a 2-tier approach assessing the level of pollutant-induced stress syndrome in sentinel organisms. *Comp. Biochem. Physiol. C* 146, 281-300.

³⁷⁵ Moore, M.N., Koehler, A., Lowe, D. & Viarengo, A., 2008. Lysosomes and autophagy in aquatic animals. In: *Methods in Enzymology* (D. Klionsky, Ed), 451, 582-620. Academic Press/Elsevier, Burlington.

³⁷⁶ Svendsen, C., Spurgeon, D.J., Hankard, P.K., Weeks, J.M., 2004. A review of lysosomal membrane stability measured by neutral red retention: is it a workable earthworm biomarker? *Ecotoxicol Environ Saf.* 57, 20-29.

³⁷⁷ Moore, M.N., Viarengo, A., Somerfield, P.J., Sforzini, S., 2012. Linking lysosomal biomarkers and ecotoxicological effects at higher biological levels. In *Ecological Biomarkers: Indicators of Ecotoxicological Effects* (Editors: C. Amiard-Triquet, J.C. Amiard, P.S. Rainbow). Pp. 107-130.

³⁷⁸ Allen, J.I., Moore, M.N., 2004. Environmental prognostics: is the current use of biomarkers appropriate for environmental risk evaluation. *Mar. Environ. Res.* 58, 227-232.

³⁷⁹ Widdows, J., Bayne, B., Donkin, P., Livingstone, D., Lowe, D., Moore, M., & Salkeld, P., 1981. Measurement of the responses of mussels to environmental stress and pollution in Sullom Voe: A base-line study. *Proc. R. Soc. Edin. Section B. Biological Sciences* 80, 323-338.

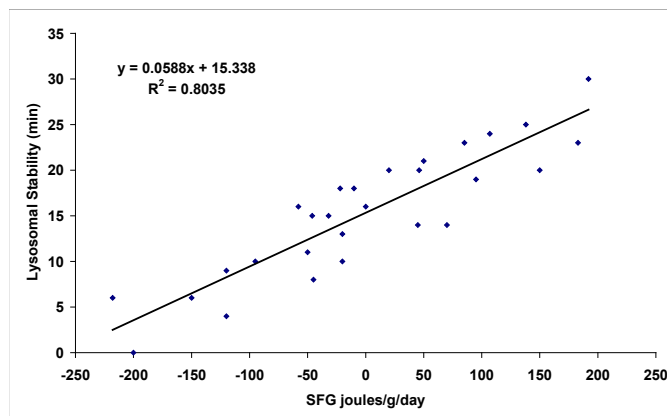

Fig. 1. Lysosomal Stability (LMS) as an indicator of whole organism health and possible effects at population level. LMS shows a significant linear relationship with Scope of Grows in the marine mussel *Mytilus edulis*. Data is a composite of several field and laboratory experiments (Allen & Moore, 2004)

10. Recently, it has been demonstrated in lab and field studies that toxic chemicals that affect LMS also inhibit mTOR (mechanistic Target of Rapamycin) activity (Sforzini et al., 2018a, b). mTOR is an evolutionarily-conserved serine/threonine protein kinase, playing a key role in the growth and reproduction of the organisms by regulating important cellular processes such as RNA and protein synthesis, energy metabolism, cytoskeleton organization, lysosomal membrane permeability, endocytosis and autophagy (Soulard et al., 2009³⁸⁰; Laplante and Sabatini, 2012³⁸¹; Sforzini et al., 2018a). For these reasons, the dephosphorylation of mTOR (complex 1: mTORC1, and complex 2: mTORC2) renders the cells catabolic, thus reducing the SFG of the animals. As reported in Sforzini et al. (2018b³⁸²), the polycyclic aromatic hydrocarbons (PAHs) accumulated in the digestive gland of mussels caged for 28 days in the highly contaminated Porto Torres harbour (Sardinia, Italy) induce a dephosphorylation of mTORC1 associated with a decrease of LMS and an increase of the lysosomal/cytoplasmic (L/C) volume ratio.

11. The lysosomal changes observed in field and lab experiments clearly indicate that increased autophagic activity is not compensated by the protein synthesis and that the mussel digestive gland cells become catabolic (Sforzini et al., 2018a, b). In these animals, the enhancement of the lysosomal content of neutral lipid seems to indicate that the mitochondrial energy production by fatty acid oxidation is reduced (Sforzini et al., 2018a). These findings confirm and clarify why a decrease of LMS is indicative and prognostic for a larger set of phenomena related to mTOR inhibition that may lead to a reduction of the SFG of the animals.

12. For these reasons, LMS, a simple and robust biomarker, was adopted as a mandatory test in the MED POL Biomonitoring programme.

13. Under this Technical Note, the Monitoring Guidelines for Biomarker Analysis of Marine Molluscs (such as *Mytilus* sp.) and Fish (*Mullus barbatus*) for IMAP Common Indicator 18 provides the following two Protocols: i) Protocol for tissue section preparation, enzymatic determination of lysosomal membrane stability (LMS) on cryostat sections in mussel digestive gland and fish liver and for the evaluation and interpretation of the results; and ii) Protocol for *in vivo* determination of lysosomal membrane stability (LMS) in mussel haemocytes, and for the evaluation and interpretation of the results.

³⁸⁰ Soulard, A., Cohen, A., Hall, M.N., 2009. TOR signaling in invertebrates. *Curr. Opin. Cell Biol.* 21, 825-836.

³⁸¹ Laplante, M., Sabatini, D.M., 2012. mTOR signaling in growth control and disease. *Cell* 149, 274-293.

³⁸² Sforzini, S., Oliveri, C., Orrù, A., Chessa, G., Jha, A., Viarengo, A., Banni, M., 2018b. Application of a new targeted low density microarray and conventional biomarkers to evaluate the health status of marine mussels: A field study in Sardinian coast, Italy. *Sci. Total Environ.* 628-629, 319-328.

2.1 Protocol for tissue section preparation, enzymatic determination of lysosomal membrane stability (LMS) on cryostat sections in mussel digestive gland and fish liver and evaluation and interpretation of the results

c) Principle

14. The cytochemical procedure for the evaluation of the LMS is based on the determination of the activity of the lysosomal enzyme N-acetyl- β -hexosaminidase. Lysosomal destabilisation is measured as an increase of the membrane permeability to the enzyme substrate (naphthol AS-BI N-acetyl- β -glucosaminide) visualized by the reaction with the enzyme in presence of diazonium salt. The changes of the stability of the lysosomal membranes are determined by exposure of the cryostat sections to an acidic solution: with this treatment, lysosomes from healthy animals remain not permeable to the substrate for longer periods (more than 20 min and up to 40 min), but the membrane of the lysosomes in the cells of stressed organisms result labilised in a shorter time, depending on the severity of the pollutant-induced stress syndrome.

d) Materials

15. The following materials are needed to support optimal application of the Protocol: Glass beakers; Glass graduated cylinders; Hellendahl staining jars; Volume adjustable pipette, 20-200 μ l and 200-1000 μ l; Pipette tips, 20-200 μ l and 200-1000 μ l; Microscope slides, 76x26 mm, 1 mm thick, pre cleaned/ready to use, Menzel-Gläser, Superfrost; Coverslips, no.1 (0.13 - 0.16 mm), 60 x 24 mm, Menzel-Gläser.

e) Equipment

16. The following chemicals and solutions are needed for optimal application of this protocol: High quality Cryostat; Shaking water thermostatic bath (up to 40 °C); Good quality bright-field microscope (10 \times , 20 \times , 40 \times objectives) equipped with a linear colour video camera; pH meter; Magnetic stirrer.

f) Chemicals and solutions

17. The following chemicals and solutions are needed for optimal application of this protocols: Lysosomal membrane labilising buffer (Solution A): 0.1 M Na-citrate Buffer, 2.5% NaCl w:v, pH 4.5.

18. Substrate incubation medium (Solution B) needs to be prepared just 5 minutes before use by applying the following procedure: 20 mg of naphthol AS-BI N-acetyl- β -D-glucosaminide ($C_{26}H_{27}BrN_2O_8$) are dissolved in 2.5 ml of 2-methoxyethanol and made up to 50 ml with solution A, containing also 3.5 g Polypep ($C_{14}H_{11}Cl_2N_3O \cdot \frac{1}{2}ZnCl_2$; low viscosity polypeptide to act as a section stabiliser; Polypep is not easy to dissolve; therefore, it needs to dissolve Polypep in the solution A time before the addition of the substrate)³⁸³.

19. Diazonium dye (Solution C) is prepared by applying the following procedure: 0.1 M Na-phosphate buffer, pH 7.4, containing 1 mg/ml of diazonium dye Fast Violet B salt (Sigma Aldrich, F1631) (or Fast Red Violet LB Salt -Sigma Aldrich, F3381; or Fast Blue RR -Sigma Aldrich, 201545) (Note: saturated solution, to be stored in dark).

20. Aqueous Mounting Medium (e.g. glycerol gelatin) to mount the sections³⁸⁴.

g) Tissue section preparation

³⁸³ Use of same solutions across region is recommended, as feasible, in order to reduce quantitative differences in the results respectively to increase reproducibility of the results of analytical determination of biomarkers.

³⁸⁴ For a few chemicals there is the indication of the supplier and is highly recommended to use exactly those in order to obtain comparable results. If not specified, the reagents must be of analytical grade.

21. Using a high-quality motorized cryostat (cabinet temperature below -28 °C), 10 µm thick sections are cut using a 15° knife angle. The sections are transferred to "warm" slides (at room temperature of about 20 °C) to flash-dry them. The slides can be stored in the cryostat for at least 4 hours before use. Before the analysis, the tissue sections are gradually acclimate to room temperature (at least 30 min at 4 °C and 30 min at room temperature).

h) Enzymatic determination of LMS

22. The application of the following procedure is essential according to Moore (1976³⁸⁵), UNEP/RAMOGÉ (1999³⁸⁶), Moore et al. (2004³⁸⁷), Martínez-Gómez et al. (2015³⁸⁸), Köhler, et al. (2002)³⁸⁹ and Broeg, K et al. (2002)³⁹⁰. The slides containing the sections are placed in a Hellendahl jar containing solution A for different times (3, 5, 10, 15, 20, 30, 40 minutes) at 37 °C in shaking water-bath (60 rpm) in order to find out the range of pre-treatment time needed to completely labilise the lysosomal membrane i.e. labilisation period (LP). The set of slides are transferred into the solution B and incubated for 20 minutes at 37 °C in a Hellendahl jar in a shaking water-bath. The slides are then washed in Hellendahl jar filled with filtered sea water at room temperature or with a saline solution (3% NaCl) at room temperature for 2 to 3 minutes. Subsequently the slides are transferred into the solution C containing the diazonium coupler for 10 min at room temperature, and then rinsed in a Hellendahl jar filled with running tap water for 5 minutes. Finally, the sections are mounted in aqueous mounting medium.

i) Result evaluation

23. The slides are viewed under a microscope and divide the analysis of each section in four areas (quarters) for statistical interpretation. Lysosomes will stain reddish-purple due to the reactivity of the substrate with N-acetyl-β-hexosaminidase (Fig. 2a and b).

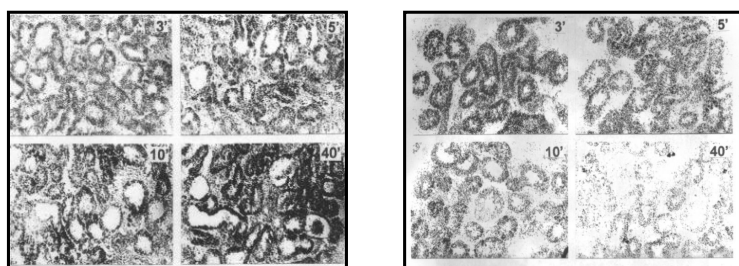

Fig. 2a. LMS cryostat sections of *Mytilus* sp digestive gland, left panel: mussels sampled in an unpolluted site, right panel: mussels sampled in a polluted site.

³⁸⁵ Moore, M.N., 1976. Cytochemical demonstration of latency of lysosomal hydrolases in digestive gland cells of the common mussel *Mytilus edulis*, and changes induced by thermal stress. *Cell Tissue Res.* 175, 279-287.

³⁸⁶ UNEP/RAMOGÉ (1999). Manual on the Biomarkers Recommended for the UNEP/MAP MED POL Biomonitoring Programme. UNEP, Athens.

³⁸⁷ Moore, M.N., Lowe, D. and Köhler, A. 2004. Biological effects of contaminants: Measurement of lysosomal membrane stability. *ICES Techniques in Marine Environmental Sciences.* No. 36. 39 pp.

³⁸⁸ Martínez-Gómez, C., Bignell, J. and Lowe, D., 2015. Lysosomal membrane stability in mussels. *ICES Techniques in Marine Environmental Sciences* No. 56. 41 pp

³⁸⁹ Köhler, A., Wahl, E., & Söffker, K. (2002). Functional and morphological changes of lysosomes as prognostic biomarkers of toxic liver injury in a marine flatfish (*Platichthys flesus* (L.)). *Environmental Toxicology and Chemistry: An International Journal*, 21(11), 2434-2444

³⁹⁰ Broeg, K., Köhler, A., & Westernhagen, H. V. (2002). Disorder and recovery of environmental health monitored by means of lysosomal stability in liver of European flounder (*Platichthys flesus* L.). *Marine environmental research*, 54(3-5), 569-573.

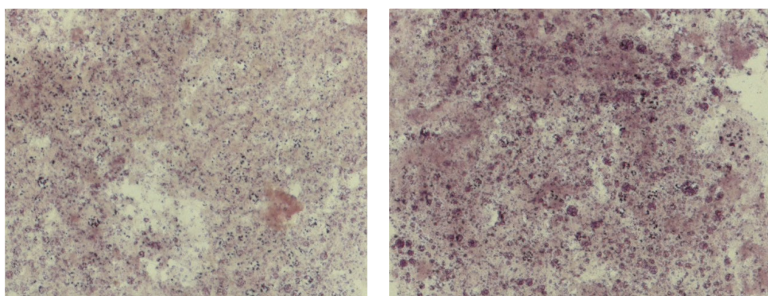
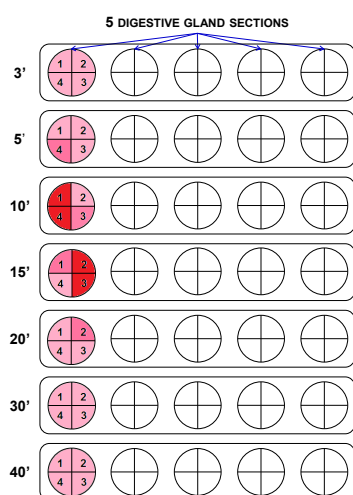

Fig.2b. LMS cryostat sections of fish (flounder) liver; animals sampled in a polluted site; left Panel: Lysosomal stain at 2 min, right Panel: Lysosomal stain at 6 min. LMS in healthy fish sampled in a pristine marina area is of about 35 min.

24. Evaluation of LP is done as shown in Fig. 3. The staining intensity can be assessed visually by microscopic examination; it is also possible to collect microscopic images by a video camera and analyse them using an image analyser. Three min are used as the minimal pre-treatment time since the sections without pre-treatment may provide sometimes stronger staining.

25. Finally, LP from test samples is compared with those obtained from mussels sampled in the reference area and the gradient of cytotoxicity is determined. Reduction in the LP along the expected pollution gradient would indicate cellular stress due to pollution. Any decrease in staining intensity in successive sections following that with maximal staining may be due to loss of enzyme by diffusion from fully labilised lysosomes. If there are two peaks of staining intensity, then consider only the first staining peak as the LP; this fact may be due to the different properties of the lysosomes present in the cells.

26. For mussel digestive gland and fish liver, timing intervals of 3, 5, 10, 15, 20, 30 and 40 minutes are normally utilised (Moore, 1976, Köhler³⁹¹, 1991; Köhler and Pluta, 1995³⁹²). The data can then be statistically analysed using the non-parametric Mann-Whitney U-test (Speigel, 1961³⁹³) and compared with reference data.



³⁹¹ Köhler, A., 1991. Lysosomal perturbations in fish liver as indicators for toxic effects of environmental pollution. *Comp. Biochem. Physiol.* 100C, 123-127.

³⁹² Köhler, A. Pluta, H.J., 1995. Lysosomal injury and MFO activity in the liver of flounder (*Platichthys flesus* L.) in relation to histopathology of hepatic degeneration and carcinogenesis. *Mar. Environ. Res.* 39, 255-260.

³⁹³ Speigel, M.R., 1961. *Statistics. Schaum's Outline Series.* Mc Graw-Hill Book Company, 359 p.

Fig. 3. Evaluation of LP: for each section one quarter is analysed and the incubation time in the acid buffer is determined which produces the maximal staining reactivity. The analysis is repeated for the remaining three quarters and the data averaged. This value represents the LP of the first digestive gland section. The LPs for the other animals (in this case $n = 5$) are similarly obtained. Example: Maximum Staining Intensity (red): Quarter 1 = 10 min; Quarter 2 = 15 min; Quarter 3 = 15 min; Quarter 4 = 10 min; LP value for specimen 1 = mean of 4 quarter = 12.5 min

27. It is important to note that, using cryostat tissue sections not pre-incubated in the acidic solution it is possible, by image analysis, to obtain the data concerning the ratio between the lysosomes and cytoplasm volumes. This parameter could be associated with that of LMS to evaluate if the organisms are “catabolic”: that is when the increase of the autophagic process in the cells is no longer compensated by an adequate level of protein synthesis (Sforzini et al., 2018a, b).

28. At the end of the analysis, the results of the LMS evaluation must be listed in an additional page of the Biomarker Analysis Register (indicating also the data of the analysis and the name of the researchers involved). If the slide were analysed using a video camera, the exact location of the file of the biomarker analysis must be indicated in the Biomarker Analysis Register together with the information concerning the -80°C freezer in which the chucks are stored after the analysis.

j) Interpretation of the results

29. The analysis of the literature data confirms that the Background Assessment Levels (BAC) and Environmental Assessment Criteria (EAC) for LMS in mussels are essentially those proposed in Decision IG.23/6³⁹⁴ on 2017 Mediterranean Quality Status Report and report of Davies and Vethaak, 2012.

- i) LMS evaluated by the histochemical method: BAC = 20 min, EAC = 10 min.
- ii) LMS values higher than 20 min should be consider typical of mussels in healthy conditions.
- iii) LMS values from 20 min to 10 min identify animals showing a stress condition and mussels characterized by LMS values lower than 10 min should be considered pathologically stressed.
- iv) For LMS in fish liver (*M. barbatus*), there are not as yet sufficient data to adequately quantify the BAC and EAC values: in this case, the values of LMS obtained in fish from the monitored sampling sites should be always compared with those obtained in fish living in relatively pristine control areas.

k) Confounding factors

30. In mussels LMS may be affected by extreme values of the environmental parameters: for this reason the animals should not be sampled in winter (low temperature and food deprivation), in summer periods when the seawater temperature is too high (the T at the sampling site should be always recorded) and the animals should be always sampled at about 4 m deep to avoid to collect animals that suffer long hypoxic periods -Moore et al.³⁹⁵, 1980, 2007; ICES, 2011³⁹⁶; OSPAR Commission, 2013).

31. In addition, it is important to know that that low salinities may affect the biomarker response, a fact that may become relevant in the biomonitoring programmes using caged mussels in areas such as estuaries. Moreover, mussels have different physiological conditions during the different seasons. For this reason, the animals should be sampled always outside the spawning period: in fact, during these

³⁹⁴ Decision IG.23/6 2017 Mediterranean Quality Status Report.

³⁹⁵ Moore, M.N., Koehn, R.K., Bayne, B.L., 1980. Leucine aminopeptidase (aminopeptidase-1), N-acetyl- β -hexosaminidase and lysosomes in the mussel *Mytilus edulis* L., in response to salinity changes. *J. Exp. Zool.* 214, 239-249.

³⁹⁶ ICES. 2011. Report of the Study Group on Integrated Monitoring of Contaminants and Biological Effects (SGIMC), 14–18 March 2011, Copenhagen, Denmark. ICES CM 2011/ACOM:30. 265 pp.

periods, the animals are often in a poor condition with reduced LMS values. However, spawning in fish (*Mullus barbatus*) has only minimal effects on lysosomal activity and does not mask the effects that toxic chemicals may have on LMS (Köhler, 1991).

1) Reporting data

32. As provided in IMAP Guidance Fact Sheet for CI 18, the unit agreed for Lysosomal Membrane Stability (LMS) in bivalve molluscs such as mussel or fish (*M. barbatus*) is PT minutes (Cryostat section enzymatic method).

2.2 Protocol for *in vivo* determination of lysosomal membrane stability (LMS) in mussel haemocytes and evaluation and interpretation of the results

33. Neutral red (NR) is an eurydine dye that is able to freely permeate the cell membrane in its lipophilic form. Within cells the compound is trapped by protonisation in its hydrophilic form in the lysosomes and accumulated in these organelles, where it can be visualised by a bright-field microscopy as red colour or by a fluorescence microscopy using a Rhodamine emission filter. The amount of Neutral Red trapped in the lysosomes depends on the pH of the organelles, in part due to the efficiency of their membrane associated proton pump (Seglen, 1983³⁹⁷). The neutral red retention time (NRRT) assay reflects the efflux of the dye from the lysosomes into the cytosol following damage to the membrane and/or the impairment of the H⁺ ion pump (Lowe et al., 1992³⁹⁸). These impairments of the lysosomal membrane will result in a reduction of the dye retention in the organelles. Studies indicate that, similarly to the cytochemical method described above, the NRRT assay is sensitive to the main classes of chemical pollutants (Lowe, 1988³⁹⁹; Moore et al., 2008).

34. The following protocol has been specifically adapted to be used on mussels, but it can be used on the cells of other molluscs.

a. Materials

35. The following materials are needed to support optimal application of the Protocol: Volume adjustable pipette, 20-200 µl and 200-1000 µl; Pipette tips, 20-200 µl and 200-1000 µl; Microcentrifuge tubes, snap cap, 2.0 ml; 2 L glass beaker; Microscope slides, 76x26 mm, 1 mm thick, pre cleaned/ready to use, Menzel-Gläser, Superfrost; Coverslips, no.1 (0.13 - 0.16 mm), 60 x 24 mm, Menzel-Gläser.

b. Equipment

36. The following equipment is needed: Good quality bright-field microscope (possibly an inverted microscope) with 10×, 20× and 40× objectives with a linear colour video camera; Humidity chambers (NR is a photosensitive dye, therefore the humidity chambers should be covered with an aluminium foil to prevent the light entry); Aquarium air pump and bubbler; pH meter; Magnetic stirrer.

c. Chemicals and solutions

37. The use of filtered sea water (0.45 µm) collected at the animals sampling sites is recommended. Alternatively, it is possible to use a physiological saline where the salinity and pH is

³⁹⁷ Seglen, P.o. 1983. Inhibitors of Lysosomal functions. Meth. Emzymol. 96, 737-765.

³⁹⁸ Lowe, D., Moore M.N., Evans B.M., 1992. Contaminant impact on interactions of molecular probes with lysosomes in living hepatocytes from dab *Limanda limanda*. Mar. Ecol. Progr. Ser. 91, 135-140.

³⁹⁹ Lowe, D.M., 1988. Alteration in the cellular structure of *Mytilus edulis* resulting from exposure to environmental contaminants under field and experimental conditions. Mar. Ecol., Prog. Ser. 46, 91-100.

the same as the conditions at the sampling sites. The salinity of the solution described below is about 30.5 PSU (g/Kg), however, in the Mediterranean Sea the salinity can reach 44 PSU (g/Kg).

38. Physiological saline solution should be prepared as follows: 20 mM (4.77 g) HEPES; 436 mM (25.48 g) NaCl; 53 mM (13.06 g) MgSO₄; 10 mM (0.75 g) KCl; 10 mM (1.47 g) CaCl₂. The NaCl concentration should be adjusted to take into account the sea water salinity at the sampling site.

39. These components are dissolved in 1 litre of deionised water. The solution is air bubbled for 10 minutes and then adjusted to pH 7.9 (or to the sea water pH) with 1M NaOH. The solution is stored in a refrigerator, but used at room temperature.

40. Neutral Red (NR) dye should be prepared as follows: the stock solution is prepared by dissolving 20 mg of NR powder (Sigma Aldrich, N4638) in 1 ml di dimethyl sulfoxide (DMSO). 5 µl of stock solution are transferred into 995 µl of physiological saline (working solution). NR stock solution is kept in the dark and in fridge (0-4 °C) when not utilized; the stock solution can be used for one month. The working solution must be prepared freshly before the analysis. N.B. For few chemicals there is the indication of the supplier and is highly recommended to use exactly those in order to obtain comparable results. If not specified, the reagents must be of analytical grade.

d. Practical evaluation

41. The Neutral Red (NR) method is recommended according to Lowe et al. (1995⁴⁰⁰). The method for mussel haemolymph collection is reported in the Protocol for the dissection and storage of tissue samples from marine molluscs (such as *Mytilus* sp.) of Technical note for the collection, transport and sampling of marine molluscs (such as *Mytilus* sp.) for biomarker analysis.

42. The NR methods requires applying the following procedure: 2 µL of Poly-L-lysine solution (0.1 % (w/v) in H₂O) (Sigma Aldrich, P8920) are put on a microscope slide and spread out with a coverslip. Leave to dry in a humidity chamber. 40 µL of haemolymph-saline mixture is dispensed on the slide, in the same position where the poly-l-lysine was added and incubated in a humidity chamber for 30 minutes to allow the cells to attach. Carefully, the excess solution is drained from the slide by placing the slide on its side and letting the liquid run off. 40 µL of the neutral red working solution is added and the slide is left in a humidity chamber for 15 min (maintained 15-16 °C during the analysis). A coverslip is applied and the preparation is inspected under a microscope. This first inspection corresponds to time 0' in Table 1.

e. Result evaluation

43. To evaluate results there is a need to visually look at the slides every 15 minutes for the first hour and then every 30 minutes for the next two hours thereafter (NR is a photosensitive dye, therefore, the light exposure time during the sample analysis should be as short as possible) (UNEP/RAMOGÉ, 1999; Moore et al., 2004). See figure 4

44. The time at which in 50% of the cells lysosomes release neutral red is then determined. Derive a mean value for each specimen and then a global mean for all specimens pertaining to the same pool. Samples from monitored field sites are compared with those taken from reference field sites and the gradient of cytotoxicity is determined. An increase in leaching rates will indicate cellular stress due to pollution.

Table 1: Example for result evaluation, with “+” more than 50% of the cells retain neutral red in the lysosomes; and “-” less than 50% of the cells retain neutral red in the lysosomes.

⁴⁰⁰ Lowe, D.M., Soverchia C., Moore M.N., 1995. Lysosomal membrane responses in the blood and digestive cells of mussels experimentally exposed to fluoranthene. *Aquatic Toxicol.* 33, 105-112.

Samples	0	15	30	60	90	120	150	180	NRRT
Control	+	+	+	+	+	+	+	+	180
Treatment	+	+	±	-	-	-	-	-	30

45. It is also possible to collect digital images of the haemocytes (objectives 20× or 40×): this will allow to evaluate the NRRT at a later stage, a fact that may be important when there is the need to analyse numerous samples. This approach also allows to evaluate the reduction of NR accumulated in lysosomes. In addition, the cells' images and the collected data could be sent to an external lab (the Reference Centre) to check the quality of the results.

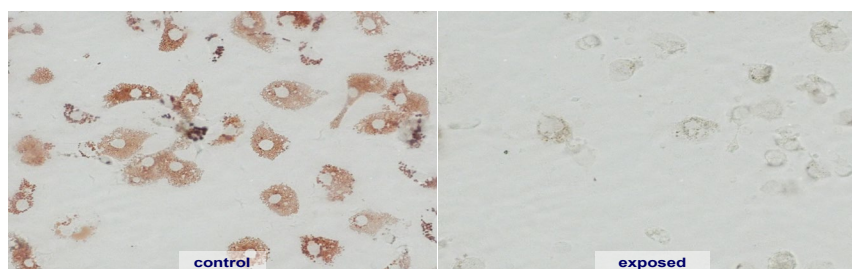

Fig. 4: Images of neutral red retention time (NRRT) assay to show lysosomal membrane stability of mussel haemocytes. More detailed information and images about NRRT in mussel haemocytes can be found in Martínez-Gómez et al., 2015.

46. At the end of the analysis the results of the LMS evaluation must be listed in an additional page of the Biomarker Analysis Register (indicating also the data of the analysis and the name of the researchers involved). If the slide were analysed using a video camera, the exact location of the file of the biomarker analysis must be indicated in the Biomarker Analysis Register.

47. Recently, Martínez-Gómez et al. (2015) suggested that lysosomal size alterations should be associated with the NRRT to calculate the Percentage of LMS. This index takes into account lysosomal changes such as enlargement but no leakage, leakage and enlargement but colourless lysosomes and rounded up fragmenting cells (Martínez-Gómez et al., 2015). Although we have as yet limited data from field biomonitoring studies, the image analysis of the NRRT samples will allow the collection of microscopy images that could be used in the future for this improvement of this analysis. On the other hand, the % LMS, as indicated in ICES TIMES Number 56 (Martínez-Gómez et al., 2015) is highly recommended and it should be considered for future assessing LMS by NRRT assay. Consequently, (Field % LMS) Units (%) Tissue (haemocytes) was included as an optional field in the proposed Reporting Formats for CI18 (UNEP/MED WG.509/33).

48. The data can then be statistically analysed using the non-parametric Mann-Whitney *U*-test (Speigel, 1961) and compared with reference data.

f. Interpretation of the results

49. The analysis of the literature data confirms that the Background Assessment Levels (BAC) and Environmental Assessment Criteria (EAC) for LMS in mussels are essentially those proposed previously (Davies and Vethaak, 2012), and included into Decision IG23/6 on the 2017 Mediterranean Quality Status Report (2017 MED QSR, respectively. LMS evaluated by the in vivo NRRT method: BAC = 120 min, EAC = 50 min.

g. Confounding factors

50. In mussels LMS may be affected by extreme values of the environmental parameters. For this reason, the animals should not be sampled in winter (low temperature and food deprivation) and in

summer periods when the seawater temperature is too high; the T at the sampling site should always be recorded. The animals should always be sampled at about 4 m deep to avoid collecting animals that suffer long hypoxic periods (Moore et al., 1980, 2007; ICES, 2011; OSPAR Commission, 2013).

51. In addition, it is important to know that low salinities may affect the biomarker response. This is a fact that may become relevant in the biomonitoring programmes using caged mussels in areas such as estuaries. Moreover, mussels have different physiological conditions during the different seasons. For this reason, the animals should be sampled always outside the spawning period: in fact, during these periods, the animals are often in a poor condition with reduced LMS values.

h. Reporting data

52. The unit for the agreed toxicological test NRRT assay under IMAP CI18 for bivalve molluscs such as mussel is “minute”.

References

- Alberts, B., Johnson, A., Lewis, J., Raff, M., Roberts, K., Walter, P., 2002. *Molecular Biology of the Cell*, 4th edition. New York: Garland Science.
- Allen, J.I., Moore, M.N., 2004. Environmental prognostics: is the-573. current use of biomarkers appropriate for environmental risk evaluation. *Mar. Environ. Res.* 58, 227-232.
- Broeg, K., Köhler, A., & Westernhagen, H. V. (2002). Disorder and recovery of environmental health monitored by means of lysosomal stability in liver of European flounder (*Platichthys flesus* L.). *Marine environmental research*, 54(3-5), 569-573.
- CAS-Chemical Abstracts Service, 2020. Specialized substance collections count: CHEMLIST®. Chemical Abstracts Service. American Chemical Society. (Available at <https://www.cas.org/support/documentation/regulated-chemicals>, accessed 31 August 2020).
- Cuervo, A.M., 2004. Autophagy: in sickness and in health. *Trends Cell Biol.* 14, 70-77.
- Davies, I.M.; Vethaak, D. (Ed.) (2012). *Integrated marine environmental monitoring of chemicals and their effects*. ICES Cooperative Research Report, 315. ICES: Copenhagen. ISBN 978-87-7482-120-5. 277 pp. Part of: ICES Cooperative Research Report. ICES: Copenhagen. ISSN 1017-6195.
- Decision IG.23/6 2017 Mediterranean Quality Status Report.
- ICES. 2011. Report of the Study Group on Integrated Monitoring of Contaminants and Biological Effects (SGIMC), 14–18 March 2011, Copenhagen, Denmark. ICES CM 2011/ACOM:30. 265 pp.
- Klionsky, D.J., Emr, S.D., 2000. Autophagy as a regulated pathway of cellular degradation. *Science* 290, 1717-1721.
- Köhler, A., 1991. Lysosomal perturbations in fish liver as indicators for toxic effects of environmental pollution. *Comp. Biochem. Physiol.* 100C, 123-127.
- Köhler, A. Pluta, H.J., 1995. Lysosomal injury and MFO activity in the liver of flounder (*Platichthys flesus* L.) in relation to histopathology of hepatic degeneration and carcinogenesis. *Mar. Environ. Res.* 39, 255-260.
- Köhler, A., Wahl, E., & Söffker, K. (2002). Functional and morphological changes of lysosomes as prognostic biomarkers of toxic liver injury in a marine flatfish (*Platichthys flesus* (L.)). *Environmental Toxicology and Chemistry: An International Journal*, 21(11), 2434-2444
- Laplante, M., Sabatini, D.M., 2012. mTOR signaling in growth control and disease. *Cell* 149, 274-293.
- Lowe, D.M., 1988. Alteration in the cellular structure of *Mytilus edulis* resulting from exposure to environmental contaminants under field and experimental conditions. *Mar. Ecol., Prog. Ser.* 46, 91-100.
- Lowe, D., Moore M.N., Evans B.M., 1992. Contaminant impact on interactions of molecular probes with lysosomes in living hepatocytes from dab *Limanda limanda*. *Mar. Ecol. Progr. Ser.* 91, 135-140.
- Lowe, D.M., Soverchia C., Moore M.N., 1995. Lysosomal membrane responses in the blood and digestive cells of mussels experimentally exposed to fluoranthene. *Aquatic Toxicol.* 33, 105-112.
- Martínez-Gómez, C., Bignell, J. and Lowe, D., 2015. Lysosomal membrane stability in mussels. *ICES Techniques in Marine Environmental Sciences* No. 56. 41 pp.
- Moore, M.N., 1976. Cytochemical demonstration of latency of lysosomal hydrolases in digestive gland cells of the common mussel *Mytilus edulis*, and changes induced by thermal stress. *Cell Tissue Res.* 175, 279-287.
- Moore, M.N., 2008. Autophagy as a second level protective process in conferring resistance to environmentally induced oxidative stress. *Autophagy* 4, 254-256.

- Moore, M.N., Koehn, R.K., Bayne, B.L., 1980. Leucine aminopeptidase (aminopeptidase-1), N-acetyl- β -hexosaminidase and lysosomes in the mussel *Mytilus edulis* L., in response to salinity changes. *J. Exp. Zool.* 214, 239-249.
- Moore, M.N., Lowe, D. and Köhler, A. 2004. Biological effects of contaminants: Measurement of lysosomal membrane stability. *ICES Techniques in Marine Environmental Sciences*. No. 36. 39 pp.
- Moore, M.N., Viarengo, A., Donkin, P., Hawkins, A.J., 2007. Autophagic and lysosomal reactions to stress in the hepatopancreas of blue mussels. *Aquat. Toxicol.* 84, 80-91.
- Moore, M.N., Koehler, A., Lowe, D. & Viarengo, A., 2008. Lysosomes and autophagy in aquatic animals. In: *Methods in Enzymology* (D. Klionsky, Ed), 451, 582-620. Academic Press/Elsevier, Burlington.
- Moore, M.N., Viarengo, A., Somerfield, P.J., Sforzini, S., 2012. Linking lysosomal biomarkers and ecotoxicological effects at higher biological levels. In *Ecological Biomarkers: Indicators of Ecotoxicological Effects* (Editors: C. Amiard-Triquet, J.C. Amiard, P.S. Rainbow). Pp. 107-130.
- Moore, M.N., Shaw, J.P., Ferrar Adams, D.R., Viarengo, A., 2015. Anti-oxidative cellular protection effect of fasting-induced autophagy as a mechanism for hormesis. *Mar. Environ. Res.* 107, 35-44.
- OSPAR Commission, 2013. Background document and technical annexes for biological effects monitoring, Update 2013. 239 pp.
- Seglen, P.O., 1983. Inhibitors of lysosomal function. *Meth. Enzymol.* 96, 737-765.
- Sforzini, S., Moore, M.N., Oliveri, C., Volta, A., Jha, A., Banni, M., Viarengo, A., 2018a. Role of mTOR in autophagic and lysosomal reactions to environmental stressors in molluscs. *Aquat. Toxicol.* 195, 114-128.
- Sforzini, S., Oliveri, C., Orrù, A., Chessa, G., Jha, A., Viarengo, A., Banni, M., 2018b. Application of a new targeted low-density microarray and conventional biomarkers to evaluate the health status of marine mussels: A field study in Sardinian coast, Italy. *Sci. Total Environ.* 628-629, 319-328.
- Soulard, A., Cohen, A., Hall, M.N., 2009. TOR signaling in invertebrates. *Curr. Opin. Cell Biol.* 21, 825-836.
- Speigel, M.R., 1961. *Statistics*. Schaum's Outline Series. Mc Graw-Hill Book Company, 359 p.
- Svendsen, C., Spurgeon, D.J., Hankard, P.K., Weeks, J.M., 2004. A review of lysosomal membrane stability measured by neutral red retention: is it a workable earthworm biomarker? *Ecotoxicol Environ Saf.* 57, 20-29.
- UNEP/RAMOGÉ (1999). *Manual on the Biomarkers Recommended for the UNEP/MAP MED POL Biomonitoring Programme*. UNEP, Athens.
- Viarengo, A., 1989. Heavy metals in marine invertebrates: mechanisms of regulation and toxicity at the cellular level. *Aquat. Sci. Review* 1, 295-317.
- Viarengo, A., Lowe, D., Bolognesi, C., Fabbri, E., Koehler, A., 2007a. The use of biomarkers in biomonitoring: a 2-tier approach assessing the level of pollutant-induced stress syndrome in sentinel organisms. *Comp. Biochem. Physiol. C* 146, 281-300.
- Widdows, J., Bayne, B., Donkin, P., Livingstone, D., Lowe, D., Moore, M., & Salkeld, P., 1981. Measurement of the responses of mussels to environmental stress and pollution in Sullom Voe: A base-line study. *Proc. R. Soc. Edin. Section B. Biological Sciences* 80, 323-338.

Appendix 24

Monitoring Guideline/Protocols for Biomarker Analysis of Marine Molluscs (such as *Mytilus* sp.) and Fish (such as *Mullus barbatus*) for IMAP Common Indicator 18 – Analysis of and micronuclei (MNi) frequency, Acetylcholinesterase (AChE) activity and Stress on Stress (SoS)

1. Introduction

1. This working document is the continuation of Monitoring Guideline/Protocols for Biomarker Analysis of Marine Molluscs (such as *Mytilus* sp.) and Fish (*Mullus barbatus*) for IMAP Common Indicator 18 provided in UNEP/MED WG. 492/4. It details protocols for the following biomarkers: i) acetylcholinesterase (AChE) activity; ii) micronuclei (MNi) frequency; and iii) stress on stress (SoS).

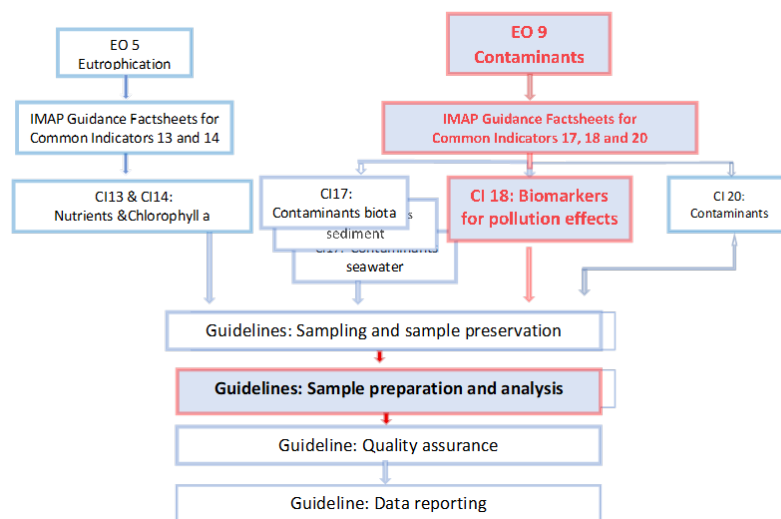

Flow Diagram: Monitoring Guidelines for IMAP Ecological Objectives 5 and 9

2. Technical note for the analysis of micronuclei (MNi) frequency in fish (*Mullus barbatus*) blood cells and in mussel (*Mytilus* sp.) gill cells and haemocytes

2. Micronuclei are small DNA-containing bodies that can be present near the cell nucleus during interphase resulting from both chromosome breakage and spindle dysfunction. The micronucleus (MN) test is suitable for the evaluation of the genotoxic activity of xenobiotic agents and of complex environmental mixtures in the laboratory, as well as in field studies (Al-Sabti and Metcalfe, 1995⁴⁰¹; Hayashi et al., 1998⁴⁰²; Bolognesi and Fenech, 2012⁴⁰³).

3. The types of genotoxic damage that could contribute to micronuclei production include:

- unrepaired DNA strand-breaks induced by environmental and endogenous genotoxic agents which may result in acentric chromosome fragments;
- products from interactions with kinetochore proteins, centromeres and spindle apparatus that could lead to unequal chromosome distribution or whole chromosome loss at anaphase.

4. Studies indicate that the relative occurrence of micronuclei provides an indication of accumulated genetic damage throughout the life span of the cells; and even during short phases of contamination. These considerations suggested the suitability of this test to monitor the extent of genotoxic damage in marine organisms in a time-integrated manner. It has been demonstrated that fish respond to toxic agents in a similar way to higher vertebrates, and can be used as bioindicator to monitor the genotoxic effects of substances that are also potentially hazardous to humans (Al-Sabti

⁴⁰¹ Al-Sabti, K., Metcalfe, C.D., 1995. Fish micronuclei for assessing genotoxicity in water. *Mutat. Res.* 343, 121-135.

⁴⁰² Hayashi, M., Ueda, T., Uyeno, K. et al., 1998. Development of genotoxicity assay systems that use aquatic organisms. *Mutat. Res.* 399, 125-133.

⁴⁰³ Bolognesi, C., Fenech, M., 2012. Mussel micronucleus cytome assay, *Nat. Protoc.* 17, 1125-1137.

and Metcalfe, 1995; Barsiene et al., 2004⁴⁰⁴; Bolognesi and Hayashi, 2011⁴⁰⁵; Bolognesi and Cirillo, 2014⁴⁰⁶). The MN test, due to its potential for application to any proliferating cell population regardless of the karyotype, has been successfully established in many fish species that are often characterized by a low amount of DNA per cell, large numbers of small chromosomes and low mitotic activity.

5. Different fish cell types have been considered for the MN analysis: gill, fin, kidney and hepatic cells and peripheral erythrocytes. However, the complexity of the protocol for the isolation of cells from gill, fin, kidney and liver involve the killing of the animals and thus limits their application for environmental monitoring. Nucleated erythrocytes are the most commonly used cells in the fish MN test. The erythrocyte MN test was validated in a number of studies in laboratory and in the field.

6. A dose-response increase in MN frequency has been observed after exposure to ionizing radiations and to a large number of genotoxic pollutants such as aflatoxins, polycyclic aromatic hydrocarbons, chlorinated hydrocarbons, heavy metals and pesticides. The use of DNA-reacting fluorescent dyes is particularly useful to detect small MN. Different kinds of nuclear alterations (NAs) are also observed in fish erythrocytes such as buds, broken eggs, lobed, notched, vacuolated and karyolytic nuclei. The mechanisms responsible for NAs are not yet fully understood. A number of them, such as buds, are considered to be indicators of genotoxic damage and, therefore, they may complement the scoring of MN in routine genotoxicity surveys. Other NAs, such as lobed and notched nuclei, are mainly associated with cytotoxicity and need to be recorded separately (Bolognesi and Hayashi, 2011).

7. In molluscs, the MN assay has been applied in various species of bivalves, under both field and laboratory conditions: haemocytes and gill cells are the targets most frequently considered. The validation process for the MN assay in the genus *Mytilus* started in 1987 (Majone et al., 1987⁴⁰⁷). Dose related induction of micronuclei (MNi) by different pollutants has been reported in mussels exposed under laboratory conditions and in field studies (Barsiene et al., 2006⁴⁰⁸; Bolognesi and Hayashi, 2011; Bolognesi and Fenech, 2012).

8. The large majority of studies evaluated only the MN frequency. More recently, the results on the frequency of other parameters included in the “cytome” approach, such as nuclear abnormalities or different types of cells, have been reported showing associations with pollutant levels (Bolognesi and Fenech, 2012). Further investigations and data collection are needed using standardized experimental protocols and scoring criteria for identifying the different types of cell and nuclear anomalies, in order to define the role of these biomarkers in environmental biomonitoring.

9. In line with above elaborated under this Technical Note, the Monitoring Guidelines for Biomarker Analysis of Marine Molluscs (such as *Mytilus sp.*) and Fish (such as *Mullus barbatus*) for IMAP Common Indicator 18 provides the following two Protocols: i) Protocol for the analysis of micronuclei (MNi) frequency in fish (*Mullus barbatus*) blood cells and evaluation and interpretation of the results; and ii) Protocol for the analysis of micronuclei (MNi) frequency in mussel gill cells and haemocytes and evaluation and interpretation of the results.

⁴⁰⁴ Barsiene, J., Lazutka., Syvokiene, J., Dedonyte, V., Rybakovas, A., Bagdonas, E., Biornstad, A., Andersen, O.K., 2004. Analysis of micronuclei in blue mussels and fish from Baltic and North Seas. *Environ. Toxicol.* 19, 365-371.

⁴⁰⁵ Bolognesi, C., Hayashi, M., 2011. Micronucleus assay in aquatic animals. *Mutagenesis* 26, 205-213.

⁴⁰⁶ Bolognesi, C., Cirillo, S., 2014. Genotoxicity biomarkers in aquatic bioindicators. *Zoology* 60, 273-284.

⁴⁰⁷ Majone, F., Brunetti, R., Gola, I., Levis, A.G., 1987. Persistence of micronuclei in the marine mussel, *Mytilus galloprovincialis*, after treatment with mitomycin C. *Mutat. Res.* 191, 157-161.

⁴⁰⁸ Barsiene, J., Schiedek, D., Rybakovas, A., Syvokiene, J., Kopecka, J., Forlin, L., 2006. Cytogenetic and cytotoxic effects in gill cells of the blue mussel *Mytilus* spp. from different zones of the Baltic Sea. *Mar. Pollut. Bull.* 53, 469-478.

2.1 Protocol for the analysis of micronuclei (MNi) frequency in fish blood cells and evaluation and interpretation of the results

a. Materials

10. Application of this protocol requires availability of the following material: Pasteur pipette rubber bulbs; Petri dishes; Volume adjustable pipette, 20-200 μ l and 200-1000 μ l; Pipette tips, 20-200 μ l and 200-1000 μ l; Single-use syringe, Luer Lock, 10-20 ml; Single-use syringe, 5 ml; Corning stripettes, disposable serological plastic pipette, 5 ml; Glass Pasteur pipettes, 150 mm; Microscope slides, 76x26 mm, 1 mm thick, pre cleaned/ready to use, Menzel-Gläser, Superfrost, wiped with ethanol and allowed to dry before use; Coverslips, no.1 (0.13 - 0.16 mm), 60 x 24 mm, Menzel-Gläser; Coplin jar, glass, for 10 slides; Microscope slide staining container, glass; slide staining rack; Storage microscope slides boxes.

b. Equipment

11. The equipment needed for the analysis includes: Microscope with good quality optics for bright-field examination of stained slides at 1000 \times magnification; Fluorescence microscope ocular (10 \times) and objective (100 \times) final magnification of 1000 \times .

c. Chemicals and Solutions

12. For the analysis of micronuclei (MNi) frequency in fish (*Mullus barbatus*) blood cells and for the evaluation and interpretation of the results, the following chemical and solutions are used: Sodium heparin; Methanol, Methyl alcohol, absolute, Assay: 99,8%; Giemsa's azur-eosin-methylene blue solution (Sigma Aldrich, 1.09204); Eukitt, quick-hardening mounting medium for microscopy, or DPX Mountant for histology; DAPI (4',6-Diamidino-2-Phenylindole, Dilactate); Mowiol 4-88, glycerol, Tris.

13. GIEMSA staining procedure follows the below described procedure (Bolognesi and Fenech, 2012):

- Sorensen buffer, pH 6.8: Prepare two solution (sol. A and sol. B);
- Sol. A: 9.073 g/L of potassium dihydrogen phosphate dehydrate (KH_2PO_4) [CAS No: 7778-770];
- Sol. B: 11.87 g/L of di-Sodium hydrogen phosphate dehydrate ($\text{Na}_2\text{HPO}_4 \cdot 2\text{H}_2\text{O}$) [CAS No: 100028-24-7];
- To obtain 100 ml of Sorensen buffer solution, pH 6.8, 53.4 ml of solution A are mixed with 46.6 ml of solution B. The final solution (A+B) is utilised to prepare the GIEMSA staining solution and rinsing solution;
- 50 ml of Giemsa's, azur-eosine-methylene blue solution is filtered with filter paper. Protect from light;
- 200 ml of Giemsa's staining solution (3% vol/vol) are prepared by adding 6 ml of filtered Giemsa and 6 ml of Sorensen buffer to 188 ml of distilled water and put it into a slide staining container.

14. Mowiol mounting medium preparation follows the below described procedure:

- 6 g glycerol and 2.4 g Mowiol 4-88 are added to a 50 ml tube;
- 6 ml distilled water are added, mixed and left for 2 h RT;
- 12 ml 0.2 M Tris buffer solution (pH 8.5) are added;
- The tube is incubated in hot water (50-55 $^{\circ}\text{C}$) for 10 minutes and stirred occasionally to allow Mowiol to dissolve (this can be repeated over several hours, if necessary);
- The solution is centrifuged at 5000 x g for 15 minutes to remove any undissolved solids;
- 1-2 ml aliquots of the Mowiol mounting medium are stored in microcentrifuge tubes at -20 $^{\circ}\text{C}$;
- At 4 $^{\circ}\text{C}$, the solution is stable for 1 month;

- Coverslipped slides are left in the dark overnight to harden before the analysis. This solution normally hardens overnight after slide preparation and does not require the coverslips to be sealed with nail polish⁴⁰⁹.

d. Practical evaluation

15. The method for blood cell collection and slide preparation is provided in the Protocol for the dissection and storage of tissue samples from marine fish (*Mullus barbatus*) of the Technical note for the collection, sampling and sample preservation of marine fish (*Mullus barbatus*) for biomarker analysis.

16. Slide staining procedure includes the following steps:

- Fixed slides are stained with 3% Giemsa solution for 10 min;
- The slides are rinsed 2 times in washing solution (Sorensen buffer 1.5%);
- The slides are air dried at room temperature;
- The slides are placed on tissue paper to be coverslipped;
- Two large drops of Eukitt or DPX (use a plastic dropper) are put on coverslips;
- The slides are inverted and placed on the coverslips. Allow the mounting medium to spread; The slides are turned so that the coverslips are on top and press the coverslips gently to expel any excess medium and air bubbles.

17. Alternatively, the slides can be stained with DAPI (300 nM in PBS) for 2-3 min and then mounted with Mowiol mounting medium. Put two large drops of Mowiol mounting medium on the slide and place on the coverslip; press the coverslip gently to expel any excess mounting medium and air bubbles.

18. The slides must be stored in a container at room temperature (Giemsa stained slides) or in a 0-4 °C fridge (DAPI stained slides). Every slide must be identify indicating the data of preparation and a code allowing to know the biometric characteristics of the mussels analysed and the name of the researcher who performed the analysis. All the information should be added in the Biomarker Analysis Register in which the position of the container in the lab should also clearly reported.

e. Result evaluation

19. Slide scoring is based on the following procedure:

- Coded and randomized slides are scored blind by a single observer;
- About 5000 erythrocytes per animal are analysed in slides stained with DAPI by a fluorescence microscope under 1000× magnification;
- About 5000 erythrocytes per animal are analysed in slides stained with Giemsa by a light microscope under 1000× magnification.

20. Criteria for micronuclei scoring are as follows:

- Diameter of micronucleus of 1/3-1/30 of the diameter of the main nucleus;
- Micronuclei are on the same optical plane as the main nucleus;
- Micronuclei are round or oval;
- Micronuclei are not linked or connected to the main nucleus;
- Micronuclei may touch but not overlap the main nucleus and the micronuclear boundary should be distinguishable from the nuclear boundary;
- Chromatin structure is similar to that of the main nucleus.

21. There is a need to consider below listed nuclear abnormalities that could be also enumerated as a complement to the evaluation of the genotoxic effects of environmental chemicals:

⁴⁰⁹ For a few chemicals there is the indication of the supplier and is highly recommended to use exactly those in order to obtain comparable results. If not specified, the reagents must be of analytical grade.

- Bud: small nuclear bodies connected with the main nucleus or as small protrusion of the nuclei; Buds usually have 1/3-1/16 diameter of the main nucleus;
- Broken eggs: nuclear bodies connected with the main nucleus or as small protrusion of the nuclei with a diameter more than ½ the main nucleus;
- Blebbed Nuclei: small evaginations of the nuclear membrane;
- Lobed Nuclei: large evaginations of the nuclear membrane;
- Binucleated cells.

22. At the end of the analysis the results of the MNi evaluation must be listed in an additional page of the Biomarker Analysis Register, indicating also the data of the analysis and the name of the researchers involved. If the slides were analysed using a video camera, the exact location of the file of the biomarker analysis must be indicated in the Biomarker Analysis Register together with the information concerning the fridge in which the slides are stored after the analysis. Moreover, the following information should be included on the score sheet for the micronucleus assay in fish cells:

- Name of the person scoring the slides;
- Code number of each slide;
- Total number of total cells scored;
- Number of cells scored (fish: > 5000)/slide;
- Number of micronuclei (MNi) and micronucleated cells (MNcells) per 1000.

23. The data can then be statistically analysed using the non-parametric Mann-Whitney *U*-test (Speigel, 1961⁴¹⁰) and compared with reference data.

f. Interpretation of the results

24. The analysis of the bibliographical data indicates that the baseline values of MNi frequency in *Mullus barbatus* blood cells may vary from 0.1 MN/1000 cells (Martinez Gomez et al., 2010) to 0.7 MN/1000 cells (Bolognesi et al., 2006⁴¹¹; Viarengo et al., 2007b⁴¹²). Davies and Vethaak (2012) suggested a background response of < 0.32 MN/1000 cells and an elevated response > 0.32 MN/1000 cells. In the Decision IG.23/6⁴¹³ no values for BAC in *M. barbatus* is reported. This is related to the fact that there are a few data concerning the MNi frequency values in *M. barbatus* sampled in the different Mediterranean areas. The value of MNi frequency in the blood cells of *M. barbatus* from unpolluted areas (controls) is one of the main requisites for the assay's application in environmental biomonitoring. However, as mentioned below (Confounding factors), due to the differences in the sea water temperature in the different Mediterranean areas, the amount of MNi in the cells of control animals may vary greatly. Therefore, in absence of BAC values, the MNi frequencies obtained in the biomonitoring studies need to be compared with the MNi values obtained by the same lab in the controls.

25. Future biomonitoring programme to be established for IMAP CI 18 should provide MNi intercalibrated data from animals sampled in the different Mediterranean regions in order to use these data for evaluation of correct BAC values.

g. Confounding factors

⁴¹⁰ Speigel, M. R., 1961. Statistics. Schaum's Outline Series. Mc Graw-Hill Book Company, 359 p.

⁴¹¹ Bolognesi, C., Perrone, E., Roggeri, P., Sciutto, A., 2006. Bioindicators in monitoring long term genotoxic impact of oil spill: Haven case study. Mar. Environ. Res. 62, S287-S291.

⁴¹² Viarengo, A., Dondero, F., Pampanin, D.M., Fabbri, R., Poggi, E., Malizia, M., Bolognesi, C., Perrone, E., Gollo, E., Cossa, G.P., 2007b. A biomonitoring study assessing the residual biological effects of pollution caused by the HAVEN wreck on marine organisms in the Ligurian Sea (Italy). Arch Environ Contam Toxicol. 53, 607-616.

⁴¹³ Decision IG.23/6 2017 Mediterranean Quality Status Report.

26. As reported for LMS, the animals show different physiological conditions in the different seasons (UNEP/RAMOGÉ, 1999; ICES, 2001; Moore et al., 2004⁴¹⁴; Viarengo et al., 2007a⁴¹⁵; OSPAR Commission, 2013). For this reason, the animals should not be sampled in the summer and in the winter and always out from the spawning period: in fact, in these periods fish are often in a poor condition showing reduced detoxification of pollutants and DNA repair capacity. It is important to highlight that water temperature was shown to have a direct effect on the mitotic rate and on the level of DNA damage and consequently on the extent of MN expression with different baseline MN values for different water temperatures (Barsiene et al., 2004). Therefore, exogenous factors other than genotoxic pollutants, such as climatic variations modulating the induction of genotoxic damage, have to be considered in the data analysis; therefore, as mentioned above, it is always necessary to compare the MN data obtained to those of the reference animals sampled under similar environmental conditions.

h. Reporting data

27. The unit for the agreed toxicological test MNi frequency under IMAF CI18 for fish (*Mullus barbatus*) is: MNi/1000 cells.

2.2 Protocol for the analysis of micronuclei (MNi) frequency in mussel gill cells and haemocytes and evaluation and interpretation of the results

a. Materials

28. Application of this protocol requires availability of the following material: 15 ml centrifuge tubes, polypropylene, sterile, conical bottom; Microcentrifuge tubes, snap cap, 2.0 ml; Corning stripettes, disposable serological plastic pipette, 10 ml; Corning stripettes, disposable serological plastic pipette, 5 ml; Glass Pasteur pipettes, 150 mm; Pasteur pipette rubber bulbs; Petri dishes; Volume adjustable pipette, 20-200 µl and 200-1000 µl; Pipette tips, 20-200 µl and 200-1000 µl; Single-use syringe, Luer Lock, 10-20 ml; Single-use syringe, 5 ml; Dissecting forceps, fine and medium; Dissecting scissors; Fine scissors 14 cm length; Scalpel blades and handles; Ice and ice bucket; Swinnex filter holders 25 mm; Nylon Net filters, type NY8H, 180 µm pore size; Nylon Net filters, type NY80, 80 µm pore size; Counting chambers (e.g. Thoma or Burcker); Microscope slides, 76x26 mm, 1 mm thick, pre cleaned/ready to use, Menzel-Gläser, Superfrost, wiped with ethanol and allowed to dry before use; Coverslips, no.1 (0.13 - 0.16 mm), 60 x 24 mm, Menzel-Gläser; Coplin jar, glass, for 10 slides; Microscope slide staining container, glass; slide staining rack; Storage microscope slides boxes.

b. Equipment

29. The equipment needed for the analysis includes: Bench top centrifuge, capable of spinning at 1000 × g; Rotary mixer for tubes; Chemical safety cabinet; Magnetic stirrer; Vortex; Vacuum pump; pH meter; Freezer -20 °C; Microscope with good quality optics for bright-field examination of stained slides at 1000× magnification; Fluorescence microscope ocular (10×) and objective (100×) final magnification of 1000 ×.

c. Chemicals and Solutions

30. For the analysis of micronuclei (MNi) frequency in mussels (*Mytilus* sp.) gill cells and haemocytes and for the evaluation and interpretation of the results, the following chemical and solutions are used: PBS, P3813-10 Pak, SIGMA-Aldrich; HANKS' Balanced Salts (HBSS), without

⁴¹⁴ Moore, M.N., Lowe, D. and Köhler, A. 2004. Biological effects of contaminants: Measurement of lysosomal membrane stability. ICES Techniques in Marine Environmental Sciences. No. 36. 39 pp.

⁴¹⁵ Viarengo, A., Lowe, D., Bolognesi, C., Fabbri, E., Koehler, A., 2007a. The use of biomarkers in biomonitoring: a 2-tier approach assessing the level of pollutant-induced stress syndrome in sentinel organisms. Comp. Biochem. Physiol. C 146, 281-300.

sodium bicarbonate and phenol red, H1387, SIGMA-Aldrich; Dispase I (neutral protease, grade I), 04942086001, 10 x 2 mg (Roche); Methanol, Methyl alcohol, absolute, Assay: 99,8%; Glacial Acetic Acid, puriss., Assay: 99.8-100.5%; Giemsa's azure eosin methylene blue solution (Sigma Aldrich, 1.09204); Eukitt, quick-hardening mounting medium for microscopy, or DPX Mountant for histology; DAPI (4',6-Diamidino-2-Phenylindole, Dilactate). To prepare Mowiol mounting medium: Mowiol 4-88, glycerol, Tris.

31. Preparation of HANKS' balanced salts solution (HBSS) 2X, pH 7.4 is based on the following procedure (Bolognesi and Fenech, 2012):

- 1 litre of solution 2X is prepared by adding the content of two packages of HANKS' balanced salts (HBSS), (SIGMA-Aldrich cat No. H-1387) to 800 ml of distilled water, gently stirring until dissolved. Do not heat. The original package is rinsed with a small amount of water to remove all traces of powder;
- 0.7 g sodium bicarbonate is added to the solution;
- Stir until dissolved. While stirring, the pH of the solution is adjusted if necessary (pH 7.4);
- Additional water is added to bring the solution to the final volume.

32. A Dispase solution (grade I, > 6 U/mg, Roche) 0.1 mg/ml in HANKS' 2X is prepared by dissolving 5 mg of the lyophilized enzyme in 50 ml of HANKS' 2X solution at room temperature. Use fresh solution for each experiment.

33. 100 ml of fixative are prepared by mixing methanol with glacial acetic acid in the ratio of 3:1. The fixative should be freshly prepared each time and used at 4 °C. This procedure should be undertaken in a well-ventilated fume hood. GIEMSA staining solution and Mowiol mounting medium are prepared as described for the MNi analysis in fish cells⁴¹⁶.

d. Practical evaluation

34. The method for mussel haemolymph collection is provided in Protocol for the dissection and storage of tissue samples from marine molluscs (such as *Mytilus* sp.) of the Technical note for the collection, transport and sampling of marine molluscs (such as *Mytilus* sp.) for biomarker analysis. After obtaining the haemolymph sample, the needle is discharged and the content is expelled in a centrifuge tube. The obtained cell suspensions are centrifuged at 1000 rpm (220 ×g) for 5 min.

35. The method for mussel gill collection is provided in the Protocol for the dissection and storage of tissue samples from marine molluscs (such as *Mytilus* sp.) of the Technical note for the collection, transport and sampling of marine molluscs (such as *Mytilus* sp.) for biomarker analysis.

e. Gill cell preparation

Plastic Millipore filter holders (Swinnex) or stainless-steel filter holder are used: nylon filters (180 nm and 80 nm) were assembled in two different filter holders to be used in sequence:

- Step 1: Mussels (6-10 animals/experimental group) are dissected, gills are removed and placed in a coded test tube/animal;
- Step 2: Gills are minced. 2 ml of dispase enzyme (0.1 mg/ml) in Hank's 2X are added. The enzymatic incubation is 10 min at room temperature in a rotating stirrer;
- Step 3: 7 ml of Hank's solution 2X are added to each test tube. The obtained cell suspension is filtered using a syringe connected with the filter apparatus. The filtered cell suspensions are collected in centrifuge test tubes. The quality of the cell suspension is checked using an inverted microscope. The cell suspensions are centrifuged at 1000 rpm (228×g) 5min at room temperature.

36. The procedure for slide preparation requires the following steps:

⁴¹⁶ For a few chemicals there is the indication of the supplier and is highly recommended to use exactly those in order to obtain comparable results. If not specified, the reagents must be of analytical grade.

- After removing the supernatant, the pellet is suspended in fixative solution (methanol: acetic acid = 3:1) in a volume of 1-2 ml based on the number of cells;
- After at least 20 min the cellular suspensions are dropped on frozen slides (-20 °C). The slides are air dried at room temperature.

37. Slide staining procedure is as follows:

- The microscope slides with the fixed cells are immersed for 5 min at room temperature in Coplin jars or staining dishes containing 3% Giemsa solution;
- The slides 2 times are rinsed in the washing solution (Sorensen buffer 1.5%);
- The slides are air dried at room temperature;
- The slides to be coverslipped are placed on tissue paper;
- Two large drops of Eukitt or DPX (use a plastic dropper) are put on coverslips;
- The slide is inverted and the coverslip is placed on. Allow the mounting medium to spread. The slide is turned so that the coverslip is on top, and the coverslip is pressed gently to expel any excess mounting and air bubbles.

38. Alternatively, the slides can be stained with DAPI (300 nM in PBS) for 2-3 min and then mounted with Mowiol mounting medium. Two large drops of Mowiol mounting medium are put on the slide and the coverslip is placed on; the coverslip is pressed gently to expel any excess of mounting medium and air bubbles. The slides must be stored in a container at room temperature (Giemsa stained slides) or in a 0-4 °C fridge (DAPI stained slides). Every slide must be identify indicating the data of preparation and a code allowing to know the biometric characteristics of the mussels analysed and the name of the researcher who performed the analysis. All the information should be added in the Biomarker Analysis Register in which the position of the container in the lab should also clearly reported.

f. Result evaluation

39. Slide scoring requires use of the following equipment: Optical microscope ocular (10×) and objective (100×) final magnification of 1000×. Coded and randomized slides were scored blind by a single observer. At least 2000 cells have to be scored for micronuclei evaluation in mussel haemocytes; only agranular haemocytes should be selected for MNi evaluation. Criteria for cell scoring are as follows:

- Haemocytes: haemocytes with well spread nuclear chromatin. The cytoplasmic boundary or membrane of the cell should be intact and clearly distinguishable from the cytoplasmic boundary of adjacent cells;
- Gill cells: agranular epithelial-like cells with well spread nuclear chromatin. The cytoplasmic boundary or membrane of the cell should be intact and clearly distinguishable from the cytoplasmic boundary of adjacent cells.

40. Criteria for micronuclei scoring are as follows:

- Diameter of micronucleus is smaller than 1/3 of the diameter of the main nucleus;
- Micronuclei are on the same optical plane as the main nucleus;
- Micronuclei are round or oval;
- Micronuclei are not linked or connected to the main nucleus;
- Micronuclei may touch but not overlap the main nucleus and the micronuclear boundary should be distinguishable from the nuclear boundary;
- Chromatin structure is similar to that of the main nucleus.

41. At the end of the analysis the results of the MNi evaluation must be listed in an additional page of the Biomarker Analysis Register (indicating also the data of the analysis and the name of the researchers involved). If the slide were analysed using a video camera, the exact location of the file of the biomarker analysis must be indicated in the Biomarker Analysis Register together with the information concerning the fridge in which the slides are stored after the analysis.

42. Moreover, the following information should be included on the score sheet for the micronucleus assay in mussel cells:

- Name of the person scoring the slides;
- Code number of each slide;
- Total number of total cells scored;
- Number of cells scored (mussels: > 2000);
- Number of micronuclei (MNi) and micronucleated cells (MNcells) per 1000.

The data can then be statistically analysed using the non-parametric Mann-Whitney U-test (Speigel, 1961) and compared with reference data.

g. Interpretation of the results

43. Although Decision IG23/6 on the 2017 Mediterranean Quality Status Report (2017 MED QSR) and Davies and Vethaak (2012) define BAC value of 1 MN/1000 cells in mussels (*Mytilus galloprovincialis*), it is worth mentioning that a wider analysis of the bibliographical data clearly indicates that the baseline values of MN frequency in haemocytes and gill cells of mussels varies with the water temperature ranging from 0.37 MN/1000 cells at water temperature of 5 °C (Barsiene et al., 2004, 2006) to 6 MN/1000 cells at temperature 20 °C (Bolognesi and Fenech, 2012). The availability of BAC values in mussels from unpolluted areas (controls) is one of the main requisites for the assay's application in environmental biomonitoring. In absence of generally accepted BAC values, the MN frequencies obtained in the biomonitoring studies needs to be compared with the range of MN values obtained by the same lab in the controls.

44. Future biomonitoring programme to be established for IMAP CI 18 should provide MNi intercalibrated data from animals sampled in the different Mediterranean regions in order to use these data for evaluation of correct BAC values.

h. Confounding factors

45. It is well documented the animals show different physiological conditions in the different seasons (UNEP/RAMOGGE, 1999; ICES, 2001; Moore et al., 2004; Viarengo et al., 2007a; OSPAR Commission, 2013). For this reason, the animals should be not sampled in the summer and in the winter and always out from the spawning period: in fact, in these periods mussels and fish are often in a poor condition showing reduced detoxification of pollutants and DNA repair capacity. Water temperature was shown to have a direct effect on the cell mitotic rate and consequently on the extent of MN expression with different baseline MN values for different water temperatures (Barsiene et al., 2004; 2006). Exogenous factors other than genotoxic pollutants, such as climatic variations modulating the induction of genotoxic damage, have to be considered in the data analysis (ICES, 2011); therefore, as mentioned above, it is always necessary to compare the MN data obtained to those of the reference animals sampled under similar environmental conditions.

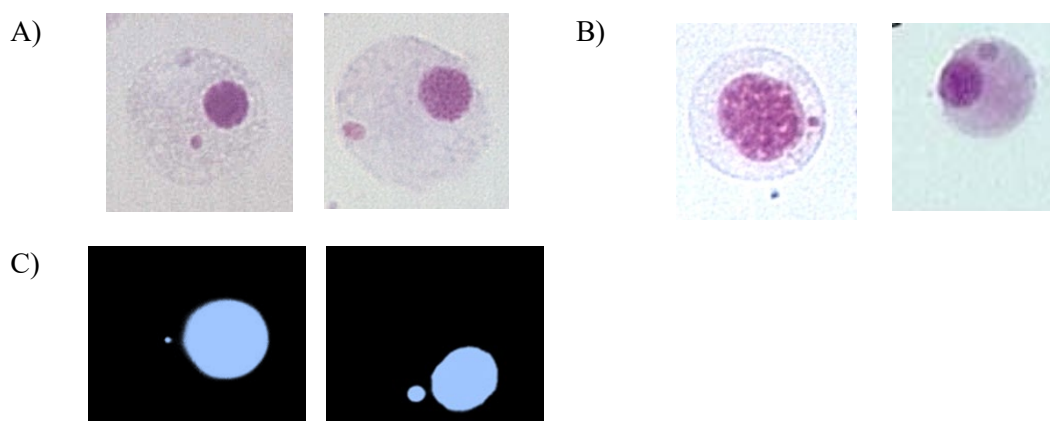

Figure 5: Images of different cell types from mussels (*Mytilus galloprovincialis*) stained using 3% Giemsa. A) Agranular gill aciliated cells with MNi, B) Agranular Hemocytes with MNi, C) Agranular gill cells with MNi, stained using DAPI.

46. In the papers reported in the References, a photo gallery of the various cell types, MN and nuclear anomalies is present (Barsiene et al., 2006; Bolognesi and Fenech, 2012; Davies and Vethaak, 2012).

i. Reporting data

47. As provided in IMAP Guidance Fact Sheet for CI 18, the unit agreed for Micronucleus assay toxicological test under IMAP CI18 is number of cases, % in haemocytes i.e. MNi/1000 cells in bivalve molluscs such as mussel.

3. Technical note for the analysis of Acetylcholinesterase (AChE) activity in mussel gills and fish muscle

48. Acetylcholinesterase (AChE) is the enzyme present in the plasma membrane of numerous cell types of most animals, which catalyses the reaction:

Acetylcholine \longrightarrow choline + acetic acid.

49. AChE activity was proposed as a biomarker of exposure to anticholinergic compounds such as Carbamates and Organophosphorus Pesticides (OP) (Bocquené et al., 1993⁴¹⁷; Escartín and Porte, 1997⁴¹⁸; Boucquené and Galgani, 1998; Burgeot et al., 2001⁴¹⁹; Galloway et al., 2002⁴²⁰). In vertebrate tissues, this enzyme activity was found to be extremely sensitive to these two classes of pesticides and, consequently, these chemicals are able to affect numerous physiological functions of the animals, such as respiration, feeding, swimming, etc. For these reasons, this biomarker could also be considered a biomarker of stress; in fact, the inhibition of this enzyme activity could alter the capacity of the animals to adapt to their environment. It also has been demonstrated that numerous environmental contaminants such as PAHs, PCBs, metals, etc. may affect AChE activity (Bocquené et al., 1993; Escartín and Porte, 1997; Solé et al., 2010⁴²¹).

50. However, it should be noted that the sensitivity of AChE activity to Carbamates and OP may vary greatly in different organisms. In particular, in marine mussels, the sensitivity of AChE activity to pesticides is similar to that of biomarkers such as lysosomal membrane stability (LMS), a well-known biomarker of stress (Rickwood and Galloway, 2004⁴²²). In the bivalve molluscs, a decrease of the AChE activity can only give an indication of possible environmental contamination by pesticides and so, should be considered as a general stress biomarker.

51. In line with above elaborated, under the Technical Note, the Monitoring Guidelines for Biomarker Analysis of Marine Molluscs (such as *Mytilus sp.*) and Fish (such as *Mullus barbatus*) for IMAP Common Indicator 18 provides the Protocol for tissue homogenate preparation and for enzymatic determination of AChE activity, as well as evaluation and interpretation of the results.

⁴¹⁷ Bocquené, G. Galgani, F., Burgeot, T., Le Dean, L., Truquet, P., 1993. Acetylcholinesterase levels in marine organisms along French coasts. Mar. Poll. Bull. 26, 101-106.

⁴¹⁸ Escartín, E., Porte, C., 1997. The use of cholinesterase and carboxylesterase activities from *Mytilus galloprovincialis* in pollution monitoring. Environ. Toxicol. Chem. 16, 2090-2095.

⁴¹⁹ Burgeot, T., Bocquené, G., His, E., Vincent, F., Geffard, O., Beira, R., et al., 2001. Monitoring of biological effects of pollutants: field application. In: Garrigues Ph., Barth, H., Walker, C.H., Narbonne, J.F., editors. Biomarkers in marine organisms: a practical approach. Amsterdam: Elsevier, pp. 179-213.

⁴²⁰ Galloway, T.S., Millward, N., Browne, M.A., Depledge, M.H., 2002. Rapid assessment of organophosphorous/carbamate exposure in the bivalve mollusc *Mytilus edulis* using combined esterase activities as biomarkers. Aquat Toxicol. 61, 169-180.

⁴²¹ Solé, M., Baena, M., Arnau, S., Carrasson, M., Maynou, F., Cartes, J.E., 2010. Muscular cholinesterase activities and lipid peroxidation levels as biomarkers in several Mediterranean marine fish species and their relationship with ecological variables. Environ. Int. 36, 202-211.

⁴²² Rickwood, C.J., Galloway, T.S., 2004. Acetylcholinesterase inhibition as a biomarker of adverse effect. A study of *Mytilus edulis* exposed to the priority pollutant chlorfenvinphos. Aquat Toxicol. 67, 45-56.

3.1 Protocol for tissue homogenate preparation and for enzymatic determination of AChE activity, as well as evaluation and interpretation of the results

a. Principle

52. As indicated in the IMAP Guidance Factsheets (UNEP/MED WG.467/5, 2019⁴²³), the method for the biochemical evaluation of the AChE activity is based on the capacity of the enzyme to use as specific substrate Acetylthiocholine (ACTC):

Acetylthiocholine \longrightarrowThiocholine + Acetic acid

53. The thiocholine released by the AChE activity is detected by the reaction with 5,5'-dithio-bis-[2-nitrobenzoic acid] (DTNB), a reagent specific for thiol detection, leading to the formation of 5-mercapto-2-nitrobenzoate that has a yellow colour and a maximum of absorbance at 412 nm. This method for the evaluation of AChE activity was initially described by Ellman et al. (1961⁴²⁴). The method here reported, based on Ellman et al. (1961), was adapted to obtain the best analytical conditions as reported by Bocquené and Galgani (1998⁴²⁵) and Galloway et al. (2002).

b. Materials

54. The following materials are needed to ensure optimal implementation of this Protocol: Volume adjustable pipette, 20-200 µl and 200-1000 µl; Pipette tips, 20-200 µl and 200-1000 µl; 15 ml centrifuge tubes, polypropylene, sterile, conical bottom; Microcentrifuge tubes, snap cap, 2.0 ml; 100 mL, 200 mL glass beaker; Glass graduated cylinders; 1-3 mL Spectrophotometer Cuvettes (10 mm light path).

a. Equipment

55. The following equipment is needed: Homogenization apparatus (a Potter apparatus for soft tissue such as gills and an Ultra Turrax apparatus for muscle homogenization); Refrigerated centrifuge (20 000 x g); Spectrophotometer UV-Visible; Thermostatic ice container; Weight scale (0.01 g).

b. Chemicals and Solutions

56. The chemicals and solution needed for application of this protocol are as follows: 0.02 M sodium phosphate buffer pH 7 (added with 0.1 % Triton X-100 before use) (the phosphate buffer can be stored at 0-4 °C); 10 mM 5,5'-Dithiobis(2-nitrobenzoic acid) (DTNB) (Sigma Aldrich, D8130) in Tris 0.1 M pH 8 (this solution can be stored at 0-4 °C for one week); 0.1 M Acetylthiocholine (ACTC) iodide (Sigma Aldrich, A5751) (ACTC substrate can be stored at -20 °C, the ACTC solution should be prepared freshly before the use); Bradford Reagent (Sigma Aldrich, B6916); BSA - Albumin, bovin serum, fraction V, fatty acid free (Sigma Aldrich, 126575 : for a few chemicals there is the indication of the supplier and is highly recommended to use exactly those in order to obtain comparable results. If not specified, the reagents must be of analytical grade).

c. Mussel gills homogenate preparation

57. Extraction is performed on fresh or frozen tissue (1:4 W:V) using 0.02 M phosphate buffer pH 7.0 (+ 0.1% Triton X-100). The tissue (from 0.1 to 1 g) is homogenized for one min using a Potter homogenizer. Extracts are then centrifuged at 10000 × g for 30 minutes at 4 °C and an aliquot of the supernatant is used in the assay. The supernatant can be stored at -20 °C or below (for 12 months) without significant loss of activity.

⁴²³ UNEP/MED WG.467/5, 2019. IMAP Guidance Factsheets: Update for Common Indicators 13, 14, 17, 18, 20 and 21; New proposal for Candidate Indicators 26 and 27.

⁴²⁴ Ellman, G.L., Courtney, K.D., Andres, V. Jr, Feather-Stone, R.M., 1961. A new and rapid colorimetric determination of acetylcholinesterase activity. *Biochem Pharmacol.* 7, 88-95.

⁴²⁵ Bocquené, G., Galgani, F. 1998. Biological effects of contaminants: Cholinesterase inhibition by organophosphate and carbamate compounds. *ICES Techniques in Marine Environmental Sciences*, No. 22.

d. Muscle fish homogenate preparation

58. The procedure is the same as described for mussel gills. Only the initial step of the homogenate preparation is different because it needs to use an Ultra-Turrax apparatus to prepare the muscle homogenate. If a blender is not available, the tissue can be treated with liquid nitrogen in a porcelain mortar to reduce it in a powder with a pestle. An aliquot of the muscle powder preparation is then homogenized as described above and properly diluted (1/5-1/10) before using it in the analysis.

e. Determination of AChE activity

59. The procedure for determination of AChE activity can be summarized as follows:

- 60 µl of 10 mM DTNB (0.5 mM final concentration) and 100 µl of supernatant (about 200-500 µg proteins) are added in a total volume of 1200 µl 0.02 M phosphate buffer (pH 7); all the reagents must be brought to 20 C° before the start of the analysis; also, the temperature of incubation and reaction must be kept at room or controlled temperature, such as +20°C.
- After 5 min incubation to allow the DTNB to react with the sulfhydryl groups of the amino acids in the sample, 31.2 µl of 0.1 M ACTC (2.6 mM final concentration) are added to start the enzymatic reaction;
- The enzymatic reaction rate was quantified using a spectrophotometer (412 nm) against a blank without ACTC substrate. In order to subtract the spontaneous hydrolysis of substrate, a second blank is performed without sample in the reaction mixture;
- The reaction for the analysis of the homogenate is usually run for 1-5 min; the time may vary in relation to the enzymatic activity of the sample that can change in different animals as well in animals in different physiological states.

f. Protein determination

60. It is suggested to evaluate the protein content using the method of Bradford (1976⁴²⁶), This procedure for protein determination can be summarized as follows:

- Protein concentration is evaluated in accordance with Bradford (1976⁴²⁷). The method consists of mixing 1 part of the protein sample with 30 parts of the Bradford Reagent. The sample may be a blank, a protein standard, or an unknown sample. The blank consists of the homogenisation buffer with no protein. The protein standard consists of a known concentration of the bovine serum albumin -BSA (Albumin, bovin serum, fraction V, fatty acid free)- protein solubilised in the homogenisation buffer; the concentrations used for the preparation of BSA standards range from 0.025 to 0.8 mg/ml (stock solution 1 mg/ml);
- The assay is performed directly in a cuvette by adding 0.05 ml of sample, standard and blank to 1.5 ml of Bradford Reagent (acclimatisation at 20 C°) in the dark. The S10 sample is diluted (1:5 - 1:10) with the homogenization buffer before performing the assay;
- The absorbance values recorded for the samples are interpolated to the standard values to obtain the mg of protein contained in 1 mL of sample, and multiplied by the dilution factor (in this case 5 - 10) to finally obtain the mg / mL of proteins.

g. Result evaluation

61. The results of evaluation need to be derived on the following equation for Calculation of AChE activity:

⁴²⁶ Bradford, M M, 1976. A Rapid and Sensitive Method for the Quantitation of Microgram Quantities of Protein Utilizing the Principle of Protein-Dye Binding. Anal. Biochem. 72, 248-254.

⁴²⁷ Bradford, M M, 1976. A Rapid and Sensitive Method for the Quantitation of Microgram Quantities of Protein Utilizing the Principle of Protein-Dye Binding. Anal. Biochem. 72, 248-254.

$$\text{AChE activity (nmol min}^{-1} * \text{mg protein}^{-1}) = (\Delta\text{OD}_{412 \text{ min}^{-1} \text{ sample}} - \Delta\text{OD}_{412 \text{ min}^{-1} \text{ blank}}) * V_{\text{tot}} / (0.0136 * L * V_{\text{s}} * \text{tot prot. conc.}) = (\Delta\text{OD}_{412 \text{ min}^{-1} \text{ sample}} - \Delta\text{OD}_{412 \text{ min}^{-1} \text{ blank}}) * V_{\text{tot}} / (0.0136 * L * \text{mg protein}) .^{428}$$

where: $\Delta\text{OD}_{412 \text{ min}^{-1} \text{ sample}} - \Delta\text{OD}_{412 \text{ min}^{-1} \text{ blank}}$ = change in optical density (absorbance) per minute of sample at 412 nm, corrected for spontaneous hydrolysis (blank);

V_{tot} = total assay volume (ml);

0.0136 = nmolar extinction coefficient of TNB ($\text{nM}^{-1}\text{cm}^{-1}$);

L = light path (which is 1 cm for multi well and cuvette);

V_{s} = sample volume (ml);

tot prot. conc. = total protein concentration in the enzymatic extract (mg ml^{-1});

mg protein = $V_{\text{s}} * \text{tot. prot. conc.}$

62. A few examples for results evaluation are listed here-below:

- 100 μl of a mussel gill extract give a rough activity of $0.200 \text{ OD min}^{-1}$;
- The protein concentration of the extract is 5 mg/ml ($5 \mu\text{g}/\mu\text{l}$);
- 100 μl of mussel gill extract = $100 \times 5 = 500 \mu\text{g} = 0.5 \text{ mg}$;
- AChE activity, expressed in $\text{U min}^{-1} \text{ mg protein}^{-1}$, is: $0.200 \text{ OD min}^{-1} * V_{\text{tot}} 1.2 \text{ ml} / 0.5 \text{ mg protein} = 0.48 \text{ U min}^{-1} \text{ mg protein}^{-1}$;
- $\text{U min}^{-1} \text{ mg protein}^{-1} / 0.0136$ (molar extinction coefficient) = nmol of substrate hydrolysed $\text{min}^{-1} \text{ mg protein}^{-1}$;
- $0.48 \text{ U min}^{-1} \text{ mg protein}^{-1} / 0.0136 = 35.3 \text{ nmol ACTC hydrolysed min}^{-1} \text{ mg protein}^{-1}$;
- i.e.: $1 \Delta\text{OD}_{412 \text{ min}^{-1} \text{ mg protein}^{-1}}$ corresponds to the hydrolysis of 73.53 nmol of ACTC;
- Expressed in nmol of substrate hydrolysed, the specific activity is: $0.48 \text{ U min}^{-1} \text{ mg protein}^{-1} \times 73.53 \text{ nmol} = 35.3 \text{ nmol ACTC hydrolysed min}^{-1} \text{ mg protein}^{-1}$.

63. At the end of the analysis, the results of the evaluation of the AChE activity must be listed in an additional page of the Biomarker Analysis Register, indicating also the data of the analysis and the name of the researchers involved. In the Biomarker Analysis Register, the information concerning the $-80 \text{ }^{\circ}\text{C}$ freezer in which the homogenates of the different samples are stored after the analysis should be also recorded.

h. Interpretation of the results

64. Background Assessment Levels (BAC) and Environmental Assessment Criteria (EAC) for AChE activity are previously proposed in Decision IG.23/6 on 2017 Mediterranean Quality Status Report:

- AChE activity (nmol/min/mg protein) in mussel gills in French Mediterranean waters: BAC = 29, EAC = 20;
- AChE activity (nmol/min/mg protein) in mussel gills in Spanish Mediterranean waters: BAC = 15, EAC = 10.

65. So far, data of AChE activities in *M. galloprovincialis* and *M. barbatus* from reference areas from the Mediterranean Sea are very limited. It has been proposed that the baseline level should be defined on a regional basis, using available long-term data (which is not yet widely available). BACs in mussel gills from Spanish Mediterranean waters were calculated using values obtained from at least two reference areas (on the basis of chemical analysis in mussel tissues) and from at least three years sampling (data submitted to MED POL database), along with records of salinity and temperature of the ambient water at the sampling time. EAC are usually derived from toxicological data and, in this case, they were calculated by subtracting 30% from BAC values (Davies and Vethaak, 2012).

⁴²⁸ Note: OD_{412} = Optical Density = Absorbance at 412 nm wavelength.

66. In the past, the labs have not used common protocols for mussels collection and transport, tissue sampling and storage; moreover, the methodologies used for the analysis of the AChE activity were not intercalibrated between those lab providing data and the methods used to calculate the protein content (i.e. Bradford versus Lowry) could be playing also a role in the final value of AChE activities. The BAC and EAC values in the gills of mussels sampled in coastal areas showing relatively similar climatic characteristics should be more similar, although South-East-South of the Spanish Mediterranean Coast is a different marine region than the French Mediterranean coast. A well-organised Q.A. programme based on the intercalibration activity, the use of the same analytical protocol (here reported) and the same reagents is required to clarify the differences in the experimental results obtained in the organisms sampled in different Mediterranean areas. Moreover, it should be noted that it may be difficult to find unpolluted sites along coasts in areas characterized by extensive agricultural activities, a fact that may be important in the estimation of the BAC values.

67. The data reported clearly demonstrate that for AChE activity, the results should be interpreted on the basis of the enzymatic activity values found in the reference mussels sampled in a well-established relatively uncontaminated coastal area. The reported data indicate that a reduction of 30% of the value obtained in the control animals may represent a correct EAC value. It is important to emphasize that the use of caged mussels, obtained from a production farm, usually minimises this problem and facilitates the interpretation of the results.

68. Although present assessment criteria do not provide values of AChE activity in fish, it is worth mentioning the values of AChE activity in *M. barbatus* muscle as proposed by Davies and Vethaak (2012) based on the analytical data of Burgeot et al. (1996⁴²⁹): BAC = 155 nmol/min/mg protein and EAC = 109 nmol/min/mg protein. However, Solé et al. (2010) reported an AChE value of 53.3 nmol/min/mg protein for the unpolluted site of Besòs (Spain). Given no BAC or EAC values for *Mullus barbatus* have been proposed in Decision 22/7 on IMAP and 23/6 Decision on 2017 Mediterranean Quality Status Report., UNEP/MAP will consider these values in the scope of further work that will be undertaken to upgrade the assessment criteria.

69. As mentioned above, also in the case of *M. barbatus*, the problem of the differences in the AChE analytical results could be clarified in the framework of the Q.A. activities (Viarengo et al., 2000⁴³⁰). Moreover, the results of AChE activity should be interpreted on the basis of the values obtained in the reference fish sampled in a well-established relatively uncontaminated area. A reduction of 30% of the value obtained in the control animals may represent a correct EAC value.

i. Confounding factors

70. The animals show different physiological status during the different seasons (UNEP/RAMOG, 1999; ICES, 2001; Moore et al., 2004; Viarengo et al., 2007a; OSPAR Commission, 2013). For this reason, the animals should be not sampled in the summer and in the winter and always outside the spawning period. As for other enzymatic activities, climatic changes, and in particular the values of water temperature, can affect the level of the AChE activity (Hogan, 1970⁴³¹).

71. The AChE activity level may vary between juveniles and adult fish; therefore, a particular attention must be given to using animals with similar biometrics characteristics, indicating fish of similar age (Galgani et al., 1992⁴³²). In *Mytilus edulis* from the Baltic Sea, the AChE values vary

⁴²⁹ Burgeot, T., Bocquené, G., Porte, C., Pfohl Leszkowicz, A., Santella, R.M., Raoux, C., Dimeet, J., et al. 1996.

Bioindicators of pollutant exposure in the northwestern part of the Mediterranean Sea. Mar. Ecol. Prog. Ser. 131, 125-141.

⁴³⁰ Viarengo, A.; Lafaurie, M.; Gabrielides, G.P.; Fabbri, R.; Marro, A., Roméo, M., 2000. Critical evaluation of an intercalibration exercise undertaken in the framework of the MED POL biomonitoring program. Mar. Environ. Res. 49, 1-18.

⁴³¹ Hogan, J.W., 1970. Water temperature as a source of variation in specific activity of brain acetylcholinesterase of bluegills. Bull. Environ. Contam. Toxicol. 5, 347-353.

⁴³² Galgani F., Bocquené G., Cadiou, Y., 1992. Evidence of variation in cholinesterase activity in fish along a pollution gradient in the North Sea. Mar. ecol. Prog. Ser. 91, 1-3).

twofold depending on the sampling season, in relation to the temperature changes (Leiniö and Lehtonen, 2005⁴³³).

72. The AChE activity was found to be affected by algal toxin (Dailianis et al., 2003⁴³⁴; Kankaanpää et al., 2007⁴³⁵). It is therefore suggested to report in the Biomarker Analysis Register the information about the presence of an algal bloom when the animals are collected.

j. Reporting data

73. As provided in IMAP Guidance Fact Sheet for CI 18, the unit for Acetylcholinesterase (AChE) activity assay in bivalve molluscs (such as *Mytilus* sp.) or fish (*M. barbatus*) is: nmol/min/mg protein.

4. Technical note for the analysis of Stress on Stress (SoS) in mussels

74. This biomarker is based on the definition of “stress”: stress is a measurable alteration of the organism’s physiology induced by an environmental change that results in a reduced capacity of the individual to adapt to further environmental variations (Bayne, 1986⁴³⁶). This concept was practically applied to mussels superimposing exposure to air, a natural stressor, over the harmful effects of chemicals contamination in their environment. Marine mussels are often naturally exposed to air (Bayne, 2009⁴³⁷) for short periods of time (hours) but they can also survive for days out of water. This ability to sustain prolonged emersion periods is due to their capacity to reduce the water loss by valve (shell) closure; and the muscle contraction required for this is supported by a shift of the energy metabolism from aerobic to anaerobic, typical of these organisms (De Zwaan and Zandee, 1972⁴³⁸; Bayne, 2009). The toxic chemicals, by altering the cellular functions and increasing energy requirement for the detoxification mechanisms, or directly affecting the energy metabolism, can reduce the ATP availability for basic physiological functions, and in particular for muscular contraction, thus leading to animal death in a short time.

75. Numerous experimental studies have confirmed that this biomarker at the whole animal level is suitable for identifying the effects of low concentrations of contaminants in the water. In particular, it was demonstrated that inorganic contaminants such as heavy metals (Cu and Cd) or organic aromatic compounds such as 9,10-dimethyl 1,2-benzo anthracene (DMBA) and PCBs (Aroclor 1254) and organochemicals at submicromolar concentrations affect the SoS response in mussels in a dose dependent manner; and that the toxic effect is significantly increased in the molluscs exposed to chemical mixtures (Eertman et al., 1993⁴³⁹; Viarengo et al., 1995⁴⁴⁰; Marcheselli et al., 2011⁴⁴¹).

76. It is important to point out that PAHs, one of the more ubiquitous groups of environmental contaminants, may affect SoS in mussels (*Mytilus trossulus*) sampled from field contaminated areas

⁴³³ Leiniö, S. and Lehtonen, K. K. 2005. Seasonal variability in biomarkers in the bivalves *Mytilus edulis* and *Macoma balthica* from the northern Baltic Sea. *Comp. Biochem. Physiol. C* 140, 408–421.

⁴³⁴ Dailianis, S., Domouhtsidou, G.P., Raftopoulou, E., Kaloyianni, M., Dimitriadis, V.K., 2003. Evaluation of neutral red retention assay, micronucleus test, acetylcholinesterase activity and a signal molecule (cAMP) in tissues of *Mytilus galloprovincialis* (L.), in pollution monitoring. *Marine Environmental Research* 56, 443–470.

⁴³⁵ Kankaanpää, H., Leiniö, S., Olin, M., Sjövall, O., Meriluoto, J., Lehtonen, K. K., 2007. Accumulation and depuration of cyanobacterial toxin nodularin and biomarker responses in the mussel *Mytilus edulis*. *Chemosphere* 68, 1210–1217.

⁴³⁶ Bayne, B.L., 1986. In: *The Role of the Oceans as a Waste Disposal Option*, ed. G. Kulleberg. Riedel, NY, pp. 617–634.

⁴³⁷ Bayne, B.L., 2009. *Marine Mussels: Their Ecology and Physiology*. Cambridge University Press 528 p.

⁴³⁸ De Zwaan, A., Zandee D.I., 1972. The utilization of glycogen and accumulation of some intermediates during anaerobiosis in *Mytilus edulis* L. *Comp. Biochem. Physiol. Part B* 43, 47–54.

⁴³⁹ Eertman, R.H.M., Wagenvoort, A.J., Hummel, H., Smaal, A. C., 1993. “Survival in air” of the blue mussel *Mytilus edulis* L. as a sensitive response to pollution-induced environmental stress. *J. Exp. Mar. Biol. Ecol.* 170, 179–195.

⁴⁴⁰ Viarengo, A., Canesi, L., Pertica, M., Mancinelli, G., Accomando, R., Smaal, A.C., Orunesu, M., 1995. Stress on Stress Response: A Simple Monitoring Tool in the Assessment of a General Stress Syndrome in Mussels. *Mar Environ Res* 39, 245–248.

⁴⁴¹ Marcheselli, M., Azzoni, P., Mauri, M., 2011. Novel antifouling agent-zinc pyrithione: Stress induction and genotoxicity to the marine mussel *Mytilus galloprovincialis*. *Aquat. Toxicol.* 102, 39–47.

(Thomas et al., 1999⁴⁴²). These findings confirm the general applicability of this stress biomarker as being sensitive to the various classes of pollutants in the laboratory, as well under field conditions. Although it was demonstrated that other biomarkers such as LMS or Scope for Growth are more sensitive, it should be noted that the methodology for SoS evaluation is very simple, low cost and does not need expensive equipment. Moreover, this biomarker has a clear dose-response relationship and shows a typical decreasing trend that lends itself to easy toxicological interpretation; although some hormetic effects at minimal toxicant concentrations were reported by Eertman et al. (1995⁴⁴³).

77. In line with above elaborated, under the Technical Note, the Monitoring Guidelines for Biomarker Analysis of Marine Molluscs (such as *Mytilus sp.*) and Fish (such as *Mullus barbatus*) for IMAP Common Indicator 18 provides the Protocol for the evaluation of SoS and for the interpretation of the results.

4.1 Protocol for the evaluation of SoS and interpretation of the results

a. Equipment

78. For optimal application of this Protocol the following equipment is needed: Thermostatic bag; Aquarium or laboratory or incubator chamber at controlled temperature.

b. Field sampling

79. The mussels may be caged for 30 days in the different field sites or collected from wild populations; in both cases, the sampled animals should be submerged and with a shell size of about 4-5 cm. It is important to stress that, in the case of wild animals sampled from different areas, the size of the molluscs has to be similar. It is necessary to take into account that younger animals (smaller mussels) have a longer survival time in air. Moreover, during the sampling procedure, water temperature, salinity and dissolved oxygen at the sampling site should be recorded. During mussel collection, byssal threads need to be cut with scissors in order to reduce the injury to the animals.

Some additional information can be useful when wild mussels are being used, such as the evaluation of the Condition Index (Crosby and Gale, 1990⁴⁴⁴; Mann, 1992⁴⁴⁵), and the degree of gonadal maturation (Bayne, 2009). In general mussels should be sampled out of the spawning period: indeed, just after the spawning, the animals are stressed and show a lower time of survival in air.

80. The sampled mussels should be rapidly transferred in a thermal insulated container with cotton towelling soaked with marine water to maintain an adequate humidity level. A temperature of about 4 °C should be maintained by using ice packs in the container.

c. Determination of SoS

81. Air exposure experiment: In the laboratory at least 10 x 4 animals from each site are subjected to anoxia by air exposure at 18 °C in humidified chambers. Mussels are placed over a moistened filter paper to guarantee the correct humidity level (the additional stressor should be the air exposure and not the water loss of the animals). Survival is assessed daily. Death symptoms are considered to be open valves and absence of muscular activity (open valve squeezing does not restore valves closure). Dead animals are recorded until 100% mortality is reached.

d. Result evaluation

⁴⁴²Thomas, R.E., Harris, P.M., Rice, S.D., 1999. Survival in air of *Mytilus trossulus* following long-term exposure to spilled Exxon Valdez crude oil in Prince William sound. Comp. Biochem. Physiol. Part C 122, 147-152.

⁴⁴³Eertman, R.H.M., Groenink, C.L.F.M.G., Sandee, B., Hummel, H., 1995. Response of the blue mussel *Mytilus edulis* L. following exposure to PAHs or contaminated sediments. Mar. Environ. Res. 39, 169-173.

⁴⁴⁴Crosby, M.P., Gale, L.D., 1990. A Review and Evaluation of Bivalve Condition Index Methodologies with a Suggested Standard Method. J. Shellfish Res. 9, 233-237.

⁴⁴⁵Mann, R., 1992. A comparison of methods for calculating condition index in eastern oysters *Crassostrea virginica* (Gmelin, 1791). VIMS Articles. 720.

82. The table reported below shows a typical mortality recording sheet for every 10 animals exposed to air for the LT₅₀ evaluation (LT = lethal time; LT₅₀ = number of days required to observe 50% mortality).

SoS: date of experiment (xx/yy/zz), Site, Site code, Sampling date

Environmental data: Water salinity (‰), Temperature (°C), pH, O₂ (mg/L).

Date	Day	Dead	Alive	% Alive
xx/yy/zz	0	0	10	100
xx/yy/zz	1	0	10	100
xx/yy/zz	2	1	9	90
xx/yy/zz	3	0	9	90
xx/yy/zz	etc.	etc.	etc.	etc.
xx/yy/zz	16	10	0	0

83. Data analysis

LT₅₀ values are used to evaluate the statistical differences between controls and animals from sites at different pollution levels. Survival curves and LT₅₀ values can be estimated using the Kaplan-Meier method (Kaplan and Meier, 1958⁴⁴⁶) and the Spearman-Kärber test (Hamilton et al., 1977⁴⁴⁷). At the end of the analysis, the results of the evaluation of the SoS must be listed in an additional page of the Biomarker Analysis Register (indicating also the data of the analysis and the name of the researchers involved).

e. Interpretation of the results

84. The indications for data interpretation related to SoS, considering related BAC and EAC values as established in Decision IG. 23/6 on 2017 Mediterranean Quality Status Report in line with the ICES Cooperative Research Report No. 315.277pp are as follows: LT₅₀ (days) – BAC 10 and EAC 5. SoS values higher than 10 days indicate healthy molluscs; values between 5 and 10 days indicate stressed animals; values lower than 5 days highlight mussels highly stressed in a pathological situation.

85. The analysis of the data reported by different authors such as Smaal et al. 1991⁴⁴⁸ and Viarengo et al. (1995) indicate LT₅₀ of 7.5 - 8 days. Recent data published in the literature on SoS found values of SoS ranging between 6 and 8 days in resident mussels (17°C ambient water) with concentrations of CBs, p-p-DDEs, Chrysene, Hg and Pb above BACs in their tissues (Martínez-Gómez et al., 2017⁴⁴⁹). The discrepancies noticed in the literature data emphasize the importance of an intercalibration activity in the framework of the QA programme in order to establish correct BAC and EAC values for SoS in the Mediterranean Sea. The data that will be collected through implementation of IMAP CI 18 will support establishing the correct SoS BAC and EAC for the Mediterranean area.

⁴⁴⁶ Kaplan, E. L., Meier, P., 1958. Nonparametric estimation from incomplete observations. *J. Am. Stat. Ass.* 53, 457-481.

⁴⁴⁷ Hamilton, M.A., Russo, R.C., Thuston, R.V., 1977. Trimmed Spearman-Kärber method for estimating median lethal concentrations in toxicity bioassays. *Environ. Sci. Technol.* 11, 714-719.

⁴⁴⁸ Smaal A.C., Wagenvoort, A., Hemelraad, J., Akkerman, I., 1991. Response to stress of mussels (*Mytilus edulis*) exposed in Dutch tidal waters. *Comp. Biochem. Physiol. C.* 100, 197-200.

⁴⁴⁹ Martínez-Gómez, C., Fernández, B., Robinson, C. D., Campillo, J. A., León, V. M., Benedicto, J., ... & Vethaak, A. D. (2017). Assessing environmental quality status by integrating chemical and biological effect data: The Cartagena coastal zone as a case. *Marine Environ. Res.*, 124, 106-117.

Presently, the correct interpretation of data related to SoS should be based on comparing the field data with the results of SoS obtained in mussels sampled in a reference coastal area.

f. Confounding factors

86. The animals show different physiological status in the different seasons (UNEP/RAMOGGE, 1999; ICES, 2001; Moore et al., 2004; Viarengo et al., 2007a; OSPAR Commission, 2013). For this reason, the animals should be not sampled in the summer or in the winter, and always outside the spawning period: in fact, in these periods the mussels are often in a poor condition and show a reduced survival time in air. This fact clearly indicates that, when possible, the use of caged mussels represents the best solution to obtain standardized, more comparable and reproducible data.

87. It should be noted that younger animals (smaller size) have longer times of survival in air (Thomas et al., 1999). Finally, the temperature value of the chamber for the SoS experiments should be routinely checked: lower temperatures in the chamber (together with the temperature of the sea water at the sampling site, as mentioned above) allow the molluscs to survive in air for longer periods of time (Thomas et al., 1999).

Reporting data

88. The unit for the agreed toxicological test SoS under IMAP CI18 in bivalve molluscs such as mussel is: LT_{50} (days).

References

- Al-Sabti, K., Metcalfe, C.D., 1995. Fish micronuclei for assessing genotoxicity in water. *Mutat. Res.* 343, 121-135.
- Barsiene, J., Lazutka, J., Syvokiene, J., Dedonyte, V., Rybakovas, A., Bagdonas, E., Bjornstad, A., Andersen, O.K., 2004. Analysis of micronuclei in blue mussels and fish from the Baltic and North Seas. *Environ. Toxicol.* 19, 365-371.
- Barsiene, J., Schiedek, D., Rybakovas, A., Syvokiene, J., Kopecka, J., Forlin, L., 2006. Cytogenetic and cytotoxic effects in gill cells of the blue mussel *Mytilus* spp. from different zones of the Baltic Sea. *Mar. Pollut. Bull.* 53, 469-478.
- Bayne, B.L., 1986. In: *The Role of the Oceans as a Waste Disposal Option*, ed. G. Kulleberg. Riedel, NY, pp. 617-634.
- Bayne, B.L., 2009. *Marine Mussels: Their Ecology and Physiology*. Cambridge University Press 528 p.
- Bocquené, G., Galgani, F. 1998. Biological effects of contaminants: Cholinesterase inhibition by organophosphate and carbamate compounds. *ICES Techniques in Marine Environmental Sciences*, No. 22.
- Bocquené, G., Galgani, F., Burgeot, T., Le Dean, L., Truquet, P., 1993. Acetylcholinesterase levels in marine organisms along French coasts. *Mar. Poll. Bull.* 26, 101-106.
- Bolognesi, C., Cirillo, S., 2014. Genotoxicity biomarkers in aquatic bioindicators. *Zoology* 60, 273-284.
- Bolognesi, C., Fenech, M., 2012. Mussel micronucleus cytome assay, *Nat. Protoc.* 17, 1125-1137.
- Bolognesi, C., Hayashi, M., 2011. Micronucleus assay in aquatic animals. *Mutagenesis* 26, 205-213.
- Bolognesi, C., Perrone, E., Roggeri, P., Sciutto, A., 2006. Bioindicators in monitoring long term genotoxic impact of oil spill: Haven case study. *Mar. Environ. Res.* 62, S287-S291.
- Bradford, M M, 1976. A Rapid and Sensitive Method for the Quantitation of Microgram Quantities of Protein Utilizing the Principle of Protein-Dye Binding. *Anal. Biochem.* 72, 248-254.
- Burgeot, T., Bocquené, G., Porte, C., Pfol Leszkowicz, A., Santella, R. M., Raoux, C., Dimeet, J., et al. 1996. Bioindicators of pollutant exposure in the northwestern part of the Mediterranean Sea. *Mar. Ecol. Prog. Ser.* 131, 125-141.
- Burgeot, T., Bocquené, G., His, E., Vincent, F., Geffard, O., Beira, R., et al., 2001. Monitoring of biological effects of pollutants: field application. In: Garrigues Ph., Barth, H., Walker, C.H., Narbonne, J.F., editors. *Biomarkers in marine organisms: a practical approach*. Amsterdam: Elsevier, pp. 179-213.
- CAS-Chemical Abstracts Service, 2020. Specialized substance collections count: CHEMLIST®. Chemical Abstracts Service. American Chemical Society. (Available at <https://www.cas.org/support/documentation/regulated-chemicals>, accessed 31 August 2020).
- Crosby, M.P., Gale, L. D., 1990. A Review and Evaluation of Bivalve Condition Index Methodologies with a Suggested Standard Method. *J. Shellfish Res.* 9, 233-237.
- Dailianis, S., Domouhsidou, G.P., Raftopoulou, E., Kaloyianni, M., Dimitriadis, V.K., 2003. Evaluation of neutral red retention assay, micronucleus test, acetylcholinesterase activity and a signal molecule (cAMP) in tissues of *Mytilus galloprovincialis* (L.), in pollution monitoring. *Marine Environmental Research* 56, 443-470.
- Davies, I.M.; Vethaak, D. (Ed.) (2012). *Integrated marine environmental monitoring of chemicals and their effects*. ICES Cooperative Research Report, 315. ICES: Copenhagen. ISBN 978-87-7482-120-5. 277 pp. Part of: ICES Cooperative Research Report. ICES: Copenhagen. ISSN 1017-6195.
- De Zwaan, A., Zandee D.I., 1972. The utilization of glycogen and accumulation of some intermediates during anaerobiosis in *Mytilus edulis* L. *Comp. Biochem. Physiol. Part B* 43, 47-54.

Decision IG.23/6 2017 Mediterranean Quality Status Report.

- Eertman, R.H.M., Wagenvoort, A.J., Hummel, H., Smaal, A.C., 1993. "Survival in air" of the blue mussel *Mytilus edulis* L. as a sensitive response to pollution-induced environmental stress. J. Exp. Mar. Biol. Ecol. 170, 179-195.
- Eertman, R.H.M., Groenink, C.L.F.M.G., Sandee, B., Hummel, H., 1995. Response of the blue mussel *Mytilus edulis* L. following exposure to PAHs or contaminated sediments. Mar. Environ. Res. 39, 169-173.
- Ellman, G.L., Courtney, K.D., Andres, V. Jr, Feather-Stone, R.M., 1961. A new and rapid colorimetric determination of acetylcholinesterase activity. Biochem Pharmacol. 7, 88-95.
- Escartín, E., Porte, C., 1997. The use of cholinesterase and carboxylesterase activities from *Mytilus galloprovincialis* in pollution monitoring. Environ. Toxicol. Chem. 16, 2090-2095.
- Galgani F., Bocquené G., Cadiou, Y., 1992. Evidence of variation in cholinesterase activity in fish along a pollution gradient in the North Sea. Mar. ecol. Prog. Ser. 91, 1-3).
- Galloway, T.S., Millward, N., Browne, M.A., Depledge, M.H., 2002. Rapid assessment of organophosphorous/carbamate exposure in the bivalve mollusc *Mytilus edulis* using combined esterase activities as biomarkers. Aquat Toxicol. 61, 169-180.
- Hamilton, M.A., Russo, R.C., Thuston, R.V., 1977. Trimmed Spearman-Kärber method for estimating median lethal concentrations in toxicity bioassays. Environ. Sci. Technol. 11, 714-719.
- Hayashi, M., Ueda, T., Uyeno, K. et al., 1998. Development of genotoxicity assay systems that use aquatic organisms. Mutat. Res. 399, 125-133.
- Hogan, J.W., 1970. Water temperature as a source of variation in specific activity of brain acetylcholinesterase of bluegills. Bull. Environ. Contam. Toxicol. 5, 347-353.
- Kankaanpää, H., Leiniö, S., Olin, M., Sjövall, O., Meriluoto, J., Lehtonen, K. K., 2007. Accumulation and depuration of cyanobacterial toxin nodularin and biomarker responses in the mussel *Mytilus edulis*. Chemosphere 68, 1210-1217.
- Kaplan, E. L., Meier, P., 1958. Nonparametric estimation from incomplete observations. J. Am. Stat. Ass. 53, 457-481.
- Leiniö, S. and Lehtonen, K. K. 2005. Seasonal variability in biomarkers in the bivalves *Mytilus edulis* and *Macoma balthica* from the northern Baltic Sea. Comp. Biochem. Physiol. C 140, 408-421.
- Majone, F., Brunetti, R., Gola, I., Levis, A.G., 1987. Persistence of micronuclei in the marine mussel, *Mytilus galloprovincialis*, after treatment with mitomycin C. Mutat. Res. 191, 157-161.
- Mann, R., 1992. A comparison of methods for calculating condition index in eastern oysters *Crassostrea virginica* (Gmelin, 1791). VIMS Articles. 720.
- Marcheselli, M., Azzoni, P., Mauri, M., 2011. Novel antifouling agent-zinc pyrithione: Stress induction and genotoxicity to the marine mussel *Mytilus galloprovincialis*. Aquat. Toxicol. 102, 39-47.
- Martínez-Gómez, C., Fernández, B., Robinson, C. D., Campillo, J. A., León, V. M., Benedicto, J., ... & Vethaak, A. D. (2017). Assessing environmental quality status by integrating chemical and biological effect data: The Cartagena coastal zone as a case. Marine Environ. Res., 124, 106-117.
- Moore, M.N., Lowe, D. and Köhler, A. 2004. Biological effects of contaminants: Measurement of lysosomal membrane stability. ICES Techniques in Marine Environmental Sciences. No. 36. 39 pp.
- OSPAR Commission, 2013. Background document and technical annexes for biological effects monitoring, Update 2013. 239 pp.
- Rickwood, C.J., Galloway, T.S., 2004. Acetylcholinesterase inhibition as a biomarker of adverse effect. A study of *Mytilus edulis* exposed to the priority pollutant chlorfenvinphos. Aquat Toxicol. 67, 45-56.

- Smaal, A.C., Wagenvoort, A., Hemelraad, J., Akkerman, I., 1991. Response to stress of mussels (*Mytilus edulis*) exposed in Dutch tidal waters. *Comp. Biochem. Physiol. C*. 100, 197-200.
- Solé, M., Baena, M., Arnau, S., Carrasson, M., Maynou, F., Cartes, J.E., 2010. Muscular cholinesterase activities and lipid peroxidation levels as biomarkers in several Mediterranean marine fish species and their relationship with ecological variables. *Environ. Int.* 36, 202-211.
- Speigel, M.R., 1961. *Statistics*. Schaum's Outline Series. Mc Graw-Hill Book Company, 359 p.
- Thain, J., Fernández, B., Martínez-Gómez, C., 2019. Biological effects of contaminants: Stress on stress (SoS) response in mussels. *ICES Techniques in Marine Environmental Sciences*. No. 59. 11 pp.
- Thomas, R.E., Harris, P.M., Rice, S.D., 1999. Survival in air of *Mytilus trossulus* following long-term exposure to spilled Exxon Valdez crude oil in Prince William sound. *Comp. Biochem. Physiol. Part C* 122, 147-152.
- UNEP/MED WG.467/5, 2019. IMAP Guidance Factsheets: Update for Common Indicators 13, 14, 17, 18, 20 and 21; New proposal for Candidate Indicators 26 and 27.
- Viarengo, A., Canesi, L., Pertica, M., Mancinelli, G., Accomando, R., Smaal, A.C., Orunesu, M., 1995. Stress on Stress Response: A Simple Monitoring Tool in the Assessment of a General Stress Syndrome in Mussels. *Mar Environ Res* 39, 245-248.
- Viarengo, A.; Lafaurie, M.; Gabrielides, G.P.; Fabbri, R.; Marro, A.; Roméo, M., 2000. Critical evaluation of an intercalibration exercise undertaken in the framework of the MED POL biomonitoring program. *Mar. Environ. Res.* 49, 1-18.
- Viarengo, A., Lowe, D., Bolognesi, C., Fabbri, E., Koehler, A., 2007a. The use of biomarkers in biomonitoring: a 2-tier approach assessing the level of pollutant-induced stress syndrome in sentinel organisms. *Comp. Biochem. Physiol. C* 146, 281-300.
- Viarengo, A., Dondero, F., Pampanin, D.M., Fabbri, R., Poggi, E., Malizia, M., Bolognesi, C., Perrone, E., Gollo, E., Cossa, G.P., 2007b. A biomonitoring study assessing the residual biological effects of pollution caused by the HAVEN wreck on marine organisms in the Ligurian Sea (Italy). *Arch Environ Contam Toxicol.* 53, 607-616.

Appendix 25

**Monitoring Guidelines/Protocols for Sampling and Sample Preservation of Sea Food for IMAP
Common Indicator 20: Heavy and Trace Elements and Organic Contaminants**

1. Introduction

1. Monitoring seafood (fish, bivalves, cephalopods and crustaceans) for compliance with levels of contaminants set for public health protection is very different from monitoring marine organisms for environmental purposes. Ongoing seafood monitoring programmes for public health reasons generally focus on estimating consumer exposure rather than assessing environmental status. Therefore, in the framework of UNEP/MAP Integrated Monitoring and Assessment Programme Common Indicator 20(CI20), as well as for the Descriptor 9 of the Marine Strategy Framework Directive (MSFD), sampling plans and procedures, selected tissues analysis and traceability to the location of catching or harvesting of seafood should be redesigned in order to provide required information (JRC, 2010⁴⁵⁰).

2. Sampling of seafood includes collection of organisms from fishing vessels but also from fish landing harbors and fish markets. This is an important difference from CI17 and CI18 sampling, where sampling site's geographical coordinates are precisely known and recorded. The sampling location of seafood on land is not enough to trace the organism's provenance and it is therefore of paramount importance to also record the original location of the collection of the organisms at sea. The list of seafood to be collected for CI20 extends beyond the sentinel organisms used for CI17 and CI18 (*Mullus barbatus* and *Mytilus galloprovincialis* or *Donax trunculus*). Therefore, each Contracting Party to the Barcelona Convention needs to select the organisms to be sampled and analyzed, based on the commercial importance of species in each country. However, in order to attempt providing a comparison between CI20 and CIs 17 and 18, it is advisable to include the above mentioned sentinel species in the monitoring programme for CI20.

3. Sample preservation during transportation to the laboratory for further analysis follows the same procedures described in the relevant Protocols of CI17, with the addition of guidelines for the preservation during transport of cephalopods and crustaceans. In all procedures the important element is to ensure the integrity of the initial sample, avoiding decay and cross contamination during transport. Ice preservation is suggested for a transport of less than 24 hours, while refrigeration (-20 °C) is the method to follow in case of a transportation period more than 24 hours. Also, sample container's materials should be adequate in order to avoid cross contamination of the samples by metals or organic contaminants.

4. The aim of monitoring for CI20 is the protection of consumers' health, therefore during dissection, only edible tissues of seafood are to be selected for analysis (the flesh of fish, the whole body of bivalves, the mantle and tentacles of cephalopods and the tail meat without the cehalothorax of crustaceans). Dissection should be carried out by trained personnel in clean conditions and using appropriate tools in order to avoid cross contamination during the process.

5. The Protocols prepared in the framework of Monitoring Guidance for Sampling and Sample Preservation of Sea Food for IMAP Common Indicator 20, as provided here-below, describe appropriate methodologies for sampling, processing and storage of seafood samples under controlled conditions to ensure the representativeness and the integrity of the biota samples. They are not intended to be analytical training manuals, but guidelines for Mediterranean laboratories, which should be tested and modified in order to validate their final results.

6. These Protocols aim at streamlining sampling, dissecting and processing of marine organisms in view of assuring comparable quality assurance of the data, as well as comparability between sampling areas and different national monitoring programmes. They provide a step-by-step guidance on the methods to be applied in the Mediterranean area for sampling, sample handling to avoid cross-

⁴⁵⁰ JRC (2010). Marine Strategy Framework Directive. Technical Report of Task Group 9: Contaminants in fish and other seafood

contamination, as well as the storage conditions in a view of maintaining the sample's integrity during the transfer from the sampling site to the analytical laboratory to ensure the representativeness and the integrity of the samples for analysis. Furthermore, protocols provide guidance on the procedures to dissect the organisms (fish, bivalves, crustaceans and cephalopods) in order to collect the appropriate tissue for analysis, taking care to avoid cross-contamination by metals or organic contaminants, depending on the foreseen analysis.

7. In order to avoid unnecessary repetitions, reference is also made to the protocols already published and publicly accessible, which can also be used by the Contracting Parties' competent laboratories participating in IMAP implementation. Namely, the here-below elaborated IMAP Protocols build upon previous UNEP/MAP - IAEA Recommended Methods, such as Reference Methods No 6 on sampling of selected marine organisms and sample preparation for trace metal analysis (UNEP/FAO/IOC/IAEA, (1987⁴⁵¹), (Annex VI) and Reference Methods No 7 (Rev. 2) on sampling and dissecting marine organisms (UNEP/FAO/IOC/IAEA, (1988⁴⁵²) (Annex VII), which were prepared in the framework of the MED POL monitoring programme. They are also streamlined with similar Guidelines for marine biota sampling, sample processing and preservation, which were developed by other Regional Seas Organisations, as follows: HELCOM (2012, Annex VII: Technical note on biological material sampling and sample handling for the analysis of persistent organic pollutants and metallic trace elements); EC relevant Regulations on marine biota sampling and sample preparation for seafood analysis (Annex II: EU Commission Regulation (EC) No 1881/2006⁴⁵³; Annex III: EU Commission Regulation (EC) No 333/2007⁴⁵⁴; Annex IV: EU Commission Regulation (EC) No 836/2011 amending (EC) No 333/2007⁴⁵⁵ laying down the methods of sampling and analysis for the official control of the levels of lead, cadmium, mercury, inorganic tin, 3-MCPD and benzo(a)pyrene in foodstuffs; Annex V: EU Commission Regulation (EC) No 644/2017⁴⁵⁶). Given the suitability of any of these Guidelines in the context of IMAP, they could be further used by interested IMAP competent Mediterranean laboratories for developing their laboratory specific sampling and sample processing methodologies. The Contracting Parties' laboratories should accommodate and always test and modify each step of the procedures to validate their results.

8. The below flow diagram informs on the category of this Monitoring Guideline related to sampling and sample preservation of sea food for IMAP Common Indicator 20 within the structure of all Monitoring Guidelines prepared for IMAP Common Indicators 13, 14, 17, 18 and 20.

⁴⁵¹ UNEP/FAO/IOC/IAEA (1987). Reference methods No 6 (Rev. 1): Guidelines for monitoring chemical contaminants in marine organisms.

⁴⁵² UNEP/FAO/IOC/IAEA (1988). Reference methods No 7 (Rev. 2): Sampling of selected marine organisms and sample preparation for trace metal analysis

⁴⁵³ EU Commission Regulation (EC) No 1881/2006, setting maximum levels for certain contaminants in seafood (Annex II)

⁴⁵⁴ EU Commission Regulation (EC) No 333/2007, laying down the methods of sampling and analysis for the official control of the levels of lead, cadmium, mercury, inorganic tin, 3-MCPD and benzo(a)pyrene in foodstuffs

⁴⁵⁵ EU Commission Regulation (EC) No 836/2011 amending (EC) No 333/2007 laying down the methods of sampling and analysis for the official control of the levels of lead, cadmium, mercury, inorganic tin, 3-MCPD and benzo(a)pyrene in foodstuffs

⁴⁵⁶ EU Commission Regulation (EC) No 644/2017, laying down methods of sampling and analysis for the official control of levels of dioxins and dioxin-like PCBs in certain foodstuffs

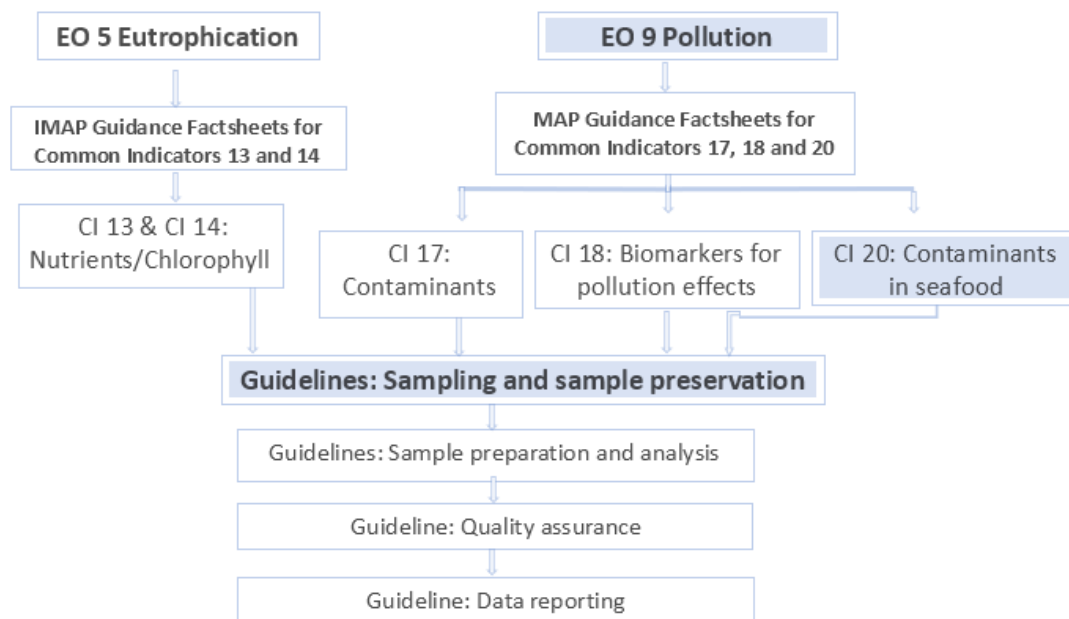

Flow Diagram: Monitoring Guidelines for IMAP Ecological Objectives 5 and 9

2. Technical note for the sampling of seafood for the analysis of heavy metals and organic contaminants

9. Monitoring seafood (fish, bivalves, cephalopods and crustaceans) for compliance with levels of contaminants set for public health protection is very different from monitoring of marine biota for assessing the quality of the marine environment. Also, ongoing seafood monitoring programmes for the purpose of public health protection generally focus on estimating consumer exposure rather than assessing environmental status. Therefore, in the framework of UNEP/MAP IMAP CI20, as well as for the Descriptor 9 of the MSFD, sampling plans and procedures, selected tissues analysis and traceability to the location of catching or harvesting of seafood should be redesigned in order to provide required information (JRC, 2010).

10. Under this Technical note on sampling of seafood for the analysis of heavy metals and organic contaminants, this Guidelines provides the Protocol for the collection of fish, crustaceans, cephalopods and bivalves for heavy metal and organic contaminants analysis.

2.1 Protocol for the collection of fish, crustaceans, cephalopods and bivalves for heavy metal and organic contaminants analysis

11. According to IMAP (UNEP, 2019a⁴⁵⁷, UNEP, 2019b⁴⁵⁸) it is proposed “to collect marine organisms mainly commercial species, and similarly to CI17 (where the whole soft tissues or dissected parts are processed to perform analytical measurements of chemical contaminants)”. It also underlined that “The sample collection for CI20 could be easily integrated with CI17 in terms of sample monitoring (e.g. from dedicated fishing vessels or from artisanal fleets at port). To be noticed, that in any case, the origin (i.e. area) of the fish captures should be exactly known, including detailed field

⁴⁵⁷ UNEP/MAP (2019a). UNEP/MED WG.467/5. IMAP Guidance Factsheets: Update for Common Indicators 13, 14, 17, 18, 20 and 21: New proposal for candidate indicators 26 and 27.;

⁴⁵⁸ UNEP (2019b). UNEP/MED WG.463/6. Monitoring Protocols for IMAP Common Indicators related to pollution;

information (e.g. coordinates)” (UNEP 2019b). Therefore, the FAO fishing area code (origFishAreaCode) should be noted and included in the Reporting Template for CI20.

12. The sample species for such analysis depends on the commercial marine organisms that are captured in the different Mediterranean areas (locations). Therefore, it is not relevant to propose a specific list of species but rather each Contracting Party will have to define its own list, which may be different from one sub-region to another. A tentative list of commercial species in the Mediterranean basin was prepared by JRC (2010) and is presented in Annex I⁴⁵⁹. Also, a list of available reference species (Code list) for Data Dictionaries and Data Standards related to E09 (CI17 and CI20) within the IMAP (Pilot) Info System is provided in UNEP/MED WG.467/8 (UNEP, 2019b⁴⁶⁰). In order to make monitoring results more comparable between Mediterranean (sub) regions, the Contracting Parties could select a relatively limited number of common target species from the most consumed species of fish and other seafood in the Mediterranean basin, to be monitored during the initial implementation phase of the IMAP programme. It is therefore reasonable to include species that are sampled for biomarkers and general contaminants (such as *Mullus barbatus* and bivalves – *Mytilus galloprovincialis*) in biota analysis as additional information will exist.

13. Ongoing monitoring programmes aiming at the protection of human health, often rely on retail sampling, at the market. However, in order to use these results for the purpose of CI20 monitoring, the recording of the exact location of seafood harvesting is of paramount importance. JRC (2010) underlines that “Traceability in the food chain is focused on risk management: unless specific provisions for further traceability exist, the requirement for traceability is limited to ensuring that food business operators are at least able to identify the immediate supplier of the product in question and the immediate subsequent recipient, with the exemption of retailers to final consumers (“one step back – one step forward”).” The aim of traceability is to make sure that a direct link is established between the fresh seafood and the specific regions of its capture, in as much detail as possible.

14. Furthermore, since seafood samples for the protection of human health are often collected at the market, it must be ensured that measured contaminants concentrations in seafood are directly related to the existing environmental conditions at the capture location and that they are not cross-contaminated during treatment, transport and storage. A close cooperation between the samples’ providers at the market and the authorities responsible for sampling seafood should be established in order to minimize such cross-contamination.

15. For contaminants for which regulatory levels have been set provisions regarding sampling procedures are presented in Commission Regulations: (EC) No 1881/2006 related to setting maximum levels of contaminants in foodstuffs, (Annex II), which was amended by (EC) No 835/2011⁴⁶¹ in relation to PAHs maximum levels; (EC) No 333/2007 related to sampling and analysis for lead, cadmium, mercury, inorganic tin, 3-MCPD and benzo(a)pyrene in foodstuffs, (Annex III.), which was amended by (EC) No 386/2011⁴⁶² in relation to PAHs methods for sampling and analysis (Annex IV); (EC) No 644/2017 related to sampling and analysis for dioxins and dioxin-like PCBs in foodstuffs; (Annex V). .. These Regulations, which include sampling plans, sample preparation and analysis may

⁴⁵⁹ Annex I: Indicative Tables of most consumed species of fish and seafood for different (sub) regions. JRC Technical Report 2010.

⁴⁶⁰ UNEP (2019b) UNEP/MED WG.467/8. Data Standards and Data Dictionaries for Common Indicators related to pollution and marine litter.

⁴⁶¹ Commission Regulation (EU) No 835/2011 amending Regulation (EC) No 1881/2006 as regards maximum levels for polycyclic aromatic hydrocarbons in foodstuffs.

⁴⁶² Commission Regulation (EU) No 386/2011 amending Regulation (EC) No 333/2006 laying down the methods of sampling and analysis for the official control of the levels of lead, cadmium, mercury, inorganic tin, 3-MCPD and benzo(a)pyrene in foodstuffs.

be used as a guidance for seafood sampling and analysis of relevance for UNEP/MAP IMAP mandatory list of contaminants (UNEP/MAP, 2019a), for which regulatory concentrations in seafood have been set by EC. From the list of EC regulated contaminants (EC) No 1881/2006) and (EC) 835/2011, Cd, Hg, Pb, PAHs (Benzo(a)Pyrene, benz(a)anthracene, benzo(b)fluoranthene and chrysene) and non dioxine-like PCBs are also designated as mandatory contaminants for CI20 monitoring (IMAP Guidance Fact Sheets, UNEP, 2019). Dioxins and dioxin-like PCBs, which are included in the list of EC regulated contaminants for seafood monitoring, are not yet included in the list of IMAP mandatory contaminants for CI20, however the Contracting Parties are encouraged to include all EU regulated contaminants in their monitoring programme for CI20, if possible.

16. The number of individual organisms to be samples depends on the weight of the “lot” and “sublot”. According to the definitions of the Commission Regulations (EC) No 333/2007:

- i) “lot” is an identifiable quantity of food delivered at one time and determined by the official to have common characteristics, (such as origin, variety, and in the case of fish (or other biota), also a comparable size;
- ii) “sublot” is the designated part of a large lot in order to apply the sampling method on that designated part;
- iii) “incremental sample” is a quantity of material taken from a single place in the lot or sublot;
- iv) “aggregate sample” is the combined total of all the incremental samples taken from the lot or sublot; aggregate samples shall be considered as representative of the lots or sublots from which they are taken; sublot must be physically separated and identifiable.

17. Using these definitions, Regulations (EC) No 333/2007 and (EC) 836/2011 suggest the following sampling plans for individual marine organisms (fish, molluscs, cephalopods and crustaceans):

Table 1. Number of packages or units (incremental samples) which shall be taken to form the aggregate sample if the lot or sublot consists of individual packages or units

Number of packages or units in the lot/ sublot	Number of packages or units to be taken
≤ 25	at least 1 package or unit
26-100	about 5 %, at least 2 packages or units
> 100	about 5 %, at maximum 10 packages or units

18. The aggregate sample shall be at least 1 kg except where it is not possible e.g. when the sample consists of 1 package or unit.”

19. In relation to packaging and transport of samples, Regulation (EC) No 333/2007 underlines that “each sample shall be placed in a clean, inert container offering adequate protection from contamination, from loss of analytes by adsorption to the internal wall of the container and against damage in transit. All necessary precautions shall be taken to avoid any change in composition of the sample which might arise during transportation or storage.” Also, “Each sample taken for official use shall be sealed at the place of sampling and identified following the rules of the Member States. A record shall be kept of each sampling, permitting each lot or sublot to be identified unambiguously (reference to the lot number shall be given) and giving the date and place of sampling together with any additional information likely to be of assistance to the analyst.”

20. During marine organisms sampling it is important to take into consideration (and record) all biological factors that can influence concentrations of contaminants in fish and other seafood, such as seasonal variation, age, sex. Since the aim of the monitoring is the protection of human health, only the edible portion of the organisms will be analyzed.

21. Seafood samples should be protected from contamination, which may occur during sampling, sample handling, storage and transfer to the laboratory for further analysis. Seafood samples have to be handled with care to avoid any contact with metals (for heavy metal analysis) or possible sources of organic contaminants (for chlorinated hydrocarbons and PAHs analysis). When seafood transport to the laboratory is done in less than 24 hours, samples can be stored on ice. In case of a transfer longer than 24 hours, samples have to be frozen in -20 °C and transported frozen to the laboratory for further processing and analysis. Each sample should be labelled with the sample's identification number, the type of tissue, and the date and location of sampling.

22. Guidelines for marine organism collection, preservation and transportation to the laboratory are developed by UNEP/FAO/IOC/IAEA (1987) (Annex VI), UNEP/FAO/IOC/IAEA (1988) (Annex VII, HELCOM (2012) (Annex VIII) and US EPA (2000⁴⁶³) (Annex IX).

3. Technical Note for the dissection of seafood for the analysis of heavy metals and organic contaminants

23. To collect the edible tissues of seafood for subsequent analysis, the organisms have to be dissected, taking care to avoid any contamination from the dissecting tools and the working environment. Also, dissection has to be undertaken by trained personnel to ensure the removal of the representative undamaged tissues.

24. For metal analysis, the dissection of marine organisms should be made on a metal-free bench, using plastic knives and tweezers for holding tissues during dissection. After each sample has been prepared, all tools and equipment (such as homogenizers) should be cleaned with a tissue and rinsed with clean water.

25. For organic contaminants analysis, the dissection of marine organisms should be made on a metallic (stainless steel or aluminum) bench, using stainless steel knives and tweezers for holding tissues during dissection. After each sample has been prepared, all tools and equipment (such as homogenizers) should be cleaned with tissue and rinsed with solvent

26. After the removal of a tissue sample from the organism, the tools have to be cleaned before being used to remove another organ of the same individual or being used on a different individual

27. For analysis of heavy metals, tools should be:

- i) Washed in acetone or alcohol and high purity water.
- ii) Washed in HNO₃ diluted (1+1) with high purity water. Tweezers and haemostates in are washed in diluted (1+6) acid.
- iii) Rinsed with high purity water.

28. For analysis of organic contaminants, tools should be:

- i) Washed in acetone or alcohol and rinsed in high purity water.

⁴⁶³ US EPA (2000). Guidance for Assessing Chemical Contaminant Data for Use in Fish Advisories Volume 1 Fish Sampling and Analysis. Third Edition (Annex VIII)

29. The glass/metal/plastic plate used during dissection should be cleaned in the same manner. The tools must be stored dust-free when not in use. Also, the dissection room should be kept clean and the air should be free from particles. If clean benches are not available on board the ship, the dissection of fish should be carried out in the land-based laboratory under conditions of maximum protection against contamination (HELCOM, 2012).

30. Under this Technical note on sampling of seafood for the analysis of heavy metals and organic contaminants, this Guidelines provides the following four Protocols:

- Protocol for dissection of fish to collect the edible part for analysis;
- Protocol for dissection of bivalves to collect the edible part for analysis;
- Protocol for dissection of crustaceans to collect the edible part for analysis;
- Protocol for dissection of cephalopods to collect the edible part for analysis.

3.1 Protocol for dissection of fish to collect the edible part for analysis

Recording biological factors of fish

31. Guidelines for recording length, weight and sex of fish are presented in UNEP/FAO/IOC/IAEA (1987) (Annex VI), UNEP/FAO/IOC/IAEA (1988) (Annex VII), and US EPA (2000) (Annex IX).

Dissection of fish

32. Muscle tissues of fish have to be dissected while they are in good condition, otherwise the decay of the tissues will affect the concentration of contaminants. Therefore, it is preferable to dissect collected fish the soonest possible, by experienced personnel able to perform the dissection and remove the muscle tissue to be analyzed. Dissection should be done in a clean area free from possible contamination of the sample by metals (for heavy metal analysis) or organic contaminants (for PCBs and PAHs analysis).

33. According to IMAP requirements, UNEP (2019), the fish tissue to be collected is muscle. Detailed guidelines for the dissection of fish and collection of samples for further analysis is presented in UNEP/FAO/IOC/IAEA (1987) (Annex VI), UNEP/FAO/IOC/IAEA (1988) (Annex VII.), HELCOM (2012) (Annex VIII) and US EPA (2000) (Annex IX).

34. In all procedures, the method requires the removal of the epidermis and the collection of a sample from the dorso-lateral muscle in order to ensure uniformity of samples (Figure 1). It is also suggested to take the entire right dorsal lateral filet as a uniform sample, from which subsamples can be taken after homogenizing for replicate dry weight and contaminant determinations. If the amount of material obtained by this procedure is too large to be easily handled, a specific portion of the dorsal musculature should be chosen for the sample. It is recommended that the portion of the muscle lying directly under the first dorsal fin should be utilized in this case. It is important to obtain the same portion of the muscle tissue for each sample, because both fat and water content vary significantly in the muscle tissue from the anterior to the caudal muscle of the fish (HELCOM, 2012).

35. In case fish samples are frozen for their transfer from the field to the laboratory, they have to rest until thawed. It is often suggested that the dissection of fish is easiest when the material, at least the surface layers of the muscle tissue, is half frozen. However, for the dissection of other organs, the thawing must proceed further. Extreme care has to be demonstrated during dissection because any loss of liquid or fat due to improper cutting or handling of the tissue makes the determinations of dry weight and fat content less accurate, which is also affecting the accuracy of the reported contaminants' concentrations.

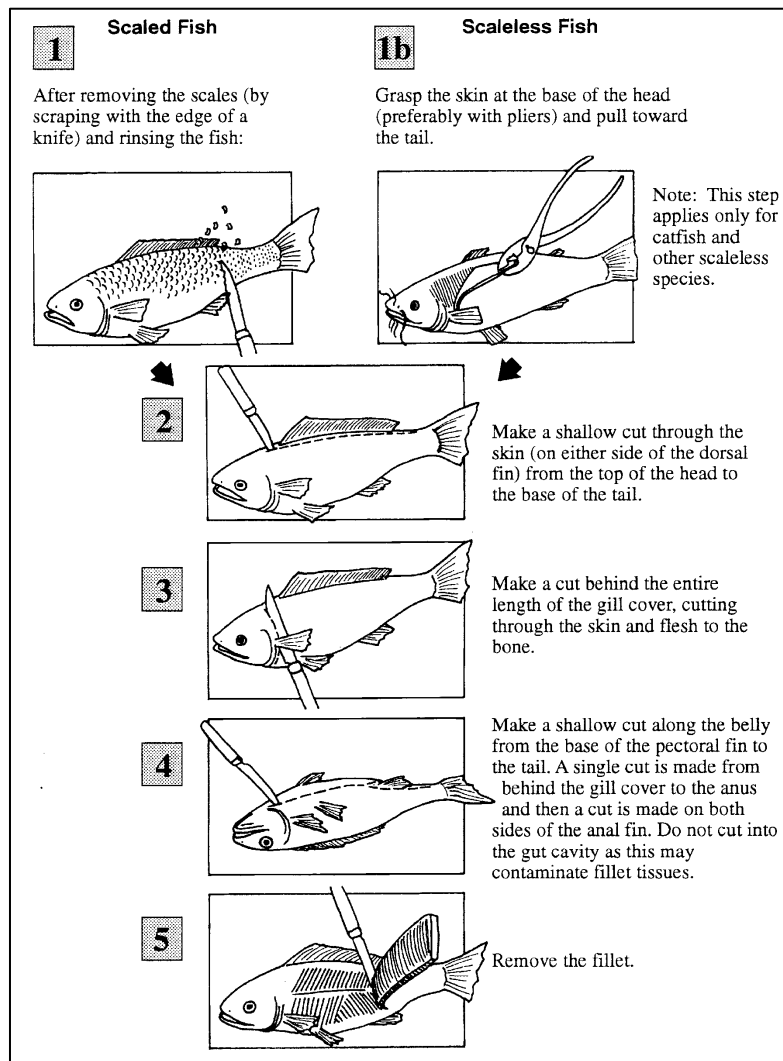

Figure 1. Fish filleting procedure (from US EPA, 2000)

3.2 Protocol for dissection of bivalves to collect the edible part for analysis (whole body)

Depuration

36. Collected bivalves that are alive should be left to void the gut contents and any associated contaminants before dissecting and sample preparation, because gut contents may contain significant quantities of contaminants associated with food and sediment particles which are not truly assimilated into the tissues of the mussels (HELCOM, 2012). Bivalve's depuration over a period of 24 hours is usually sufficient and should be undertaken under controlled conditions and in filtered sea water in the laboratory. The aquarium should be aerated and the temperature and salinity of the water should be similar to that from which the animals were removed.

Recording biological factors of bivalves

37. Guidelines for recording length and weight of bivalves are presented in UNEP/FAO/IOC/IAEA (1987) (Annex VI), UNEP/FAO/IOC/IAEA (1988) (Annex VII), and US EPA (2000) (Annex IX).

Bivalves' dissection

38. The whole soft tissue of bivalves is edible therefore, it has to be collected for analysis. Detailed guidelines for the dissection of bivalves and collection of samples for further analysis is

presented in UNEP/FAO/IOC/IAEA (1987) (Annex VI), UNEP/FAO/IOC/IAEA (1988) (Annex VII), HELCOM (2012) (Annex VIII) and US EPA (2000) (Annex IX).

39. In general, foreign materials attached to the outer surface of the shell have to be removed using a clean plastic/stainless steel knife with a strong plastic/metal brush. Handle the mussels as little as possible. For removing the soft tissue for analysis, bivalves should be shucked live and opened with minimal tissue damage by detaching the adductor muscles from the interior of at least one valve (Figure 2). The soft tissues should be removed and homogenized as soon as possible, frozen and kept in plastic containers (for metal analysis) or in metal containers (for organic contaminants' analysis) at -20°C until analysis. Homogenization can be done using stainless steel blades (for organic contaminants analysis) or using an agate mortar, following the drying of the sample.

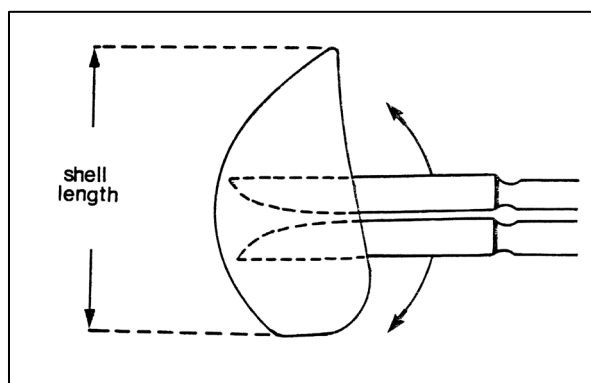

Figure 2. Cutting the abductor muscle

3.3 Protocol for dissection of crustaceans to collect the edible part for analysis

Recording biological factors of crustaceans

40. Guidelines for recording length, weight and sex of crustaceans are presented in UNEP/FAO/IOC/IAEA (1987) (Annex VI), UNEP/FAO/IOC/IAEA (1988) (Annex VII), and US EPA (2000) (Annex IX).

41. The length of the shrimp is measured from rostrum to uropod (Figure 3) using an appropriate length-measuring device. Weigh the shrimp after placing a clean weighing container (plastic or aluminum foil depending on the analysis to be made) on the balance and note its length and fresh weight.

Crustaceans' dissection

42. To collect the edible part of shrimps and crayfish the cephalothorax is removed and the tail meat with the section of intestine passing through the tail muscle is retained for analysis (Figure 3). The vein is then removed using a sharp knife. The edible tissue of lobsters typically includes the tail and claw meat. Guidelines for dissection of crustaceans are prepared by UNEP/FAO/IOC/IAEA (1987) (Annex VI), UNEP/FAO/IOC/IAEA (1988) (Annex VII), and US EPA (2000) (Annex IX).

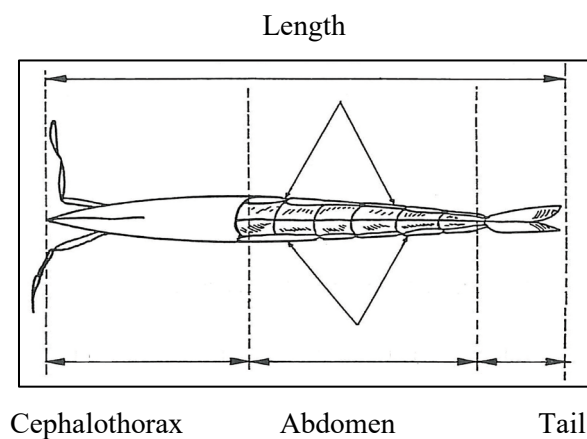

Figure 3. Shrimp

3.4 Protocol for dissection of cephalopods to collect the edible part for analysis (mantle and head)

Recording biological factors of cephalopods

43. For octopus and squid, total length is measured from end of longest arm to posterior end of mantle. Mantle length is measured from midpoint between eyes to the posterior end of mantle.

Dissection of cephalopods

44. The digestive gland and the internal organs (gills, ink sack, branchial hearts and their appendages, systemic heart and brain) of each cephalopod are totally removed using appropriate tools to avoid contamination. The edible parts of the cephalopod (mantle, head with tentacles) (Figure 4) are stored in clean containers for further analysis (Bustamante et al, 1998⁴⁶⁴).

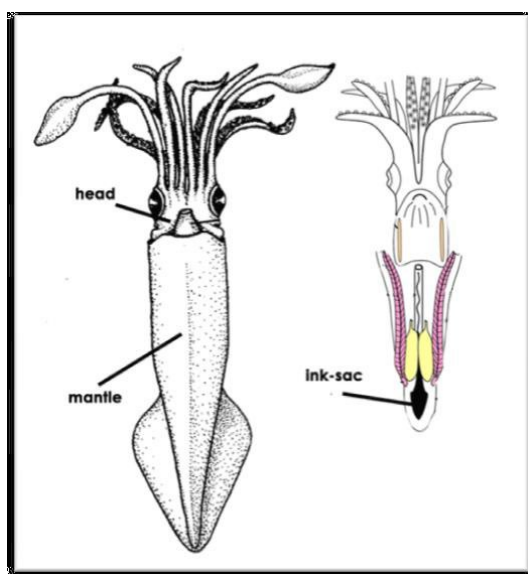

Figure 4. Squid

⁴⁶⁴ Bustamante P, Caurant F, Fowler SW, Miramand P. Cephalopods as a vector for the transfer of cadmium to top marine predators in the north-east Atlantic Ocean. *Sci. Total Environ.* 1998; 220: 71–80.

4. Technical note for the sample preservation of seafood for the analysis of heavy metals and organic contaminants

45. Under this Technical note on processing and preservation of marine biota for the analysis of heavy metals and organic contaminants, this Guidelines provides the following two Protocols:

- Protocol for the treatment of seafood samples prior to heavy metal analysis;
- Protocol for the treatment of biota samples prior to analysis for organic contaminants.

46. The Protocols under this Technical Note are similar to the relevant Protocols related to sampling and sample preservation of marine biota samples presented in the framework of CI17 Guideline for biota sampling and samples preservation, for the analysis of heavy metals and organic contaminants.

4.1 Protocol for the treatment of seafood samples prior to heavy metal analysis

47. For contaminants for which regulatory levels have been set, certain provisions regarding sampling procedures and sample preservation are presented in Commission Regulations (EC) No 333/2007 of the European Union (Annex III.). These methods could be used when determining levels of contaminants in fish and seafood for human consumption in view of monitoring Good Environmental Status of the marine environment. Guidelines for treatment of marine biota samples prior to analysis are proposed by UNEP/FAO/IOC/IAEA (1987) (Annex VI), UNEP/FAO/IOC/IAEA (1988) (Annex VII) and HELCOM (2012) (Annex VIII).

a) Storage of wet samples on board/market

48. Upon collection wet samples have to be stored in such a way as to preserve them from deterioration that will affect the subsequent analysis of contaminants. When the fish transport to the laboratory is done in less 24 hours, samples can be stored on ice. However, for longer periods, fish samples have to be frozen (-20 °C) and transported frozen to the laboratory for further processing. Each sample should be labelled with the sample's identification number, the type of tissue, and the date and location of sampling.

b) Drying of biota tissues

49. Drying biota tissues is a procedure to establish the wet/dry ratio of the tissues, in order to express metal concentrations accordingly enabling comparisons between different data sets. Dried biota tissues can then be digested for heavy metal analysis, although biota tissues can also be digested wet, without prior drying (HELCOM, 2012).

50. For metal (except volatile mercury) analysis, sediments freeze-drying is the preferable procedure. Alternatively, the biota tissues may be dried at any temperature below 105°C until constant weight. For mercury analysis, to minimise losses due to evaporation, a sediment sub sample could be air dried at temperature <50°C (EC, 2010). Frozen biota samples are placed in clean wide-mouth glass or plastic containers suitable for freeze-drying and are freeze-dried for 24 hours taking care to protect them from cross-contamination from particles and vapours. A possible way to protect samples from contamination is to cover the sample containers with a filter paper perforated with a small hole (HELCOM, 2012). Then the containers with the samples are weighted and freeze-dried again for another 24 hours and weighted. If the difference between the 2 weighing is less than 0.5%, drying is completed and the dw/ww ratio can be calculated. Otherwise the drying cycle can be repeated (24 hours) until the difference between successive weighing is less than 0.5%.

51. Freeze dried biota tissues are then grinded and homogenized using a metal-free ball mill. Guidelines for processing biota samples for metal analysis are provided by ICES/OSPAR (2018⁴⁶⁵) and HELCOM (2012) (Annex VII).

c) Storage of dried biota tissues

52. Freeze-dried tissue samples can be stored in pre-cleaned wide-mouth bottles with a screw cap. Samples intended for the analysis of metals can be stored in plastic or glass containers. For mercury analysis, samples must be stored in acid-washed borosilicate glass or quartz containers, as mercury can move through the walls of plastic containers (EC, 2010⁴⁶⁶).

53. Containers with biota tissue samples should be archived and kept in storage after the completion of the analysis, in order to be used as a replicate sample in case crosschecking of the results is required or additional determinations are needed in the future. Freeze-dried biota tissues remaining after analyses could be stored in the original sample bottle, closed with an airtight lid to protect against moisture and stored in a cool, dark place. Under these conditions, samples may be archived and stored for 10-15 years. (EC, 2010).

4.2 Protocol for the treatment of seafood samples prior to analysis for organic contaminants

54. For organic contaminants for which regulatory levels have been set, certain provisions regarding sampling procedures and sample preservation are presented in Commission Regulations (EC) No 333/2007 (PAHs) and (EC) No 644/2017 (PCBs and dioxins) of the European Union. (Annexes III. and IV.). These methods could be used when determining levels of contaminants in fish and seafood for human consumption in view of monitoring Good Environmental Status of the marine environment. Guidelines for treatment of marine biota samples prior to analysis are proposed by UNEP/FAO/IOC/IAEA (1987) (Annex VI), UNEP/FAO/IOC/IAEA (1988) (Annex VII.) and HELCOM (2012) (Annex VIII)

a) Storage of wet samples on board/market

55. Upon collection wet samples have to be stored in such a way as to preserve them from deterioration that will affect the subsequent analysis of contaminants. When the fish transport to the laboratory is done in less 24 hours, samples can be stored on ice. However, for longer periods, fish samples have to be frozen (-20 °C) and transported frozen to the laboratory for further processing. Each sample should be labelled with the sample's identification number, the type of tissue, and the date and location of sampling.

b) Drying of biota tissues

56. For organic contaminants analysis drying procedures depends on the compounds to be analysed. For chlorinated hydrocarbons sediments can be freeze-dried taking care to avoid determinant loss through evaporation by keeping the temperature in the evaporation chamber below 0°C (ICES/OSPAR, 2018). For PAH determination, freeze-drying sediment samples may be a source of contamination due to the back-streaming of oil vapours from the rotary vacuum pumps. Furthermore, drying the samples may result in losses of the lower molecular weight, more volatile PAHs through evaporation. To protect biota samples from cross-contamination from particles and vapours during freeze drying, the sample containers could be covered with a lid or filter paper perforated with a small hole (HELCOM, 2012).

⁴⁶⁵ ICES/OSPAR (2018). CEMP Guidelines for Monitoring Contaminants in Biota. Technical Annexes: 1) organic contaminants; 2) metals; 3) parent and alkylated PAHs; 8) chlorobiphenyls

⁴⁶⁶ EC (2010). Guidance Document No: 25 Guidance on chemical monitoring of sediment and biota under the Water Framework Directive

c) Storage of dried biota tissues

57. Freeze-dried tissue samples can be stored in pre-cleaned wide-mouth bottles with a screw cap. Samples intended for the analysis of organic contaminants should be stored in glass containers.

58. Containers with biota tissue samples should be archived and kept in storage after the completion of the analysis, in order to be used as a replicate sample in case crosschecking of the results are required or additional determinations are needed in the future. Freeze-dried biota tissues remaining after analyses could be stored in the original sample bottle, closed with an airtight lid to protect against moisture and stored in a cool, dark place. Under these conditions, samples may be archived and stored for 10-15 years (EC, 2010).

Appendix 25
Joint Research Centre Scientific and Technical Reports
MARINE STRATEGY FRAMEWORK DIRECTIVE
Task Group 9 Contaminants in fish and other seafood
APRIL 2010
ANNEX II: INDICATIVE TABLES OF MOST CONSUMED SPECIES OF FISH AND
SEAFOOD
FOR THE DIFFERENT (SUB) REGIONS

Joint Research Centre Scientific and Technical Reports

MARINE STRATEGY FRAMEWORK DIRECTIVE

Task Group 9 Contaminants in fish and other seafood

APRIL 2010

ANNEX II: INDICATIVE TABLES OF MOST CONSUMED SPECIES OF FISH AND SEAFOOD

FOR THE DIFFERENT (SUB) REGIONS

3. Region: Mediterranean Sea

3.1. Subregion: Western Mediterranean Sea

Common name	Scientific name	Importance
Sardine	<i>Sardina pilchardus</i>	+++
Horse Mackerel	<i>Trachurus trachurus</i>	+++
Hake	<i>Merluccius merluccius</i>	+++
Anchovy	<i>Engraulis encrasicolus</i>	+++
Blue Whiting	<i>Micromesistius poutassou</i>	++
Gilt sardine, Spanish sardine	<i>Sardinella aurita</i>	++
Mediterranean horse mackerel	<i>Trachurus mediterraneus</i>	++
Bullet tuna	<i>Auxis rochei</i>	++
Atlantic mackerel	<i>Scomber scombrus</i>	++
Swordfish	<i>Xiphias gladius</i>	++
Octopus	<i>Octopus vulgaris</i>	++
Mackerels	<i>Scomber spp</i>	++
Red shrimp	<i>Aristeus antennatus</i>	++
Atlantic blue fin tuna	<i>Thunnus thynnus</i>	++
Angler	<i>Lophius piscatorius</i>	++
Red mullet	<i>Mullus barbatus</i>	++
Mackerel	<i>Trachurus spp</i>	++
Gilthead sea bream	<i>Sparus aurata</i>	++
Menhaden	<i>Brevoortia pectinata</i>	+
Cuttlefish	<i>Sepia officinalis</i>	+
Atlantic saury	<i>Scorpaenopsis scorpaena</i>	+
Common Pandora	<i>Pagellus erythrinus</i>	+
Blackspot sea bream	<i>Pagellus bogaraveo</i>	+

Other seafood

Common name	Scientific name	Importance
Spot tail mantis shrimp	<i>Squilla mantis</i>	++
Mediterranean mussel	<i>Mytilus galloprovincialis</i>	++
Norway lobster	<i>Nephrops norvegicus</i>	+

3.2. Subregion: Adriatic Sea

Fish

Common name	Scientific name	Importance
European anchovy	<i>Engraulis encrasicolus</i>	+++
Hake	<i>Merluccius merluccius</i>	+++
European Squid	<i>Loligo vulgaris</i>	+++
Atlantic bonito	<i>Sarda sarda</i>	++
Horse mackerel	<i>Trachurus trachurus</i>	++
Red striped mullet	<i>Mullus surmuletus</i>	++
Atlantic mackerel	<i>Scomber scombrus</i>	++

Other seafood

Common name	Scientific name	Importance
Mediterranean mussel	<i>Mytilus galloprovincialis</i>	+++
Clams	<i>Ruditapes decussates/ philippinarum</i>	+++
Norway lobster	<i>Nephrops norvegicus</i>	++

3.3. Subregion: Ionian Sea and Central Mediterranean Sea

Fish

Common name	Scientific name	Importance
European anchovy	<i>Engraulis encrasicolus</i>	+++
Hake	<i>Merluccius merluccius</i>	+++
Atlantic blue fin tuna	<i>Thunnus thynnus</i>	+++
Atlantic bonito	<i>Sarda sarda</i>	++
Red striped mullet	<i>Mullus surmuletus</i>	++
Swordfish	<i>Xiphias gladius</i>	++
Bullet tuna	<i>Auxis rokei</i>	++
Sardine	<i>Sardina pilchardus</i>	+
Atlantic mackerel	<i>Scomber scombrus</i>	+
Horse mackerel	<i>Trachurus trachurus</i>	+

Other seafood

Common name	Scientific name	Importance
Deep-water rose shrimp	<i>Parapenaeus longirostris</i>	++
Norway lobster	<i>Nephrops norvegicus</i>	+

3.5. Subregion: Aegean-Levantine Sea

Fish

Common name	Scientific name	Importance
European anchovy	<i>Engraulis encrasicolus</i>	
Sardine	<i>Sardina pilchardus</i>	
Gilt sardine, Spanish sardine	<i>Sardinella spp</i>	
Cuttlefish	<i>Sepia officinalis</i>	
Bogue	<i>Boops boops</i>	
Octopus	<i>Octopus vulgaris</i>	
Chub mackerel	<i>Scomber japonicus</i>	
Mediterranean horse mackerel	<i>Trachurus mediterraneus</i>	
Hake	<i>Merluccius merluccius</i>	
Shad	<i>Alosa spp</i>	
Blue Whiting	<i>Micromesistius poutassou</i>	
Picarels	<i>Spicara spp</i>	
Goatfishes	<i>Mullus spp.</i>	
Horse mackerel	<i>Trachurus trachurus</i>	
Flathead Mullet (Striped Mullet)	<i>Mugil cephalus</i>	
Common sea bream	<i>Pagrus pagrus</i>	
Meagre, shade-fish, salmon bass or Stone Bass	<i>Argyrosomus regius</i>	
Gilthead sea bream	<i>Sparus aurata</i>	
Barracuda	<i>Sphyraena spp</i>	
European sea bass	<i>Dicentrarchus labrax</i>	
Grouper	<i>Epinephelus spp</i>	

Other seafood

Common name	Scientific name	Importance
Mediterranean mussel	<i>Mytilus galloprovincialis</i>	
Caramote prawn	<i>Penaeus kerathurus</i>	

Annex II:

Official Journal of the European Union

**COMMISSION REGULATION (EC) No 1881/2006
of 19 December 2006
setting maximum levels for certain contaminants in foodstuffs**

COMMISSION REGULATION (EC) No 1881/2006
of 19 December 2006
setting maximum levels for certain contaminants in foodstuffs
 (Text with EEA relevance)

THE COMMISSION OF THE EUROPEAN COMMUNITIES,

Having regard to the Treaty establishing the European Community,

Having regard to Council Regulation (EEC) No 315/93 of 8 February 1993 laying down Community procedures for contaminants in food ⁽¹⁾, and in particular Article 2(3) thereof,

Whereas:

- (1) Commission Regulation (EC) No 466/2001 of 8 March 2001 setting maximum levels for certain contaminants in foodstuffs ⁽²⁾ has been amended substantially many times. It is necessary to amend again maximum levels for certain contaminants to take into account new information and developments in Codex Alimentarius. At the same time, the text should, where appropriate, be clarified. Regulation (EC) No 466/2001 should therefore be replaced.
- (2) It is essential, in order to protect public health, to keep contaminants at levels which are toxicologically acceptable.
- (3) In view of disparities between the laws of Member States and the consequent risk of distortion of competition, for some contaminants Community measures are necessary in order to ensure market unity while abiding by the principle of proportionality.
- (4) Maximum levels should be set at a strict level which is reasonably achievable by following good agricultural, fishery and manufacturing practices and taking into account the risk related to the consumption of the

food. In the case of contaminants which are considered to be genotoxic carcinogens or in cases where current exposure of the population or of vulnerable groups in the population is close to or exceeds the tolerable intake, maximum levels should be set at a level which is as low as reasonably achievable (ALARA). Such approaches ensure that food business operators apply measures to prevent and reduce the contamination as far as possible in order to protect public health. It is furthermore appropriate for the health protection of infants and young children, a vulnerable group, to establish the lowest maximum levels, which are achievable through a strict selection of the raw materials used for the manufacturing of foods for infants and young children. This strict selection of the raw materials is also appropriate for the production of some specific foodstuffs such as bran for direct human consumption.

- (5) To allow maximum levels to be applied to dried, diluted, processed and compound foodstuffs, where no specific Community maximum levels have been established, food business operators should provide the specific concentration and dilution factors accompanied by the appropriate experimental data justifying the factor proposed.
- (6) To ensure an efficient protection of public health, products containing contaminants exceeding the maximum levels should not be placed on the market either as such, after mixture with other foodstuffs or used as an ingredient in other foods.
- (7) It is recognised that sorting or other physical treatments make it possible to reduce the aflatoxin content of consignments of groundnuts, nuts, dried fruit and maize. In order to minimise the effects on trade, it is appropriate to allow higher aflatoxin contents for those products which are not intended for direct human consumption or as an ingredient in foodstuffs. In these cases, the maximum levels for aflatoxins should be fixed taking into consideration the effectiveness of the above-mentioned treatments to reduce the aflatoxin content in groundnuts, nuts, dried fruit and maize to levels below the maximum limits fixed for those products intended for direct human consumption or use as an ingredient in foodstuffs.
- (8) To enable effective enforcement of the maximum levels for certain contaminants in certain foodstuffs, it is appropriate to provide for suitable labelling provisions for these cases.

⁽¹⁾ OJ L 37, 13.2.1993, p. 1. Regulation as amended by Regulation (EC) No 1882/2003 of the European Parliament and of the Council (OJ L 284, 31.10.2003, p. 1).

⁽²⁾ OJ L 77, 16.3.2001, p. 1. Regulation as last amended by Regulation (EC) No 199/2006 (OJ L 32, 4.2.2006, p. 32).

- (9) Because of the climatic conditions in some Member States, it is difficult to ensure that the maximum levels are not exceeded for fresh lettuce and fresh spinach. These Member States should be allowed for a temporary period to continue to authorise the marketing of fresh lettuce and fresh spinach grown and intended for consumption in their territory with nitrate contents exceeding the maximum levels. Lettuce and spinach producers established in the Member States which have given the aforementioned authorisations should progressively modify their farming methods by applying the good agricultural practices recommended at national level.
- (10) Certain fish species originating from the Baltic region may contain high levels of dioxins and dioxin-like PCBs. A significant proportion of these fish species from the Baltic region will not comply with the maximum levels and would therefore be excluded from the diet. There are indications that the exclusion of fish from the diet may have a negative health impact in the Baltic region.
- (11) Sweden and Finland have a system in place which has the capacity to ensure that consumers are fully informed of the dietary recommendations concerning restrictions on consumption of fish from the Baltic region by identified vulnerable groups of the population in order to avoid potential health risks. Therefore, it is appropriate to grant a derogation to Finland and Sweden to place on the market for a temporary period certain fish species originating in the Baltic region and intended for consumption in their territory with levels of dioxins and dioxin-like PCBs higher than those set in this Regulation. The necessary measures must be implemented to ensure that fish and fish products not complying with the maximum levels are not marketed in other Member States. Finland and Sweden report every year to the Commission the results of their monitoring of the levels of dioxins and dioxin-like PCBs in fish from the Baltic region and the measures to reduce human exposure to dioxins and dioxin-like PCBs from the Baltic region.
- (12) To ensure that the maximum levels are enforced in a uniform way, the same sampling criteria and the same analysis performance criteria should be applied by the competent authorities throughout the Community. It is furthermore important that analytical results are reported and interpreted in a uniform way. The measures as regards sampling and analysis specified in this Regulation provide for uniform rules on reporting and interpretation.
- (13) For certain contaminants, Member States and interested parties should monitor and report levels, as well report on the progress with regard to application of preventative measures, to allow the Commission to assess the need to modify existing measures or to adopt additional measures.
- (14) Any maximum level adopted at Community level can be subject to a review to take account of the advance of scientific and technical knowledge and improvements in good agricultural, fishery and manufacturing practices.
- (15) Bran and germ can be marketed for direct human consumption and it is therefore appropriate to establish a maximum level for deoxynivalenol and zearalenone in these commodities.
- (16) Codex Alimentarius has recently set a maximum level for lead in fish which the Community accepted. It is therefore appropriate to modify the current provision for lead in fish accordingly.
- (17) Regulation (EC) No 853/2004 of the European Parliament and Council of 29 April 2004 laying down specific hygiene rules for food of animal origin ⁽³⁾ defines foodstuffs of animal origin, and consequently the entries as regards foodstuffs of animal origin should be amended in some cases according to the terminology used in that Regulation.
- (18) It is necessary to provide that the maximum levels for contaminants do not apply to the foodstuffs which have been lawfully placed on the Community market before the date of application of these maximum levels.
- (19) As regards nitrate, vegetables are the major source for the human intake of nitrate. The Scientific Committee on Food (SCF) stated in its opinion of 22 September 1995 ⁽⁴⁾ that the total intake of nitrate is normally well below the acceptable daily intake (ADI) of 3,65 mg/kg body weight (bw). It recommended, however, continuation of efforts to reduce exposure to nitrate via food and water.
- (20) Since climatic conditions have a major influence on the levels of nitrate in certain vegetables such as lettuce and spinach, different maximum nitrate levels should therefore be fixed depending on the season.
- (13) For certain contaminants, Member States and interested parties should monitor and report levels, as well report on the progress with regard to application of pre-

⁽³⁾ OJ L 139, 30.4.2004, p. 55, as corrected by OJ L 226, 25.6.2004, p. 22. Regulation as last amended by Regulation (EC) No 1662/2006 (OJ L 320, 18.11.2006, p. 1).

⁽⁴⁾ Reports of the Scientific Committee for Food, 38th series, Opinion of the Scientific Committee for Food on nitrates and nitrite, p. 1, http://ec.europa.eu/food/fs/sc/scf/reports/scf_reports_38.pdf

- (21) As regards aflatoxins, the SCF expressed in its opinion of 23 September 1994 that aflatoxins are genotoxic carcinogens⁽⁵⁾. Based on that opinion, it is appropriate to limit the total aflatoxin content of food (sum of aflatoxins B₁, B₂, G₁ and G₂) as well as the aflatoxin B₁ content alone, aflatoxin B₁ being by far the most toxic compound. For aflatoxin M₁ in foods for infants and young children, a possible reduction of the current maximum level should be considered in the light of developments in analytical procedures.
- (22) As regards ochratoxin A (OTA), the SCF adopted a scientific opinion on 17 September 1998⁽⁶⁾. An assessment of the dietary intake of OTA by the population of the Community has been performed⁽⁷⁾ in the framework of Council Directive 93/5/EEC of 25 February 1993 on assistance to the Commission and cooperation by the Member States in the scientific examination of questions relating to food⁽⁸⁾ (SCOOP). The European Food Safety Authority (EFSA) has, on a request from the Commission, adopted an updated scientific opinion relating to ochratoxin A in food on 4 April 2006⁽⁹⁾, taking into account new scientific information and derived a tolerable weekly intake (TWI) of 120 ng/kg bw.
- (23) Based on these opinions, it is appropriate to set maximum levels for cereals, cereal products, dried vine fruit, roasted coffee, wine, grape juice and foods for infants and young children, all of which contribute significantly to general human exposure to OTA or to the exposure of vulnerable groups of consumers such as children.
- (24) The appropriateness of setting a maximum level for OTA in foodstuffs such as dried fruit other than dried vine fruit, cocoa and cocoa products, spices, meat products, green coffee, beer and liquorice, as well as a review of the existing maximum levels, in particular for OTA in dried vine fruit and grape juice, will be considered in the light of the recent EFSA scientific opinion.
- (25) As regards patulin, the SCF endorsed in its meeting on 8 March 2000 the provisional maximum tolerable daily intake (PMTDI) of 0,4 µg/kg bw for patulin⁽¹⁰⁾.
- (26) In 2001, a SCOOP-task 'Assessment of the dietary intake of patulin by the population of EU Member States' in the framework of Directive 93/5/EEC was performed⁽¹¹⁾.
- (27) Based on that assessment and taking into account the PMTDI, maximum levels should be set for patulin in certain foodstuffs to protect consumers from unacceptable contamination. These maximum levels should be reviewed and, if necessary, reduced taking into account the progress in scientific and technological knowledge and the implementation of Commission Recommendation 2003/598/EC of 11 August 2003 on the prevention and reduction of patulin contamination in apple juice and apple juice ingredients in other beverages⁽¹²⁾.
- (28) As regards Fusarium toxins, the SCF has adopted several opinions evaluating deoxynivalenol in December 1999⁽¹³⁾ establishing a tolerable daily intake (TDI) of 1 µg/kg bw, zearalenone in June 2000⁽¹⁴⁾ establishing a temporary TDI of 0,2 µg/kg bw, fumonisins in October 2000⁽¹⁵⁾ (updated in April 2003)⁽¹⁶⁾ establishing a TDI of 2 µg/kg bw, nivalenol in October 2000⁽¹⁷⁾ establishing a temporary TDI of 0,7 µg/kg bw, T-2 and HT-2 toxin in May 2001⁽¹⁸⁾ establishing a combined temporary TDI of 0,06 µg/kg bw and the trichothecenes as group in February 2002⁽¹⁹⁾.
-
- ⁽⁵⁾ Reports of the Scientific Committee for Food, 35th series, Opinion of the Scientific Committee for Food on aflatoxins, ochratoxin A and patulin, p. 45.
http://ec.europa.eu/food/fs/sc/scf/reports/scf_reports_35.pdf
- ⁽⁶⁾ Opinion of the Scientific Committee on Food on Ochratoxin A (expressed on 17 September 1998)
http://ec.europa.eu/food/fs/sc/scf/out14_en.html
- ⁽⁷⁾ Reports on tasks for scientific cooperation, Task 3.2.7 'Assessment of dietary intake of Ochratoxin A by the population of EU Member States'.
http://ec.europa.eu/food/food/chemicalsafety/contaminants/task_3-2-7_en.pdf
- ⁽⁸⁾ OJ L 52, 4.3.1993, p. 18.
- ⁽⁹⁾ Opinion of the Scientific Panel on contaminants in the Food Chain of the EFSA on a request from the Commission related to ochratoxin A in food. http://www.efsa.europa.eu/etc/medialib/efsa/science/contam/contam_opinions/1521.Par.0001.File.dat/contam_op_ej365_ochratoxin_a_food_en1.pdf
- ⁽¹⁰⁾ Minutes of the 120th Meeting of the Scientific Committee on Food held on 8 and 9 March 2000 in Brussels, Minute statement on patulin. http://ec.europa.eu/food/fs/sc/scf/out55_en.pdf
- ⁽¹¹⁾ Reports on tasks for scientific cooperation, Task 3.2.8, 'Assessment of dietary intake of Patulin by the population of EU Member States'.
http://ec.europa.eu/food/food/chemicalsafety/contaminants/3.2.8_en.pdf
- ⁽¹²⁾ OJ L 203, 12.8.2003, p. 34.
- ⁽¹³⁾ Opinion of the Scientific Committee on Food on Fusarium-toxins Part 1: Deoxynivalenol (DON), (expressed on 2 December 1999)
http://ec.europa.eu/food/fs/sc/scf/out44_en.pdf
- ⁽¹⁴⁾ Opinion of the Scientific Committee on Food on Fusarium-toxins Part 2: Zearalenone (ZEA), (expressed on 22 June 2000)
http://ec.europa.eu/food/fs/sc/scf/out65_en.pdf
- ⁽¹⁵⁾ Opinion of the Scientific Committee on Food on Fusarium-toxins Part 3: Fumonisin B₁ (FB₁) (expressed on 17 October 2000)
http://ec.europa.eu/food/fs/sc/scf/out73_en.pdf
- ⁽¹⁶⁾ Updated opinion of the Scientific Committee on Food on Fusonisin B₁, B₂ and B₃ (expressed on 4 April 2003)
http://ec.europa.eu/food/fs/sc/scf/out185_en.pdf
- ⁽¹⁷⁾ Opinion of the Scientific Committee on Food on Fusarium-toxins Part 4: Nivalenol (expressed on 19 October 2000)
http://ec.europa.eu/food/fs/sc/scf/out74_en.pdf
- ⁽¹⁸⁾ Opinion of the Scientific Committee on Food on Fusarium-toxins Part 5: T-2 toxin and HT-2 toxin (adopted on 30 May 2001)
http://ec.europa.eu/food/fs/sc/scf/out88_en.pdf
- ⁽¹⁹⁾ Opinion of the Scientific Committee on Food on Fusarium-toxins Part 6: Group evaluation of T-2 toxin, HT-2toxin, nivalenol and deoxynivalenol. (adopted on 26 February 2002)
http://ec.europa.eu/food/fs/sc/scf/out123_en.pdf

- (29) In the framework of Directive 93/5/EEC the SCOOP-task 'Collection of occurrence data on Fusarium toxins in food and assessment of dietary intake by the population of EU Member States' was performed and finalised in September 2003 ⁽²⁰⁾.
- (30) Based on the scientific opinions and the assessment of the dietary intake, it is appropriate to set maximum levels for deoxynivalenol, zearalenone and fumonisins. As regards fumonisins, monitoring control results of the recent harvests indicate that maize and maize products can be very highly contaminated by fumonisins and it is appropriate that measures are taken to avoid such unacceptably highly contaminated maize and maize products can enter the food chain.
- (31) Intake estimates indicate that the presence of T-2 and HT-2 toxin can be of concern for public health. Therefore, the development of a reliable and sensitive method, collection of more occurrence data and more investigations/research in the factors involved in the presence of T-2 and HT-2 toxin in cereals and cereal products, in particular in oats and oat products, is necessary and of high priority.
- (32) It is not necessary due to co-occurrence to consider specific measures for 3-acetyl deoxynivalenol, 15-acetyl deoxynivalenol and fumonisin B₃, as measures with regard to in particular deoxynivalenol and fumonisin B₁ and B₂ would also protect the human population from an unacceptable exposure from 3-acetyl deoxynivalenol, 15-acetyl deoxynivalenol and fumonisin B₃. The same applies to nivalenol for which to a certain degree co-occurrence with deoxynivalenol can be observed. Furthermore, human exposure to nivalenol is estimated to be significantly below the t-TDI. As regards other trichothecenes considered in the abovementioned SCOOP-task, such as 3-acetyldeoxynivalenol, 15-acetyldeoxynivalenol, fusarenon-X, T2-triol, diacetoxyscirpenol, neosolaniol, monoacetoxyscirpenol and verrucol, the limited information available indicates that they do not occur widely and the levels found are generally low.
- (33) Climatic conditions during the growth, in particular at flowering, have a major influence on the Fusarium toxin content. However, good agricultural practices, whereby the risk factors are reduced to a minimum, can prevent to a certain degree the contamination by *Fusarium* fungi. Commission Recommendation 2006/583/EC of 17 August 2006 on the prevention and reduction of Fusarium toxins in cereals and cereal products ⁽²¹⁾ contains general principles for the prevention and reduction of Fusarium toxin contamination (zearalenone, fumonisins and trichothecenes) in cereals to be implemented by the development of national codes of practice based on these principles.
- (34) Maximum levels of Fusarium toxins should be set for unprocessed cereals placed on the market for first-stage processing. Cleaning, sorting and drying procedures are not considered as first-stage processing insofar as no physical action is exerted on the grain kernel itself. Scouring is to be considered as first-stage processing.
- (35) Since the degree to which Fusarium toxins in unprocessed cereals are removed by cleaning and processing may vary, it is appropriate to set maximum levels for final consumer cereal products as well as for major food ingredients derived from cereals to have enforceable legislation in the interest of ensuring public health protection.
- (36) For maize, not all factors involved in the formation of Fusarium toxins, in particular zearalenone and fumonisins B₁ and B₂, are yet precisely known. Therefore, a time period is granted to enable food business operators in the cereal chain to perform investigations on the sources of the formation of these mycotoxins and on the identification of the management measures to be taken to prevent their presence as far as reasonably possible. Maximum levels based on currently available occurrence data are proposed to apply from 2007 in case no specific maximum levels based on new information on occurrence and formation are set before that time.
- (37) Given the low contamination levels of Fusarium toxins found in rice, no maximum levels are proposed for rice or rice products.
- (38) A review of the maximum levels for deoxynivalenol, zearalenone, fumonisin B₁ and B₂ as well as the appropriateness of setting a maximum level for T-2 and HT-2 toxin in cereals and cereal products should be considered by 1 July 2008, taking into account the progress in scientific and technological knowledge on these toxins in food.
- (39) As regards lead, the SCF adopted an opinion on 19 June 1992 ⁽²²⁾ endorsing the provisional tolerable weekly intake (PTWI) of 25 µg/kg bw proposed by the WHO in 1986. The SCF concluded in its opinion that the mean level in foodstuffs does not seem to be a cause of immediate concern.

⁽²⁰⁾ Reports on tasks for scientific cooperation, Task 3.2.10 'Collection of occurrence data of Fusarium toxins in food and assessment of dietary intake by the population of EU Member States'. <http://ec.europa.eu/food/fs/scoop/task3210.pdf>

⁽²¹⁾ OJ L 234, 29.8.2006, p. 35.

⁽²²⁾ Reports of the Scientific Committee for Food, 32nd series, Opinion of the Scientific Committee for Food on 'The potential risk to health presented by lead in food and drink', p. 7, http://ec.europa.eu/food/fs/sc/scf/reports/scf_reports_32.pdf

- (40) In the framework of Directive 93/5/EEC 2004 the SCOOP-task 3.2.11 'Assessment of the dietary exposure to arsenic, cadmium, lead and mercury of the population of the EU Member States' was performed in 2004⁽²³⁾. In view of this assessment and the opinion delivered by the SCF, it is appropriate to take measures to reduce the presence of lead in food as much as possible
- (41) As regards cadmium, the SCF endorsed in its opinion of 2 June 1995⁽²⁴⁾ the PTWI of 7 µg/kg bw and recommended greater efforts to reduce dietary exposure to cadmium since foodstuffs are the main source of human intake of cadmium. A dietary exposure assessment was performed in the SCOOP-task 3.2.11. In view of this assessment and the opinion delivered by the SCF, it is appropriate to take measures to reduce the presence of cadmium in food as much as possible.
- (42) As regards mercury EFSA adopted on 24 February 2004 an opinion related to mercury and methylmercury in food⁽²⁵⁾ and endorsed the provisional tolerable weekly intake of 1,6 µg/kg bw. Methylmercury is the chemical form of most concern and can make up more than 90 % of the total mercury in fish and seafood. Taking into account the outcome of the SCOOP-task 3.2.11, EFSA concluded that the levels of mercury found in foods, other than fish and seafood, were of lower concern. The forms of mercury present in these other foods are mainly not methylmercury and they are therefore considered to be of lower risk.
- (43) In addition to the setting of maximum levels, targeted consumer advice is an appropriate approach in the case of methylmercury for protecting vulnerable groups of the population. An information note on methylmercury in fish and fishery products responding to this need has therefore been made available on the website of the Health and Consumer Protection Directorate-General of the European Commission⁽²⁶⁾. Several Member States have also issued advice on this issue that is relevant to their population.
- (44) As regards inorganic tin, the SCF concluded in its opinion of 12 December 2001⁽²⁷⁾ that levels of inorganic tin of 150 mg/kg in canned beverages and 250 mg/kg in other canned foods may cause gastric irritation in some individuals.
- (45) To protect public health from this health risk it is necessary to set maximum levels for inorganic tin in canned foods and canned beverages. Until data becomes available on the sensitivity of infants and young children to inorganic tin in foods, it is necessary on a precautionary basis to protect the health of this vulnerable population group and to establish lower maximum levels.
- (46) As regards 3-monochloropropane-1,2-diol (3-MCPD) the SCF adopted on 30 May 2001 a scientific opinion as regards 3-MCPD in food⁽²⁸⁾, updating its opinion of 16 December 1994⁽²⁹⁾ on the basis of new scientific information and established a tolerable daily intake (TDI) of 2 µg/kg bw for 3-MCPD.
- (47) In the framework of Directive 93/5/EEC the SCOOP-task 'Collection and collation of data on levels of 3-MCPD and related substances in foodstuffs' was performed and finalised in June 2004⁽³⁰⁾. The main contributors of 3-MCPD to dietary intake were soy sauce and soy-sauce based products. Some other foods eaten in large quantities, such as bread and noodles, also contributed significantly to intake in some countries because of high consumption rather than high levels of 3-MCPD present in these foods.
- (48) Accordingly maximum levels should be set for 3-MCPD in hydrolysed vegetable protein (HVP) and soy sauce taking into account the risk related to the consumption of these foods. Member States are requested to examine other foodstuffs for the occurrence of 3-MCPD in order to consider the need to set maximum levels for additional foodstuffs.

⁽²³⁾ Reports on tasks for scientific co-operation, Task 3.2.11 'Assessment of dietary exposure to arsenic, cadmium, lead and mercury of the population of the EU Member States'. http://ec.europa.eu/food/food/chemicalsafety/contaminants/scoop_3-2-11_heavy_metals_report_en.pdf

⁽²⁴⁾ Reports of the Scientific Committee for Food, 36th series, Opinion of the Scientific Committee for Food on cadmium, p. 67, http://ec.europa.eu/food/fs/sc/scf/reports/scf_reports_36.pdf

⁽²⁵⁾ Opinion of the Scientific Panel on contaminants in the Food Chain of the European Food Safety Authority (EFSA) on a request from the Commission related to mercury and methylmercury in food (adopted on 24 February 2004) http://www.efsa.eu.int/science/contam/contam_opinions/259/opinion_contam_01_en1.pdf

⁽²⁶⁾ http://ec.europa.eu/food/food/chemicalsafety/contaminants/information_note_mercury-fish_12-05-04.pdf

⁽²⁷⁾ Opinion of the Scientific Committee on Food on acute risks posed by tin in canned foods (adopted on 12 December 2001) http://ec.europa.eu/food/fs/sc/scf/out110_en.pdf

⁽²⁸⁾ Opinion of the Scientific Committee on Food on 3-monochloropropane-1,2-diol (3-MCPD) updating the SCF opinion of 1994 (adopted on 30 May 2001) http://ec.europa.eu/food/fs/sc/scf/out91_en.pdf

⁽²⁹⁾ Reports of the Scientific Committee for Food, 36th series, Opinion of the Scientific Committee for Food on 3-monochloropropane-1,2-diol 3-MCPD, p. 31, http://ec.europa.eu/food/fs/sc/scf/reports/scf_reports_36.pdf

⁽³⁰⁾ Reports on tasks for scientific cooperation, Task 3.2.9 'Collection and collation of data on levels of 3-monochloropropanediol (3-MCPD) and related substances in foodstuffs'. http://ec.europa.eu/food/food/chemicalsafety/contaminants/scoop_3-2-9_final_report_chloropropanols_en.pdf

- (49) As regards dioxins and PCBs, the SCF adopted on 30 May 2001 an opinion on dioxins and dioxin-like PCBs in food ⁽³¹⁾, updating its opinion of 22 November 2000 ⁽³²⁾ fixing a tolerable weekly intake (TWI) of 14 pg World Health Organisation toxic equivalent (WHO-TEQ)/kg bw for dioxins and dioxin-like PCBs.
- (50) Dioxins as referred to in this Regulation cover a group of 75 polychlorinated dibenzo-p-dioxin (PCDD) congeners and 135 polychlorinated dibenzofuran (PCDF) congeners, of which 17 are of toxicological concern. Polychlorinated biphenyls (PCBs) are a group of 209 different congeners which can be divided into two groups according to their toxicological properties: 12 congeners exhibit toxicological properties similar to dioxins and are therefore often termed dioxin-like PCBs. The other PCBs do not exhibit dioxin-like toxicity but have a different toxicological profile.
- (51) Each congener of dioxins or dioxin-like PCBs exhibits a different level of toxicity. In order to be able to sum up the toxicity of these different congeners, the concept of toxic equivalency factors (TEFs) has been introduced to facilitate risk assessment and regulatory control. This means that the analytical results relating to all the individual dioxin and dioxin-like PCB congeners of toxicological concern are expressed in terms of a quantifiable unit, namely the TCDD toxic equivalent (TEQ).
- (52) Exposure estimates taking into account the SCOOP-task 'Assessment of dietary intake of dioxins and related PCBs by the population of EU Member States' finalised in June 2000 ⁽³³⁾ indicate that a considerable proportion of the Community population has a dietary intake in excess of the TWI.
- (53) From a toxicological point of view, any level set should apply to both dioxins and dioxin-like PCBs, but in 2001 maximum levels were set on Community level only for dioxins and not for dioxin-like PCBs, given the very limited data available at that time on the prevalence of dioxin-like PCBs. Since 2001, however, more data on the presence of dioxin-like PCBs have become available, therefore, maximum levels for the sum of dioxins and dioxin-like PCBs have been set in 2006 as this is the most appropriate approach from a toxicological point of view. In order to ensure a smooth transition, the levels for dioxins should continue to apply for a transitional period in addition to the levels for the sum of dioxins and dioxin-like PCBs. Foodstuffs must comply during that transitional period with the maximum levels for dioxins and with the maximum levels for the sum of dioxins and dioxin-like PCBs. Consideration will be given by 31 December 2008 to dispensing with the separate maximum levels for dioxins.
- (54) In order to encourage a proactive approach to reducing the dioxins and dioxin-like PCBs present in food and feed, action levels were set by Commission Recommendation 2006/88/EC of 6 February 2006 on the reduction of the presence of dioxins, furans and PCBs in feeding-stuffs and foodstuffs ⁽³⁴⁾. These action levels are a tool for competent authorities and operators to highlight those cases where it is appropriate to identify a source of contamination and to take measures to reduce or eliminate it. Since the sources of dioxins and dioxin-like PCBs are different, separate action levels are determined for dioxins on the one hand and for dioxin-like PCBs on the other hand. This proactive approach to actively reduce the dioxins and dioxin-like PCBs in feed and food and consequently, the maximum levels applicable should be reviewed within a defined period of time with the objective to set lower levels. Therefore, consideration will be given by 31 December 2008 to significantly reducing the maximum levels for the sum of dioxins and dioxin-like PCBs.
- (55) Operators need to make efforts to step up their capacity to remove dioxins, furans and dioxin-like PCBs from marine oil. The significant lower level, to which consideration shall be given by 31 December 2008, shall be based on the technical possibilities of the most effective decontamination procedure.
- (56) As regards the establishment of maximum levels for other foodstuffs by 31 December 2008, particular attention shall be paid to the need to set specific lower maximum levels for dioxins and dioxin-like PCBs in foods for infants and young children in the light of the monitoring data obtained through the 2005, 2006 and 2007 programmes for monitoring dioxins and dioxin-like PCBs in foods for infants and young children.

⁽³¹⁾ Opinion of the Scientific Committee on Food on the risk assessment of dioxins and dioxin-like PCBs in food. Update based on new scientific information available since the adoption of the SCF opinion of 22nd November 2000 (adopted on 30 May 2001) http://ec.europa.eu/food/fs/sc/scf/out90_en.pdf

⁽³²⁾ Opinion of the Scientific Committee on Food on the risk assessment of dioxins and dioxin-like PCBs in food. (adopted on 22 November 2000) http://ec.europa.eu/food/fs/sc/scf/out78_en.pdf

⁽³³⁾ Reports on tasks for scientific cooperation, Task 3.2.5 'Assessment of dietary intake of dioxins and related PCBs by the population of EU Member States'. http://ec.europa.eu/dgs/health_consumer/library/pub/pub08_en.pdf

⁽³⁴⁾ OJ L 42, 14.2.2006, p. 26.

- (57) As regards polycyclic aromatic hydrocarbons, the SCF concluded in its opinion of 4 December 2002 ⁽³⁵⁾ that a number of polycyclic aromatic hydrocarbons (PAH) are genotoxic carcinogens. The Joint FAO/WHO Expert Committee on Food Additives (JECFA) performed in 2005 a risk assessment on PAHs and estimated margins of exposure (MOE) for PAH as a basis for advice on compounds that are both genotoxic and carcinogenic ⁽³⁶⁾.
- (58) According to the SCF, benzo(a)pyrene can be used as a marker for the occurrence and effect of carcinogenic PAH in food, including also benz(a)anthracene, benzo(b)fluoranthene, benzo(j)fluoranthene, benzo(k)fluoranthene, benzo(g,h,i)perylene, chrysene, cyclopenta(c,d)pyrene, dibenz(a,h)anthracene, dibenzo(a,e)pyrene, dibenzo(a,h)pyrene, dibenzo(a,i)pyrene, dibenzo(a,l)pyrene, indeno(1,2,3-cd)pyrene and 5-methylchrysene. Further analyses of the relative proportions of these PAH in foods would be necessary to inform a future review of the suitability of maintaining benzo(a)pyrene as a marker. In addition benzo(c)fluorene should be analysed, following a recommendation of JECFA.
- (59) PAH can contaminate foods during smoking processes and heating and drying processes that allow combustion products to come into direct contact with food. In addition, environmental pollution may cause contamination with PAH, in particular in fish and fishery products.
- (60) In the framework of Directive 93/5/EEC, a specific SCOOP-task 'Collection of occurrence data on PAH in food' has been performed in 2004 ⁽³⁷⁾. High levels were found in dried fruits, olive pomace oil, smoked fish, grape seed oil, smoked meat products, fresh molluscs, spices/sauces and condiments.
- (61) In order to protect public health, maximum levels are necessary for benzo(a)pyrene in certain foods containing fats and oils and in foods where smoking or drying processes might cause high levels of contamination. Maximum levels are also necessary in foods where environmental pollution may cause high levels of contamination, in particular in fish and fishery products, for example resulting from oil spills caused by shipping.
- (62) In some foods, such as dried fruit and food supplements, benzo(a)pyrene has been found, but available data are inconclusive on what levels are reasonably achievable. Further investigation is needed to clarify the levels that are reasonably achievable in these foods. In the meantime, maximum levels for benzo(a)pyrene in relevant ingredients should apply, such as in oils and fats used in food supplements.
- (63) The maximum levels for PAH and the appropriateness of setting a maximum level for PAH in cocoa butter should be reviewed by 1 April 2007, taking into account the progress in scientific and technological knowledge on the occurrence of benzo(a)pyrene and other carcinogenic PAH in food.
- (64) The measures provided for in this Regulation are in accordance with the opinion of the Standing Committee on the Food Chain and Animal Health,

HAS ADOPTED THIS REGULATION:

Article 1

General rules

1. The foodstuffs listed in the Annex shall not be placed on the market where they contain a contaminant listed in the Annex at a level exceeding the maximum level set out in the Annex.
2. The maximum levels specified in the Annex shall apply to the edible part of the foodstuffs concerned, unless otherwise specified in the Annex.

Article 2

Dried, diluted, processed and compound foodstuffs

1. When applying the maximum levels set out in the Annex to foodstuffs which are dried, diluted, processed or composed of more than one ingredient, the following shall be taken into account:
 - (a) changes of the concentration of the contaminant caused by drying or dilution processes;
 - (b) changes of the concentration of the contaminant caused by processing;
 - (c) the relative proportions of the ingredients in the product;
 - (d) the analytical limit of quantification.

⁽³⁵⁾ Opinion of the Scientific Committee on Food on the risks to human health of Polycyclic Aromatic Hydrocarbons in food (expressed on 4 December 2002)

http://ec.europa.eu/food/fs/sc/scf/out153_en.pdf

⁽³⁶⁾ Evaluation of certain food contaminants — Report of the Joint FAO/WHO Expert Committee on Food Additives, 64th meeting, Rome, 8 to 17 February 2005, p. 1 and p. 61.

WHO Technical Report Series, No. 930, 2006 — http://whqlibdoc.who.int/trs/WHO_TRS_930_eng.pdf

⁽³⁷⁾ Reports on tasks for scientific co-operation, Task 3.2.12 'Collection of occurrence data on polycyclic aromatic hydrocarbons in food'. http://ec.europa.eu/food/food/chemicalsafety/contaminants/scoop_3-2-12_final_report_pah_en.pdf

2. The specific concentration or dilution factors for the drying, dilution, processing and/or mixing operations concerned or for the dried, diluted, processed and/or compound foodstuffs concerned shall be provided and justified by the food business operator, when the competent authority carries out an official control.

If the food business operator does not provide the necessary concentration or dilution factor or if the competent authority deems that factor inappropriate in view of the justification given, the authority shall itself define that factor, based on the available information and with the objective of maximum protection of human health.

3. Paragraphs 1 and 2 shall apply in so far as no specific Community maximum levels are fixed for these dried, diluted, processed or compound foodstuffs.

4. As far as Community legislation does not provide for specific maximum levels for foods for infants and young children, Member States may provide for stricter levels.

Article 3

Prohibitions on use, mixing and detoxification

1. Foodstuffs not complying with the maximum levels set out in the Annex shall not be used as food ingredients.

2. Foodstuffs complying with the maximum levels set out in the Annex shall not be mixed with foodstuffs which exceed these maximum levels.

3. Foodstuffs to be subjected to sorting or other physical treatment to reduce contamination levels shall not be mixed with foodstuffs intended for direct human consumption or with foodstuffs intended for use as a food ingredient.

4. Foodstuffs containing contaminants listed in section 2 of the Annex (Mycotoxins) shall not be deliberately detoxified by chemical treatments.

Article 4

Specific provisions for groundnuts, nuts, dried fruit and maize

Groundnuts, nuts, dried fruit and maize not complying with the appropriate maximum levels of aflatoxins laid down in points 2.1.3, 2.1.5 and 2.1.6 of the Annex can be placed on the market provided that these foodstuffs:

- (a) are not intended for direct human consumption or use as an ingredient in foodstuffs;
- (b) comply with the appropriate maximum levels laid down in points 2.1.1, 2.1.2, 2.1.4 and 2.1.7 of the Annex;
- (c) are subjected to a treatment involving sorting or other physical treatment and that after this treatment the maximum levels laid down in points 2.1.3, 2.1.5 and 2.1.6 of the Annex are not exceeded, and this treatment does not result in other harmful residues;
- (d) are labelled clearly showing their use, and bearing the indication 'product shall be subjected to sorting or other physical treatment to reduce aflatoxin contamination before human consumption or use as an ingredient in foodstuffs'. The indication shall be included on the label of each individual bag, box etc. or on the original accompanying document. The consignment/batch identification code shall be indelibly marked on each individual bag, box etc. of the consignment and on the original accompanying document.

Article 5

Specific provisions for groundnuts, derived products thereof and cereals

A clear indication of the intended use must appear on the label of each individual bag, box, etc. or on the original accompanying document. This accompanying document must have a clear link with the consignment by means of mentioning the consignment identification code, which is on each individual bag, box, etc. of the consignment. In addition the business activity of the consignee of the consignment given on the accompanying document must be compatible with the intended use.

In the absence of a clear indication that their intended use is not for human consumption, the maximum levels laid down in points 2.1.3 and 2.1.6 of the Annex shall apply to all groundnuts, derived products thereof and cereals placed on the market.

Article 6

Specific provisions for lettuce

Unless lettuce grown under cover (protected lettuce) is labelled as such, maximum levels set in the Annex for lettuce grown in the open air (open-grown lettuce) shall apply.

*Article 7***Temporary derogations**

1. By way of derogation from Article 1, Belgium, Ireland, the Netherlands and the United Kingdom may authorise until 31 December 2008 the placing on the market of fresh spinach grown and intended for consumption in their territory with nitrate levels higher than the maximum levels set out in point 1.1 of the Annex.

2. By way of derogation from Article 1, Ireland and the United Kingdom may authorise until 31 December 2008 the placing on the market of fresh lettuce grown and intended for consumption in their territory and harvested throughout the year with nitrate levels higher than the maximum levels set out in point 1.3 of the Annex.

3. By way of derogation from Article 1, France may authorise until 31 December 2008 the placing on the market of fresh lettuce grown and intended for consumption in its territory and harvested from 1 October to 31 March with nitrate levels higher than the maximum levels set out in point 1.3 of the Annex.

4. By way of derogation from Article 1, Finland and Sweden may authorise until 31 December 2011 the placing on their market of salmon (*Salmo salar*), herring (*Clupea harengus*), river lamprey (*Lampetra fluviatilis*), trout (*Salmo trutta*), char (*Salvelinus* spp.) and roe of vendace (*Coregonus albula*) originating in the Baltic region and intended for consumption in their territory with levels of dioxins and/or levels of the sum of dioxins and dioxin-like PCBs higher than those set out in point 5.3 of the Annex, provided that a system is in place to ensure that consumers are fully informed of the dietary recommendations with regard to the restrictions on the consumption of these fish species from the Baltic region by identified vulnerable sections of the population in order to avoid potential health risks. By 31 March each year, Finland and Sweden shall communicate to the Commission the results of their monitoring of the levels of dioxins and dioxin-like PCBs in fish from the Baltic region obtained in the preceding year and shall report on the measures taken to reduce human exposure to dioxins and dioxin-like PCBs from fish from the Baltic region.

Finland and Sweden shall continue to apply the necessary measures to ensure that fish and fish products not complying with point 5.3 of the Annex are not marketed in other Member States.

*Article 8***Sampling and analysis**

The sampling and the analysis for the official control of the maximum levels specified in the Annex shall be performed in accordance with Commission Regulations (EC) No

1882/2006⁽³⁸⁾, No 401/2006⁽³⁹⁾, No 1883/2006⁽⁴⁰⁾ and Commission Directives 2001/22/EC⁽⁴¹⁾, 2004/16/EC⁽⁴²⁾ and 2005/10/EC⁽⁴³⁾.

*Article 9***Monitoring and reporting**

1. Member States shall monitor nitrate levels in vegetables which may contain significant levels, in particular green leaf vegetables, and communicate the results to the Commission by 30 June each year. The Commission will make these results available to the Member States.

2. Member States and interested parties shall communicate each year to the Commission the results of investigations undertaken including occurrence data and the progress with regard to the application of prevention measures to avoid contamination by ochratoxin A, deoxynivalenol, zearalenone, fumonisin B₁ and B₂, T-2 and HT-2 toxin. The Commission will make these results available to the Member States.

3. Member States should report to the Commission findings on aflatoxins, dioxins, dioxin-like PCBs, non-dioxin-like PCBs and polycyclic aromatic hydrocarbons as specified in Commission Decision 2006/504/EC⁽⁴⁴⁾, Commission Recommendation 2006/794/EC⁽⁴⁵⁾ and Commission Recommendation 2005/108/EC⁽⁴⁶⁾.

*Article 10***Repeal**

Regulation (EC) No 466/2001 is repealed.

References to the repealed Regulation shall be construed as references to this Regulation.

*Article 11***Transitional measures**

This Regulation shall not apply to products that were placed on the market before the dates referred to in points (a) to (d) in conformity with the provisions applicable at the respective date:

- (a) 1 July 2006 as regards the maximum levels for deoxynivalenol and zearalenone laid down in points 2.4.1, 2.4.2, 2.4.4, 2.4.5, 2.4.6, 2.4.7, 2.5.1, 2.5.3, 2.5.5 and 2.5.7 of the Annex;

⁽³⁸⁾ See page 25 of this Official Journal.

⁽³⁹⁾ OJ L 70, 9.3.2006, p. 12.

⁽⁴⁰⁾ See page 32 of this Official Journal.

⁽⁴¹⁾ OJ L 77, 16.3.2001, p. 14. Directive as amended by Directive 2005/4/EC (OJ L 19, 21.1.2005, p. 50).

⁽⁴²⁾ OJ L 42, 13.2.2004, p. 16.

⁽⁴³⁾ OJ L 34, 8.2.2005, p. 15.

⁽⁴⁴⁾ OJ L 199, 21.7.2006, p. 21.

⁽⁴⁵⁾ OJ L 322, 22.11.2006, p. 24.

⁽⁴⁶⁾ OJ L 34, 8.2.2005, p. 43.

(b) 1 July 2007 as regards the maximum levels for deoxyvalenol and zearalenone laid down in points 2.4.3, 2.5.2, 2.5.4, 2.5.6 and 2.5.8 of the Annex;

(c) 1 October 2007 as regards the maximum levels for fumonisins B₁ and B₂ laid down in point 2.6 of the Annex;

(d) 4 November 2006 as regards the maximum levels for the sum of dioxins and dioxin-like PCBs laid down in section 5 of the Annex.

The burden of proving when the products were placed on the market shall be borne by the food business operator.

Article 12

Entry into force and application

This Regulation shall enter into force on the 20th day following its publication in the *Official Journal of the European Union*.

It shall apply from 1 March 2007.

This Regulation shall be binding in its entirety and directly applicable in all Member States.

Done at Brussels, 19 December 2006.

For the Commission

Markos KYPRIANOU

Member of the Commission

ANNEX

Maximum levels for certain contaminants in foodstuffs ⁽¹⁾

Section 1: Nitrate

Foodstuffs ⁽¹⁾		Maximum levels (mg NO ₃ /kg)	
1.1	Fresh spinach (<i>Spinacia oleracea</i>) ⁽²⁾	Harvested 1 October to 31 March	3 000
		Harvested 1 April to 30 September	2 500
1.2	Preserved, deep-frozen or frozen spinach		2 000
1.3	Fresh Lettuce (<i>Lactuca sativa</i> L.) (protected and open-grown lettuce) excluding lettuce listed in point 1.4	Harvested 1 October to 31 March:	
		lettuce grown under cover	4 500
		lettuce grown in the open air	4 000
		Harvested 1 April to 30 September:	
	lettuce grown under cover	3 500	
	lettuce grown in the open air	2 500	
1.4	Iceberg-type lettuce	Lettuce grown under cover	2 500
		Lettuce grown in the open air	2 000
1.5	Processed cereal-based foods and baby foods for infants and young children ⁽³⁾ ⁽⁴⁾		200

Section 2: Mycotoxins

Foodstuffs ⁽¹⁾		Maximum levels (µg/kg)		
2.1	Aflatoxins	B ₁	Sum of B ₁ , B ₂ , G ₁ and G ₂	M ₁
2.1.1	Groundnuts to be subjected to sorting, or other physical treatment, before human consumption or use as an ingredient in foodstuffs	8,0 ⁽⁵⁾	15,0 ⁽⁵⁾	—
2.1.2	Nuts to be subjected to sorting, or other physical treatment, before human consumption or use as an ingredient in foodstuffs	5,0 ⁽⁵⁾	10,0 ⁽⁵⁾	—
2.1.3	Groundnuts and nuts and processed products thereof, intended for direct human consumption or use as an ingredient in foodstuffs	2,0 ⁽⁵⁾	4,0 ⁽⁵⁾	—
2.1.4	Dried fruit to be subjected to sorting, or other physical treatment, before human consumption or use as an ingredient in foodstuffs	5,0	10,0	—
2.1.5	Dried fruit and processed products thereof, intended for direct human consumption or use as an ingredient in foodstuffs	2,0	4,0	—
2.1.6	All cereals and all products derived from cereals, including processed cereal products, with the exception of foodstuffs listed in 2.1.7, 2.1.10 and 2.1.12	2,0	4,0	—
2.1.7	Maize to be subjected to sorting or other physical treatment before human consumption or use as an ingredient in foodstuffs	5,0	10,0	—
2.1.8	Raw milk ⁽⁶⁾ , heat-treated milk and milk for the manufacture of milk-based products	—	—	0,050

Foodstuffs ⁽¹⁾		Maximum levels (µg/kg)		
2.1.9	Following species of spices: <i>Capsicum</i> spp. (dried fruits thereof, whole or ground, including chillies, chilli powder, cayenne and paprika) <i>Piper</i> spp. (fruits thereof, including white and black pepper) <i>Myristica fragrans</i> (nutmeg) <i>Zingiber officinale</i> (ginger) <i>Curcuma longa</i> (turmeric)	5,0	10,0	—
2.1.10	Processed cereal-based foods and baby foods for infants and young children ⁽³⁾ ⁽⁷⁾	0,10	—	—
2.1.11	Infant formulae and follow-on formulae, including infant milk and follow-on milk ⁽⁴⁾ ⁽⁸⁾	—	—	0,025
2.1.12	Dietary foods for special medical purposes ⁽⁹⁾ ⁽¹⁰⁾ intended specifically for infants	0,10	—	0,025
2.2	Ochratoxin A			
2.2.1	Unprocessed cereals	5,0		
2.2.2	All products derived from unprocessed cereals, including processed cereal products and cereals intended for direct human consumption with the exception of foodstuffs listed in 2.2.9 and 2.2.10	3,0		
2.2.3	Dried vine fruit (currants, raisins and sultanas)	10,0		
2.2.4	Roasted coffee beans and ground roasted coffee, excluding soluble coffee	5,0		
2.2.5	Soluble coffee (instant coffee)	10,0		
2.2.6	Wine (including sparkling wine, excluding liqueur wine and wine with an alcoholic strength of not less than 15 % vol) and fruit wine ⁽¹¹⁾	2,0 ⁽¹²⁾		
2.2.7	Aromatised wine, aromatised wine-based drinks and aromatised wine-product cocktails ⁽¹³⁾	2,0 ⁽¹²⁾		
2.2.8	Grape juice, concentrated grape juice as reconstituted, grape nectar, grape must and concentrated grape must as reconstituted, intended for direct human consumption ⁽¹⁴⁾	2,0 ⁽¹²⁾		
2.2.9	Processed cereal-based foods and baby foods for infants and young children ⁽³⁾ ⁽⁷⁾	0,50		
2.2.10	Dietary foods for special medical purposes ⁽⁹⁾ ⁽¹⁰⁾ intended specifically for infants	0,50		
2.2.11	Green coffee, dried fruit other than dried vine fruit, beer, cocoa and cocoa products, liqueur wines, meat products, spices and liquorice	—		
2.3	Patulin			
2.3.1	Fruit juices, concentrated fruit juices as reconstituted and fruit nectars ⁽¹⁴⁾	50		

	Foodstuffs ⁽¹⁾	Maximum levels (µg/kg)
2.3.2	Spirit drinks ⁽¹⁵⁾ , cider and other fermented drinks derived from apples or containing apple juice	50
2.3.3	Solid apple products, including apple compote, apple puree intended for direct consumption with the exception of foodstuffs listed in 2.3.4 and 2.3.5	25
2.3.4	Apple juice and solid apple products, including apple compote and apple puree, for infants and young children ⁽¹⁶⁾ and labelled and sold as such ⁽⁴⁾	10,0
2.3.5	Baby foods other than processed cereal-based foods for infants and young children ⁽³⁾ ⁽⁴⁾	10,0
2.4	Deoxynivalenol ⁽¹⁷⁾	
2.4.1	Unprocessed cereals ⁽¹⁸⁾ ⁽¹⁹⁾ other than durum wheat, oats and maize	1 250
2.4.2	Unprocessed durum wheat and oats ⁽¹⁸⁾ ⁽¹⁹⁾	1 750
2.4.3	Unprocessed maize ⁽¹⁸⁾	1 750 ⁽²⁰⁾
2.4.4	Cereals intended for direct human consumption, cereal flour (including maize flour, maize meal and maize grits ⁽²¹⁾), bran as end product marketed for direct human consumption and germ, with the exception of foodstuffs listed in 2.4.7	750
2.4.5	Pasta (dry) ⁽²²⁾	750
2.4.6	Bread (including small bakery wares), pastries, biscuits, cereal snacks and breakfast cereals	500
2.4.7	Processed cereal-based foods and baby foods for infants and young children ⁽³⁾ ⁽⁷⁾	200
2.5	Zearalenone ⁽¹⁷⁾	
2.5.1	Unprocessed cereals ⁽¹⁸⁾ ⁽¹⁹⁾ other than maize	100
2.5.2	Unprocessed maize ⁽¹⁸⁾	200 ⁽²⁰⁾
2.5.3	Cereals intended for direct human consumption, cereal flour, bran as end product marketed for direct human consumption and germ, with the exception of foodstuffs listed in 2.5.4, 2.5.7 and 2.5.8	75
2.5.4	Maize intended for direct human consumption, maize flour, maize meal, maize grits, maize germ and refined maize oil ⁽²¹⁾	200 ⁽²⁰⁾
2.5.5	Bread (including small bakery wares), pastries, biscuits, cereal snacks and breakfast cereals, excluding maize snacks and maize based breakfast cereals	50
2.5.6	Maize snacks and maize based breakfast cereals	50 ⁽²⁰⁾

Foodstuffs ⁽¹⁾		Maximum levels (µg/kg)
2.5.7	Processed cereal-based foods (excluding processed maize-based foods) and baby foods for infants and young children ⁽³⁾ ⁽⁷⁾	20
2.5.8	Processed maize-based foods for infants and young children ⁽³⁾ ⁽⁷⁾	20 ⁽²⁰⁾
2.6	Fumonisin	Sum of B ₁ and B ₂
2.6.1	Unprocessed maize ⁽¹⁸⁾	2 000 ⁽²³⁾
2.6.2	Maize flour, maize meal, maize grits, maize germ and refined maize oil ⁽²¹⁾	1 000 ⁽²³⁾
2.6.3	Maize based foods for direct human consumption, excluding foods listed in 2.6.2 and 2.6.4	400 ⁽²³⁾
2.6.4	Processed maize-based foods and baby foods for infants and young children ⁽³⁾ ⁽⁷⁾	200 ⁽²³⁾
2.7	T-2 and HT-2 toxin ⁽¹⁷⁾	Sum of T-2 and HT-2 toxin
2.7.1	Unprocessed cereals ⁽¹⁸⁾ and cereal products	

Section 3: Metals

Foodstuffs ⁽¹⁾		Maximum levels (mg/kg wet weight)
3.1	Lead	
3.1.1	Raw milk ⁽⁶⁾ , heat-treated milk and milk for the manufacture of milk-based products	0,020
3.1.2	Infant formulae and follow-on formulae ⁽⁴⁾ ⁽⁸⁾	0,020
3.1.3	Meat (excluding offal) of bovine animals, sheep, pig and poultry ⁽⁶⁾	0,10
3.1.4	Offal of bovine animals, sheep, pig and poultry ⁽⁶⁾	0,50
3.1.5	Muscle meat of fish ⁽²⁴⁾ ⁽²⁵⁾	0,30
3.1.6	Crustaceans, excluding brown meat of crab and excluding head and thorax meat of lobster and similar large crustaceans (<i>Nephropidae</i> and <i>Palinuridae</i>) ⁽²⁶⁾	0,50
3.1.7	Bivalve molluscs ⁽²⁶⁾	1,5
3.1.8	Cephalopods (without viscera) ⁽²⁶⁾	1,0
3.1.9	Cereals, legumes and pulses	0,20
3.1.10	Vegetables, excluding brassica vegetables, leaf vegetables, fresh herbs and fungi ⁽²⁷⁾ . For potatoes the maximum level applies to peeled potatoes	0,10

	Foodstuffs ⁽¹⁾	Maximum levels (mg/kg wet weight)
3.1.11	Brassica vegetables, leaf vegetables and cultivated fungi ⁽²⁷⁾	0,30
3.1.12	Fruit, excluding berries and small fruit ⁽²⁷⁾	0,10
3.1.13	Berries and small fruit ⁽²⁷⁾	0,20
3.1.14	Fats and oils, including milk fat	0,10
3.1.15	Fruit juices, concentrated fruit juices as reconstituted and fruit nectars ⁽¹⁴⁾	0,050
3.1.16	Wine (including sparkling wine, excluding liqueur wine), cider, perry and fruit wine ⁽¹¹⁾	0,20 ⁽²⁸⁾
3.1.17	Aromatized wine, aromatized wine-based drinks and aromatized wine-product cocktails ⁽¹³⁾	0,20 ⁽²⁸⁾
3.2	Cadmium	
3.2.1	Meat (excluding offal) of bovine animals, sheep, pig and poultry ⁽⁶⁾	0,050
3.2.2	Horsemeat, excluding offal ⁽⁶⁾	0,20
3.2.3	Liver of bovine animals, sheep, pig, poultry and horse ⁽⁶⁾	0,50
3.2.4	Kidney of bovine animals, sheep, pig, poultry and horse ⁽⁶⁾	1,0
3.2.5	Muscle meat of fish ⁽²⁴⁾ ⁽²⁵⁾ , excluding species listed in 3.2.6 and 3.2.7	0,050
3.2.6	Muscle meat of the following fish ⁽²⁴⁾ ⁽²⁵⁾ : anchovy (<i>Engraulis species</i>) bonito (<i>Sarda sarda</i>) common two-banded seabream (<i>Diplodus vulgaris</i>) eel (<i>Anguilla anguilla</i>) grey mullet (<i>Mugil labrosus labrosus</i>) horse mackerel or scad (<i>Trachurus species</i>) louvar or luvar (<i>Luvarus imperialis</i>) sardine (<i>Sardina pilchardus</i>) sardinops (<i>Sardinops species</i>) tuna (<i>Thunnus species</i> , <i>Euthynnus species</i> , <i>Katsuwonus pelamis</i>) wedge sole (<i>Dicologlossa cuneata</i>)	0,10
3.2.7	Muscle meat of swordfish (<i>Xiphias gladius</i>) ⁽²⁴⁾ ⁽²⁵⁾	0,30
3.2.8	Crustaceans, excluding brown meat of crab and excluding head and thorax meat of lobster and similar large crustaceans (<i>Nephropidae</i> and <i>Palinuridae</i>) ⁽²⁶⁾	0,50
3.2.9	Bivalve molluscs ⁽²⁶⁾	1,0
3.2.10	Cephalopods (without viscera) ⁽²⁶⁾	1,0

	Foodstuffs ⁽¹⁾	Maximum levels (mg/kg wet weight)
3.2.11	Cereals excluding bran, germ, wheat and rice	0,10
3.2.12	Bran, germ, wheat and rice	0,20
3.2.13	Soybeans	0,20
3.2.14	Vegetables and fruit, excluding leaf vegetables, fresh herbs, fungi, stem vegetables, pine nuts, root vegetables and potatoes ⁽²⁷⁾	0,050
3.2.15	Leaf vegetables, fresh herbs, cultivated fungi and celeriac ⁽²⁷⁾	0,20
3.2.16	Stem vegetables, root vegetables and potatoes, excluding celeriac ⁽²⁷⁾ . For potatoes the maximum level applies to peeled potatoes	0,10
3.3	Mercury	
3.3.1	Fishery products ⁽²⁶⁾ and muscle meat of fish ⁽²⁴⁾ ⁽²⁵⁾ , excluding species listed in 3.3.2. The maximum level applies to crustaceans, excluding the brown meat of crab and excluding head and thorax meat of lobster and similar large crustaceans (<i>Nephropidae</i> and <i>Palinuridae</i>)	0,50
3.3.2	Muscle meat of the following fish ⁽²⁴⁾ ⁽²⁵⁾ : anglerfish (<i>Lophius species</i>) atlantic catfish (<i>Anarhichas lupus</i>) bonito (<i>Sarda sarda</i>) eel (<i>Anguilla species</i>) emperor, orange roughy, rosy soldierfish (<i>Hoplostethus species</i>) grenadier (<i>Coryphaenoides rupestris</i>) halibut (<i>Hippoglossus hippoglossus</i>) marlin (<i>Makaira species</i>) megrin (<i>Lepidorhombus species</i>) mullet (<i>Mullus species</i>) pike (<i>Esox lucius</i>) plain bonito (<i>Orcynopsis unicolor</i>) poor cod (<i>Tricopterus minutes</i>) portuguese dogfish (<i>Centroscymnus coelolepis</i>) rays (<i>Raja species</i>) redfish (<i>Sebastes marinus</i> , <i>S. mentella</i> , <i>S. viviparus</i>) sail fish (<i>Istiophorus platypterus</i>) scabbard fish (<i>Lepidopus caudatus</i> , <i>Aphanopus carbo</i>) seabream, pandora (<i>Pagellus species</i>) shark (all species) snake mackerel or butterfish (<i>Lepidocybium flavobrunneum</i> , <i>Ruvettus pretiosus</i> , <i>Gempylus serpens</i>) sturgeon (<i>Acipenser species</i>) swordfish (<i>Xiphias gladius</i>) tuna (<i>Thunnus species</i> , <i>Euthynnus species</i> , <i>Katsuwonus pelamis</i>)	1,0
3.4	Tin (inorganic)	
3.4.1	Canned foods other than beverages	200
3.4.2	Canned beverages, including fruit juices and vegetable juices	100

Foodstuffs ⁽¹⁾		Maximum levels (mg/kg wet weight)
3.4.3	Canned baby foods and processed cereal-based foods for infants and young children, excluding dried and powdered products ⁽³⁾ ⁽²⁹⁾	50
3.4.4	Canned infant formulae and follow-on formulae (including infant milk and follow-on milk), excluding dried and powdered products ⁽⁸⁾ ⁽²⁹⁾	50
3.4.5	Canned dietary foods for special medical purposes ⁽⁹⁾ ⁽²⁹⁾ intended specifically for infants, excluding dried and powdered products	50

Section 4: 3-monochloropropane-1,2-diol (3-MCPD)

Foodstuffs ⁽¹⁾		Maximum levels (µg/kg)
4.1	Hydrolysed vegetable protein ⁽³⁰⁾	20
4.2	Soy sauce ⁽³⁰⁾	20

Section 5: Dioxins and PCBs ⁽³¹⁾

Foodstuffs		Maximum levels	
		Sum of dioxins (WHO-PCDD/F-TEQ) ⁽³²⁾	Sum of dioxins and dioxin-like PCBs (WHO-PCDD/F-PCB-TEQ) ⁽³²⁾
5.1	Meat and meat products (excluding edible offal) of the following animals ⁽⁶⁾		
	— bovine animals and sheep	3,0 pg/g fat ⁽³³⁾	4,5 pg/g fat ⁽³³⁾
	— poultry	2,0 pg/g fat ⁽³³⁾	4,0 pg/g fat ⁽³³⁾
	— pigs	1,0 pg/g fat ⁽³³⁾	1,5 pg/g fat ⁽³³⁾
5.2	Liver of terrestrial animals referred to in 5.1 ⁽⁶⁾ , and derived products thereof	6,0 pg/g fat ⁽³³⁾	12,0 pg/g fat ⁽³³⁾
5.3	Muscle meat of fish and fishery products and products thereof, excluding eel ⁽²⁵⁾ ⁽³⁴⁾ . The maximum level applies to crustaceans, excluding the brown meat of crab and excluding head and thorax meat of lobster and similar large crustaceans (<i>Nephropidae</i> and <i>Palinuridae</i>)	4,0 pg/g wet weight	8,0 pg/g wet weight
5.4	Muscle meat of eel (<i>Anguilla anguilla</i>) and products thereof	4,0 pg/g wet weight	12,0 pg/g wet weight
5.5	Raw milk ⁽⁶⁾ and dairy products ⁽⁶⁾ , including butterfat	3,0 pg/g fat ⁽³³⁾	6,0 pg/g fat ⁽³³⁾

Foodstuffs		Maximum levels	
		Sum of dioxins (WHO-PCDD/F-TEQ) ⁽³²⁾	Sum of dioxins and dioxin-like PCBs (WHO-PCDD/F-PCB-TEQ) ⁽³²⁾
5.6	Hen eggs and egg products ⁽⁶⁾	3,0 pg/g fat ⁽³³⁾	6,0 pg/g fat ⁽³³⁾
5.7	Fat of the following animals:		
	— bovine animals and sheep	3,0 pg/g fat	4,5 pg/g fat
	— poultry	2,0 pg/g fat	4,0 pg/g fat
	— pigs	1,0 pg/g fat	1,5 pg/g fat
5.8	Mixed animal fats	2,0 pg/g fat	3,0 pg/g fat
5.9	Vegetable oils and fats	0,75 pg/g fat	1,5 pg/g fat
5.10	Marine oils (fish body oil, fish liver oil and oils of other marine organisms intended for human consumption)	2,0 pg/g fat	10,0 pg/g fat

Section 6: Polycyclic aromatic hydrocarbons

Foodstuffs		Maximum levels (µg/kg wet weight)
6.1	Benzo(a)pyrene ⁽³⁵⁾	
6.1.1	Oils and fats (excluding cocoa butter) intended for direct human consumption or use as an ingredient in foods	2,0
6.1.2	Smoked meats and smoked meat products	5,0
6.1.3	Muscle meat of smoked fish and smoked fishery products ⁽²⁵⁾ ⁽³⁶⁾ , excluding bivalve molluscs. The maximum level applies to smoked crustaceans, excluding the brown meat of crab and excluding head and thorax meat of lobster and similar large crustaceans (<i>Nephropidae</i> and <i>Palinuridae</i>)	5,0
6.1.4	Muscle meat of fish ⁽²⁴⁾ ⁽²⁵⁾ , other than smoked fish	2,0
6.1.5	Crustaceans, cephalopods, other than smoked ⁽²⁶⁾ . The maximum level applies to crustaceans, excluding the brown meat of crab and excluding head and thorax meat of lobster and similar large crustaceans (<i>Nephropidae</i> and <i>Palinuridae</i>)	5,0
6.1.6	Bivalve molluscs ⁽²⁶⁾	10,0
6.1.7	Processed cereal-based foods and baby foods for infants and young children ⁽³⁾ ⁽²⁹⁾	1,0
6.1.8	Infant formulae and follow-on formulae, including infant milk and follow-on milk ⁽⁸⁾ ⁽²⁹⁾	1,0
6.1.9	Dietary foods for special medical purposes ⁽⁹⁾ ⁽²⁹⁾ intended specifically for infants	1,0

- (¹) As regards fruits, vegetables and cereals, reference is made to the foodstuffs listed in the relevant category as defined in Regulation (EC) No 396/2005 of the European Parliament and of the Council of 23 February 2005 on maximum residue levels of pesticides in or on food and feed of plant and animal origin and amending Council Directive 91/414/EEC (OJ L 70, 16.3.2005, p. 1) as last amended by Regulation (EC) No 178/2006 (OJ L 29, 2.2.2006, p. 3). This means, *inter alia*, that buckwheat (*Fagopyrum* sp) is included in 'cereals' and buckwheat products are included in 'cereal products'.
- (²) The maximum levels do not apply for fresh spinach to be subjected to processing and which is directly transported in bulk from field to processing plant.
- (³) Foodstuffs listed in this category as defined in Commission Directive 96/5/EC of 16 February 1996 on processed cereal-based foods and baby foods for infants and young children (OJ L 49, 28.2.1996, p. 17) as last amended by Directive 2003/13/EC (OJ L 41, 14.2.2003, p. 33).
- (⁴) The maximum level refers to the products ready to use (marketed as such or after reconstitution as instructed by the manufacturer).
- (⁵) The maximum levels refer to the edible part of groundnuts and nuts. If groundnuts and nuts 'in shell' are analysed, it is assumed when calculating the aflatoxin content all the contamination is on the edible part.
- (⁶) Foodstuffs listed in this category as defined in Regulation (EC) No 853/2004 of the European Parliament and of the Council of 29 April 2004 laying down specific hygiene rules for food of animal origin (OJ L 226, 25.6.2004, p. 22).
- (⁷) The maximum level refers to the dry matter. The dry matter is determined in accordance with Regulation (EC) No 401/2006.
- (⁸) Foodstuffs listed in this category as defined in Commission Directive 91/321/EEC of 14 May 1991 on infant formulae and follow-on formulae (OJ L 175, 4.7.1991, p. 35) as last amended by Directive 2003/14/EC (OJ L 41, 14.2.2003, p. 37).
- (⁹) Foodstuffs listed in this category as defined in Commission Directive 1999/21/EC of 25 March 1999 on dietary foods for special medical purposes (OJ L 91, 7.4.1999, p. 29).
- (¹⁰) The maximum level refers in the case of milk and milk products, to the products ready for use (marketed as such or reconstituted as instructed by the manufacturer) and in the case of products other than milk and milk products, to the dry matter. The dry matter is determined in accordance with Regulation (EC) No 401/2006.
- (¹¹) Foodstuffs listed in this category as defined in Council Regulation (EC) No 1493/1999 of 17 May 1999 on the common organisation of the market in wine (OJ L 179, 14.7.1999, p. 1) as last amended by the Protocol concerning the conditions and arrangements for admission of the Republic of Bulgaria and Romania to the European Union (OJ L 157, 21.6.2005, p. 29).
- (¹²) The maximum level applies to products produced from the 2005 harvest onwards.
- (¹³) Foodstuffs listed in this category as defined in Council Regulation (EEC) No 1601/91 of 10 June 1991 laying down general rules on the definition, description and presentation of aromatised wines, aromatised wine-based drinks and aromatised wine-product cocktails (OJ L 149, 14.6.1991, p. 1) as last amended by the Protocol concerning the conditions and arrangements for admission of the Republic of Bulgaria and Romania to the European Union. The maximum level for OTA applicable to these beverages is function of the proportion of wine and/or grape must present in the finished product.
- (¹⁴) Foodstuffs listed in this category as defined in Council Directive 2001/112/EC of 20 December 2001 relating to fruit juices and certain similar products intended for human consumption (OJ L 10, 12.1.2002, p. 58).
- (¹⁵) Foodstuffs listed in this category as defined in Council Regulation (EEC) No 1576/89 of 29 May 1989 laying down general rules on the definition, description and presentation of spirit drinks (OJ L 160, 12.6.1989, p. 1), as last amended by the Protocol concerning the conditions and arrangements for admission of the Republic of Bulgaria and Romania to the European Union.
- (¹⁶) Infants and young children as defined in Directive 91/321/EEC and Directive 96/5/EC.
- (¹⁷) For the purpose of the application of maximum levels for deoxynivalenol, zearalenone, T-2 and HT-2 toxin established in points 2.4, 2.5 and 2.7 rice is not included in 'cereals' and rice products are not included in 'cereal products'.
- (¹⁸) The maximum level applies to unprocessed cereals placed on the market for first-stage processing. 'First-stage processing' shall mean any physical or thermal treatment, other than drying, of or on the grain. Cleaning, sorting and drying procedures are not considered to be 'first-stage processing' insofar no physical action is exerted on the grain kernel itself and the whole grain remains intact after cleaning and sorting. In integrated production and processing systems, the maximum level applies to the unprocessed cereals in case they are intended for first-stage processing.
- (¹⁹) The maximum level applies to cereals harvested and taken over, as from the 2005/06 marketing year, in accordance with Commission Regulation (EC) No 824/2000 of 19 April 2000 establishing procedures for the taking-over of cereals by intervention agencies and laying down methods of analysis for determining the quality of cereals (OJ L 100, 20.4.2000, p. 31), as last amended by Regulation (EC) No 1068/2005 (OJ L 174, 7.7.2005, p. 65).
- (²⁰) Maximum level shall apply from 1 July 2007.
- (²¹) This category includes also similar products otherwise denominated such as semolina.
- (²²) Pasta (dry) means pasta with a water content of approximately 12 %.

- (23) Maximum level shall apply from 1 October 2007.
- (24) Fish listed in this category as defined in category (a), with the exclusion of fish liver falling under code CN 0302 70 00, of the list in Article 1 of Council Regulation (EC) No 104/2000 (OJ L 17, 21.1.2000, p. 22) as last amended by the Act concerning the conditions of accession of the Czech Republic, the Republic of Estonia, the Republic of Cyprus, the Republic of Latvia, the Republic of Lithuania, the Republic of Hungary, the Republic of Malta, the Republic of Poland, the Republic of Slovenia and the Slovak Republic and the adjustments to the Treaties on which the European Union is founded (OJ L 236, 23.9.2003, p. 33). In case of dried, diluted, processed and/or compound foodstuffs Article 2(1) and 2(2) apply.
- (25) Where fish are intended to be eaten whole, the maximum level shall apply to the whole fish.
- (26) Foodstuffs falling within category (c) and (f) of the list in Article 1 of Regulation (EC) No 104/2000, as appropriate (species as listed in the relevant entry). In case of dried, diluted, processed and/or compound foodstuffs Article 2(1) and 2(2) apply.
- (27) The maximum level applies after washing of the fruit or vegetables and separating the edible part.
- (28) The maximum level applies to products produced from the 2001 fruit harvest onwards.
- (29) The maximum level refers to the product as sold.
- (30) The maximum level is given for the liquid product containing 40 % dry matter, corresponding to a maximum level of 50 µg/kg in the dry matter. The level needs to be adjusted proportionally according to the dry matter content of the products.
- (31) Dioxins (sum of polychlorinated dibenzo-para-dioxins (PCDDs) and polychlorinated dibenzofurans (PCDFs), expressed as World Health Organisation (WHO) toxic equivalent using the WHO-toxic equivalency factors (WHO-TEFs)) and sum of dioxins and dioxin-like PCBs (sum of PCDDs, PCDFs and polychlorinated biphenyls (PCBs), expressed as WHO toxic equivalent using the WHO-TEFs). WHO-TEFs for human risk assessment based on the conclusions of the WHO meeting in Stockholm, Sweden, 15 to 18 June 1997 (Van den Berg et al., (1998) Toxic Equivalency Factors (TEFs) for PCBs, PCDDs, PCDFs for Humans and for Wildlife. Environmental Health Perspectives, 106 (12), 775).

Congener	TEF value	Congener	TEF value
Dibenzo-p-dioxins (PCDDs)		Dioxin-like PCBs: Non-ortho PCBs + Mono-ortho PCBs	
2,3,7,8-TCDD	1	<i>Non-ortho PCBs</i>	
1,2,3,7,8-PeCDD	1	PCB 77	0,0001
1,2,3,4,7,8-HxCDD	0,1	PCB 81	0,0001
1,2,3,6,7,8-HxCDD	0,1	PCB 126	0,1
1,2,3,7,8,9-HxCDD	0,1	PCB 169	0,01
1,2,3,4,6,7,8-HpCDD	0,01		
OCDD	0,0001	<i>Mono-ortho PCBs</i>	
Dibenzofurans (PCDFs)		PCB 105	0,0001
2,3,7,8-TCDF	0,1	PCB 114	0,0005
1,2,3,7,8-PeCDF	0,05	PCB 118	0,0001
2,3,4,7,8-PeCDF	0,5	PCB 123	0,0001
1,2,3,4,7,8-HxCDF	0,1	PCB 156	0,0005
1,2,3,6,7,8-HxCDF	0,1	PCB 157	0,0005
1,2,3,7,8,9-HxCDF	0,1	PCB 167	0,00001
2,3,4,6,7,8-HxCDF	0,1	PCB 189	0,0001
1,2,3,4,6,7,8-HpCDF	0,01		
1,2,3,4,7,8,9-HpCDF	0,01		
OCDF	0,0001		

Abbreviations used: 'T' = tetra; 'Pe' = penta; 'Hx' = hexa; 'Hp' = hepta; 'O' = octa; 'CDD' = chlorodibenzodioxin; 'CDF' = chlorodibenzofuran; 'CB' = chlorobiphenyl.

- (32) Upperbound concentrations: Upperbound concentrations are calculated on the assumption that all the values of the different congeners below the limit of quantification are equal to the limit of quantification.
- (33) The maximum level is not applicable for foods containing < 1 % fat.
- (34) Foodstuffs listed in this category as defined in categories (a), (b), (c), (e) and (f) of the list in Article 1 of Regulation (EC) No 104/2000 with the exclusion of fish liver falling under code CN 0302 70 00.
- (35) Benzo(a)pyrene, for which maximum levels are listed, is used as a marker for the occurrence and effect of carcinogenic polycyclic aromatic hydrocarbons. These measures therefore provide full harmonisation on polycyclic aromatic hydrocarbons in the listed foods across the Member States.
- (36) Foodstuffs listed in this category as defined in categories (b), (c), and (f) of the list in Article 1 of Regulation (EC) No 104/2000.

Annex III:

Official Journal of the European Union

**COMMISSION REGULATION (EC) No 333/2007
of 28 March 2007**

**laying down the methods of sampling and analysis for the official control of the levels of lead,
cadmium, mercury, inorganic tin, 3-MCPD and benzo(a)pyrene in foodstuffs**

COMMISSION REGULATION (EC) No 333/2007**of 28 March 2007****laying down the methods of sampling and analysis for the official control of the levels of lead, cadmium, mercury, inorganic tin, 3-MCPD and benzo(a)pyrene in foodstuffs****(Text with EEA relevance)**

THE COMMISSION OF THE EUROPEAN COMMUNITIES,

Having regard to the Treaty establishing the European Community,

Having regard to Regulation (EC) No 882/2004 of the European Parliament and of the Council of 29 April 2004 on official controls performed to ensure the verification of compliance with feed and food law, animal health and animal welfare rules ⁽¹⁾, in particular Article 11(4) thereof,

Whereas:

(1) Council Regulation (EEC) No 315/93 of 8 February 1993 laying down Community procedures for contaminants in food ⁽²⁾ provides that maximum levels must be set for certain contaminants in foodstuffs in order to protect public health.

(2) Commission Regulation (EC) No 1881/2006 of 19 December 2006 setting maximum levels for certain contaminants in foodstuffs ⁽³⁾ establishes maximum levels for lead, cadmium, mercury, inorganic tin, 3-MCPD and benzo(a)pyrene in certain foodstuffs.

(3) Regulation (EC) No 882/2004 lays down general principles for the official control of foodstuffs. However, in certain cases more specific provisions are necessary to ensure that official controls are performed in a harmonised manner in the Community.

(4) The methods of sampling and analysis to be used for the official control of levels of lead, cadmium, mercury, 3-MCPD, inorganic tin and benzo(a)pyrene in certain foodstuffs are established in Commission Directive 2001/22/EC of 8 March 2001 laying down the sampling methods and the methods of analysis for the

official control of the levels of lead, cadmium, mercury and 3-MCPD in foodstuffs ⁽⁴⁾, Commission Directive 2004/16/EC of 12 February 2004 laying down the sampling methods and the methods of analysis for the official control of the levels of tin in canned foods ⁽⁵⁾ and Commission Directive 2005/10/EC of 4 February 2005 laying down the sampling methods and the methods of analysis for the official control of the levels of benzo(a)pyrene in foodstuffs ⁽⁶⁾, respectively.

(5) Numerous provisions on sampling and analysis for the official control of the levels of lead, cadmium, mercury, inorganic tin, 3-MCPD and benzo(a)pyrene in foodstuffs are similar. Therefore, in the interest of clarity of legislation, it is appropriate to merge those provisions in one single legislative act.

(6) Directives 2001/22/EC, 2004/16/EC and 2005/10/EC should therefore be repealed and replaced by a new Regulation.

(7) The measures provided for in this Regulation are in accordance with the opinion of the Standing Committee for the Food Chain and Animal Health,

HAS ADOPTED THIS REGULATION:

Article 1

1. Sampling and analysis for the official control of the levels of lead, cadmium, mercury, inorganic tin, 3-MCPD and benzo(a)pyrene listed in sections 3, 4 and 6 of the Annex to Regulation (EC) No 1881/2006 shall be carried out in accordance with the Annex to this Regulation.

2. Paragraph 1 shall apply without prejudice to the provisions of Regulation (EC) No 882/2004.

⁽¹⁾ OJ L 165, 30.4.2004, p. 1, corrected by OJ L 191, 28.5.2004, p. 1. Regulation as amended by Commission Regulation (EC) No 1791/2006 (OJ L 363, 20.12.2006, p. 1).

⁽²⁾ OJ L 37, 13.2.1993, p. 1. Regulation as amended by Regulation (EC) No 1882/2003 of the European Parliament and of the Council (OJ L 284, 31.10.2003, p. 1).

⁽³⁾ OJ L 364, 20.12.2006, p. 5.

⁽⁴⁾ OJ L 77, 16.3.2001, p. 14. Directive as last amended by Directive 2005/4/EC (OJ L 19, 21.1.2005, p. 50).

⁽⁵⁾ OJ L 42, 13.2.2004, p. 16.

⁽⁶⁾ OJ L 34, 8.2.2005, p. 15.

Article 2

Directives 2001/22/EC, 2004/16/EC and 2005/10/EC are hereby repealed.

References to the repealed Directives shall be construed as references to this Regulation.

Article 3

This Regulation shall enter into force on the 20th day following its publication in the *Official Journal of the European Union*.

It shall apply from 1 June 2007.

This Regulation shall be binding in its entirety and directly applicable in all Member States.

Done at Brussels, 28 March 2007.

For the Commission
Markos KYPRIANOU
Member of the Commission

ANNEX

PART A

DEFINITIONS

For the purposes of this Annex, the following definitions shall apply:

- 'lot': an identifiable quantity of food delivered at one time and determined by the official to have common characteristics, (such as origin, variety, type of packing, packer, consignor or markings). In the case of fish, also the size of fish shall be comparable;
- 'sublot': designated part of a large lot in order to apply the sampling method on that designated part. Each sublot must be physically separated and identifiable;
- 'incremental sample': a quantity of material taken from a single place in the lot or sublot;
- 'aggregate sample': the combined total of all the incremental samples taken from the lot or sublot; aggregate samples shall be considered as representative of the lots or sublots from which they are taken;
- 'laboratory sample': a sample intended for the laboratory.

PART B

SAMPLING METHODS**B.1. GENERAL PROVISIONS****B.1.1. Personnel**

Sampling shall be performed by an authorised person as designated by the Member State.

B.1.2. Material to be sampled

Each lot or sublot which is to be examined shall be sampled separately.

B.1.3. Precautions to be taken

In the course of sampling, precautions shall be taken to avoid any changes which would affect the levels of contaminants, adversely affect the analytical determination or make the aggregate samples unrepresentative.

B.1.4. Incremental samples

As far as possible, incremental samples shall be taken at various places distributed throughout the lot or sublot. Departure from such procedure shall be recorded in the record provided for under point B.1.8. of this Annex.

B.1.5. Preparation of the aggregate sample

The aggregate sample shall be made up by combining the incremental samples.

B.1.6. Samples for enforcement, defence and referee purposes

The samples for enforcement, defence and referee purposes shall be taken from the homogenised aggregate sample unless this conflicts with the rules of the Member States as regards the rights of the food business operator.

B.1.7. Packaging and transmission of samples

Each sample shall be placed in a clean, inert container offering adequate protection from contamination, from loss of analytes by adsorption to the internal wall of the container and against damage in transit. All necessary precautions shall be taken to avoid any change in composition of the sample which might arise during transportation or storage.

B.1.8. Sealing and labelling of samples

Each sample taken for official use shall be sealed at the place of sampling and identified following the rules of the Member States.

A record shall be kept of each sampling, permitting each lot or subplot to be identified unambiguously (reference to the lot number shall be given) and giving the date and place of sampling together with any additional information likely to be of assistance to the analyst.

B.2. SAMPLING PLANS

Large lots shall be divided into sublots on condition that the subplot may be separated physically. For products traded in bulk consignments (e.g. cereals), Table 1 shall apply. For other products Table 2 shall apply. Taking into account that the weight of the lot is not always an exact multiple of the weight of the sublots, the weight of the subplot may exceed the mentioned weight by a maximum of 20 %.

The aggregate sample shall be at least 1 kg or 1 litre except where it is not possible e.g. when the sample consists of 1 package or unit.

The minimum number of incremental samples to be taken from the lot or subplot shall be as given in Table 3.

In the case of bulk liquid products the lot or subplot shall be thoroughly mixed in so far as possible and in so far it does not affect the quality of the product, by either manual or mechanical means immediately prior to sampling. In this case, a homogeneous distribution of contaminants is assumed within a given lot or subplot. It is therefore sufficient to take three incremental samples from a lot or subplot to form the aggregate sample.

The incremental samples shall be of similar weight. The weight of an incremental sample shall be at least 100 grams or 100 millilitres, resulting in an aggregate sample of at least about 1 kg or 1 litre. Departure from this method shall be recorded in the record provided for under point B.1.8. of this Annex.

Table 1

Subdivision of lots into sublots for products traded in bulk consignments

Lot weight (ton)	Weight or number of sublots
≥ 1 500	500 tonnes
> 300 and < 1 500	3 sublots
≥ 100 and ≤ 300	100 tonnes
< 100	—

Table 2

Subdivision of lots into sublots for other products

Lot weight (ton)	Weight or number of sublots
≥ 15	15 to 30 tonnes
< 15	—

Table 3

Minimum number of incremental samples to be taken from the lot or subplot

Weight or volume of lot/sublot (in kg or litre)	Minimum number of incremental samples to be taken
< 50	3
≥ 50 and ≤ 500	5
> 500	10

If the lot or subplot consists of individual packages or units, then the number of packages or units which shall be taken to form the aggregate sample is given in Table 4.

Table 4

Number of packages or units (incremental samples) which shall be taken to form the aggregate sample if the lot or subplot consists of individual packages or units

Number of packages or units in the lot/sublot	Number of packages or units to be taken
≤ 25	at least one package or unit
26 to 100	about 5 %, at least two packages or units
> 100	about 5 %, at maximum 10 packages or units

The maximum levels for inorganic tin apply to the contents of each can, but for practical reasons it is necessary to use an aggregate sampling approach. If the result of the test for an aggregate sample of cans is less than, but close to, the maximum level of inorganic tin and if it is suspected that individual cans might exceed the maximum level, then it might be necessary to conduct further investigations.

B.3. SAMPLING AT RETAIL STAGE

Sampling of foodstuffs at retail stage shall be done where possible in accordance with the sampling provisions set out in points B.1. and B.2. of this Annex.

Where this is not possible, an alternative method of sampling at retail stage may be used provided that it ensures sufficient representativeness for the sampled lot or subplot.

PART C**SAMPLE PREPARATION AND ANALYSIS****C.1. LABORATORY QUALITY STANDARDS**

Laboratories shall comply with the provisions of Article 12 of Regulation (EC) No 882/2004 ⁽¹⁾.

Laboratories shall participate in appropriate proficiency testing schemes which comply with the 'International Harmonised Protocol for the Proficiency Testing of (Chemical) Analytical Laboratories' ⁽²⁾ developed under the auspices of IUPAC/ISO/AOAC.

Laboratories shall be able to demonstrate that they have internal quality control procedures in place. Examples of these are the 'ISO/AOAC/IUPAC Guidelines on Internal Quality Control in Analytical Chemistry Laboratories' ⁽³⁾.

⁽¹⁾ As amended by Article 18 of Commission Regulation (EC) No 2076/2005 (OJ L 338, 22.12.2005, p. 83).

⁽²⁾ The international harmonized protocol for the proficiency testing of analytical chemistry laboratories' by M. Thompson, S.L.R. Ellison and R. Wood, Pure Appl. Chem., 2006, 78, 145-96.

⁽³⁾ Edited by M. Thompson and R. Wood, Pure Appl. Chem., 1995, 67, 649-666.

Wherever possible the trueness of analysis shall be estimated by including suitable certified reference materials in the analysis.

C.2. SAMPLE PREPARATION

C.2.1. Precautions and general considerations

The basic requirement is to obtain a representative and homogeneous laboratory sample without introducing secondary contamination.

All of the sample material received by the laboratory shall be used for the preparation of the laboratory sample.

Compliance with maximum levels laid down in Regulation (EC) No 1881/2006 shall be established on the basis of the levels determined in the laboratory samples.

C.2.2. Specific sample preparation procedures

C.2.2.1. Specific procedures for lead, cadmium, mercury and inorganic tin

The analyst shall ensure that samples do not become contaminated during sample preparation. Wherever possible, apparatus and equipment coming into contact with the sample shall not contain those metals to be determined and be made of inert materials e.g. plastics such as polypropylene, polytetrafluoroethylene (PTFE) etc. These should be acid cleaned to minimise the risk of contamination. High quality stainless steel may be used for cutting edges.

There are many satisfactory specific sample preparation procedures which may be used for the products under consideration. Those described in the CEN Standard 'Foodstuffs — Determination of trace elements — Performance criteria, general considerations and sample preparation' ⁽¹⁾ have been found to be satisfactory but others may be equally valid.

In the case of inorganic tin, care shall be taken to ensure that all the material is taken into solution as losses are known to occur readily, particularly because of hydrolysis to insoluble hydrated Sn(IV) oxide species.

C.2.2.2. Specific procedures for benzo(a)pyrene

The analyst shall ensure that samples do not become contaminated during sample preparation. Containers shall be rinsed with high purity acetone or hexane before use to minimise the risk of contamination. Wherever possible, apparatus and equipment coming into contact with the sample shall be made of inert materials such as aluminium, glass or polished stainless steel. Plastics such as polypropylene or PTFE shall be avoided because the analyte can adsorb onto these materials.

C.2.3. Treatment of the sample as received in the laboratory

The complete aggregate sample shall be finely ground (where relevant) and thoroughly mixed using a process that has been demonstrated to achieve complete homogenisation.

C.2.4. Samples for enforcement, defence and referee purposes

The samples for enforcement, defence and referee purposes shall be taken from the homogenised material unless this conflicts with the rules of the Member States on sampling as regards the rights of the food business operator.

⁽¹⁾ Standard EN 13804:2002, 'Foodstuffs — Determination of trace elements — Performance criteria, general considerations and sample preparation', CEN, Rue de Stassart 36, B-1050 Brussels.

C.3. METHODS OF ANALYSIS

C.3.1. Definitions

The following definitions shall apply:

- 'r' = Repeatability the value below which the absolute difference between single test results obtained under repeatability conditions (i.e., same sample, same operator, same apparatus, same laboratory, and short interval of time) may be expected to lie within a specific probability (typically 95 %) and hence $r = 2,8 \times s_r$.
- 's_r' = Standard deviation calculated from results generated under repeatability conditions.
- 'RSD_r' = Relative standard deviation calculated from results generated under repeatability conditions $[(s_r/\bar{x}) \times 100]$.
- 'R' = Reproducibility the value below which the absolute difference between single test results obtained under reproducibility conditions (i.e., on identical material obtained by operators in different laboratories, using the standardised test method), may be expected to lie within a certain probability (typically 95 %); $R = 2,8 \times s_R$.
- 's_R' = Standard deviation, calculated from results under reproducibility conditions.
- 'RSD_R' = Relative standard deviation calculated from results generated under reproducibility conditions $[(s_R/\bar{x}) \times 100]$.
- 'LOD' = Limit of detection, smallest measured content, from which it is possible to deduce the presence of the analyte with reasonable statistical certainty. The limit of detection is numerically equal to three times the standard deviation of the mean of blank determinations ($n > 20$).
- 'LOQ' = Limit of quantification, lowest content of the analyte which can be measured with reasonable statistical certainty. If both accuracy and precision are constant over a concentration range around the limit of detection, then the limit of quantification is numerically equal to six or 10 times the standard deviation of the mean of blank determinations ($n > 20$).
- 'HORRAT_r' = The observed RSD_r divided by the RSD_r value estimated from the Horwitz equation ⁽¹⁾ using the assumption $r = 0,66R$.
- 'HORRAT_R' = The observed RSD_R value divided by the RSD_R value calculated from the Horwitz equation.
- 'u' = Standard measurement uncertainty.
- 'U' = The expanded measurement uncertainty, using a coverage factor of 2 which gives a level of confidence of approximately 95 % ($U = 2u$).
- 'U_f' = Maximum standard measurement uncertainty.

C.3.2. General requirements

Methods of analysis used for food control purposes shall comply with the provisions of points 1 and 2 of Annex III to Regulation (EC) No 882/2004.

Methods of analysis for total tin are appropriate for official control on inorganic tin levels.

For the analysis of lead in wine, Commission Regulation (EEC) No 2676/90 ⁽²⁾ lays down the method to be used in chapter 35 of its Annex.

C.3.3. Specific requirements

C.3.3.1. Performance criteria

Where no specific methods for the determination of contaminants in foodstuffs are prescribed at Community level, laboratories may select any validated method of analysis (where possible, the validation shall include a certified reference material) provided the selected method meets the specific performance criteria set out in Tables 5 to 7.

⁽¹⁾ M. Thompson, Analyst, 2000, 125, 385-386.

⁽²⁾ OJ L 272, 3.10.1990, p. 1. Regulation as last amended by Regulation (EC) No 1293/2005 (OJ L 205, 6.8.2005, p. 12).

Table 5

Performance criteria for methods of analysis for lead, cadmium, mercury and inorganic tin

Parameter	Value/Comment
Applicability	Foods specified in Regulation (EC) No 1881/2006
LOD	For inorganic tin less than 5 mg/kg. For other elements less than one tenth of the maximum level in Regulation (EC) No 1881/2006, except if the maximum level for lead is less than 100 µg/kg. For the latter, less than one fifth of the maximum level
LOQ	For inorganic tin less than 10 mg/kg. For other elements less than one fifth of the maximum level in Regulation (EC) No 1881/2006, except if the maximum level for lead is less than 100 µg/kg. For the latter, less than two fifth of the maximum level
Precision	HORRAT _r or HORRAT _R values of less than 2
Recovery	The provisions of point D.1.2. apply
Specificity	Free from matrix or spectral interferences

Table 6

Performance criteria for methods of analysis for 3-MCPD

Criterion	Recommended Value	Concentration
Field blanks	Less than the LOD	—
Recovery	75 to 110 %	all
LOD	5 µg/kg (or less) on a dry matter basis	
LOQ	10 µg/kg (or less) on a dry matter basis	—
Precision	< 4 µg/kg	20 µg/kg
	< 6 µg/kg	30 µg/kg
	< 7 µg/kg	40 µg/kg
	< 8 µg/kg	50 µg/kg
	< 15 µg/kg	100 µg/kg

Table 7

Performance criteria for methods of analysis for benzo(a)pyrene

Parameter	Value/Comment
Applicability	Foods specified in Regulation (EC) No 1881/2006
LOD	Less than 0,3 µg/kg
LOQ	Less than 0,9 µg/kg
Precision	HORRAT _r or HORRAT _R values of less than 2
Recovery	50 to 120 %
Specificity	Free from matrix or spectral interferences, verification of positive detection

C.3.3.2. 'Fitness-for-purpose' approach

Where a limited number of fully validated methods of analysis exist, alternatively, a 'fitness-for-purpose' approach may be used to assess the suitability of the method of analysis. Methods suitable for official control must produce results with standard measurement uncertainties less than the maximum standard measurement uncertainty calculated using the formula below:

$$U_f = \sqrt{(\text{LOD}/2)^2 + (\alpha C)^2}$$

where:

U_f is the maximum standard measurement uncertainty ($\mu\text{g}/\text{kg}$);

LOD is the limit of detection of the method ($\mu\text{g}/\text{kg}$);

C is the concentration of interest ($\mu\text{g}/\text{kg}$);

α is a numeric factor to be used depending on the value of C . The values to be used are given in Table 8.

Table 8

Numeric values to be used for α as constant in formula set out in this point, depending on the concentration of interest

C ($\mu\text{g}/\text{kg}$)	α
≤ 50	0,2
51 to 500	0,18
501 to 1 000	0,15
1 001 to 10 000	0,12
$> 10\ 000$	0,1

PART D

REPORTING AND INTERPRETATION OF RESULTS

D.1. REPORTING

D.1.1. Expression of results

The results shall be expressed in the same units and with the same number of significant figures as the maximum levels laid down in Regulation (EC) No 1881/2006.

D.1.2. Recovery calculations

If an extraction step is applied in the analytical method, the analytical result shall be corrected for recovery. In this case the level of recovery must be reported.

In case no extraction step is applied in the analytical method (e.g. in case of metals), the result may be reported uncorrected for recovery if evidence is provided by ideally making use of suitable certified reference material that the certified concentration allowing for the measurement uncertainty is achieved (i.e. high accuracy of the measurement). In case the result is reported uncorrected for recovery this shall be mentioned.

D.1.3. Measurement uncertainty

The analytical result shall be reported as $x \pm U$ whereby x is the analytical result and U is the expanded measurement uncertainty, using a coverage factor of 2 which gives a level of confidence of approximately 95 % ($U = 2u$).

The analyst shall note the 'Report on the relationship between analytical results, measurement uncertainty, recovery factors and the provisions in EU food and feed legislation' ⁽¹⁾.

D.2. INTERPRETATION OF RESULTS**D.2.1. Acceptance of a lot/sublot**

The lot or subplot is accepted if the analytical result of the laboratory sample does not exceed the respective maximum level as laid down in Regulation (EC) No 1881/2006 taking into account the expanded measurement uncertainty and correction of the result for recovery if an extraction step has been applied in the analytical method used.

D.2.2. Rejection of a lot/sublot

The lot or subplot is rejected if the analytical result of the laboratory sample exceeds beyond reasonable doubt the respective maximum level as laid down in Regulation (EC) No 1881/2006 taking into account the expanded measurement uncertainty and correction of the result for recovery if an extraction step has been applied in the analytical method used.

D.2.3. Applicability

The present interpretation rules shall apply for the analytical result obtained on the sample for enforcement. In case of analysis for defence or reference purposes, the national rules shall apply.

⁽¹⁾ http://europa.eu.int/comm/food/food/chemicalsafety/contaminants/sampling_en.htm

Annex IV:

Official Journal of the European Union

**COMMISSION REGULATION (EU) No 836/2011
of 19 August 2011**

**amending Regulation (EC) No 333/2007 laying down the methods of sampling and analysis for
the official control of the levels of lead, cadmium, mercury, inorganic tin, 3-MCPD and
benzo(a)pyrene in foodstuffs**

COMMISSION REGULATION (EU) No 836/2011

of 19 August 2011

amending Regulation (EC) No 333/2007 laying down the methods of sampling and analysis for the official control of the levels of lead, cadmium, mercury, inorganic tin, 3-MCPD and benzo(a)pyrene in foodstuffs

(Text with EEA relevance)

THE EUROPEAN COMMISSION,

Having regard to the Treaty on the Functioning of the European Union,

Having regard to Regulation (EC) No 882/2004 of the European Parliament and of the Council of 29 April 2004 on official controls performed to ensure the verification of compliance with feed and food law, animal health and animal welfare rules ⁽¹⁾, in particular Article 11(4) thereof,

Whereas:

(1) Commission Regulation (EC) No 1881/2006 of 19 December 2006 setting maximum levels for certain contaminants in foodstuffs ⁽²⁾ established, inter alia, maximum levels for the contaminant benzo(a)pyrene.

(2) The Scientific Panel on Contaminants in the Food Chain of the European Food Safety Authority (EFSA) adopted an opinion on Polycyclic Aromatic Hydrocarbons in Food on 9 June 2008 ⁽³⁾. The EFSA concluded that benzo(a)pyrene is not a suitable marker for the occurrence of polycyclic aromatic hydrocarbons (PAH) in food and that a system of four specific substances or eight specific substances would be the most suitable markers of PAH in food. The EFSA also concluded that a system of eight substances would not provide much added value compared to a system of four substances.

(3) As a consequence Commission Regulation (EU) No 835/2011 ⁽⁴⁾ amended Regulation (EC) No 1881/2006 in order to set maximum levels for the sum of four polycyclic aromatic hydrocarbons (benzo(a)pyrene, benz(a)anthracene, benzo(b)fluoranthene and chrysene).

(4) Commission Regulation (EC) No 333/2007 ⁽⁵⁾ lays down analytical performance criteria only for benzo(a)pyrene. It is therefore necessary to lay down analytical performance criteria for the other three substances for which maximum levels are now set out in Regulation (EC) No 1881/2006.

(5) The European Union Reference Laboratory for Polycyclic Aromatic Hydrocarbons (EU-RL PAH) in collaboration with the national reference laboratories carried out a survey among official control laboratories to assess which analytical performance criteria would be achievable for benzo(a)pyrene, benz(a)anthracene, benzo(b)fluoranthene and chrysene in relevant food matrices. The outcome of this survey was summarised by the EU-RL PAH in the Report on 'Performance characteristics of analysis methods for the determination of 4 polycyclic aromatic hydrocarbons in food' ⁽⁶⁾. The results of the survey show that the analytical performance criteria currently applicable to benzo(a)pyrene are also suitable for the other three substances.

(6) Experience acquired while implementing Regulation (EC) No 333/2007 revealed that in some cases the current sampling provisions may be impracticable or may lead to unacceptable economic damage to the sampled lot. For such cases, departure from the sampling procedures should be allowed, provided that sampling remains sufficiently representative of the sampled lot or subplot and that the procedure used is fully documented. For sampling at the retail stage, flexibility to depart from the sampling procedures existed already. The provisions for sampling at retail stage should be aligned with the general sampling procedures.

(7) More detailed provisions are needed as regards the material of sampling containers when samples are taken for PAH analysis. Plastic containers are widely used by enforcement authorities, but they are not suitable when sampling is carried out for PAH analysis, as the PAH content of the sample can be altered by these materials.

(8) Clarification is needed for some aspects of the specific requirements for analytical methods, in particular the requirements regarding the use of the performance criteria and the 'fitness-for-purpose' approach. Furthermore, the presentation of the tables with the performance criteria should be modified to appear more uniform across all analytes.

(9) Regulation (EC) No 333/2007 should therefore be amended accordingly. Since Regulation (EU) No 835/2011 and this Regulation are inter-linked, both Regulations should become applicable on the same date.

⁽¹⁾ OJ L 165, 30.4.2004, p. 1.

⁽²⁾ OJ L 364, 20.12.2006, p. 5.

⁽³⁾ The EFSA Journal (2008) 724, p. 1.

⁽⁴⁾ See page 4 of this Official Journal.

⁽⁵⁾ OJ L 88, 29.3.2007, p. 29.

⁽⁶⁾ JRC Report 59046, 2010.

(10) The measures provided for in this Regulation are in accordance with the opinion of the Standing Committee on the Food Chain and Animal Health and neither the European Parliament nor the Council have opposed them,

HAS ADOPTED THIS REGULATION:

Article 1

Regulation (EC) No 333/2007 is amended as follows:

(1) the title is replaced by the following:

'Commission Regulation (EC) No 333/2007 of 28 March 2007 laying down the methods of sampling and analysis for the official control of the levels of lead, cadmium, mercury, inorganic tin, 3-MCPD and polycyclic aromatic hydrocarbons in foodstuffs';

(2) in Article 1, paragraph 1 is replaced by the following:

'1. Sampling and analysis for the official control of the levels of lead, cadmium, mercury, inorganic tin, 3-MCPD and polycyclic aromatic hydrocarbons ("PAH") listed in Sections 3, 4 and 6 of the Annex to Regulation (EC) No 1881/2006 shall be carried out in accordance with the Annex to this Regulation.';

(3) the Annex is amended in accordance with the Annex to this Regulation.

Article 2

This Regulation shall enter into force on the 20th day following its publication in the *Official Journal of the European Union*.

It shall apply from 1 September 2012.

This Regulation shall be binding in its entirety and directly applicable in all Member States.

Done at Brussels, 19 August 2011.

For the Commission

The President

José Manuel BARROSO

ANNEX

The Annex to Regulation (EC) No 333/2007 is amended as follows:

- (1) in point B.1.7 'Packaging and transmission of samples', the following second paragraph is added:

'In case of sampling for PAH analysis plastic containers shall be avoided if possible as they could alter the PAH content of the sample. Inert, PAH-free glass containers, adequately protecting the sample from light, shall be used wherever possible. Where this is practically impossible, at least direct contact of the sample with plastics shall be avoided, e.g. in case of solid samples by wrapping the sample in aluminium foil before placing it in the sampling container.';

- (2) points B.2 and B.3 are replaced by the following:

B.2. SAMPLING PLANS

B.2.1. Division of lots into sublots

Large lots shall be divided into sublots on condition that the subplot may be separated physically. For products traded in bulk consignments (e.g. cereals) Table 1 shall apply. For other products Table 2 shall apply. Taking into account that the weight of the lot is not always an exact multiple of the weight of the sublots, the weight of the subplot may exceed the mentioned weight by a maximum of 20 %.

B.2.2. Number of incremental samples

The aggregate sample shall be at least 1 kg or 1 litre except where it is not possible, e.g. when the sample consists of 1 package or unit.

The minimum number of incremental samples to be taken from the lot or subplot shall be as given in Table 3.

In the case of bulk liquid products the lot or subplot shall be thoroughly mixed in so far as possible and in so far it does not affect the quality of the product, by either manual or mechanical means immediately prior to sampling. In this case, a homogeneous distribution of contaminants is assumed within a given lot or subplot. It is therefore sufficient to take three incremental samples from a lot or subplot to form the aggregate sample.

The incremental samples shall be of similar weight/volume. The weight/volume of an incremental sample shall be at least 100 grams or 100 millilitres, resulting in an aggregate sample of at least about 1 kg or 1 litre. Departure from this method shall be recorded in the record provided for under point B.1.8 of this Annex.

Table 1

Subdivision of lots into sublots for products traded in bulk consignments

Lot weight (ton)	Weight or number of sublots
≥ 1 500	500 tonnes
> 300 and < 1 500	3 sublots
≥ 100 and ≤ 300	100 tonnes
< 100	—

Table 2

Subdivision of lots into sublots for other products

Lot weight (ton)	Weight or number of sublots
≥ 15	15-30 tonnes
< 15	—

Table 3

Minimum number of incremental samples to be taken from the lot or subplot

Weight or volume of lot/sublot (in kg or litre)	Minimum number of incremental samples to be taken
< 50	3
≥ 50 and ≤ 500	5
> 500	10

If the lot or subplot consists of individual packages or units, then the number of packages or units which shall be taken to form the aggregate sample is given in Table 4.

Table 4

Number of packages or units (incremental samples) which shall be taken to form the aggregate sample if the lot or subplot consists of individual packages or units

Number of packages or units in the lot/sublot	Number of packages or units to be taken
≤ 25	at least 1 package or unit
26-100	about 5 %, at least 2 packages or units
> 100	about 5 %, at maximum 10 packages or units

The maximum levels for inorganic tin apply to the contents of each can, but for practical reasons it is necessary to use an aggregate sampling approach. If the result of the test for an aggregate sample of cans is less than but close to the maximum level of inorganic tin and if it is suspected that individual cans might exceed the maximum level, then it might be necessary to conduct further investigations.

Where it is not possible to carry out the method of sampling set out in this chapter because of the unacceptable commercial consequences (e.g. because of packaging forms, damage to the lot, etc.) or where it is practically impossible to apply the abovementioned method of sampling, an alternative method of sampling may be applied provided that it is sufficiently representative for the sampled lot or subplot and is fully documented.

B.2.3. Specific provisions for the sampling of large fish arriving in large lots

In case the lot or subplot to be sampled contains large fishes (individual fishes weighing more than about 1 kg) and the lot or subplot weighs more than 500 kg, the incremental sample shall consist of the middle part of the fish. Each incremental sample shall weigh at least 100 g.

B.3. SAMPLING AT RETAIL STAGE

Sampling of foodstuffs at retail stage shall be done where possible in accordance with the sampling provisions set out in point B.2.2 of this Annex.

Where it is not possible to carry out the method of sampling set out in point B.2.2 because of the unacceptable commercial consequences (e.g. because of packaging forms, damage to the lot, etc.) or where it is practically impossible to apply the abovementioned method of sampling, an alternative method of sampling may be applied provided that it is sufficiently representative for the sampled lot or subplot and is fully documented.;

- (3) in the first paragraph of point C.1 'Laboratory Quality Standards', footnote 1 is deleted;
- (4) in point C.2.2.1 'Specific procedures for lead, cadmium, mercury and inorganic tin', the second paragraph is replaced by the following:

There are many satisfactory specific sample preparation procedures which may be used for the products under consideration. For those aspects not specifically covered by this Regulation, the CEN Standard "Foodstuffs - Determination of trace elements – Performance criteria, general considerations and sample preparation"⁽¹⁾ has been found to be satisfactory but other sample preparation methods may be equally valid.;

- (5) point C.2.2.2 is replaced by the following:

'C.2.2.2. Specific procedures for polycyclic aromatic hydrocarbons

The analyst shall ensure that samples do not become contaminated during sample preparation. Containers shall be rinsed with high purity acetone or hexane before use to minimise the risk of contamination. Wherever possible, apparatus and equipment coming into contact with the sample shall be made of inert materials such as aluminium, glass or polished stainless steel. Plastics such as polypropylene or PTFE shall be avoided because the analytes can adsorb onto these materials.;

(6) point C.3.1 'Definitions' is amended as follows:

(a) the definition for 'HORRAT_r' is replaced by the following:

'HORRAT (*)_r = The observed RSD_r divided by the RSD_r value estimated from the (modified) Horwitz equation (**) (cf. point C.3.3.1 ("Notes to the performance criteria")) using the assumption $r = 0,66 R$.

(*) Horwitz W. and Albert, R., 2006, The Horwitz Ratio (HorRat): A useful Index of Method Performance with respect to Precision, Journal of AOAC International, Vol. 89, 1095-1109.

(**) M. Thompson, Analyst, 2000, p. 125 and 385-386.'

(b) the definition for 'HORRAT_R' is replaced by the following:

'HORRAT (*)_R = The observed RSD_R divided by the RSD_R value estimated from the (modified) Horwitz equation (**) (cf. point C.3.3.1 ("Notes to the performance criteria")).

(*) Horwitz W. and Albert, R., 2006, The Horwitz Ratio (HorRat): A useful Index of Method Performance with respect to Precision, Journal of AOAC International, Vol. 89, 1095-1109.

(**) M. Thompson, Analyst, 2000, p. 125 and 385-386.'

(c) the definition for 'u' is replaced by the following:

'u = Combined standard measurement uncertainty obtained using the individual standard measurement uncertainties associated with the input quantities in a measurement model (*)

(*) International vocabulary of metrology – Basic and general concepts and associated terms (VIM), JCGM 200:2008.;

(7) point C.3.2 is replaced by the following:

'C.3.2 General requirements

Methods of analysis used for food control purposes shall comply with the provisions of Annex III to Regulation (EC) No 882/2004.

Methods for analysis for total tin are appropriate for official control on inorganic tin levels.

For the analysis of lead in wine, the methods and rules established by the OIV (*) apply in accordance with Article 31 of Council Regulation (EC) No 479/2008 (**).

(*) Organisation internationale de la vigne et du vin.

(**) Council Regulation (EC) No 479/2008 of 29 April 2008 on the common organisation of the market in wine amending Regulations (EC) No 1493/1999, (EC) No 1782/2003, (EC) No 1290/2005, (EC) No 3/2008 and repealing Regulations (EEC) No 2392/86 and (EC) No 1493/1999 (OJ L 148, 6.6.2008, p. 1).;

(8) point C.3.3.1 is replaced by the following:

'C.3.3.1. Performance criteria

Where no specific methods for the determination of contaminants in foodstuffs are prescribed at European Union level, laboratories may select any validated method of analysis for the respective matrix provided that the selected method meets the specific performance criteria set out in Tables 5, 6 and 7.

It is recommended that fully validated methods (i.e. methods validated by collaborative trial for the respective matrix) are used where appropriate and available. Other suitable validated methods (e.g. in-house validated methods for the respective matrix) may also be used provided that they fulfil the performance criteria set out in Tables 5, 6 and 7.

Where possible, the validation of in-house validated methods shall include a certified reference material.

- (a) Performance criteria for methods of analysis for lead, cadmium, mercury and inorganic tin:

Table 5

Parameter	Criterion		
Applicability	Foods specified in Regulation (EC) No 1881/2006		
Specificity	Free from matrix or spectral interferences		
Repeatability (RSD _r)	HORRAT _r less than 2		
Reproducibility (RSD _R)	HORRAT _R less than 2		
Recovery	The provisions of point D.1.2 apply		
	Inorganic tin	Lead, cadmium, mercury	
		ML is < 0,100 mg/kg	ML is ≥ 0,100 mg/kg
LOD	≤ 5 mg/kg	≤ one fifth of the ML	≤ one tenth of the ML
LOQ	≤ 10 mg/kg	≤ two fifths of the ML	≤ one fifth of the ML

- (b) Performance criteria for methods of analysis for 3-MCPD:

Table 6

Parameter	Criterion
Applicability	Foods specified in Regulation (EC) No 1881/2006
Specificity	Free from matrix or spectral interferences
Field blanks	Less than LOD
Repeatability (RSD _r)	0,66 times RSD _R as derived from (modified) Horwitz equation
Reproducibility (RSD _R)	as derived from (modified) Horwitz equation
Recovery	75-110 %
LOD	≤ 5 µg/kg (on dry matter basis)
LOQ	≤ 10 µg/kg (on dry matter basis)

- (c) Performance criteria for methods of analysis for polycyclic aromatic hydrocarbons:

The four polycyclic aromatic hydrocarbons to which these criteria apply are benzo(a)pyrene, benz(a)anthracene, benzo(b)fluoranthene and chrysene.

Table 7

Parameter	Criterion
Applicability	Foods specified in Regulation (EC) No 1881/2006
Specificity	Free from matrix or spectral interferences, verification of positive detection
Repeatability (RSD _r)	HORRAT _r less than 2
Reproducibility (RSD _R)	HORRAT _R less than 2

Parameter	Criterion
Recovery	50-120 %
LOD	≤ 0,30 µg/kg for each of the four substances
LOQ	≤ 0,90 µg/kg for each of the four substances

(d) Notes to the performance criteria:

The Horwitz equation (*) (for concentrations $1,2 \times 10^{-7} \leq C \leq 0,138$) and the modified Horwitz equation (**) (for concentrations $C < 1,2 \times 10^{-7}$) are generalised precision equations which are independent of analyte and matrix but solely dependent on concentration for most routine methods of analysis.

Modified Horwitz equation for concentrations $C < 1,2 \times 10^{-7}$:

$$RSD_R = 22 \%$$

where:

- RSD_R is the relative standard deviation calculated from results generated under reproducibility conditions $[(s_R / \bar{x}) \times 100]$
- C is the concentration ratio (i.e. 1 = 100 g/100 g, 0,001 = 1 000 mg/kg). The modified Horwitz equation applies to concentrations $C < 1,2 \times 10^{-7}$.

Horwitz equation for concentrations $1,2 \times 10^{-7} \leq C \leq 0,138$:

$$RSD_R = 2C^{(-0,15)}$$

where:

- RSD_R is the relative standard deviation calculated from results generated under reproducibility conditions $[(s_R / \bar{x}) \times 100]$
- C is the concentration ratio (i.e. 1 = 100 g/100 g, 0,001 = 1 000 mg/kg). The Horwitz equation applies to concentrations $1,2 \times 10^{-7} \leq C \leq 0,138$.

(*) W. Horwitz, L.R. Kamps, K.W. Boyer, J.Assoc.Off.Analy.Chem.,1980, 63, 1344.

(**) M. Thompson, Analyst, 2000, p. 125 and 385-386.;

(9) point C.3.3.2 is replaced by the following:

'C.3.3.2. "Fitness-for-purpose" approach

For in-house validated methods, as an alternative a "fitness-for-purpose" approach (*) may be used to assess their suitability for official control. Methods suitable for official control must produce results with a combined standard measurement uncertainty (u) less than the maximum standard measurement uncertainty calculated using the formula below:

$$U_f = \sqrt{(LOD/2)^2 + (\alpha C)^2}$$

where:

- U_f is the maximum standard measurement uncertainty (µg/kg).
- LOD is the limit of detection of the method (µg/kg). The LOD must meet the performance criteria set in point C.3.3.1 for the concentration of interest.
- C is the concentration of interest (µg/kg);
- α is a numeric factor to be used depending on the value of C . The values to be used are given in Table 8.

Table 8

Numeric values to be used for α as constant in formula set out in this point, depending on the concentration of interest

C (µg/kg)	α
≤ 50	0,2
51-500	0,18

C (µg/kg)	α
501-1 000	0,15
1 001-10 000	0,12
> 10 000	0,1

The analyst shall note the "Report on the relationship between analytical results, measurement uncertainty, recovery factors and the provisions of EU food and feed legislation" (**).

(*) M. Thompson and R. Wood, Accred. Qual. Assur., 2006, p. 10 and 471-478.

(**) http://ec.europa.eu/food/food/chemicalsafety/contaminants/report-sampling_analysis_2004_en.pdf;

(10) in point D.1.2 'Recovery calculations', the second paragraph is replaced by the following:

'In case no extraction step is applied in the analytical method (e.g. in case of metals), the result may be reported uncorrected for recovery if evidence is provided by ideally making use of suitable certified reference material that the certified concentration allowing for the measurement uncertainty is achieved (i.e. high accuracy of the measurement), and thus that the method is not biased. In case the result is reported uncorrected for recovery this shall be mentioned.';

(11) in point D.1.3 'Measurement uncertainty', the second paragraph is replaced by the following:

'The analyst shall note the "Report on the relationship between analytical results, measurement uncertainty, recovery factors and the provisions of EU food and feed legislation" (*).

(*) http://ec.europa.eu/food/food/chemicalsafety/contaminants/report-sampling_analysis_2004_en.pdf.

Annex V:

Official Journal of the European Union

COMMISSION REGULATION (EU) No 2017/644

of 5 April 2017

laying down methods of sampling and analysis for the control of levels of dioxins, dioxin-like PCBs and non-dioxin-like PCBs in certain foodstuffs and repealing Regulation (EU)

No 589/2014

COMMISSION REGULATION (EU) 2017/644

of 5 April 2017

laying down methods of sampling and analysis for the control of levels of dioxins, dioxin-like PCBs and non-dioxin-like PCBs in certain foodstuffs and repealing Regulation (EU) No 589/2014

(Text with EEA relevance)

THE EUROPEAN COMMISSION,

Having regard to the Treaty on the Functioning of the European Union,

Having regard to Regulation (EC) No 882/2004 of the European Parliament and of the Council of 29 April 2004 on official controls performed to ensure the verification of compliance with feed and food law, animal health and animal welfare rules ⁽¹⁾, and in particular Article 11(4) thereof,

Whereas:

- (1) Commission Regulation (EC) No 1881/2006 ⁽²⁾ sets out the maximum levels for non-dioxin-like polychlorinated biphenyls (PCBs) dioxins and furans and for the sum of dioxins, furans and dioxin-like PCBs in certain foodstuffs.
- (2) Commission Recommendation 2013/711/EU ⁽³⁾ sets out action levels in order to stimulate a proactive approach to reduce the presence of polychlorinated dibenzo-para-dioxins and polychlorinated dibenzofurans (PCDD/Fs) and dioxin-like PCBs in food. Those action levels are a tool used by competent authorities and operators to highlight those cases where it is appropriate to identify a source of contamination and to take the necessary measures in order to reduce or eliminate it.
- (3) Commission Regulation (EC) No 589/2014 ⁽⁴⁾ establishes specific provisions concerning the sampling procedure and the methods of analysis to be applied for the official control of levels of dioxins, dioxin-like PCBs and non-dioxin-like PCBs.
- (4) The provisions laid down in this Regulation relate only to the sampling and analysis of dioxins, dioxin-like PCBs and non-dioxin-like PCBs for the implementation of Regulation (EC) No 1881/2006 and Recommendation 2013/711/EU. They do not affect the sampling strategy, sampling levels and frequency as set out in Annexes III and IV to Council Directive 96/23/EC ⁽⁵⁾. They do not affect the targeting criteria for sampling as laid down in Commission Decision 98/179/EC ⁽⁶⁾.
- (5) It is appropriate to ensure that food business operators applying the controls performed within the framework of Article 4 of Regulation (EC) No 852/2004 of the European Parliament and of the Council ⁽⁷⁾ apply sampling procedures equivalent to the sampling procedures provided for by this Regulation in order to ensure that samples taken for those controls are representative samples. Furthermore, the European Union Reference Laboratory for Dioxins and PCBs has provided evidence that analytical results in certain cases are not reliable when the performance criteria as provided in this Regulation are not applied by laboratories performing the analysis of samples taken by food business operators within the framework of Article 4 of Regulation (EC) No 852/2004. It is therefore appropriate to make the application of the performance criteria also obligatory for the analysis of those samples.

⁽¹⁾ OJ L 165, 30.4.2004, p. 1.⁽²⁾ Commission Regulation (EC) No 1881/2006 of 19 December 2006 setting maximum levels for certain contaminants in foodstuffs (OJ L 364, 20.12.2006, p. 5).⁽³⁾ Commission Recommendation 2013/711/EU of 3 December 2013 on the reduction of the presence of dioxins, furans and PCBs in feed and food (OJ L 323, 4.12.2013, p. 37).⁽⁴⁾ Commission Regulation (EU) No 589/2014 of 2 June 2014 laying down methods of sampling and analysis for the official control of levels of dioxins, dioxin-like PCBs and non-dioxin-like PCBs in certain foodstuffs and repealing Regulation (EU) No 252/2012 (OJ L 164, 3.6.2014, p. 18).⁽⁵⁾ Council Directive 96/23/EC of 29 April 1996 on measures to monitor certain substances and residues thereof in live animals and animal products and repealing Directives 85/358/EEC and 86/469/EEC and Decisions 89/187/EEC and 91/664/EEC (OJ L 125, 23.5.1996, p. 10).⁽⁶⁾ Commission Decision 98/179/EC of 23 February 1998 laying down detailed rules on official sampling for the monitoring of certain substances and residues thereof in live animals and animal products (OJ L 65, 5.3.1998, p. 31).⁽⁷⁾ Regulation (EC) No 852/2004 of the European Parliament and of the Council of 29 April 2004 on the hygiene of foodstuffs (OJ L 139, 30.4.2004, p. 1).

- (6) Given that the approach of the use of a decision limit to ensure that an analytical result is above the maximum level with a certain probability, as provided for in Commission Decision 2002/657/EC ⁽¹⁾, is no longer applied for the analysis of dioxins and PCBs in food, it is appropriate to delete this approach and to keep only the approach of the expanded uncertainty using the coverage factor of 2, giving a level confidence of approximately 95 %.
- (7) In line with the reporting requirements for bioanalytical screening methods, it is appropriate to also provide for physico-chemical methods used for screening specific reporting requirements.
- (8) Given that the analysis of dioxins, dioxin-like PCBs and non-dioxin-like PCBs are in most cases determined together it is appropriate to align the performance criteria for the non-dioxin-like PCBs to the performance criteria for dioxins and dioxin-like PCBs. This is a simplification, without substantial changes in practice as in the case of non-dioxin-like PCBs the relative intensity of qualifier ions compared to target ions is > 50 %.
- (9) Furthermore there are several other minor modifications proposed to the current provisions, requiring the repeal of Regulation (EU) No 589/2014 and its replacing by a new Regulation to maintain the readability of the text.
- (10) The measures provided for in this Regulation are in accordance with the opinion of the Standing Committee on Plants, Animals, Food and Feed,

HAS ADOPTED THIS REGULATION:

Article 1

For the purposes of this Regulation, the definitions and abbreviations set out in Annex I shall apply.

Article 2

Sampling for the official control of the levels of dioxins, furans, dioxin-like PCBs and non-dioxin-like PCBs in foodstuffs listed in Section 5 of the Annex to Regulation (EC) No 1881/2006 shall be carried out in accordance with the methods set out in Annex II to this Regulation.

Article 3

Sample preparation and analyses for the control of the levels of dioxins, furans and dioxin-like PCBs in foodstuffs listed in Section 5 of the Annex to Regulation (EC) No 1881/2006 shall be carried out in accordance with the methods set out in Annex III to this Regulation.

Article 4

Analyses for the control of the levels of non-dioxin-like PCBs in foodstuffs listed in Section 5 of the Annex to Regulation (EC) No 1881/2006 shall be carried out in accordance with the requirements for analytical procedures set out in Annex IV to this Regulation.

Article 5

Regulation (EU) No 589/2014 is repealed.

References to the repealed Regulation shall be construed as references to this Regulation.

⁽¹⁾ Commission Decision 2002/657/EC of 14 August 2002 implementing Council Directive 96/23/EC concerning the performance of analytical methods and the interpretation of results (OJ L 221, 17.8.2002, p. 8).

Article 6

This Regulation shall enter into force on the twentieth day following that of its publication in the *Official Journal of the European Union*.

This Regulation shall be binding in its entirety and directly applicable in all Member States.

Done at Brussels, 5 April 2017.

For the Commission
The President
Jean-Claude JUNCKER

ANNEX I

DEFINITIONS AND ABBREVIATIONS

I. DEFINITIONS

For the purposes of this Regulation the definitions laid down in Annex I to Decision 2002/657/EC shall apply.

Further to those definitions, the following definitions shall apply for the purposes of this Regulation:

- 1.1. 'Action level' means the level of a given substance, as laid down in the Annex to Recommendation 2013/711/EU, which triggers investigations to identify the source of that substance in cases where increased levels of the substance are detected.
- 1.2. 'Screening methods' means methods used for the selection of those samples with levels of PCDD/Fs and dioxin-like PCBs that exceed the maximum levels or the action levels. They shall allow for a cost-effective high sample-throughput, thus increasing the chance of discovering new cases where high exposure may lead to health risks for consumers. Screening methods shall be based on bioanalytical or GC-MS methods. Results from samples exceeding the cut-off value established to check compliance with the maximum level shall be verified by a full re-analysis from the original sample using a confirmatory method.
- 1.3. 'Confirmatory methods' means methods that provide full or complementary information enabling the PCDD/Fs and dioxin-like PCBs to be identified and quantified unequivocally at the maximum or, in case of need, at the action level. Such methods utilise gas chromatography/high resolution mass spectrometry (GC-HRMS) or gas chromatography/tandem mass spectrometry (GC-MS/MS).
- 1.4. 'Bioanalytical methods' means methods based on the use of biological principles such as cell-based assays, receptor-assays or immunoassays. They do not give results at the congener level but merely an indication ⁽¹⁾ of the TEQ level, expressed in Bioanalytical Equivalents (BEQ) to acknowledge the fact that not all compounds present in a sample extract that produce a response in the test may meet all requirements of the TEQ-principle.
- 1.5. 'Bioassay apparent recovery' means the BEQ level calculated from the TCDD or PCB 126 calibration curve corrected for the blank and then divided by the TEQ level determined by the confirmatory method. It attempts to correct factors like the loss of PCDD/Fs and dioxin-like compounds during the extraction and clean-up steps, co-extracted compounds increasing or decreasing the response (agonistic and antagonistic effects), the quality of the curve fit, or differences between the TEF and the REP values. The bioassay apparent recovery is calculated from suitable reference samples with representative congener patterns around the maximum or action level.
- 1.6. 'Duplicate analysis' means separate analysis of the analytes of interest using a second aliquot of the same homogenised sample.
- 1.7. 'Accepted specific limit of quantification ⁽²⁾ of an individual congener in a sample' means the lowest content of the analyte that can be measured with reasonable statistical certainty, fulfilling the identification criteria as described in internationally recognised standards, for example, in standard EN 16215:2012 ('Animal feed — Determination of dioxins and dioxin-like PCBs by GC/HRMS and of indicator PCBs by GC/HRMS') and/or in EPA methods 1613 and 1668 as revised.

The limit of quantification of an individual congener may be identified as

- (a) the concentration of an analyte in the extract of a sample which produces an instrumental response at two different ions to be monitored with a S/N (signal/noise) ratio of 3:1 for the less intensive raw data signal;

⁽¹⁾ Bioanalytical methods are not specific to those congeners included in the TEF-scheme. Other structurally related AhR-active compounds may be present in the sample extract which contribute to the overall response. Therefore, bioanalytical results cannot be an estimate but rather an indication of the TEQ level in the sample.

⁽²⁾ The principles as described in the 'Guidance Document on the Estimation of LOD and LOQ for Measurements in the Field of Contaminants in Feed and Food' [[link to website](#)] shall be followed when applicable.

or, if for technical reasons the signal-to-noise calculation does not provide reliable results,

(b) the lowest concentration point on a calibration curve that gives an acceptable ($\leq 30\%$) and consistent (measured at least at the start and at the end of an analytical series of samples) deviation to the average relative response factor calculated for all points on the calibration curve in each series of samples⁽¹⁾.

- 1.8. 'Upper-bound' means the concept which requires using the limit of quantification for the contribution of each non-quantified congener.
- 1.9. 'Lower-bound' means the concept which requires using zero for the contribution of each non-quantified congener.
- 1.10. 'Medium-bound' means the concept which requires using half of the limit of quantification calculating the contribution of each non-quantified congener.
- 1.11. 'Lot' means an identifiable quantity of food delivered at one time and determined by the official to have common characteristics, such as origin, variety, type of packing, packer, consignor or markings. In the case of fish and fishery products, also the size of fish shall be comparable. In case the size and/or weight of the fish is not comparable within a consignment, the consignment may still be considered as a lot but a specific sampling procedure has to be applied.
- 1.12. 'Sublot' means designated part of a large lot in order to apply the sampling method on that designated part. Each sublot must be physically separated and identifiable.
- 1.13. 'Incremental sample' means a quantity of material taken from a single place in the lot or sublot.
- 1.14. 'Aggregate sample' means the combined total of all the incremental samples taken from the lot or sublot.
- 1.15. 'Laboratory sample' means a representative part/quantity of the aggregate sample intended for the laboratory.

II. ABBREVIATIONS USED

BEQ	Bioanalytical Equivalents
GC	Gas chromatography
HRMS	High resolution mass spectrometry
LRMS	Low resolution mass spectrometry
MS/MS	Tandem mass spectrometry
PCB	Polychlorinated biphenyl
Non-dioxin-like PCBs	PCB 28, PCB 52, PCB 101, PCB 138, PCB 153 and PCB 180
PCDD	Polychlorinated dibenzo-p-dioxins
PCDF	Polychlorinated dibenzofurans
QC	Quality control
REP	Relative potency
TEF	Toxic Equivalency Factor
TEQ	Toxic Equivalents
TCDD	2,3,7,8-Tetrachlorodibenzo-p-dioxin
U	Expanded measurement uncertainty

⁽¹⁾ The LOQ is calculated from the lowest concentration point taking into account the recovery of internal standards and sample intake.

ANNEX II

METHODS OF SAMPLING FOR OFFICIAL CONTROL OF LEVELS OF DIOXINS (PCDD/PCDF), DIOXIN-LIKE PCBs AND NON-DIOXIN-LIKE PCBs IN CERTAIN FOODSTUFFS**I. SCOPE**

Samples intended for the official control of the levels of dioxins (PCDD/Fs), dioxin-like PCBs and non-dioxin-like PCBs in foodstuffs shall be taken according to the methods described in this Annex. Aggregate samples thus obtained shall be considered as representative of the lots or sublots from which they are taken. Compliance with maximum levels laid down in Regulation (EC) No 1881/2006 shall be established on the basis of the levels determined in the laboratory samples.

To ensure compliance with the provisions in Article 4 of Regulation (EC) No 852/2004, food business operator shall, when samples are taken to control the levels of dioxins (PCDD/Fs), dioxin-like PCBs and non-dioxin-like PCBs, take the samples according to the methods described in Chapter III of this Annex or apply an equivalent sampling procedure which is demonstrated to have a same level of representation as the sampling procedure described in Chapter III of this Annex.

II. GENERAL PROVISIONS**1. Personnel**

Official sampling shall be performed by an authorised person as designated by the Member State.

2. Material to be sampled

Each lot or subplot which is to be examined shall be sampled separately.

3. Precautions to be taken

In the course of sampling and the preparation of the samples, precautions shall be taken to avoid any changes which would affect the content of dioxins and PCBs, adversely affect the analytical determination or make the aggregate samples unrepresentative.

4. Incremental samples

As far as possible, incremental samples shall be taken at various places distributed throughout the lot or subplot. Departure from such a procedure shall be recorded in the record provided for under point II.8.

5. Preparation of the aggregate sample

The aggregate sample shall be made up by combining the incremental samples. It shall be at least 1 kg unless not practical, e.g. when a single package has been sampled or when the product has a very high commercial value.

6. Replicate samples

The replicate samples for enforcement, defence and reference purposes shall be taken from the homogenised aggregate sample, unless such procedure conflicts with a Member State's rules as regard the rights of the food business operator. The size of the laboratory samples for enforcement shall be sufficient to allow at least for duplicate analyses.

7. Packaging and transmission of samples

Each sample shall be placed in a clean, inert container offering adequate protection from contamination, from loss of analytes by adsorption to the internal wall of the container and against damage in transit. All necessary precautions shall be taken to avoid any change in composition of the sample which might arise during transportation or storage.

8. Sealing and labelling of samples

Each sample taken for official use shall be sealed at the place of sampling and identified in accordance with the rules of the Member States.

A record shall be kept of each sampling, permitting each lot to be identified unambiguously and giving the date and place of sampling together with any additional information likely to be of assistance to the analyst.

III. SAMPLING PLAN

The sampling method applied shall ensure that the aggregate sample is representative of the (sub)lot that is to be controlled.

1. Division of lots into sublots

Large lots shall be divided into sublots on condition that the subplot can be separated physically. For products traded in large bulk consignments (e.g. vegetable oils) Table 1 shall apply. For other products Table 2 shall apply. Taking into account that the weight of the lot is not always an exact multiple of the weight of the sublots, the weight of the subplot may exceed the mentioned weight by a maximum of 20 %.

Table 1

Subdivision of lots into sublots for products traded in bulk consignments

Lot weight (ton)	Weight or number of sublots
≥ 1 500	500 tonnes
> 300 and < 1 500	3 sublots
≥ 50 and ≤ 300	100 tonnes
< 50	—

Table 2

Subdivision of lots into sublots for other products

Lot weight (ton)	Weight or number of sublots
≥ 15	15-30 tonnes
< 15	—

2. Number of incremental samples

The aggregate sample uniting all incremental samples shall be at least 1 kg (see point II.5).

The minimum number of incremental samples to be taken from the lot or subplot shall be as given in Tables 3 and 4.

In the case of bulk liquid products, the lot or subplot shall be thoroughly mixed insofar as possible and insofar as it does not affect the quality of the product by either manual or mechanical means immediately prior to sampling. In that case, a homogeneous distribution of contaminants is assumed within a given lot or subplot. It is therefore sufficient to take three incremental samples from a lot or subplot to form the aggregate sample.

The incremental samples shall be of similar weight. The weight of an incremental sample shall be at least 100 grams.

Departure from this procedure must be recorded in the record provided for under point II.8 of this Annex. In accordance with the provisions of Commission Decision 97/747/EC⁽¹⁾, the aggregate sample size for hens' eggs is at least 12 eggs (for bulk lots as well as for lots consisting of individual packages, Tables 3 and 4 shall apply).

Table 3

Minimum number of incremental samples to be taken from the lot or subplot

Weight or volume of lot/sublot (in kg or litre)	Minimum number of incremental samples to be taken
< 50	3
50 to 500	5
> 500	10

If the lot or subplot consists of individual packages or units, then the number of packages or units which shall be taken to form the aggregate sample is given in Table 4.

Table 4

Number of packages or units (incremental samples) which shall be taken to form the aggregate sample if the lot or subplot consists of individual packages or units

Number of packages or units in the lot/sublot	Number of packages or units to be taken
1 to 25	at least 1 package or unit
26 to 100	about 5 %, at least 2 packages or units
> 100	about 5 %, at maximum 10 packages or units

3. Specific provisions for the sampling of lots containing whole fishes of comparable size and weight

Fishes are considered to be of comparable size and weight where the difference in size and weight does not exceed about 50 %.

The number of incremental samples to be taken from the lot are defined in Table 3. The aggregate sample uniting all incremental samples shall be at least 1 kg (see point II.5).

- Where the lot to be sampled contains small fishes (individual fishes weighing < about 1 kg), the whole fish is taken as incremental sample to form the aggregate sample. Where the resulting aggregate sample weighs more than 3 kg, the incremental samples may consist of the middle part, weighing each at least 100 grams, of the fishes forming the aggregate sample. The whole part to which the maximum level is applicable is used for homogenisation of the sample.

The middle part of the fish is where the centre of gravity is. This is located in most cases at the dorsal fin (in case the fish has a dorsal fin) or halfway between the gill opening and the anus.

- Where the lot to be sampled contains larger fishes (individual fishes weighing more than about 1 kg), the incremental sample consists of the middle part of the fish. Each incremental sample weighs at least 100 grams.

For fishes of intermediate size (about 1-6 kg) the incremental sample is taken as a slice of the fish from backbone to belly in the middle part of the fish.

⁽¹⁾ Commission Decision 97/747/EC of 27 October 1997 fixing the levels and frequencies of sampling provided for by Council Directive 96/23/EC for the monitoring of certain substances and residues thereof in certain animal products (OJ L 303, 6.11.1997, p. 12).

For very large fishes (e.g. > about 6 kg), the incremental part is taken from the right side (frontal view) dorso-lateral muscle meat in the middle part of the fish. Where the taking of such a piece of the middle part of the fish would result in significant economic damage, the taking of three incremental samples of at least 350 grams each may be considered as being sufficient independent of the size of the lot or alternatively an equal part of the muscled meat close to the tail part and the muscle meat close to the head part of one fish may be taken to form the incremental sample being representative for the level of dioxins in the whole fish.

4. Sampling of lots of fish containing whole fishes of different size and/or weight

- The provisions of point III.3 as regards sample constitution shall apply.
- Where a size or weight class/category is predominant (about 80 % or more of the lot), the sample is taken from fishes with the predominant size or weight. This sample is to be considered as being representative for the whole lot.
- Where no particular size or weight class/category predominates, then it must be ensured that the fishes selected for the sample are representative for the lot. Specific guidance for such cases is provided in 'Guidance document on sampling of whole fishes of different size and/or weight' ⁽²⁾.

5. Sampling at retail stage

Sampling of foodstuffs at the retail stage shall be done where possible in accordance with the sampling provisions set out in point III.2.

Where this is not possible, an alternative method of sampling at retail stage may be used provided that it ensures sufficient representativeness for the sampled lot or subplot.

IV. COMPLIANCE OF THE LOT WITH SPECIFICATION

1. As regards non-dioxin-like PCBs

The lot is compliant if the analytical result for the sum of non-dioxin-like PCBs does not exceed the respective maximum level, as laid down in Regulation (EC) No 1881/2006 taking into account the expanded measurement uncertainty ⁽³⁾.

The lot is non-compliant with the maximum level as laid down in Regulation (EC) No 1881/2006 if the mean of two upperbound analytical results obtained from duplicate analysis ⁽⁴⁾, taking into account the expanded measurement uncertainty, exceeds the maximum level beyond reasonable doubt.

The expanded measurement uncertainty is calculated using a coverage factor of 2 which gives a level of confidence of approximately 95 %. A lot is non-compliant if the mean of the measured values minus the expanded uncertainty of the mean is above the established maximum level.

The rules, mentioned in the paragraphs above under this point, shall apply for the analytical result obtained on the sample for official control. In case of analysis for defence or reference purposes, the national rules apply.

2. As regards dioxins (PCDD/Fs) and dioxin-like PCBs

The lot is compliant if the result of a single analysis

- performed by a screening method with a false-compliant rate below 5 % indicates that the level does not exceed the respective maximum level of PCDD/Fs and the sum of PCDD/Fs and dioxin-like PCBs as laid down in Regulation (EC) No 1881/2006,

⁽²⁾ https://ec.europa.eu/food/sites/food/files/safety/docs/cs_contaminants_catalogue_dioxins_guidance-sampling_exemples-dec2006_en.pdf

⁽³⁾ The principles as described in the 'Guidance Document on Measurement Uncertainty for Laboratories performing PCDD/F and PCB Analysis using Isotope Dilution Mass Spectrometry' [link to website] shall be followed when applicable.

⁽⁴⁾ The duplicate analysis is necessary if the result of the first determination is non-compliant. The duplicate analysis is necessary to exclude the possibility of internal cross-contamination or an accidental mix-up of samples. In case the analysis is performed in the course of a contamination incident, confirmation by duplicate analysis might be omitted in case the samples selected for analysis are through traceability linked to the contamination incident and the level found is significantly above the maximum level.

- performed by a confirmatory method does not exceed the respective maximum level of PCDD/Fs and the sum of PCDD/Fs and dioxin-like PCBs as laid down in Regulation (EC) No 1881/2006 taking into account the expanded measurement uncertainty ⁽⁷⁾.

For screening assays a cut-off value shall be established for the decision on the compliance with the respective maximum levels set for either PCDD/Fs or for the sum of PCDD/Fs and dioxin-like PCBs.

The lot is non-compliant with the maximum level as laid down in Regulation (EC) No 1881/2006 if the mean of two upperbound analytical results (duplicate analysis ⁽⁶⁾) obtained using a confirmatory method, taking into account the expanded measurement uncertainty, exceeds the maximum level beyond reasonable doubt.

The expanded measurement uncertainty is calculated using a coverage factor of 2 which gives a level of confidence of approximately 95 %. A lot is non-compliant if the mean of the measured values minus the expanded uncertainty of the mean is above the established maximum level.

The sum of the estimated expanded uncertainties of the separate analytical results of PCDD/Fs and dioxin-like PCBs has to be used for the estimated expanded uncertainty of the sum of PCDD/Fs and dioxin-like PCBs,

The rules, mentioned in the paragraphs above under this point, shall apply for the analytical result obtained on the sample for official control. In case of analysis for defence or reference purposes, the national rules apply.

V. EXCEEDANCE OF ACTION LEVELS

Action levels serve as a tool for the selection of samples in those cases where it is appropriate to identify a source of contamination and to take measures for its reduction or elimination. Screening methods shall establish the appropriate cut-off values for selection of those samples. Where significant efforts are necessary to identify a source and to reduce or eliminate the contamination, it might be appropriate to confirm exceedance of the action level by duplicate analysis using a confirmatory method and taking into account the expanded measurement uncertainty ⁽⁷⁾.

⁽⁷⁾ Guidance Document on Measurement Uncertainty for Laboratories performing PCDD/F and PCB Analysis using Isotope Dilution Mass Spectrometry [[link to website](#)], Guidance Document on the Estimation of LOD and LOQ for Measurements in the Field of Contaminants in Feed and Food [[link to website](#)].

⁽⁶⁾ The duplicate analysis is necessary if the result of the first determination applying confirmatory methods with the use of ¹³C-labelled internal standard for the relevant analytes is non-compliant. The duplicate analysis is necessary to exclude the possibility of internal cross-contamination or an accidental mix-up of samples. In case the analysis is performed in the course of a contamination incident, confirmation by duplicate analysis might be omitted in case the samples selected for analysis are through traceability linked to the contamination incident and the level found is significantly above the maximum level.

⁽⁷⁾ Identical explanation and requirements for duplicate analysis for control of action levels as in footnote 6 for maximum levels.

ANNEX III

SAMPLE PREPARATION AND REQUIREMENTS FOR METHODS OF ANALYSIS USED IN CONTROL OF THE LEVELS OF DIOXINS (PCDD/Fs) AND DIOXIN-LIKE PCBs IN CERTAIN FOODSTUFFS

1. FIELD OF APPLICATION

The requirements set out in this Annex shall be applied where foodstuffs are analysed for the official control of the levels of 2,3,7,8-substituted polychlorinated dibenzo-p-dioxins and polychlorinated dibenzofurans (PCDD/Fs) and dioxin-like polychlorinated biphenyls (dioxin-like PCBs) and as regards sample preparation and analytical requirements for other regulatory purposes, including the controls performed by the food business operator to ensure compliance with provisions in Article 4 of Regulation (EC) No 852/2004.

Monitoring for the presence of PCDD/Fs and dioxin-like PCBs in foodstuffs may be performed with two different types of analytical methods:

(a) *Screening methods*

The goal of screening methods is to select those samples with levels of PCDD/Fs and dioxin-like PCBs that exceed the maximum levels or the action levels. Screening methods shall ensure cost-effective high sample-throughput, thus increasing the chance to discover new incidents where high exposure may lead to health risks for consumers. Their application shall aim to avoid false-compliant results. They may comprise bioanalytical and GC/MS methods.

Screening methods compare the analytical result with a cut-off value, providing a yes/no-decision over the possible exceedance of the maximum or action level. The concentration of PCDD/Fs and the sum of PCDD/Fs and dioxin-like PCBs in samples suspected to be non-compliant with the maximum level must be determined or confirmed by a confirmatory method.

In addition, screening methods may give an indication of the levels of PCDD/Fs and dioxin-like-PCBs present in the sample. In case of application of bioanalytical screening methods the result is expressed as Bioanalytical Equivalents (BEQ), whereas in case of application of physico-chemical GC-MS methods it is expressed as Toxic Equivalents (TEQ). The numerically indicated results of screening methods are suitable for demonstrating compliance or suspected non-compliance or exceedance of action levels and give an indication of the range of levels in case of follow-up by confirmatory methods. They are not suitable for purposes such as evaluation of background levels, estimation of intake, following of time trends in levels or re-evaluation of action and maximum levels.

(b) *Confirmatory methods*

Confirmatory methods allow the unequivocal identification and quantification of PCDD/Fs and dioxin-like PCBs present in a sample and provide full information on congener basis. Therefore, those methods allow the control of maximum and action levels, including the confirmation of results obtained by screening methods. Furthermore, results may be used for other purposes such as determination of low background levels in food monitoring, following of time trends, exposure assessment of the population and building of a database for possible re-evaluation of action and maximum levels. They are also important for establishing congener patterns in order to identify the source of a possible contamination. Such methods utilise GC-HRMS. For confirming compliance or non-compliance with the maximum level, also GC-MS/MS can be used.

2. BACKGROUND

For calculation of TEQ concentrations, the concentrations of the individual substances in a given sample shall be multiplied by their respective TEF, as established by the World Health Organisation and listed in the Appendix to this Annex, and subsequently summed to give the total concentration of dioxin-like compounds expressed as TEQs.

Screening and confirmatory methods may only be applied for control of a certain matrix if the methods are sensitive enough to detect levels reliably at the maximum or action level.

3. QUALITY ASSURANCE REQUIREMENTS

- Measures must be taken to avoid cross-contamination at each stage of the sampling and analysis procedure.
- The samples must be stored and transported in glass, aluminum, polypropylene or polyethylene containers suitable for storage without any influence on the levels of PCDD/Fs and dioxin-like PCBs in the samples. Traces of paper dust must be removed from the sample container.
- The sample storage and transportation has to be performed in a way that maintains the integrity of the foodstuff sample.
- Insofar as relevant, finely grind and mix thoroughly each laboratory sample using a process that has been demonstrated to achieve complete homogenisation (e.g. ground to pass a 1 mm sieve); samples have to be dried before grinding if moisture content is too high.
- Control of reagents, glassware and equipment for possible influence of TEQ- or BEQ-based results is of general importance.
- A blank analysis shall be performed by carrying out the entire analytical procedure omitting only the sample.
- For bioanalytical methods, it is of great importance that all glassware and solvents used in analysis shall be tested to be free of compounds that interfere with the detection of target compounds in the working range. Glassware shall be rinsed with solvents or/and heated at temperatures suitable to remove traces of PCDD/Fs, dioxin-like compounds and interfering compounds from its surface.
- Sample quantity used for the extraction must be sufficient to fulfill the requirements with respect to a sufficiently low working range including the concentrations of maximum or action levels.
- The specific sample preparation procedures used for the products under consideration shall follow internationally accepted guidelines.
- In the case of fish, the skin has to be removed as the maximum level applies to muscle meat without skin. However it is necessary that all remaining muscle meat and fat tissue on the inner side of the skin are carefully and completely scraped off from the skin and added to the sample to be analysed.

4. REQUIREMENTS FOR LABORATORIES

- In accordance with the provisions of Regulation (EC) No 882/2004, laboratories shall be accredited by a recognised body operating in accordance with ISO Guide 58 to ensure that they are applying analytical quality assurance. Laboratories shall be accredited following the EN ISO/IEC 17025 standard. The principles as described in the Technical Guidelines for the estimation of measurement uncertainty and limits of quantification for PCDD/F and PCB analysis shall be followed when applicable ⁽¹⁾.
- Laboratory proficiency shall be proven by the continuous successful participation in interlaboratory studies for the determination of PCDD/Fs and dioxin-like PCBs in relevant food matrices and concentration ranges.
- Laboratories applying screening methods for routine control of samples shall establish a close cooperation with laboratories applying the confirmatory method, both for quality control and confirmation of the analytical result of suspected samples.

5. BASIC REQUIREMENTS TO BE MET BY ANALYTICAL PROCEDURE FOR DIOXINS (PCDD/Fs) AND DIOXIN-LIKE PCBs

5.1. Low working range and limits of quantification

- For PCDD/Fs, detectable quantities have to be in the upper femtogram (10^{-15} g) range because of extreme toxicity of some of these compounds. For most PCB congeners limit of quantification in the nanogram (10^{-9} g) range is already sufficient. However, for the measurement of the more toxic dioxin-like PCB congeners (in particular non-ortho-substituted congeners) the lower end of the working range must reach the low picogram (10^{-12} g) levels.

⁽¹⁾ Guidance Document on Measurement Uncertainty for Laboratories performing PCDD/F and PCB Analysis using Isotope Dilution Mass Spectrometry [link to website], Guidance Document on the Estimation of LOD and LOQ for Measurements in the Field of Contaminants in Feed and Food [link to website].

5.2. High selectivity (specificity)

- A distinction is required between PCDD/Fs and dioxin-like PCBs and a multitude of other, coextracted and possibly interfering compounds present at concentrations up to several orders of magnitude higher than those of the analytes of interest. For gas chromatography/mass spectrometry (GC-MS) methods, a differentiation among various congeners is necessary, such as between toxic (e.g. the seventeen 2,3,7,8-substituted PCDD/Fs, and twelve dioxin-like PCBs) and other congeners.
- Bioanalytical methods shall be able to detect the target compounds as the sum of PCDD/Fs, and/or dioxin-like PCBs. Sample clean-up shall aim at removing compounds causing false non-compliant results or compounds that may decrease the response, causing false-compliant results.

5.3. High accuracy (trueness and precision, bioassay apparent recovery)

- For GC-MS methods, the determination shall provide a valid estimate of the true concentration in a sample. High accuracy (accuracy of the measurement: the closeness of the agreement between the result of a measurement with the true or assigned value of the measurand) is necessary to avoid the rejection of a sample analysis result on the basis of poor reliability of the determined TEQ level. Accuracy is expressed as trueness (difference between the mean value measured for an analyte in a certified material and its certified value, expressed as percentage of this value) and precision (RSD_R relative standard deviation calculated from results generated under reproducibility conditions).
- For bioanalytical methods, the bioassay apparent recovery shall be determined.

5.4. Validation in the range of maximum level and general quality control measures

- Laboratories shall demonstrate the performance of a method in the range of the maximum level, e.g. 0,5×, 1× and 2× the maximum level with an acceptable coefficient of variation for repeated analysis, during the validation procedure and/or during routine analysis.
- Regular blank controls and spiking experiments or analysis of control samples (preferably, if available, certified reference material) shall be performed as internal quality control measures. Quality control (QC) charts for blank controls, spiking experiments or analysis of control samples shall be recorded and checked to make sure the analytical performance is in accordance with the requirements.

5.5. Limit of quantification

- For a bioanalytical screening method, establishment of the LOQ is not an indispensable requirement but the method shall prove that it can differentiate between the blank and the cut-off value. When providing a BEQ-level, a reporting level shall be established to deal with samples showing a response below this level. The reporting level shall be demonstrated to be different from procedure blank samples at least by a factor of three, with a response below the working range. It shall therefore be calculated from samples containing the target compounds around the required minimum level, and not from a S/N ratio or an assay blank.
- Limit of quantification (LOQ) for a confirmatory method shall be about one fifth of the maximum level.

5.6. Analytical criteria

- For reliable results from confirmatory or screening methods, the following criteria must be met in the range of the maximum level for the TEQ value respectively the BEQ value, whether determined as total TEQ or total BEQ (as sum of PCDD/F and dioxin-like PCBs) or separately for PCDD/Fs and dioxin-like PCBs.

	Screening with bioanalytical or physico-chemical methods	Confirmatory methods
False-compliant rate (*)	< 5 %	
Trueness		- 20 % to + 20 %

	Screening with bioanalytical or physico-chemical methods	Confirmatory methods
Repeatability (RSD _r)	< 20 %	
Intermediate precision (RSD _R)	< 25 %	< 15 %

(*) With respect to the maximum levels

5.7. Specific requirements for screening methods

- Both GC-MS and bioanalytical methods may be used for screening. For GC-MS methods the requirements as laid down in point 6 are to be used. For cell-based bioanalytical methods specific requirements are laid down in point 7.
- Laboratories applying screening methods for routine control of samples shall establish a close cooperation with laboratories applying the confirmatory method.
- Performance verification of the screening method is required during routine analysis, by analytical quality control and ongoing method validation. There must be a continuous programme for control of compliant results.
- Check on possible suppression of the cell response and cytotoxicity.

20 % of the sample extracts shall be measured in routine screening without and with TCDD added corresponding to the maximum or action level, to check if the response is possibly suppressed by interfering substances present in the sample extract. The measured concentration of the spiked sample is compared to the sum of the concentration of the unspiked extract plus the spiking concentration. If this measured concentration is more than 25 % lower than the calculated (sum) concentration, this is an indication of a potential signal suppression and the respective sample must be submitted to confirmatory analysis. Results shall be monitored in quality control charts.

- Quality control on compliant samples

Approximately 2 % to 10 % of the compliant samples, depending on sample matrix and laboratory experience, shall be confirmed.

- Determination of false-compliant rates from QC data

The rate of false-compliant results from screening of samples below and above the maximum level or the action level shall be determined. Actual false-compliant rates shall be below 5 %.

After a minimum of 20 confirmed results per matrix/matrix group is available from the quality control of compliant samples, conclusions on the false-compliant rate shall be drawn from this database. The results from samples analysed in ring trials or during contamination incidents, covering a concentration range up to, e.g. 2× the maximum level (ML), may also be included in the minimum of 20 results for evaluation of the false-compliant rate. The samples shall cover most frequent congener patterns, representing various sources.

Although screening assays shall preferentially aim to detect samples exceeding the action level, the criterion for determining false-compliant rates is the maximum level, taking into account the expanded measurement uncertainty of the confirmatory method.

- Potential non-compliant results from screening shall always be verified by a full re-analysis of the original sample by a confirmatory method. These samples may also be used to evaluate the rate of false non-compliant results. For screening methods, the rate of false non-compliant results is the fraction of results confirmed to be compliant from confirmatory analysis, while in previous screening the sample had been declared to be suspected to be non-compliant. However, evaluation of the advantageousness of the screening method shall be based on comparison of false non-compliant samples with the total number of samples checked. This rate shall be low enough to make the use of a screening tool advantageous.

- At least under validation conditions, bioanalytical methods shall provide a valid indication of the TEQ level, calculated and expressed as BEQ.
 - Also for bioanalytical methods carried out under repeatability conditions, the intra-laboratory RSD_r would typically be smaller than the reproducibility RSD_R.
6. SPECIFIC REQUIREMENTS FOR GC-MS METHODS TO BE COMPLIED WITH FOR SCREENING OR CONFIRMATORY PURPOSES
- 6.1. **Acceptable differences between upperbound and lowerbound WHO-TEQ levels**
- The difference between upperbound level and lowerbound level shall not exceed 20 % for confirmation of the exceedance of maximum or in case of need of action levels.
- 6.2. **Control of recoveries**
- Addition of ¹³C-labelled 2,3,7,8-chlorine-substituted internal PCDD/F standards and of ¹³C-labelled internal dioxin-like PCB standards must be carried out at the very beginning of the analytical method, e.g. prior to extraction, in order to validate the analytical procedure. At least one congener for each of the tetra- to octa-chlorinated homologous groups for PCDD/Fs and at least one congener for each of the homologous groups for dioxin-like PCBs must be added (alternatively, at least one congener for each mass spectrometric selected ion recording function used for monitoring PCDD/Fs and dioxin-like PCBs). In case of confirmatory methods, all seventeen ¹³C-labelled 2,3,7,8-substituted internal PCDD/F standards and all twelve ¹³C-labelled internal dioxin-like PCB standards shall be used.
 - Relative response factors shall also be determined for those congeners for which no ¹³C-labelled analogue is added by using appropriate calibration solutions.
 - For foodstuffs of plant origin and foodstuffs of animal origin containing less than 10 % fat, the addition of the internal standards is mandatory prior to extraction. For foodstuffs of animal origin containing more than 10 % fat, the internal standards may be added either before or after fat extraction. An appropriate validation of the extraction efficiency shall be carried out, depending on the stage at which internal standards are introduced and on whether results are reported on product or fat basis.
 - Prior to GC-MS analysis, one or two recovery (surrogate) standard(s) must be added.
 - Control of recovery is necessary. For confirmatory methods, the recoveries of the individual internal standards shall be in the range of 60 to 120 %. Lower or higher recoveries for individual congeners, in particular for some hepta- and octa-chlorinated dibenzo-p-dioxins and dibenzofurans, are acceptable on the condition that their contribution to the TEQ value does not exceed 10 % of the total TEQ value (based on sum of PCDD/F and dioxin-like PCBs). For GC-MS screening methods, the recoveries shall be in the range of 30 to 140 %.
- 6.3. **Removal of interfering substances**
- Separation of PCDD/Fs from interfering chlorinated compounds such as non-dioxin-like PCBs and chlorinated diphenyl ethers shall be carried out by suitable chromatographic techniques (preferably with a florisil, alumina and/or carbon column).
 - Gas-chromatographic separation of isomers shall be sufficient (< 25 % peak to peak between 1,2,3,4,7,8-HxCDF and 1,2,3,6,7,8-HxCDF).
- 6.4. **Calibration with standard curve**
- The range of the calibration curve shall cover the relevant range of maximum or action levels.
- 6.5. **Specific criteria for confirmatory methods**
- For GC-HRMS:

In HRMS, the resolution shall typically be greater than or equal to 10 000 for the entire mass range at 10 % valley.

Fulfilment of further identification and confirmation criteria as described in internationally recognised standards, for example, in standard EN 16215:2012 (Animal feed — Determination of dioxins and dioxin-like PCBs by GC/HRMS and of indicator PCBs by GC/HRMS) and/or in EPA methods 1613 and 1668 as revised.

— For GC-MS/MS:

Monitoring of at least two specific precursor ions, each with one specific corresponding transition product ion for all labelled and unlabelled analytes in the scope of analysis.

Maximum permitted tolerance of relative ion intensities of $\pm 15\%$ for selected transition product ions in comparison to calculated or measured values (average from calibration standards), applying identical MS/MS conditions, in particular collision energy and collision gas pressure, for each transition of an analyte.

Resolution for each quadrupole to be set equal to or better than unit mass resolution (unit mass resolution: sufficient resolution to separate two peaks one mass unit apart) in order to minimise possible interferences on the analytes of interest.

Fulfilment of the further criteria as described in internationally recognised standards, for example, in standard EN 16215:2012 (Animal feed — Determination of dioxins and dioxin-like PCBs by GC/HRMS and of indicator PCBs by GC/HRMS) and/or in EPA methods 1613 and 1668 as revised, except the obligation to use GC-HRMS.

7. SPECIFIC REQUIREMENTS FOR BIOANALYTICAL METHODS

Bioanalytical methods are methods based on the use of biological principles like cell-based assays, receptor-assays or immunoassays. This point establishes requirements for bioanalytical methods in general.

A screening method in principle classifies a sample as compliant or suspected to be non-compliant. For this, the calculated BEQ level is compared to the cut-off value (see point 7.3). Samples below the cut-off value are declared compliant, samples equal or above the cut-off value as suspected to be non-compliant, requiring analysis by a confirmatory method. In practice, a BEQ level corresponding to two-thirds of the maximum level may serve as cut-off value provided that a false-compliant rate below 5 % and an acceptable rate for false non-compliant results are ensured. With separate maximum levels for PCDD/Fs and for the sum of PCDD/Fs and dioxin-like PCBs, checking compliance of samples without fractionation requires appropriate bioassay cut-off values for PCDD/Fs. For checking of samples exceeding the action levels, an appropriate percentage of the respective action level would suit as cut-off value.

If an indicative level is expressed in BEQs, the results from the the sample must be given in the working range and exceeding the reporting limit (see points 7.1.1 and 7.1.6).

7.1. Evaluation of the test response

7.1.1. General requirements

— When calculating the concentrations from a TCDD calibration curve, values at the higher end of the curve will show a high variation (high coefficient of variation (CV)). The working range is the area where this CV is smaller than 15 %. The lower end of the working range (reporting limit) must further be set significantly (at least by a factor of three) above the procedure blanks. The upper end of the working range is usually represented by the EC_{70} value (70 % of maximal effective concentration), but lower if the CV is higher than 15 % in this range. The working range shall be established during validation. Cut-off values (see point 7.3) must be within the working range.

— Standard solutions and sample extracts shall be tested in triplicate or at least in duplicate. When using duplicates, a standard solution or a control extract tested in four to six wells divided over the plate shall produce a response or concentration (only possible in the working range) based on a $CV < 15\%$.

7.1.2. Calibration

7.1.2.1. Calibration with standard curve

- Levels in samples may be estimated by comparison of the test response with a calibration curve of TCDD (or PCB 126 or a PCDD/F/dioxin-like PCB standard mixture) to calculate the BEQ level in the extract and subsequently in the sample.
- Calibration curves shall contain 8 to 12 concentrations (at least in duplicates), with enough concentrations in the lower part of the curve (working range). Special attention shall be paid to the quality of the curve-fit in the working range. As such, the R^2 value is of little or no value in estimating the goodness of fit in nonlinear regression. A better fit will be achieved by minimising the difference between calculated and observed levels in the working range of the curve (e.g. by minimising the sum of squared residuals).
- The estimated level in the sample extract is subsequently corrected for the BEQ level calculated for a matrix or solvent blank sample (to account for impurities from solvents and chemicals used), and the apparent recovery (calculated from the BEQ level of suitable reference samples with representative congener patterns around the maximum or action level). For performing a recovery correction, the apparent recovery must always be within the required range (see point 7.1.4). Reference samples used for recovery correction must comply with requirements as given in point 7.2.

7.1.2.2. Calibration with reference samples

Alternatively, a calibration curve prepared from at least four reference samples (see point 7.2: one matrix blank, plus three reference samples at 0,5×, 1,0× and 2,0× the maximum or action level may be used, eliminating the need to correct for blank and recovery if matrix properties of the reference samples match those of the unknown samples. In this case, the test response corresponding to two-thirds of the maximum level (see point 7.3) may be calculated directly from these samples and used as cut-off value. For checking of samples exceeding the action levels, an appropriate percentage of these action levels would suit as cut-off value.

7.1.3. Separate determination of PCDD/Fs and dioxin-like PCBs

Extracts may be split into fractions containing PCDD/Fs and dioxin-like PCBs, allowing a separate indication of PCDD/Fs and dioxin-like PCB TEQ levels (in BEQs). A PCB 126 standard calibration curve shall preferentially be used to evaluate results for the fraction containing dioxin-like PCBs.

7.1.4. Bioassay apparent recoveries

The 'bioassay apparent recovery' shall be calculated from suitable reference samples with representative congener patterns around the maximum or action level and expressed as percentage of the BEQ level in comparison to the TEQ level. Depending on the type of assay and TEFs⁽¹⁾ used, the differences between TEF and REP factors for dioxin-like PCBs may cause low apparent recoveries for dioxin-like PCBs in comparison to PCDD/Fs. Therefore, if a separate determination of PCDD/Fs and dioxin-like PCBs is performed, bioassay apparent recoveries shall be: for dioxin-like PCBs 20 % to 60 %, for PCDD/Fs 50 % to 130 % (ranges apply for TCDD calibration curve). As the contribution of dioxin-like PCBs to the sum of PCDD/Fs and dioxin-like PCBs may vary between different matrices and samples, bioassay apparent recoveries for the sum parameter reflect these ranges and shall be between 30 % to 130 %.

7.1.5. Control of recoveries for clean-up

The loss of compounds during the clean-up shall be checked during validation. A blank sample spiked with a mixture of the different congeners shall be submitted to clean-up (at least $n = 3$) and the recovery and variability checked by a confirmatory method. The recovery shall be within 60 to 120 % especially for congeners contributing more than 10 % to the TEQ-level in various mixtures.

⁽¹⁾ Current requirements are based on the TEFs published in: M. Van den Berg et al, Toxicol Sci 93 (2), 223-241 (2006).

7.1.6. Reporting Limit

When reporting BEQ levels, a reporting limit shall be determined from relevant matrix samples involving typical congener patterns, but not from the calibration curve of the standards due to low precision in the lower range of the curve. Effects from extraction and clean-up must be taken into account. The reporting limit must be set significantly (at least by a factor of three) above the procedure blanks.

7.2. Use of reference samples

- Reference samples shall represent sample matrix, congener patterns and concentration ranges for PCDD/Fs and dioxin-like PCBs around the maximum or action level.
- A procedure blank, or preferably a matrix blank, and a reference sample at the maximum or action level have to be included in each test series. These samples must be extracted and tested at the same time under identical conditions. The reference sample must show a clearly elevated response in comparison to the blank sample, thus ensuring the suitability of the test. Those samples may be used for blank and recovery corrections.
- Reference samples chosen for performing a recovery correction shall be representative for the test samples, meaning that congener patterns shall not lead to an underestimation of levels.
- Extra reference samples at, e.g. 0,5× and 2× the maximum or action level may be included to demonstrate the proper performance of the test in the range of interest for the control of the maximum or action level. Combined, these samples may be used for calculating the BEQ-levels in test samples (see point 7.1.2.2).

7.3. Determination of cut-off values

The relationship between bioanalytical results in BEQ and results from confirmatory methods in TEQ shall be established (e.g. by matrix-matched calibration experiments, involving reference samples spiked at 0, 0,5×, 1× and 2× the maximum level (ML), with six repetitions on each level (n = 24)). Correction factors (blank and recovery) may be estimated from this relationship but shall be checked in each test series by including procedure/matrix blanks and recovery samples (see point 7.2).

Cut-off values shall be established for decision over sample compliance with maximum levels or for control of action levels, if of interest, with the respective maximum or action levels set for either PCDD/Fs and dioxin-like PCBs alone, or for the sum of PCDD/Fs and dioxin-like PCBs. They are represented by the lower endpoint of the distribution of bioanalytical results (corrected for blank and recovery) corresponding to the decision limit of the confirmatory method based on a 95 % level of confidence, implying a false-compliant rate < 5 %, and on a $RSD_R < 25$ %. The decision limit of the confirmatory method is the maximum level, taking into account the expanded measurement uncertainty.

In practice, the cut-off value (in BEQ) may be calculated from the following approaches (see Figure 1):

7.3.1. Use of the lower band of the 95 % prediction interval at the decision limit of the confirmatory method

$$\text{Cut-off value} = \text{BEQ}_{\text{DL}} - s_{y,x} \times t_{\alpha, f = m - 2} \sqrt{1/n + 1/m + (x_i - \bar{x})^2 / Q_{xx}}$$

with:

BEQ_{DL}	BEQ corresponding to the decision limit of the confirmatory method, being the ML taking into account the expanded measurement uncertainty
$s_{y,x}$	residual standard deviation
$t_{\alpha, f = m - 2}$	student factor ($\alpha = 5$ %, $f =$ degrees of freedom, single-sided)
m	total number of calibration points (index j)
n	number of repetitions on each level

x_i sample concentration (in TEQ) of calibration point I determined by a confirmatory method

\bar{x} mean of the concentrations (in TEQ) of all calibration samples

$$Q_{xx} = \sum_{j=1}^m (x_j - \bar{x})^2 \text{ square sum parameter}$$

i = index for calibration point i

7.3.2. Calculation from bioanalytical results (corrected for blank and recovery) of multiple analyses of samples ($n \geq 6$) contaminated at the decision limit of the confirmatory method, as the lower endpoint of the data distribution at the corresponding mean BEQ value:

$$\text{Cut-off value} = \text{BEQ}_{\text{DL}} - 1,64 \times \text{SD}_R$$

with

SD_R standard deviation of bioassay results at BEQ_{DL} , measured under within-laboratory reproducibility conditions

7.3.3. Calculation as mean value of bioanalytical results (in BEQ, corrected for blank and recovery) from multiple analysis of samples ($n \geq 6$) contaminated at two-thirds of the maximum or action level. This is based on the observation that this level will be around the cut-off determined under point 7.3.1 or 7.3.2.

Calculation of cut-off values based on a 95 % level of confidence implying a false-compliant rate < 5 %, and a $\text{RSD}_R < 25 \%$:

1. from the lower band of the 95 % prediction interval at the decision limit of the confirmatory method,
2. from multiple analysis of samples ($n \geq 6$) contaminated at the decision limit of the confirmatory method as the lower endpoint of the data distribution (represented in the figure by a bell-shaped curve) at the corresponding mean BEQ value.

Figure 1

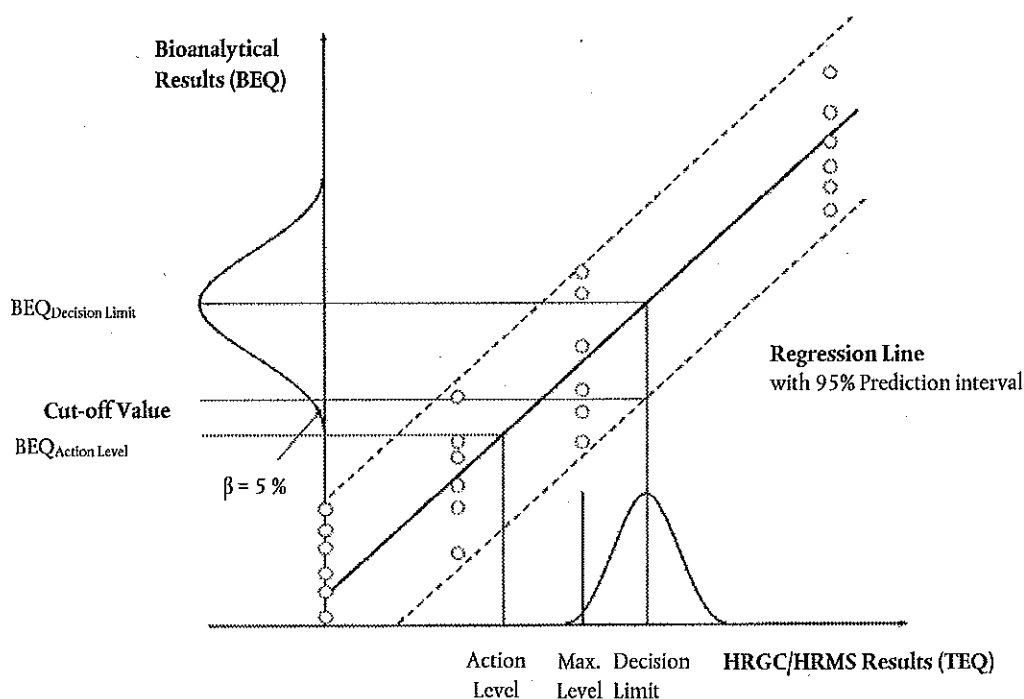

7.3.4. Restrictions to cut-off values

BEQ-based cut-off values calculated from the RSD_r achieved during validation using a limited number of samples with different matrix/congener patterns may be higher than the TEQ-based maximum or action levels due to a better precision than attainable in routine when an unknown spectrum of possible congener patterns has to be controlled. In such cases, cut-off values shall be calculated from an $RSD_r = 25\%$, or two-thirds of the maximum or action level shall be preferred.

7.4. Performance characteristics

- Since no internal standards can be used in bioanalytical methods, tests on repeatability shall be carried out to obtain information on the standard deviation within and between test series. Repeatability shall be below 20 % and intra-laboratory reproducibility shall be below 25 %. This shall be based on the calculated levels in BEQs after blank and recovery correction.
- As part of the validation process, the test must be shown to discriminate between a blank sample and a level at the cut-off value, allowing the identification of samples above the corresponding cut-off value (see point 7.1.2).
- Target compounds, possible interferences and maximum tolerable blank levels shall be defined.
- The per cent standard deviation in the response or concentration calculated from the response (only possible in working range) of a triplicate determination of a sample extract shall not be above 15 %.
- The uncorrected results of the reference sample(s) expressed in BEQs (blank and at the maximum or action level) shall be used for evaluation of the performance of the bioanalytical method over a constant time period.
- QCcharts for procedure blanks and each type of reference sample shall be recorded and checked to make sure the analytical performance is in accordance with the requirements, in particular for the procedure blanks with regard to the requested minimum difference to the lower end of the working range and for the reference samples with regard to within-laboratory reproducibility. Procedure blanks must be well controlled in order to avoid false-compliant results when subtracted.
- The results from the confirmatory methods of suspected samples and 2 to 10 % of the compliant samples (minimum of 20 samples per matrix) shall be collected and used to evaluate the performance of the screening method and the relationship between BEQs and TEQs. This database might be used for re-evaluation of cut-off values applicable to routine samples for the validated matrices.
- Successful method performance may also be demonstrated by participation in ring trials. The results from samples analysed in ring trials, covering a concentration range up to, e.g. $2 \times ML$, may also be included in the evaluation of the false-compliant rate, if a laboratory is able to demonstrate its successful performance. The samples shall cover most frequent congener patterns, representing various sources.
- During incidents, the cut-off values may be re-evaluated, reflecting the specific matrix and congener patterns of this single incident.

8. REPORTING OF THE RESULT

Confirmatory methods

- The analytical results shall contain the levels of the individual PCDD/F and dioxin-like PCB congeners and TEQ-values shall be reported as lower-bound, upper-bound and medium-bound in order to include a maximum of information in the reporting of the results and thereby enabling the interpretation of the results according to specific requirements.
- The report shall also include the method used for extraction of PCDD/Fs, dioxin-like PCBs and lipids. The lipid content of the sample shall be determined and reported for food matrices with maximum levels expressed on fat basis and with an expected fat concentration in the range of 0-2 % (in correspondence to existing legislation). For other samples, the determination of the lipid content is optional.

- The recoveries of the individual internal standards must be made available in case the recoveries are outside the range mentioned in point 6.2 where the maximum level is exceeded (in this case, the recoveries for one of the two duplicate analysis) and in other cases upon request.
- As the expanded measurement uncertainty is to be taken into account when deciding about the compliance of a sample, this parameter shall also be made available. Thus, analytical results shall be reported as $x \pm U$ whereby x is the analytical result and U is the expanded measurement uncertainty using a coverage factor of 2 which gives a level of confidence of approximately 95 %. In case of a separate determination of PCDD/Fs and dioxin-like-PCBs the sum of the estimated expanded uncertainty of the separate analytical results of PCDD/Fs and dioxin-like PCBs has to be used for the sum of PCDD/Fs and dioxin-like PCBs.
- The results shall be expressed in the same units and with the same number of significant figures as the maximum levels laid down in Regulation (EC) No 1881/2006.

Bioanalytical screening methods

- The result of the screening shall be expressed as compliant or suspected to be non-compliant ('suspected').
- In addition, an indicative result for PCDD/F and/or dioxin-like PCBs expressed in BEQ (not TEQ) may be given (see point 1). Samples with a response below the reporting limit shall be expressed as lower than the reporting limit. Samples with a response above the working range shall be reported as exceeding the working range and the level corresponding to the upper end of the working range shall be given in BEQ.
- For each type of sample matrix, the report shall mention the maximum or action level on which the evaluation is based.
- The report shall mention the type of test applied, the basic test principle and kind of calibration.
- The report shall also include the method used for extraction of PCDD/Fs, dioxin-like PCBs and lipids. The lipid content of the sample shall be determined and reported for food matrices with maximum levels expressed on fat basis and with an expected fat concentration in the range of 0-2 % (in correspondence to existing legislation). For other samples, the determination of the lipid content is optional.
- In the case of samples suspected to be non-compliant, the report needs to include a note on the action to be taken. The concentration of PCDD/Fs and the sum of PCDD/Fs and dioxin-like PCBs in those samples with elevated levels has to be determined/confirmed by a confirmatory method.
- Non-compliant results shall only be reported from confirmatory analysis.

Physico-chemical screening methods

- The result of the screening shall be expressed as compliant or suspected to be non-compliant ('suspected').
- For each type of sample matrix, the report shall mention the maximum or action level on which the evaluation is based.
- In addition, levels for individual PCDD/F and/or dioxin-like PCB congeners and TEQ-values reported as lower-bound, upper-bound and medium-bound may be given. The results shall be expressed in the same units and with (at least) the same number of significant figures as the maximum levels laid down in Regulation (EC) No 1881/2006.
- The recoveries of the individual internal standards must be made available in case the recoveries are outside the range mentioned in point 6.2 and in other cases upon request.
- The report shall mention the GC-MS method applied.
- The report shall also include the method used for extraction of PCDD/Fs, dioxin-like PCBs and lipids. The lipid content of the sample shall be determined and reported for food matrices with maximum levels expressed on fat basis and with an expected fat concentration in the range of 0-2 % (in correspondence to existing legislation). For other samples, the determination of the lipid content is optional.

-
- In case of samples suspected to be non-compliant, the report needs to include a note on the action to be taken. The concentration of PCDD/Fs and the sum of PCDD/Fs and dioxin-like PCBs in those samples with elevated levels has to be determined/confirmed by a confirmatory method.
 - Non-compliance can only be decided after confirmatory analysis.

Appendix

WHO-TEFs for human risk assessment based on the conclusions of the World Health Organisation (WHO) 0151 International Programme on Chemical Safety (IPCS) expert meeting which was held in Geneva in June 2005 ⁽¹⁾

Congener	TEF value	Congener	TEF value
Dibenzo-p-dioxins ('PCDDs')		'Dioxin-like' PCBs	
		Non-ortho PCBs + Mono-ortho PCBs	
2,3,7,8-TCDD	1		
1,2,3,7,8-PeCDD	1	Non-ortho PCBs	
1,2,3,4,7,8-HxCDD	0,1	PCB 77	0,0001
1,2,3,6,7,8-HxCDD	0,1	PCB 81	0,0003
1,2,3,7,8,9-HxCDD	0,1	PCB 126	0,1
1,2,3,4,6,7,8-HpCDD	0,01	PCB 169	0,03
OCDD	0,0003		
Dibenzofurans ('PCDFs')		Mono-ortho PCBs	
2,3,7,8-TCDF	0,1	PCB 105	0,00003
1,2,3,7,8-PeCDF	0,03	PCB 114	0,00003
2,3,4,7,8-PeCDF	0,3	PCB 118	0,00003
1,2,3,4,7,8-HxCDF	0,1	PCB 123	0,00003
1,2,3,6,7,8-HxCDF	0,1	PCB 156	0,00003
1,2,3,7,8,9-HxCDF	0,1	PCB 157	0,00003
2,3,4,6,7,8-HxCDF	0,1	PCB 167	0,00003
1,2,3,4,6,7,8-HpCDF	0,01	PCB 189	0,00003
1,2,3,4,7,8,9-HpCDF	0,01		
OCDF	0,0003		

Abbreviations used: 'T' = tetra; 'Pe' = penta; 'Hx' = hexa; 'Hp' = hepta; 'O' = octa; 'CDD' = chlorodibenzodioxin; 'CDF' = chlorodibenzofuran; 'CB' = chlorobiphenyl.

⁽¹⁾ Martin van den Berg et al., The 2005 World Health Organisation Re-evaluation of Human and Mammalian Toxic Equivalency Factors for Dioxins and Dioxin-like Compounds. Toxicological Sciences 93(2), 223-241 (2006).

ANNEX IV

SAMPLE PREPARATION AND REQUIREMENTS FOR METHODS OF ANALYSIS USED IN CONTROL OF THE LEVELS OF NON-DIOXIN-LIKE PCBs IN CERTAIN FOODSTUFFS

The requirements set out in this Annex shall be applied where foodstuffs are analysed for the official control of the levels of non-dioxin-like PCBs and as regards sample preparation and analytical requirements for other regulatory purposes, including the controls performed by the food business operator to ensure compliance with the provisions in Article 4 of Regulation (EC) No 852/2004.

The provisions on sample preparation provided for in point 3 of Annex III of this Regulation shall also be applicable for the control of the levels of non-dioxin-like PCBs in food.

1. Applicable detection methods

Gas Chromatography/Electron Capture Detection (GC-ECD), GC-LRMS, GC-MS/MS, GC-HRMS or equivalent methods.

2. Identification and confirmation of analytes of interest:

- Relative retention time in relation to internal standards or reference standards (acceptable deviation of $\pm 0,25$ %).
- Gas chromatographic separation of the non-dioxin-like PCBs (from interfering substances, especially co-eluting PCBs, in particular if levels of samples are in the range of legal limits and non-compliance is to be confirmed ⁽¹⁾).
- For GC-MS techniques:
 - Monitoring of at least the following number of molecular ions or characteristic ions from the molecular cluster:
 - two specific ions for HRMS,
 - three specific ions for LRMS,
 - two specific precursor ions, each with one specific corresponding transition product ion for MS-MS.
 - Maximum permitted tolerances for abundance ratios for selected mass fragments:
Relative deviation of abundance ratio of selected mass fragments from theoretical abundance or calibration standard for target ion (most abundant ion monitored) and qualifier ion(s): ± 15 %.
- For GC-ECD:
Confirmation of results exceeding the maximum level with two GC columns with stationary phases of different polarity.

3. Demonstration of performance of method:

Validation in the range of the maximum level (0,5 to 2 times the maximum level) with an acceptable coefficient of variation for repeated analysis (see requirements for intermediate precision in point 8).

4. Limit of quantification:

The sum of the LOQs ⁽²⁾ of non-dioxin-like PCBs shall not be higher than one-third of the maximum level ⁽³⁾.

5. Quality control:

Regular blank controls, analysis of spiked samples, quality control samples, participation in interlaboratory studies on relevant matrices.

⁽¹⁾ Congeners often found to co-elute are, e.g. PCB 28/31, PCB 52/69 and PCB 138/163/164. For GC-MS also possible interferences from fragments of higher chlorinated congeners have to be considered.

⁽²⁾ The principles as described in the 'Guidance Document on the Estimation of LOD and LOQ for Measurements in the Field of Contaminants in Feed and Food' [link to website] shall be followed when applicable.

⁽³⁾ It is highly recommendable to have a lower contribution of the reagent blank level to the level of a contaminant in a sample. It is in the responsibility of the laboratory to control the variation of blank levels, in particular, if the blank levels are subtracted.

6. Control of recoveries:

- Use of suitable internal standards with physico-chemical properties comparable to analytes of interest.
- Addition of internal standards:
 - Addition to products (before extraction and clean-up process),
 - Addition also possible to extracted fat (before clean-up process), if maximum level is expressed on fat basis.
- Requirements for methods using all six isotope-labelled non-dioxin-like PCB congeners:
 - Correction of results for recoveries of internal standards,
 - Generally acceptable recoveries of isotope-labelled internal standards are between 60 and 120 %,
 - Lower or higher recoveries for individual congeners with a contribution to the sum of non-dioxin-like PCBs below 10 % are acceptable.
- Requirements for methods using not all six isotope-labelled internal standards or other internal standards:
 - Control of recovery of internal standard(s) for every sample,
 - Acceptable recoveries of internal standard(s) between 60 and 120 %,
 - Correction of results for recoveries of internal standards.
- The recoveries of unlabelled congeners shall be checked by spiked samples or quality control samples with concentrations in the range of the maximum level. Acceptable recoveries for these congeners are between 60 and 120 %.

7. Requirements for laboratories

In accordance with the provisions of Regulation (EC) No 882/2004, laboratories shall be accredited by a recognised body operating in accordance with ISO Guide 58 to ensure that they are applying analytical quality assurance. Laboratories shall be accredited following the EN ISO/IEC 17025 standard. In addition, the principles as described in Technical Guidelines for the estimation of measurement uncertainty and limits of quantification for PCB analysis shall be followed when applicable ⁽¹⁾.

8. Performance characteristics: Criteria for the sum of non-dioxin-like PCBs at the maximum level

	Isotope dilution mass spectrometry ^(*)	Other techniques
Trueness	- 20 to + 20 %	- 30 to + 30 %
Intermediate precision (RSD _R)	≤ 15 %	≤ 20 %
Difference between upper and lower bound calculation	≤ 20 %	≤ 20 %

^(*) Use of all six ¹³C-labelled analogues as internal standards required

9. Reporting of results

- The analytical results shall contain the levels of the individual non-dioxin-like PCB congeners and the sum of non-dioxin-like PCBs, reported as lower-bound, upper-bound and medium-bound, in order to include a maximum of information in the reporting of the results and thereby enabling the interpretation of the results according to specific requirements.

⁽¹⁾ 'Guidance Document on Measurement Uncertainty for Laboratories performing PCDD/F and PCB Analysis using Isotope Dilution Mass Spectrometry' [link to website], 'Guidance Document on the Estimation of LOD and LOQ for Measurements in the Field of Contaminants in Feed and Food' [link to website].

-
- The report shall also include the method used for the extraction of PCBs and lipids. The lipid content of the sample shall be determined and reported for food matrices with maximum levels expressed on fat basis and with an expected fat concentration in the range of 0-2 % (in correspondence to existing legislation). For other samples, the determination of the lipid content is optional.
 - The recoveries of the individual internal standards must be made available in case the recoveries are outside the range mentioned in point 6, in case the maximum level is exceeded and in other cases upon request.
 - As the expanded measurement uncertainty is to be taken into account when deciding about the compliance of a sample, that parameter shall also be made available. Thus, analytical results shall be reported as $x \pm U$ whereby x is the analytical result and U is the expanded measurement uncertainty using a coverage factor of 2 which gives a level of confidence of approximately 95 %.
 - The results shall be expressed in the same units and with the same number of significant figures as the maximum levels laid down in Regulation (EC) No 1881/2006.

Annex VI:

Guidelines for monitoring chemical contaminants in the sea using marine organisms



UNITED NATIONS ENVIRONMENT PROGRAMME

SEPTEMBER 1992

*Guidelines for monitoring
chemical contaminants in
the sea using marine organisms*

Reference Methods For Marine Pollution Studies No. 6

Prepared in co-operation with



FAO



IOC



IAEA

UNEP 1992

NOTE: This document has been prepared in co-operation between the United Nations Environment Programme (UNEP), The Food and Agriculture Organization of the United Nations (FAO), the International Atomic Energy Agency (IAEA) and the Intergovernmental Oceanographic Commission (IOC) under project FP/S102-88-03 (2849).

For bibliographic purposes this document may be cited as:

UNEP/FAO/IOC/IAEA: Guidelines for monitoring chemical contaminants in the sea using marine organisms. Reference Methods for Marine Pollution Studies No. 6, UNEP 1992.

PREFACE

The Regional Seas Programme was initiated by UNEP in 1974. Since then the Governing Council of UNEP has repeatedly endorsed a regional approach to the control of marine pollution and the management of marine and coastal resources and has requested the development of regional action plans. The Regional Seas Programme at present includes ten regions and has over 120 coastal States participating in it (1),(2).

One of the basic components of the action plans sponsored by UNEP in the framework of the Regional Seas Programme is the assessment of the state of the marine environment and of its resources, and of the sources and trends of the pollution, and the impact of pollution on human health, marine ecosystems and amenities. In order to assist those participating in this activity and to ensure that the data obtained through this assessment can be compared on a world-wide basis and thus contribute to the Global Environment Monitoring System (GEMS) of UNEP, a set of Reference Methods and Guidelines for marine pollution studies are being developed as part of a programme of comprehensive technical support which includes the provision of expert advice, reference methods and materials, training and data quality assurance (3). The Methods are recommended to be adopted by Governments participating in the Regional Seas Programme.

The methods and guidelines are prepared in co-operation with the relevant specialized bodies of the United Nations system as well as other organizations and are tested by a number of experts competent in the field relevant to the methods described.

In the description of the methods and guidelines the style used by the International Organization for Standardization (ISO) is followed as closely as possible.

The methods and guidelines, as published in UNEP's series of Reference Methods for Marine Pollution Studies, are not considered as final. They are planned to be periodically revised taking into account the development of our understanding of the problems, of analytical instrumentation and the actual need of the users. In order to facilitate these revisions the users are invited to convey their comments and suggestions to:

Marine Environmental Studies Laboratory
IAEA Marine Environment Laboratory
19, Avenue des Castellans
MC 98000 MONACO

which is responsible for the technical co-ordination of the development, testing and intercalibration of Reference Methods.

-
- | | | |
|-----|----------------|--|
| (1) | UNEP: | Achievements and planned development of the UNEP's Regional Seas Programme and comparable programmes sponsored by other bodies. UNEP Regional Seas Reports and Studies No. 1 UNEP, 1982. |
| (2) | P. HULM: | A Strategy for the Seas. The Regional Seas Programme: Past and Future, UNEP 1983. |
| (3) | UNEP/IAEA/IOC: | Reference Methods and Materials: A Programme of comprehensive support for regional and global marine pollution assessments. UNEP 1990. |

- ii -

The present document was prepared at the initiative of FAO, the Food and Agriculture Organization of the United Nations as part of its contribution to the Regional Seas Programme and in particular the Mediterranean Action Plan. The assistance of Dr. G. Topping with this work is particularly appreciated. The document was subsequently edited at IAEA's Marine Environmental Laboratory and reviewed by GEMSI, the IOC/UNEP Group of Experts on Methods, Standards and Intercalibration. The assistance of all those who participated in this work is gratefully acknowledge.

CONTENTS

	<u>Page</u>
1. Scope and field of application	1
2. References	1
3. Introduction	2
4. Definitions	3
5. Aims of monitoring programmes	4
6. Pilot study	5
7. Designing a monitoring programme	6
8. Selection of contaminants	7
9. Selection of organisms	8
10. Location of sampling sites	10
11. Period and frequency of sampling	11
12. Size of sample	12
13. Selection of tissue	13
14. Appendix 1: Guidance on the planning of a pilot study	14
15. Appendix 2: Documentation of data	17
16. Appendix 3: Examples of chemical substances measured in marine organisms from monitoring purposes	18
17. Appendix 4: A) List of MED-POL species B) List of possible organisms for the assessment of contamination in the North Atlantic Region	19
18. Appendix 5: Detection of differences in levels of contaminants in marine organisms in relation to spatial; and trend monitoring programmes	21

1. SCOPE AND FIELD OF APPLICATION

This publication provides guidelines for monitoring chemical contaminants in the sea using measurements in marine organisms. It describes strategies for applying such measurements to the protection of public health, the assessment of the geographical distribution of contaminants and the evaluation of time trends in contamination which in turn can demonstrate the effectiveness of measures designed to control potential sources of pollution.

2. REFERENCES

The following are useful publications to consult in relation to the design, planning and conduct of marine pollution monitoring programmes using marine organisms:

- BRYAN, G.W., LANGSTONE, W.J. and HUMMERSTONE, L.G. (1980). The use of biological indicators of heavy metal contamination in estuaries. Marine Biological Association of the United Kingdom, Occasional publication Number 1, June 1980, 73 p.
- BURNS, K.A. and SMITH, J.L. (1981). Biological monitoring of ambient water quality: the case for using sentinel organisms for monitoring petroleum pollution in coastal waters. *Estuar. Coastal Shelf Sci.*, 13: 433-443.
- DAVIES, I.M. and PIRIE, J.M. (1980). Evaluation of a "Mussel Watch" project for heavy metals in Scottish Coastal waters. *Mar.Biol.*, 57: 87-93.
- GOLDBERG, E.D., BOWEN, V.T., FARRINGTON, J.W., HARVEY, G., MARTIN, J.H., PARKER, P.L., RISEBOROUGH, R.W., ROBERTSON, W., SCHNEIDER, E. and GANBLE, E. (1978). The "Mussel Watch". *Environ.Conserv.*, 5: 101-125.
- GORDON, M., KNAUER, G.A. and MARTIN, J.H. (1980). *Mytilus californianus* as a bio-indicator of trace metal pollution: variability and statistical considerations. *Mar.Pollut.Bull.*, 11: 195-198.
- PHILLIPS, D.J.H., (1980). Quantitative aquatic biological indicators: Their use to monitor trace metal and organochlorine pollution. Pollution Monitoring Series, London, Applied Science Publishers Ltd, 488 p.
- PHILLIPS, D.J.H. and SEGAR, D.A. (1986). Use of bio-indicators in monitoring conservative contaminants: Programme design imperatives. *Mar.Pollut.Bull.*, 17(1): 10-17.
- SEGAR, D.A. and STAMMAN, E. (1986). Fundamentals of marine pollution monitoring programme design. *Mar.Pollut.Bull.*, 17(5): 194-200.
- TOPPING, G. (1983). Guidelines for the use of biological material in the first order pollution assessment and trend monitoring. Dept. of Agriculture and Fisheries for Scotland, Marine Laboratory, Scottish Fisheries Research Report No 28. ISSN 0308 8022, 28 p.

3. INTRODUCTION

Marine organisms can accumulate contaminants from seawater, suspended particulate matter, sediments and their food. It has also been demonstrated, through field observations and experimental studies, that the concentration of some contaminants in tissues are related to the concentrations in the surrounding environment. This process, termed bio-accumulation, has been used by scientists to assess the marine contamination which has been caused by man's activities (eg. marine disposal of wastes by pipeline discharges and dumping from ships).

There are however certain difficulties in using bio-accumulators, or bio-indicators as they are sometimes known, for this purpose. For example, individuals of the same species exposed to the same concentration of contaminants for the same period of time will not accumulate the substances at the same rate. This is related to such factors as age, sex, size and physiological state of the individual. Similarly, different species do not bio-accumulate to the same level when they are exposed to the same concentration of contaminant in sea water, and often have different rates of contaminant elimination.

Therefore, careful consideration must be given to the above factors when a monitoring programme is designed in order to reduce (or allow for) the effects of natural variability.

This document provides guidance on the design of such programmes and is intended for scientists who are responsible for marine pollution monitoring programmes. It is particularly aimed at programmes which fall under the auspices of the UNEP, IOC and FAO.

The guidelines presented in this report cover the following aspects of marine pollution monitoring programmes:

- aims
- pilot studies
- criteria for the selection of contaminants, organisms and locations to be studied
- size of sample
- frequency of sampling operations
- tissue selection.

Although an important component of these programmes is the analysis of contaminants in samples, this matter will not be addressed in detail in this document since other UNEP Reference Methods For Marine Pollution Studies cover this topic. Readers of this document are therefore advised to have the relevant analytical documents to hand (see UNEP/IOC/IAEA 1990); particularly "Contaminant monitoring programmes using marine organisms: Quality Assurance and Good Laboratory Practice" Reference Method No 57, since this deals with all aspects of work which influence the quality of data.

4. DEFINITIONS

Before discussing the programmes for which these guidelines may be used, it is necessary to define some of the more important terms which are used in this report.

Term	Definition
Accuracy, precision limit of detection	See definitions in Appendix 2 of Reference Method No 57.
Anthropogenic	Derived from human activity
Contamination	in the context of the marine environment this term describes a situation where either the concentrations of some natural substances (eg. metals) are clearly above normal values, or the concentrations of man-made substances (eg. DDT) is detectable but which do not necessarily cause deleterious effects (referred to as pollution, see definition below).
Bio-indicator	A species which accumulates a contaminant in its tissue in amounts that are proportional to the levels of the contaminant in the local environment (ie. water, sediment and food).
Hot spot	An area of the sea where there is a significantly high level of contamination
Pollution	The Group of Experts on Scientific Aspects of Marine Pollution defines pollution as "the introduction by man, directly or indirectly, of substances or energy into the marine environment (including estuaries) which results in such deleterious effects as harm to living resources, hazards to human health, hindrance to marine activities including fishing, impairment of quality for use of seawater and reduction of amenities."
Monitoring	A programme of repeated measurements of contaminants in marine samples which is carried out for a specific purpose eg. annual measurements of mercury in the edible tissue of fish to provide information on the potential annual intake of mercury by consumers. A study of mercury in fish which examines levels in different species would not be classed as monitoring. If, however, this study was repeated in subsequent years these sets of data would be classed as 'monitoring data'.

Pilot study	Measurements of contaminants in marine samples, in an area not previously studied, to investigate the current levels of contamination. This work is a prerequisite to a monitoring programme since the information collected in this study enables the investigator to design the sampling programme suited to the specific aims of the monitoring work. Without such information the investigator may be unable to judge which contaminants, organisms and locations to select for the monitoring programme.
Quality Assurance	All procedures that are carried out by a laboratory to ensure that it produces data of the appropriate quality to meet the defined aims of its monitoring programme. Quality Assurance essentially consists of two elements - quality control and quality assessment. Definitions of these latter terms are given in UNEP Reference Method No 57.

5. AIMS OF MONITORING PROGRAMMES

There are three principal aims of monitoring programmes which involve the collection and analysis of marine organisms; they are:

- to compare contaminant levels in the edible tissues of marine organisms against national limits and to provide data to calculate the potential amount of contaminant taken in by consumers (ie Public Health monitoring).
- to compare the levels of contamination in different geographical areas (Spatial Monitoring). Such measurements are often made to assess whether the current discharges of wastes are producing unacceptable levels of contamination ie they are causing, or likely to cause, marine pollution problems.
- to measure the levels of contaminants over time at particular locations to judge whether they are changing in relation to the inputs of contaminants (ie Trend Monitoring). Such measurements are made to assess the efficiency of measures taken to reduce pollution.

Investigators should write down the specific aims of each monitoring programme before commencing any field measurements. These aims are needed to narrow the list of parameters, species and sites to be investigated). There are two distinct aspects of aims:

Environmental management - Are standards complied with? What is the spatial extent of contamination? What are the changes of levels with time in relation to changes in inputs of contaminants?

Environmental science - Statistical significance of differences in levels of contaminants - representative sampling of the population - selection of analytical methods with the required accuracy and precision.

6. PILOT STUDY

This assists the investigator in the design of an efficient monitoring programme for each specific aim. Provided a pilot study is carefully planned (see Appendix 1 for guidance), it can provide the following information:

- a) In relation to public health studies, it can identify the relevant edible species, particularly the ones which contain elevated levels of regulated contaminants and therefore merit further investigation to determine the need for additional regulatory action, such as input controls or restriction on the harvesting or consumption of fish/shellfish.
- b) It can identify which areas of the marine environment are sufficiently contaminated to warrant monitoring.
- c) It can provide an indication of the variability of contaminant levels in individuals of the same species from the same population and location. This information is essential to an investigator wishing to establish a programme of trend monitoring. Without it, he may not be able to judge whether his sampling and analytical work will be sufficiently detailed to detect changes in contaminant levels with time against the natural fluctuations that may exist in any population of organisms.
- d) It can identify which tissues of organisms, particularly fish and large shellfish, are the most appropriate ones to use in specific monitoring programmes since not all tissues reflect changes in the levels of contaminants in the environment to which the organism is exposed.
- e) It can identify, and sometimes quantify, inputs of contaminants to the study area. This will help the investigator to select which contaminants should be given priority, if the resources for monitoring are limited, and in which areas contaminated organisms are likely to be found.

A pilot study can easily be expanded in order to accommodate measurements of biological effects. These effects may include changes in community structure and populations or adverse changes in the biochemistry of organisms (for example, acetyl cholinesterase depression by organophosphorus pesticides). Linkage of "levels" with "effects" is an important step in a complete pollution assessment. When effects are noted on a pilot scale, associated with specific contaminants or groups of contaminants, a strong case can be made for incorporating such contaminants in a full-scale monitoring programme and for taking immediate measures for their control and abatement. Details of some biological effects measurements are included in the Reference Method Series (see UNEP/IOC/IAEA, 1990).

Once a pilot study has been successfully completed, and the results evaluated, the investigator should prepare a protocol for each specific monitoring programme for the collection and analysis of samples. This protocol will specify what information is required to meet the specific aims, and the criteria to obtain the required quantity and quality of data. Time spent on the planning of a statistically significant sampling and analytical programme, will inevitably produce a more efficient programme which makes the best use of the laboratory's most important resource (ie staff time). Initially, it is generally sensible to conduct a programme which satisfies essential, rather than very ambitious, aims. It is relatively easy to expand this basic programme if extra resources become available. Finally, it is necessary to review the monitoring programme on a regular basis, to assess how well the aims are being met. This review may result in a reduction of effort on sampling and analyses, and the time gained can be usefully employed on other aspects of marine pollution studies. However, it might identify the need to put in more effort.

7. DESIGNING A MONITORING PROGRAMME

There are a number of factors to be considered in the planning of a monitoring programme which is to meet specific aims:

- a) Which contaminants should be measured?
- b) Which organism(s) should be selected?
- c) Where should the samples be collected?
- d) When should the sampling be done and how frequently should it be carried out?
- e) How many individual organisms should be collected on each sampling occasion and which size(s) should be included in each sample?
- f) Which tissue(s) of the organism(s) should be selected for analysis?

It is the principal investigator, together with a knowledgeable statistician and biologist, who will have to do this evaluation, design and plan the sampling work, prepare the necessary instruction sheets for the field staff, discuss with the analysts the precautions to be taken by staff in the storage and processing of samples prior to their analysis.

Specifically, the investigator will have to do the following:

- (i) Design a sampling programme for the organisms of interest; selecting sufficient numbers, and sizes, of individuals at each site at appropriate intervals of time to take into account the inherent variability of contaminant levels in the organisms. This work will be done on the basis of the results obtained from the pilot study and any relevant information from other similar studies. Sampling must be designed to provide a statistically sound basis on which to judge changes in contaminant levels. Once this sampling programme has been designed, instruction sheets should be prepared and issued to the field staff.
- (ii) Ensure that samples are collected, stored and transported to the laboratory in a way which minimizes losses and gains of contaminants prior to analysis. Guidance on this can be obtained by consulting the relevant documents in the UNEP Reference Methods series. Again it will be necessary to prepare instruction sheets for field and laboratory staff.
- (iii) Arrange for the processed samples to be analyzed using methods which have the required accuracy and precision. Experience has shown that close collaboration between the principal investigator and the analysts is essential if this work is to be successful. The investigator and the principal analyst should consult the UNEP Reference Method No 57 which gives guidelines on Quality Assurance, if they are in any doubt about how to achieve and maintain the required quality of analytical data.
- (iv) Ensure that there is an adequate system of documentation to allow samples to be traced from the time of collection to the recording of analytical data. The investigator should ensure that all relevant staff are aware of, and comply with, the system of documentation (see Appendix 2 for more details on this matter).

Each of the factors a - f will now be considered in more detail.

8. SELECTION OF CONTAMINANTS

The selection of substances to be monitored will be determined by a) the aims of the monitoring programme, b) the findings of the pilot study (ie which contaminants, present at significant levels above the background values, justify further study), and c) the ability of the analyst to measure these substances with the required accuracy and precision. In practice the last factor will often determine whether a particular contaminant or group of contaminants can be included in the monitoring programme.

It is essential that the principal investigator and the principal analyst agree to the required accuracy, precision and limit of detection for the measurements to ensure that the necessary standards of analysis are achieved eg. it would be inappropriate to consider measurements of specific changes in contaminant levels using an analytical method which had an inadequate level of precision.

If the analytical method used in the pilot study does not meet the required standard for the specific monitoring purposes, the analyst must select another method which meets the required standard. If for any reason this is not possible (eg. there is a statutory requirement to use a particular method) the investigator should abandon the proposed monitoring programme. Any other action will merely result in wasted effort, since the aims will not be met using an inadequate analytical method. However, it must be stressed that the use of an analytical method which, in theory, has the required performance characteristics to meet the aims does not necessarily guarantee success. Other factors have to be taken into account in obtaining the required quality of analytical data. These are discussed in some detail in "Quality Assurance and Good Laboratory Practice in relation to Marine Pollution Monitoring Programmes", UNEP Reference Method No 57. Investigators are strongly advised to obtain a copy of this document for analysts at the outset of the work.

In addition to selecting contaminants to meet the aims of the laboratory's marine pollution programme, it may be appropriate to include other contaminants which meet regional and international needs. This should only be considered if the additional data is useful to the laboratory, or if it is part of the laboratory's commitment to Regional Studies, and does not jeopardize the main aims of the laboratory's monitoring programme. A list of contaminants, identified by some organizations (International Council for the Exploration of the Seas, Oslo and Paris Commission's Joint Monitoring Group) for monitoring work in the North Sea and adjacent waters as well as those recommended (category I and II substances) for the MED POL programme are given, for information, in Appendix 3.

The final selection of contaminants should also be related to knowledge of their likely sources (eg. an extensive monitoring programme for pesticides along a desert coastline would be unwarranted) and information from scientific literature on their transport and persistence in the environment. Such information will also help to identify which environmental compartment should most usefully be monitored. As an example, organophosphorus pesticides are rapidly metabolized by many marine organisms but are rather persistent in sediments. It would be pointless to monitor them in biota but highly relevant to monitor their biological effects.

9. SELECTION OF ORGANISMS

9.1 Spatial and trend monitoring

Experience has shown that the most reliable data on contaminant trends in organisms are obtained by sampling organisms which have the following characteristics:

- A simple relationship exists between contaminant residues in the organisms and the average concentrations in the surrounding seawater or sediments.
- The organism accumulates the contaminant without being affected by the levels encountered.
- The organism is sedentary and thus representative of the area of collection.
- The organism is widespread in the study region, to allow comparisons between different areas.
- The organism is sufficiently long-lived, to allow sampling of more than one year class if desired.
- The organism is of a reasonable size, to give adequate tissue for analysis.
- The organism is easy to sample and robust enough to survive in the laboratory, allowing (if desired) depuration before analysis and, if needed, studies of uptake of contaminants.
- The organism exhibits high concentration factors, to allow direct analysis without pre-concentration.
- The organism is tolerant of brackish water, to allow comparisons to be made between estuarine and offshore sites.

These characteristics restrict the useful organisms to a range of fairly large, abundant, widespread, inter-tidal organisms, mainly molluscs. Filter-feeding molluscs are more likely to reflect contaminants in the water column, whilst deposit feeders will also be influenced by sediment chemistry. The working of the sediments both by organisms and water currents will cause an averaging of short-term variations in contaminant loading. Water chemistry, however, will more rapidly respond to effluent discharges and dispersal conditions at the time of sampling. Filter-feeders are therefore more likely to provide the information required to fulfill the objectives of a monitoring programme concerned with water quality. In Appendix 4, lists are given of organisms which some scientists in the United Kingdom have suggested may be used for monitoring a range of metals and organochlorine compounds in either rocky or muddy inter-tidal areas in UK waters.

In practice the selection of an organism, for monitoring purposes, is determined by its availability in the study area and its known ability to act as a bio-indicator. If this latter information is not known it must be obtained from either the scientific literature (eg. Phillips 1980), or the pilot study. Final selection should be made in consultation with a knowledgeable biologist. Common mussels, (*Mytilus edulis*, *M. californianus* and *M. galloprovincialis*), that are used in global mussel watch programmes are generally suitable for spatial and trend monitoring programmes in coastal waters.

Other species of shellfish, and fish, can be used for spatial and trend monitoring purposes provided the organism can be shown to accumulate the specific contaminant(s) and that the concentrations of the contaminant(s) are in proportion to the concentrations in either water or sediment or food.

9.2 Public Health programmes

If the pilot study has revealed that edible species from the local fishery contain levels of contaminants which approach or exceed statutory limits for contaminants in foodstuffs, then these organisms should be included in any subsequent public health monitoring programme.

Since permissible limits of some contaminants (eg. Cd) in foodstuffs are extremely low, the analytical method for this work must be capable of producing the required data quality. A high degree of accuracy, and a detection limit which is ca 1/10 of the permissible concentration of the contaminant in the foodstuff, are essential for this work. These criteria enable the analyst to have confidence in the results that are provided to managers for regulatory purposes.

10. LOCATION OF SAMPLING SITES

10.1 Spatial and trend monitoring

Hot spots are usually found in estuarine and coastal areas where anthropogenic wastes are discharged. The offshore areas where hot spots are most likely to occur are those used for the dumping of wastes from ships or those in the vicinity of offshore oil platforms.

A decision to monitor contaminant levels in 'hot spots' should be taken only after careful consideration of the discharges to these areas. If, as a result of the pilot study, the relevant authorities decide to reduce inputs then it would be appropriate to monitor to judge whether the new controls have been effective in reducing levels in organisms. If no action is to be taken on the regulation of discharges then monitoring is only justified if there is a good reason to update the information collected in the pilot study.

Other estuarine, coastal and offshore sampling sites may be included in the programme to provide coverage of both clean and moderately contaminated areas. All sampling should be done by scientific personnel operating from research or chartered vessels, rather than by fishermen, to ensure that contamination of the samples during and after collection is kept within acceptable limits.

For long-term monitoring programmes, the precise locality of sampling sites should be registered as very small spatial variation may strongly influence the final data (ie "mussels from the harbour wall" should specify which point in the harbour wall). In some cases it may be useful to photograph the sites, particularly where intertidal organisms are taken.

10.2 Public Health Programmes

In some countries there may be officials who are knowledgeable about the edible species of fish and shellfish caught by commercial fishermen. Investigators may find it helpful to discuss their proposed monitoring programme with such officials since they can often offer valuable advice in the design of the collection programmes.

Samples of fish and shellfish may be obtained from the fish markets or from fishing vessels or research ships which are operating in traditional fishing areas. The basic requirement is a representative sample of the species normally consumed by the general public. It should be noted, however, that some countries may specify the exact sampling procedures for public health monitoring.

Commercial fishermen do not usually take any special precautions during the collection, storage, transport and off-loading of their catches, other than to ensure that they are presentable enough for sale. The retailer and the consumer do not normally adopt any stringent dissection procedures, other than from a public health viewpoint. The scientist, however, will use careful sampling and pre-treatment procedures to ensure that contamination is kept within acceptable limits. These different approaches to sampling may lead to differences in the amount of contaminants found in the samples. In general the scientific samples will be less contaminated than those taken from fish markets, fishing boats and fish retailers.

The final decision on where and how to collect samples for public health monitoring will depend on whether information is required on actual contaminant intake by the consumer (in which case samples will be taken from the fish markets or fish retailers) or whether the aim is to determine which edible species and areas are exposed to contamination (in which case the sampling must be done by scientific staff).

11. PERIOD AND FREQUENCY OF SAMPLING

11.1 Spatial and trend monitoring

For spatial monitoring, collections should be made over a short interval of time (within weeks rather than months) to enable a synoptic comparison of concentrations of contaminants at different sites. This also helps to ensure that organisms are in the same physiological state. If major annual changes in the quantity and/or composition of inputs are anticipated it would be appropriate to conduct an annual or biennial sampling. Experience has shown that the effects of changes in inputs of contaminants are often confined to the area in the immediate vicinity of the discharge. It is these areas where more frequent monitoring should be conducted.

For trend monitoring, the frequency of sampling will a) reflect the time scales over which the changes are required to be detected, b) the degree of confidence required in the measurement of these changes, and c) the available laboratory resources. Investigators should note that there is nothing more frustrating and time-wasting than a programme in which the proposed work is well below the minimum standard required to detect the desired changes in contaminant levels. If, for any reason, the resources are insufficient to meet the specific aims of the programme, then the programme should be canceled and replaced with one which has less ambitious aims but which can be carried out successfully with available resources.

If no changes in inputs are expected, then it would be sensible to restrict sampling to ca 5 yearly intervals. A more frequent sampling programme can only be justified if there is a need to provide more regular data for other purposes eg. to reassure the general public that levels of contaminants are not changing.

Seasonal variations in food supply, and the spawning cycle, are known to cause changes in total body weight, as well as lipid concentration and composition and, these may influence contaminant levels in the tissues of some organisms. In order to minimize these variations, it is suggested that sampling be undertaken at the pre-spawning period.

11.2 Public Health monitoring

Unless there is a seasonal fishing pattern for some species, samples may be taken at any time of the year. Ideally all species should be sampled at the same time so that a synoptic picture of the contaminant levels can be obtained. A typical monitoring programme might consist of a survey every 5 years. A more frequent sampling programme (ie annual) will be needed if the results of the pilot programme show that concentrations of contaminants in foodstuffs approach or exceed permissible limits for foodstuffs. Increased sampling should be confined to the particular species and contaminants which give cause for concern.

12. SIZE OF SAMPLE

12.1 Spatial and trend monitoring

Ideally, the investigator will have established the relationship between contaminant levels and size of organisms from the results of the pilot study. It is good practice to select a particular size or size range to minimize the variance of contaminant levels from sample to sample. The number of individuals required for each sample will be determined by the magnitude of the change that is considered to be significant in relation to the specific aims. The smaller the difference the greater the number of individuals required for each sample. (See Appendix 5 for further guidance)

If the relationship between size of organism and contaminant level has not been obtained from the pilot study then a sufficient number of individuals should be collected at one of the sampling sites to cover the size range of organisms in the population, to establish the variability of contaminant levels with size. This is a minimum requirement since, ideally, this sampling procedure should be done at all sites. The information on variability at one site will allow the investigator to make comparisons with other sites where individuals of a limited size range are collected.

If either analytical resources or sample material is limited it may not be practical for the individuals from each site to be analyzed separately. In this case, individuals should be combined to make one sample (often referred to as 'pooled' samples). For 'pooled samples', no information will be obtained on the variation of contaminant levels with size but the data can be used to assess site to site differences with some level of confidence, provided that a number of replicate analyses are done on each of the 'pooled' samples, and the 'pooled' samples consist of individuals from the same size range.

12.2 Public Health monitoring

The size(s) of organisms to be sampled should be based on information on consumption patterns. If a range of sizes is sold, then these different sizes should be analyzed. The number of individual organisms in each sample will be influenced by the importance of the species as a foodstuff, the availability of scientific manpower and the need to sample sufficient numbers of each species and of each size category to cover the range of values encountered in a typical population or catch. Generally, a sample of 5-10 individuals from each size range of fish and large shellfish (crabs, lobsters) and ca 50 individuals for smaller shellfish (eg. mussels, shrimps) would be sufficient.

13. SELECTION OF TISSUE

13.1 Spatial and trend monitoring

For invertebrates, whole soft tissue (less viscera) should be taken for analysis.

For fish, muscle is the most useful tissue for most purposes. However, liver and kidney tissues have been used for studies of fish and the digestive gland of large crustaceans. In general, whole soft tissue is taken for smaller shellfish.

13.2 Public Health monitoring

Only edible tissue need be analyzed for contaminants - usually this means muscle tissue for fish and large crustaceans and whole soft tissue (less viscera, ie guts, gills and gonad) for small shellfish.

Every opportunity should be taken to collect data on the size (or length) and age of the species. This may be relevant to subsequent decisions on regulatory action.

13.3 Normalization procedures

It is usual to report all tissue data on a dry weight basis (ie. g contaminant/g (dry weight)). However, some literature values use wet weight which may be required for public health studies. Since drying is a common part of most analytical protocols (see RM. No. 7 "Sampling of selected marine organisms and sample preparation for trace metal analysis" and RM. No. 12 "Sampling of selected marine organisms and sample preparation for the analysis of chlorinated hydrocarbons"), the reader is advised to record wet/dry weight ratios on a routine basis.

In the case of lipophilic contaminants, such as chlorinated hydrocarbons, contaminant concentrations are often expressed in terms of g contaminant/g HEOM (where HEOM is Hexane Extractable Organic Matter, principally lipid). This procedure enables a certain degree of normalization for seasonal or spatial variations in the lipid content of sentinel organisms and facilitates the comparability of data.

Appendix 1

GUIDANCE ON THE PLANNING OF A PILOT STUDY

Desk Study

It is important to determine what is known about contaminants in the proposed study area, before any field work is done. Some of this information can be found by reviewing the relevant scientific journals and other published material (eg. books, conference proceedings).

Annual reports of other marine institutes, local and central government and industrial research laboratories are also useful sources of data, as are unpublished scientific reports from these organizations. If these latter sources provide useful data, it is good practice to contact scientists from the relevant organizations to identify whether there is any other unpublished data or information, which might be useful to the investigator.

This review can often provide data on the current levels of contamination in water, sediments or biota and occasionally information on inputs of contaminants to the area via rivers, pipelines or dumping from ships. It may also reveal the type of industry and agriculture located in the coastal region, the range and scale of potentially toxic substances used by them, and possibly information on their discharges to the rivers and sea. These latter data should be verified by contacting the local or national authority, which has responsibility for regulating discharges to rivers and coastal waters. This authority should also be approached for information on the past and present discharges to the area.

For public health work, the investigator should identify which fish and shellfish species are caught for human consumption, and whether there are relevant permissible limits for contaminants in marine foodstuffs. Information on commercial catches can be obtained from either the local fishermen or their representative organizations or the local or central government fisheries department. Information on food standards can be obtained from the local environmental health department or the central government department responsible for food safety. It is difficult to be more specific about the exact sources of the above information in each country since they do vary from country to country.

This review should enable the principal investigator to identify the group of contaminants, and specific fish and shellfish, which should be given priority in the pilot study for public health purposes. It will also give some general guidance on the species to be selected for spatial and trend monitoring purposes. However, before the principal investigator can plan this latter work he needs to do some additional desk work to identify the locations where samples should be collected.

Identifying sampling sites

It is essential that the pilot study covers the areas which are likely to be contaminated and the areas which, from a hydrographic and input viewpoint, are unlikely to be significantly affected (ie sites located well offshore from industrialized areas or those located in inshore areas next to less populated and industrialized areas).

The level and extent of contamination in coastal and estuarine waters is determined by:

- the rate of input of contaminants
- the location of the individual inputs
- the composition of the waste - whether the contaminants are in solution, attached to solids or associated with mixtures of solid and liquid
- the dilution and dispersion of wastes following discharge, and in the case of discharges containing solids, the settlement of solid material to the sea bed sediments
- the physical and chemical processes in the sea (ie adsorption and desorption of substances between dissolved and particulate phases of seawater).

Unless the principal investigator has a good working knowledge of hydrography of the local area, it will be necessary to seek the help of an hydrographic expert to determine the optimum locations for sampling in relation to known inputs.

Assuming the principal investigator can provide the hydrographer with the relevant information on inputs, and that his colleague has a good understanding of the hydrographic characteristics of the area (direction, speed and variability of currents, salinity and temperature of the water masses, and the freshwater flows to the sea) it should be possible to calculate the theoretical dilution and dispersion of wastes at estuarine and coastal sites. This information can then be used to identify the locations where organisms are exposed to contamination and the adjacent areas where they will probably not be subject to contamination (ie clean or control areas).

If expert hydrographic advice is not available, the principal investigator should establish a sampling grid along the likely gradient of contamination; with sampling sites located at progressively increasing distances from the input (100m, 300m, 1000m, 3000m etc.). If a river is the principal source of contamination to the study area, the investigator can establish his sampling grid along the salinity gradient. It is relatively easy to calculate the dilution of river water, and the corresponding dilution of contaminants, by measuring the salinity at locations in an estuary and comparing these measurements with the salinity values of the water entering the estuary. For this calculation, the investigator assumes that river water has zero salinity and that the contaminants behave conservatively during mixing of freshwater and seawater.

Sample size

The concentration of some contaminants can vary with size of the organisms. It is important in spatial and trend monitoring to reduce this source of variability in the data to detect differences in contaminant levels between sites and with time (see Appendix 5). If this relationship is not known by the investigator prior to the commencement of monitoring, it will be necessary to establish it during the pilot study.

To do this, the investigator must collect a representative sample of each population of species at each sampling site. This sample should include sufficient numbers of individuals to cover the range of sizes/ages/lengths of individuals in each population. The investigator should consult a knowledgeable biologist for guidance on the range of sizes that might be expected for each species.

Selection of tissue

Although there is considerable scientific literature on the accumulation of contaminants by different tissues (eg. Phillips, 1980), it is advisable for the investigator to check this aspect for the specific organisms to be examined in the pilot study. It is also advisable to consult a biologist to determine the best procedure for dissection of organisms into their constituent parts, to ensure that there is no possibility of one tissue being contaminated by another.

Ideally, the investigator should investigate the relationship between the contaminant level, tissue and size of organism by analyzing tissue from individuals of different sizes rather than by analyzing pooled samples; even if the latter consist of a number of individuals of the same size or size range. However, if analytical resources are limited, it may be necessary for him to establish this relationship by analyzing pooled samples.

Appendix 2

DOCUMENTATION OF DATA

The adoption of the following guidelines by a laboratory should provide adequate documentation to allow it to trace samples from the collection stage to the completion of its analyses by providing a record of the appropriate data in logbooks or in computer files.

Documentation

- (i) Descriptions of the sampling strategy, methods of sample collection, procedures for storage, and pre-treatment and analytical procedures, plus a list of ancillary site observations;
- (ii) Sample documentation (description of organisms, numbers of individuals collected for each sample, weights of tissue taken for analysis (individual tissue or homogenate) plus ancillary data on organisms (length, weight and age);
- (iii) Description of analytical procedures, including details of accuracy, precision and limit of detection;
- (iv) Description of quality control and quality assessment and evidence that these procedures have been applied and have provided acceptable data;
- (v) Description of working standards used on each occasion and calculations of results;
- (vi) A secure system for the long term storage of data either in logbooks or computer files is essential. It is also advisable to have a duplicate set of records in case one is lost, mislaid or accidentally destroyed;

Advice should be sought on the correct method of storing computer tapes and/or discs to ensure the long-term stability of data files.

Storage of data

It has been shown that even the most experienced personnel can make simple arithmetic errors in calculating results. Thus, a check should be made for such errors before compiling tables of results. Once this check has been MADE it is appropriate to carry out a preliminary assessment of the quality of the data, prior to its evaluation and publication, to ensure that no erroneous results are included. This assessment can include a comparison of the results with existing data (ie data for the study area either previously collected by the laboratory or data published in the literature). Before consigning data to long term storage, a final check should be made to ensure that no errors have been made in transcribing the data (ie the re-typing of data sets by typists or data processors can sometimes lead to such errors).

Appendix 3

EXAMPLES OF CHEMICAL SUBSTANCES MEASURED IN MARINE ORGANISMS FOR MONITORING PURPOSES

(SOURCE:

Trace metals

Arsenic (As), Cadmium (Cd), Chromium (Cr), Copper (Cu), Lead (Pb), Mercury (Hg), Nickel (Ni), Tin (Sn), and Zinc (Zn).

DDT and its metabolites

o,p'-DDD, p,p'-DDD, o,p'-DDE, o,p'-DDT, and p,p'-DDT.

Chlorinated pesticides other than DDT

Aldrin, Alpha-Chlordane, Trans-Nonachlor, Dieldrin, Heptachlor, Heptachlor epoxide, Hexachlorobenzene, Lindane (gamma-BHC), and Mirex (+ Endosulfan ?)

Polychlorinated biphenyls (PCBs)

Measurements are usually restricted to either a small number of individual compounds (known as congeners) or to the total concentration of PCBs.

Polyaromatic hydrocarbons

These can include:

2-ring compounds	Naphthalene, 1-Methylnaphthalene, 2-Methylnaphthalene, 2,6-Dimethylnaphthalene, and Acenaphthene.
3-ring compounds	Fluorene, Phenanthrene, 1-Methylphenanthrene and Anthracene.
4-ring compounds	Fluoranthrene, Pyrene, and Benz(a)anthracene
5-ring compounds	Chrysene, Benzo(a)pyrene, Benzo(e)pyrene, and Dibenz(a,h)anthracene.

For the purposes of the Long-term programme for pollution monitoring and research in the Mediterranean sea (MED POL - Phase II) the following chemical contaminants were identified for analysis in marine organisms.

category I (mandatory)

total mercury
organic mercury
cadmium
halogenated hydrocarbons

category II (optional)

total arsenic
radionuclides
polynuclear aromatic hydrocarbons

Appendix 4

A. LIST OF MED-POL SPECIES

For the purposes of the Long-term programme for pollution monitoring and research in the Mediterranean sea (MED POL - Phase II) the following species (nearly all edible), representing different ecotypes, are recommended for the monitoring of chemical contaminants in marine organisms.

a) Bivalves

Mytilus galloprovincialis, or

Mytilus edulis, or

b) Demersal fish

Perna perna, or

Donax trunculus

M. edulis, P. perna or D. trunculus can only be monitored as alternative species if Mytilus galloprovincialis does not occur in the area.

Mullus barbatus, or

Mullus surmuletus, or

Upeneus molluccensis

M. surmuletus or U. molluccensis can only be monitored as alternative species if Mullus barbatus does not occur in the area.

c) Pelagic carnivore fish

Thunnus thynnus, or

Thunnus alalunga, or

Xiphias gladius

d) Pelagic plankton feeding fish

Sardina pilchardus

Other clupeids should only be monitored as alternative species if S. pilchardus does not occur in the area.

e) Crustaceans

Parapenaeus longirostris, or

Nephrops norvegicus, or

Penaeus kerathurus

N. norvegicus or P. kerathurus can only be monitored as alternative species if P. longirostris does not occur in the area.

**B. LIST OF POSSIBLE ORGANISMS FOR THE ASSESSMENT OF
CONTAMINATION IN THE NORTH ATLANTIC REGION**

	Cd	Hg	Cu	Cr	Pb	Zn	HH	PHC
Rocky substrate								
<u>Mytilus edulis</u> (common mussel)	+		?	+	+	+	+	+
<u>Littorina littorea</u> (gastropod)	+		+	?	+	+		
<u>Patella vulgata</u> (limpet, gastropod)	+		+		+	+		
Muddy substrate								
<u>Scrobicularia plana</u> (da Costa) (peppery furrow bivalve)	+	+	?	+	+	+		
<u>Macoma balthica</u> (bivalve)	+	+	?	+	+	+		
<u>Nereis diversicolor</u> (annelid)	+	+	+	+	+	+		

Key: + = appears to act as good indicator
 ? = doubt about use as indicator
 HH = halogenated hydrocarbons
 PHC = petroleum hydrocarbons

NOTES: The organisms listed for muddy substrates are all deposit feeders, whilst those for rocky substrates are filter feeders or herbivores. It is unlikely that contaminant levels in the tissues of the two groups will reflect contaminant levels in the same part of the marine environment.

Annex VII:

Sampling of selected marine organisms and sample preparation for trace metal analysis

Reference Methods for Marine Pollution Studies No. 7 Rev. 2

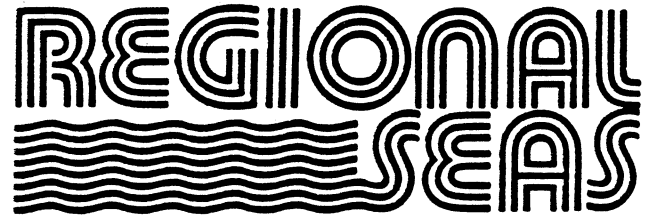

UNITED NATIONS ENVIRONMENT PROGRAMME

12 November 1984

*Sampling of selected marine organisms
and sample preparation for trace metal analysis*

Reference Methods for Marine Pollution Studies No. 7 Rev. 2

Prepared in co-operation with



FAO



IAEA



IOC

Note: This document has been prepared in co-operation between the Food and Agriculture Organization of the United Nations (FAO), the International Atomic Energy Agency (IAEA), the Intergovernmental Oceanographic Commission (IOC) of UNESCO and the United Nations Environment Programme (UNEP) under projects FP/ME/0503-75-07, ME/5102-81-01, FP/5102-77-03 and FP/5101-84-01.

For bibliographic purposes this document may be cited as:

UNEP/FAO/IAEA/IOC: Sampling of selected marine organisms and sample preparation for trace metal analysis. Reference Methods for Marine Pollution Studies No. 7 Rev. 2, UNEP 1984.

PREFACE

The Regional Seas Programme was initiated by UNEP in 1974. Since then the Governing Council of UNEP has repeatedly endorsed a regional approach to the control of marine pollution and the management of marine and coastal resources and has requested the development of regional action plans. The Regional Seas Programme at present ^{1/} includes ^{2/} ten regions and has over 120 coastal States participating in it.

One of the basic components of the action plans sponsored by UNEP in the framework of Regional Seas Programme is the assessment of the state of marine environment and of its resources, of the sources and trends of the pollution, and the impact of pollution on human health, marine ecosystems and amenities. In order to assist those participating in this activity and to ensure that the data obtained through this assessment can be compared on a world-wide basis and thus contribute to the Global Environment Monitoring System (GEMS) of UNEP, a set of reference methods and guidelines for marine pollution studies are being developed and are recommended to be adopted by Governments participating in the Regional Seas Programme.

The methods and guidelines are prepared in co-operation with the relevant specialized bodies of the United Nations system as well as other organizations and are tested by a number of experts competent in the field relevant to the methods described.

In the description of the methods and guidelines the style used by the International Organization for Standardization (ISO) is followed as closely as possible.

The methods and guidelines, as published in UNEP's series of Reference Methods for Marine Pollution Studies, are not considered as final. They are planned to be periodically revised taking into account the development of our understanding of the problems, of analytical instrumentation and the actual need of the users. In order to facilitate these revisions the users are invited to convey their comments and suggestions to:

International Laboratory of Marine
Radioactivity
International Atomic Energy Agency
c/o Musée Océanographique
MC98000 MONACO

which is responsible for the technical co-ordination of the development, testing and intercalibration of reference methods.

1/ UNEP: Achievements and planned development of UNEP's Regional Seas Programme and comparable programmes sponsored by other bodies. UNEP Regional Seas Reports and Studies No. 1 UNEP, 1982.

2/ P. HULM: A Strategy for the Seas. The Regional Seas Programme: Past and Future UNEP, 1983.

This issue (Rev.2) of the Reference Method for Marine Pollution Studies No. 7 was prepared in co-operation with the Food and Agriculture Organization of the United Nations (FAO), the International Atomic Energy Agency (IAEA) and the Intergovernmental Oceanographic Commission (IOC) of UNESCO. It includes comments received from IOC's GIPME Group of Experts on Methods, Standards and Intercalibration (GEMSI), from the FAO/UNEP/IAEA Experts Consultation Meeting on Reference Methods for the Determination of Chemical Contaminants in Marine Organisms (Rome, 4-8 June 1984) and from a number of scientists who reviewed and tested the method. The assistance of all those who contributed to the preparation of Revision 2 of this reference method is gratefully acknowledged.

CONTENTS

	<u>Page</u>
1. Scope and field of application	1
2. References	1
3. Principles	1
4. Reagents	1
5. Apparatus	2
6. Sampling and transport	3
7. Sample preparation	5
8. Sampling and sample preparation protocol	10
Appendix A : Preparation of plastic tweezers	14
Appendix B : Specimen identification note	15

1. SCOPE AND FIELD OF APPLICATION

This publication describes the sampling and sample preparation procedures suitable to obtain uncontaminated samples of mussels (total soft tissue), shrimps (muscles), and fish (muscles) for trace metal analysis by atomic absorption spectrophotometry.

2. REFERENCES

BERNHARD, M. (1976) Manual of methods in aquatic environment research. Part 3. Sampling and analyses of biological material. FAO Fish.Tech.Pap. No. 158 (FIRI/T158), pp. 124. FAU, Rome.

UNEP/FAO/IAEA (in preparation). Guidelines for monitoring chemical contaminants in marine organisms. Reference methods for marine pollution studies No. 6. UNEP, Geneva.

3. PRINCIPLES

Specimens of organisms selected and collected according to UNEP/FAO/IAEA (in preparation) are enclosed in plastic containers and transported to the analytical laboratory either as cooled (-2 to 4°C) or as deep-frozen (-18°C) samples. There the specimens are dissected under "clean conditions" and subsamples are prepared for the analyses of trace metals.

4. REAGENTS

4.1 Demineralized distilled water or glass distilled water of equivalent quality, with a trace metal content below detection limits when checked with this reference method.

4.2 Uncontaminated "open-ocean" subsurface (1 m below the surface) sea water.

4.3 Detergent recommended for laboratory use.

5. APPARATUS

5.1 Plastic thermo-insulated boxes (camping equipment) cooled with commercially available cooling bags. For storage and transport of mussels the boxes must be equipped with a grid in the bottom in order to avoid the mussels being submerged when moistened during transport and storage.

5.2 Refrigerator (required for 6.2, 6.3, 6.4).

5.3 Deep-freezer (-18°C).

5.4 Heavy duty, high-density polyethylene bags or suitable plastic containers for storage of specimens.

5.5 Plastic length-measuring board, length-measuring scale (ruler) or transparent Pyrex dish (cooking utensil) with centimetre scale attached underneath (for small and medium-size specimens).

5.6 Two or more plastic knives made out of high-density and purity polyethylene or similar material. Alternatively, quartz knives can be used.

5.7 Pyrex dishes or porcelain dishes (cooking utensils) as working surface for sample preparation.

5.8 Two or more pairs of plastic, commercially available or "home-made", tweezers (see Appendix A).

5.9 High density and purity polyethylene bags and airtight plastic containers with screw caps, for preservation of samples in deep-freezer, cleaned with detergent (4.3) and rinsed with distilled water (4.1) or uncontaminated sea water (4.2).

5.10 High-density polyethylene sheets for covering working bench.

5.11 Smaller polyethylene sheets to be used as "weighing plastic".

5.12 Balance (100-200 g) with a precision of 0.001 g or better, for weighing specimens and subsamples; preferably a "top-loading" balance.

5.13 Plastic wash bottle containing glass-distilled water (4.1).

5.14 Scraper (figure 1), a strong rust-free knife or similar for collecting mussels.

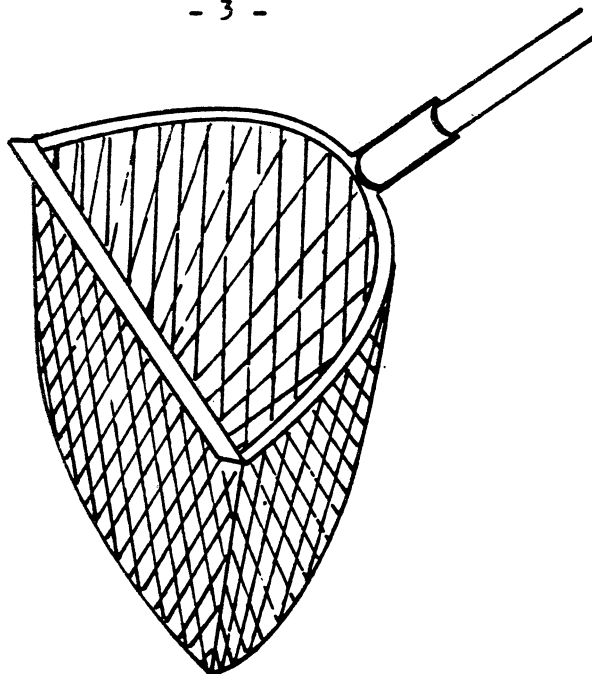

FIGURE 1 : SCRAPER FOR COLLECTING MUSSELS

5.15 Plastic tank or bottle (20 - 50 l) for the sea water (4.2) needed to moisten live mussel samples during storage and transport.

5.16 Large rust-free metal knife for cutting portions from large fishes.

5.17 Stainless steel blender or other tissue homogenizer made from glass and/or teflon. Stainless steel equipment should be tested for trace metal contamination by homogenizing reference (standard) material and comparing the analytical result obtained with same material which was not homogenized with stainless steel equipment.

5.18 Strong plastic brush for removing foreign material attached to the surface of mussels.

6. SAMPLING AND TRANSPORT

6.1 Presampling preparations

Clean the thermo-insulated boxes (5.1), the high density polyethylene bags or containers (5.4), the length-measuring board (5.5), the large rust-free knife (5.16), the scraper or the knife (5.14) with detergent (4.3) and rinse them with distilled water or, alternatively, with clean open-ocean sea water (4.2).

6.2 Sampling of mussels

Remove mussels from their attachments with the clean scraper or the rust-free knife (5.14).

Transfer a suitable number (UNEP/FAO/IAEA (in preparation)) of undamaged mussels into clean thermo-insulated boxes with grid on the bottom (5.1). Collect, from the sampling site, a clean sea water sample in a suitable container (5.15) to keep the mussels moist if a long transport (more than 2 hours in hot climates) is envisaged. Keep the mussels moist with the clean sea water without submerging them.

If the mussels have to be transported and stored before sample preparation (7) for more than 24 hours place a suitable number of mussels in plastic bag (5.9). Squeeze out the air and close the bag airtight with a knot, thermoseal, or similar. Place the bag into another bag (5.4) together with a sample identification note (see Appendix B), close airtight the second bag and deep-freeze.

This represents the "specimen sample".

NOTE: The transport of mussels collected near the laboratory will not present special transport and storage problems. Mussels should be kept exposed to air and moistured with clean sea water during the transport to the laboratory. When gathered from the intertidal zone, they will survive aerial exposure for 24 hours. Mussels submerged in sea water during transport will open their valves, start pumping water and excreting waste products, while during aerial exposure their valves will remain closed and their metabolic rate is greatly reduced; therefore their submersion in sea water during transport should be avoided.

6.3 Sampling of shrimps and small to medium-size fish

Place in a clean plastic bag (5.4) a suitable number of the undamaged specimens (select according to UNEP/FAO/IAEA (in preparation)) collected from a fishing vessel, fish market, etc., taking care that the legs, spines, etc. will not puncture the plastic. Squeeze out the air and close the bag airtight with a knot, thermoseal, or similar. Place the bag into another bag (5.4) together with a sample identification note (see Appendix B), and close the second bag airtight also. Deep-freeze (5.3) the bag whenever possible. Use a refrigerator (5.2) or a cooled thermo-insulated box (5.1) only if the storage period is not too long (48 hours in hot climates).

This represents the "specimen sample".

6.4 Sampling of large-size fish

Determine and note the fork-length, the body weight and sex of the collected specimen.

Separate with a clean rust-free metal knife (5.16) a portion of at least 100 g of muscle tissue. This portion must be at least 5 cm thick so that during sample preparation (7.3) contaminated and dirty tissue can be sliced off. Place each portion into a separate clean bag (5.4), squeeze out the air and close the bag airtight. Place it together with the sample identification note (see Appendix B) into a second bag (5.4) and close it airtight also. Deep-freeze

(5.3) the bag whenever possible, otherwise use a refrigerator (5.2) or a cooled thermo-insulated box (5.1) if the storage period is not too long (48 hours in hot climate).

This represents the "specimen sample".

7. SAMPLE PREPARATION

7.1 Preparatory activities

If necessary, partially thaw deep-frozen samples (6) by placing them overnight in a refrigerator at -2°C to 4°C (partially frozen samples are easier to cut than completely thawed or even fresh samples).

Clean the knives (5.6), the dishes (5.7), the tweezers (5.8), the length-measuring board (5.5) and "weighing plastics" (5.11) with detergent (4.3), rinse with distilled water (4.1) or clean sea water (4.2). Cover the working area with pre-cleaned plastic sheets (5.10). Clean hands carefully with detergent (4.3) and rinse them with distilled water (4.1) or clean sea water (4.2).

NOTE: If hands are cleaned and precautions are taken not to touch the dissected part with hands, bare hands are preferred to hands covered with gloves, since the operator has a much better control of instruments, etc. If possible a clean room should be used for preparatory activities.

7.2 Sample preparation of mussels

Scrape off all foreign materials attached to the outer surface of the shell with a clean plastic knife (knife no. 1) (5.6), to be used only for this purpose or with a strong plastic brush (5.18). Handle the mussels as little as possible.

Rinse each mussel with distilled water (4.1) or alternatively with clean sea water (4.2) and let the water drain off.

Pull out the byssus which extrudes from between the closed shells on the concave side of the shells.

Weigh (5.12) the whole mussel and note the weight.

Insert a second clean plastic knife (knife no. 2) (5.6) into the opening from which the byssus extrudes and cut the adductor muscles by turning the knife as indicated in figure 2 and open the mussel. Do not try to break the mussel open with the knife; if the muscles are cut, the mussel will open easily. Check if the byssus has been eliminated completely; if not, remove the remainder with clean tweezers (5.8).

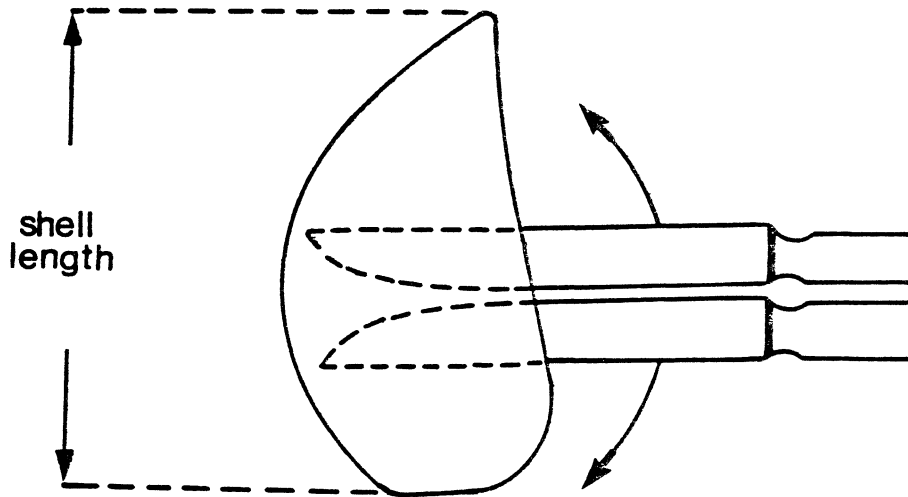

FIGURE 2 : CUTTING THE ADDUCTOR MUSCLE

Rinse the soft part of the mussel in its shells with distilled water (4.1) or clean sea water (4.2).

Loosen all tissue with the second clean knife (knife no. 2) (5.6), remove the soft tissue from the shell with a pair of clean plastic tweezers (5.8) without touching the outer part of the shells, and let all the water drain off.

(a) Single specimen sample: Weigh a clean empty container (5.9) on the balance and note the weight. Then put the soft part of the mussel in it and reweigh. Note the fresh weight of the soft part. Close the container airtight, label it with the sample preparation code. Determine the length of the mussel's shell (figure 2) by placing it with the inner part facing the cm scale (5.13). Note the length of the shell and the weight of the soft part of the mussel.

(b) Composite sample: Fill a container (5.9) of known weight with at least 10 soft parts of mussels prepared as described above. Reweigh the plastic container and note the composite fresh weight of the mussels. Homogenize the specimens in a cleaned blender (5.17), and return the homogenate in the plastic container. Note the total weight again and recalculate the fresh weight of the homogenate. Label the plastic container with the sample code.

NOTE: When preparing composite samples, use mussels of similar size. The length and weight of each specimen should be determined separately before the soft parts are pooled.

Place several plastic containers in a clean plastic bag (5.4), include an identification note with the containers sample codes, seal the bag airtight and deep-freeze.

This represents the "tissue sample".

7.3 Sample preparation of shrimps

(a) Single specimen sample: Determine the length of the shrimp from rostrum to uropod (see figure 3) using the appropriate length measuring device (5.5). Weigh the shrimp after placing a clean "weighing plastic" (5.11) on the balance (5.12) and note its length and fresh weight.

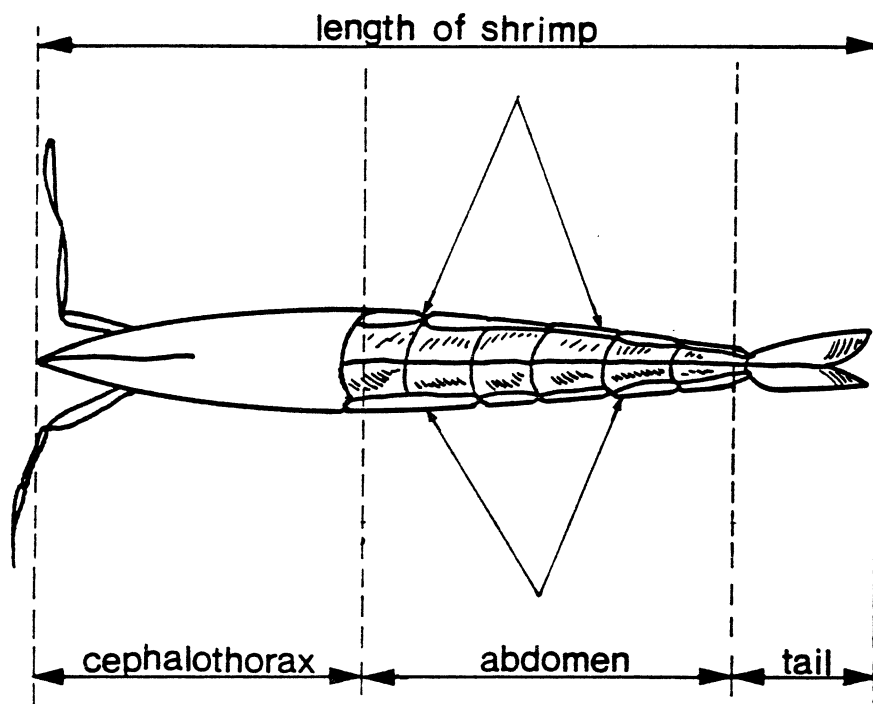

FIGURE 3 : SCHEMATIC DIAGRAM OF A SHRIMP
(arrows indicate where to cut after the legs have been removed)

Separate the abdomen from the cephalothorax and the "tail" (telson and uropod) with a first plastic knife (knife no. 1) taking care that no viscera remain in the abdomen (figure 3). Cut off all legs. Turn the abdomen with the ventral side up and cut with a plastic knife along the edges of the sterinities (ventral exoskeleton); lift the sterinities off with a pair of plastic tweezers and discard.

Loosen with a second clean knife (knife no. 2) the abdomen muscle and lift it from the exoskeleton with a clean pair of tweezers.

Determine and note the sex by examining the gonads.

Transfer the muscle with a clean pair of plastic tweezers (5.8) into a preweighed plastic container (5.9), determine and note the fresh weight of the muscle. Close the container airtight, label it with the sample code, place a suitable number of containers in a plastic bag, add a sample identification note to the containers, and close the bag airtight and deep freeze the samples.

(b) Composite sample: Start sample preparation as described for single specimen sample above taking care to record length, fresh weight, tail muscle weight and the sex of each specimen separately. Reduce the tail muscle(s) of the large specimens to the weight of the smallest tail muscle. A composite sample should not contain less than 6 tail muscles from 6 different specimens of

the same sex and size. Homogenize the tail muscles in a blender (5.17). Transfer the homogenate into a suitable clean container (5.9) which has been weighed empty. Close the container airtight, label it and weigh the container with the homogenate. Note the weight of the homogenate together with the other data in a protocol. Place a suitable number of containers in a plastic bag (5.4), add a sample identification note, close the bag airtight and deep-freeze (5.3) the containers.

This represents the "tissue sample".

NOTE: The concentration of trace metals in a composite sample should represent the mean value of metal concentrations of single specimens. In order to avoid overrepresentation of large specimens, only shrimp of similar size (age) should be used for the preparations of composite samples. In addition, the weight of the tail muscles of all specimens to be included in the composite sample should be reduced to that of the tail muscle of the smallest specimen. As there might be considerable differences in the trace metal content of male and female specimens, use them in separate composite samples.

7.4 Sample preparation for small and medium size fish

(a) Single specimen sample: Determine the fork-length (from tip of snout when the mouth is closed to the apex of the fork of the tail) of fish (figure 4) to the nearest mm on the length-measuring board (5.5). Weigh the fish on a clean "weighing plastic" (5.11) with an accuracy of 0.1% of its total weight and note both the fork-length and the fresh weight of the specimen.

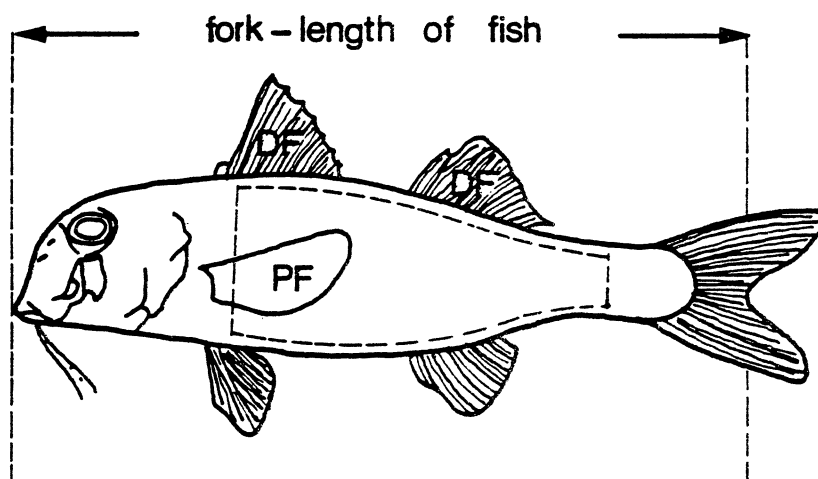

FIGURE 4 : SCHEMATIC DIAGRAM OF A FISH

(PF=pectoral fin, DF=dorsal fins, dashed line shows where the cuts should be made)

Rinse the fish with distilled water (4.1) or clean sea water (4.2) and place it on a clean working surface (5.7). Remove the pectoral fin and cut the skin of the fish with a first knife (5.6) near the dorsal fins, starting from the head to the tail (figure 4).

Cut near the gills across the body, along the ventral edge from the gills to the tail and finally across the body near the tail. These four cuts should be carried out first on one side only taking care not to cut too deep in order to avoid cutting into the viscera and thus contaminating the fillet. It is advisable that a second person hold the fish by the head and tail during this operation.

Pull the skin from the fillet with a pair of tweezers (5.8), taking care that the outer skin does not contaminate the fillet.

With a second clean knife (5.6), cut the fillet from the vertebral column (backbone) starting from the cut near the gills. Lift the fillet with a second clean pair of tweezers (5.8), so that the fillet will not touch the working surface (e.g. the Pyrex dish) or other parts of the fish.

Weigh the fillet in a clean plastic container (5.9) and note its fresh weight.

If one fillet does not yield enough material for analysis, put the fish, skin side upwards, on a clean portion of the working surface (5.3) or on a new working surface and remove the second fillet from the other side of the same fish as described above, add it to the first sample and record their total weight.

Close the container airtight. Identify the container with a code number and/or label, record all data in the protocol and deep-freeze (5.3).

This represents the "tissue sample".

Determine and note the sex of fish by examining the gonads.

NOTE: Comparing the weight of the container holding the fillet sample(s) determined at this point with the weight of the container before the digestion step will show if the tissues have lost moisture during prolonged storage.

(b) Composite sample: Start sample preparation as described for single specimen sample above taking care to record the length, the fresh weight and fillet (sample) weight of each fish separately. Determine and note by examining the gonads the sex of each specimen separately.

Reduce the fillet(s) of the large specimens to the weight of the smallest fillet. A composite sample should not contain less than 6 fillets from 6 different specimens of the same sex and size. Homogenize the fillets in a blender (5.17). Transfer the homogenate into a suitable clean container (5.9) which has been weighed empty. Close the container airtight, label it and weight the container with the homogenate. Note the weight of the homogenate together with the other data in a protocol and deep-freeze (5.3) the container.

This represents the "tissue sample".

NOTE: The concentration of trace metals in a composite sample should represent the mean value of metal concentrations of single specimens. In order to avoid overrepresentation of large specimens, only fish of similar size (age) should be used for the preparation of composite samples. In addition, the weight of the fillets of all specimens to be included in the composite sample should be reduced to that of the fillet of the smallest fish. As there might be considerable differences in the trace metal content of male and female specimens, use them in separate composite samples.

7.5 Sample preparation of large-size fish

If necessary, thaw partially, e.g. overnight in a refrigerator (-2 to 4°C), the subsample taken in the field during sampling (6.4).

Rinse the subsample with distilled water (4.1) or clean sea water (4.2) and place it on a clean working surface (5.7). Remove any skin and bone that may be present. Cut off thin slices from all surfaces with clean plastic knife (5.6) and discard them. Repeat the operation with a second clean knife (5.6) in order to obtain a clean uncontaminated block of homogeneous tissue.

NOTE: It has been recognized that differences in trace metal concentrations may exist between different muscles in large fish, therefore as much information as possible on the actual sample should be recorded.

Transfer the tissue into an airtight container (5.9), close and label it, weigh it, note all data together with data of the subsample in the protocol, and deep-freeze (5.3).

This represents the "tissue sample".

8. SAMPLING AND SAMPLE PREPARATION PROTOCOL

Fill in the sampling and sample preparation protocol (table 1) giving full details in every column. This protocol should be attached to the test report on the determination of trace metals in the analyzed sample.

The following guidelines should be kept in mind when completing the protocol (the numbers refer to those used in table 1):

1.1 Use the scientific name for the species sampled. If necessary indicate subspecies or variety.

1.2 Indicate the name under which the species is known locally.

1.3 Use any code adopted by your institution. Never use the same sample code for more than one sample.

3.2 For samples obtained on fish market, indicate the town (village) where the market is. For samples taken at standard sampling stations or areas, indicate the name (code) of the station or area.

3.3 If the sampling point does not coincide with a standard sampling station or area, it may be advisable to code (name) it, in particular when the sampling point is used more frequently (e.g. a particular fish market). Never use the same sampling point code for more than one sampling point.

3.4 and 3.5 Always indicate the longitude and latitude of the sampling point to the nearest minute. For samples obtained from fish market, enquire about their provenience and try to reflect it also as geographic co-ordinates. Circle either E or W and N or S, as appropriate.

3.6 Give any additional information which may be relevant for the interpretation of the results (e.g. sampling point in vicinity of outfalls or similar).

4.1 Indicate the difference between data given under 2 and 5.

4.2 Mark the storage conditions used. If none of them applicable, give additional explanations in 4.3.

6.2 Identify sex of the specimen whenever possible. As for specimen length, determine shell length for mussels, fork length for fish and total length for shrimp as indicated in figures 2, 3, and 4. Specimen weight always refers to the fresh weight of the whole mussel, of the whole shrimp and of the whole fish. Note that sample weight, in the case of mussels, refers to the total weight of soft tissues. In the case of shrimp, the sample weight refers only to the fresh weight of the muscle, and in the case of fish, to the fresh weight of the fillet or of the combined weight of fillets removed from the same fish.

6.3 Whenever possible use six or more specimens of the same sex and size (age) in preparing composite samples. Mean length and weight refers to the arithmetical mean of the weight and length of individual specimens, as explained above. Always calculate the standard deviations.

Table 1: Sampling and Sample Preparation Protocol

1. Sample (specimen)

1.1 Scientific name: _____

1.2 Common name: _____

1.3 Sample code: _____

2. Date of sampling: day _____; month _____; year _____

3. Sampling point

3.1 Country: _____

3.2 Type of sampling point: _____ fish market;
_____ sampling area/station

3.3 Sampling point code: _____

3.4 Longitude: _____ ° _____ ' E or W

3.5 Latitude: _____ ° _____ ' N or S

3.6 Conditions at sampling point which may be relevant for the interpretation of results:

4. Sample storage

4.1 Duration of storage: _____ hours; _____ days

4.2 Storage: deep-freezing _____; cooling _____

4.3 Factors relevant to sample storage which may be important for the interpretation of results:

5. Date of sample preparation: day _____; month _____; year _____

6. Sample preparation

6.1 Tissue type (kind) _____

6.2 Single specimen sample: sex____; specimen length_____cm;
specimen weight_____g; sample weight_____g

6.3 Composite sample:

- number of specimens _____; sex _____
- mean length of specimens _____cm; stand. dev. _____
- mean weight of specimens _____g; stand. dev. _____
- total weight of composite sample _____g
- total net weight of homogenate _____g

6.4 Factors relevant to sample preparation which may be important for the interpretation of results:

7. Full address of the institution carrying out the sampling and sample preparation:

8. Name(s) and signature(s) of the person(s) who carried out the sample preparation:

Date: _____

Appendix A

Preparing plastic tweezers

Methylmetacrylate of 4 mm thickness has been found to be very useful as it has the right elasticity. If thinner or thicker material has to be used, either the strips from which the tweezers are to be made are cut wider or narrower. The easiest way to heat the plastic and bend it is with a hot air blower used for forming plastics. A drying oven can be used also. However, it is much more difficult to make tweezers by heating the plastic in an oven since the plastic twists easily.

Materials:

- sheets of acrylic (methylmetacrylate) resin; 4 mm thick (trade names: e.g. Perspex, Flexiglas, Lucite);
- a plastic tube, about 40 mm in diameter.

Equipment:

- hot air blower (300-350°C) used for molding plastics, or Drying oven (135-140°C).

Procedure:

(a) With a hot air blower

- cut from the sheet with an electric or a hand saw strips of about 10 mm width and 250 mm length;
- heat about a 60 mm long part in the middle of the strip so that it bends easily. Bend it around the plastic tube carefully in order to make both ends meet. Cool the plastic with cold water;
- sharpen the ends with a file and roughen the inside of the tweezers so that they grip well;
- wash the tweezers carefully with detergents and rinse them with distilled water.

(b) With a drying oven

- place the plastic strip on a clean piece of wood in a drying oven (135-140°C) until it becomes soft;
- lift the strip at one end with a pair of tweezers and bend it around the plastic tube without letting the tweezer tips meet;
- cool the tips by dipping them in a beaker of clean cold water and afterwards bend the ends of the tweezer so that the tips meet;
- prepare the ends of the tweezers as described earlier.

Appendix B

Sample identification note

A standard sample identification note should contain the following data:

- sample code (the same code should be used in 1.3 of the Sampling and Sample Preparation Protocol; see table 1);
- species name (important in particular whenever storage of sample may create difficulties in determining the species);
- sampling date;
- sampling location (given as sampling point code, if possible; see 3.3 of table 1);
- collector's (sampler's) name;

Example:

AN 435
Mytillus galloprovincialis
3 March 1982
F 17
D. Degobbis

Issued and printed by:



Regional Seas Programme Activity Centre
United Nations Environment Programme

Additional copies of this and other publications issued by
the Regional Seas Programme Activity Centre of UNEP can be
obtained from:

Regional Seas Programme Activity Centre
United Nations Environment Programme
Palais des Nations
GENEVA
Switzerland

Annex VIII:

HELCOM

Manual for marine monitoring in the COMBINE programme

**ANNEX B-12, APPENDIX 1. TECHNICAL NOTE ON BIOLOGICAL MATERIAL
SAMPLING AND SAMPLE HANDLING FOR THE ANALYSIS OF PERSISTENT
ORGANIC POLLUTANTS (PAHS, PCBS AND OCPS) AND METALLIC TRACE
ELEMENTS**

HELCOM Manual for marine monitoring in the COMBINE programme

ANNEX B-12, APPENDIX 1. TECHNICAL NOTE ON BIOLOGICAL MATERIAL SAMPLING AND SAMPLE HANDLING FOR THE ANALYSIS OF PERSISTENT ORGANIC POLLUTANTS (PAHS, PCBS AND OCPS) AND METALLIC TRACE ELEMENTS

1. GENERAL PRINCIPLES

Muscle tissue or liver of fish have to be dissected while they are in good condition. If biological tissue deteriorates, uncontrollable losses of determinands or cross-contamination from other deteriorating tissues and organs may occur. To avoid this, individual fish specimens must be dissected at sea if adequate conditions prevail on board, or be frozen immediately after collection and transported frozen to the laboratory, where they are dissected later. If the option chosen is dissection on board the ship, two criteria must be met:

1. The work must be carried out by personnel capable of identifying and removing the desired organs according to the requirements of the investigations; and
2. There must be no risk of contamination from working surfaces or other equipment.

2. TOOLS AND WORKING AREA

Crushed pieces of glass or quartz knives, and scalpels made of stainless steel or titanium are suitable dissection instruments.

Colourless polyethylene tweezers are recommended as tools for holding tissues during the dissection of biological tissue for metallic trace element analysis. Stainless steel tweezers are recommended if biological tissue is dissected for analysis of chlorinated biphenyls (PCBs), organochlorine pesticides (OCPs) and polynuclear aromatic hydrocarbons (PAHs). After each sample has been prepared, including the samples of different organs from the same individual, the tools should be changed and cleaned.

The following procedures are recommended for cleaning tools used for preparing samples:

1) for analysis of metallic trace elements

- a) Wash in acetone or alcohol and high purity water.
- b) Wash in HNO₃ (p.a.) diluted (1+1) with high purity water. Tweezers and haemostates in diluted (1+6) acid.
- c) Rinse with high purity water.

2) for analysis of CBs and OCPs

- a) Wash in acetone or alcohol and rinse in high purity water.

The glass plate used during dissection should be cleaned in the same manner. The tools must be stored dust-free when not in use.

The dissection room should be kept clean and the air should be free from particles. If clean benches are not available on board the ship, the dissection of fish should be carried out in the land-based laboratory under conditions of maximum protection against contamination.

3. FISH MUSCLE AND LIVER SAMPLES DISSECTION

For fish analysis, commercial catches can be used if fish transport to the laboratory does not take longer than 24 hours. The fish must be transported on ice. The dissection then takes place at the laboratory.

For analysis of **fish muscle**, the epidermis and subcutaneous tissue should be carefully removed from the fish. Samples should be taken under the red muscle layer. In order to ensure uniformity of samples, the **right side dorso-lateral muscle** should be taken as the sample. If possible, the entire right dorsal lateral filet should be used as a uniform sample, from which subsamples can be taken after homogenizing for replicate dry weight and contaminant determinations. If, however, the amount of material obtained by this procedure is too large to handle in practice, a specific portion of the dorsal musculature should be chosen for the sample. It is recommended that the portion of the muscle lying directly under the first dorsal fin should be utilised in this case. As both fat and water content vary significantly in the muscle tissue from the anterior to the caudal muscle of the fish (Oehlerschläger, 1994), it is important to obtain the same portion of the muscle tissue for each sample.

To sample **liver tissue**, the liver must be identified in the presence of other organs such as the digestive system or gonads (Harms and Kanisch, 2000). The appearance of the gonads will vary according to the sex of the fish and the season. After opening the body cavity with a scalpel, the connective tissue around the liver should be cut away and as much as possible of the liver is cut out in a single piece together with the gall bladder. The bile duct is then carefully clamped and the gall bladder dissected away from the liver.

When fish samples which have been frozen at sea are brought to the laboratory for analysis, they should be dissected as soon as the tissue has thawed sufficiently. The dissection of fish is easiest when the material, at least the surface layers of the muscle tissue, is half frozen. For dissection of other organs, the thawing must proceed further, but it is an advantage if, for example, the liver is still frozen. It must be noted that any loss of liquid or fat due to improper cutting or handling of the tissue makes the determinations of dry weight and fat content, and consequently the reported concentrations of determinands, less accurate.

After muscle preparations, the liver should be completely and carefully removed while still partly frozen to avoid water and fat loss. Immediately after removing it from the fish, the liver should be returned to the freezer so that it will be completely frozen prior to further handling. This is particularly important for cod liver.

4. SHELLFISH SAMPLING

The blue mussel (*Mytilus edulis*) occurs in shallow waters along almost all coasts of the Baltic Sea. It is therefore suitable for monitoring in near shore waters. No distinction is made between *M. edulis*, *M. galloprovincialis*, and *M. trossulus* because the latter species fills a similar ecological niche. A sampling size range of 20–70 mm shell length is specified to ensure availability throughout the whole maritime area.

Two alternative sampling strategies can be used: sampling to minimise natural variability and length-stratified sampling. Only details of length-stratified sampling are described in this document, as this strategy is used in monitoring programmes for temporal trends of contaminants in biota.

For shellfish, the upper limit of shell length should be chosen in such a way that at least 20 mussels in the largest length interval can easily be found. The length stratification should be

determined in such a way that it can be maintained over many years for the purposes of temporal trend monitoring. The length interval shall be at least 5 mm in size. The length range should be split into at least three length intervals (small, medium, and large) which are of equal size after log transformation.

Mussels are collected by a bottom grab and selected onboard. The number of specimens selected for analysis depends on their length, e.g. 80-100 individuals are necessary to suffice material within the length range 4-5 cm.

5. STORAGE OF FISH AND MUSSEL SAMPLES

Material from single fish specimens should be packaged and stored individually.

- Samples for analysis of metallic trace elements can be stored in polyethylene, polypropylene, polystyrene or glass containers.
- Samples for analysis of CBs and OCPs should be packaged in precleaned aluminium foil or in precleaned glass containers.

Liver tissue can deteriorate rather rapidly at room temperature. Consequently, samples should be frozen as soon as possible after packaging. They can be frozen rapidly by immersion in liquid nitrogen or blast freezing, but both these techniques need care. Whatever system is used, freezing a large bulk of closely packed material must be avoided. The samples in the centre will take longer to cool and will therefore deteriorate more than those in the outer layer.

Once frozen, samples can be stored in a deep freezer at temperatures of -20°C or below.

Frozen liver tissue should not be stored longer than six months, while lean muscle tissue can be stored up to two years. Each sample should be carefully and permanently labelled. The label should contain at least the sample's identification number, the type of tissue, and the date and location of sampling.

Mussels should be shucked live and opened with minimal tissue damage by detaching the adductor muscles from the interior of at least one valve. The soft tissues should be removed and homogenised as soon as possible, and frozen in glass jars at -20 °C until analysis. Mussel tissue for trace metal determination is homogenised and decomposed in a wet state while for persistent organic pollutants determination it is homogenised and water is removed by freeze-drying. Frozen liver tissue should not be stored longer than six months, while lean muscle tissue can be stored up to two years. Each sample should be carefully and permanently labelled. The label should contain at least the sample's identification number, the type of tissue, and the date and location of sampling.

REFERENCES

- Harms, U.; Kanisch, G. (2000): Intra-Individual Variability of levels of lead detected in the liver of Baltic cod (*Gadus morhua*). *Mar. Poll. Bull.*, 40 / 8, 710-712
- Oehlenschläger, J. 1994. Quality assurance during sampling onboard. *In ICES/HELCOM Workshop on Quality Assurance of Chemical Analytical Procedures for the Baltic Monitoring Programme*. Ed. by G. Topping and U. Harms. *Baltic Sea Environment Proceedings No. 58: 82-84.*

Annex IX:

**Guidance for Assessing Chemical Contaminant
Data for Use in Fish Advisories**

**Volume 1: Fish Sampling and Analysis
Third Edition**



Guidance for Assessing Chemical Contaminant Data for Use in Fish Advisories

Volume 1 Fish Sampling and Analysis Third Edition



Guidance for Assessing Chemical Contaminant Data for Use in Fish Advisories

**Volume 1: Fish Sampling and Analysis
Third Edition**

**Office of Science and Technology
Office of Water
U.S. Environmental Protection Agency
Washington, DC**



United States

Environmental Protection Agency

(4305)

Washington, DC 20460

Official Business

Penalty for Private Use \$300



Guidance for Assessing Chemical Contaminants

Volume 1: Fish Sampling and Analysis



TABLE OF CONTENTS

Section	Page
Figures	vii
Tables	ix
Acknowledgments	xii
Acronyms	xiii
Executive Summary	ES-1
1 Introduction	1-1
1.1 Historical Perspective	1-1
1.1.1 Establishment of the Fish Contaminant Workgroup ...	1-3
1.1.2 Development of a National Fish Advisory Database ...	1-3
1.2 Purpose	1-10
1.3 Objectives	1-13
1.4 Relationship of Manual to Other Guidance Documents	1-15
1.5 Contents of Volume 1	1-15
1.6 New Information And Revisions to Volume 1	1-18
2 Monitoring Strategy	2-1
2.1 Screening Studies (Tier 1)	2-4
2.2 Intensive Studies (Tier 2)	2-13
3 Target Species	3-1
3.1 Purpose of Using Target Species	3-1
3.2 Criteria for Selecting Target Species	3-2
3.3 Freshwater Target Species	3-3
3.3.1 Target Finfish Species	3-5
3.3.2 Target Turtle Species	3-10
3.4 Estuarine/marine Target Species	3-15
3.4.1 Target Shellfish Species	3-23
3.4.2 Target Finfish Species	3-28
4 Target Analytes	4-1
4.1 Recommended Target Analytes	4-1
4.2 Selection and Prioritization of Target Analytes	4-3
4.3 Target Analyte Profiles	4-12
4.3.1 Metals	4-12
4.3.2 Organochlorine Pesticides	4-24
4.3.3 Organophosphate Pesticides	4-38

Section	Page
4.3.4 Chlorophenoxy Herbicides	4-43
4.3.5 Polycyclic Aromatic Hydrocarbons	4-44
4.3.6 Polychlorinated Biphenyls (Total)	4-47
4.3.7 Dioxins and Dibenzofurans	4-54
4.4 Target Analytes Under Evaluation	4-58
4.4.1 Lead	4-58
5 Screening Values for Target Analytes	5-1
5.1 General Equations for Calculating Screening Values	5-1
5.1.1 Noncarcinogens	5-3
5.1.2 Carcinogens	5-3
5.1.3 Recommended Values for Variables in Screening Value Equations	5-4
5.2 Screening Values for Target Analytes	5-9
5.3 Comparison of Target Analyte Concentrations with Screening Values	5-16
5.3.1 Metals	5-16
5.3.2 Organics	5-18
6 Field Procedures	6-1
6.1 Sampling Design	6-1
6.1.1 Screening Studies (Tier 1)	6-2
6.1.2 Intensive Studies (Tier 2)	6-22
6.2 Sample Collection	6-38
6.2.1 Sampling Equipment and Use	6-38
6.2.2 Preservation of Sample Integrity	6-45
6.2.3 Field Recordkeeping	6-46
6.3 Sample Handling	6-55
6.3.1 Sample Selection	6-55
6.3.2 Sample Packaging	6-61
6.3.3 Sample Preservation	6-64
6.3.4 Sample Shipping	6-65
7 Laboratory Procedures I—Sample Handling	7-1
7.1 Sample Receipt And Chain-of-custody	7-1
7.2 Sample Processing	7-3
7.2.1 General Considerations	7-3
7.2.2 Processing Fish Samples	7-7
7.2.3 Processing Turtle Samples	7-16
7.2.4 Processing Shellfish Samples	7-24
7.3 Sample Distribution	7-29
7.3.1 Preparing Sample Aliquots	7-29
7.3.2 Sample Transfer	7-32

Section	Page
8 Laboratory Procedures II—Sample Analyses	8-1
8.1 Recommended Analytes	8-1
8.1.1 Target Analytes	8-1
8.1.2 Lipid	8-1
8.2 Analytical Methods	8-3
8.2.1 Lipid Method	8-3
8.2.2 Target Analyte Methods	8-4
8.3 Quality Assurance and Quality Control Considerations	8-12
8.3.1 QA Plans	8-14
8.3.2 Method Documentation	8-14
8.3.3 Minimum QA and QC Requirements for Sample Analyses	8-14
8.4 Documentation and Reporting of Data	8-46
8.4.1 Analytical Data Reports	8-46
8.4.2 Summary Reports	8-47
9 Data Analysis and Reporting	9-1
9.1 Data Analysis	9-1
9.1.1 Screening Studies	9-1
9.1.2 Intensive Studies	9-2
9.2 Data Reporting	9-3
9.2.1 State Data Reports	9-3
9.2.2 Reports to the National Fish Tissue Residue Data Repository (NFTRDR)	9-3
10 Literature Cited	10-1
 Appendix	
A 1993 Fish Contaminant Workgroup	A-1
B Screening Values for Defining Green Areas	B-1
C Use of Individual Samples in Fish Contaminant Monitoring Programs	C-1
D Fish and Shellfish Species for which State Consumption Advisories Have Been Issued	D-1
E Target Analytes Analyzed in National or Regional Monitoring Programs	E-1
F Pesticides and Herbicides Recommended as Target Analytes	F-1

Section	Page
G Target Analyte Dose-Response Variables and Associated Information	G-1
H A Recommended Method for Inorganic Arsenic Analysis	H-1
I Quality Assurance and Quality Control Guidance	I-1
J Recommended Procedures for Preparing Whole Fish Composite Homogenate Samples	J-1
K General Procedures for Removing Edible Tissues from Freshwater Turtles	K-1
L General Procedures for Removing Edible Tissues from Shellfish ..	L-1
M Sources of Reference Materials and Standards	M-1
N Statistical Methods for Comparing Samples: Spatial and Temporal Considerations	N-1

FIGURES

Number		Page
1-1	Total number of fish advisories in effect in each state in 1998 (change from 1997)	1-6
1-2	Trends in number of advisories issued for various pollutants	1-7
1-3	Series summary: Guidance for assessing chemical contamination data for use in fish advisories	1-16
2-1	Recommended strategy for State fish and shellfish contaminant monitoring programs	2-3
3-1	Geographic range of the common snapping turtle (<i>Chelydra serpentina</i>)	3-12
3-2	Geographic distributions of three bivalve species used extensively in national contaminant monitoring programs	3-27
4-1	States issuing fish and shellfish advisories for mercury	4-21
4-2	States issuing fish and shellfish advisories for chlordane	4-27
4-3	States issuing fish and shellfish advisories for PCBs	4-51
4-4	States issuing fish and shellfish advisories for dioxin/furans	4-57
5-1	Recommended Values for Mean Body Weights (BW) and Fish Consumption Rates (CRs) for Selected Subpopulations	5-5
5-2	Fish Consumption Rates for Various Fisher Populations	5-10
5-3	Dose-Response Variables and Recommended Screening Values (SVs) for Target Analytes - Recreational Fishers	5-11
5-4	Dose-Response Variables and Recommended Screening Values (SVs) for Target Analytes - Subsistence Fishers	5-13
5-5	Example Screening Values (SVs) for Various Target Populations and Risk Levels (RLs)	5-17
5-6	Toxicity Equivalency Factors for Various PAHs	5-20
5-7	Toxicity Equivalency Factors (TEFs) for Tetra-through Octa-Chlorinated Dibenzo-p-Dioxins and Dibenzofurans and Dioxin-Like PCBs	5-22

Number		Page
6-1	Example of a sample request form	6-3
6-2	U.S. fish and wildlife service regions	6-7
6-3	Example of a field record for fish contaminant monitoring program—screening study	6-47
6-4	Example of a field record for shellfish contaminant monitoring program—screening study	6-48
6-5	Example of a field record for fish contaminant monitoring program—intensive study	6-49
6-6	Example of a field record for shellfish contaminant monitoring program—intensive study	6-51
6-7	Example of a sample identification label	6-52
6-8	Example of a chain-of-custody tag or label	6-53
6-9	Example of a chain-of-custody record form	6-54
6-10	Recommended measurements of body length and size for fish, shellfish, and turtles	6-58
7-1	Preparation of fish fillet composite homogenate samples	7-8
7-2	Sample processing record for fish contaminant monitoring program—fish fillet composites.	7-10
7-3	Illustration of basic fish filleting procedure.	7-13
7-4	Preparation of individual turtle homogenate samples	7-17
7-5	Sample processing record for a contaminant monitoring program—individual turtle samples	7-19
7-6	Illustration of basic turtle resection procedure	7-21
7-7	Preparation of shellfish edible tissue composite homogenate samples	7-25
7-8	Sample processing record for shellfish contaminant monitoring program—edible tissue composites.	7-27
7-9	Example of a fish and shellfish monitoring program sample aliquot record.	7-31
7-10	Example of a fish and shellfish monitoring program sample transfer record	7-33
8-1	Recommended contents of analytical standard operating procedures (SOPs).	8-15
9-1	Recommended data reporting requirements for screening and intensive studies	9-4
9-2	Key information fields for the National Fish Tissue Residue Data Repository	9-6

TABLES

Number		Page
1-1	U.S. Advisories Issued from 1993 to 1998 by Type	1-5
1-2	Summary of Statewide Advisories in Effect in 1998	1-9
1-3	Comparison of FDA Action Levels and Tolerances with EPA Screening Values	1-12
2-1	Recommended Strategy for State Fish and Shellfish Contaminant Monitoring Programs	2-5
3-1	Recommended Target Species for Inland Fresh Waters	3-4
3-2	Recommended Target Species for Great Lakes Waters	3-4
3-3	Comparison of Freshwater Finfish Species Used in Several National Fish Contaminant Monitoring Programs	3-6
3-4	Freshwater Turtles Recommended for Use as Target Species . . .	3-7
3-5	Average Fish Tissue Concentrations (ppb) of Xenobiotics for Major Finfish Species Sampled in the National Study of Chemical Residues in Fish	3-8
3-6	Average Fish Tissue Concentrations (ppt) of Dioxins and Furans for Major Finfish Species Sampled in the National Study of Chemical Residues in Fish	3-9
3-7	Principal Freshwater Fish Species Cited in State Fish Consumption Advisories	3-11
3-8	Principal Freshwater Turtle Species Cited in State Consumption Advisories	3-12
3-9	Studies Using Freshwater Turtles as Biomonitors of Environmental Contamination	3-14
3-10	Recommended Target Species for Northeast Atlantic Estuaries and Marine Waters (Maine through Connecticut)	3-16
3-11	Recommended Target Species for Mid-Atlantic Estuaries and Marine Waters (New York through Virginia)	3-17
3-12	Recommended Target Species for Southeast Atlantic Estuaries and Marine Waters (North Carolina through Florida) . .	3-18
3-13	Recommended Target Species for Gulf of Mexico Estuaries and Marine Waters (West Coast of Florida through Texas)	3-19
3-14	Recommended Target Species for Pacific Northwest Estuaries and Marine Waters (Alaska through Oregon)	3-20
3-15	Recommended Target Species for Northern California Estuaries and Marine Waters (Klamath River through Morro Bay)	3-21

Number	Page	
3-16	Recommended Target Species for Southern California Estuaries and Marine Waters (Santa Monica Bay to Tijuana Estuary)	3-22
3-17	Sources of Information on Commercial and Sportfishing Species in Various Coastal Areas of the United States	3-24
3-18	Estuarine/Marine Species Used in Several National Fish and Shellfish Contaminant Monitoring Programs	3-25
3-19	Principal Estuarine/Marine Fish and Shellfish Species Cited in State Consumption Advisories	3-29
4-1	Recommended Target Analytes	4-2
4-2	Contaminants Resulting in Fish and Shellfish Advisories	4-4
4-3	Selection and Prioritization of Target Analytes by Watershed Type	4-6
4-4	Total Mercury and Methylmercury Concentrations in Estuarine Fish from South Florida	4-18
4-5	Chlordane Constituent Concentrations ^a Detected in the EPA National Study of Chemical Residues in Fish	4-26
4-6	Summary of PCBs Detected in Fish Tissue ^a as Part of the National Study of Chemical Residues in Fish	4-50
4-7	Polychlorinated Biphenyl (PCB) Congeners Recommended for Quantitation as Potential Target Analytes	4-53
4-8	Summary of Dioxins/Furans Detected in Fish Tissue as Part of the EPA National Study of Chemical Residues in Fish	4-56
4-9	Dibenzo-p-Dioxins and Dibenzofurans Recommended for Analysis as Target Analytes	4-59
5-1	Recommended Values for Mean Body Weights (BW _s) and Fish Consumption Rates (CR _s) for Selected Subpopulations	5-5
5-2	Fish Consumption Rates for Various Fisher Populations	5-10
5-3	Dose-Response Variables and Recommended Screening Values (SV _s) for Target Analytes - Recreational Fishers	5-11
5-4	Dose-Response Variables and Recommended Screening Values (SV _s) for Target Analytes - Subsistence Fishers	5-13
5-5	Example Screening Values (SV _s) for Various Target Populations and Risk Levels (RL _s)	5-17
5-6	Toxicity Equivalency Factors for Various PAHs	5-20
5-7	Toxicity Equivalency Factors (TEF _s) for Tetra-through Octa-Chlorinated Dibenzo-p-Dioxins and Dibenzofurans and Dioxin-Like PCBs	5-22

Number		Page
6-1	Values of $\left[\frac{2}{n^2 m^2 (n-1)} \right]^{1/2}$ for Various Combinations of n and m . .	6-30
6-2	Estimates of Statistical Power of Hypothesis of Interest Under Specified Assumptions	6-32
6-3	Observed Ratios (σ/SV) of Selected Target Analytes	6-33
6-4	Summary of Fish Sampling Equipment	6-39
6-5	Summary of Shellfish Sampling Equipment	6-40
6-6	Checklist of Field Sampling Equipment and Supplies for Fish and Shellfish Contaminant Monitoring Programs	6-42
6-7	Safety Considerations for Field Sampling Using a Boat	6-43
6-8	Recommendations for Preservation of Fish, Shellfish, and Turtles Samples from Time of Collection to Delivery at the Processing Laboratory	6-63
7-1	Recommendations for Container Materials, Preservation, and Holding Times for Fish, Shellfish, and Turtle Tissues from Receipt at Sample Processing Laboratory to Analysis	7-4
7-2	Weights (g) of Individual Homogenates Required for Screening Study Composite Homogenate Sample	7-16
7-3	Recommended Sample Aliquot Weights and Containers for Various Analyses	7-30
8-1	Contract Laboratories Conducting Dioxin/Furan Analyses in Fish and Shellfish Tissues	8-2
8-2	Current References for Analytical Methods for Contaminants in Fish and Shellfish Tissues	8-5
8-3	Recommended Analytical Techniques for Target Analytes	8-8
8-4	Range of Detection and Quantitation Limits of Current Analytical Methods for Recommended Target Analytes	8-10
8-5	Approximate Range of Costs per Sample for Analysis of Recommended Target Analytes	8-13
8-6	Recommended Quality Assurance and Quality Control Samples	8-17
8-7	Minimum Recommended QA and QC Samples for Routine Analysis of Target Analytes	8-23
8-8	Fish and Shellfish Tissue Reference Materials	8-26

ACKNOWLEDGMENTS

This report was prepared by the U.S. Environmental Protection Agency, Office of Water, Fish and Wildlife Contamination Program. The EPA Project Manager for this document was Jeffrey Bigler who provided overall project coordination as well as technical direction. EPA was supported in the development of this document by the Research Triangle Institute (RTI) (EPA Contract Number 68-C7-0056). Pat Cunningham of RTI was the contractor's Project Manager. Preparation of the First Edition of this guidance in 1993 was facilitated by the substantial efforts of the numerous Workgroup members and reviewers listed in Appendix A.

ACRONYMS

AFS	American Fisheries Society
ANOVA	Analysis of Variance
ATSDR	Agency for Toxic Substances and Disease Registry
BCF	bioconcentration factor
BW	body weight
CDD	chlorodibenzo- <i>p</i> -dioxin
CDF	chlorodibenzofuran
CERCLA	Comprehensive Environmental Response, Compensation, and Liability Act
CLP	Contract Laboratory Program
COC	chain-of-custody
CR	consumption rate
CRM	certified reference material
CRADAs	Cooperative Research and Development Agreements
CSF	cancer slope factor
CSFII	Continuing Survey of Food Intake by Individuals
CSOs	combined sewer overflows
CV	coefficient of variation
CVAAS	cold vapor atomic absorption spectrometry
DFTPP	decafluorotriphenylphosphine
DOT	U.S. Department of Transportation
EMAP	Environmental Monitoring and Assessment Program
EMAP-NC	Environmental Monitoring and Assessment Program—Near Coastal
EPA	U.S. Environmental Protection Agency
EMMI	Environmental Monitoring Methods Index System
FDA	U.S. Food and Drug Administration

FWS	U.S. Fish and Wildlife Service
γ-BHC	benzene hexachloride
γ-HCH	hexachlorocyclohexane
GC/ECD	gas chromatography/electron capture detection
GC/FID	gas chromatography/flame ionization detection
GC/FPD	gas chromatography/flame photometric detection
GC/NPD	gas chromatography/nitrogen-phosphorus detection
GC/MS	gas chromatography/mass spectrometry
GFAA	graphic furnace atomic absorption spectrometry
GLIFWC	Great Lakes Indian Fish and Wildlife Commission
GPS	Global Positioning System
HAA	hydride generation atomic absorption spectrometry
HEAST	Health Effects Assessment Summary Tables
HPLC/MS	high-performance liquid chromatography/mass spectrometry
HRGC/LRMS	high-resolution gas chromatography/low-resolution mass spectrometry
HRGC/HRMS	high-resolution gas chromatography/high-resolution mass spectrometry
ICP	inductively coupled plasma atomic emission spectrometry
IDL	instrument detection limit
IRIS	Integrated Risk Information System
IUPAC	Information Union of Pure and Applied Chemistry
LAN	local area network
LLD	lower limits of detection
LOAEL	lowest observed adverse effects level
LOD	limit of detection
LOQ	limit of quantitation
MDL	method detection limit
MQL	method quantitation limit
NAS	National Academy of Sciences
NEP	National Estuary Program
NERRS	National Estuarine Research Research System

NCBP	National Contaminant Biomonitoring Program
NCR	no-carbon-required
ND	not detected
NEP	National Estuary Program
NFTDR	National Fish Tissue Data Repository
NIST	National Institute of Standards and Technology
NLFWA	National Listing of Residue Fish and Wildlife Advisors
NOAA	National Oceanic and Atmospheric Administration
NOAEL	no observed adverse effects level
NRCC	National Research Council of Canada
NS&T	National States and Trends Program
NSCRf	National Study of Chemical Residues in Fish
NTIS	National Technical Information Service
OAPCA	Organotin Antifouling Paint Control Act
OAQPS	Office of Air Quality Planning and Standards
OCDD	octachlorodibenzo- <i>p</i> -dioxin
OCDF	octachlorodibenzofuran
ODES	Ocean Discharge Evaluation System
ODW	Office of Drinking Water
OHEA	Office of Health and Environmental Assessment
OPP	Office of Pesticide Programs
ORSANCO	Ohio River Valley Water Sanitation Commission
PAB	Population Adjusted Dose
PAHs	polycyclic aromatic hydrocarbons
PBBs	polybrominated biphenyls
PCBs	polychlorinated biphenyls
PCDDs	polychlorinated dibenzo- <i>p</i> -dioxins
PCDFs	polychlorinated dibenzofurans
PEC	potency equivalency concentration
PNAs	polynuclear aromatic hydrocarbons
PQL	practical quantitation limit
PTFE	polytetrafluoroethylene

QA	quality assurance
QC	quality control
RCRA	Resource Conservation and Recovery Act
RDL	reliable detection limit
RFs	response factors
RfD	reference dose
RL	risk level
RPs	relative potencies
RPD	relative percent difference
RRFs	relative response factors
RSD	relative standard deviation
SOPs	standard operating procedures
SRMs	standard reference materials
SVs	screening values
2,4,5-T	2,4,5-trichlorophenoxyacetic acid
2,3,7,8-TCDD	2,3,7,8-tetrachlorodibenzo- <i>p</i> -dioxin
2,3,7,8-TCDF	2,3,7,8-tetrachlorodibenzofuran
2,4,5-T	2,4,5-trichlorophenoxyacetic acid
2,4,5-TCP	2,4,5-trichlorophenol
TEFs	toxicity equivalency factor
TEQs	toxicity equivalency concentrations
TVA	Tennessee Valley Authority
UF	uncertainty factor
UM	modifying factor
USDA	U.S. Department of Agriculture
USGS	U.S. Geological Survey
USFWS	U.S. Fish and Wildlife Service
WHO	World Health Organization

EXECUTIVE SUMMARY

A 1988 survey, funded by the U.S. Environmental Protection Agency (EPA) and conducted by the American Fisheries Society, identified the need for standardizing the approaches to evaluating risks and developing fish consumption advisories that are comparable across different jurisdictions. Four major components were identified as critical to the development of a consistent risk-based approach: standardized practices for sampling and analyzing fish, standardized risk assessment methods, standardized procedures for making risk management decisions, and standardized approaches for communicating risk to the general public.

To address concerns raised by the survey respondents, EPA began developing a series of four documents designed to provide guidance to state, local, regional, and tribal environmental health officials responsible for designing contaminant monitoring programs and issuing fish and shellfish consumption advisories. It is essential that all four documents be used together, since no single volume addresses all of the topics involved in the development of fish consumption advisories. The documents are meant to provide guidance only and do not constitute a regulatory requirement. This document series includes:

Guidance for Assessing Chemical Contaminant Data for Use in Fish Advisories

- Volume 1: Fish Sampling and Analysis*
- Volume 2: Risk Assessment and Fish Consumption Limits*
- Volume 3: Overview of Risk Management*
- Volume 4: Risk Communication.*

Volume 1 was first released in September 1993 and was followed by a second edition in September 1995. This current revision to the Volume 1 guidance provides the latest information on sampling and analysis procedures based on new information provided by EPA. The major objective of Volume 1 is to provide information on sampling strategies for a contaminant monitoring program. In addition, information is provided on selection of target species; selection of chemicals as target analytes; development of human health screening values; sample collection procedures including sample processing, sample preservation, and shipping; sample analysis; and data reporting and analysis.

Volume 2 was first released in June 1994 and was followed by a second edition in July 1997. A third edition will be released in November 2000. This volume provides guidance on the development of appropriate meal sizes and frequency of meal consumption (e.g., one meal per week) for the target analytes that

bioaccumulate in fish tissues. In addition to the presentation of consumption limits, Volume 2 contains a discussion of risk assessment methods used to derive the consumption limits as well as a discussion of methods to modify these limits to reflect local conditions. Volume 2 also contains toxicological profiles for each of the 25 target analytes.

Volume 3 was published in June 1996 and provides an overview of a risk management framework. This volume provides information on selecting and implementing various options for reducing health risks associated with the consumption of chemically contaminated fish and shellfish. Using a human health risk-based approach, states can determine the level of the advisory and the most appropriate type of advisory to issue. Methods to evaluate population risks for specific groups, waterbodies, and geographic areas are also presented.

Volume 4 was published in March 1995 and provides guidance on risk communication as a process for sharing information with the public on the health risks of consuming chemically contaminated fish and shellfish. This volume provides guidance on problem analysis and program objectives, audience identification and needs assessments, communication strategy design, implementation and evaluation, and responding to public inquiries.

EPA welcomes your suggestions and comments. A major goal of this guidance document series is to provide a clear and usable summary of critical information necessary to make informed decisions concerning the development of fish consumption advisories. We encourage comments and hope this document will be a useful adjunct to the resources used by the states, local governments, and tribal organizations in making decisions concerning the development of fish advisories within their various jurisdictions.

SECTION 1

INTRODUCTION

1.1 HISTORICAL PERSPECTIVE

Contamination of aquatic resources, including freshwater, estuarine, and marine fish and shellfish, has been documented in the scientific literature for many regions of the United States (NAS, 1991). Environmental concentrations of some pollutants have decreased over the past 25 years as a result of better water quality management practices. However, environmental concentrations of other heavy metals, pesticides, and toxic organic compounds have increased due to intensifying urbanization, industrial development, and use of new agricultural chemicals. Our Nation's waterbodies are among the ultimate repositories of pollutants released from these activities. Pollutants come from permitted point source discharges (e.g., industrial and municipal facilities), accidental spill events, and nonpoint sources (e.g., agricultural practices, resource extraction, urban runoff, in-place sediment contamination, groundwater recharge, vehicular exhaust, and atmospheric deposition from various combustion and incineration processes).

Once these toxic contaminants reach surface waters, they may concentrate through aquatic food chains and bioaccumulate in fish and shellfish tissues. Aquatic organisms may bioaccumulate environmental contaminants to more than 1,000,000 times the concentrations detected in the water column (U.S. EPA, 1992c, 1992d). Thus, fish and shellfish tissue monitoring serves as an important indicator of contaminated sediments and water quality problems, and many states routinely conduct chemical contaminant analyses of fish and shellfish tissues as part of their comprehensive water quality monitoring programs (Cunningham and Whitaker, 1989; Cunningham, 1998; Cunningham and Sullivan, 1999). Tissue contaminant monitoring also enables state agencies to detect levels of contamination in fish and shellfish tissue that may be harmful to human consumers. If states conclude that consumption of chemically contaminated fish and shellfish poses an unacceptable human health risk, they may issue local fish consumption advisories or bans for specific waterbodies and specific fish and shellfish species for specific populations.

In 1989, the American Fisheries Society (AFS), at the request of the U.S. Environmental Protection Agency (EPA), conducted a survey of state fish and shellfish consumption advisory practices. Questionnaires were sent to health departments, fisheries agencies, and water quality/environmental management departments in all 50 states and the District of Columbia. Officials in all 50 states and the District responded.

Respondents were asked to provide information on several issues including

- Agency responsibilities
- Sampling strategies
- Sample collection procedures
- Chemical residue analysis procedures
- Risk assessment methodologies
- Data interpretation and advisory development
- State concerns
- Recommendations for federal assistance.

Cunningham et al. (1990) summarized the survey responses and reported that monitoring and risk assessment procedures used by states in their fish and shellfish advisory programs varied widely. States responded to the question concerning assistance from the federal government by requesting that federal agencies

- Provide a consistent approach for state agencies to use in assessing health risks from consumption of chemically contaminated fish and shellfish
- Develop guidance on sample collection procedures
- Develop and/or endorse uniform, cost-effective analytical methods for quantitation of contaminants
- Establish a quality assurance (QA) program that includes use of certified reference materials for chemical analyses.

In March 1991, the National Academy of Sciences (NAS) published a report entitled *Seafood Safety* (NAS, 1991) that reviewed the nature and extent of public health risks associated with seafood consumption and examined the scope and adequacy of current seafood safety programs. After reviewing over 150 reports and publications on seafood contamination, the NAS Institute of Medicine concluded that high concentrations of chemical contaminants exist in various fish species in a number of locations in the country. The report noted that the fish monitoring data available in national and regional studies had two major shortcomings that affected their usefulness in assessing human health risks:

- In some of the more extensive studies, analyses were performed on nonedible portions of finfish (e.g., liver tissue) or on whole fish, which precludes accurate determination of human exposures.
- Studies did not use consistent methods of data reporting (e.g., both geometric and arithmetic means were reported in different studies) or failed to report crucial information on sample size, percent lipid, mean values of contaminant concentrations, or fish size, thus precluding direct comparison of the data from different studies and complicating further statistical analysis and risk assessment.

1.1.1 Establishment of the Fish Contaminant Workgroup

As a result of NAS concerns and state concerns expressed in the AFS survey, EPA's Office of Water established a Fish Contaminant Workgroup. It was composed of representatives from EPA and the following state and federal agencies:

- U.S. Food and Drug Administration (FDA)
- U.S. Fish and Wildlife Service (FWS)
- Ohio River Valley Water Sanitation Commission (ORSANCO)
- National Oceanic and Atmospheric Administration (NOAA)
- Tennessee Valley Authority (TVA)
- United States Geological Survey (USGS)

and representatives from 26 states: Alabama, Arkansas, California, Colorado, Delaware, Florida, Georgia, Illinois, Indiana, Louisiana, Maryland, Massachusetts, Michigan, Minnesota, Missouri, Nebraska, New Hampshire, New Jersey, New York, North Carolina, North Dakota, Ohio, Oregon, Texas, Virginia, and Wisconsin.

The objective of the EPA Fish Contaminant Workgroup was to formulate guidance for states on how to sample and analyze chemical contaminants in fish and shellfish where the primary end uses of the data included development of fish consumption advisories. The Workgroup compiled documents describing protocols currently used by various federal agencies, EPA Regional offices, and states that have extensive experience in fish contaminant monitoring. Using these documents, they selected methods considered most cost-effective and scientifically sound for sampling and analyzing fish and shellfish tissues. These methods were recommended as standard procedures for use by the states and are described in this guidance document.

1.1.2 Development of a National Fish Advisory Database

In addition to initiating work on the national guidance document series in 1993, EPA also initiated work on the development of a national database — The National Listing of Fish and Wildlife Advisories (NLFWA) database — for tracking fish and wildlife advisories issued by the states. The 1998 update of the NLFWA database includes all available information describing state, territorial, tribal, and federal fish consumption advisories issued in the United States (U.S. EPA 1999a, 1999c). The database contains fish consumption advisory information provided to EPA by the states and other jurisdictions from 1993 through December 1998. It also includes information from 1996 through 1997 for 12 Canadian provinces and territories. No updates to information on Canadian advisories were made in 1998. Since the release of the first fish advisory results in 1994, advisory results and trends have been accessible to states, territories, tribal organizations, and the general public by querying the NLFWA database or through summary information reported each year in the *EPA Fact Sheet—Update: National Listing of Fish and*

Wildlife Advisories. Fish advisory results and trends reported in the 1999 Fish Advisory Fact Sheet (U.S. EPA, 1999c) are presented below. The most recent updates of the Fish Advisory Fact Sheet are available on the EPA website at <http://epa.gov/OST/fish>.

1.1.2.1 Background—

The states, U.S. territories, and Native American tribes (hereafter referred to as states) have primary responsibility for protecting residents from the health risks of consuming contaminated noncommercially caught fish and wildlife. They do this by issuing consumption advisories for the general population, including recreational and subsistence fishers, as well as for sensitive subpopulations (such as pregnant women, nursing mothers, and children). These advisories inform the public that high concentrations of chemical contaminants (e.g., mercury and dioxins) have been found in local fish and wildlife. The advisories include recommendations to limit or avoid consumption of certain fish and wildlife species from specified waterbodies or, in some cases, from specific waterbody types (e.g., all inland lakes). Similarly, in Canada, the provinces and territories have primary responsibility for issuing fish consumption advisories for their residents.

States typically issue five major types of advisories and bans to protect both the general population and specific subpopulations.

- When levels of chemical contamination pose a health risk to the general public, states may issue a no consumption advisory for the general population.
- When contaminant levels pose a health risk to sensitive subpopulations, states may issue a no consumption advisory for the sensitive subpopulation.
- In waterbodies where chemical contamination is less severe, states may issue an advisory recommending that either the general population or a sensitive subpopulation restrict their consumption of the specific species for which the advisory is issued.
- The fifth type of state-issued advisory is the commercial fishing ban, which prohibits the commercial harvest and sale of fish, shellfish, and/or wildlife species from a designated waterbody and, by inference, the consumption of all species identified in the fishing ban from that waterbody.

As shown in Table 1-1, advisories of all types increased overall in number from 1993 to 1998.

1.1.2.2 Advisories in Effect—

The database includes information on

- Species and size ranges of fish and/or wildlife sampled
- Chemical contaminants identified in the advisory

Table 1-1. U.S. Advisories Issued from 1993 to 1998 by Type

	1993	1994	1995	1996	1997	1998
No Consumption – General Population	503	462	463	563	545	532
No Consumption – Sensitive Subpopulation	555	720	778	1,022	1,119	1,211
Restricted Consumption – General Population	993	1,182	1,372	1,763	1,843	2,062
Restricted Consumption – Sensitive Subpopulation	689	900	1,042	1,370	1,450	1,595
Commercial Fishing Ban	30	30	55	50	52	50

Source: U.S. EPA 1999a, 1999c.

- Geographic location of each advisory (including narrative information on landmarks, river miles, or latitude and longitude coordinates of the affected waterbody and map showing location of waterbody)
- Lake acreage or river miles under advisory
- Population for whom the advisory was issued
- Fish tissue chemical residue data from waterbodies under advisory.

The 1994, 1995, 1996, 1997, and 1998 versions of the NLFWA database can generate national, regional, and state maps that illustrate any combination of these advisory parameters. In addition, the 1996 through 1998 versions of the database can provide information on the percentage of waterbodies in each state currently under an advisory and the percentage of waters assessed. A new feature of the 1998 database provides users access to fish tissue residue data for those waterbodies under advisory in 16 states. The name of each state contact, phone number, FAX number, and e-mail address are also provided so that users can obtain additional information concerning specific advisories. Comparable advisory information (excluding tissue residue data) and contact information for 1996 and 1997 are provided for each Canadian province or territory.

1.1.2.3 Advisory Trends—

The number of waterbodies in the United States under advisory reported in 1998 (2,506) represents a 9% increase from the number reported in 1997 (2,299 advisories) and a 98% increase from the number of advisories issued since 1993 (1,266 advisories). Figure 1-1 shows the number of advisories in effect for each state in 1998 and the number of advisories issued or rescinded since 1997. The increase in advisories issued by the states generally reflects an increase in the number of assessments of the levels of chemical contaminants in fish and wildlife tissues. These additional assessments were conducted as a result of the increased awareness of health risks associated with the consumption of chemically contaminated fish and wildlife. Some of the increase in advisory numbers, however, may be due to the increasing use of EPA risk assessment procedures in setting advisories rather than FDA action levels developed for commercial fisheries.

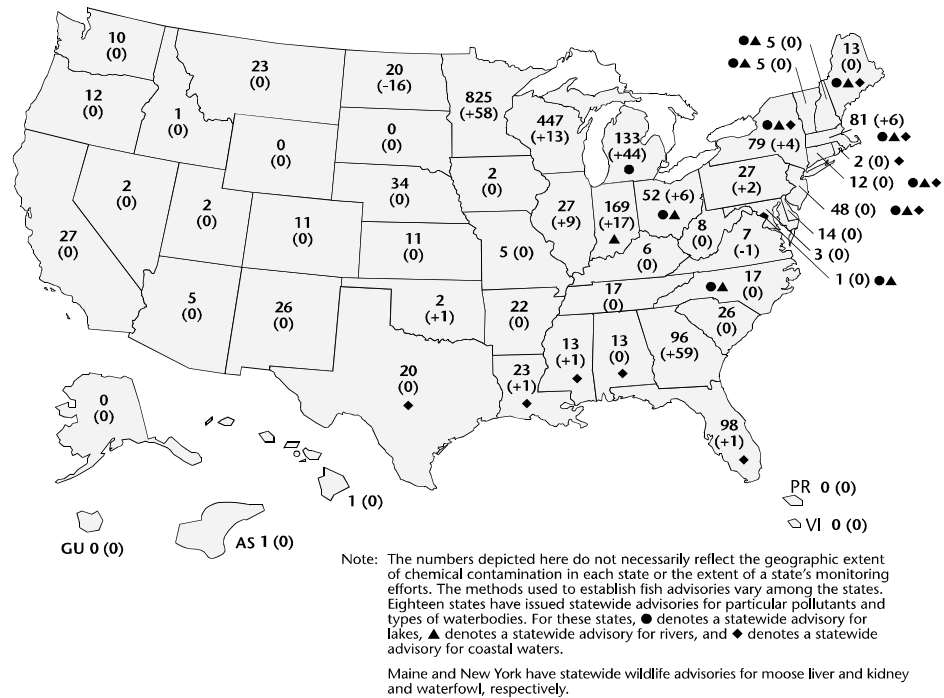

Source: U.S. EPA, 1999c.

Figure 1-1. Total number of fish advisories in effect in each state in 1998 (change from 1997).

1.1.2.4 Bioaccumulative Pollutants—

Although U.S. advisories have been issued for a total of 46 chemical contaminants, most advisories issued have involved five primary contaminants. These chemical contaminants are biologically accumulated in the tissues of aquatic organisms at concentrations many times higher than concentrations in the water. In addition, these chemical contaminants persist for relatively long periods in sediments where they can be accumulated by bottom-dwelling organisms and passed up the food chain to fish. Concentrations of these contaminants in the tissues of aquatic organisms may be increased at each successive level of the food chain. As a result, top predators in a food chain, such as largemouth bass, salmon, or walleye, may have concentrations of these chemicals in their tissues that can be a million times higher than the concentrations in the water. Mercury, PCBs, chlordane, dioxins, and DDT (and its degradation products, DDE and DDD) were at least partly responsible for 99 percent of all fish consumption advisories in effect in 1998. (See Figure 1-2.)

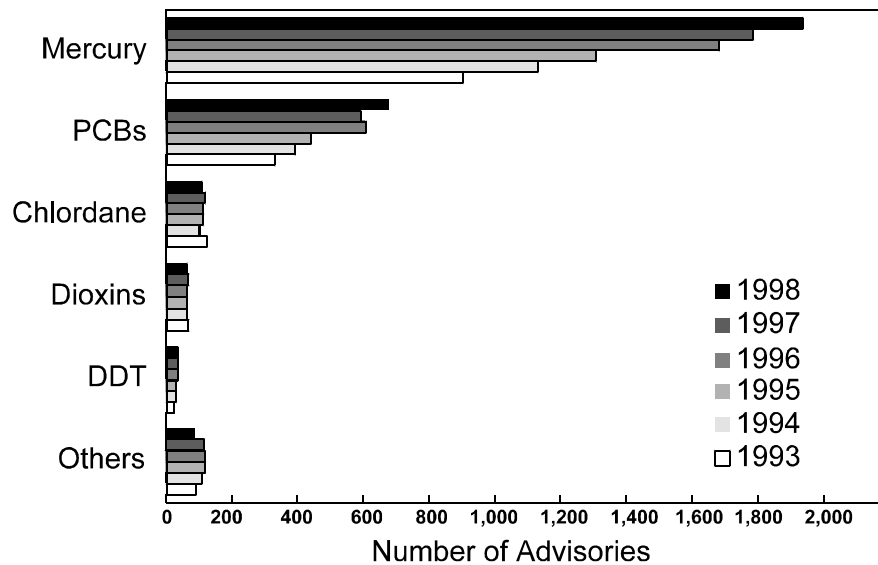

Source: U.S. EPA, 1999a, 1999c.

Figure 1-2. Trends in number of advisories issued for various pollutants.

1.1.2.5 Wildlife Advisories—

In addition to advisories for fish and shellfish, the database also contains several wildlife advisories. Four states have issued consumption advisories for turtles: Arizona (3), Massachusetts (1), Minnesota (8), and New York (statewide advisory). One state (Massachusetts) has an advisory for frogs, New York has a statewide advisory for waterfowl (including mergansers), Arkansas has an advisory for woodducks, and Utah has an advisory for American coot and ducks. Maine issued a statewide advisory for moose liver and kidneys due to cadmium levels. No new wildlife advisories were issued in 1998.

1.1.2.6 1998 United States Advisories—

The 1998 database lists 2,506 advisories in 47 states, the District of Columbia, and the U.S. Territory of American Samoa. Some of these advisories represent statewide advisories for certain types of waterbodies (e.g., lakes, rivers, and/or coastal waters). An advisory may represent one waterbody or one type of waterbody within a state's jurisdiction. Statewide advisories are counted as one advisory. The database counts one advisory for each waterbody name or type of waterbody regardless of the number of fish or wildlife species that are affected or the number of chemical contaminants detected at concentrations of human health concern. Eighteen states (Alabama, Connecticut, District of Columbia, Florida, Indiana, Louisiana, Maine, Massachusetts, Michigan, Mississippi, New Hampshire, New Jersey, New York, North Carolina, Ohio, Rhode Island, Texas,

and Vermont) currently have statewide advisories in effect (see Table 1-2). Missouri rescinded its statewide advisories for lakes and rivers in 1998, and Mississippi added a statewide coastal advisory for mercury. A statewide advisory is issued to warn the public of the potential for widespread contamination of certain species of fish in certain types of waterbodies (e.g., lakes, rivers and streams, or coastal waters) or certain species of wildlife (e.g., moose or waterfowl). In such a case, the state may have found a level of contamination of a specific pollutant in a particular fish or wildlife species over a relatively wide geographic area that warrants advising the public of the situation.

The statewide advisories and 2,506 specifically named waterbodies represent approximately 15.8 percent of the Nation's total lake acreage and 6.8% of the Nation's total river miles. In addition, 100 percent of the Great Lakes waters and their connecting waters are also under advisory due to one or more contaminants (e.g., PCBs, dioxins, mercury, and/or chlordane). The Great Lakes waters are considered separately from other lakes, and their connecting waters are considered separately from other river miles.

Several states also have issued fish advisories for all of their coastal waters. Using coastal mileages calculated by the National Oceanic and Atmospheric Administration (NOAA), an estimated 58.9 percent of the coastline of the contiguous 48 states currently is under advisory. This includes 61.5 percent of the Atlantic Coast and 100 percent of the Gulf Coast. No Pacific Coast state has issued a statewide advisory for any of its coastal waters although several localized areas along the Pacific Coast are under advisory. The Atlantic coastal advisories have been issued for a wide variety of chemical contaminants including mercury, PCBs, dioxins, and cadmium, while all of the Gulf Coast advisories have been issued for mercury.

1.1.2.7 Database Use and Access—

The NLFWA database was developed by EPA to help federal, state, and local government agencies and Native American tribes assess the potential for human health risks associated with consumption of chemical contaminants in noncommercially caught fish and wildlife. The data contained in this database may also be used by the general public to make informed decisions about the waterbodies in which they choose to fish or harvest wildlife; the frequency with which they fish these waterbodies; the species, size, and number of fish they collect; and the frequency with which they consume fish from specific waterbodies. Note: State fish advisory contact information and hyperlinks to state fish advisory websites are also provided.

EPA provides this 1998 update of the NLFWA database available on the Internet at

<http://www.epa.gov/OST/fish>

Table 1-2. Summary of Statewide Advisories in Effect in 1998

State	Lakes	Rivers	Coastal Waters
Alabama	—	—	Mercury
Connecticut	Mercury	Mercury	PCBs
District of Columbia	PCBs	PCBs	—
Florida	—	—	Mercury
Indiana	—	Mercury PCBs	—
Louisiana	—	—	Mercury
Maine	Mercury	Mercury	Dioxins
Massachusetts	Mercury	Mercury	PCBs Organics
Michigan	Mercury	—	—
Mississippi	—	—	Mercury
New Hampshire	Mercury	Mercury	PCBs
New Jersey	Mercury	Mercury	PCBs Cadmium Dioxins
New York	PCBs Chlordane Mirex DDT	PCBs Chlordane Mirex DDT	PCBs Cadmium Dioxins
North Carolina	Mercury	Mercury	—
Ohio	Mercury	Mercury	—
Rhode Island	—	—	PCBs
Texas	—	—	Mercury
Vermont	Mercury	Mercury	—

Source: U.S. EPA, 1999a, 1999c.

Further information on specific advisories within a particular state is available from the appropriate state agency contact listed in the database. This is particularly important for advisories recommending that consumers restrict their consumption of fish from certain waterbodies. State health departments provide more specific information for restricted consumption advisories (RGP and RSP) on the appropriate meal size and meal frequency (number of meals per week or month) that is considered safe to consume for a specific consumer group (e.g., the general public versus pregnant women, nursing mothers, and young children). For further information on Canadian advisories, contact the appropriate Province contact given in the database.

For more information concerning the National Fish and Wildlife Contamination Program, contact:

U.S. Environmental Protection Agency
 Office of Science and Technology
 National Fish and Wildlife Contamination Program—4305
 1200 Pennsylvania Avenue, NW
 Washington, DC 20460
 Phone 202 260-7301 FAX 202 260-9830
 e-mail: Bigler.Jeff@epa.gov

1.2 PURPOSE

The purpose of this manual is to provide overall guidance to states on methods for sampling and analyzing contaminants in fish and shellfish tissue that will promote consistency in the data they use to determine the need for fish consumption advisories. This manual provides guidance only and does not constitute a regulatory requirement for the states. It is intended to describe what EPA believes to be scientifically sound methods for sample collection, chemical analyses, and statistical analyses of fish and shellfish tissue contaminant data for use in fish contaminant monitoring programs that have as their objective the protection of public health. This nonregulatory, technical guidance manual is intended for use as a handbook by state and local agencies that are responsible for sampling and analyzing fish and shellfish tissue. Adherence to this guidance will enhance the comparability of fish and shellfish contaminant data, especially in interstate waters and thus provide more standardized information on fish contamination problems.

It should be noted that the EPA methodology described in Volumes 1 and 2 of this guidance series offers great flexibility to state users. These documents are designed to meet the objectives of state monitoring and risk assessment programs by providing options to meet specific state or study needs within state budgetary constraints. The users of this fish advisory guidance document should recognize that it is the consistent application of the EPA methodology and processes rather than individual elements of the program sampling design that are of major importance in improving consistency among state fish advisory programs. For example, whether a state elects to collect three composite samples of five individual fish or four composite samples of eight individual fish as the basis of its state program is of less importance than a state designing and executing its monitoring program with attention to all elements of the EPA methodology having been considered and addressed during the planning and implementation phases.

One major factor currently affecting the comparability of fish advisory information nationwide, is the fact that the states employ different methodologies to determine the necessity for issuing an advisory. For example, some states currently do not use the EPA methodology at all or use it only in their assessment of health risks for certain chemical contaminants. Often these states rely instead on exceedances of FDA action levels or tolerances to determine the need to issue an advisory. FDA's mission is to protect the public health with respect to levels of chemical contaminants in all foods, including fish and shellfish sold in interstate commerce. FDA has developed both action levels and tolerances to address levels of contamination in foods. FDA may establish an action level when food contains a chemical from sources of contamination that cannot be avoided even by adherence to good agricultural or manufacturing practices, such as

contamination by a pesticide that persists in the environment. An action level is an administrative guideline or instruction to the agency field unit that defines the extent of contamination at which FDA may regard food as adulterated. An action level represents the limit at or above which FDA may take legal action to remove products from the marketplace. Under the Food, Drug, and Cosmetic Act, FDA also may set tolerances for unavoidably added poisonous or deleterious substances, that is, substances that are either required in the production of food or are otherwise unavoidable by good manufacturing practices. A tolerance is a regulation that is established following formal rulemaking procedures; an action level is a guideline or "instruction" and is not a formal regulation (Boyer et al., 1991).

FDA's jurisdiction in setting action levels or tolerances is limited to contaminants in food shipped and marketed in interstate commerce. Thus, the methodology used by FDA in establishing action levels or tolerances is directed at determining the health risks of chemical contaminants in fish and shellfish that are bought and sold in interstate commerce rather than in locally harvested fish and shellfish (Bolger et al., 1990). FDA action levels and tolerances are indicators of chemical residue levels in fish and shellfish that should not be exceeded for the general population who consume fish and shellfish typically purchased in supermarkets or fish markets that sell products that are harvested from a wide geographic area, including imported fish and shellfish products. However, the underlying assumptions used in the FDA methodology were never intended to be protective of recreational, tribal, ethnic, and subsistence fishers who typically consume larger quantities of fish than the general population and often harvest the fish and shellfish they consume from the same local waterbodies repeatedly over many years. If these local fishing and harvesting areas contain fish and shellfish with elevated tissue levels of chemical contaminants, these individuals potentially could have increased health risks associated with their consumption of the contaminated fish and shellfish.

The following chemical contaminants discussed in this volume have FDA action levels for their concentration in the edible portion of fish and shellfish: chlordane, DDT, DDE, DDD, heptachlor epoxide, mercury, and mirex. FDA has not set an action level for PCBs in fish but has established a tolerance in fish for this chemical. Table 1-3 compares the FDA action levels and tolerance for these six chemical contaminants with EPA's recommended screening values (SVs) for recreational and subsistence fishers calculated for these target analytes using the EPA methodology.

The EPA SV for each chemical contaminant is defined as the concentration of the chemical in fish tissue that is of potential public health concern and that is used as a threshold value against which tissue residue levels of the contaminant in fish and shellfish can be compared. The SV is calculated based on both the

Table 1-3. Comparison of FDA Action Levels and Tolerances with EPA Screening Values

Chemical contaminant	FDA Action Level ^a (ppm)	EPA SV for Recreational Fishers (ppm)	EPA SV for Subsistence Fishers (ppm)
Chlordane	0.3	0.114	0.014
Total DDT	5	0.117	0.014
Dieldrin	0.3	2.50 x 10 ⁻³	3.07 x 10 ⁻⁴
Heptachlor epoxide	0.3	4.39 x 10 ⁻³	5.40 x 10 ⁻⁴
Mercury	1.0	0.40	0.049
Mirex	0.1	0.80	0.098
	FDA Tolerance Level (ppm)		
PCBs	2	0.02	2.45 x 10 ⁻³

^aU.S. FDA 1998.

noncarcinogenic and carcinogenic effects of the chemical contaminant, which are discussed in detail in Section 5 of this volume. EPA recommends that the more conservative of the calculated values derived from the noncarcinogenic rather than the carcinogenic effects be used because it is more protective of the consumer population (either recreational or subsistence fishers). As can be seen in Table 1-3 for the recreational fisher SV, the EPA-recommended values typically range from 2 to 120 times lower and are thus more protective than the corresponding FDA action or tolerance level. This difference is even more striking for subsistence fishers for whom the SVs are 20 to 997 times lower than the FDA values.

EPA and FDA have agreed that the use of FDA Action Levels for the purpose of making local advisory determinations is inappropriate. In letters to all states, guidance documents, and annual conferences, this practice has been discouraged by EPA and FDA in favor of EPA's risk-based approach to derive local fish consumption advisories.

EPA has provided this guidance to be especially protective of recreational fishers and subsistence fishers within the general U.S. population. EPA recognizes, however, that Native American subsistence fishers are a unique subsistence fisher population that needs to be considered separately. For Native American subsistence fishers, eating fish is not simply a dietary choice that can be completely eliminated if chemical contamination reaches unacceptable levels; rather, eating fish is an integral part of their lifestyle and culture. This traditional lifestyle is a living religion that includes values about environmental responsibility and community health as taught by elders and tribal religious leaders (Harris and Harper, 1977). Therefore, methods for balancing benefits and risks from eating

contaminated fish must be evaluated differently than for the general fisher population (see Section 5.1.3.2).

To enhance the use of this guidance as a working document, EPA will issue additional information and updates to users as appropriate. It is anticipated that updates will include minor revisions such as the addition or deletion of chemicals from the recommended list of target analytes, new screening values as new toxicologic data become available, and new chemical analysis procedures for some target analytes as they are developed. A new edition of this document will be issued to include the addition of major new areas of guidance or when major changes are made to the Agency's risk assessment procedures.

EPA's Office of Water realizes that adoption of these recommended methods requires adequate funding. In practice, funding varies among states and resource limitations will cause states to tailor their fish and shellfish contaminant monitoring programs to meet their own needs. States must consider tradeoffs among the various parameters when developing their fish contaminant monitoring programs. These parameters include

- Total number of stations sampled
- Intensity of sampling at each site
- Number of chemical analyses and their cost
- Resources expended on data storage and analysis, QA and quality control (QC), and sample archiving.

Consideration of these tradeoffs will determine the number of sites sampled, number of target analytes analyzed at each site, number of target species collected, and number of replicate samples of each target species collected at each site (Crawford and Luoma, 1993).

1.3 OBJECTIVES

The specific objectives of this manual are to

1. Recommend a tiered monitoring strategy designed to
 - Screen waterbodies (**Tier 1**) to identify those harvested sites where chemical contaminant concentrations in the edible portions of fish and shellfish exceed human consumption levels of potential concern (screening values [**SVs**]). SVs for contaminants with carcinogenic effects are calculated based on selection of an acceptable cancer risk level. SVs for contaminants with noncarcinogenic effects are concentrations determined to be without appreciable noncancer health risk. For a contaminant with both carcinogenic and noncarcinogenic effects, EPA recommends that the lower (more conservative) of these two calculated SVs be used.

- Conduct intensive followup sampling (**Tier 2, Phase I**) to determine the magnitude of the contamination in edible portions of fish and shellfish species commonly consumed by humans in waterbodies identified in the screening process.
 - Conduct intensive sampling at additional sites (**Tier 2, Phase II**) in a waterbody where screening values were exceeded to determine the geographic extent of contamination in various size classes of fish and shellfish.
 - Conduct intensive followup sampling in waterbodies where none of the 25 SVs are exceeded in order to establish areas of unrestricted fish consumption or “green areas.”
2. Recommend target species and criteria for selecting additional species if the recommended target species are not present at a site.
 3. Recommend target analytes to be analyzed in fish and shellfish tissue and criteria for selecting additional analytes.
 4. Recommend risk-based procedures for calculating target analyte screening values.
 5. Recommend standard field procedures including
 - Site selection
 - Sampling time
 - Sample type and number of replicates
 - Sample collection procedures including sampling equipment
 - Field recordkeeping and chain of custody
 - Sample processing, preservation, and shipping.
 6. Recommend cost-effective, technically sound analytical methods and associated QA and QC procedures, including identification of
 - Analytical methods for target analytes with detection limits capable of measuring tissue concentrations at or below SVs
 - Sources of recommended certified reference materials
 - Federal agencies currently conducting QA interlaboratory comparison programs.
 7. Recommend procedures for data analysis and reporting of fish and shellfish contaminant data.
 8. Recommend QA and QC procedures for all phases of the monitoring program and provide guidance for documenting QA and QC requirements in a QA plan or in a combined work/QA project plan.

1.4 RELATIONSHIP OF MANUAL TO OTHER GUIDANCE DOCUMENTS

This manual is the first in a series of four documents to be prepared by EPA's Office of Water as part of a Federal Assistance Plan to help states standardize fish consumption advisories. This series of four documents—*Guidance for Assessing Chemical Contaminant Data for Use in Fish Advisories* includes

- Volume 1: *Fish Sampling and Analysis* (EPA 823-R-93-002), published August 1993; a second edition, published September 1995; and the current third edition (EPA-823-B-00-007) to be published in November 2000.
- Volume 2: *Risk Assessment and Fish Consumption Limits* (EPA 823-B-94-004), published June 1994; a second edition (EPA 823-B-97-009), published in July 1997; and a third edition (EPA-823-B-00-008) to be published in November 2000.
- Volume 3: *Overview of Risk Management* (EPA 823-B-96-006), published in June 1996.
- Volume 4: *Risk Communication* (EPA 823-R-95-001), published March 1995.

This sampling and analysis manual is not intended to be an exhaustive guide to all aspects of sampling, statistical design, development of risk-based screening values, laboratory analyses, QA and QC considerations, data analysis, and reporting for fish and shellfish contaminant monitoring programs. Key references are provided in Section 10, Literature Cited, that detail various aspects of these topics.

1.5 CONTENTS OF VOLUME 1

Figure 1-3 shows how Volume 1 fits into the overall guidance series and lists the major categories of information provided. The first five sections discuss the history of the EPA Fish and Wildlife Contamination Program, monitoring strategy, including selection of target fish and shellfish species, selection of target analytes, and calculation of screening values for all target analytes. Section 6 provides guidance on field sampling and preservation procedures. Sections 7 and 8 provide guidance on laboratory procedures including sample handling and analysis, and Section 9 discusses data analysis and reporting procedures.

Appropriate QA and QC considerations are integral parts of each of the recommended procedures. Section 10 is a compilation of all literature cited in Sections 1 through 9 of this document. New information or revisions to existing information contained in previous editions of this guidance document are briefly described in Section 1.6.

Section 1 of this document reviews the historical development of this guidance document series, describes the purpose and objectives of the Volume 1 manual,

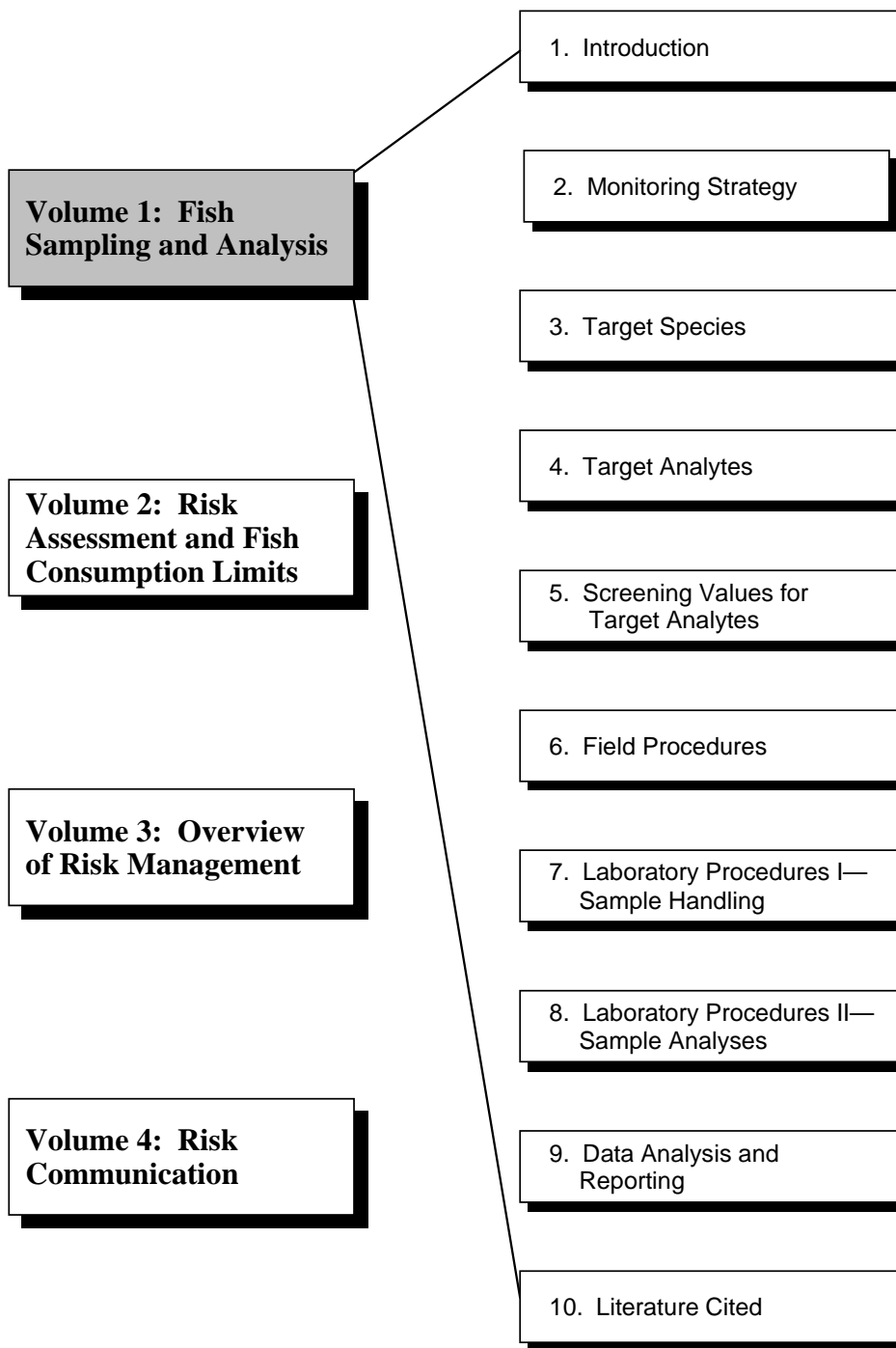

Figure 1-3. Series summary: Guidance for assessing chemical contamination data for use in fish advisories.

outlines the relationship of the manual to the other three documents in the series, describes the contents of the manual, and identifies new revisions made to the guidance of this third edition.

Section 2 outlines the recommended strategy for state fish and shellfish contaminant monitoring programs. This strategy is designed to (1) routinely screen waterbodies to identify those locations where chemical contaminants in edible portions of fish and shellfish exceed human health screening values, (2) sample more intensively those waterbodies where exceedances of these SVs have been found in order to assess the magnitude and the geographic extent of the contamination, and (3) identify those areas where chemical contaminant concentrations are low and would allow states to designate areas where unrestricted fish consumption may be permitted.

Section 3 discusses the purpose of using target species and criteria for selection of target species for both screening and intensive studies. Lists of recommended target species are provided for inland fresh waters, Great Lakes waters, and seven distinct estuarine and coastal marine regions of the United States.

Section 4 presents a list of recommended target analytes to be considered for inclusion in screening and intensive studies, briefly discusses the original criteria used in selecting these analytes, provides a summary of the toxicological information available for each analyte as well as pertinent information on the analyte's detection in national and regional fish monitoring studies.

Section 5 describes the new EPA risk-based procedure for calculating screening values for target analytes using (1) an adult body weight of 70 kg, (2) a lifetime exposure of 70 years, and (3) new consumption rate default values for both the general population and recreational fishers (17.5 g/d) and subsistence fishers (142.4 g/d). The last part of this section describes how to compare these new SVs against results obtained in fish tissue residue analysis.

Section 6 recommends field procedures to be followed from the time fish or shellfish samples are collected until they are delivered to the laboratory for processing and analysis. Guidance is provided on site selection and sample collection procedures; the guidance addresses material and equipment requirements, time of sampling, size of animals to be collected, sample type, and number of samples. Sample identification, handling, preservation, shipping, and storage procedures are also described.

Section 7 describes recommended laboratory procedures for sample handling including: sample measurements, sample processing procedures, and sample preservation and storage procedures.

Section 8 presents recommended laboratory procedures for sample analyses, including cost-effective analytical methods and associated QC procedures; and information on sources of certified reference materials; recommended analytical

techniques for target analytes, including revised detection and quantitation limits; information on the per-sample cost of chemical analysis for each target analyte; and information on federal agencies currently conducting interlaboratory comparison programs.

Section 9 includes procedures for data analysis to determine the need for additional monitoring and risk assessment and for data reporting.

Supporting documentation for this guidance is provided in Section 10, Literature Cited and in Appendixes A through N.

1.6 NEW INFORMATION AND REVISIONS TO VOLUME 1

This 3rd edition of Volume 1 contains newly prepared material as well as major updates and revisions to existing information. A brief summary of major additions and revisions is provided below.

Section 1

- New information is presented on the NLFWA database, including the 5-year trend in the total number of advisories issued nationwide, the number of advisories issued for five major pollutants of concern, and the issuance of increasing numbers of statewide advisories for freshwater lakes and/or rivers and coastal marine areas.
- Additional information describes the flexibility that is built into the EPA methodology, which allows the method to be used to meet a wide variety of state or tribal study needs within budgetary constraints.
- Clarification of the FDA methodology is provided emphasizing the inappropriateness of the method and reasons states should adopt and use the EPA methodology when issuing fish consumption advisories to protect their recreational and subsistence fishers.

Section 2

- Updated information is presented in Table 2-1 to be consistent with monitoring design and risk assumptions used in this 3rd edition.
- New discussion of the criteria states may use to identify green areas where chemical contaminant concentrations are at or below the screening values for recreational or subsistence fishers is introduced with more detailed information provided in Appendix B.

Section 3

- Several tables, including Tables 3-7 and 3-19, were updated to include new information from the 1998 NLFWA database on the number of states that have issued fish advisories for freshwater and marine species.
- Table 3-9 was updated and associated narrative text was revised to include information on studies using turtles as biomonitors of environmental contaminants.

Section 4

- Information on the environmental sources, toxicology, and the number of fish advisories issued in 1998 for each of the 25 target analytes was updated.
- New information is included on the range in concentrations of each contaminant detected in the FWS National Contaminant Biomonitoring Program and the EPA National Study of Chemical Residues in Fish as well as information on more recent regional studies.
- A procedure is described for the selection and prioritization of target analytes for analysis predicated on a watershed-based approach that takes into consideration land use categories, as well as geological characteristics, regional differences, national fish advisory trends, and monitoring and analysis costs.
- Additional guidance is presented on organophosphate pesticides and when and under what situations to monitor fish tissues for these compounds.
- A clarification is provided of the recommendation for selection of target species, especially bivalve molluscs and/or crustaceans when PAH contamination is suspected.
- A new discussion is provided to reflect the Agency's position on using Aroclor and congener analysis for calculating total PCB concentration.
- A new discussion is provided for determining the TEQ value for dioxins, which are now defined as including the 17 2,3,7,8 congeners of dioxin and 2,3,7,8 congeners of dibenzofuran, and the 12 coplanar PCBs with dioxin-like properties based on recent guidance from the World Health Organization (Van den Berg et al., 1998).
- Several tables, including Tables 4-1, 4-2, 4-7, and 4-9 were revised with new information. Tables 4-3, 4-4, 4-5, 4-6, and 4-8 are new to the document.
- All of the toxicological information was revised in light of the most current information concerning each target analyte.

Section 5

- Revisions were made describing major changes in the assumptions used in the risk assessment equations to calculate screening values including use of default consumption rates of 17.5 g/d for the general population and recreational fishers and 142.4 g/d for subsistence fishers based on more recent information from the 1994 to 1996 Continuing Survey of Food Intake by Individuals study conducted by the U.S. Department of Agriculture.
- Additional guidance is provided on how states should handle the interpretation and risk assessment of chemicals that have detection limits higher than the risk-based screening values.
- Tables 5-1, 5-3, 5-4, and 5-5 were revised to reflect changes in consumption rates. Screening values shown in Tables 5-3 and 5-4 were developed using the new consumption rates as well as the most recent RfD and cancer slope factors available.
- Additional information is provided on Native American subsistence fishers, and Table 5-2 was added to summarize several recent studies on Native American fish consumption rates.
- Additional guidance is provided on how states should deal with interpreting analytical results in cases where the screening value is lower than the detection limit for a particular analyte.
- New guidance is provided on determining total PCBs by summary Aroclor equivalents or PCB congeners.
- New information from the World Health Organization (Van den Berg et al., 1998) is included in Table 5-6 showing the most recent Toxic Equivalency Factors (TEF) for the 2,3,7,8-substituted dioxins, dibenzofurans, and the 12 coplanar PCBs.

Section 6

- Additional information is provided on the statistical implications associated with deviations from the recommended sampling design, including the use of unequal numbers of fish per composite, sizes of fish exceeding the size range recommendations for composites, and the use of unequal numbers of replicate samples across sampling sites.
- Clarification is provided on the recommended number of fish that should make up a composite sample.

- More explicit information is provided regarding exceedances of screening values and the statistical basis for issuing a new advisory or rescinding an existing advisory.
- Discussion is provided on the number of samples necessary to characterize different waterbody types and sizes of waterbodies with consideration given to the home range and mobility of the target species.
- How regional data should be used in the risk assessment process to address statewide advisories is discussed.
- Additional guidance is provided on how sample type selection should be based on the study objectives as well as on the sample type consumed by the target population.
- Clarification is provided as to EPA's position on the use of dead, lacerated, or mutilated fish for human health risk assessments.
- New information is provided on U.S. Fish and Wildlife Service and National Marine Fisheries permit requirements in situations where concerns exist about the impact of sampling for the target species in areas inhabited by threatened or endangered species.
- Revisions were made in recordkeeping for field sampling associated with use of the Year 2000 compliant format (YYYYMMDD) for sampling date information.

Section 7

- Revisions were made in recordkeeping forms to initiate use of the Year 2000 compliant format for the date of sampling and analysis procedures.

Section 8

- Updated information is included in Tables 8-1 through 8-5.
- Updated information is provided on the EPA Environmental Monitoring Methods Index System (EMMI).
- Revised information is provided in Section 8.3.3.8.1 concerning round-robin analysis interlaboratory comparison programs.

Section 9

- New information is included on the National Tissue Residue Data Repository, now housed within the NLFWA database.

- Recommended data reporting requirements were updated (Figure 9-1) to include Year 2000 compliant format.
- Detailed information is provided on the Internet-based data entry facility contained within the NLFWA database that can accept fish contaminant residue data to support state fish advisories.
- An example of the new data tables (Figure 9-2) currently used in the fish tissue residue data repository is provided.

Section 10

- Literature citations were revised to include all new references cited in Sections 1 through 9.

Appendixes:

- The following appendixes were revised or added:
 - A - EPA 1993 Fish Contamination Workgroup Members
 - B - Screening Values for Defining Green Areas
 - D - Fish and Shellfish Species for Which State Consumption Advisories Have Been Issued
 - F - Pesticide and Herbicides Recommended as Target Analytes
 - G - Target Analyte Dose-Response Variables and Associated Information
 - I - Quality Assurance and Quality Control Guidance
 - M - Sources of Reference Materials

SECTION 2

MONITORING STRATEGY

The objective of this section is to describe the strategy recommended by the EPA Office of Water for use by states in their fish and shellfish contaminant monitoring programs. A two-tiered strategy is recommended as the most cost-effective approach for State contaminant monitoring programs to obtain data necessary to evaluate the need to issue fish or shellfish consumption advisories. This monitoring strategy is shown schematically in Figure 2-1 and consists of

- **Tier 1—Screening studies** of a large number of sites for chemical contamination where sport, subsistence, and/or commercial fishing is conducted. This screening will help states identify those sites where concentrations of chemical contaminants in edible portions of commonly consumed fish and shellfish indicate the potential for significant health risks to human consumers.
- **Tier 2—Two-phase intensive studies** of problem areas identified in screening studies to determine the magnitude of contamination in edible portions of commonly consumed fish and shellfish species (**Phase I**), to determine size-specific levels of contamination, and to assess the geographic extent of the contamination (**Phase II**).

One key objective in the recommendation of this approach is to improve the data used by states for issuing fish and shellfish consumption advisories. Other specific aims of the recommended strategy are

- To ensure that resources for fish contaminant monitoring programs are allocated in the most cost-effective way. By limiting the number of sites targeted for intensive studies, as well as the number of target analytes at each intensive sampling site, screening studies help to reduce overall program costs while still allowing public health protection objectives to be met.
- To ensure that sampling data are appropriate for developing risk-based consumption advisories.
- To ensure that sampling data are appropriate for determining contaminant concentrations in various size (age) classes of each target species so that states can give size-specific advice on contaminant concentrations (as appropriate).

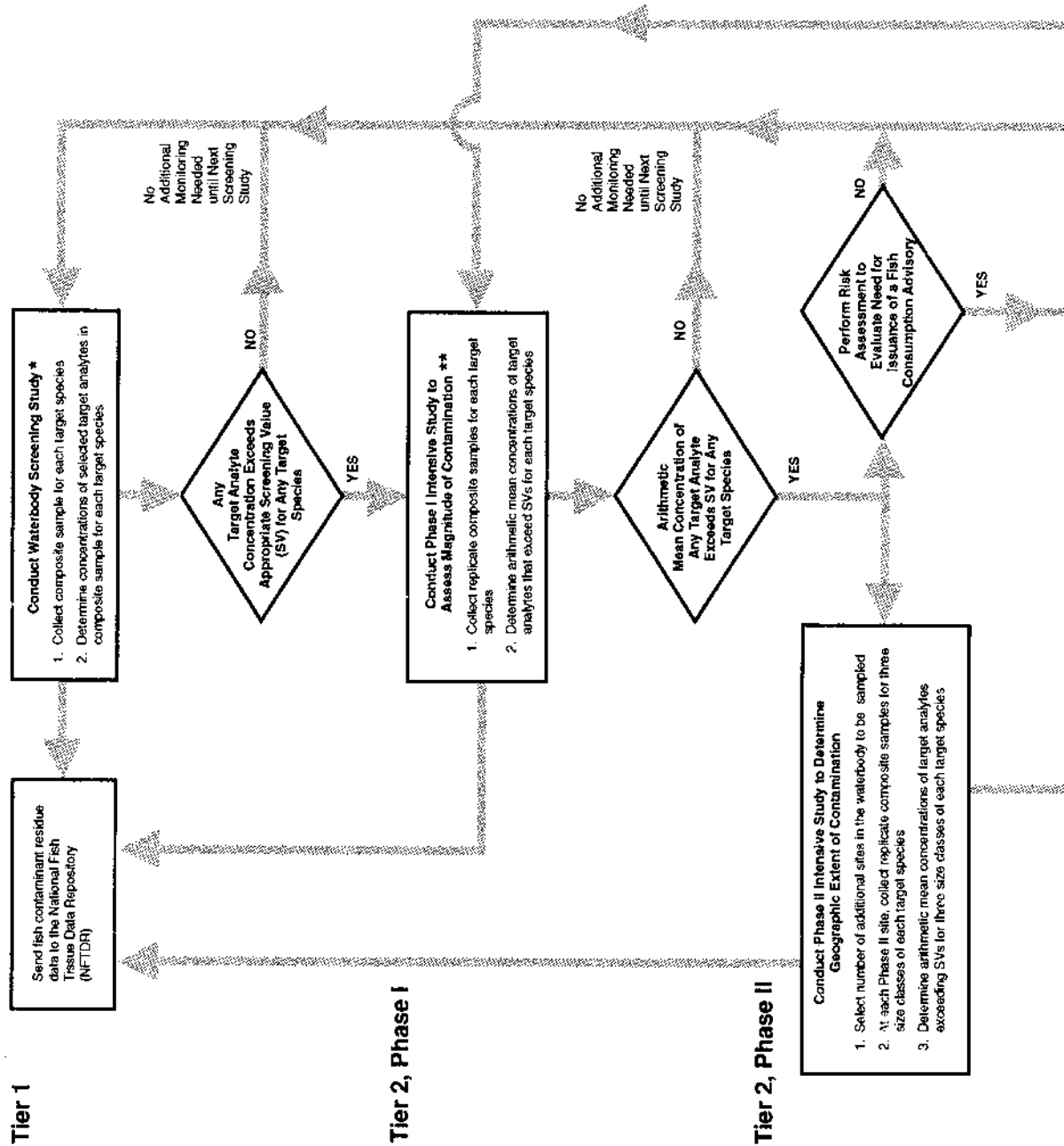

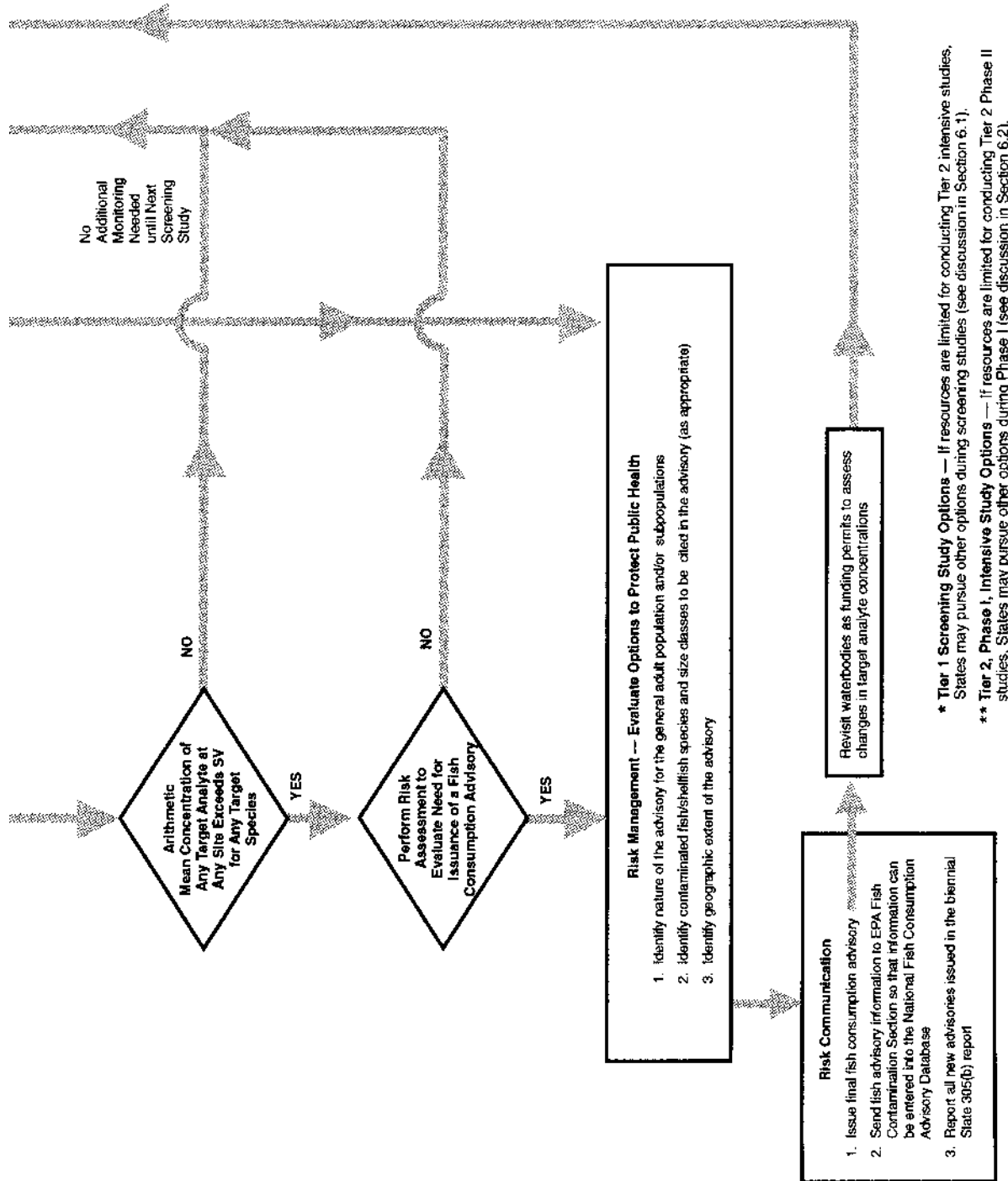

Figure 2-1. Recommended strategy for state fish and shellfish contaminant monitoring programs.

- To ensure that sampling designs are appropriate to allow statistical hypothesis testing. Such sampling designs permit the use of statistical tests to detect a difference between the average tissue contaminant concentration at a site and the human health screening value for any analyte.

The following elements must be considered when planning either screening studies or more intensive followup sampling studies:

- Study objective
- Target species (and size classes)
- Target analytes
- Target analyte screening values
- Sampling locations
- Sampling times
- Sample type
- Sample replicates
- Sample analysis
- Data analysis and reporting.

Detailed guidance for each of these elements, for screening studies (**Tier 1**) and for both Phase I and Phase II of intensive studies (**Tier 2**), is provided in this document. The key elements of the monitoring strategy are summarized in Table 2-1, with reference to the section number of this document where each element is discussed.

2.1 SCREENING STUDIES (TIER 1)

The primary aim of screening studies is to identify frequently fished sites where concentrations of chemical contaminants in edible fish and shellfish composite samples exceed specified human health screening values and thus require more intensive followup sampling. Ideally, screening studies should include all waterbodies where commercial, recreational, or subsistence fishing is practiced; specific sampling sites should include areas where various types of fishing are conducted routinely (e.g., from a pier, from shore, or from private and commercial boats), thereby exposing a significant number of individuals to potentially adverse health effects. Composites of skin-on fillets (except for catfish and other scaleless species, which are usually prepared as skin-off fillets) and edible portions of shellfish are recommended for contaminant analyses in screening studies to provide conservative estimates of typical exposures for the general population. If consumers remove the skin and fatty areas from a fish before preparing it for eating, exposures to some contaminants can be reduced (see U.S. EPA, 2000a, Appendix C of Volume 2 of this guidance document series).

Note: If the target population of consumers includes primarily ethnic or subsistence fishers who consume the whole fish or tissues of the fish not typically consumed by the general population, state monitoring programs should include the fish sample type associated with the target consumers' dietary and/or culinary preference (see Section 6.1.1.6, Sample Type, for additional information.)

Table 2-1. Recommended Strategy for State Fish and Shellfish Contaminant Monitoring Programs

Program element	Tier 1 Screening study	Tier 2 Intensive study (Phase I)	Tier 2 Intensive study (Phase II)
	Objective (see Section 2)	Identify frequently fished sites where commonly consumed fish and shellfish target species are contaminated and may pose potential human health risk.	Assess and verify magnitude of tissue contamination at screening site for commonly consumed target species.
Target species and size classes (see Sections 3 and 6)	Select target species from commonly consumed species using the following additional criteria: known to bioaccumulate high concentrations of contaminants and distributed over a wide geographic area.	Resample target species at sites where they were found to be contaminated in screening study.	Resample at additional sites in the waterbody 3 size classes of the target species found to be contaminated in Phase I study.
	Recommended types of target species: Inland fresh waters: 1 bottom-feeder 1 predator Great Lakes: 1 bottom-feeder 1 predator Estuarine/marine: 1 shellfish and 1 fish species 2 fish species (one species should be bottom-feeder). or 2 fish species (one species should be bottom-feeder).		
	OPTIONAL: If resources are limited and a state cannot conduct Tier 2 intensive studies, the state may find it more cost-effective to collect additional samples during the Tier 1 screening study. States may collect (1) one composite sample of each of three size classes for each target species, (2) replicate composite samples for each target species, or (3) replicate composite samples of each of three size classes for each target species.	OPTIONAL: If resources are limited and a state cannot conduct Tier 2, Phase II, intensive studies, the state may find it more cost-effective to collect additional samples during the Tier 2, Phase I, intensive study. States may collect replicate composite samples of three size classes of the target species found to be contaminated to assess size-specific contaminant concentrations. Other commonly consumed target species may also be sampled if resources allow.	OPTIONAL: If resources allow, select additional commonly consumed target species using same criteria as in Phase I study.

See notes at end of table.

(continued)

Table 2-1. (continued)

Program element	Tier 1 Screening study	Tier 2 Intensive study (Phase I)	Tier 2 Intensive study (Phase II)
Target analytes (see Section 4)	Consider all target analytes listed in Table 4-1 for analysis but prioritize the 25 target analytes based on water and sediment sampling results, land use within the watershed, geographic characteristics, regional and national advisory trends and analytical costs. Include additional site-specific target analytes as appropriate based on current or historic data.	Analyze only for those target analytes from Tier 1 screening study that exceeded SVs.	Analyze only for those target analytes from Tier 2, Phase I, study that exceeded SVs.
Screening values (see Section 5)	Calculate SVs using oral RfDs for noncarcinogens and using oral slope factors and an appropriate risk level (10^{-4} to 10^{-7}) for carcinogens, for adults consuming 17.5 g/d and 142.4 g/d of fish and shellfish (default values) or based on site-specific dietary data. Note: In this guidance document, EPA's Office of Water used 17.5 g/d (for recreational fishers) and 142.4 g/d (for subsistence fishers) consumption rates, 70-kg adult body weight, and, for carcinogens, used a 10^{-5} risk level, 70-year exposure, and assumed no loss of contaminants during preparation or cooking. States may use other SVs for site-specific exposure scenarios by adjusting values for consumption rate, body weight, risk level, exposure period, and contaminant loss during preparation or cooking.	Use same SVs as in screening study.	Use same SVs as in screening study.
Sampling sites (see Section 6)	Sample target species at sites in each harvest area that have a high probability of contamination and at presumed clean sites or given areas as resources allow (see Appendix A).	Sample target species at each site identified in the screening study where fish/shellfish tissue concentrations exceed SVs to assess the magnitude of contamination.	Sample at additional sites in the harvest area 3 size classes of the target species found to be contaminated in Phase I study to assess the geographic extent of the contamination in the waterbody.

See notes at end of table.

(continued)

Table 2-1. (continued)

Program element	Tier 1 Screening study	Tier 2 Intensive study (Phase I)	Tier 2 Intensive study (Phase II)
<u>Sampling times</u> (see Section 6)	Sample during legal harvest season when target species are most available to consumers. Ideally, sampling time should not include the spawning period for target species unless the target species can be legally harvested during this period.	Same as screening study.	Same as screening study.
<u>Sample type</u> (see Sections 6 and 7)	Collect composite fillet samples (skin on, belly flap included) for each target fish species and composite samples of edible portions of target shellfish species. The exceptions to the "skin on, belly flap included" recommendation is to use skin-off fillets for catfish and other scaleless species. OPTIONAL: States may use individual fish samples, whole fish, or other sample types, if necessary, to improve exposure estimates of local fish-, shellfish-, or turtle-consuming populations. Sample type should reflect dietary and fish preparation methods of the target population of concern.	Same as screening study.	Same as screening study but collect composite samples for three size classes of each target species as appropriate.
<u>Sample replicates</u> (see Section 6)	Collect one composite sample for each target species. Collection of replicate composite samples is encouraged but is optional. If resources allow, collect a minimum of one replicate composite sample for each target species at 10% of the screening sites for QC.	Same as screening study.	Same as screening study.
<u>Sample analysis</u> (see Section 8)	Use standardized and quantitative analytical methods with limits of detection adequate to allow reliable quantitation of selected target analytes at or below SVs.	Use same analytical methods as in screening study.	Use same analytical methods as in screening study.

See notes at end of table.

(continued)

Table 2-1. (continued)

Program element	Tier 1 Screening study	Tier 2 Intensive study (Phase I)	Tier 2 Intensive study (Phase II)
Data analysis and reporting (see Sections 6, 7, 8, and 9)	For each target species, compare target analyte concentrations of composite sample with SVs to determine which sites require Tier 2, Phase I, intensive study.	For each target species, compare target analyte arithmetic mean concentrations of replicate composite samples with SVs to determine which sites require Phase II intensive study. If resources are insufficient to conduct Phase II intensive study, conduct a risk assessment and assess the need for issuing a preliminary fish or shellfish consumption advisory.	For each of three size classes within each target species, compare target analyte arithmetic mean concentrations of replicate composite samples at each Phase II site with SVs to determine geographic extent of fish or shellfish contamination. Assess the need for issuing a final fish or shellfish consumption advisory.
Data analysis and reporting (see Sections 6, 7, 8, and 9) (continued)	The following information should be reported for each target species at each site: <ul style="list-style-type: none"> • Site location (e.g., sample site name, water-body name, type of waterbody, and latitude/longitude) • Scientific and common name of target species • Sampling date and time • Sampling gear type used • Sampling depth • Number of QC replicates (optional) • Number of individual organisms used in the composite sample and in the QC replicate composite sample if applicable 	The following information should be reported for each target species at each site: <ul style="list-style-type: none"> • Same as screening study. • Same as screening study • Same as screening study • Same as screening study • Same as screening study • Number of replicates • Number of individual organisms used in each replicate composite sample 	The following information should be reported for each of three size classes within each target species at each site: <ul style="list-style-type: none"> • Same as screening study. • Same as screening study • Same as screening study • Same as screening study • Same as Phase I study • Same as Phase I study

See notes at end of table.

(continued)

Table 2-1. (continued)

Program element	Tier 1 Screening study	Tier 2 Intensive study (Phase I)	Tier 2 Intensive study (Phase II)
	<ul style="list-style-type: none"> Predominant characteristics of specimens used in the composite sample and in the QC replicate if applicable (e.g., life stage, age, sex, total length or body size) and description of fish fillet or edible parts of shellfish (tissue type) used Analytical methods used (including a method for lipid analysis) and method detection and quantitation limits for each target analyte. 	<ul style="list-style-type: none"> Predominant characteristics of specimens used in each replicate composite sample (e.g., life stage, age, sex, total length or body size) and description of fish fillet or edible parts of shellfish (tissue type) used Same as screening study 	<ul style="list-style-type: none"> Same as Phase I study Same as screening study
<u>Data analysis and reporting</u> (see Sections 6, 7, 8, and 9) (continued)	<ul style="list-style-type: none"> Sample cleanup procedures Data qualifiers Percent lipid in each composite sample. For each target analyte: <ul style="list-style-type: none"> Total wet weight of composite sample (g) used in analysis Measured concentration (wet weight) in composite sample including units of measurement for target analyte Measured concentration (wet weight) in the QC replicate, if applicable 	<ul style="list-style-type: none"> Same as screening study. Same as screening study. Same as screening study. For each target analyte: <ul style="list-style-type: none"> Total wet weight of each replicate composite sample (g) used in analysis Measured concentration (wet weight) in each replicate composite sample and units of measurement for target analyte Range of concentrations (wet weight) for each set of replicate composite samples Mean (arithmetic) concentration (wet weight) for each set of replicate composite samples Standard deviation of mean concentration (wet weight) 	<ul style="list-style-type: none"> Same as screening study. Same as screening study. Same as screening study. For each target analyte: <ul style="list-style-type: none"> Same as Phase I study Same as Phase I study Same as Phase I study Same as Phase I study Same as Phase I study Same as Phase I study

See notes at end of table.

Table 2-1. (continued)

Program element	Tier 1 Screening study	Tier 2 Intensive study (Phase I)	Tier 2 Intensive study (Phase II)
<ul style="list-style-type: none"> - Evaluation of laboratory performance (i.e., description of all QA and QC samples associated with the sample(s) and results of all QA and QC analyses) 	<ul style="list-style-type: none"> - Same as screening study 	<ul style="list-style-type: none"> - Same as screening study 	<ul style="list-style-type: none"> - Same as screening study
<ul style="list-style-type: none"> - Comparison of measured concentration of composite sample with SV and clear indication of whether SV was exceeded 	<ul style="list-style-type: none"> - Comparison of target analyte arithmetic mean concentration of replicate composite samples with SV using hypothesis testing and clear indication of whether the SV was exceeded 	<ul style="list-style-type: none"> - Same as Phase I study 	<ul style="list-style-type: none"> - Same as Phase I study

QA = Quality assurance.
 QC = Quality control.

RfDs = Reference doses.
 SVs = Screening values.

Because the sampling sites in screening studies are focused primarily on the most likely problem areas and the numbers of commonly consumed target species and samples collected are limited, relatively little detailed information is obtained on the magnitude and geographic extent of contamination in a wide variety of harvestable fish and shellfish species of concern to consumers. More information is obtained through additional intensive followup studies (**Tier 2, Phases I and II**) conducted at potentially contaminated sites identified in screening studies.

Although the EPA Office of Water recommends that screening study results not be used as the sole basis for conducting a risk assessment, EPA recognizes that this practice may be unavoidable if monitoring resources are limited or if the state must issue an advisory based on detection of elevated concentrations in one composite sample. States have several options for collecting samples during the **Tier 1** screening study (see Figure 2-1), which can provide additional information on contamination without necessitating additional field monitoring expenditures as part of the **Tier 2** intensive studies.

The following assumptions are made in this guidance document for sampling fish and shellfish and for calculating human health SVs for recreational and subsistence fishers:

- Use of commonly consumed target species that are dominant in the catch and have high bioaccumulation potential (see Section 3, Target Species)
- Use of fish fillets (with skin on and belly flap tissue included) for scaled finfish species, use of skinless fillets for scaleless finfish species, and use of edible portions of shellfish (see Section 6.1.1.6, Sample Type)
- Use of fish and shellfish above legal size to maximum size in the target species
- Use of a 10^{-5} risk level, a human body weight of 70 kg (average adult), a consumption rate of 17.5 g/d for recreational fishers and 142.4 g/d for subsistence fishers, and a 70-yr lifetime exposure period to calculate SVs for carcinogens.
- Use of a human body weight of 70 kg (average adult) and a consumption rate of 17.5 g/d for recreational fishers and 142.4 g/d for subsistence fishers to calculate SVs for noncarcinogens (see Section 5, Screening Values for Target Analytes).
- Use of no contaminant loss during preparation and cooking or from incomplete absorption in the intestines.

For certain site-specific situations, states may wish to use one or more of the following exposure assumptions to protect the health of high-end fish consumers such as subsistence fishers at potentially greater risk:

- Use of commonly consumed target species that are dominant in the catch and have the highest bioaccumulation potential
- Use of whole fish or whole body of shellfish (excluding shell of bivalves), which may provide a better estimate of contaminant exposures in ethnic or Native American subsistence populations that consume whole fish or shellfish
- Use of the largest (oldest) individuals in the target species to represent the highest likely exposure levels
- Use of a 10^{-6} or 10^{-7} risk level, body weights less than 70 kg for women and children, site-specific consumption rates for sport fishers or for subsistence fishers or other consumption rates based on dietary studies of local fish-consuming populations, and a 70-yr exposure period to calculate SVs for carcinogens. **Note:** EPA has reviewed national data on the consumption rate for sport and subsistence fishers and the recommended default values for these populations are 17.5 and 142.4 g/d, respectively (USDA/ARS, 1998; U.S. EPA, 2000c).
- Use of body weights less than 70 kg for women and children and site-specific consumption rates for sport fishers or for subsistence fishers or other consumption rates based on dietary studies of local fish-consuming populations to calculate SVs for noncarcinogens. **Note:** EPA has reviewed national data on the consumption rate for sport and subsistence fishers and the recommended default values for these populations are 17.5 and 142.4 g/d, respectively (USDA/ARS, 1998; U.S. EPA, 2000c).

There are additional aspects of the screening study design that states should review because they affect the statistical analysis and interpretation of the data. These include

- Use of composite samples, which results in loss of information on the distribution of contaminant concentrations in the individual sampled fish and shellfish. Maximum contaminant concentrations in individual sampled fish, which can be used as an indicator of potentially harmful levels of contamination (U.S. EPA, 1989d), are not available when composite sampling is used.
- Use of a single sample per screening site for each target species, which precludes estimating the variability of the contamination level at that site and, consequently, of conducting valid statistical comparisons to the target analyte SVs.
- Uncertainty factors affecting the numerical calculation of quantitative health risk information (i.e., reference doses and cancer slope factors) as well as human health SVs.

The use of composite samples is often the most cost-effective method for estimating average tissue concentrations of analytes in target species populations to assess chronic human health risks. However, there are some situations in which individual sampling can be more appropriate from both ecological and risk assessment perspectives. Individual sampling provides a direct measure of the range and variability of contaminant levels in target fish populations. Information on maximum contaminant concentrations in individual fish is useful in evaluating acute human health risks. Estimates of the variability of contaminant levels among individual fish can be used to ensure that studies meet desired statistical objectives. For example, the population variance of a contaminant can be used to estimate the sample size needed to detect statistically significant differences in contaminant screening values compared to the mean contaminant concentration. Finally, the analysis of individual samples may be desirable, or necessary, when the objective is to minimize the impacts of sampling on certain vulnerable target populations, such as predators in headwater streams and aquatic turtles, and in cases where the cost of collecting enough individuals for a composite sample is excessive. For states that wish to consider use of individual sampling during either the screening or intensive studies, additional information on collecting and analyzing individual samples is provided in Appendix C. States should consider the potential effects of these study design features when evaluating screening study results.

Note: As part of screening studies, states may wish to issue information not only on restricting or avoiding consumption of certain species from certain waterbodies, but on promoting unrestricted fish consumption in those waterbodies where the levels of contamination are below the SVs for all 25 of the target analytes. Waterbodies in which target analyte concentrations (see Section 5) are below the selected target analyte SVs are known as “green areas” where states can promote fish consumption to specified fisher populations. Guidance to assist states in designating these safe or green areas is provided in detail in Appendix B.

2.2 INTENSIVE STUDIES (TIER 2)

The primary aims of intensive studies are to assess the magnitude of tissue contamination at screening sites, to determine the size class or classes of fish within a target species whose contaminant concentrations exceed the SVs, and to assess the geographic extent of the contamination for the target species in the waterbody under investigation. With respect to the design of intensive studies, EPA recommends a sampling strategy that may not be feasible for some site-specific environments. Specifically, EPA recognizes that some waterbodies cannot sustain the same intensity of sampling (i.e., number of replicate composite samples per site and number of individuals per composite sample) that others (i.e., those used for commercial harvesting) can sustain. In such cases, state fisheries personnel may consider modifying the sampling strategy (e.g., analyzing individual fish) for intensive studies to protect the fishery resource. Although one strategy cannot cover all situations, these sampling guidelines are reasonable for the majority of environmental conditions, are scientifically defensible, and provide

information that can be used to assess the risk to public health. Regardless of the final study design and protocol chosen for a fish contaminant monitoring program, state fisheries, environmental, and health personnel should always evaluate and document the procedures used to ensure that results obtained meet state objectives for protecting human health.

The allocation of limited funds to screening studies or to intensive studies should always be guided by the goal of conducting adequate sampling of state fish and shellfish resources to ensure the protection of public health. The amount of sampling that can be performed by a state will be determined by available economic resources. Ideally, state agencies will allocate funds for screening as many sites as is deemed necessary while reserving adequate resources to conduct subsequent intensive studies at sites where excessive fish tissue contamination is detected. State environmental and health personnel should use all information collected in both screening and intensive studies to (1) conduct a risk assessment to determine whether the issuance of an advisory is warranted, (2) use risk management to determine the nature and extent of the advisory, and then (3) effectively communicate this risk to the fish-consuming public. Additional information on risk assessment, risk management, and risk communication procedures will be provided in subsequent volumes in this series.

SECTION 3

TARGET SPECIES

The primary objectives of this section are to: (1) discuss the purpose of using target species, (2) describe the criteria used by the 1993 EPA Fish Contaminant Workgroup to select target species, and (3) provide lists of recommended target species. Target species recommended for freshwater and estuarine/marine ecosystems are discussed in Sections 3.3 and 3.4, respectively.

3.1 PURPOSE OF USING TARGET SPECIES

The use of target species allows comparison of fish, shellfish, and turtle tissue contaminant monitoring data among sites over a wide geographic area. Differences in habitat, food preferences, and rate of contaminant uptake among various fish, shellfish, and turtle species make comparison of contaminant monitoring results within a state or among states difficult unless the contaminant data are from the same species. It is virtually impossible to sample the same species at every site, within a state or region or nationally, due to the varying geographic distributions and environmental requirements of each species. However, a limited number of species can be identified that are distributed widely enough to allow for collection and comparison of contaminant data from many sites.

Three aims are achieved by using target species in screening studies. First, states can cost-effectively compare contaminant concentrations in their state waters and then prioritize sites where tissue contaminants exceed human health screening values. In this way, limited monitoring resources can be used to conduct intensive studies at sites exhibiting the highest degree of tissue contamination in screening studies. By resampling target species used in the screening study in Phase I intensive studies and sampling additional size classes and additional target species in Phase II intensive studies as resources allow, states can assess the magnitude and geographic extent of contamination in species of commercial, recreational, or subsistence value. Second, the use of common target species among states allows for more reliable comparison of sampling information. Such information allows states to design and evaluate their own contaminant monitoring programs more efficiently, which should further minimize overall monitoring costs. For example, monitoring by one state of fish tissue contamination levels in the upper reaches of a particular river can provide useful information to an adjacent state on tissue contamination levels that might be anticipated in the same target species at sampling sites downstream. Third, the use of a select group of target fish, shellfish, and freshwater turtle species will allow for the development of a national database for tracking the magnitude and

geographic extent of pollutant contamination in these target species nationwide and will permit analyses of trends in fish, shellfish, and turtle contamination over time.

3.2 CRITERIA FOR SELECTING TARGET SPECIES

The appropriate choice of target species is a key element of any chemical contaminant monitoring program. Criteria for selecting target species used in the following national fish and shellfish contaminant monitoring programs were reviewed by the 1993 EPA Fish Contaminant Workgroup to assess their applicability for use in selecting target species for state fish contaminant monitoring programs:

- National Study of Chemical Residues in Fish (U.S. EPA)
- National Dioxin Study (U.S. EPA)
- 301(h) Monitoring Program (U.S. EPA)
- National Pesticide Monitoring Program (U.S. FWS)
- National Contaminant Biomonitoring Program (U.S. FWS)
- National Status and Trends Program (NOAA).
- National Water Quality Assessment Program (USGS).

The criteria used to select target species in many of these programs are similar although the priority given each criterion may vary depending on program aims.

According to the 1993 EPA Fish Contaminant Workgroup, the most important criterion for selecting target fish, shellfish, and turtle species for state contaminant monitoring programs assessing human consumption concerns was that the species were commonly consumed in the study area and were of commercial, recreational, or subsistence fishing value. Two other criteria of major importance are that the species have the potential to bioaccumulate high concentrations of chemical contaminants and have a wide geographic distribution. EPA recommends that states use the same criteria to select species for both screening and intensive site-specific studies.

In addition to the three primary criteria for target species selection, it is also important that the target species be easy to identify taxonomically because there are significant species-specific differences in bioaccumulation potential. Because many closely related species can be similar in appearance, reliable taxonomic identification is essential to prevent mixing of closely related species with the target species. **Note:** Under no circumstance should individuals of more than one species be mixed to create a composite sample (U.S. EPA, 1991e). It is also both practical and cost-effective to sample target species that are abundant, easy to capture, and large enough to provide adequate tissue samples for chemical analyses.

It cannot be overemphasized that final selection of target species will require the expertise of state fisheries biologists with knowledge of local species that best meet the selection criteria and knowledge of local human consumption patterns. Although, ideally, all fish, shellfish, or turtle species consumed from a given waterbody by the local population should be monitored, resource constraints may dictate that only a few of the most frequently consumed species be sampled.

In the next two sections, lists of recommended target species are provided for freshwater ecosystems (inland fresh waters and the Great Lakes) and estuarine/marine ecosystems (Atlantic, Gulf, and Pacific waters), and the methods used to develop each list are discussed.

3.3 FRESHWATER TARGET SPECIES

As part of the two-tiered sampling strategy proposed for state fish contaminant monitoring programs, EPA recommends that states collect one bottom-feeding fish species and one predator fish species at each freshwater screening study site. Some suggested target species for use in state fish contaminant monitoring programs are shown in Table 3-1 for inland fresh waters and in Table 3-2 for Great Lakes waters.

The lists of target species recommended by the 1993 EPA Fish Contaminant Workgroup for freshwater ecosystems were developed based on a review of species used in the following national monitoring programs:

- National Study of Chemical Residues in Fish (U.S. EPA)
- National Dioxin Study (U.S. EPA)
- National Pesticide Monitoring Program (U.S. FWS)
- National Contaminant Biomonitoring Program (U.S. FWS)
- National Water Quality Assessment Program (USGS)

and on a review of fish species cited in state fish consumption advisories or bans (RTI, 1993). Separate target species lists were developed for inland fresh waters (Table 3-1) and Great Lakes waters (Table 3-2) because of the distinct ecological characteristics of these waters and their fisheries. Each target species list has been reviewed by regional and state fisheries experts.

Use of two distinct ecological groups of finfish (i.e., bottom-feeders and predators) as target species in freshwater systems is recommended. This permits monitoring of a wide variety of habitats, feeding strategies, and physiological factors that might result in differences in bioaccumulation of contaminants. Bottom-feeding species may accumulate high contaminant concentrations from direct physical contact with contaminated sediment and/or by consuming benthic invertebrates and epibenthic organisms that live in contaminated sediment. Predator species are also good indicators of persistent pollutants (e.g., mercury or DDT and its metabolites) that may be biomagnified through several trophic levels of the food web. Species used in several federal programs to assess the

Table 3-1. Recommended Target Species for Inland Fresh Waters

Family name	Common name	Scientific name
<i>Percichthyidae</i>	White bass	<i>Morone chrysops</i>
<i>Centrarchidae</i>	Largemouth bass	<i>Micropterus salmoides</i>
	Smallmouth bass	<i>Micropterus dolomieu</i>
	Black crappie	<i>Pomoxis nigromaculatus</i>
	White crappie	<i>Pomoxis annularis</i>
<i>Percidae</i>	Walleye	<i>Stizostedion vitreum</i>
	Yellow perch	<i>Perca flavescens</i>
<i>Cyprinidae</i>	Common carp	<i>Cyprinus carpio</i>
<i>Catostomidae</i>	White sucker	<i>Catostomus commersoni</i>
<i>Ictaluridae</i>	Channel catfish	<i>Ictalurus punctatus</i>
	Flathead catfish	<i>Pylodictis olivaris</i>
<i>Esocidae</i>	Northern pike	<i>Esox lucius</i>
<i>Salmonidae</i>	Lake trout	<i>Salvelinus namaycush</i>
	Brown trout	<i>Salmo trutta</i>
	Rainbow trout	<i>Oncorhynchus mykiss^a</i>

^aFormerly *Salmo gairdneri*.

Table 3-2. Recommended Target Species for Great Lakes Waters

Family name	Common name	Scientific name
<i>Percichthyidae</i>	White bass	<i>Morone chrysops</i>
<i>Centrarchidae</i>	Smallmouth bass	<i>Micropterus dolomieu</i>
<i>Percidae</i>	Walleye	<i>Stizostedion vitreum</i>
<i>Cyprinidae</i>	Common carp	<i>Cyprinus carpio</i>
<i>Catostomidae</i>	White sucker	<i>Catostomus commersoni</i>
<i>Ictaluridae</i>	Channel catfish	<i>Ictalurus punctatus</i>
<i>Esocidae</i>	Muskellunge	<i>Esox masquinongy</i>
<i>Salmonidae</i>	Chinook salmon	<i>Oncorhynchus tshawytscha</i>
	Lake trout	<i>Salvelinus namaycush</i>
	Brown trout	<i>Salmo trutta</i>
	Rainbow trout	<i>Oncorhynchus mykiss^a</i>

^aFormerly *Salmo gairdneri*.

extent of freshwater fish tissue contamination nationwide are compared in Table 3-3.

In addition to finfish species, states should consider monitoring the tissues of freshwater turtles for environmental contaminants in areas where turtles are consumed by recreational, subsistence, or ethnic populations. Interest has been increasing in the potential transfer of environmental contaminants from the aquatic food chain to humans via consumption of freshwater turtles. Turtles may bioaccumulate environmental contaminants in their tissues from exposure to contaminated sediments or via consumption of contaminated prey. Because some turtle species are long-lived and occupy a medium to high trophic level of the food chain, they have the potential to accumulate high concentrations of chemical contaminants from their diets (Hebert et al., 1993). Some suggested target turtle species for use in state contaminant monitoring programs are listed in Table 3-4.

The list of target turtle species recommended for freshwater ecosystems was developed based on a review of turtle species cited in state consumption advisories or bans (RTI, 1993) and a review of the recent scientific literature. The recommended target species list has been reviewed by regional and state experts.

3.3.1 Target Finfish Species

3.3.1.1 Bottom-Feeding Species

EPA recommends that, whenever practical, states use common carp (*Cyprinus carpio*), channel catfish (*Ictalurus punctatus*), and white sucker (*Catostomus commersoni*) in that order as bottom-feeding target species in both inland fresh waters (Table 3-1) and in Great Lakes waters (Table 3-2). These bottom-feeders have been used consistently for monitoring a wide variety of contaminants including dioxins/furans (Crawford and Luoma, 1993; U.S. EPA, 1992c, 1992d; Versar Inc., 1984), organochlorine pesticides (Crawford and Luoma, 1993; Schmitt et al., 1983, 1985, 1990; U.S. EPA, 1992c, 1992d), and heavy metals (Crawford and Luoma, 1993; Lowe et al., 1985; May and McKinney, 1981; Schmitt and Brumbaugh, 1990; U.S. EPA, 1992c, 1992d). These three species are commonly consumed in the areas in which they occur and have also demonstrated an ability to accumulate high concentrations of environmental contaminants in their tissues as shown in Tables 3-5 and 3-6. **Note:** The average contaminant concentrations shown in Tables 3-5 and 3-6 for fish collected for the EPA National Study of Chemical Residues in Fish (U.S. EPA, 1992c, 1992d) were derived from concentrations in fish from undisturbed areas and from areas expected to have elevated tissue contaminant concentrations. The mean contaminant concentrations shown, therefore, may be higher or lower than those found in the ambient environment because of site selection criteria used in this study.

Table 3-3. Comparison of Freshwater Finfish Species Used in Several National Fish Contaminant Monitoring Programs

	U.S. EPA National Dioxin Study	U.S. FWS NPMP and NCBP	U.S. EPA NSCRF	USGS NWQAP
BOTTOM FEEDERS				
Family <i>Cyprinidae</i> Carp (<i>Cyprinus carpio</i>)	●	●	●	●
Family <i>Ictaluridae</i> Channel catfish (<i>Ictalurus punctatus</i>)	●	● Or other ictalurid	●	●
Family <i>Catostomidae</i> White sucker (<i>Catostomus commersoni</i>)	●	● Or other catostomid	●	●
Longnose sucker (<i>C. catostromus</i>)				●
Largescale sucker (<i>C. macrocheilus</i>)				
Spotted sucker (<i>Minytrema melanops</i>)			●	
Redhorse sucker (<i>Moxostoma sp.</i>) included variety of species: Silver redhorse (<i>M. anisurum</i>) Grey redhorse (<i>M. congetum</i>) Black redhorse (<i>M. duquesnei</i>) Golden redhorse (<i>M. erythrurum</i>) Shorthead redhorse (<i>M. macrolepidotum</i>) Blacktail redhorse (<i>M. poecilurum</i>)			●	
PREDATORS				
Family <i>Salmoridae</i> Rainbow trout (<i>Oncortynchus mykiss</i>) [formerly <i>Salmo gairdneni</i>]	●	●		
Brown trout (<i>Salmo trutta</i>)	●	●	●	●
Brook trout (<i>Salvelinus fontinalis</i>)	●	●		●
Lake trout (<i>Salmo namaycush</i>)	●	●		
Family <i>Percidae</i> Walleye (<i>Stizostedion vitreum</i>)	● Or other percid	● Or other percid	●	
Sauger (<i>Stizostedion canadense</i>)	○	○		
Yellow perch (<i>Perca flavescans</i>)	○	○		
Family <i>Percichthyidae</i> White bass (<i>Morone chrysops</i>)			●	
Family <i>Centrarchidae</i> Largemouth bass (<i>Micropterus salmoides</i>)	● Or other centrarchid	● Or other centrarchid	●	●
Smallmouth bass (<i>Micropterus dolomieu</i>)			●	
Black crappie (<i>Pomoxis nigromaculatus</i>)	○	○		
White crappie (<i>Pomoxis annularis</i>)	○	○	●	
Bluegill sunfish (<i>Lepomis macrochirus</i>)	○	○		●
Family <i>Esocidae</i> Northern pike (<i>Esox lucius</i>)			●	
Family <i>Ictaluridae</i> Flathead catfish (<i>Pylodictis olivaris</i>)			●	

- Recommended target species
- Alternate target species

NPMP = National Pesticide Monitoring Program
 NCBP = National Contaminant Biomonitoring Program
 NSCRF = National Study of Chemical Residues in Fish
 NWQAP = National Water Quality Assessment Program

Sources: Versar, Inc., 1984; Schmitt et al., 1990; Schmitt et al., 1983; May and McKinney, 1981; U.S. EPA, 1992c, 1992d; Crawford and Luoma, 1993.

Table 3-4. Freshwater Turtles Recommended for Use as Target Species

Family name	Common name	Scientific name
<i>Chelydridae</i>	Snapping turtle	<i>Chelydra serpentina</i>
<i>Emydidae</i>	Yellow-bellied turtle	<i>Trachemys scripta scripta</i>
	Red-eared turtle	<i>Trachemys scripta elegans</i>
	River cooter	<i>Pseudemys concinna concinna</i>
	Suwanee cooter	<i>Pseudemys concinna suwanniensis</i>
	Slider	<i>Pseudemys concinna hieroglyphica</i>
	Texas slider	<i>Pseudemys concinna texana</i>
	Florida cooter	<i>Pseudemys floridana floridana</i>
	Peninsula cooter	<i>Pseudemys floridana penisularis</i>
<i>Trionychidae</i>	Smooth softshell	<i>Apalone muticus</i>
	Eastern spiny softshell	<i>Apalone spinifera spinifera</i>
	Western spiny softshell	<i>Apalone spinifera hartwegi</i>
	Gulf Coast spiny softshell	<i>Apalone spinifera aspera</i>
	Florida softshell	<i>Apalone ferox</i>

In addition, these three species are relatively widely distributed throughout the continental United States, and numerous states are already sampling these species in their contaminant monitoring programs. A review of the database *National Listing of State Fish and Shellfish Consumption Advisories and Bans* (RTI, 1993) indicated that the largest number of states issuing advisories for specific bottom-feeding species did so for carp (21 states) and channel catfish (22 states), with eight states issuing advisories for white suckers (see Table 3-7). Appendix D lists the freshwater fish species cited in consumption advisories for each state as of 1998.

3.3.1.2 Predator Species

EPA recommends that, whenever practical, states use predator target species listed in Tables 3-1 and 3-2 for inland fresh waters and Great Lakes waters, respectively. Predator species, because of their more definitive habitat and water temperature preferences, generally have a more limited geographic distribution. Thus, a greater number of predator species than bottom feeders have been used in national contaminant monitoring programs (Table 3-3) and these are recommended for use as target species in freshwater ecosystems. Predator fish that prefer relatively cold freshwater habitats include many members of the following families: *Salmonidae* (trout and salmon), *Percidae* (walleye and yellow perch), and *Esocidae* (northern pike and muskellunge). Members of the *Centrarchidae* (large- and smallmouth bass, crappie, and sunfish), *Percichthyidae* (white bass), and *Ictaluridae* (flathead catfish) families prefer relatively warm water habitats. Only two predator species (brown trout and largemouth bass) were used in all four of the national monitoring programs reviewed by the 1993 EPA Fish Contaminant Workgroup (Table 3-3). However, most of the other predator species recommended as target species have been used in at least one national monitoring program. To identify those predator species with a known ability to bioaccumulate contaminants in their tissues, the 1993 EPA Workgroup reviewed average tissue concentrations of xenobiotic contaminants for major

Table 3-5. Average Fish Tissue Concentrations (ppb) of Xenobiotics for Major Finfish Species Sampled in the National Study of Chemical Residues in Fish^a

Fish Species	Alpha-BHC	Gamma-BHC	Biphenyl	Chlorpyrifos	Dicofol	Dieldrin	Endrin	Heptachlor epoxide	Mercury	Mirex	Oxychlor-dane	PCBs
Bottom Feeders^b												
Carp	3.10	4.34	4.38	8.23	0.88	44.75	1.40	4.00	0.11	3.70	8.20	2941.13
White sucker	3.31	1.66	1.28	1.75	0.48	22.75	0.24	1.09	0.11	4.35	3.10	1697.81
Channel cat	2.87	3.17	1.24	6.97	0.59	15.44	9.07	0.50	0.09	14.59	6.41	1300.52
Redhorse sucker	0.82	0.41	1.25	0.35	ND	5.35	0.97	ND	0.27	0.57	2.37	487.72
Spotted sucker	1.45	2.63	3.35	0.56	0.05	5.52	ND	ND	0.12	1.79	0.05	133.90
Predators^b												
Largemouth bass	0.15	0.07	0.38	0.23	0.20	5.01	ND	0.30	0.46	0.21	0.47	232.26
Smallmouth bass	0.36	0.15	0.33	0.08	ND	2.34	ND	0.07	0.34	1.99	0.54	496.22
Walleye	ND	ND	0.40	0.04	ND	3.73	ND	0.21	0.51	0.08	1.11	368.65
Brown trout	1.59	ND	0.81	ND	0.94	20.13	ND	2.08	0.14	43.98	5.38	2434.07
White bass	0.34	0.79	0.62	1.32	ND	9.35	ND	1.40	0.35	0.11	0.84	288.35
Northern pike	0.55	ND	0.59	11.43	0.31	9.04	ND	ND	0.34	2.39	4.00	788.40
Flathead cat	0.92	0.58	0.60	22.57	1.28	37.38	3.45	0.57	0.27	ND	0.63	521.19
White crappie	0.23	ND	0.21	ND	ND	ND	ND	ND	0.22	ND	ND	22.34
Bluefish	0.38	0.12	0.20	ND	ND	2.87	ND	ND	0.22	0.13	ND	368.06
Fish Species												
	Penta-chloro-anisole	Penta-chloro-benzene	DDE	Total Chlordane	Total Nonachlor	123 TCB	124 TCB	135 TCB	1234 TECB	Trifluralin	Hexa-chloro-benzene	
Bottom Feeders^b												
Carp	16.50	1.04	415.43	67.15	63.15	1.54	4.77	0.08	0.30	12.55	3.58	
White sucker	9.06	0.39	78.39	18.43	20.83	0.16	0.30	0.14	0.15	ND	3.62	
Channel cat	39.60	1.32	627.77	54.39	66.28	0.14	0.37	ND	0.88	1.00	2.36	
Redhorse sucker	2.87	0.02	87.25	16.48	30.73	0.55	6.48	0.08	0.09	ND	0.58	
Spotted sucker	17.68	0.02	75.31	12.33	15.00	3.34	12.00	1.00	0.09	ND	0.02	
Predators^b												
Largemouth bass	0.57	0.02	55.72	2.89	4.21	0.22	0.19	0.03	0.01	ND	0.20	
Smallmouth bass	0.23	0.02	33.63	4.01	7.82	0.70	0.59	0.04	0.04	ND	0.36	
Walleye	0.76	ND	34.00	3.62	8.04	0.29	0.38	ND	0.004	ND	0.11	
Brown trout	0.09	0.60	158.90	7.25	32.60	1.10	0.98	ND	0.09	ND	3.06	
White bass	0.93	ND	17.44	10.67	16.00	0.21	0.10	ND	0.01	ND	0.83	
Northern pike	1.51	0.09	59.50	5.45	13.88	0.30	0.23	ND	0.01	ND	0.20	
Flathead catfish	0.31	ND	755.18	16.07	14.04	0.10	0.18	ND	ND	44.37	0.85	
White crappie	0.33	ND	10.04	0.34	0.28	0.08	0.08	0.08	ND	ND	ND	
Bluefish	0.05	ND	29.13	2.74	2.56	6.25	4.66	4.66	ND	ND	ND	

^a These average fish tissue concentrations may be higher or lower than those found in the ambient environment because of site selection criteria used in this study.

^b Values were calculated using whole-body samples for bottom feeders and fillet samples for predators. Individual values below detection limit were set at zero. Asterisk indicates all values below the detection limit. Units = ppb, (µg/g) wet weight basis. ND = Not detected.

Source: US. EPA, 1991h.

Table 3-6. Average Fish Tissue Concentrations (ppt) of Dioxins and Furans for Major Finfish Species Sampled in the National Study of Chemical Residues in Fish^a

Fish Species	2378 TCDD	12378 PeCDD	123478 HxCDD	123678 HxCDD	123789 HxCDD	1234678 HxCDD	2378 TCDF	12378 PeCDF	23478 PeCDF	123478 HxCDF	123678 HxCDF	123789 HxCDF	234678 HxCDF	1234678 HxCDF	1234789 HxCDF	TEQ
Bottom Feeders^b																
Carp	7.76	3.63	2.16	6.81	1.54	22.29	10.15	1.31	4.01	2.54	1.91	1.16	1.20	2.49	1.22	13.06
White sucker	8.08	2.05	1.03	1.96	0.88	3.72	22.89	1.10	2.64	2.21	1.29	1.06	1.09	1.23	1.13	12.79
Channel catfish	11.56	2.37	1.61	5.62	1.29	9.40	2.22	0.52	2.91	2.41	1.41	1.38*	1.62	2.55	1.26	14.80
Redhorse sucker	4.65	1.50	1.40	2.36	0.84	4.94	30.09	0.75	1.28	2.10	1.16	1.19*	1.50	1.57	1.36*	9.22
Spotted sucker	1.73	2.34	1.70	12.08	1.14	17.48	7.49	2.12	2.06	2.22	1.79	1.28*	1.78	1.77	1.08	6.23
Predators^b																
Largemouth bass	1.73	0.59	1.12	1.28	0.64	2.48	2.18	0.37	0.47	1.24	1.23	1.21*	0.88	0.82	1.21*	1.91
Smallmouth bass	0.72	0.50*	1.13*	0.79	0.64*	0.67	1.93	0.36*	0.51	1.28	1.23	1.26*	0.89*	0.69	1.30*	0.65*
Walleye	0.88	0.54*	0.99*	0.73	0.62*	0.88	1.83	0.35*	0.38	1.04	1.09*	1.07*	0.75	0.74	1.21*	0.79*
Brown trout	2.52	1.01	1.07*	0.98	0.68*	1.18	3.74	0.60	1.36	1.47	1.12*	1.09*	0.94*	0.67*	1.16*	3.31
White bass	3.00	0.66	1.05*	0.78	0.61*	1.01	5.07	0.40	0.49	1.04	1.16*	1.13*	0.81*	0.63	1.17*	3.44
Northern pike	0.77	0.46*	1.23*	0.91	0.69*	0.73	1.01	0.44	0.66	1.41*	1.42*	1.38*	0.98*	0.56	1.30*	0.66
Fathead cat	0.78	0.43	0.90	1.06	0.50	1.67	1.63	0.40	0.56	1.05	1.20*	1.17*	0.61*	0.56	1.10*	0.99
White crappie	2.13	0.60	1.29*	1.03*	0.83*	1.33	10.46	0.54	0.67	1.33*	1.33*	1.30*	0.95*	0.96*	1.34*	3.80
Bluefish	0.85	0.56	1.23*	0.98*	0.69*	0.65	2.11	0.41	0.59	1.42*	1.42*	1.39*	0.98*	0.72*	1.31*	1.41

^a These average fish tissue concentrations may be higher or lower than those found in the ambient environment because of site selection criteria used in this study.
^b Values were calculated using whole-body samples for bottom feeders and fillet samples for predators. Values below detection limit have been replaced by one-half detection limit for the given sample. Asterisk indicates all values below detection limit. Units = ppt (pg/g) wet weight basis.
 TEQ = Toxicity equivalency was based on TEF-89 toxicity weighting values; however, octachlorodibenzo-*p*-dioxin and octachlorodibenzofurans were not analyzed; therefore, the TEQ value does not include these two compounds.

Source: U.S. EPA, 1991h.

predator fish species sampled in the National Study of Chemical Residues in Fish. Unlike the bottom feeders (common carp, channel catfish, and white suckers), no single predator species or group of predator species consistently exhibited the highest tissue concentrations for the contaminants analyzed (Tables 3-5 and 3-6). However, average fish tissue concentrations for some contaminants (i.e., mercury, mirex, chlorpyrifos, DDE, 1,2,3-trichlorobenzene [123-TCB], and trifluralin) were higher for some predator species than for the bottom feeders despite the fact that only the fillet portion rather than the whole body was analyzed for predator species. This finding emphasizes the need for using two types of fish (i.e., bottom feeders and predators) with different habitat and feeding strategies as target species.

The existence of fish consumption advisories for these predator target species was further justification for their recommended use. As was shown for the bottom-feeder target species, states were already sampling the recommended predator target species listed in Table 3-7. The largest number of states issuing advisories in 1993 for specific predator species did so for largemouth bass (15), lake trout (10), white bass (10), smallmouth bass (9), brown trout (9), walleye (9), rainbow trout (8), yellow perch (8), chinook salmon (7), northern pike (7), black crappie (5), flathead catfish (4), and muskellunge (4) (RTI, 1993). For comparison, the number of states reporting advisories for each species in 1998 is also presented in Table 3-7.

Because some freshwater finfish species (e.g., several Great Lake salmonids) are highly migratory, harvesting of these species may be restricted to certain seasons because sexually mature adult fish (i.e., the recommended size for sampling) may make spawning runs from the Great Lakes into tributary streams. EPA recommends that spawning populations not be sampled in fish contaminant monitoring programs. Sampling of target finfish species during their spawning period should be avoided because contaminant tissue concentrations may decrease during this time (Phillips, 1980) and because the spawning period is generally outside the legal harvest period. **Note:** Target finfish may be sampled during their spawning period, however, if the species can be legally harvested at this time.

State personnel, with their knowledge of site-specific fisheries and human consumption patterns, must be the ultimate judge of the species selected for use in freshwater fish contaminant monitoring programs within their jurisdiction.

3.3.2 Target Turtle Species

EPA recommends that states in which freshwater turtles are consumed by recreational, subsistence, or ethnic populations consider monitoring turtles to assess the level of environmental contamination and whether they pose a human health risk. In all cases, the primary criterion for selecting the target turtle species is whether it is commonly consumed. To identify those turtle species with a known ability to bioaccumulate contaminants in their tissues, the 1993 EPA Workgroup reviewed turtle species cited in state consumption advisories and those species identified

Table 3-7. Principal Freshwater Fish Species Cited in State Fish Consumption Advisories^a

Family name	Common name	Scientific name	Number of states with advisories ^b	
			1993	1998
<i>Percichthyidae</i>	White bass	<i>Morone chrysops</i>	10	17
	Striped bass	<i>Morone saxatilis</i>	6	12
	White perch	<i>Morone americana</i>	4	7
<i>Centrarchidae</i>	Largemouth bass	<i>Micropterus salmoides</i>	15	33
	Smallmouth bass	<i>Micropterus dolomieu</i>	9	18
	Black crappie	<i>Pomoxis nigromaculatus</i>	5	18
	White crappie	<i>Pomoxis annularis</i>	2	11
	Bluegill sunfish	<i>Lepomis macrochirus</i>	5	11
	Rock bass	<i>Ambloplites rupestris</i>	3	5
<i>Percidae</i>	Yellow perch	<i>Perca flavescens</i>	8	12
	Sauger	<i>Stizostedion canadense</i>	4	9
	Walleye	<i>Stizostedion vitreum</i>	9	12
<i>Cyprinidae</i>	Common carp	<i>Cyprinus carpio</i>	21	25
<i>Acipenseridae</i>	Shovelnose sturgeon	<i>Scaphirhynchus platyrhynchus</i>	1	3
	Lake sturgeon	<i>Acipenser fulvescens</i>	2	3
<i>Catostomidae</i>	Smallmouth buffalo	<i>Ictiobus bubalus</i>	4	5
	Bigmouth buffalo	<i>Ictiobus cyprinellus</i>	4	6
	Shorthead redhorse	<i>Moxostoma macrolepidotum</i>	2	3
	White sucker	<i>Catostomus commersoni</i>	8	11
	Quillback carpsucker	<i>Carpodes cyprinus</i>	2	5
<i>Ictaluridae</i>	White catfish	<i>Ictalurus catus</i>	5	6
	Channel catfish	<i>Ictalurus punctatus</i>	22	26
	Flathead catfish	<i>Pylodictis olivaris</i>	4	11
	Black bullhead	<i>Ictalurus melas</i>	2	3
	Brown bullhead	<i>Ictalurus nebulosus</i>	7	10
	Yellow bullhead	<i>Ictalurus natalis</i>	2	8
<i>Sciaenidae</i>	Freshwater drum	<i>Aplodinotus grunniens</i>	3	13
<i>Esocidae</i>	Northern pike	<i>Esox lucius</i>	7	10
	Muskellunge	<i>Esox masquinongy</i>	4	4
<i>Salmonidae</i>	Coho salmon	<i>Oncorhynchus kisutch</i>	6	8
	Chinook salmon	<i>Oncorhynchus tshawytscha</i>	7	7
	Brown trout	<i>Salmo trutta</i>	9	11
	Lake trout	<i>Salvelinus namaycush</i>	10	12
	Rainbow trout	<i>Oncorhynchus mykiss</i> ^c	8	12
	Brook trout	<i>Salvelinus fontinalis</i>	3	4
	Lake whitefish	<i>Coregonus clupea formis</i>	2	7
<i>Anguillidae</i>	American eel	<i>Anguilla rostrata</i>	6	7

^a Species in boldface are EPA-recommended target species for inland fresh waters (see Table 3-1) and the Great Lakes waters (Table 3-2).

^b Many states did not identify individual species of finfish in their advisories.

^c Formerly *Salmo gairdneri*.

Sources: RTI, 1993; U.S. EPA, 1999c (NLFWA).

in the scientific literature as having accumulated high concentrations of environmental contaminants.

Based on information in state advisories and a number of environmental studies using turtles as biological indicators of pollution, one species stands out as an obvious choice for a target species, the common snapping turtle (*Chelydra serpentina*). This turtle has been recommended by several researchers as an important bioindicator species (Bishop et al., 1996; Bonin et al., 1995; Olafsson et al., 1983; Stone et al., 1980) and has the widest geographic distribution of any of the North American aquatic turtles (see Figure 3-1). In addition, this species is highly edible, easily identified, easily collected, long-lived (>20 years), grows to a large size, and has been extensively studied with respect to a variety of environmental contaminants. Other turtle species that should be considered for use as target species are listed in Table 3-4.

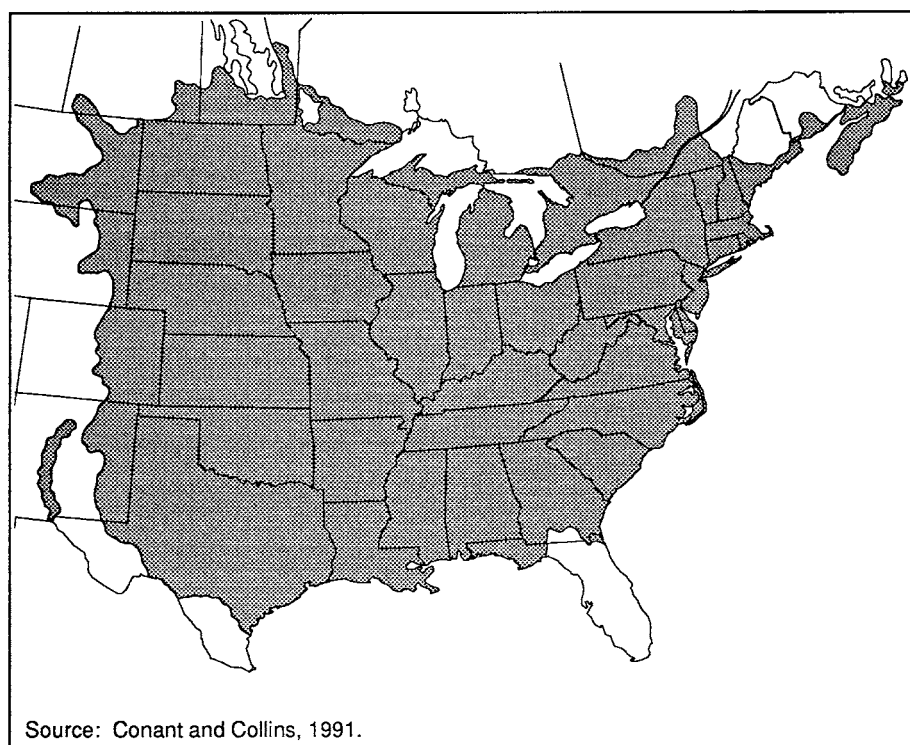

Figure 3-1. Geographic range of the common snapping turtle (*Chelydra serpentina*).

Four states (Arizona, Massachusetts, Minnesota, and New York) currently have consumption advisories in force for various turtle species (U.S. EPA, 1999c; New York State Department of Health, 1994). The species cited in the state advisories and the pollutants identified in turtle tissues as exceeding acceptable levels of contamination with respect to human health are listed in Table 3-8. New York

Table 3-8. Principal Freshwater Turtle Species Cited in State Consumption Advisories

Family name	Common name	Scientific name	Pollutant	State
<i>Chelydridae</i>	Snapping turtle ^a	<i>Chelydra serpentina</i>	Mercury	MN
	Snapping turtle ^a (and other unspecified turtle species)	<i>Chelydra serpentina</i>	PCBs	MA
	Snapping turtle ^b	<i>Chelydra serpentina</i>	PCBs	NY
<i>Trionychidae</i>	Western spiny softshell ^a	<i>Apalone spiniferus</i>	DDT toxaphene, chlordane, dieldrin	AZ

PCB = Polychlorinated biphenyls. DDT = 1,1,1-trichloro-2,2 bis(p-chlorophenyl)ethane.

^aSource: U.S. EPA 1999c (NLFWA).

^bSource: New York State Department of Health, 1994.

state has a statewide advisory directed specifically at women of childbearing age and children under 15 and advises these groups to avoid eating snapping turtles altogether. The advisory also recommends that members of the general population who wish to consume turtle meat should trim away all fat and discard the liver tissue and eggs of the turtles prior to cooking the meat or preparing other dishes. These three tissues (fat, liver, and eggs) have been shown to accumulate extremely high concentrations of a variety of environmental contaminants in comparison to muscle tissue (Bishop et al., 1996; Bonin et al., 1995; Bryan et al., 1987; Hebert et al., 1993; Olafsson et al 1983; 1987; Ryan et al., 1986; Stone et al., 1980). The Minnesota advisory also recommends that consumers remove all fat from turtle meat prior to cooking as a risk-reducing strategy (Minnesota Department of Health, 1994). States should consider monitoring pollutant concentrations in all three tissues (fat, liver, and eggs) in addition to muscle tissue if resources allow. If residue analysis reveals the presence of high concentrations of any environmental contaminant of concern, the state should consider making the general recommendation to consumers to discard these three highly lipophilic tissues (fat, liver, and eggs) to reduce the risk of exposure particularly to many organic chemical contaminants.

To identify those freshwater turtle species with a known ability to bioaccumulate chemical contaminants in their tissues, several studies were reviewed that identified freshwater turtle species as useful biomonitors of PCBs (Bishop et al., 1996; Bonin et al., 1995; Bryan et al., 1987; Hebert et al., 1993; Helwig and Hora, 1983; Olafsson et al., 1983; 1987; Safe, 1985; and Stone et al., 1980), dioxins and dibenzofurans (Bishop et al., 1996; Rappe et al., 1981; Ryan et al., 1986), organochlorine pesticides (Bishop et al., 1996; Bonin et al., 1995; Hebert et al., 1993; Stone et al., 1980), heavy metals (Bonin et al., 1995; Helwig and Hora, 1983; Stone et al., 1980), and radioactive nuclides (cesium-137 and strontium-90) (Lamb et al., 1991; Scott et al., 1986). The turtle species used in these studies, the pollutants monitored, and the reference sources are summarized in Table 3-9.

Table 3-9. Studies Using Freshwater Turtles as Biomonitors of Environmental Contamination

Species	Pollutant monitored	Source
Snapping turtle (<i>Chelydra serpentina</i>)	PCBs, total DDT, mirex	Hebert et al., 1993
Snapping turtle (<i>Chelydra serpentina</i>)	PCBs	Olafsson et al., 1987 Olafsson et al., 1983
Snapping turtle (<i>Chelydra serpentina</i>)	PCBs	Safe, 1987
Snapping turtle (<i>Chelydra serpentina</i>)	PCBs	Bryan et al., 1987
Snapping turtle (<i>Chelydra serpentina</i>)	Dioxins/Furans	Ryan et al., 1986
Snapping turtle (<i>Chelydra serpentina</i>)	PCBs, mercury, cadmium	Helwig and Hora, 1983
Snapping turtle (<i>Chelydra serpentina</i>)	Furans	Rappe et al., 1981
Snapping turtle (<i>Chelydra serpentina</i>)	Organochlorine pesticides (DDE, dieldrin, hexachlorobenzene, heptachlor epoxide, mirex), PCBs, cadmium, mercury	Stone et al., 1980
Snapping turtle (<i>Chelydra serpentina</i>)	29 Organochlorine pesticides, 39 PCB congeners, mercury	Bonin et al., 1995
Snapping turtle eggs	4 Organochlorine pesticides (DDE, dieldrin, mirex, hexachloro- benzene), PCBs, dioxins/furans	Bishop et al., 1996
Yellow-bellied turtle (<i>Trachemys scripta</i>)	Cesium-137 Strontium-90	Lamb et al., 1991
Yellow-bellied turtle (<i>Trachemys scripta</i>)	Cesium-137 Strontium-90	Scott et al., 1986
PCBs = Polychlorinated biphenyls. DDT = 1,1,1-Trichloro-2,2 bis(p-chlorophenyl)ethane. DDE = 1,1-Dichloro-2,2-bis(p-chlorophenyl)-ethylene.		

State personnel, with their knowledge of site-specific fisheries and human consumption patterns, must be the ultimate judge of the turtle species selected for use in contaminant monitoring programs within their jurisdictions. Because several turtle species are becoming less common as a result of habitat loss or degradation or overharvesting, biologists need to ensure that the target species selected for the state toxics monitoring program is not of special concern within their jurisdiction or designated as a threatened or endangered species. For example, two highly edible turtle species, the Alligator snapping turtle (*Macrolemys temmincki*) and the Northern diamondback terrapin (*Malaclemys terrapin terrapin*) are protected in some states or designated as species of concern within portions of their geographic range and are also potential candidates for federal protection (Sloan and Lovich, 1995). Although protected to varying degrees by several states, George (1987) and Pritchard (1989) concluded that the Alligator snapping turtle should receive range-wide protection

from the federal government as a threatened species under the Endangered Species Act. Unfortunately, basic ecological and life history information necessary to make environmental management decisions (i.e., federal listing as endangered or threatened species) is often not available for turtles and other reptiles (Gibbons, 1988).

Several species of freshwater turtles already have been designated as endangered or threatened species in the United States including the Bog turtle (*Clemmys muhlenbergii*), Plymouth red-bellied turtle (*Pseudemys rubriventris bangsi*), Alabama red-bellied turtle (*Pseudemys alabamensis*), Flattened musk turtle (*Stemotherus depressus*), Ringed map (=sawback) turtle (*Graptemys oculifera*), and the Yellow-blotched map (=sawback) turtle (*Graptemys flavimaculata*) (U.S. EPA, 1994; U.S. Fish and Wildlife Service, 1994). In addition, all species of marine sea turtles including the Green sea turtle (*Chelonia mydas*), Hawksbill sea turtle (*Eretmochelys imbricata*), Kemp's ridley sea turtle (*Lepidochelys kempii*), Olive ridley sea turtle (*Lepidochelys olivacea*), Loggerhead sea turtle (*Caretta caretta*), and the Leatherback sea turtle (*Dermochelys coriacea*) have been designated as endangered (U.S. EPA, 1994; U.S. Fish and Wildlife Service, 1994).

3.4 ESTUARINE/MARINE TARGET SPECIES

EPA recommends that states collect **either** one shellfish species (preferably a bivalve mollusc) and one finfish species **or** two finfish species at each estuarine/marine screening site. In all cases, the primary criterion for selecting the target species is that it is commonly consumed. Ideally, one shellfish species and one finfish species should be sampled; however, if no shellfish species from the recommended target species list meets the primary criterion, EPA recommends that states use two finfish species selected from the appropriate regional estuarine/marine target species lists. If two finfish are selected as the target species, one should be a bottom-feeding species.

EPA recommends that, whenever practical, states use target species selected from fish and shellfish species identified in Tables 3-10 through 3-16 for the following specific estuarine/marine coastal areas:

- Northeast Atlantic region (Maine through Connecticut)—Table 3-10
- Mid-Atlantic region (New York through Virginia)—Table 3-11
- Southeast Atlantic region (North Carolina through Florida)—Table 3-12
- Gulf Coast region (west coast of Florida through Texas)—Table 3-13
- Pacific Northwest region (Alaska through Oregon)—Table 3-14
- Northern California waters (Klamath River through Morro Bay)—Table 3-15
- Southern California waters (Santa Monica Bay to Tijuana Estuary)—Table 3-16.

Table 3-10. Recommended Target Species for Northeast Atlantic Estuaries and Marine Waters (Maine through Connecticut)

Family name	Common name	Scientific name
Finfish Species		
<i>Anguillidae</i>	American eel	<i>Anguilla rostrata</i>
<i>Percichthyidae</i>	Striped bass	<i>Morone saxatilis</i>
<i>Pomatomidae</i>	Bluefish	<i>Pomatomus saltatrix</i>
<i>Sparidae</i>	Scup	<i>Stenotomus chrysops</i>
<i>Sciaenidae</i>	Weakfish	<i>Cynoscion regalis</i>
<i>Bothidae</i>	Summer flounder	<i>Paralichthys dentatus</i>
	Four-spotted flounder	<i>Paralichthys oblongus</i>
<i>Pleuronectidae</i>	Winter flounder	<i>Pseudopleuronectes americanus</i>
	Yellowtail flounder	<i>Limanda ferruginea</i>
	American dab	<i>Hippoglossoides platessoides</i>
Shellfish Species		
<i>Bivalves</i>	Soft-shell clam	<i>Mya arenaria</i>
		<i>Mercenaria mercenaria</i>
		<i>Arctica islandica</i>
		<i>Spisula solidissima</i>
		<i>Mytilus edulis</i>
<i>Crustaceans</i>	American lobster	<i>Homarus americanus</i>
	Eastern rock crab	<i>Cancer irroratus</i>

Table 3-11. Recommended Target Species for Mid-Atlantic Estuaries and Marine Waters (New York through Virginia)

Family name	Common name	Scientific name
Finfish Species		
<i>Anguillidae</i>	American eel	<i>Anguilla rostrata</i>
<i>Ictaluridae</i>	Channel catfish	<i>Ictalurus punctatus</i>
	White catfish	<i>Ictalurus catus</i>
<i>Percichthyidae</i>	White perch	<i>Morone americana</i>
	Striped bass	<i>Morone saxatilis</i>
<i>Pomatomidae</i>	Bluefish	<i>Pomatomus saltatrix</i>
<i>Sparidae</i>	Scup	<i>Stenotomus chrysops</i>
<i>Sciaenidae</i>	Weakfish	<i>Cynoscion regalis</i>
	Spot	<i>Leiostomus xanthurus</i>
	Atlantic croaker	<i>Micropogonias undulatus</i>
	Red drum	<i>Sciaenops ocellatus</i>
<i>Bothidae</i>	Summer flounder	<i>Paralichthys dentatus</i>
<i>Pleuronectidae</i>	Winter flounder	<i>Pseudopleuronectes americanus</i>
Shellfish Species		
<i>Bivalves</i>	Hard clam	<i>Mercenaria mercenaria</i>
	Soft-shell clam	<i>Mya arenaria</i>
	Ocean quahog	<i>Arctica islandica</i>
	Surf clam	<i>Spisula solidissima</i>
	Blue mussel	<i>Mytilus edulis</i>
	American oyster	<i>Crassostrea virginica</i>
<i>Crustaceans</i>	Blue crab	<i>Callinectes sapidus</i>
	American lobster	<i>Homarus americanus</i>
	Eastern rock crab	<i>Cancer irroratus</i>

Table 3-12. Recommended Target Species for Southeast Atlantic Estuaries and Marine Waters (North Carolina through Florida)

Family name	Common name	Scientific name
Finfish Species		
<i>Anguillidae</i>	American eel	<i>Anguilla rostrata</i>
<i>Ictaluridae</i>	Channel catfish	<i>Ictalurus punctatus</i>
	White catfish	<i>Ictalurus catus</i>
<i>Percichthyidae</i>	White perch	<i>Morone americana</i>
	Striped bass	<i>Morone saxatilis</i>
<i>Sciaenidae</i>	Spot	<i>Leiostomus xanthurus</i>
	Atlantic croaker	<i>Micropogonias undulatus</i>
	Red drum	<i>Sciaenops ocellatus</i>
<i>Bothidae</i>	Southern flounder	<i>Paralichthys lethostigma</i>
	Summer flounder	<i>Paralichthys dentatus</i>
Shellfish Species		
<i>Bivalves</i>	Hard clam	<i>Mercenaria mercenaria</i>
	American oyster	<i>Crassostrea virginica</i>
<i>Crustaceans</i>	West Indies spiny lobster	<i>Panulirus argus</i>
	Blue crab	<i>Callinectes sapidus</i>

Table 3-13. Recommended Target Species for Gulf of Mexico Estuaries and Marine Waters (West Coast of Florida through Texas)

Family name	Common name	Scientific name
Finfish Species		
<i>Ictaluridae</i>	Blue catfish	<i>Ictalurus furcatus</i>
	Channel catfish	<i>Ictalurus punctatus</i>
<i>Ariidae</i>	Hardhead catfish	<i>Arius felis</i>
<i>Sciaenidae</i>	Spotted seatrout	<i>Cynoscion nebulosus</i>
	Spot	<i>Leiostomus xanthurus</i>
	Atlantic croaker	<i>Micropogonias undulatus</i>
	Red drum	<i>Sciaenops ocellatus</i>
<i>Bothidae</i>	Gulf flounder	<i>Paralichthys albigutta</i>
	Southern flounder	<i>Paralichthys lethostigma</i>
Shellfish Species		
<i>Bivalves</i>	American oyster	<i>Crassostrea virginica</i>
	Hard clam	<i>Mercenaria mercenaria</i>
<i>Crustaceans</i>	White shrimp	<i>Penaeus setiferus</i>
	Blue crab	<i>Callinectes sapidus</i>
	Gulf stone crab	<i>Menippe adina</i>
	West Indies spiny lobster	<i>Panulirus argus</i>

Table 3-14. Recommended Target Species for Pacific Northwest Estuaries and Marine Waters (Alaska through Oregon)

Family name	Common name	Scientific name
Finfish Species		
<i>Embiotocidae</i>	Redtail Surfperch	<i>Amphistichus rhodoterus</i>
<i>Scorpaenidae</i>	Copper rockfish	<i>Sebastes caurinus</i>
	Black rockfish	<i>Sebastes melanops</i>
<i>Bothidae</i>	Speckled sanddab	<i>Citharichthys stigmaeus</i>
	Pacific sanddab	<i>Citharichthys sordidus</i>
<i>Pleuronectidae</i>	Starry flounder	<i>Platichthys stellatus</i>
	English sole	<i>Parophrys vetulus</i>
<i>Salmonidae</i>	Coho salmon	<i>Onchorhynchus kisutch</i>
	Chinook salmon	<i>Onchorhynchus tshawytscha</i>
Shellfish Species		
<i>Bivalves</i>	Blue mussel	<i>Mytilus edulis</i>
	California mussel	<i>Mytilus californianus</i>
	Pacific oyster	<i>Crassostrea gigas</i>
	Horseneck clam	<i>Tresus capax</i>
	Pacific littleneck clam	<i>Protothaca staminea</i>
	Soft-shell clam	<i>Mya arenaria</i>
	Manila clam	<i>Venerupis japonica</i>
<i>Crustaceans</i>	Dungeness crab	<i>Cancer magister</i>
	Red crab	<i>Cancer productus</i>

Table 3-15. Recommended Target Species for Northern California Estuaries and Marine Waters (Klamath River through Morro Bay)

Family name	Common name	Scientific name
Finfish Species		
<i>Triakidae</i>	Leopard shark	<i>Triakis semifasciata</i>
<i>Sciaenidae</i>	White croaker	<i>Genyonemus lineatus</i>
<i>Embiotocidae</i>	Redtailed surfperch	<i>Amphistichus rhodoterus</i>
	Striped seaperch	<i>Embiotoca lateralis</i>
<i>Scorpaenidae</i>	Black rockfish	<i>Sebastes melanops</i>
	Yellowtail rockfish	<i>Sebastes flavidus</i>
	Bocaccio	<i>Sebastes paucispinis</i>
<i>Bothidae</i>	Pacific sanddab	<i>Citharichthys sordidus</i>
	Speckled sanddab	<i>Citharichthys stigmaeus</i>
<i>Pleuronectidae</i>	Starry flounder	<i>Platichthys stellatus</i>
	English sole	<i>Parophrys vetulus</i>
<i>Salmonidae</i>	Coho salmon	<i>Onchorhynchus kisutch</i>
	Chinook salmon	<i>Onchorhynchus tshawytscha</i>
Shellfish Species		
<i>Bivalves</i>	Blue mussel	<i>Mytilus edulis</i>
	California mussel	<i>Mytilus californianus</i>
	Pacific littleneck clam	<i>Protothaca staminea</i>
	Soft-shell clam	<i>Mya arenaria</i>
<i>Crustaceans</i>	Dungeness crab	<i>Cancer magister</i>
	Red crab	<i>Cancer productus</i>
	Pacific rock crab	<i>Cancer antennarius</i>

Table 3-16. Recommended Target Species for Southern California Estuaries and Marine Waters (Santa Monica Bay to Tijuana Estuary)

Family name	Common name	Scientific name
Finfish Species		
<i>Serranidae</i>	Kelp bass	<i>Paralabrax clathratus</i>
	Barred sand bass	<i>Paralabrax nebulifer</i>
<i>Sciaenidae</i>	White croaker	<i>Genyonemus lineatus</i>
	Corbina	<i>Menticirrhus undulatus</i>
<i>Embiotocidae</i>	Black perch	<i>Embiotoca jacksoni</i>
	Walleye surf perch	<i>Hyperprosopan argenteum</i>
	Barred surfperch	<i>Amphistichus argenteus</i>
<i>Scorpaenidae</i>	California scorpionfish	<i>Scorpaena guttata</i>
	Widow rockfish	<i>Sebastes entomelas</i>
	Blue rockfish	<i>Sebastes mystinus</i>
	Bocaccio	<i>Sebastes paucispinis</i>
<i>Pleuronectidae</i>	Diamond turbot	<i>Hypsopetta guttulata</i>
	Dover sole	<i>Microstomus pacificus</i>
Shellfish Species		
<i>Bivalves</i>	Blue mussel	<i>Mytilus edulis</i>
	California mussel	<i>Mytilus californianus</i>
	Pacific littleneck clam	<i>Protothaca staminea</i>
<i>Crustaceans</i>	Pacific rock crab	<i>Cancer antennarius</i>
	Red crab	<i>Cancer productus</i>
	California rock lobster	<i>Panulirus interruptus</i>

The seven separate regional lists of target species recommended by the 1993 EPA Workgroup for estuarine/marine ecosystems were developed because of differences in species' geographic distribution and abundance and the nature of the regional fisheries and were developed based on a review of species used in the following national monitoring programs:

- National Dioxin Study (U.S. EPA)
- Section 301(h) Monitoring Program (U.S. EPA)
- National Status and Trends Program (NOAA)
- National Study of Chemical Residues in Fish (U.S. EPA).

Because some of these programs identified some fish and shellfish species that are not of commercial, sportfishing, or subsistence value, several additional literature sources identifying commercial and sportfishing species were also

reviewed (Table 3-17). Some sources included information on seasonal distribution and abundance of various life stages (i.e., adults, spawning adults, juveniles) of fish and shellfish species. This information was useful in delineating seven regional estuarine/marine areas nationwide. The 1993 EPA Workgroup also reviewed fish and shellfish species cited in state consumption advisories for estuarine/marine waters (Appendix D). Each of the final regional lists of target species has been reviewed by state, regional, and national fisheries experts.

Use of two distinct ecological groups of organisms (shellfish and finfish) as target species in estuarine/marine systems is recommended. This permits monitoring of a wide variety of habitats, feeding strategies, and physiological factors that might result in differences in bioaccumulation of contaminants. Estuarine/marine species used in several national contaminant monitoring programs reviewed by the 1993 EPA Workgroup are compared in Table 3-18.

3.4.1 Target Shellfish Species

Selection of shellfish species (particularly bivalve molluscs) as target species received primary consideration by the 1993 EPA Workgroup because of the commercial, recreational, and subsistence value of shellfish in many coastal areas of the United States. Bivalve molluscs (e.g., oysters, mussels, and clams) are filter feeders that accumulate contaminants directly from the water column or via ingestion of contaminants adsorbed to phytoplankton, detritus, and sediment particles. Bivalves are good bioaccumulators of heavy metals (Cunningham, 1979) and polycyclic aromatic hydrocarbons (PAHs) and other organic compounds (Phillips, 1980; NOAA, 1987) and, because they are sessile, they may reflect local contaminant concentrations more accurately than more mobile crustacean or finfish species.

Three bivalve species—the blue mussel (*Mytilus edulis*), the California mussel (*Mytilus californianus*), and the American oyster (*Crassostrea virginica*)—were recommended and/or used in three of the national monitoring programs reviewed by the 1993 EPA Workgroup. Two other bivalve species—the soft-shell clam (*Mya arenaria*) and the Pacific oyster (*Crassostrea gigas*)—were also recommended and/or used in two national programs. Although no bivalve species was identified by name in state fish and shellfish consumption advisories (Appendix D), seven coastal states issued advisories in 1993 for unspecified bivalves or shellfish species that may have included these and other bivalve species. All three species are known to bioaccumulate a variety of environmental contaminants (Phillips, 1988). The wide distribution of these three species makes them useful for comparison within a state or between states sharing coastal waters (Figure 3-2). Because these three species met all of the selection criteria, they were recommended as target species for use in geographic areas in which they occur.

Table 3-17. Sources of Information on Commercial and Sportfishing Species in Various Coastal Areas of the United States

Geographic area	Source
Atlantic Coast	<p>National Marine Fisheries Service. 1987. <i>Marine Recreational Fishery Statistics Survey, Atlantic and Gulf Coasts, 1986</i>. Current Fishery Statistics Number 8392. National Oceanic and Atmospheric Administration, U.S. Department of Commerce, Rockville, MD.</p> <p>Leonard, D.L., M.A. Broutman, and K.E. Harkness. 1989. <i>The Quality of Shellfish Growing Waters on the East Coast of the United States</i>. Strategic Assessment Branch, National Oceanic and Atmospheric Administration, U.S. Department of Commerce, Rockville, MD.</p> <p>Nelson, D.M., M.E. Monaco, E.A. Irlandi, L.R. Settle, and L. Coston-Clements. 1991. <i>Distribution and Abundance of Fishes and Invertebrates in Southeast Estuaries</i>. ELMR Report No. 9. Strategic Assessment Division. National Oceanic and Atmospheric Administration, U.S. Department of Commerce, Rockville, MD.</p> <p>Stone, S.L., T.A. Lowery, J.D. Field, C.D. Williams, D.M. Nelson, S.H. Jury, M.E. Monaco, and L. Andreasen. 1994. <i>Distribution and Abundance of Fishes and Invertebrates in Mid-Atlantic Estuaries</i>. ELMR Rep. No. 12. NOAA/NOS Strategic Environmental Assessments Division, Silver Spring, MD.</p> <p>Jury, S.H., J.D. Field, S.L. Stone, D.M. Nelson, and M.E. Monaco. 1994. <i>Distribution and Abundance of Fishes and Invertebrates in North Atlantic Estuaries</i>. ELMR Rep. No. 13. NOAA/NOS Strategic Environmental Assessments Division, Silver Spring, MD.</p>
Gulf Coast	<p>National Marine Fisheries Service. 1987. <i>Marine Recreational Fishery Statistics Survey, Atlantic and Gulf Coasts, 1986</i>. Current Fishery Statistics Number 8392. National Oceanic and Atmospheric Administration, U.S. Department of Commerce, Rockville, MD.</p> <p>Broutman, M.A., and D.L. Leonard. 1988. <i>The Quality of Shellfish Growing Waters in the Gulf of Mexico</i>. Strategic Assessment Branch, National Oceanic and Atmospheric Administration, Rockville, MD.</p> <p>Monaco, M.E., D.M. Nelson, T.C. Czapl, and M.E. Patillo. 1989. <i>Distribution and Abundance of Fishes and Invertebrates in Texas Estuaries</i>. ELMR Report No. 3. Strategic Assessment Branch, National Oceanic and Atmospheric Administration, U.S. Department of Commerce, Rockville, MD.</p> <p>Williams, C.D., D.M. Nelson, M.E. Monaco, S.L. Stone, C. Iancu, L. Coston-Clements, L.R. Settle, and E.A. Irlandi. 1990. <i>Distribution and Abundance of Fishes and Invertebrates in Eastern Gulf of Mexico Estuaries</i>. ELMR Report No. 6. Strategic Assessment Branch, National Oceanic and Atmospheric Administration, U.S. Department of Commerce, Rockville, MD.</p> <p>Czapl, T.C., M.E. Patillo, D.M. Nelson, and M.E. Monaco. 1991. <i>Distribution and Abundance of Fishes and Invertebrates in Central Gulf of Mexico Estuaries</i>. ELMR Report No. 7. Strategic Assessment Branch, National Oceanic and Atmospheric Administration, U.S. Department of Commerce, Rockville, MD.</p> <p>Nelson, D.M. (editor). 1992. <i>Distribution and Abundance of Fishes and Invertebrates in Gulf of Mexico Estuaries</i>, Volume I: Data Summaries. ELMR Rep. No. 10. NOAA/NOS Strategic Environmental Assessments Division, Rockville, MD.</p> <p>Patillo, M.E., T.E. Czapl, D.M. Nelson, and M.E. Monaco. 1997. <i>Distribution and Abundance of Fishes and Invertebrates in Gulf of Mexico Estuaries. Vol. II: Species Life History Summaries</i>. ELMR Rep. No. 14. NOAA/NOS Strategic Environmental Assessments Division, Silver Spring, MD.</p>
West Coast	<p>National Marine Fisheries Service. 1987. <i>Marine Recreational Fishery Statistics Survey, Pacific Coast, 1986</i>. Current Fishery Statistics Number 8393. National Oceanic and Atmospheric Administration, U.S. Department of Commerce, Rockville, MD.</p> <p>Leonard, D.L., and E.A. Slaughter. 1990. <i>The Quality of Shellfish Growing Waters on the West Coast of the United States</i>. Strategic Assessment Branch, National Oceanic and Atmospheric Administration, U.S. Department of Commerce, Rockville, MD.</p> <p>Monaco, M.E., D.M. Nelson, R.L. Emmett, and S.A. Hinton. 1990. <i>Distribution and Abundance of Fishes and Invertebrates in West Coast Estuaries</i>. Volume I: Data Summaries. ELMR Report No. 4. Strategic Assessment Branch, National Oceanic and Atmospheric Administration, Rockville, MD.</p> <p>Emmett, R.L., S.A. Hinton, S.L. Stone, and M.E. Monaco. 1991. <i>Distribution and Abundance of Fishes and Invertebrates in West Coast Estuaries</i>. Volume II: Life History Summaries. ELMR Report No. 8. Strategic Environmental Assessment Division, Rockville, MD.</p>

Table 3-18. Estuarine/Marine Species Used in Several National Fish and Shellfish Contaminant Monitoring Programs

	U.S. EPA National Dioxin Study ^a	NOAA Status and Trends	U.S. EPA 301(h) Program	U.S. EPA NSCRF ^b
FINFISH				
Family <i>Acipenseridae</i> White sturgeon (<i>Acipenser transmontanus</i>)				●
Family <i>Ariidae</i> Hardhead catfish (<i>Arius felis</i>)				●
Family <i>Percichthyidae</i> White perch (<i>Morone americana</i>)				●
Family <i>Pomatomidae</i> Bluefish (<i>Pomatomus saltatrix</i>)				●
Family <i>Lutjanidae</i> Red snapper (<i>Lutjanus campechanus</i>)				●
Family <i>Sparidae</i> Sheepshead (<i>Archosargus probatocephalus</i>)				●
Family (<i>Sciaenidae</i>) Spotted seatrout (<i>Cynoscion nebulosus</i>)				●
Weakfish (<i>Cynoscion regalis</i>)				●
Spot (<i>Leiostomus xanthurus</i>)		●	●	●
White croaker (<i>Genyonemus lineatus</i>)		●		●
Atlantic croaker (<i>Micropogonias undulatus</i>)		●		●
Black drum (<i>Pogonias cromis</i>)				●
Red drum (<i>Sciaenops ocellatus</i>)				●
Family <i>Serranidae</i> Barred sand bass (<i>Paralabrax nebulifer</i>)		●		
Family <i>Mugilidae</i> Striped mullet (<i>Mugil cephalus</i>)				●
Family <i>Bothidae</i> Southern flounder (<i>Paralichthys lethostigma</i>)				●
Windowpane flounder (<i>Scophthalmus aquosus</i>)		●		
Family <i>Pleuronectidae</i> Pacific sanddab (<i>Citharichthys sordidus</i>)			●	
Flathead sole (<i>Hippoglossoides elassodon</i>)				●
Diamond turbot (<i>Hypsopsetta guttulata</i>)		●		
Starry flounder (<i>Platichthys stellatus</i>)		●		●
Hornyhead turbot (<i>Pleuronichthys verticalis</i>)		●		
Winter flounder (<i>Pseudopleuronectes americanus</i>)		●	●	●
English sole (<i>Parophrys vetulus</i>)		●	●	
Dover sole (<i>Microstomus pacificus</i>)		●	●	

See notes at end of table.

(continued)

Table 3-18. (continued)

	U.S. EPA National Dioxin Study ^a	NOAA Status and Trends	U.S. EPA 301(h) Program	U.S. EPA NSCRF ^b
SHELLFISH				
Bivalves				
Hard clam (<i>Mercenaria mercanaria</i>)			●	
Soft-shell clam (<i>Mya arenaria</i>)			●	●
Ocean quahog (<i>Arctica islandia</i>)			●	
Surf clam (<i>Spisula solidissima</i>)			●	
Blue mussel (<i>Mytilus edulis</i>)	●	●	●	
California mussel (<i>Mytilus californianus</i>)	●	●	●	
American oyster (<i>Crassostrea virginica</i>)	●	●	●	
Hawaiian oyster (<i>Ostrea sandwichensis</i>)		●		
Pacific oyster (<i>Crassostrea gigas</i>)			●	●
Bent-nosed macoma (<i>Macoma nasuta</i>)			●	
Baltic macoma (<i>Macoma baltica</i>)			●	
White sand macoma (<i>Macoma secta</i>)			●	
Crustaceans				
American lobster (<i>Homarus americanus</i>)			●	
West Indies spiny lobster (<i>Panulirus argus</i>)			●	
California rock lobster (<i>Panulirus interruptus</i>)			●	
Hawaiian spiny lobster (<i>Panulirus penicillatus</i>)			●	
Eastern rock crab (<i>Cancer irroratus</i>)			●	
Dungeness crab (<i>Cancer magister</i>)			●	●
Pacific rock crab (<i>Cancer antennarius</i>)			●	
Yellow crab (<i>Cancer anthonyi</i>)			●	
Red crab (<i>Cancer productus</i>)			●	

NSCRF = National Study of Chemical Residues in Fish.

^a Only freshwater finfish were identified as target species; bivalves were identified as estuarine/marine target species.

^b Species listed were those collected at more than one site nationally; *Salmonidae* were not listed because they were included on freshwater lists.

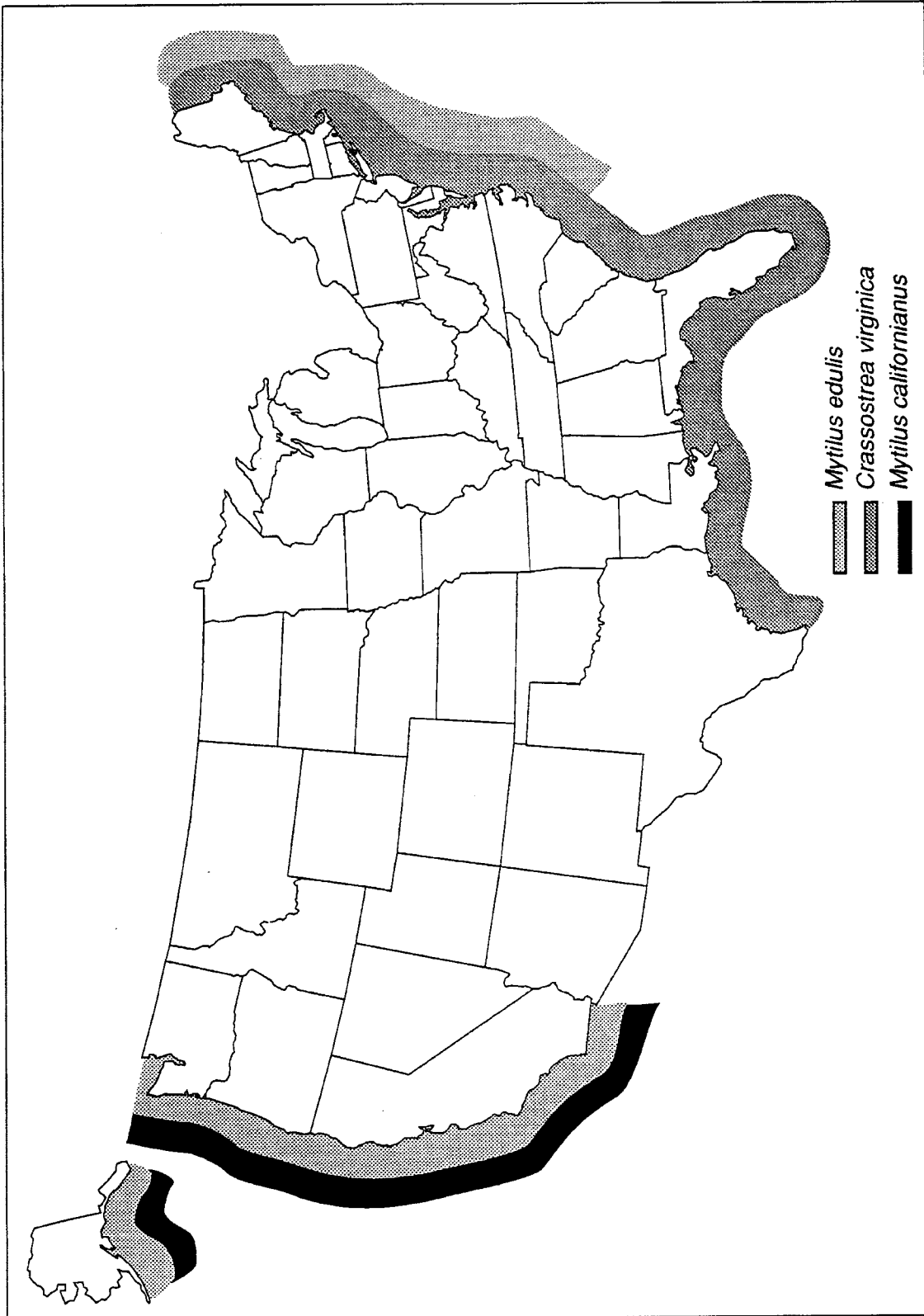

Source: Abbott, 1974.

Figure 3-2. Geographic distributions of three bivalve species used extensively in national contaminant monitoring programs.

In addition, several species of edible clams were added to the various estuarine/marine target species lists based on recommendations received from specific state and regional fisheries experts.

Crustaceans are also recommended as target species for estuarine/marine sampling sites. Many crustaceans are bottom-dwelling and bottom-feeding predator and/or scavenger species that are good indicators of contaminants that may be biomagnified through several trophic levels of the food web. Several species of lobsters and crabs were recommended in one national monitoring program, and the Dungeness crab was recommended in two national monitoring programs (Table 3-18). These crustaceans, although of fishery value in many areas, are not as widely distributed nationally as the three bivalve species (Figure 3-2). However, they should be considered for selection as target species in states where they are commonly consumed.

Only two crustaceans—the American lobster (*Homarus americanus*) and the blue crab (*Callinectes sapidus*)—were specifically identified in state advisories (RTI, 1993). However, in 1993, seven coastal states reported advisories in estuarine/marine waters for unspecified shellfish species that may have included these and other crustacean species (Table 3-19). All of the shellfish species cited in state advisories are included as EPA-recommended target species on the appropriate estuarine/marine regional lists.

3.4.2 Target Finfish Species

Two problems were encountered in the selection of target finfish species for monitoring fish tissue contamination at estuarine/marine sites regionally and nationally. First is the lack of finfish species common to both Atlantic and Gulf Coast waters as well as Pacific Coast waters. Species used in several federal fish contaminant monitoring programs are compared in Table 3-18. Members of the families *Sciaenidae* (seven species), *Bothidae* (two species), and *Pleuronectidae* (eight species) were used extensively in these programs. Bottom-dwelling finfish species (e.g., flounders in the families *Bothidae* and *Pleuronectidae*) may accumulate high concentrations of contaminants from direct physical contact with contaminated bottom sediments. In addition, these finfish feed on sedentary infaunal or epifaunal organisms and are at additional risk of accumulating contaminants via ingestion of these contaminated prey species (U.S. EPA, 1987a). For finfish species, two Atlantic coast species, spot (*Leiostomus xanthurus*) and winter flounder (*Pseudopleuronectes americanus*), are recommended and/or used in three of the national monitoring programs, and the Atlantic croaker (*Micropogonias undulatus*) is recommended and/or used in two national monitoring programs. Three Pacific coast species, Starry flounder (*Platichthys stellatus*), English sole (*Parophrys vetulus*), and Dover sole (*Microstomus pacificus*), are recommended or used in two of the national monitoring programs.

Table 3-19. Principal Estuarine/Marine Fish and Shellfish Species Cited in State Consumption Advisories^{a,b}

Species group name	Common name	Scientific name	Number of states with advisories in 1993	Number of states with advisories in 1998
Finfish				
<i>Percichthyidae</i>	Striped bass	<i>Morone saxatilis</i>	5	6
	White perch	<i>Morone americana</i>	3	3
<i>Centrarchidae</i>	Largemouth bass	<i>Micropterus salmoides</i>	0	3
	Smallmouth bass	<i>Micropterus dolomieu</i>	0	1
<i>Ictaluridae</i>	White catfish	<i>Ictalurus catus</i>	4	2
	Channel catfish	<i>Ictalurus punctatus</i>	5	2
<i>Anguillidae</i>	American eel	<i>Anguilla rostrata</i>	6	5
<i>Elopidae</i>	Ladyfish	<i>Elops saurus</i>	0	1
<i>Carangidae</i>	Crevalle jack	<i>Caranx hippos</i>	0	1
<i>Pomatomidae</i>	Bluefish	<i>Pomatomus saltatrix</i>	4	6
<i>Labridae</i>	Tautog	<i>Tautoga onitis</i>	0	1
<i>Sparidae</i>	Scup	<i>Stenotomus chrysops</i>	0	1
<i>Sciaenidae</i>	Spotted sea trout	<i>Cynoscion nebulosus</i>	0	2
	Atlantic croaker	<i>Micropogonias undulatus</i>	0	1
	Red drum	<i>Sciaenops ocellatus</i>	0	1
	Black drum	<i>Pogonias cromis</i>	0	1
	Silver perch	<i>Bairdiella chrysoura</i>	0	1
<i>Scombridae</i>	King mackerel	<i>Scomberomorus cavalla</i>	0	5
	Spanish mackerel	<i>Scomberomorus maculatus</i>	0	1
<i>Ariidae</i>	Gafftopsail catfish	<i>Bagre marinus</i>	0	1
<i>Belonidae</i>	Atlantic needlefish	<i>Strongylura marina</i>	1	1
<i>Serranidae</i>	Kelp bass	<i>Paralabrax clathratus</i>	1	1
<i>Sciaenidae</i>	Black croaker	<i>Cheilotrema saturnum</i>	1	1
	White croaker	<i>Genyonemus lineatus</i>	1	1
	Queenfish	<i>Seriphus politus</i>	1	1
	Corbina	<i>Menticirrhus undulatus</i>	1	1
Shellfish				
<i>Crustaceans^c</i>	American lobster	<i>Homarus americanus</i>	1	5
	Blue crab	<i>Callinectes sapidus</i>	3	4

^a Species in boldface are EPA-recommended target species for regional estuarine/marine waters (see Tables 3-10 through 3-16).

^b Many coastal states issued advisories for fish and shellfish species and thus did not identify specific finfish and shellfish species in their advisories.

^c Eight coastal states (California, Georgia, Hawaii, Louisiana, Massachusetts, North Carolina, Texas, and Washington) and the U.S. territory of American Samoa report advisories for unspecified shellfish or bivalve species.

Sources: RTI, 1993, EPA 1999a (NLFWA).

Second, because some estuarine/marine finfish species are highly migratory, harvesting of these species may be restricted to certain seasons because sexually mature adult fish (i.e., the recommended size for sampling) may enter the estuaries only to spawn. EPA recommends that neither spawning populations nor undersized juvenile stages be sampled in fish contaminant monitoring programs. Sampling of target finfish species during their spawning period should be avoided as contaminant tissue concentrations may decrease during this time (Phillips, 1980) and because the spawning period is generally outside the legal harvest period. **Note:** Target finfish species may be sampled during their spawning period if the species can be legally harvested at this time. Sampling of undersized juveniles of species that use estuaries as nursery areas is precluded by EPA's recommended monitoring strategy because juveniles may not have had sufficient time to bioaccumulate contaminants or attain harvestable size.

Because of these problems, the 1993 EPA Workgroup consulted with regional and state fisheries experts and reviewed the list of state fish consumption advisories and bans to determine which estuarine/marine finfish species should be recommended as target species. As shown in Table 3-19, the largest number of states issuing advisories in 1993 for specific estuarine and marine waters did so for the American eel (6), channel catfish (5), striped bass (5), bluefish (4), white catfish (4), and white perch (3). Several other estuarine/marine species were cited in advisories for one state each (Table 3-19). Many coastal states did not identify individual finfish species by name in their advisories (see Appendix D); however, almost all of the species that have been cited in state advisories are recommended as target species by EPA (see Tables 3-10 through 3-16). The listing of estuarine fish and shellfish cited in state advisories in 1998 is also shown in Table 3-19.

These seven regional lists of recommended estuarine/marine target species are provided to give guidance to states on species commonly consumed by the general population. state personnel, with their knowledge of site-specific fisheries and human consumption patterns, must be the ultimate judge of the species selected for use in estuarine/marine fish contaminant monitoring programs within their jurisdiction.

SECTION 4

TARGET ANALYTES

The selection of appropriate target analytes in fish and shellfish contaminant monitoring programs is essential to the adequate protection of the health of fish and shellfish consumers. The procedures used for selecting target analytes for screening studies and a list of recommended target analytes are presented in this section.

4.1 RECOMMENDED TARGET ANALYTES

Recommended target analytes for screening studies in fish and shellfish contaminant monitoring programs are listed in Table 4-1. This list was developed by the EPA 1993 Fish Contaminant Workgroup from a review of the following information:

1. Pollutants analyzed in several national or regional fish contaminant monitoring programs—The monitoring programs reviewed included

- National Study of Chemical Residues in Fish (U.S. EPA)
- National Dioxin Study (U.S. EPA)
- 301(h) Monitoring Program (U.S. EPA)
- National Pollutant Discharge Elimination System (U.S. EPA)
- National Pesticide Monitoring Program (U.S. FWS)
- National Contaminant Biomonitoring Program (U.S. FWS)
- National Status and Trends Program (NOAA)
- Great Lakes Sportfish Consumption Advisory Program
- National Water Quality Assessment Program (USGS).

Criteria for selection of the target analytes in these programs varied widely depending on specific program objectives. The target analytes used in these major fish contaminant monitoring programs are compared in Appendix E. Over 200 potential contaminants are listed, including metals, pesticides, base/neutral organic compounds, dioxins, dibenzofurans, acidic organic compounds, and volatile organic compounds.

Table 4-1. Recommended Target Analytes

Metals	Organophosphate Pesticides
Arsenic (inorganic)	Chlorpyrifos
Cadmium	Diazinon
Mercury (methylmercury)	Disulfoton
Selenium	Ethion
Tributyltin	Terbufos
Organochlorine Pesticides	Chlorophenoxy Herbicides
Chlordane, total (cis- and trans-chlordane, cis- and trans-nonachlor, oxychlordane)	Oxyfluorfen
DDT, total (2,4'-DDD, 4,4'-DDD, 2,4'-DDE, 4,4'-DDE, 2,4'-DDT, 4,4'-DDT)	PAHs ^d
Dicofol	PCBs
Dieldrin	Total PCBs ^e (sum of PCB congeners or Aroclor equivalents)
Endosulfan (I and II)	Dioxins/furans ^{f,g}
Endrin	
Heptachlor epoxide ^a	
Hexachlorobenzene	
Lindane (γ -hexachlorocyclohexane; γ -HCH) ^b	
Mirex ^c	
Toxaphene	

PAHs = Polycyclic aromatic hydrocarbons; PCBs = Polychlorinated biphenyls; DDT = p,p'-dichlorodiphenyl trichloroethane; DDE = p,p'-dichlorodiphenyl dichloroethylene; and DDD = dichlorodiphenyldichloro ethane.

^a Heptachlor epoxide is not a pesticide but is a metabolite of two pesticides, heptachlor and chlordane.

^b Also known as γ -benzene hexachloride (γ -BHC).

^c Mirex should be regarded primarily as a regional target analyte in the Southeast and Great Lakes states, unless historic tissue, sediment, or discharge data indicate the likelihood of its presence in other areas.

^d It is recommended that tissue samples be analyzed for benzo[*a*]pyrene, and 14 other PAHs and that the order-of-magnitude relative potencies given for these PAHs be used to calculate a potency equivalency concentration (PEC) for each sample for comparison with the recommended SVs for benzo[*a*]pyrene (see Section 5.3.2.5).

^e Analysis of total PCBs (as the sum of Aroclors or PCB congeners) is recommended for conducting human health risk assessments for total PCBs (see Sections 4.3.6 and 5.3.2.6). A standard method for Aroclor analysis is available (EPA Method 608). A standard method for congener analysis (EPA Method 1668) is currently under development; however, it has not been finalized. States that currently do congener-specific PCB analysis should continue to do so and other states are encouraged to develop the capability to conduct PCB congener analysis. When standard methods for congener analysis are verified and peer reviewed, the Office of Water will evaluate the use of these methods.

^f Note: The EPA Office of Research and Development is currently reassessing the human health effects of dioxins/furans.

^g It is recommended that the 17 2,3,7,8-substituted tetra- through octa-chlorinated dibenzo-*p*-dioxins (PCDDs) and dibenzofurans (PCDFs) and 12 dioxin-like PCBs be determined and a toxicity-weighted total concentration calculated for each sample (Van den Berg et al., 1998) (see Sections 4.3.7, 5.3.2.6, and 5.3.2.7).

2. Pesticides with active registrations—The EPA Office of Pesticide Programs (OPP) Fate One Liners Database (U.S. EPA, 1993a) containing information for more than 900 registered pesticides was reviewed to identify pesticides and herbicides with active registrations that met four criteria. The screening criteria used were

- Oral toxicity, Class I or II
- Bioconcentration factor greater than 300
- Half-life value of 30 days or more
- Initial use application profile.

At the time of this review, complete environmental fate information was available for only about half of the registered pesticides. As more data become available, additional pesticides will be evaluated for possible inclusion on the target analyte list.

Use of the OPP database was necessary because many pesticides and herbicides with active registrations have not been monitored extensively either in national or state fish contaminant monitoring programs.

3. **Contaminants that have triggered states to issue fish and shellfish consumption advisories or bans**—The database, *National Listing of State Fish and Shellfish Consumption Advisories and Bans* (RTI, 1993), was reviewed to identify specific chemical contaminants that have triggered issuance of consumption advisories by the states. As shown in Table 4-2, four contaminants (PCBs, mercury, chlordane, and dioxins/furans) triggered advisories in the largest number of states in 1993. As a comparison, the number of states issuing advisories for each pollutant in 1998 has also been presented while the total number of states issuing advisories for most pollutants generally has increased, the number of states issuing advisories for two major pollutants, chlordane and dioxin, has decreased over the past 5 years.
4. **Published literature on the chemistry and health effects of potential contaminants**—The physical, chemical, and toxicologic factors considered to be of particular importance in developing the recommended target analyte list were
 - Oral toxicity
 - Potential of the analyte to bioaccumulate
 - Prevalence and persistence of the analyte in the environment
 - Biochemical fate of the analyte in fish and shellfish
 - Human health risk of exposure to the analyte via consumption of contaminated fish and shellfish
 - Analytical feasibility.

Final selection of contaminants by the EPA 1993 Workgroup for the recommended target analyte list (Table 4-1) was based on their frequency of inclusion in national monitoring programs, on the number of states issuing consumption advisories for them in 1993 (Table 4-2), and on their origins, chemistry, potential to bioaccumulate, estimated human health risk, and feasibility of analysis. Primary consideration was also given to the recommendations of the Committee on Evaluation of the Safety of Fishery Products, published in *Seafood Safety* (NAS, 1991).

4.2 SELECTION AND PRIORITIZATION OF TARGET ANALYTES

The decision to conduct a fish tissue monitoring study is normally the result of the discovery of specific contaminants during water quality or sediment studies and/or

Table 4-2. Contaminants Resulting in Fish and Shellfish Advisories

Contaminant	Number of states issuing advisories	
	1993	1998
Metals		
Arsenic (total)	1	3
Cadmium	2	3
Chromium	1	1
Copper	1	1
Lead	4	5
Mercury	29	40
Selenium	5	5
Tributyltin	1	0
Zinc	1	1
Organometallics	1	1
Unidentified metals	3	1
Pesticides		
Chlordane	24	22
DDT and metabolites	9	12
Dieldrin	3	6
Heptachlor epoxide	1	1
Hexachlorobenzene	2	2
Kepone	1	1
Mirex	3	3
Photomirex	1	0
Toxaphene	2	4
Unidentified pesticides	2	2
Polycyclic aromatic hydrocarbons (PAHs)	3	4
Polychlorinated biphenyls (PCBs)	32	36
Dioxins/furans	20	19
Other chlorinated organics		
Dichlorobenzene	1	1
Hexachlorobutadiene	1	1
Pentachlorobenzene	1	0
Pentachlorophenol	1	2
Tetrachlorobenzene	2	0
Tetrachloroethane	1	0
Others		
Creosote	2	2
Gasoline	1	1
Multiple pollutants	2	1
Phthalate esters	1	0
Polybrominated biphenyls (PBBs)	1	1
Unspecified pollutants	3	0

Sources: RTI, 1993; U.S. EPA, 1999c.

the identification of pollutant sources in waters routinely used by recreational or subsistence fishers. EPA recognizes that measuring all 25 target analytes in fish tissues collected at all state monitoring sites is expensive and that cost is an important consideration that states must evaluate in designing and implementing

their fish monitoring programs. Ideally, if resources are available to conduct sampling and analysis of all 25 target analytes, the state should consider this option because it provides the greatest amount of information for fishers in the state on levels of contamination statewide. Also, this approach can better detect the presence of those contaminants that are transported long distances from their points of release (e.g., methylmercury, dioxins/furans, toxaphene), often outside the state's borders, and contaminate relatively pristine areas devoid of any obvious pollutant sources.

If the cost of this approach is prohibitive, however, the state may wish to use a watershed-based approach as a way to reduce sampling and analysis costs (Table 4-3). The selection and prioritization recommendations discussed below are watershed-based and take into consideration land use categories (rural, agricultural, suburban/urban, and industrial) as well as geological characteristics, regional differences, and national pollution trends. Land use patterns (both current and historic) are often the most important factors in deciding what analytes to select for analysis. The watershed-based approach gives the highest priority (XXX) to analysis of contaminants that are widely dispersed nationally and relatively inexpensive to analyze, such as mercury. This approach gives a lower priority (X) to monitoring organochlorine pesticides (e.g., chlordane, DDT, and dieldrin) at rural and suburban sites, but a higher priority (XX) to monitoring these same chemicals in agricultural watersheds where their use has been extensive or in industrial watersheds where they may have been released during manufacturing, formulation, packaging, or disposal. Because of the very high cost of analysis for some contaminants (e.g., PCBs and dioxins/furans and dioxin-like PCBs), this watershed approach also allows money for these analyses to be directed toward analysis primarily in suburban/urban and industrial watersheds where sources either from historic manufacturing or historic and/or current practices (combustion or incineration sources) have been identified or where water and/or sediment data in the watershed have detected these chemicals at elevated concentrations.

States should use all available environmental data and their best scientific judgment when developing their fish monitoring programs. Using the watershed approach gives states the flexibility to tailor their sampling and analysis programs to obtain needed information as cost-effectively as possible by directing limited resources to obtaining information on contaminant levels most likely to be found in fish tissue at a given site. To be most effective, states need to recognize and carefully evaluate all existing data when assessing which target analytes to monitor at a particular site. States should include any of the recommended EPA target analytes and any additional target analytes in their screening programs when site-specific information (e.g., tissue, water, or sediment data; discharge monitoring data from municipal and industrial sources; or pesticide use data) suggests that these contaminants may be present at levels of concern for human health.

Table 4-3. Selection and Prioritization of Target Analytes by Watershed Type

Analyte	Rural	Agricultural	Suburban/ Urban	Industrial	Sources/Uses
Metals					
Arsenic	XX ^a	X ^{a,b}	X ^{a,b}	XX ^b	Naturally occurring as a sulfide in mineral ores; fossil fuel combustion; mining/smelting; wood preservative; insecticide, herbicide, and algicide; hazardous waste site leachate
Cadmium	XX ^a	X ^{a,b}	X ^{a,b}	XX ^b	Smelting/mining; surface mine drainage; uses in paints, alloys, batteries, plastics, pesticides, herbicides; waste disposal operations.
Mercury	XXX ^c	XXX ^c	XXX ^c	XXX ^c	Naturally occurring; atmospheric transport from fossil fuel combustion; mining/smelting; chlorine alkali production; historic use in pulp and paper and paints; Hazardous waste site leachate; statewide freshwater and/or coastal advisories in 15 states
Selenium	XX ^a	X ^a	X ^a	XX ^d	Naturally occurring in west and southwest soils; emissions from fossil fuel combustion; leachate from coal fly ash disposal areas
Tributyltin			X ^d	XX ^d	Shipyards and marinas; uses in antifouling paint, cooling tower disinfectants, wood preservatives, pulp and paper industry, and textile mills.
Organochlorine Pesticides					
Chlordane		XX ^b	X ^b	XX ^b	Domestic termite control; pesticide manufacturing/packaging/formulation sites
DDT		XX ^b	X ^b	XX ^b	Broad spectrum pesticide use; pesticide manufacturing/packaging/formulation sites
Dicofol ^e		XX ^b		XX ^b	Miticide/pesticide for cotton, apples, and citrus primarily in FL and CA; lesser use in turf, ornamentals, pears, apricots, and cherries; pesticide manufacturing/packaging/formulation sites
Dieldrin		XX ^b	X ^b	XX ^b	Broad spectrum pesticide for termites/soil insects and for cotton, corn, and citrus; pesticide manufacturing/packaging/formulation sites
Endosulfan ^e		XX ^b		XX ^b	Noncontact insecticide for seed and soil treatments; pesticide manufacturing/packaging/formulation sites
Endrin		XX ^b		XX ^b	Broad spectrum pesticide; pesticide manufacturing/packaging/formulation sites
Heptachlor epoxide		XX ^b	X ^b	XX ^b	Degradation product of heptachlor used as a contact and ingested soil insecticide for termites and household pesticide and chlordane also used as a termiticide; pesticide manufacturing/packaging/formulation sites for heptachlor and chlordane

Table 4-3. (continued)

Analyte	Rural	Agricultural	Suburban/ Urban	Industrial	Sources/Uses
Hexachlorobenzene		XX ^b		XX ^b	Fungicide used as seed protectant, used as chemical intermediate in production of many other organochlorine pesticides; pesticide manufacturing/packaging/formulation sites for a wide variety of organochlorine pesticides
Lindane ^e		XX ^b	X ^b	XX ^b	Seed and soil treatments for tobacco; foliage applications for fruit and nut trees and vegetables; wood preservative. pesticide manufacturing/packaging/formulation sites
Mirex		XX ^b	X ^b	XX ^b	Used extensively in Southeast and Gulf Coast states against fire ants; used in fire retardants and plastic polymerizer; pesticide manufacturing/packaging/formulation sites
Toxaphene		XX ^b		XX ^b	Insecticide for cotton; piscicide for rough fish; pesticide manufacturing/packaging/formulation sites
Organophosphate Pesticides					
Chlorpyrifos ^e		XX ^b	X ^b	XX ^b	Widely used on cotton, peanuts, and sorghum as well as fruits and vegetables; domestic household insecticide with lawn and garden applications. Use applications will change by the end of 2001. All residential use will end as will use on tomatoes. Use on apples and grapes will be greatly reduced (U.S. EPA, 2000b). Used as a termiticide in California; pesticide manufacturing/packaging/formulation sites
Diazinon ^e		XX ^b	X ^b	XX ^b	Widely used on a broad variety of fruits and vegetables, field crops, and pastureland; domestic household insecticide used for lawn and garden applications; pesticide manufacturing/packaging/formulation sites
Disulfoton ^e		XX ^b		XX ^b	Widely used as a side dressing, broadcast, and foliar spray and as a seed dressing; pesticide manufacturing/packaging/formulation sites
Ethion ^e		XX ^b	X ^b	XX ^b	Major use on citrus, fruit and nut trees, and vegetables. Domestic outdoor use around homes and lawns; pesticide manufacturing/packaging/formulation sites
Terbufos ^e		XX ^b		XX ^b	Used principally on corn, sugar beets, and grain sorghum; pesticide manufacturing/packaging/formulation sites
Chlorophenoxy Herbicides					
Oxyfluorfen ^e		XX ^b		XX ^b	Widely used to control grass and weeds in corn, cotton, soybeans, fruit and nut trees, and ornamental crops; pesticide manufacturing/packaging/formulation sites

Table 4-3. (continued)

Analyte	Rural	Agricultural	Suburban/ Urban	Industrial	Sources/Uses
Polycyclic Aromatic Hydrocarbons (PAHS)			X ^d	X ^d	Components of crude and refined petroleum and coal products; waste incineration, wood preservatives, creosote, coal tar, coal coking, urban runoff from asphalt, automobile tires and exhaust emissions, and petroleum spills; coal gasification sites, and petroleum refineries.
Polychlorinated Biphenyls (PCBs)			X ^d	X ^d	Produced as Arochlors for use as dielectric fluid in electrical transformers and as hydraulic fluid; leachate from land fills and Superfund sites.
Dioxins and Dibenzofurans			X ^d	X ^d	Industrial sites including bleached kraft paper mills, facilities handling 2,4,5-trichlorophenoxyacetic acid (2,4,5,-T), 2,4,5-trichlorophenol (2,4,5-TCP), silvex, hexachlorobenzene, pentachlorophenol, and PCBs.; Industrial and municipal combustors and incinerators

^a Tissue residue analysis is recommended if geologic characteristics suggest potential for elevated metal concentrations in water or sediment or if sources are identified in the watershed suggesting the presence of this target analyte at the sampling site.

^b Tissue residue analysis is recommended if use application of this pesticide has been reported in the watershed either from historic or current use data, if sources like pesticide production/packaging/formulation facilities exist in the watershed, or if the state has water and/or sediment data indicating the presence of this target analyte at the sampling site.

^c Tissue residue analysis is highly recommended at all sites.

^d Tissue residue analysis is recommended if sources as described in Sources/Uses column are identified in suburban/urban or industrial watershed or the state has water and/or sediment data indicating the presence of this analyte at the sampling site.

^e Pesticide with currently active registration

X = Analysis for target analyte should be considered if water and or sediment analysis results detect the target analyte or if historic or current use information provide evidence for the potential presence of this target analyte in the watershed.

XX = Analysis for target analyte is recommended for this land use type if historic or current use information provides evidence of the potential presence of this target analyte in the watershed.

XXX = Analysis for target analyte is highly recommended at all stations in all watershed types.

Rural. The major analytes of concern in rural waterbodies (i.e., watersheds with no past or current urban/suburban, industrial, or agricultural uses) are the metals, including arsenic, cadmium, mercury, and selenium. Weathering processes in certain geologic areas can result in elevated levels of arsenic, cadmium, mercury, and selenium in water and sediments. State agencies should also be aware of past land use patterns in what are now considered rural areas of their states. For example, abandoned mining sites may be a source of metal contamination via leaching from mine drainage or slag piles. Large areas east of the Appalachians were agricultural watersheds during the early to mid twentieth century. While some of this agriculture land is now suburban/urban in its use, other areas, particularly in the South, are reverting to forests that might at first glance be classified as rural use. Arsenic compounds were used as pesticides in the early

1900s, and, along with organochlorine pesticides, may still be present in farmland abandoned after the 1940s. States should also be aware that mercury has been identified in fish collected from what would be classified as rural or pristine areas of the Great Lakes basins and waterbodies in the northeastern and southeastern states remote from any obvious point sources of pollution. Mercury contamination in these areas seems to be facilitated through the atmospheric transport of this metal. Because mercury is the target analyte that has triggered issuance of the largest number of advisories in the United States (nearly 68 percent of all advisories nationwide) and because of the relatively low cost of chemical analysis for this analyte, EPA recommends that this metal be monitored at all rural sites, especially those where little or no monitoring data are available.

Depending on site-specific conditions and considerations, states may opt to analyze for mercury as well as a suite of other heavy metals that can be analyzed as a group at relatively low cost. The only target analyte metal that should not be analyzed for routinely in rural areas without other supporting data is tributyltin, which is typically found near boatyards and marinas or near wood preservative production facilities. States may include any of the recommended EPA target analytes and any additional target analytes in their screening programs when site-specific information on a rural watershed suggests that these contaminants may be present at levels of concern for human health.

Agricultural. The major analytes of concern in agricultural waterbodies (i.e., watersheds where past or current land use is dominated by agriculture) are the organochlorine and organophosphate pesticides and the chlorophenoxy herbicide, oxyfluorfen. These analytes fall into two categories, those with inactive registrations (i.e. banned or withdrawn from the market) and those with active registrations (endosulfan, lindane, dicofol, chlorpyrifos, diazinon, terbufos, ethion, disulfoton, and oxyfluorfen). Although use of some of the organochlorine pesticides was terminated more than 20 years ago in the United States (e.g., DDT, dieldrin, endrin, and mirex), these compounds still need to be monitored. Many of the organochlorine pesticides that are now banned were used in large quantities for over a decade and are still present in high concentrations at some sites. On a nationwide basis, chlordane and DDT, for example, are responsible for 3 and 1 percent, respectively, of the advisories currently in effect. For the pesticides with active registrations, use and rate application information maintained by the state's Department of Agriculture should be reviewed to identify watersheds where these pesticides are currently used and are likely to be present in aquatic systems as a result of agricultural runoff or drift. Unlike many of the historically used organochlorine pesticides, the pesticides in current use degrade relatively rapidly in the environment. In addition, federal regulations are in effect that set maximum application rates and minimize use near waterbodies. At the time of this writing, no fish consumption advisories for these analytes have yet been issued; however, state agencies should be aware of special circumstances that could result in accumulation in fish. In addition to accidental spills and misapplication, heavy and repeated rainfall shortly after application may wash these pesticides into streams. Signs of pesticide pollution may include erratic swimming behavior in fish as well as fish kills.

It is also important to note that pesticide uses and labels may change over time. All pesticides with active registrations are currently being reviewed by EPA under provisions of the Food Quality Protection Act of 1996. The state agency responsible for designing the fish contaminant monitoring program should be aware of all historic and current uses of each pesticide within its state, including the watersheds, application rates, and acreage where the pesticide has been or currently is applied to ensure that all potentially contaminated sites are included in the sampling plan. Because mercury contamination seems to be facilitated through atmospheric transport, because it has triggered issuance of the largest number of U.S. advisories, and because of the relatively low cost of chemical analysis for this analyte, EPA recommends that this metal be monitored at all agricultural sites, especially those for which little or no monitoring data are available. Additionally, states may also want to analyze for other metals (arsenic, cadmium, and selenium). States may include any of the recommended EPA target analytes and any additional target analytes in their screening programs when site-specific information on an agricultural watershed suggests that these contaminants may be present at levels of concern for human health.

Suburban/Urban. Water and sediment quality are often regularly monitored in suburban and urban areas, and selection of target analytes should be based on these data when available. Some suburban watersheds of today were agricultural watersheds during the early twentieth century. Arsenic compounds were widely used as pesticides in the early 1900s, as were organochlorine pesticides. These contaminants may still be present in farmland abandoned after the 1940s. As a result of the rapid population growth in recent years, other suburban areas have been built on former industrial sites, so historical information on land use should be obtained by states whenever possible and reviewed carefully during the target analyte selection process.

Several of the organophosphates as well as organochlorine pesticides have had wide use in control of pests around domestic structures as well as in lawn and garden applications (see Table 4-3). Chlorpyrifos and diazinon are currently used by pest control applicators and the general public (Robinson et al., 1994), and diazinon has been reported at high concentrations in effluents from POTWs in some suburban/urban areas (Amato et al., 1992; Burkhard and Jensen, 1993). Historically, chlordane was used extensively in termite control around homes and DDT was used as a general all-purpose insecticide. Nationally, chlordane and DDT are responsible for 3 and 1 percent, respectively, of the advisories currently in effect, and their use within suburban/urban watersheds should be considered as should the use of any of the pesticides registered for use around domestic structures or in lawn and garden applications. Depending on the proximity of some suburban/urban sites to industrial areas, states may also wish to review historic or current information on production sites associated with any of the pesticides, PAHs, PCBs, and dioxin/furans. Because of the historic and current uses of mercury in a variety of industrial processes, because it has triggered issuance of the largest number of U.S. advisories, and because of the relatively low cost of chemical analysis, EPA recommends that this metal be monitored at all suburban/urban sites, especially those where either little or no monitoring data

are available. States should include any of the recommended EPA target analytes and any additional target analytes in their screening programs when site-specific information on a suburban/urban watershed suggests that these contaminants may be present at levels of concern for human health.

Industrial. All of the recommended target analytes can enter waterbodies through releases from industrial processes, Superfund sites, or landfills. Often water and sediment data are available to help guide the selection of the target analytes that should be given high priority with respect to analysis. Selection of analytes for analysis in industrial watersheds should be guided by knowledge of the type of industrial production that has existed in the past or is currently present in the watershed. Historical information is particularly important since potential contaminants may still be present at abandoned industrial sites or contained in sediments in receiving waterbodies. Sources of these target analytes are listed in Section 4.3, which contains the individual target analyte profiles and descriptions of the types of industries that may contribute to releases of these specific pollutants. Again, the states should review all existing water and sediment quality data available before selecting the specific target analytes for analysis at each site. Because of the historic and current uses of mercury in a variety of industrial processes, because it has triggered issuance of the largest number of U.S. advisories, and because of the relatively low cost of chemical analysis, EPA recommends that this metal be monitored at all industrial sites, especially those where little or no monitoring data are available. The other metals, including tributyltin, should also be considered for analysis based on existence of industrial production facilities, waste disposal facilities (e.g., Superfund or hazardous waste sites, and landfills), or shipyards where these target analytes may have been released to the environment. With respect to the pesticides, sites of production, formulation, and packaging facilities can all potentially be sites for release of these contaminants into the surrounding environment. Petroleum refining and coal gasification and processing facilities can also be sites for discharges of PAHs. PCBs can be released from historic landfills where PCB-containing equipment was disposed of or from sites of historic PCB production or use. Dioxins and dibenzofurans are likely to be found in proximity to historic or current industrial sites such as bleached kraft paper mills or production facilities for 2,4,5-trichlorophenoxyacetic acid (2,4,5-T), 2,4,5-trichlorophenol (2,4,5-TCP), and/or silvex and medical, municipal, or industrial combustors or incinerators. States should include any of the recommended EPA target analytes and any additional target analytes in their screening programs when site-specific information on an industrial watershed suggests that these contaminants may be present at levels of concern for human health.

Specific factors that have been considered in the selection of the recommended 25 target analytes and sources for their release into the environment are summarized in the next section. Chemical pollutants that are currently under review by EPA's Office of Water for inclusion as recommended target analytes are discussed in Section 4.4.

4.3 TARGET ANALYTE PROFILES

4.3.1 Metals

Five metals—arsenic, cadmium, mercury, selenium, and tributyltin—are recommended as target analytes in screening studies. Arsenic, cadmium, and mercury have been included in at least five of the eight major fish contaminant monitoring programs reviewed by the 1993 Workgroup (see Appendix E). It should be noted, however, that with respect to arsenic, all monitoring programs measured total arsenic rather than inorganic arsenic. Selenium was monitored in four national monitoring programs. Tributyltin, a constituent in antifouling paints was not recommended for analysis in any of the national programs evaluated by the 1993 Workgroup. As of 1993, fish consumption advisories were in effect for arsenic, cadmium, mercury, selenium, and tributyltin in 1, 2, 29, 5, and 1 states, respectively (Table 4-2). As of 1998, fish advisories were in effect for arsenic, cadmium, mercury, and selenium in 3, 3, 40, and 11 states, respectively. No states had active advisories for tributyltin (U.S. EPA, 1999c). Also, with the exception of tributyltin, these metals have been identified as having the greatest potential toxicity resulting from ingestion of contaminated fish and shellfish (NAS, 1991).

4.3.1.1 Arsenic—

Arsenic is the twentieth most abundant element in the earth's crust and naturally occurs as a sulfide in a variety of mineral ores containing copper, lead, iron, nickel, cobalt, and other metals (Eisler, 1988; Merck Index, 1989; Woolson, 1975). Arsenic is released naturally to the atmosphere from volcanic eruptions and forest fires (Walsh et al., 1979) and to water via natural weathering processes (U.S. EPA, 1982b). Arsenic also has several major anthropogenic sources including industrial emissions from coal-burning electric generating facilities, releases, as a byproduct of nonferrous metal (gold, silver, copper, lead, uranium, and zinc) mining and smelting operations (Eisler, 1988; May and McKinney, 1981; NAS, 1977), releases associated with its production and use as a wood preservative (primarily as arsenic trioxide), and application as an insecticide, herbicide, algicide, and growth stimulant for plants and animals (Appendix F) (Eisler, 1988). Arsenic releases are also associated with leaching at hazardous waste disposal sites and discharges from sewage treatment facilities. Arsenic trioxide is the arsenic compound of chief commercial importance (U.S. EPA, 1982b) and was produced in the United States until 1985 at the ASARCO smelter near Tacoma, Washington. Arsenic is no longer produced commercially within the United States in any significant quantities, but arsenic compounds are imported into the United States primarily for use in various wood preservative and pesticide formulations.

The toxicity of arsenicals is highly dependent upon the nature of the compounds, and particularly upon the valency state of the arsenic atom (Frost, 1967; Penrose, 1974; Vallee et al., 1960). Typically, compounds containing trivalent (+3) arsenic are much more toxic than those containing pentavalent (+5) arsenic. The valency of the arsenic atom is a more important factor in determining toxicity than the

organic or inorganic nature of the arsenic-containing compound (Edmonds and Francesconi, 1993). With respect to inorganic arsenic compounds, salts of arsenic acid (arsenates) with arsenic in the pentavalent state are less toxic than arsenite compounds with arsenic in the trivalent state (Penrose, 1974). Because some reduction of arsenate (pentavalent arsenic) to arsenite (trivalent arsenic) might occur in the mammalian body (Vahter and Envall, 1983), it would be unwise to disregard the possible toxicity of inorganic arsenic ingested in either valency state (Edmonds and Francesconi, 1993).

Seafood is a major source of trace amounts of arsenic in the human diet. However, arsenic in the edible parts of fish and shellfish is predominantly present as the arsenic-containing organic compound arsenobetaine (Cullen and Reimer, 1989; Edmonds and Francesconi, 1987a; NAS, 1991). Arsenobetaine is a stable compound containing a pentavalent arsenic atom, which has been shown to be metabolically inert and nontoxic in a number of studies (Cannon et al., 1983; Bos et al., 1985; Kaise et al., 1985; Sabbioni et al., 1991; Vahter et al., 1983) and is not generally considered a threat to human health (ATSDR, 1998a). Inorganic arsenic, although a minor component of the total arsenic content of fish and shellfish when compared to arsenobetaine, presents potential toxicity problems. To the degree that inorganic forms of arsenic are either present in seafood or, upon consumption, may be produced as metabolites of organic arsenic compounds in seafood, some human health risk, although small, would be expected (NAS, 1991).

Inorganic arsenic is very toxic to mammals and has been assigned to Toxicity Class I based on oral toxicity tests (U.S. EPA, 1998d). Use of several arsenical pesticides has been discontinued because of the health risks to animals and man. Inorganic arsenic also has been classified as a human carcinogen (A), and long-term effects include dermal hyperkeratosis, dermal melanosis and carcinoma, hepatomegaly, and peripheral neuropathy (IRIS, 1999) (Appendix G).

Total arsenic (inclusive of both inorganic and organic forms) has been included in five of the eight national monitoring programs evaluated by the 1993 Workgroup (Appendix E). Arsenic and arsenic-containing organic compounds have not been shown to bioaccumulate to any great extent in aquatic organisms (NAS, 1977). Experimental evidence indicates that inorganic forms of both pentavalent and trivalent arsenic bioaccumulate minimally in several species of finfish including rainbow trout, bluegill, and fathead minnows (ASTER, 1999). A bioconcentration factor (BCF) value of 350 was reported for the American oyster (*Crassostrea virginica*) exposed to trivalent arsenic (Zaroogian and Hoffman, 1982).

In 1984 and 1985, the U.S. Fish and Wildlife Service collected 315 composite samples of whole fish from 109 stations nationwide as part of the National Contaminant Biomonitoring Program (Schmitt and Brumbaugh, 1990). The authors reported the the maximum, geometric mean, and 85th percentile concentrations for total arsenic were 1.5, 0.14, and 0.27 ppm (wet weight), respectively. No information, however, was available on the percentage of inorganic arsenic in the fish sampled in the NCBP study. Kidwell et al. (1995)

conducted an analysis of total arsenic levels in bottom-feeding and predator fish using the 1984-1985 data from the NCBP study. These authors reported that the mean total arsenic tissue concentrations of 0.16 ± 0.23 ppm in bottom feeders and 0.16 ± 0.14 ppm in predator fish were not significantly different.

Edmonds and Francesconi (1993) summarized existing data from studies conducted outside the United States comparing concentrations of total arsenic, organic arsenic, and inorganic arsenic in marine fish and shellfish. Inorganic arsenic was found to represent from 0 to 44 percent of the total arsenic in marine fish and shellfish species surveyed. Residue concentrations of inorganic arsenic in the tissues typically ranged from 0 to 5.6 ppm (wet weight basis); but were generally less than 0.5 ppm for most species. In a study of six species of freshwater fish monitored as part of the Lower Columbia River study, inorganic arsenic represented from 0.1 to 27 percent of the total arsenic, and tissue residues of inorganic arsenic ranging from 0.001 to 0.047 ppm (wet weight) were 100 times lower than those reported for marine species (Tetra Tech, 1995).

In 1993, only one state (Oregon) had an advisory in effect for arsenic contamination (RTI, 1993). As of 1998, there were three advisories in effect in three states (Louisiana, Oregon, and Washington) for this metal (U.S. EPA, 1999c). Because it is the concentration of inorganic arsenic in fish and shellfish that poses the greatest threat to human health, EPA recommends that total inorganic arsenic (not total arsenic) be analyzed in contaminant monitoring programs. A chemical analysis procedure for determining total inorganic arsenic residues in fish and shellfish tissues is provided in Appendix H. Total inorganic arsenic should be considered for inclusion in state fish and shellfish monitoring programs in areas where it occurs in geologic formations, sites where mining or smelter operations have occurred, or where its use is or has been extensive. States should contact their appropriate state agencies to obtain information on the historic and current uses of arsenic particularly as a wood preservative and in agricultural pesticides.

4.3.1.2 Cadmium—

Cadmium is commonly found in zinc, lead, and copper deposits (May and McKinney, 1981). It is released into the environment from several anthropogenic sources: smelting and refining of ores, electroplating, application of phosphate fertilizers, surface mine drainage (Frag et al., 1998; U.S. EPA, 1978), and waste disposal operations (municipal incineration and land application) (U.S. EPA, 1979a, 1987c). Cadmium is also used in the manufacture of paints, alloys, batteries, and plastics and has been used in the control of moles and plant diseases in lawns.

Cadmium is a cumulative human toxicant; it has been shown to cause renal dysfunction and a degenerative bone disease, Itai-Itai, in Japanese populations exposed via consumption of contaminated rice, fish, and water. Because cadmium is retained in the kidney, older individuals (over 40-50 years of age) typically have both the highest renal concentrations of cadmium and the highest prevalence of renal dysfunction (U.S. EPA, 1979a). Cadmium is a known

carcinogen in animals, and there is limited evidence of the carcinogenicity of cadmium or cadmium compounds in humans. It has been classified by EPA as a probable human carcinogen by inhalation (B1) (IRIS, 1999).

Cadmium has been found to bioaccumulate in fish and shellfish tissues in fresh water (Schmitt and Brumbaugh, 1990) and in estuarine/marine waters (NOAA, 1987, 1989a) nationwide. In 1984 and 1985, the U.S. Fish and Wildlife Service collected 315 composite samples of whole fish from 109 stations nationwide as part of the NCBP (Schmitt and Brumbaugh, 1990). The authors reported the maximum, geometric mean, and 85th percentile concentrations for cadmium were 0.22, 0.03, and 0.05 ppm (wet weight), respectively. In the NCBP study, geometric mean concentrations of cadmium in freshwater fish were found to have declined from 0.07 ppm in 1976 to 0.03 ppm in 1984 (Schmitt and Brumbaugh, 1990). This trend contradicts the general trend of increasing cadmium concentrations in surface waters, which Smith et al. (1987) attribute to increasing U.S. coal combustion (Schmitt and Brumbaugh, 1990). Kidwell et al. (1995) conducted an analysis of cadmium concentrations in bottom-feeding and predatory fish species using the 1984-1985 data from the NCBP study. These authors found that mean cadmium tissue concentration (whole fish samples) of 0.04 ± 0.05 ppm in bottom feeders (e.g., carp, white sucker, and channel catfish) was significantly higher than the mean cadmium tissue concentration of 0.01 ± 0.02 ppm found in predator fish (e.g., trout, walleye, largemouth bass).

In 1993, only two states (New York and Ohio) had issued fish advisories for cadmium contamination (RTI, 1993). As of 1998, there were seven advisories in effect in three states (Maine, New Jersey, and New York) for this heavy metal (U.S. EPA, 1999c). Two of these states, New York and New Jersey, have issued advisories for this metal in all of their marine coastal waters. Maine has a statewide wildlife advisory in effect for cadmium in moose liver and kidney tissue (U.S. EPA, 1999c). Cadmium should be considered for inclusion in all state fish and shellfish contaminant monitoring programs in areas where it occurs in geologic formations, where mining or smelter operations have occurred, or where its use is or has been extensive.

4.3.1.3 Mercury—

A major source of atmospheric mercury is the natural degassing of the earth's crust, amounting to 2,700 to 6,000 tons per year (WHO, 1990). Primary points of entry of mercury into the environment from anthropogenic sources include mining and smelting, industrial processes including chlorine-alkali production facilities and atmospheric deposition resulting from combustion of coal and other fossil fuels and municipal and medical refuse incinerators (U.S. EPA, 1997c; Glass et al., 1990). Primary industrial uses of mercury are in the manufacture of batteries, vapor discharge lamps, rectifiers, fluorescent bulbs, switches, thermometers, and industrial control instruments (May and McKinney, 1981), and these products ultimately end up in landfills or incinerators. Mercury has also been used as a slimicide in the pulp and paper industry, as an antifouling and mildew-proofing

agent in paints, and as an antifungal seed dressing (ATSDR, 1998; *Farm Chemicals Handbook*, 1989; Friberg and Vostal, 1972).

Although mercury use and losses from industrial processes in the United States have been reduced significantly since the 1970s, mercury contamination associated with increased fossil fuel combustion is of concern in some areas and may pose more widespread contamination problems in the future. An estimated 5,000 tons of mercury per year is released into the environment from fossil fuel burning (Klaassen et al., 1986). The best estimate of annual anthropogenic U.S. emissions of mercury in 1994-1995 was 158 tons. Of this, about 87 percent was released from combustion sources, including waste and fuel combustion. (U.S. EPA, 1997). There is also increasing evidence of elevated mercury concentrations in areas where acid rain is believed to be a factor (NESCAUM, 1998; Sheffy, 1987; Wiener, 1987). Volatilization from surfaces painted with mercury-containing paints, both indoors and outdoors, may have been a significant source in the past (Agocs et al., 1990; Sheffy, 1987). The United States estimated that 480,000 pounds of mercuric fungicides were used in paints and coatings in 1987 (NPCA, 1988). In July 1990, EPA announced an agreement with the National Paint and Coatings Association to cancel all registrations for use of mercury or mercury compounds in interior paints and coatings. In May 1991, the paint industry voluntarily canceled all remaining registrations for mercury in exterior paints.

Cycling of mercury in the environment is facilitated by the volatile character of its metallic form and by bacterial transformation of metallic and inorganic forms to stable alkyl mercury compounds, particularly in bottom sediments, which leads to bioaccumulation of mercury (Wood, 1974). Practically all mercury in fish tissue is in the form of methylmercury (Bache et al., 1971; Bloom, 1992; Kannan et al., 1998; Spry and Wiener, 1991), which is toxic to humans (NAS, 1991; Tollefson, 1989), with the percentage of methylmercury to total mercury in the muscle tissue increasing as the fish ages (Bache et al., 1971). Several studies have shown that mercury concentrations in fish tissue generally increase with age, and therefore size (length or weight), owing to methylmercury accumulation with increasing duration of exposure (Driscoll et al., 1994; Jackson, 1990; Johnson, 1987; Lange et al., 1993); however this relationship is not as strongly correlated in all environmental situations or for all fish species (Goldstein et al., 1996; Neumann et al., 1997).

EPA has classified methylmercury as a Group C, possible human carcinogen, based on inadequate data in humans and limited evidence in animals (Appendix G). No persuasive evidence of increased carcinogenicity attributable to methylmercury exposure was observed in three human studies; however, interpretation of these studies was limited by poor study design and other problems. Animal studies have shown significant increases in the incidences of kidney tumors in male, but not in female, mice (IRIS, 1999).

Both inorganic and organic forms of mercury are neurotoxicants. Fetuses exposed to organic mercury have been found to be born mentally retarded and

with symptoms similar to those of cerebral palsy (Marsh, 1987; U.S. EPA, 1997c). Individuals exposed to mercury via long-term ingestion of mercury-contaminated fish have been found to exhibit a wide range of symptoms, including numbness of the extremities, tremors, spasms, personality and behavior changes, difficulty in walking, deafness, blindness, and death (U.S. EPA, 1997c). Organomercury compounds were the causative agents of Minamata Disease, a neurological disorder reported in Japan during the 1950s among individuals consuming contaminated fish and shellfish (Kurland et al., 1960), with infants exposed prenatally found to be at significantly higher risk than adults. Another methylmercury poisoning incident involving fish and shellfish occurred in 1965 in Niigata, Japan. A third methylmercury poisoning incident occurred in the late 1960s and early 1970s in Iraq; however, this last incident was associated with the accidental consumption of seed grain treated with organomercury fungicide (U.S. EPA, 1997c). The EPA is especially concerned about evidence that the fetus is at increased risk of adverse neurological effects from exposure to methylmercury (e.g., Marsh et al., 1987; Piotrowski and Inskip, 1981; Skerfving, 1988; WHO, 1976, 1990; U.S. EPA, 1997c).

The EPA has set an interim Reference Dose (RfD) for methylmercury of 0.1 $\mu\text{g}/\text{kg}\cdot\text{d}$ (IRIS 1999). The National Academy of Sciences (NAS) conducted an independent assessment of the interim RfD. They concluded "On the basis of its evaluation, the committee's consensus is that the value of EPA's current RfD for methylmercury, 0.1 $\mu\text{g}/\text{kg}$ per day, is a scientifically justifiable level for the protection of public health". However, the NAS recommended that the Iraqi study no longer be used as the scientific basis for the RfD. In addition, the NAS recommended that the developmental neurotoxic effects of methylmercury reported in the Faroe Islands study should be used as the basis for the derivation of the RfD." (NAS, 2000)

Mercury has been found in both fish and shellfish from estuarine/marine (NOAA, 1987, 1989a) and fresh waters (Schmitt and Brumbaugh, 1990) at diverse locations nationwide. In 1984 and 1985, the U.S. Fish and Wildlife Service collected 315 composite samples of whole fish from 109 stations nationwide as part of the National Contaminant Biomonitoring Program (NCBP) (Schmitt and Brumbaugh, 1990). The authors reported that the maximum, geometric mean, and 85th percentile concentrations for mercury were 0.37, 0.10, and 0.17 ppm (wet weight), respectively. In contrast to cadmium and selenium, concentrations of mercury in freshwater fish tissue did not decline between 1976 and 1984 (Schmitt and Brumbaugh, 1990). Kidwell et al. (1995) conducted an analysis of mercury levels in bottom-feeding and predator fish using the 1984-1985 data from the NCBP study. These authors reported that the mean mercury tissue concentration (whole fish samples) of 0.12 ± 0.08 ppm in predator fish (e.g., trout, walleye, largemouth bass) was significantly higher than the mean tissue concentration of 0.08 ± 0.006 ppm in bottom feeders (e.g., carp, white sucker, and channel catfish).

Mercury, the only metal analyzed as part of the EPA National Study of Chemical Residues in Fish, was detected at 92 percent of 374 sites surveyed. Maximum,

arithmetic mean, and median concentrations in fish tissue were 1.77, 0.26, and 0.17 ppm (wet weight), respectively (U.S. EPA, 1991h, 1992c, 1992d). Bahnick et al. (1994) analyzed the NSCRF data by fish species and reported that mean mercury concentrations in bottom feeders (whole body samples) were generally lower than concentrations for predator fish (fillet samples). Carp, white sucker, and channel catfish (bottom feeders) had average tissue concentrations of 0.11, 0.11, and 0.09 ppm, respectively. Largemouth bass, smallmouth bass, and walleye (predator species) had average tissue concentrations of 0.46, 0.34, and 0.52 ppm, respectively (Bahnick et al., 1994). With regard to the source of the mercury contamination, Bahnick et al. (1994) reported that the highest mean concentration of mercury was detected in fish sampled near public treatment works (0.59 ppm); however, background sites and sites near wood preserving facilities exhibited the second (0.34 ppm) and third (0.31 ppm) highest mean mercury concentrations. The authors also reported that most of the higher tissue concentrations of mercury were detected in freshwater fish samples collected in the Northeast.

Recently, the northeastern states and eastern Canadian provinces issued their own mercury study, including a comprehensive analysis of mercury concentrations in a variety of freshwater sportfish (NESCAUM, 1998). This study involved a large number of sampling sites, including remote lake sites that did not receive point source discharges. Top-level piscivores (i.e., predator fish), such as walleye, chain pickerel, and large and smallmouth bass, were typically found to exhibit the highest concentrations, with mean tissue residues greater than 0.5 ppm and maximum residues exceeding 2 ppm. One largemouth bass sample was found to contain 8.94 ppm of mercury, while a smallmouth bass sampled contained 5 ppm. A summary of the range and the mean concentrations found in eight species of sportfish sampled is shown in Table 4-4 (NESCAUM, 1998).

Table 4-4. Total Mercury and Methylmercury Concentrations in Estuarine Fish from South Florida

Species	Mean mercury concentration ^a (ppm) and range	Mean methylmercury ^a concentration (ppm) and range
Hardhead catfish	1.94 (0.44-4.64)	1.54 (0.18-4.42)
Gafftopsail catfish	3.0 (0.76-10.10)	1.86 (0.72-4.50)
Sand seatrout	2.41 (2.21-2.61)	2.04 (1.60-2.47)
Sand seaperch	0.48 (0.40-0.54)	0.42 (0.40-0.49)
Pinfish	0.54 (0.32-1.06)	0.44 (0.20-0.90)
White grunt	0.49 (0.28-1.03)	0.49 (0.31-0.99)
Lane snapper	0.57 (0.22-1.03)	0.58 (0.19-1.27)
Spot	0.29 (0.11-0.43)	0.24 (0.06-0.40)

^aConcentrations are in ppm (µg/g) wet weight basis.

Source: Kannan et al., 1998.

EPA's Office of Water also recently published results of a national survey of mercury concentrations in fish (U.S. EPA, 1999d). This survey compiled state data on tissue residue levels of mercury in fish analyzed by 39 states between 1990 and 1995. The range of mean mercury concentrations (ppm) for the nine major fish species reported were as follows: largemouth bass, 0.001-8.94; smallmouth bass, 0.008-3.34; walleye, 0.008-3.0; northern pike, 0.10-4.4; channel catfish, 0.001-2.57; bluegill sunfish, 0.001-1.68; common carp, 0.001-1.8; white sucker, 0.002-1.71; and yellow perch, 0.01-2.14. All mercury concentrations used in the study were expressed on a wet weight and fillet basis. While the majority of the finfish sampled were freshwater species, some estuarine and marine species were also included; however, the report excluded all nonfish species such as turtles, molluscs, and crustaceans. Although comparison of data between states was difficult because of differences in sampling strategies (representative versus targeted), differences in analytical procedures, and the fact that mercury concentrations may vary with age of the fish, the analysis did indicate that both the magnitude and variability of mercury concentrations were greater in higher trophic level fish species.

Another recent study was conducted to assess total mercury and methylmercury concentrations in estuarine fish from south Florida coastal waters (Kannan et al., 1998). The authors reported that concentrations of total mercury in fish muscle tissue ranged between 0.03 and 2.22 ppm (mean: 0.31 ppm) (wet weight basis), with methylmercury contributing 83 percent of the total mercury. The mean concentrations and range of total mercury and methylmercury in muscle tissue of different species collected from south Florida's coastal waters are shown in Table 4-4.

In another study, methylmercury concentrations in muscle tissue of nine species of sharks were analyzed from four different locations along the coast of Florida (Hueter et al., 1995). Muscle tissue methylmercury concentrations averaged 0.88 ppm (wet weight) and ranged from 0.06 to 2.87 ppm, with 31 percent of the samples tested exceeding 1 ppm. A positive correlation was found between methylmercury concentration and the body length (size) of the shark, such that sharks larger than 2 m in total length contained methylmercury concentrations >1 ppm. Sharks collected off the southern and southwestern coastal areas contained significantly higher concentrations than those caught in the northeast coastal region (Cape Canaveral and north). Methylmercury concentrations were highest in the Caribbean reef shark (*Carcharhinus perezii*). The two most abundant shark species in the U.S. East Coast commercial shark fishery, the sandbar (*C. plumbeus*) and blacktip (*C. limbatus*) sharks, are of special public health concern. Although the mean methylmercury concentration in the sandbar shark (0.77 ppm) was below the average for all sharks, sandbar shark tissues contained up to 2.87 ppm methylmercury, and 20.9 percent of the sampled fish exceeded 1 ppm. Of more concern is that 71.4 percent of the blacktip shark samples (mean, 1.3 ppm) exceeded 1 ppm methylmercury. The authors suggest that continued monitoring of methylmercury concentrations in various shark species is warranted, since these fish are taken in both recreational and commercial fisheries. Similarly, on the West Coast, Fairey et al. (1997) reported

that the highest concentrations of mercury found in all of the fish species sampled as part of a fish monitoring effort in the San Francisco Bay and Estuary were detected in leopard shark muscle tissue (1.26 ppm wet weight basis).

In 1993, 898 fish advisories had been issued in 29 states as a result of mercury contamination (see Figure 4-1). In particular, mercury was included in a large number of the fish advisories in effect for lakes in Minnesota, Wisconsin, and Michigan and for rivers and lakes in Florida (RTI, 1993). As of 1998, 1,931 advisories had been issued in 40 states for this metal, and mercury is responsible for more than 68 percent of all fish advisories issued in the United States. In addition, 10 states have statewide advisories in effect for mercury in freshwater lakes and/or rivers and 5 Gulf Coast states have statewide mercury advisories in effect for their coastal marine waters (U.S. EPA, 1999c).

Because of its widespread occurrence in fish across the United States, mercury should be monitored in all state fish and shellfish contaminant monitoring programs at all stations. Only one national program reviewed by the 1993 Workgroup—EPA 301(h) monitoring program—recommended analyzing specifically for methylmercury; however, six programs recommended analyzing for total mercury (Appendix E). Because of the higher cost of methylmercury analysis two to three times greater than for total mercury analysis). EPA recommends that total mercury be determined in state fish contaminant monitoring programs and the conservative assumption be made that all mercury is present as methylmercury so as to be most protective of human health. It should be noted that Bache et al. (1971) analyzed methylmercury concentrations in lake trout of known ages and found that methylmercury concentration and the ratio of methylmercury to total mercury increased with age. Relative proportions of methylmercury in fish varied between 30 and 100 percent, with methylmercury concentrations lower than 80 percent occurring in fish 3 years of age or younger. Thus, when high concentrations of total mercury are detected, and if resources are sufficient, states may wish to repeat sampling and obtain more specific information on actual concentrations of methylmercury in various age or size classes of fish.

4.3.1.4 Selenium—

Selenium is a natural component of many soils, particularly in the west and southwest regions of the United States (NAS, 1991). It enters the environment primarily via emissions from oil and coal combustion (May and McKinney, 1981; Pillay et al., 1969). Selenium is an essential nutrient but is toxic to both humans and animals at high concentrations (NAS, 1991). Long-term adverse effects from ingestion by humans have not been studied thoroughly. EPA has determined that the evidence of carcinogenicity of selenium in both humans and animals is inadequate and, therefore, has assigned this metal a D carcinogenicity classification (IRIS, 1999).

Selenium is frequently detected in ground and surface waters in most regions of the United States and has been detected in marine fish and shellfish (NOAA,

4. TARGET ANALYTES

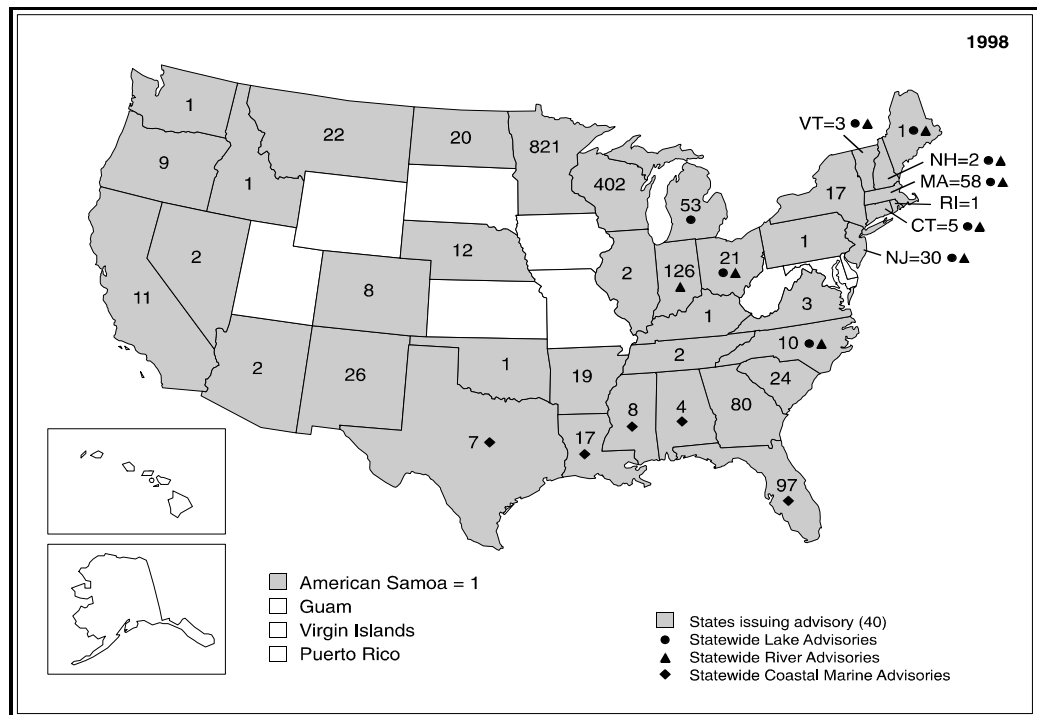
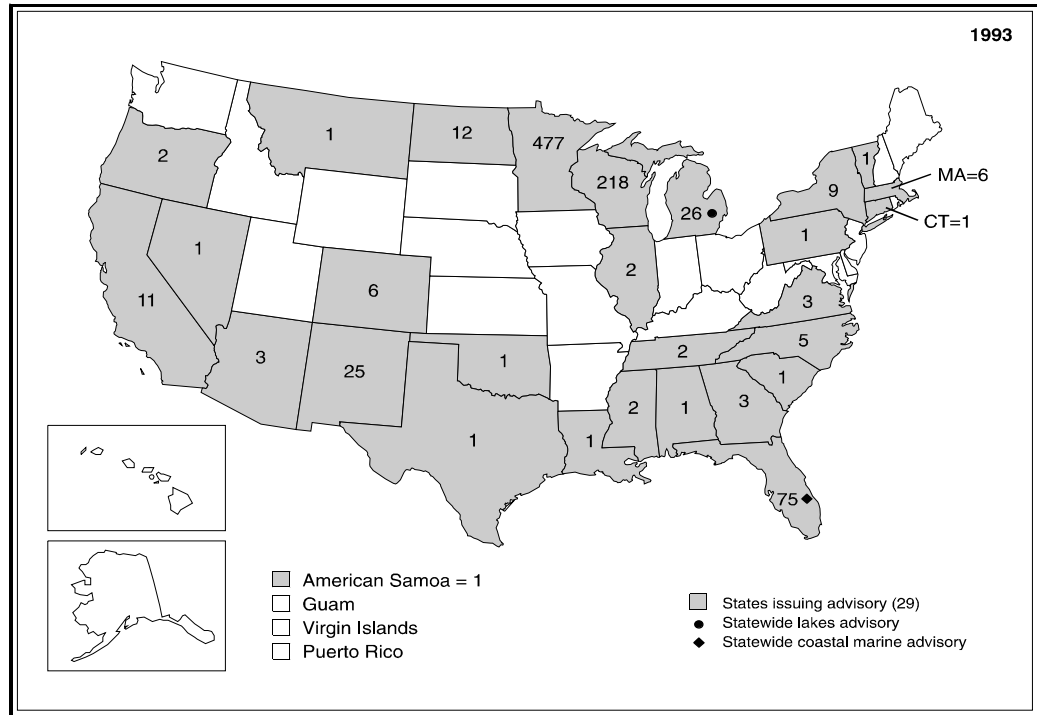

Figure 4-1. States issuing fish and shellfish advisories for mercury.

1987, 1989a) and in freshwater fish (Schmitt and Brumbaugh, 1990) from several areas nationwide. In 1984 and 1985, the U.S. Fish and Wildlife Service collected 315 composite samples of whole fish from 109 stations nationwide as part of the National Contaminant Biomonitoring Program (Schmitt and Brumbaugh, 1990). The authors reported the maximum, geometric mean, and 85th percentile concentrations for selenium were 2.30, 0.42, and 0.73 ppm (wet weight), respectively. Kidwell et al. (1995) conducted an analysis of selenium concentrations in bottom-feeding and predator fish using the 1984-1985 data from the NCBP study. Mean selenium tissue concentrations (whole fish samples) were not significantly different in bottom feeders (0.50 ± 0.41 ppm) as compared to predator fish (0.50 ± 0.42 ppm). Like cadmium, concentrations of selenium declined in fish tissues between 1976 and 1984 (Schmitt and Brumbaugh, 1990).

In a more recent study (May 1993 to January 1994), selenium concentrations in the tissues of fish from the Pigeon River and Pigeon Lake in Michigan were examined. Mean selenium concentrations in white sucker fillets were 0.49 ± 0.19 , 1.8 ± 0.96 , and 1.7 ± 0.80 ppm (wet weight) in samples taken from the Upper Pigeon River, Lower Pigeon River, and Pigeon Lake, respectively. At these same locations, northern pike fillets contained selenium concentrations of 0.88 ± 0.22 , 1.1 ± 0.91 , and 2.2 ± 0.90 ppm (wet weight), respectively (Besser et al., 1996). This study was conducted to assess the potential hazard of selenium leaching from a coal fly ash disposal area.

Selenium was monitored in four national fish contaminant monitoring programs reviewed by the EPA 1993 Workgroup (Appendix E). Definitive information concerning the chemical forms of selenium found in fish and shellfish is not available (NAS, 1976, 1991).

In 1993, five states (California, Colorado, North Carolina, Texas, and Utah) had issued advisories for selenium contamination in fish (RTI, 1993). As of 1998, there were 11 advisories in effect in these same five states for this heavy metal (U.S. EPA, 1999c). These advisories include one wildlife advisory in Nevada for selenium in several species of waterfowl. Selenium should be considered for inclusion in all state fish and shellfish monitoring programs in areas where it occurs in geologic formations (particularly in the western and southwestern states) and near sites where oil or coal combustion currently occurs or historically has occurred.

4.3.1.5 Tributyltin Compounds—

Tributyltin compounds belong to the organometallic family of tin compounds that have been used as biocides, disinfectants, and antifoulants. Antifoulant paints containing tributyltin compounds were first registered for use in the United States in the early 1960s (Appendix F). Tributyltin compounds are used in paints applied to boat and ship hulls as well as to crab pots, fishing nets, and buoys to retard the growth of fouling organisms. These compounds were also registered for use as wood preservatives, disinfectants, and biocides in cooling towers, pulp and paper mills, breweries, leather processing facilities, and textile mills (U.S. EPA, 1988c).

Tributyltin compounds are acutely toxic to aquatic organisms at concentrations below 1 ppb and are chronically toxic to aquatic organisms at concentrations as low as 0.002 ppb (U.S. EPA, 1988c). EPA initiated a Special Review of tributyltin compounds used as antifoulants in January of 1986 based on concerns over its adverse effects on nontarget aquatic species. Shortly thereafter the Organotin Antifouling Paint Control Act (OAPCA) was enacted in June 1988, which contained interim and permanent tributyltin use restrictions as well as environmental monitoring, research, and reporting requirements. The Act established interim release rate restrictions under which only tributyltin-containing products that do not exceed an average daily release rate of 4 micrograms organotin/cm²-d can be sold or used. The OAPCA also contained a permanent provision to prohibit the application of tributyltin antifouling paints to non-aluminum vessels under 25 meters (82 feet) long (U.S. EPA, 1988c).

Tributyltin oxide appears to be toxic to animals, with oral LD₅₀s ranging between 52 and 194 mg/kg (ATSDR, 1992; HSDB, 1999; WHO, 1999). Immunotoxicity is the critical effect produced by chronic exposure to tributyltin. Insufficient data are available to evaluate the carcinogenicity of tributyltin oxide compounds; therefore, EPA has listed this compound in Group D (Appendix G) (IRIS, 1999).

Tributyltins have been found to bioaccumulate in fish, bivalve mollusks, and crustaceans. Bioconcentration factors have been reported to range from 200 to 4,300 for finfish, from 2,000 to 6,000 for bivalves, and a BCF value of 4,400 was reported for crustaceans (U.S. EPA, 1988c). Tributyltin used to control marine fouling organisms in an aquaculture rearing pen has been found to bioaccumulate in fish tissue (Short and Thrower, 1987a and 1987b). Tsuda et al. (1988) reported a BCF value of 501 for tributyltin in carp (*Cyprinus carpio*) muscle tissue. Martin et al. (1989) reported a similar BCF value of 406 for tributyltin in rainbow trout (*Salmo gairdneri*) and Ward et al. (1981) reported a BCF value of 520 for the sheepshead minnow (*Cyprinodon variegatus*). In an environmental monitoring study conducted in England, a BCF value of 1,000 was reported for tributyltin in seed oysters (*Crassostrea gigas*) (Ebdon et al., 1989).

Tributyltin was not monitored in any national fish contaminant monitoring program evaluated by the EPA 1993 Workgroup (Appendix E). In 1993, only one state, Oregon, had an advisory in effect for tributyltin contamination in shellfish (RTI, 1993). As of 1998, there were no active fish advisories in effect for tributyltin, since the advisory in Oregon was rescinded (U.S. EPA, 1999c).

Tributyltin compounds should be considered for inclusion in all state fish and shellfish contaminant monitoring programs, particularly in states with coastal waters, states bordering the Great Lakes, or states with large rivers where large ocean-going vessels are used for commerce. Tributyltin concentrations have been reported to be highest in areas of heavy boating and shipping activities including shipyards, drydocks, and marinas where tributyltin-containing antifouling paints are often removed and reapplied. Before recoating, old paint containing tributyltin residues is scraped from the vessel hull and these paint scrapings are sometimes washed into the water adjacent to the boat or shipyard despite the tributyltin label

prohibiting this practice (U.S. EPA, 1988c). Tributyltin should be considered for inclusion in state fish and shellfish monitoring programs in areas where its use is or has been extensive. States should contact their appropriate agencies to obtain information on the historic and current uses of tributyltin, particularly with respect to its uses in antifouling paints and wood preservatives.

4.3.2 Organochlorine Pesticides

The following organochlorine pesticides and metabolites are recommended as target analytes in screening studies: total chlordane (sum of cis- and trans-chlordane, cis- and trans-nonachlor, and oxychlordane), total DDT (sum of 2,4'- and 4,4'-homologues of DDT, DDD, and DDE), dicofol, dieldrin, endosulfan I and II, endrin, heptachlor epoxide, hexachlorobenzene, lindane (γ -hexachlorocyclohexane), mirex, and toxaphene (see Appendix F). Mirex is of particular concern in the Great Lakes states and the southeast states (NAS, 1991). All of these compounds are neurotoxins and most are known or suspected human carcinogens (IRIS, 1999; Sax, 1984).

With the exception of endosulfan I and II, dicofol, and total DDT, each of the pesticides on the recommended target analyte list (Table 4-1) had been included in at least four major fish contaminant monitoring programs (Appendix E), and seven of the compounds had triggered at least one state fish consumption advisory in 1993 (Table 4-2). Although use of some of these pesticides has been terminated or suspended within the United States for over 25 years (Appendix F), these compounds still require long-term monitoring. Many of the organochlorine pesticides that are now banned were used in large quantities for over a decade and are still present in sediments at high concentrations. These organochlorine pesticides are not easily degraded or metabolized and, therefore, persist in the environment. These compounds are either insoluble or have relatively low solubility in water, but are quite lipid-soluble. Because these compounds are not readily metabolized or excreted from the body and are readily stored in fatty tissues, they can bioaccumulate to high concentrations through aquatic food chains to secondary consumers (e.g., fish, piscivorous birds, and mammals including humans).

Pesticides may enter aquatic ecosystems from point source industrial discharges or from nonpoint sources such as aerial drift and/or runoff from agricultural use areas, leaching from landfills, or accidental spills or releases. Agricultural runoff from crop and grazing lands is considered to be the major source of pesticides in water, with industrial waste (effluents) from pesticide manufacturing the next most common source (Li, 1975). Significant atmospheric transport of pesticides to aquatic ecosystems can also result from aerial drift of pesticides, volatilization from applications in terrestrial environments, and wind erosion of treated soil (Li, 1975). Once in water, pesticide residues may become adsorbed to suspended material, deposited in bottom sediment, or absorbed by organisms in which they are detoxified and eliminated or accumulated (Nimmo, 1985).

The reader should note that three of the organochlorine pesticides still have active registrations: endosulfan, lindane, and dicofol. These pesticides are much less persistent in the environment and have a lower bioaccumulation potential than the banned organochlorines. However, agricultural runoff particularly during the period immediately after field application could result in significant levels of these pesticides in fish and shellfish tissues. States should contact their appropriate state agencies to obtain information on both the historic and current uses of these pesticides.

4.3.2.1 Chlordane (Total)—

Chlordane is a multipurpose insecticide that has been used extensively in home and agricultural applications in the United States for the control of termites and many other insects (Appendix F). This pesticide is similar in chemical structure to dieldrin, although less toxic (Toxicity Class II), and has been classified as a probable human carcinogen (B2) by EPA (Appendix G) (IRIS, 1999; Worthing, 1991).

Although the last labeled use of chlordane as a termiticide was phased out in the United States beginning in 1975, it has been monitored in seven national fish contaminant programs evaluated by the EPA 1993 Workgroup (Appendix E) and has been widely detected in freshwater fish (Schmitt et al., 1990) and in both estuarine/marine finfish (NOAA, 1987) and marine bivalves (NOAA, 1989a) at concentrations of human health concern. In 1984 and 1985, the U.S. Fish and Wildlife Service collected 321 composite samples of whole fish from 112 stations nationwide as part of the National Contaminant Biomonitoring Program (Schmitt et al., 1990). These authors reported the maximum and geometric mean concentrations for the five major degradation products of chlordane (*cis*-chlordane, *trans*-chlordane, *cis*-nonachlor, *trans*-nonachlor, and oxychlordane) were 0.66 and 0.03 ppm, 0.35 and 0.02 ppm, 0.45 and 0.02 ppm, 1.00 and 0.30 ppm, and 0.29 and 0.01 ppm (wet weight), respectively. Kidwell et al. (1995) conducted an analysis of all 1984-1985 data from the NCBP study on the major constituents of chlordane (including *cis*- and *trans*-chlordane, *cis*- and *trans*-nonachlor, and oxychlordane) in bottom-feeding and predator fish species. The authors reported there was no significant difference in residues in these two trophic groups of fish except for concentrations of *trans*-chlordane, which were significantly higher in the tissues of bottom feeders. Mean tissue concentrations of *cis*- and *trans*-chlordane, *cis*- and *trans*-nonachlor, and oxychlordane were 0.03 ± 0.06 , 0.02 ± 0.04 , 0.02 ± 0.04 , 0.03 ± 0.01 , and 0.01 ± 0.02 ppm, respectively, for bottom feeders as compared to 0.02 ± 0.04 , 0.01 ± 0.02 , 0.02 ± 0.03 , 0.03 ± 0.06 , and 0.01 ± 0.01 ppm, respectively, for predator species (Kidwell et al., 1995).

The *cis*- and *trans*-isomers of chlordane and *cis*- and *trans*-isomers of nonachlor, which are primary constituents of technical-grade chlordane, and oxychlordane, the major metabolite of chlordane, were also monitored as part of the EPA National Study of Chemical Residues in Fish (U.S. EPA, 1992c, 1992d). These compounds were detected in fish tissue at the following percentage of the 362

sites surveyed: *cis*-chlordane (64 percent), *trans*-chlordane (61 percent), *cis*-nonachlor (35 percent), *trans*-nonachlor (77 percent), and oxychlordane (27 percent) (U.S. EPA, 1992c, 1992d). The maximum, arithmetic mean, and median concentrations (wet weight) of *cis*-chlordane, *trans*-chlordane, *cis*-nonachlor, *trans*-nonachlor, and oxychlordane are summarized in Table 4-5. Mean total chlordane residues from the NSCRF study were highest in bottom feeders such as carp (0.067 ppm), white sucker (0.018 ppm), and channel catfish (0.054 ppm) as compared to predator fish such as largemouth bass (0.029 ppm), smallmouth bass (0.004 ppb), and walleye (0.004 ppm) (Kuehl et al., 1994).

Table 4-5. Chlordane Constituent Concentrations^a Detected in the EPA National Study of Chemical Residues in Fish

Chlordane constituent or metabolite	Maximum	Arithmetic mean	Median
<i>cis</i> -Chlordane	0.378	0.021	0.004
<i>trans</i> -Chlordane	0.310	0.017	0.003
<i>cis</i> -Nonachlor	0.127	0.009	ND
<i>trans</i> -Nonachlor	0.477	0.031	0.009
Oxychlordane	0.243	0.005	ND

ND = Not detected.

^aConcentrations are in ppm (micrograms/g) on a wet weight basis.

Source: U.S. EPA, 1992c, 1992d.

In 1993, 120 fish advisories in 24 states had been issued as a result of chlordane contamination (see Figure 4-2). As of 1998, there were 104 advisories in effect in 22 states for this pesticide, and New York currently has a statewide advisory for chlordane in all waterfowl (U.S. EPA, 1999c). Because of its extensive use in termite control and its widespread detection in fish tissues, total chlordane (i.e., sum of *cis*- and *trans*-chlordane, *cis*- and *trans*-nonachlor, and oxychlordane) should be considered for inclusion in all state fish and shellfish contaminant monitoring programs (NAS, 1991). Monitoring sites in agricultural watersheds should be reviewed to determine the application rate and acreage where chlordane was used historically. In suburban/urban watersheds, the degree of historic use of chlordane as a termiticide around domestic structures should also be evaluated. Sites in industrial watersheds should be reviewed to identify historic sites of chlordane production, formulation, or packaging facilities.

4.3.2.2 DDT (Total)—

Although the use of DDT was terminated in the United States in 1972, DDT and its DDE and DDD metabolites persist in the environment and are known to bioaccumulate (Ware, 1978). DDT, DDD, and DDE have all been classified by EPA as probable human carcinogens (B2) (Appendix G) (IRIS, 1999).

DDT or its metabolites have been included as target analytes in as many as seven major fish and shellfish monitoring programs (Appendix E) and contamination has been found to be widespread (NOAA, 1987, 1989a; Schmitt et al., 1990). In 1984 and 1985, the U.S. Fish and Wildlife Service collected 321 composite samples of whole fish from 112 stations nationwide as part of the National Contaminant Biomonitoring Program (Schmitt et al., 1990). Maximum and geometric mean tissue concentrations of DDT, DDE, and DDD in 1984 were 1.79 and 0.03 ppm, 4.74 and 0.19 ppm, and 2.55 and 0.06 ppm (wet weight), respectively (Schmitt et al., 1990). Kidwell et al. (1995) conducted an analysis of all 1984-1985 data from the NCBP study on DDT and its major metabolites (DDE and DDD) in bottom-feeding and predator fish. The authors reported that there was no significant difference in residues in these two trophic groups of fish. Mean tissue concentrations of DDT, DDE, and DDD were 0.03 ± 0.14 , 0.21 ± 0.46 , and 0.07 ± 0.21 ppm for bottom feeders as compared to 0.03 ± 0.06 , 0.24 ± 0.55 , and 0.06 ± 0.14 ppm for predator species, respectively. DDE, the only DDT metabolite surveyed in fish tissue in the EPA National Study of Chemical Residues in Fish, was detected at more sites than any other single chemical pollutant (99 percent of the 362 sites sampled) (U.S. EPA, 1992c, 1992d). Maximum, arithmetic mean, and median concentrations of DDE were 14, 0.295, and 0.058 ppm (wet weight), respectively. Mean DDE residues from the NSCRF study were highest in bottom feeders such as carp (0.42 ppm), white sucker (0.08 ppm), and channel catfish (0.63 ppm) as compared to predator species such as largemouth bass (0.06 ppm), smallmouth bass (0.03 ppb), and walleye (0.03 ppm) (Kuehl et al., 1994). In 1993, eight states (Alabama, Arizona, California, Delaware, Massachusetts, Nebraska, New York, and Texas) and the territory of American Samoa had fish consumption advisories in effect for DDT or its metabolites (RTI, 1993). As of 1998, there were 34 advisories in effect in 11 states and the territory of American Samoa for DDT and/or one of its metabolites, DDE or DDD (U.S. EPA, 1999c). In addition, New York has a statewide DDT advisory in effect for mergansers. Because of the extensive national use of this compound and its widespread detection in fish tissues, total DDT (i.e., sum of the 4,4'- and 2,4'-homologues of DDT and of its metabolites, DDE and DDD) should be considered for inclusion in all state fish and shellfish contaminant monitoring programs. Monitoring sites in agricultural watersheds should be reviewed to determine the application rate and acreage where DDT was applied historically. In suburban/urban watersheds, the degree of historic use of DDT in domestic home and garden applications should be evaluated. Sites in industrial watersheds should be reviewed to identify historic sites of DDT production, formulation, or packaging facilities.

4.3.2.3 Dicofol—

Dicofol, one of the three organochlorine target analytes with an active registration, is a miticide/pesticide that was first registered for use in 1957. Currently, dicofol is used primarily on cotton, apples, and citrus crops, mostly in California and Florida (U.S. EPA, 1998c). Dicofol is considered a DDT analog based on its structure and activity (Hayes and Laws, 1991). In the past, dicofol often contained 9 to 15 percent DDT and its analogs. In 1989, EPA required that these contaminants constitute less than 0.1 percent of dicofol (HSDB, 1993).

Historically, dicofol has been used to control mites on cotton and citrus (60 percent), on apples (10 percent), on ornamental plants and turf (10 percent), and on a variety of other agricultural products (20 percent) including pears, apricots, and cherries (*Farm Chemical Handbook*, 1989), as a seed crop soil treatment, on vegetables (e.g., beans and corn), and on shade trees (U.S. EPA, 1992c, 1992d).

Dicofol is moderately toxic to laboratory rats and has been assigned to EPA Toxicity Class III based on an oral LD₅₀ of 587 mg/kg in rats (U.S. EPA, 1998d) (Appendix F). Technical-grade dicofol induced hepatocellular (liver) carcinomas in male mice; however, results were negative in female mice and in rats (NCI, 1978) and in a second 2-year feeding study in both sexes of rats (U.S. EPA, 1998d). EPA has classified dicofol as a possible human carcinogen (C) (Appendix G) (U.S. EPA, 1998c).

Dicofol was recommended for monitoring by the EPA Office of Water as part of the Assessment and Control of Bioconcentratable Contaminants in Surface Waters Program and has been included in two other national monitoring programs (see Appendix E). Experimental evidence indicates this compound bioaccumulates extensively in bluegill sunfish (BCF from 6,600 to 17,000) (U.S. EPA, 1993a).

In the EPA National Study of Chemical Residues in Fish, dicofol was detected at 16 percent of the 374 sites monitored (U.S. EPA, 1992c, 1992d). Maximum, arithmetic mean, and median dicofol concentrations (wet weight basis) were 0.074 ppm, 0.001 ppm, and ND (not detectable). Dicofol concentrations were greater than the quantification limit (0.0025 ppm) in samples from only 7 percent of the sites. Most of the sites where dicofol was detected were in agricultural areas where citrus and other fruits and vegetables are grown (U.S. EPA, 1992c, 1992d). It should be noted that this national study did not specifically target agricultural sites where this pesticide historically had been or currently was used. Dicofol residues in fish could be much higher if sampling were targeted for pesticide runoff, particularly during the period immediately after field application. Mean dicofol residues from the NSCRF study were highest in bottom feeders such as carp (0.88 ppm), white sucker (0.48 ppm), and channel catfish (0.59 ppm) as compared to predator species such as largemouth bass (0.20 ppm), smallmouth bass (not detected), and walleye (not detected) (Kuehl et al., 1994).

In 1993, however, no consumption advisories were in effect for dicofol (RTI, 1993). As of 1998, there were no advisories in effect for this pesticide (U.S. EPA, 1999c). Dicofol should be considered for inclusion in state fish and shellfish contaminant monitoring programs, in areas where its use is or has been extensive. States should contact their appropriate state agencies to obtain information on the historic and current uses of this pesticide. Monitoring sites in agricultural watersheds should be reviewed to determine the application rate and acreage where dicofol is currently used and was used historically. Sites in industrial watersheds should be reviewed to identify historic and current sites of dicofol production, formulation, or packaging facilities.

4.3.2.4 Dieldrin—

Dieldrin is a chlorinated cyclodiene that was widely used in the United States from 1950 to 1974 as a broad spectrum pesticide, primarily on termites and other soil-dwelling insects and on cotton, corn, and citrus crops. Because the toxicity of this persistent pesticide posed an imminent danger to human health, EPA banned the production and most major uses of dieldrin in 1974, and, in 1987, all uses of dieldrin were voluntarily canceled by industry (see Appendix F).

Dieldrin has been classified by EPA as a probable human carcinogen (B2) (Appendix G) (IRIS, 1999) and has been identified as a human neurotoxin (ATSDR, 1991). Dieldrin has been included in seven national monitoring programs (Appendix E) and has been detected nationwide in freshwater finfish (Schmitt et al., 1990) and estuarine/marine finfish and shellfish (NOAA, 1987, 1989a). Because it is a metabolite of aldrin, the environmental concentrations of dieldrin are a cumulative result of the historic use of both aldrin and dieldrin (Schmitt et al., 1990).

In 1984 and 1985, the U.S. Fish and Wildlife Service collected 321 composite samples of whole fish from 112 stations nationwide as part of the National Contaminant Biomonitoring Program. Maximum and geometric mean tissue concentrations of dieldrin in 1984 were 1.39 and 0.04 ppm (wet weight), respectively (Schmitt et al., 1990). Kidwell et al. (1995) conducted an analysis of all 1984-1985 data from the NCBP study on dieldrin in bottom-feeding and predator fish. These authors reported there was no significant difference in residues in these two trophic groups of fish. Mean tissue concentrations of dieldrin were 0.05 ± 0.14 ppm for bottom feeders as compared to 0.04 ± 0.10 ppm for predator species. Dieldrin was also detected in fish tissue at 60 percent of the 362 sites surveyed as part of the EPA National Survey of Chemical Residues in Fish (U.S. EPA, 1992c, 1992d). Maximum, arithmetic mean, and median concentrations of dieldrin in fish tissues were 0.450, 0.028, and 0.004 ppm (wet weight), respectively. Mean dieldrin residues from the NSCRF study were highest in bottom feeders such as carp (0.045 ppm), white sucker (0.023 ppm), and channel catfish (0.015 ppm) as compared to predator species such as largemouth bass (0.005 ppm), smallmouth bass (0.002 ppm), and walleye (0.002 ppm) (Kuehl et al., 1994).

In 1993, three states (Arizona, Illinois, and Nebraska) had issued advisories for dieldrin contamination in fish (RTI, 1993). As of 1998, there were 23 advisories in effect in six states (Arizona, California, Colorado, Hawaii, Nebraska, and Texas) for this pesticide (U.S. EPA, 1999c). Dieldrin should be considered for inclusion in all state fish and shellfish contaminant monitoring programs in areas where its use as well as the use of aldrin have been extensive. States should contact their appropriate state agencies to obtain information on the historic uses of these two pesticides. Monitoring sites in agricultural watersheds should be reviewed to determine the application rate and acreage where dieldrin and aldrin were applied since dieldrin is a degradation product of aldrin. In suburban/urban watersheds, the degree of historic use of dieldrin and aldrin in domestic home and garden

applications should be evaluated. Sites in industrial watersheds should be reviewed to identify historic sites of dieldrin and aldrin production, formulation, or packaging facilities.

4.3.2.5 Endosulfan—

Endosulfan is a chlorinated cyclodiene pesticide that is currently in wide use primarily as a noncontact insecticide for seed and soil treatments (Appendix F). Two stereohomologues (I and II) exist and exhibit approximately equal effectiveness and toxicity (Worthing, 1991).

Endosulfan is highly toxic to laboratory animals and has been assigned to EPA Toxicity Class I (U.S. EPA, 1998d). To date, no studies have been found concerning carcinogenicity in humans after oral exposure to endosulfan (ATSDR, 1998c). EPA has classified endosulfan as Group E, evidence of noncarcinogenicity for humans (U.S. EPA, 1999b).

Agricultural runoff is the primary source of this pesticide in aquatic ecosystems. Endosulfan has been shown to be highly toxic to fish and marine invertebrates and is readily absorbed in sediments. It therefore represents a potential hazard in the aquatic environment (Sittig, 1980). However, data are insufficient to assess nationwide endosulfan contamination (NAS, 1991). Endosulfan has been included in one national fish contaminant monitoring program—the U.S. EPA 301(h) Program—the (U.S. EPA 301(h) Program—evaluated by the 1993 EPA Workgroup (Appendix E); however, no information was located related to its concentrations in fish or shellfish tissue.

In 1993, no consumption advisories were in effect for endosulfan I or II (RTI, 1993). As of 1998, there were no advisories in effect for this pesticide (U.S. EPA, 1999c). Endosulfan I and II should be considered for inclusion in all state fish and shellfish contaminant monitoring programs in areas where its use is or has been extensive. States should contact their appropriate agencies to obtain information on the historic and current uses of this pesticide. Monitoring sites in agricultural watersheds should be reviewed to determine the application rate and acreage where endosulfan currently is used and was used historically. Sites in industrial watersheds should be reviewed to identify historic and current sites of endosulfan production, formulation, or packaging facilities.

4.3.2.6 Endrin—

Endrin is a chlorinated cyclodiene that historically was widely used as a broad spectrum pesticide. Endrin was first registered for use in the United States in 1951. However, recognition of its long-term persistence in soil and its high levels of mammalian toxicity led to restriction of its use beginning in 1964 and 1979 (U.S. EPA, 1980a; 44 FR 43632) and to final cancellation of its registration in 1984 (U.S. EPA, 1984a) (Appendix F).

Endrin is highly toxic to humans (EPA Toxicity Class I) (U.S. EPA, 1998d), with acute exposures affecting the central nervous system primarily (Sax, 1984). At present, evidence of both animal and human carcinogenicity of endrin is considered inadequate, and EPA has classified endrin in Group D, not classifiable as to human carcinogenicity insufficient information available (Appendix G) (IRIS, 1999).

Although endrin has been included in five national fish contaminant monitoring programs (Appendix E), it has not been found widely throughout the United States. In 1984 and 1985, the U.S. Fish and Wildlife Service collected 321 composite samples of whole fish from 112 stations nationwide as part of the National Contaminant Biomonitoring Program (Schmitt et al., 1990). Endrin was detected in freshwater fish at only 29 percent of 112 stations sampled in the NCBP study. Maximum and geometric mean tissue concentrations of endrin in 1984 were 0.22 and <0.01 ppm (wet weight), respectively (Schmitt et al. 1990). Endrin was also detected in freshwater and marine species at 11 percent of the 362 sites surveyed in the EPA National Study of Chemical Residues in Fish (U.S. EPA, 1992c, 1992d). Maximum, arithmetic mean, and median concentrations of endrin in fish tissues were 0.162 ppm, 0.002 ppm, and not detectable (wet weight), respectively. Mean endrin residues from the NSCRF study were highest in bottom feeders such as carp (0.0014 ppm), white sucker (0.0002 ppm), and channel catfish (0.009 ppm) as compared to predatory species such as largemouth bass (not detectable), smallmouth bass (not detectable), and walleye (not detectable) (Kuehl et al., 1994).

In 1993, no state had issued a fish advisory for endrin (RTI, 1993). As of 1998, there were no advisories in effect for this pesticide (U.S. EPA, 1999c). Endrin should be considered for inclusion in all state fish and shellfish contaminant monitoring programs in areas where its use has been extensive. States should contact their appropriate agencies to obtain information on the historic uses of this pesticide. Monitoring sites in agricultural watersheds should be reviewed to determine the application rate and acreage where endrin was used historically. Sites in industrial watersheds should be reviewed to identify historic sites of endrin production, formulation, or packaging facilities.

4.3.2.7 Heptachlor Epoxide—

Heptachlor epoxide is not a formulated pesticide but is a metabolic degradation product of the pesticides heptachlor and chlordane. It is also found as a contaminant in heptachlor and chlordane formulations (Appendix F). Heptachlor epoxide is also more toxic than either parent compound (ATSDR, 1993). Heptachlor has been used as a persistent, nonsystemic contact and ingested insecticide on soils (particularly for termite control) and seeds and as a household insecticide (Worthing, 1991). EPA suspended the major uses of heptachlor in 1978 (ATSDR, 1993). Acute exposures to high doses of heptachlor epoxide in humans can cause central nervous system effects (e.g., irritability, dizziness, muscle tremors, and convulsions (U.S. EPA, 1986c). In animals, liver, kidney, and blood disorders can occur (IRIS, 1999). Exposure to this compound

produced an increased incidence of liver carcinomas in rats and mice and hepatomas in female rats (IRIS, 1999). Heptachlor epoxide has been classified by EPA as a probable human carcinogen (B2) (Appendix G) (IRIS, 1999).

Heptachlor epoxide has been included in six national fish monitoring programs (Appendix E) and has been detected widely in freshwater finfish (Schmitt et al., 1990), but infrequently in bivalves and marine fish (NOAA, 1987, 1989a). In 1984 and 1985, the U.S. Fish and Wildlife Service collected 321 composite samples of whole fish from 112 stations nationwide as part of the National Contaminant Biomonitoring Program (Schmitt et al., 1990). Heptachlor epoxide was detected in freshwater fish at 49 percent of 112 stations sampled in the NCBP study. Maximum and geometric mean tissue concentrations of heptachlor epoxide in 1984 were 0.29 and 0.01 ppm (wet weight), respectively (Schmitt et al., 1990). Heptachlor epoxide also was detected in fish tissue at 16 percent of the 362 sites where it was surveyed in the EPA National Study of Chemical Residues in Fish (U.S. EPA, 1992c, 1992d). Maximum, arithmetic mean, and median concentrations of heptachlor epoxide were 0.063 ppm, 0.002 ppm, and not detectable (wet weight). It should be noted that one of the parent compounds, heptachlor was detected at only 2 percent of the 362 sites where it was surveyed at a maximum, arithmetic mean, and median concentration of 0.076, 0.0004 ppm, and not detectable, respectively. The five degradation products of chlordane were detected at from 27 to 77 percent of these same sites (see Section 4.3.2.1 for a discussion of chlordane). Mean heptachlor epoxide residues from the NSCRF study were highest in bottom feeders such as carp (0.004 ppm), white sucker (0.001 ppm), and channel catfish (0.0005 ppm) as compared to predator species such as largemouth bass (0.0003 ppm), smallmouth bass (0.00007 ppm), and walleye (0.0002 ppm) (Kuehl et al., 1994).

In 1993, only Nebraska had fish advisories for heptachlor epoxide contamination (RTI, 1993). As of 1998, there was only one advisory in effect, in Texas, for this pesticide degradation product (U.S. EPA, 1999c). Heptachlor epoxide should be considered for inclusion in all state fish and shellfish monitoring programs in areas where the use of heptachlor or chlordane have been extensive. States should contact their appropriate agencies to obtain information on the historic uses of these pesticides. Monitoring sites in agricultural watersheds should be reviewed to determine the application rate and acreage where heptachlor and chlordane were historically used since both of these pesticides degrade to heptachlor epoxide. In suburban/urban watersheds, the degree of historic use of heptachlor and chlordane in domestic home and garden applications should be evaluated. Sites in industrial watersheds also should be reviewed to identify historic sites of heptachlor and chlordane production, formulation, or packaging facilities.

4.3.2.8 Hexachlorobenzene—

Hexachlorobenzene is a fungicide that was widely used as a seed protectant in the United States until 1984 (Appendix F). The use of hexachlorobenzene and the presence of hexachlorobenzene residues in food are banned in many countries

including the United States (Worthing, 1991). Registration of hexachlorobenzene as a pesticide was voluntarily canceled in 1984 (Morris and Cabral, 1986).

The toxicity of this compound is minimal; it has been given an EPA toxicity classification of IV (i.e., oral LD₅₀ greater than 5,000 ppm in laboratory animals (U.S. EPA, 1998d). However, nursing infants are particularly susceptible to hexachlorobenzene poisoning as lactational transfer can increase infant tissue levels to two to five times maternal tissue levels (ATSDR, 1996). Hexachlorobenzene is a known animal carcinogen (ATSDR, 1996) and has been classified by EPA as a probable human carcinogen (B2) (Appendix G) (IRIS, 1999).

Of the chlorinated benzenes, hexachlorobenzene is the most widely monitored (Worthing, 1991). It was included as a target analyte in seven of the major monitoring programs reviewed by the 1993 Workgroup (Appendix E). In 1984 and 1985, the U.S. Fish and Wildlife Service collected 321 composite samples of whole fish from 112 stations nationwide as part of the National Contaminant Biomonitoring Program (Schmitt et al., 1990). Hexachlorobenzene was detected in freshwater fish at 19 percent of 112 stations sampled in the NCBP study. Maximum and geometric mean tissue concentrations of hexachlorobenzene in 1984 were 0.41 and <0.01 ppm (wet weight), respectively (Schmitt et al., 1990). Kidwell et al. (1995) conducted an analysis of all 1984-1985 data from the NCBP on hexachlorobenzene in bottom-feeding and predator fish. The authors reported that there was no significant difference in residues in these two trophic groups. Mean tissue concentrations of HCB were 0.00 ± 0.01 and 0.01 ± 0.04 ppm, respectively, for bottom feeders and predator species. Hexachlorobenzene also was detected in fish tissue at 46 percent of the 362 sites where it was surveyed in the EPA National Study of Chemical Residues in Fish (U.S. EPA, 1992c, 1992d). Maximum, arithmetic mean, and median concentrations were 0.913 ppm, 0.006 ppm, and not detectable (wet weight), respectively. Mean hexachlorobenzene residues from the NSCRF study were highest in bottom feeders such as carp (0.0036 ppm), white sucker (0.0036 ppm), and channel catfish (0.0024 ppm) as compared to predator species such as largemouth bass (0.0002 ppm), smallmouth bass (0.0004 ppm), and walleye (0.0001 ppm) (Kuehl et al., 1994).

In 1993, Louisiana and Ohio had issued advisories for hexachlorobenzene contamination in fish and shellfish (RTI, 1993). As of 1988, there were three advisories in effect in these two states for this pesticide (U.S. EPA, 1999c). Hexachlorobenzene should be considered for inclusion in all state fish and shellfish monitoring programs. Monitoring sites in agricultural watersheds should be reviewed to determine the application rate and acreage where hexachlorobenzene was historically used. Sites in industrial watersheds also should be reviewed to identify historic sites of hexachlorobenzene as well as other organochlorine pesticide production, formulation, or packaging facilities since hexachlorobenzene was used as an intermediate in the chemical synthesis of many organochlorine pesticides.

4.3.2.9 Lindane—

Lindane is a mixture of homologues of hexachlorocyclohexane (C₆H₆Cl₆), whose major component (≥99 percent) is the gamma isomer. It is commonly referred to as either γ-HCH (hexachlorocyclohexane) or γ-BHC (benzene hexachloride). Lindane is used primarily in seed treatments, soil treatments for tobacco transplants, foliage applications on fruit and nut trees and vegetables, and wood and timber protection. Lindane is used as a therapeutic scabicide, pediculicide, and ectoparasiticide for humans and animals (Merck Index 1989). Since 1985, many uses of lindane have been banned or restricted (see Appendix F) and its application is permitted only under supervision of a certified applicator (U.S. EPA, 1985c). In 1993, EPA issued a “Notice of Receipt of a Request for Amendments to Delete Uses” for several formulations of lindane provider, 99.5 percent technical, and dust concentrate, which would delete from the pesticide label most uses of lindane for agricultural crops and use on animals and humans (EPA 1993).

Lindane is a neurotoxin (assigned to EPA Toxicity Class II) (U.S. EPA, 1998d) and has been found to cause aplastic anemia in humans (Worthing, 1991). Lindane has been classified by EPA as a probable/possible human carcinogen (B2/C) (Appendix G) (U.S. EPA, 1999b).

Lindane has been included in seven major fish contaminant monitoring programs (Appendix E). This pesticide has been detected in freshwater fish (Schmitt et al., 1990) and in marine fish and bivalves (NOAA, 1987, 1989a) nationwide. In 1984 and 1985, the U.S. Fish and Wildlife Service collected 321 composite samples of whole fish from 112 stations nationwide as part of the National Contaminant Biomonitoring Program (Schmitt et al., 1990). Lindane was detected in freshwater fish at 47 percent of 112 stations sampled in the NCBP study. Maximum and geometric mean tissue concentrations of lindane in 1984 were 0.40 and <0.01 ppm (wet weight), respectively (Schmitt et al., 1990). Kidwell et al. (1995) conducted an analysis of all 1984-1985 data from the NCBP study on lindane in bottom-feeding and predator fish. These authors reported there was no significant difference in residues in these two trophic groups of fish. Lindane also was detected in fish tissue at 42 percent of 362 sites surveyed in the EPA National Study of Chemical Residues in Fish (U.S. EPA, 1992c, 1992d). Maximum, arithmetic mean, and median lindane concentrations were 0.083 ppm, 0.003 ppm, and not detectable (wet weight), respectively. Mean lindane residues from the NSCRF study were highest in bottom feeders such as carp (0.0043 ppm), white sucker (0.0017 ppm), and channel catfish (0.0032 ppm) as compared to predator species such as largemouth bass (0.00007 ppm), smallmouth bass (0.00015 ppm), and walleye (not detectable) (Kuehl et al., 1994).

In 1993, although it had been widely monitored and widely detected, no consumption advisories were in effect for lindane (RTI, 1993). As of 1998, there were no advisories in effect for this pesticide (U.S. EPA, 1999c). Lindane should be considered for inclusion in all state fish and shellfish monitoring programs in areas where its use has been extensive. States should contact their appropriate

agencies to obtain information on the historic and current uses of this pesticide. Monitoring sites in agricultural watersheds should be reviewed to determine the application rate and acreage where lindane was used historically. In suburban/urban watersheds, the degree of historic use of lindane in domestic home and garden applications should be evaluated. Sites in industrial watersheds should be reviewed to identify historic and current sites of lindane production, formulation, or packaging facilities.

4.3.2.10 Mirex—

Mirex is a chlorinated cyclodiene pesticide that was used in large quantities in the United States from 1962 through 1975 primarily for control of fire ants in the Southeast and Gulf Coast states and, more widely, under the name Dechlorane as a fire retardant and polymerizing agent in plastics (Kaiser, 1978; Kutz et al., 1985) (Appendix F).

Mirex has been assigned to EPA Toxicity Class II on the basis of an oral LD₅₀ in rats of 368 mg/kg (ATSDR, 1995; U.S. EPA, 1998d) (Appendix F). Mirex has been assigned a carcinogenicity classification of group B2, probable human carcinogen (HEAST, 1997). EPA instituted restrictions on the use of mirex in 1975, and, thereafter, the U.S. Department of Agriculture (USDA) suspended the fire ant control program (Hodges, 1977).

Mirex has been included in seven major fish contaminant monitoring programs (Appendix E). It has been found primarily in the Southeast, Gulf Coast, and the Great Lakes regions (Kutz et al., 1985; NAS, 1991; Schmitt et al., 1990). In 1984 and 1985, the U.S. Fish and Wildlife Service collected 321 composite samples of whole fish from 112 stations nationwide as part of the National Contaminant Biomonitoring Program (NCBP) (Schmitt et al., 1990). Mirex was detected in freshwater fish at 13 percent of 112 stations sampled in the NCBP study. Maximum and geometric mean tissue concentrations of mirex in 1984 were 0.44 and <0.01 ppm (wet weight), respectively (Schmitt et al., 1990). Kidwell et al. (1995) conducted an analysis of all 1984-1985 data from the NCBP study on mirex in bottom-feeding and predator fish. These authors reported there was no significant difference in residues in these two trophic groups of fish. Mean tissue concentrations of mirex were 0.00 ± 0.04 and 0.01 ± 0.05 ppm, respectively, for bottom feeders and predator species. Mirex also was detected in fish tissue at 38 percent of 362 sites surveyed in the EPA National Study of Chemical Residues in Fish (NSCRF) (U.S. EPA, 1992c, 1992d). Maximum, arithmetic mean, and median mirex concentrations were 0.225 ppm, 0.004 ppm, and not detectable (wet weight), respectively. Mean mirex residues from the EPA NSCRF study were highest in bottom feeders such as carp (0.0037 ppm), white sucker (0.0044 ppm), and channel catfish (0.0146 ppm) as compared to predator species such as largemouth bass (0.0002 ppm), smallmouth bass (0.002 ppm), and walleye (0.00008 ppm) (Kuehl et al., 1994).

In 1993, three states (New York, Ohio, and Pennsylvania) had issued fish advisories for mirex (RTI, 1993). As of 1998, there were 11 advisories in effect

in these same three states for this pesticide (U.S. EPA, 1999c). New York has a statewide advisory in effect for mergansers. Mirex should be considered for inclusion in all state fish and shellfish monitoring programs in areas where its use has been extensive. States should contact their appropriate agencies to obtain information on the historic uses of this pesticide. Monitoring sites in agricultural watersheds should be reviewed to determine the application rate and acreage where mirex was used historically. In suburban/urban watersheds, the degree of historic use of mirex in domestic home and garden applications should be evaluated. Sites in industrial watersheds should be reviewed to identify historic sites of mirex production, formulation, or packaging facilities.

4.3.2.11 Toxaphene—

Toxaphene is an organochlorine pesticide composed of a complex mixture of chlorinated camphenes (chlorinated bornanes and some bornenes) that was first registered for use in the United States in 1947. It was commercially produced by the chlorination of camphenes derived from pine trees. It has been estimated that the commercial mixture of toxaphene contained at least 670 congeners with the majority of these having 6 to 10 chlorines (Jansson and Wideqvist, 1983). Historically, this compound was used in the United States as an insecticide primarily on cotton (Hodges, 1977). In addition, toxaphene was used as a piscicide for rough fish in the 1950s and 1960s in North America and was the replacement for DDT after DDT's use was severely restricted in 1972 (Saleh, 1991). Partly as a consequence of the ban on the use of DDT imposed in 1972, toxaphene was for many years the most heavily used pesticide in the United States (Eichers et al., 1978). In 1982, toxaphene's registration for most uses was canceled (47 FR 53784) and all uses were banned in 1990 (55 FR 31164-31174). Toxaphene is a global pollutant whose chemical-physical properties make it a candidate for long-range atmospheric transport via the cold condensation effect once it is released into the environment (Wania and Mackay, 1993, 1996).

Like many of the other organochlorine pesticides, toxaphene has been assigned to EPA Toxicity Class II (U.S. EPA, 1998d) (Appendix F). Some components of toxaphene may accumulate in body fat. Toxaphene has been classified by EPA as a probable human carcinogen (B2) (Appendix G) (IRIS, 1999).

Toxaphene has been included in four major fish contaminant monitoring programs (Appendix E). It has been detected frequently in both freshwater fish (Schmitt et al., 1990) and estuarine species (NOAA, 1989a) but is only consistently found in Georgia, Texas, and California (NAS, 1991). In 1984 and 1985, the U.S. Fish and Wildlife Service collected 321 composite samples of whole fish from 112 stations nationwide as part of the National Contaminant Biomonitoring Program (Schmitt et al., 1990). Toxaphene was detected in freshwater fish at 69 percent of 112 stations sampled in the NCBP study. Maximum and geometric mean tissue concentrations of toxaphene in 1984 were 8.2 and 0.14 ppm (wet weight), respectively (Schmitt et al., 1990). Kidwell et al. (1995) conducted an analysis of all 1984-1985 data from the NCBP study on toxaphene in bottom-feeding and predatory fish species. These authors reported there was no significant difference

in residues in these two trophic groups of fish. Mean tissue concentrations of toxaphene were 0.19 ± 0.63 and 0.17 ± 0.35 ppm, respectively, for bottom feeders and predator species.

In 1993, two states (Arizona and Texas) had fish advisories in effect for toxaphene (RTI, 1993). As of 1988, there were six advisories in effect in four states (Arizona, Georgia, Oklahoma, and Texas) for this pesticide (U.S. EPA, 1999c). Toxaphene should be considered for inclusion in all state fish and shellfish monitoring programs in areas where its use has been extensive. States should contact their appropriate agencies to obtain information on the historic uses of this pesticide. Monitoring sites in agricultural watersheds should be reviewed to determine the application rate and acreage where toxaphene was used historically. Sites in industrial watersheds should be reviewed to identify historic sites of toxaphene production, formulation, or packaging facilities.

4.3.3 Organophosphate Pesticides

The following organophosphate pesticides are recommended as target analytes in screening studies: chlorpyrifos, diazinon, disulfoton, ethion, and terbufos (Appendix E). These pesticides share two distinct features that differentiate them from the organochlorines. Organophosphate pesticides are generally more acutely toxic to vertebrates than organochlorine pesticides and exert their toxic action by inhibiting the activity of cholinesterase (ChE), one of the vital nervous system enzymes. In addition, organophosphates are chemically unstable (they are all slowly hydrolyzed by water) and thus are less persistent in the environment. It is this latter feature that made them attractive alternatives to the organochlorine pesticides that were used extensively in agriculture from the 1940s to the early 1970s.

With the exception of chlorpyrifos, none of the organophosphates has been included in any of the national fish contaminant monitoring programs evaluated by the EPA 1993 Workgroup and none of these pesticides (including chlorpyrifos) has triggered state fish consumption advisories. All of the organophosphate pesticides have active pesticide registrations and have been recommended for monitoring because they have an EPA Toxicity Classification of I or II (Appendix F), BCFs >300, and a half-life of 30 days or more in the environment and their use profiles suggest they could be potential problems in some agricultural watersheds.

The target organophosphates are used in agriculture throughout the United States, particularly in areas under intensive cultivation (row crops, orchards, fruits, and vegetables). Bioconcentration studies indicate they can accumulate in fish and, because they are known human neurotoxins, the potential exists for human health effects from consuming contaminated fish. For this reason, federal regulations are in effect that set maximum application rates and minimize use near waterbodies. At the time of this writing, no fish consumption advisories for these target analytes have yet been issued; however, state agencies should be aware of special circumstances that could result in their accumulation in fish. In

addition to chemical spills and misapplications, heavy and repeated rainfall shortly after application may wash pesticides off of plants and into streams. Signs of acute organophosphate pollution may include erratic swimming behavior in fish or fish kills.

States should contact their appropriate agencies to obtain information on both the historic and current uses of these pesticides. With the exception of ethion, which is used almost exclusively on citrus, the target organophosphates are used on a wide variety of crops. In addition, chlorpyrifos and diazinon have significant uses in domestic and commercial pest control in suburban/urban areas (Robinson et al., 1994). If a state determines that high concentrations of these pesticides may be present in its agricultural watersheds, sampling should be conducted during late spring or early summer within 1 to 2 months following pesticide application to maximize detection of these compounds in fish tissues. In general, the organophosphates are degraded relatively rapidly in the environment and metabolized relatively rapidly by fish, so timing of the sampling program is a more important consideration for this class of pesticides. Additional discussion of appropriate sampling times for fish contaminant monitoring programs is provided in Section 6.1.1.5.

All of the target organophosphates are members of the organothiophosphate group of insecticides. They are all metabolized in the liver to their active form, referred to as an "oxon" (e.g., chlorpyrifos is activated to chlorpyrifos oxon) (Klaasen, 1996). The oxons are approximately 300- to 1,000-fold more toxic than the parent compounds; however, they are also less lipid-soluble than the parent compounds and, therefore, are expected to be less likely to bioaccumulate in fish tissue. In another laboratory study where chlorpyrifos was fed to channel catfish, only chlorpyrifos and its inactive metabolites were found; the oxon was not detected in any tissue (Barron et al., 1991). No information is available on the presence of the oxon metabolites in fish tissue for the other organophosphates.

Note: The potential human toxicity of the organophosphates is undergoing reassessment by EPA at this time as a result of the provisions of the Food Quality Protection Act of 1996. For more information, consult the EPA Office of Pesticide Programs webpage available on the Internet at:

<http://www.epa.gov.pesticides/op>.

4.3.3.1 Chlorpyrifos—

This organophosphate pesticide was first introduced in 1965 to replace the more persistent organochlorine pesticides (e.g., DDT) (U.S. EPA, 1986c) and has been used for a broad range of insecticide applications (Appendix F). Chlorpyrifos is used primarily to control soil and foliar insects on cotton, peanuts, and sorghum (Worthing, 1991; U.S. EPA, 1986c). Chlorpyrifos is also used to control root-infesting and boring insects on a variety of fruits (e.g., apples, bananas, citrus, grapes), nuts (e.g., almonds, walnuts), vegetables (e.g., beans, broccoli, brussel sprouts, cabbage, cauliflower, peas, and soybeans), and field crops (e.g., alfalfa and corn) (U.S. EPA, 1984c). As a household insecticide, chlorpyrifos has been

used to control ants, cockroaches, fleas, and mosquitoes (Worthing, 1991) and is registered for use in controlling subsurface termites in California (U.S. EPA, 1983a). Based on use application, 48 percent of chlorpyrifos use is agricultural and 52 percent is nonagricultural (U.S. EPA, 2000b). Chlorpyrifos is also used by the general public for home, lawn, and garden insect control (ATSDR, 1997).

Note: As a result of the reassessment conducted under the Food Quality Act of 1996, use patterns of chlorpyrifos will change significantly by the end of 2001. In particular, virtually all indoor and outdoor residential use will end, as well as all agricultural use on tomatoes. Agricultural use of chlorpyrifos on apples and grapes will be reduced substantially (U.S. EPA, 2000b).

Chlorpyrifos has a moderate mammalian toxicity and has been assigned to EPA Toxicity Class II based on oral feeding studies (U.S. EPA, 1998d). No carcinogenicity was found in chronic feeding studies with rats, mice, and dogs (U.S. EPA, 1983a). Because chlorpyrifos did not increase the incidence of cancer in feeding studies on rats and mice (U.S. EPA, 1999b, U.S. EPA, 2000b) EPA has classified chlorpyrifos in Group E (Appendix G) (U.S. EPA, 2000b). Experimental evidence indicates this compound bioaccumulates in rainbow trout (BCF from 1,280 to 3,903) (U.S. EPA, 1993a).

Chlorpyrifos has been included in one national monitoring program reviewed by the EPA 1993 Workgroup, the EPA National Study of Chemical Residues in Fish (NSCRF) (see Appendix E). In this study, chlorpyrifos was detected at 26 percent of sites sampled nationally (U.S. EPA, 1992c, 1992d). Eighteen percent of the sites with relatively high concentrations (0.0025 to 0.344 ppm) were scattered throughout the East, Midwest, and in California; the highest mean concentrations detected (0.060 to 0.344 ppm) were found either in agricultural areas or in urban areas with a variety of nearby industrial sources. Maximum, arithmetic mean, and median tissue concentrations (wet weight) of chlorpyrifos were 0.344 ppm, 0.004 ppm, and not detectable, respectively. Mean chlorpyrifos residues from the NSCRF study were highest in bottom feeders such as carp (0.0082 ppm), white sucker (0.0018 ppm), and channel catfish (0.007 ppm) as compared to predator species such as largemouth bass (0.00028 ppm), smallmouth bass (0.00008 ppm), and walleye (0.00004 ppm) (Kuehl et al., 1994). It should be noted that this national study did not specifically target agricultural sites where this pesticide historically had been used or is currently used. Chlorpyrifos residues in fish could be much higher if sampling were targeted for pesticide runoff, especially during the period immediately after field application.

In 1993, no consumption advisories were in effect for chlorpyrifos (RTI, 1993). As of 1998, there were no advisories in effect for this pesticide (U.S. EPA, 1999c). Chlorpyrifos should be considered for inclusion in state fish and shellfish contaminant monitoring programs in areas where its use is or has been extensive. States should contact their appropriate agencies to obtain information on the historic and current uses of this pesticide. Monitoring sites in agricultural watersheds should be reviewed to determine the application rate and acreage where chlorpyrifos is currently used or was used historically. In suburban/urban water-

sheds, the degree of historic and current use of chlorpyrifos in domestic home and garden applications should be evaluated. Sites in industrial watersheds also should be reviewed to identify historic and current sites of chlorpyrifos production, formulation, or packaging facilities.

4.3.3.2 Diazinon—

Diazinon is a phosphorothiate insecticide and nematicide that was first registered in 1952 for control of soil insects and pests of fruits, vegetables, tobacco, forage, field crops, range, pasture, grasslands, and ornamentals; for control of cockroaches and other household insects; for control of grubs and nematodes in turf; as a seed treatment; and for fly control (U.S. EPA, 1986d). Diazinon is also used by the general public for home, lawn, and garden insect control (Appendix F) (ATSDR, 1996).

Diazinon is moderately toxic to mammals and has been assigned to EPA Toxicity Class II based on oral toxicity tests (U.S. EPA, 1998d) (Appendix F). Diazinon was not found to be carcinogenic in rats and mice (ATSDR, 1996). Because of inadequate evidence of carcinogenicity, EPA has classified diazinon as “not likely to be a human carcinogen” (Appendix G) (U.S. EPA, 1998d). This compound is also highly toxic to birds, fish, and other aquatic invertebrates (U.S. EPA, 1986d).

Diazinon was not included in any national fish contaminant monitoring program evaluated by the EPA 1993 Workgroup (Appendix E). Experimental evidence indicates this compound accumulates in trout (BCF of 542) (U.S. EPA, 1993a).

In 1993, no consumption advisories were in effect for diazinon (RTI, 1993). As of 1998, there were no advisories in effect for this pesticide (U.S. EPA, 1999c). Diazinon should be considered for inclusion in state fish and shellfish contaminant monitoring programs in areas where its use is or has been extensive. States should contact their appropriate agencies to obtain information on the historic and current uses of this pesticide. Monitoring sites in agricultural watersheds should be reviewed to determine the application rate and acreage where diazinon is currently used or was used historically. In suburban/urban watersheds, the degree of historic and current use of diazinon in domestic home and garden applications should be evaluated. Sites in industrial watersheds should be reviewed to identify historic and current sites of diazinon production, formulation, or packaging facilities.

4.3.3.3 Disulfoton—

Disulfoton is a multipurpose systemic insecticide and acaricide first registered in 1958 for use as a side dressing, broadcast, or foliar spray in the seed furrow to control many insect and mite species and as a seed treatment for sucking insects (Appendix F) (*Farm Chemicals Handbook*, 1989).

Disulfoton is highly toxic to all mammalian systems and has been assigned to EPA Toxicity Class I on the basis of all routes of exposure (U.S. EPA, 1998d).

Disulfoton was not found to be carcinogenic in dogs, rats, or mice (ATSDR, 1995). Because of inadequate evidence of carcinogenicity, EPA has classified disulfoton as Group E, evidence of noncarcinogenicity for humans (Appendix G) (U.S. EPA, 1999b).

Disulfoton was not included in any national fish contaminant monitoring program evaluated by the EPA 1993 Workgroup (Appendix E). Experimental evidence indicates this compound accumulates in fish (BCF from 460 to 700) (U.S. EPA, 1993a).

In 1993, no consumption advisories were in effect for disulfoton (RTI, 1993). As of 1998, there were no advisories in effect for this pesticide (U.S. EPA, 1999c). Disulfoton should be considered for inclusion in state fish and shellfish contaminant monitoring programs in areas where its use is or has been extensive. States should contact their appropriate agencies to obtain information on the historic and current uses of this pesticide. Monitoring sites in agricultural watersheds should be reviewed to determine the application rate and acreage where disulfoton currently is used or was used historically. Sites in industrial watersheds also should be reviewed to identify historic and current sites of disulfoton production, formulation, or packaging facilities.

4.3.3.4 Ethion—

Ethion is a multipurpose insecticide and acaricide that has been registered since 1965 for use on a wide variety of nonfood crops (turf, evergreen plantings, and ornamentals), food crops (seed, fruit, nut, fiber, grain, forage, and vegetables), and for domestic outdoor uses around dwellings and for lawns (Appendix F) (*Farm Chemicals Handbook*, 1989). Application to citrus crops accounts for 86 to 89 percent of the ethion used in the United States. The remaining 11 to 14 percent is applied to cotton and a variety of fruit and nut trees and vegetables. Approximately 55 to 70 percent of all domestically produced citrus fruits are treated with ethion (U.S. EPA, 1989e).

Acute oral toxicity studies have shown that technical-grade ethion is moderately toxic to mammals (EPA Toxicity Class II) (U.S. EPA, 1998d). Ethion was not found to be carcinogenic in rats and mice (U.S. EPA, 1989e). EPA has classified ethion in Group E—evidence of noncarcinogenicity for humans (Appendix G) (U.S. EPA, 1999b).

Ethion was not included in any national fish contaminant monitoring program evaluated by the EPA 1993 Workgroup (Appendix E). Experimental evidence indicates this compound accumulates in bluegill sunfish (BCF from 880 to 2,400) (U.S. EPA, 1993a).

In 1993, no consumption advisories were in effect for ethion (RTI, 1993). As of 1998, there were no advisories in effect for this pesticide (U.S. EPA, 1999c). Ethion should be considered for inclusion in state fish and shellfish contaminant monitoring programs in areas where its use is or has been extensive. States

should contact their appropriate agencies to obtain information on the historic and current uses of this pesticide. Monitoring sites in agricultural watersheds should be reviewed to determine the application rate and acreage where ethion currently is used or was used historically. In suburban/urban watersheds, the degree of historic and current use of ethion in domestic home and garden applications should be evaluated. Sites in industrial watersheds also should be reviewed to identify historic and current sites of ethion production, formulation, or packaging facilities.

4.3.3.5 Terbufos—

Terbufos is a systemic organophosphate insecticide and nematicide registered in 1974 principally for use on corn, sugar beets, and grain sorghum. The primary method of application involves direct soil incorporation of a granular formulation (*Farm Chemicals Handbook*, 1989). Two soil metabolites of terbufos, terbufos sulfoxide and terbufos sulfone, are also toxic to humans and are found at sites where terbufos has been applied (U.S. EPA, 1995)

Terbufos is highly toxic to humans and has been assigned to EPA Toxicity Class I (U.S. EPA, 1998d) (Appendix F). Terbufos was not found to be carcinogenic in rats and mice (U.S. EPA, 1995j). EPA has assigned terbufos to carcinogenicity classification E, evidence of noncarcinogenicity for humans (U.S. EPA, 1998d) (Appendix G). Terbufos is also highly toxic to birds, fish, and other aquatic invertebrates (U.S. EPA, 1985d).

Terbufos was not included in any national fish contaminant monitoring program evaluated by the EPA 1993 Workgroup (Appendix E). Experimental evidence indicates this compound accumulates in fish (BCF from 320 to 1,400) (U.S. EPA, 1993a).

In 1993, no consumption advisories were in effect for terbufos (RTI, 1993). As of 1998, there were no advisories in effect for this pesticide (U.S. EPA, 1999c). Terbufos and its toxic metabolites should be considered for inclusion in state fish and shellfish contaminant monitoring programs in areas where its use is or has been extensive. States should contact their appropriate agencies to obtain information on the historic and current uses of this pesticide. Monitoring sites in agricultural watersheds should be reviewed to determine the application rate and acreage where terbufos currently is used or was used historically. Sites in industrial watersheds also should be reviewed to identify historic and current sites of terbufos production, formulation, or packaging facilities.

4.3.4 Chlorophenoxy Herbicides

Chlorophenoxy herbicides, which include oxyfluorfen, are nonselective foliar herbicides that are most effective in hot weather (Ware, 1978).

4.3.4.1 Oxyfluorfen—

Oxyfluorfen is a pre- and postemergence herbicide with an active registration that has been registered since 1979 for use to control a wide spectrum of annual broadleaf weeds and grasses in apples, artichokes, corn, cotton, jojoba, tree fruits, grapes, nuts, soybeans, spearmint, peppermint, and certain tropical plantation and ornamental crops (Appendix F) (*Farm Chemicals Handbook*, 1989).

Oxyfluorfen is of low toxicity to mammals (oral LD₅₀ in rats >5,000 mg/kg) and has been assigned to EPA Toxicity Class IV (U.S. EPA, 1998d) (Hayes and Lawes, 1991). There is also evidence of carcinogenicity (liver tumors) in mice (U.S. EPA, 1993a) and therefore oxyfluorfen has been classified by EPA as a possible human carcinogen (C) (Appendix G) (U.S. EPA, 1999b).

Oxyfluorfen was not included in any national fish contaminant monitoring program evaluated by the EPA 1993 Workgroup (Appendix E). Experimental evidence indicates this herbicide accumulates in bluegill sunfish (BCF from 640 to 1,800) (U.S. EPA, 1993a).

In 1993, no consumption advisories were in effect for oxyfluorfen (RTI, 1993). As of 1998, there were no advisories in effect for this herbicide (U.S. EPA, 1999c). Oxyfluorfen should be considered for inclusion in state fish and shellfish contaminant monitoring programs in areas where its use is or has been extensive. States should contact their appropriate agencies to obtain information on the historic and current uses of this pesticide. Monitoring sites in agricultural watersheds should be reviewed to determine the application rate and acreage where oxyfluorfen currently is used or was used historically. Sites in industrial watersheds also should be reviewed to identify historic and current sites of oxyfluorfen production, formulation, or packaging facilities.

4.3.5 Polycyclic Aromatic Hydrocarbons

PAHs are base/neutral organic compounds that have a fused ring structure of two or more benzene rings. PAHs are also commonly referred to as polynuclear aromatic hydrocarbons (PNAs). PAHs with two to five benzene rings (i.e., 10 to 24 skeletal carbons) are generally of greatest concern for environmental and human health effects (Benkert, 1992). These PAHs have been identified as the most important with regard to human exposure (ATSDR, 1995):

- Acenaphthene
- Acenaphthylene
- Anthracene
- Benz[*a*]anthracene
- Benzo[*a*]pyrene
- Benzo[*e*]pyrene
- Benzo[*b*]fluoranthene
- Benzo[*k*]fluoranthene
- Benzo[*j*]fluoranthene
- Benzo[*g,h,i*]perylene
- Chrysene
- Dibenz[*a,h*]anthracene
- Fluoranthene
- Fluorene
- Indeno[*1,2,3-cd*]pyrene
- Phenanthrene

- Pyrene.

The metabolites of many of the high-molecular-weight PAHs (e.g., benz[*a*]anthracene, benzo[*a*]pyrene, benzo[*b*]fluoranthene, benzo[*k*]fluoranthene, chrysene, dibenz[*a,h*]anthracene, indeno[1,2,3-*cd*]pyrene, and benzo[*g,h,i*]perylene) have been shown in laboratory test systems to be carcinogens, cocarcinogens, teratogens, and/or mutagens (Moore and Ramamoorthy, 1984; ATSDR 1995). Benzo[*a*]pyrene, one of the most widely occurring and potent PAHs, and six other PAHs (e.g., benz[*a*]anthracene, benzo[*b*]fluoranthene, benzo[*k*]fluoranthene, chrysene, dibenz[*a,h*]anthracene, indeno[1,2,3-*cd*]pyrene) have been classified by EPA as probable human carcinogens (B2) (IRIS, 1999). Evidence for the carcinogenicity of PAHs in humans comes primarily from epidemiologic studies that have shown an increased mortality due to lung cancer in humans exposed to PAH-containing coke oven emissions, roof-tar emissions, and cigarette smoke (ATSDR, 1995).

PAHs are ubiquitous in the environment and usually occur as complex mixtures with other toxic chemicals. They are components of crude and refined petroleum products and of coal. They are also produced by the incomplete combustion of organic materials. Many domestic and industrial activities involve pyrosynthesis of PAHs, which may be released into the environment in airborne particulates or in solid (ash) or liquid byproducts of the pyrolytic process. Domestic activities that produce PAHs include cigarette smoking, home heating with wood or fossil fuels, waste incineration, broiling and smoking foods, and use of internal combustion engines. Industrial activities that produce PAHs include wood preserving, coal coking; production of carbon blacks, creosote, and coal tar; petroleum refining; synfuel production from coal; and use of Soderberg electrodes in aluminum smelters and ferrosilicum and iron works (ATSDR, 1995; Neff, 1985). Historic coal gasification sites have also been identified as significant sources of PAH contamination (ATSDR, 1995).

Major sources of PAHs found in marine and fresh waters include biosynthesis (restricted to anoxic sediments), spillage and seepage of fossil fuels, discharge of domestic and industrial wastes, atmospheric deposition, and runoff (Neff, 1985). Urban stormwater runoff contains PAHs from leaching of asphalt roads, wearing of tires, deposition from automobile exhaust, and oiling of roadsides and unpaved roadways with crankcase oil (ATSDR, 1995; MacKenzie and Hunter, 1979). Solid PAH-containing residues from activated sludge treatment facilities have been disposed of in landfills or in the ocean (ocean dumping was banned in 1989). Although liquid domestic sewage contains <1 µg/L total PAH, the total PAH content of industrial sewage is 5 to 15 µg/L (Borneff and Kunte, 1965) and that of sewage sludge is 1 to 30 mg/kg (Grimmer et al., 1978; Nicholls et al., 1979).

In most cases, there is a direct relationship between PAH concentrations in river water and the degree of industrialization and human activity in the surrounding watersheds. Rivers flowing through heavily industrialized areas may contain 1 to

5 ppb total PAH, compared to unpolluted river water, ground water, or seawater that usually contains less than 0.1 ppb PAH (Neff, 1979).

PAHs can accumulate in aquatic organisms from water, sediments, and food. BCFs of PAHs in fish, crustaceans, and bivalves have frequently been reported to be in the range of 12 to 9,200 for fish, 200 to 134,248 for crustaceans, and 8 to 242 for bivalves based on short-term exposure studies typically less than 7 days duration (Eisler, 1987). In general, bioconcentration was greater for the higher molecular weight PAHs than for the lower molecular weight PAHs. Biotransformation by the mixed function oxidase system in the fish liver can result in the formation of carcinogenic and mutagenic intermediates, and exposure to PAHs has been linked to the development of tumors in fish (Eisler, 1987). The ability of fish to metabolize PAHs probably explains why benzo[a]pyrene frequently is not detected or is found only at very low concentrations in fish from areas heavily contaminated with PAHs (Varanasi and Gmur, 1980, 1981).

Sediment-associated PAHs can be accumulated by bottom-dwelling invertebrates and fish (Eisler, 1987). For example, Great Lakes sediments containing elevated levels of PAHs were reported by Eadie et al. (1983) to be the source of the body burdens of the compounds in bottom-dwelling invertebrates. Similarly, Varanasi et al. (1985) found that benzo[a]pyrene was accumulated in fish, amphipod crustaceans, shrimp, and clams when estuarine sediment was the source of the compound. Approximate tissue-to-sediment ratios were 0.6 to 1.2 for amphipods, 0.1 for clams, and 0.05 for fish and shrimp. Although fish and most crustaceans evaluated to date have the mixed function oxidase system required for biotransformation of PAHs, many molluscs lack this system and are unable to metabolize PAHs efficiently (Varanasi et al., 1985). More important, PAHs induce mixed function oxidase enzymes (and thus their own biotransformation) in fish and other vertebrates, but not in molluscs and crustaceans (Stegeman and Lech, 1991). The resulting dramatic difference in biotransformation means that in PAH-contaminated waters, fish may show little or no accumulation of PAHs, while bivalve molluscs and crustaceans are heavily contaminated. Varanasi et al. (1985) ranked benzo[a]pyrene metabolism by aquatic organisms as follows: fish > shrimp > amphipod crustaceans > clams. Half-lives for elimination of PAHs in fish ranged from less than 2 days to 9 days (Niimi, 1987). NAS (1991) reported that PAH contamination in bivalves has been found in all areas of the United States. If PAHs are selected as a target analyte to be monitored at a site, primary preference should be given to selection of a bivalve mollusc (clam, oyster, mussel) as the target species, secondary preference should be given to a crustacean (shrimp, lobster, crab) (if available), and finfish should be given the lowest priority for selection as the target species. This ranking of the preferred target species for PAH analysis assumes that a bivalve mollusc and crustacean are available at the sampling site and that these species are eaten by the consumer population of concern.

In 1993, three states (Massachusetts, Michigan, and Ohio) had issued advisories for PAH contamination in finfish (RTI, 1993). As of 1998, there were five advisories in effect in four states (Massachusetts, Michigan, Ohio, and

Washington) for PAHs (U.S. EPA, 1999c). Monitoring sites in industrial and suburban/urban watersheds should be reviewed to identify current and historic sites of waste incinerators, coal gasification facilities, petroleum refineries, and creosote, coal tar, coal coking, and wood preservative facilities that are potential sources for PAH releases to the environment. Sites of petroleum spills should also be reviewed.

The EPA and others have developed a relative potency estimate approach for the PAHs (Nisbet and LaGoy, 1992; U.S. EPA, 1993c). Using this approach, the cancer potency of 14 carcinogenic PAHs can be estimated based on their relative potency to benzo[*a*]pyrene. Toxicity equivalence factors (TEF) for benzo[*a*]pyrene and the other 14 PAHs based on carcinogenicity are discussed in Section 5.3.2.4.

Although several PAHs have been classified as probable human carcinogens (Group B2), benzo[*a*]pyrene is the only PAH for which an oral CSF is currently available in IRIS (1999). It is recommended that, in both screening and intensive studies, tissue samples be analyzed for benzo[*a*]pyrene and the other 14 PAHs for which TEFs are available and that the relative potencies given for these PAHs (Nisbet and LaGoy, 1992; U.S. EPA, 1993c) be used to calculate a potency equivalency concentration for each sample for comparison with the recommended SVs for benzo[*a*]pyrene (see Section 5.3.2.4).

4.3.6 Polychlorinated Biphenyls (Total)

PCBs are base/neutral compounds that are formed by the direct chlorination of biphenyl. PCBs are closely related to many chlorinated hydrocarbon pesticides (e.g., DDT, dieldrin, and aldrin) in their chemical, physical, and toxicologic properties and in their widespread occurrence in the aquatic environment (Nimmo, 1985). There are 209 different PCB compounds, termed congeners, based on the possible chlorine substitution patterns. In the United States, mixtures of various PCB congeners were formulated for commercial use under the trade name Aroclor on the basis of their percent chlorine content. For example, a common PCB mixture, Aroclor 1254, has an average chlorine content of 54 percent by weight (Nimmo, 1985).

Unlike the organochlorine pesticides, PCBs were never intended to be released directly into the environment; most uses were in closed industrial systems. Important properties of PCBs for industrial applications include thermal stability, fire and oxidation resistance, and solubility in organic compounds (Hodges, 1977). PCBs were used as insulating fluids in electrical transformers and capacitors, as plasticizers, as lubricants, as fluids in vacuum pumps and compressors, and as heat transfer and hydraulic fluids (Hodges, 1977; Nimmo, 1985). Although use of PCBs as a dielectric fluid in transformers and capacitors was generally considered a closed-system application, the uses of PCBs, especially during the 1960s, were broadly expanded to many open systems where losses to the environment were likely. Heat transfer systems, hydraulic fluids in die cast machines, and uses in specialty inks are examples of more open-ended

applications that resulted in serious contamination in fish near industrial discharge points (Hesse, 1976).

Although PCBs were once used extensively by industry, their production and use in the United States were banned by the EPA in July 1979 (Miller, 1979). Prior to 1979, the disposal of PCBs and PCB-containing equipment was not subject to federal regulation. Prior to regulation, of the approximately 1.25 billion pounds purchased by U.S. industry, 750 million pounds (60 percent) were still in use in capacitors and transformers, 55 million pounds (4 percent) had been destroyed by incineration or degraded in the environment, and over 450 million pounds (36 percent) were either in landfills or dumps or were available to biota via air, water, soil, and sediments (Durfee et al., 1976).

PCBs are extremely persistent in the environment and are bioaccumulated throughout the food chain (Eisler, 1986; Worthing, 1991). There is evidence that PCB health risks increase with increased chlorination because more highly chlorinated PCBs are retained more efficiently in fatty tissues (IRIS, 1999). However, individual PCB congeners have widely varying potencies for producing a variety of adverse biological effects including hepatotoxicity, cardiovascular toxicity, developmental toxicity, immunotoxicity, neurotoxicity, and carcinogenicity. The non-ortho-substituted coplanar PCB congeners, and some of the mono-ortho-substituted congeners, have been shown to exhibit "dioxin-like" effects (Golub et al., 1991; Kimbrough and Jensen, 1989; McConnell, 1980; Poland and Knutson, 1982; Safe, 1985, 1990; Tilson et al., 1990; U.S. EPA 1993c; Van den Berg et al., 1998). The neurotoxic effects of PCBs appear to be associated with some degree of ortho-chlorine substitution. There is increasing evidence that many of the toxic effects of PCBs result from alterations in hormonal function. Because PCBs can act directly as hormonal agonists or antagonists, PCB mixtures may have complex interactive effects in biological systems (Korach et al., 1988; Safe et al., 1991; Shain et al., 1991; U.S. EPA, 1993c). Because of the lack of sufficient toxicologic data, EPA has not developed quantitative estimates of health risk for specific congeners; however, 12 dioxin-like congeners have been assigned TEFs and may be evaluated as contributing to dioxin health risk (Van den Berg et al., 1998). PCB mixtures have been classified as probable human carcinogens (Group B2) (Appendix G) (IRIS, 1999; U.S. EPA, 1988a).

PCB mixtures have been shown to cause adverse developmental effects in experimental animals (ATSDR, 1998b). Data are inconclusive in regard to developmental effects in humans. Several studies in humans have suggested that PCB exposure may cause adverse developmental effects in children and in developing fetuses (ATSDR, 1998b). These include lower IQ scores (Jacobson and Jacobson, 1996), low birth weight (Rylander et al., 1998), and lower behavior assessment scores (Lonky et al., 1996). However, study limitations, including lack of control for confounding variables, deficiencies in the general areas of exposure assessment, selection of exposed and control subjects, and the comparability of exposed and control samples obscured interpretation of these results (ATSDR, 1998b).

PCBs, total or as Aroclors, have been included in seven major fish contaminant monitoring programs evaluated by the 1993 EPA Workgroup (Appendix E). A summary of the U.S. Fish and Wildlife Service National Contaminants Biomonitoring Program (NCBP) data from 1976 through 1984 indicated a significant downward trend in the geometric mean concentration (wet weight basis) of total PCBs (from 0.89 ppm in 1976 to 0.39 ppm in 1984); however, PCB residues in fish tissue remain widespread, being detected at 91 percent of the sites monitored in 1984 (Schmitt et al., 1990). Maximum total PCB tissue residue concentrations during this same period also declined, from 70.6 ppm in 1976 to 6.7 ppm in 1984. Coinciding declines in tissue residue concentrations of three Aroclors (1248, 1254, and 1260) were also observed. Kidwell et al. (1995) conducted an analysis of all 1984-1985 data from the NCBP study on the three Aroclors in bottom-feeding and predatory fish species. These authors reported there was no significant difference in residues in these two trophic groups of fish for Aroclor 1248 and 1254; however, there were significantly higher concentrations of Aroclor 1260 in predator species as compared to bottom feeders. Mean tissue concentrations of Aroclor 1248, 1254, and 1260 were 0.06 ± 0.32 , 0.21 ± 0.39 , and 0.14 ± 0.24 ppm, respectively, for bottom feeders (e.g., carp, white suckers, and channel catfish) and 0.08 ± 0.31 , 0.35 ± 0.69 , and 0.23 ± 0.38 ppm, respectively, for predator species (e.g., rainbow, brown, brook, and lake trout, largemouth bass, and walleye).

Total PCBs also were detected at 91 percent of 374 sites surveyed in the EPA National Study of Chemical Residues in Fish (NSCRF) (U.S. EPA, 1992c, 1992d). Maximum, arithmetic mean, and median total PCB concentrations (wet weight) reported were 124, 1.89, and 0.209 ppm, respectively. As is shown in Table 4-6, the tri-, tetra-, penta-, hexa-, and heptachlorobiphenyls were detected in fish tissue samples at >50 percent of the NSCRF sites. Mean tissue concentrations were highest for the tetra- and pentachlorobiphenyls with concentrations of 0.696, 0.565, and 0.356 ppm, respectively. The median fish tissue concentrations were highest for the hexa- followed by the pentachlorobiphenyls with concentrations of 0.077 and 0.072 ppm, respectively.

With respect to sources of these compounds, PCBs were detected in all parts of the country with the highest concentrations being associated with paper mills, refinery/other industry sites, Superfund sites, wood preserving facilities, and industrial/urban areas. Mean total PCB concentrations from the NSCRF study were highest in bottom feeders (whole fish) such as carp (2.94 ppm), white sucker (1.7 ppm), and channel catfish (1.3 ppm) as compared to predator species (fillet samples) such as largemouth bass (0.23 ppm), smallmouth bass (0.5 ppm), and walleye (0.37 ppm) (Kuehl et al., 1994).

In 1993, PCB contamination in fish and shellfish resulted in the issuance of 328 advisories in 31 states and the U.S. territory of American Samoa (Figure 4-3) (RTI, 1993). As of 1998, there were 679 advisories in effect in 36 states and the U.S. territory of American Samoa for this compound (Figure 4-3) (U.S. EPA, 1999c.). In addition, two states (Indiana and New York) and the District of Columbia had statewide advisories for PCBs in freshwater rivers and/or lakes.

Table 4-6. Summary of PCBs Detected in Fish Tissue^a as Part of the National Study of Chemical Residues in Fish

Congener group	% sites where detected	Maximum	Mean	Median
Monochlorobiphenyl	13.8	0.235	0.001	ND
Dichlorobiphenyl	30.7	5.072	0.021	ND
Trichlorobiphenyl	57.5	18.344	0.150	0.002
Tetrachlorobiphenyl	72.4	60.764	0.696	0.023
Pentachlorobiphenyl	86.7	29.578	0.565	0.072
Hexachlorobiphenyl	88.7	8.862	0.356	0.077
Heptachlorobiphenyl	69.1	1.850	0.097	0.017
Octachlorobiphenyl	34.8	0.593	0.017	ND
Nonachlorobiphenyl	9.7	0.413	0.003	ND
Decachlorobiphenyl	3.3	0.038	0.001	0.003
Total PCBs*	91.4	-----	1.898	0.209

* The sum of the concentrations of compounds with 1 to 10 chlorines.

^a Concentrations are in ppm (µg/g) wet weight basis.

Source: U.S. EPA, 1992c, 1992d.

One state, Connecticut, had an advisory for all its coastal estuarine waters (Long Island Sound), and five states (Massachusetts, New Hampshire, New Jersey, New York, and Rhode Island) had advisories in effect for all of their coastal marine waters (U.S. EPA, 1999c). Monitoring sites in industrial and suburban/urban watersheds should be reviewed to identify sites of historical Aroclor production facilities, current and historic transformer manufacturing or refurbishing facilities, current and historic landfill and Superfund sites, and current and historic incineration or combustion facilities that are potential sources for PCB releases to the environment.

PCBs may be analyzed quantitatively as Aroclor equivalents, as homologue groups, or as individual congeners. Historically, Aroclor analysis has been performed by most laboratories. This procedure can, however, result in significant error in determining total PCB concentrations (Schwartz et al., 1987; Cogliano, 1998; U.S. EPA, 1996) and in assessing the toxicologic significance of PCBs, because it is based on the assumption that distribution of PCB congeners in environmental samples and parent Aroclors is similar.

The distribution of PCB congeners in Aroclors is, in fact, altered considerably by physical, chemical, and biological processes after release into the environment, particularly when the process of biomagnification is involved (Norstrom, 1988; Oliver and Niimi, 1988; Smith et al., 1990; U.S. EPA, 1996). Aquatic environmental studies indicate that the chlorine content of PCBs increases at higher trophic levels (Bryan et al., 1987; Kubiak et al., 1989; Oliver and Niimi, 1988).

4. TARGET ANALYTES

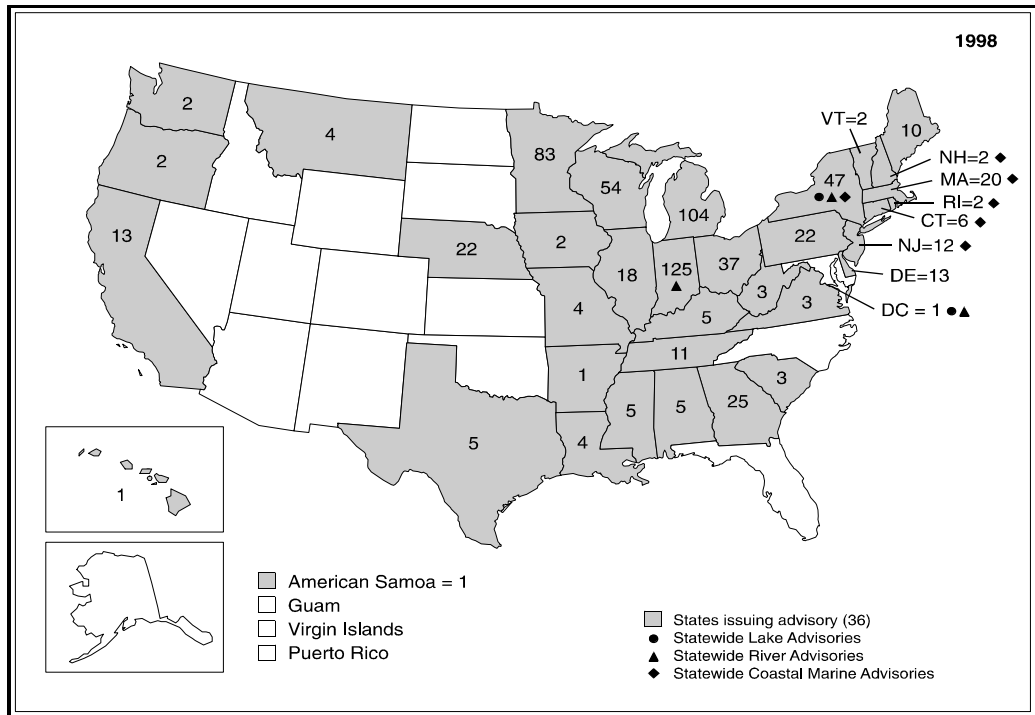
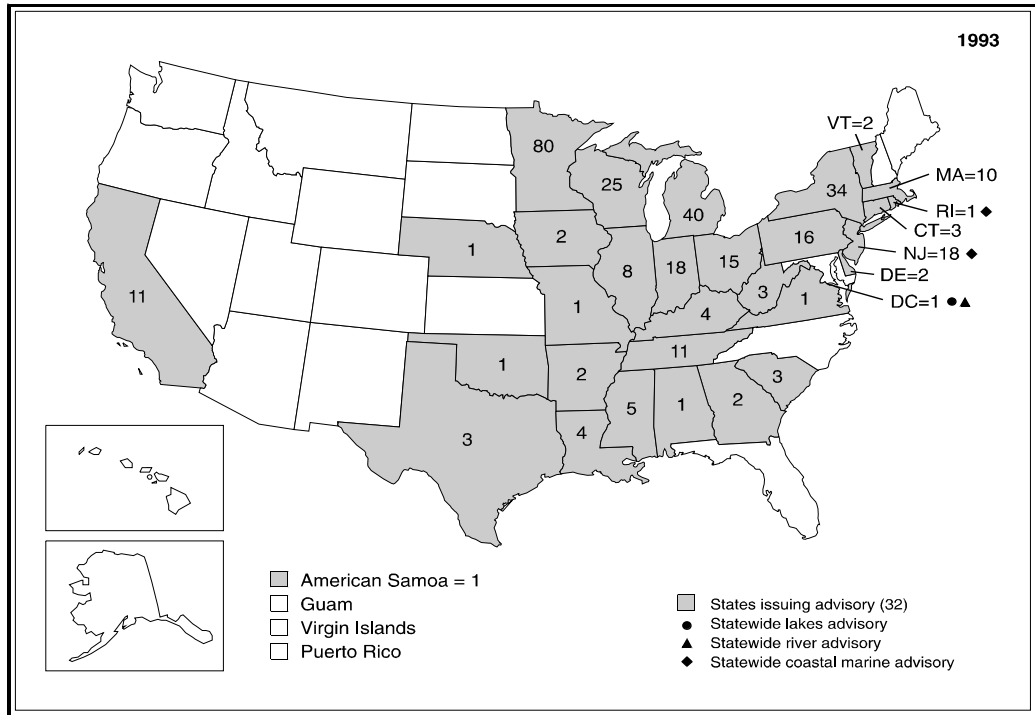

Figure 4-3. States issuing fish and shellfish advisories for PCBs.

The available data indicate that bioaccumulated PCBs are more toxic and more persistent than the original Aroclor mixtures (Cogliano, 1998). Consequently, analysis of homologue groups or congeners should provide a more accurate determination of total PCB concentrations than Aroclor analysis. PCB concentrations derived from Aroclor methods may underestimate total PCBs. In one study, the Delaware Department of National Resources and Environmental Control (DDNREC) compared results of PCBs in six fish samples as determined by Aroclor analysis (Method 608) and homologue analysis (Method 680) (Greene, 1992). On the average, the homologue method gave PCB estimates that were 230 percent higher than the results from the Aroclor method.

The major advantage to analyzing PCBs as Aroclor equivalents is that the analysis is relatively inexpensive (approximately \$200 - \$500) compared to analyzing PCBs as individual congeners (approximately \$800-\$2000). Another disadvantage to analyzing PCBs as individual congeners is that the large number of PCB congeners presents analytical difficulties. Quantitation of individual PCB congeners is relatively time-consuming. EPA has not issued a standard method for PCB congener analysis but has developed a draft method (1668) for dioxin-like congeners (U.S. EPA 1997a). This method is likely to be revised to include the capability to detect all 209 PCB congeners. Currently, only a few laboratories have the capability or expertise to perform congener analyses. Both NOAA (MacLeod et al., 1985; NOAA, 1989b) and the EPA Narragansett Research Laboratory conduct PCB congener analyses. Some states currently conduct both congener and Aroclor analysis; however, most states routinely perform only Aroclor analysis. Analytical methods for congener analysis are discussed in the following references: Cogliano, 1998; Huckins et al., 1988; Kannan et al., 1989; Lake et al., 1995; MacLeod et al., 1985; Maack and Sonzogni, 1988; Mes and Weber, 1989; NOAA, 1989b; Skerfving et al., 1994; Smith et al., 1990; Tanabe et al., 1987; U.S. EPA, 1996.

For the purposes of conducting a risk assessment to determine whether tissue residues exceed potential levels of public health concern in fish and shellfish monitoring programs, analysis of PCB congener or Aroclor equivalents is acceptable. However, because of their lower cost, Aroclor analyses may be the more cost-effective method to use if a large number of samples are analyzed for PCB contamination.

States are encouraged to develop the capability to perform PCB congener analysis. When congener analysis is conducted, at a minimum the 18 congeners recommended by NOAA (shown in Table 4-7) should be analyzed and summed to determine a total PCB concentration according to the approach used by NOAA (1989b). States may wish to consider including additional congeners based on site-specific considerations. PCB congeners of potential environmental importance identified by McFarland and Clarke (1989) and dioxin-like congeners identified by Van den Berg et al. (1998) also are listed in Table 4-7. Lake et al. (1995) and Oliver and Niimi (1988) included more than 80 congeners in their analyses of PCB patterns in water, sediment, and aquatic organisms. A recent study conducted by the DDNREC (Greene, 1999) analyzed for 75 congeners in

Table 4-7. Polychlorinated Biphenyl (PCB) Congeners Recommended for Quantitation as Potential Target Analytes

PCB Congener ^{a,b}	NOAA ^c	McFarland and Clarke (1989)		Dioxin-Like PCBs ^f
		Highest priority ^d	Second priority ^e	
2,4' diCB	8			
2,2',5 triCB	18		18	
2,4,4' triCB	28		37	
3,4,4' triCB				
2,2',3,5' tetraCB	44		44	
2,2',4,5' tetraCB	52	77	49	77
2,2',5,5' tetraCB	66		52	81
2,3',4,4' tetraCB	77		70	
2,3',4',5 tetraCB			74	
2,4,4',5 tetraCB			81	
3,3',4,4' tetraCB				
3,4,4',5 tetraCB				
2,2',3,4,5' pentaCB		87		
2,2',3,4',5 pentaCB	101	90	114	105
2,2',4,5,5' pentaCB	105	101	119	114
2,3,3',4,4' pentaCB	118	105	123	118
2,3,4,4',5 pentaCB	126	118		123
2,3',4,4',5 pentaCB		126		126
2,3',4,4',6 pentaCB				
2',3,4,4',5 pentaCB				
3,3',4,4',5 pentaCB				
2,2',3,3',4,4' hexaCB	128	128		
2,2',3,4,4',5' hexaCB	138	138	151	156
2,2',3,5,5',6 hexaCB	153	153	157	157
2,2',4,4',5,5' hexaCB	169	156	158	167
2,3,3',4,4',5 hexaCB		169	167	169
2,3,3',4,4',5 hexaCB			168	
2,3,3',4,4',6 hexaCB				
2,3',4,4',5,5' hexaCB				
2,3',4,4',5',6 hexaCB				
3,3',4,4',5,5' hexaCB				
2,2',3,3',4,4',5 heptaCB	170	170		
2,2',3,4,4',5,5' heptaCB	180	180	187	189
2,2',3,4,4',5',6 heptaCB	187	183	189	
2,2',3,4,4',6,6' heptaCB		184	201	
2,2',3,4',5,5',6 heptaCB		195		
2,3,3',4,4',5,5' heptaCB				
2,2',3,3',4,4',5,6 octaCB				
2,2',3,3',4,5',6,6' octaCB				
2,2',3,3',4,4',5,5',6 nonaCB		206		
2,2',3,3',4,4',5,5',6,6' decaCB		209		

^a Congeners recommended for quantitation, from dichlorobiphenyl (diCB) through decachlorobiphenyl (decaCB).

^b Congeners are identified in each column by their International Union of Pure and Applied Chemistry (IUPAC) number, as referenced in Ballschmitter and Zell (1980) and Mullin et al. (1984).

^c EPA recommends that these 18 congeners be summed to determine total PCB concentration (NOAA, 1989b).

^d PCB congeners having highest priority for potential environmental importance based on potential for toxicity, frequency of occurrence in environmental samples, and relative abundance in animal tissues.

^e Congeners having second priority for potential environmental importance based on potential for toxicity, frequency of occurrence in environmental samples, and relative abundance in animal tissues.

^f Van den Berg et al., 1998.

fish tissue. Of the 75 congeners, 40 were detected in every fish sample and 20 other congeners were detected in at least half the samples. The DDNREC concluded that a comprehensive target congener list is needed to account for total PCBs in environmental samples because most of the congeners contributed less than 5 percent of the total PCBs.

The EPA Office of Water recommends that PCBs be analyzed as either congeners or Aroclors, with total PCB concentrations reported as the sum of the individual congeners or the sum of the individual Aroclors. If a congener analysis is conducted, the 12 dioxin-like congeners identified in Table 4-7 may be evaluated separately as part of the dioxin risk (see Section 4.3.7). The recommendation is intended to allow states flexibility in PCB analysis and to encourage the continued development of reliable databases of PCB congener and Aroclor equivalents concentrations in fish and shellfish tissue in order to increase our understanding of the mechanisms of action and toxicities of these chemicals. The rationale for, and the uncertainties of, this recommended approach are discussed further in Section 5.3.2.6.

4.3.7 Dioxins and Dibenzofurans

Note: At this time, EPA's Office of Research and Development is reevaluating the potency of dioxins and dibenzofurans. Information provided here as well as information in Section 5.3.2.7 related to calculating TEQs and SVs for dioxins/furans has been modified since the second edition of this Volume 1 guidance was published, but is subject to change pending the results of this reevaluation.

The polychlorinated dibenzo-p-dioxins (PCDDs) and polychlorinated dibenzofurans (PCDFs) are included as target analytes primarily because of the extreme potency of 2,3,7,8-tetrachlorodibenzo-p-dioxin (2,3,7,8-TCDD). Extremely low doses of this homologue have been found to elicit a wide range of toxic responses in animals, including carcinogenicity, teratogenicity, fetotoxicity, reproductive dysfunction, and immunotoxicity (U.S. EPA, 1987d). This compound is the most potent animal carcinogen evaluated by EPA, and EPA has determined that there is sufficient evidence to conclude that 2,3,7,8-TCDD is a probable human carcinogen (B2) (HEAST, 1997). Concern over the health effects of 2,3,7,8-TCDD is increased because of its persistence in the environment and its high potential to bioaccumulate (U.S. EPA, 1987d). As of 1998, the TEF value for 1,2,3,7,8-PeCDD was changed from 0.5 to 1.0, giving 1,2,3,7,8-PeCDD and 2,3,7,8-TCDD the same toxicity equivalency factor (Van den Berg et al., 1998). 1,2,3,7,8-PeCDD is also one of the congeners that is bioaccumulated by fish (U.S. EPA, 1992c, 1992d).

Because dioxin/furan contamination is found in proximity to industrial sites (e.g., bleached kraft paper mills or facilities handling 2,4,5-trichlorophenoxyacetic acid [2,4,5-T], 2,4,5-trichlorophenol [2,4,5-TCP], and/or silvex), and municipal or industrial combustors and incinerators (U.S. EPA, 1987d), it is recommended that each state agency responsible for monitoring include these compounds as target analytes on a site-specific basis based on the presence of potential sources and

results of any environmental (water, sediment, soil, air) monitoring performed in areas adjacent to these sites. All states should maintain a current awareness of potential dioxin/furan contamination, including contamination from the 12 coplanar PCBs that exhibit dioxin-like effects.

Fifteen dioxin and dibenzofuran congeners have been included in two major fish contaminant monitoring programs; however, one congener, 2,3,7,8-TCDD, has been included in six national monitoring programs (Appendix E). Six dioxin congeners and nine dibenzofuran congeners were measured in fish tissue samples in the EPA National Study of Chemical Residues in Fish. The various dioxin congeners were detected at 32 to 89 percent of the 388 sites surveyed, while the furan congeners were detected at 1 to 89 percent of the 388 sites surveyed (U.S. EPA, 1992c, 1992d). As shown in Table 4-8, the dioxin/furan congeners detected at more than 50 percent of the sites included four CDD compounds and three CDF compounds: 1,2,3,4,6,7,8 HpCDD (89 percent), 2,3,7,8 TCDF (89 percent), 2,3,7,8 TCDD (70 percent), 1,2,3,6,7,8 HxCDD (69 percent), 2,3,4,7,8 PeCDF (64 percent), 1,2,3,4,6,7,8 HpCDF (54 percent), and 1,2,3,7,8 PeCDD (54 percent). The most frequently detected CDD/CDF compounds (1,2,3,4,6,7,8-HpCDD and 2,3,7,8-TCDF) were also detected at the highest concentrations—249 ppt and 404 ppt (wet weight), respectively. The mean concentrations of these two compounds were considerably lower, at 10.5 and 13.6 ppt, respectively. The dioxin congener (2,3,7,8-TCDD) believed to be one of the two most toxic congeners to mammals was detected at 70 percent of the sites at a maximum concentration of 204 ppt and a mean concentration of 6.8 ppt. The other toxic congener, 1,2,3,7,8-PeCDD, was detected at 54 percent of the sites at a maximum and mean concentration of 53.95 and 2.38 ppt, respectively.

The NSCRF data showed that pulp and paper mills using chlorine bleach pulp were the dominant source of 2,3,7,8-TCDD and 2,3,7,8-TCDF and that these sites had the highest median 2,3,7,8-TCDD concentrations (5.66 ppt), compared to other source categories studied, including refinery/other industrial sites (1.82 ppt), industrial/urban sites (1.40 ppt), Superfund sites (1.27 ppt), and background sites (0.5 ppt). Source categories that had the highest 2,3,7,8-TCDD concentrations in fish also had the highest TEQ values. It should be noted that OCDD and OCDF were not analyzed in fish tissues because the TEFs were zero for these compounds at the initiation of the NSCRF study. In 1989, TEFs for OCDD and OCDFs were given a TEF value of 0.001. Therefore, TEQ values presented in the NSCRF report may be underreported for samples collected at sites with sources of OCDD/OCDF contamination (e.g., wood preservers) (U.S. EPA, 1992, 1992d). It is noted that the latest TEFs for OCDD and OCDF are 0.0001 (Van den Berg et al., 1998) (see Table 5-6).

In 1993, 20 states had issued 67 fish advisories for dioxins/furans (Figure 4-4) (RTI, 1993). As of 1998, there were 59 advisories in effect in 19 states for this chemical contaminant (Figure 4-4) (U.S. EPA, 1999c). In addition, three states (Maine, New Jersey, and New York) had dioxin advisories in effect for all coastal marine waters (U.S. EPA, 1999c).

Table 4-8. Summary of Dioxins/Furans Detected in Fish Tissue as Part of the EPA National Study of Chemical Residues in Fish^a

Congener	% Sites where detected	Maximum	Mean	Standard deviation	Median
Dioxins					
2,3,7,8-TCDD	70	203.6	6.89	19.41	1.38
1,2,3,7,8-PeCDD	54	53.95	2.38	4.34	0.93
1,2,3,4,7,8-HxCDD	32	37.56	1.67	2.39	1.24
1,2,3,6,7,8-HxCDD	69	100.9	4.30	9.25	1.32
1,2,3,7,8,9-HxCDD	38	24.76	1.16	1.74	0.69
1,2,3,4,6,7,8-HpCDD	89	249.1	10.52	25.30	2.83
Furans					
2,3,7,8-TCDF	89	403.9	13.61	40.11	2.97
1,2,3,7,8-PeCDF	47	120.3	1.71	7.69	0.45
2,3,4,7,8-PeCDF	64	56.37	3.06	6.47	0.75
1,2,3,4,7,8-HxCDF	42	45.33	2.35	4.53	1.42
1,2,3,6,7,8-HxCDF	21	30.86	1.74	2.34	1.42
1,2,3,7,8,9-HxCDF	1	0.96 ^b	1.22	0.41	1.38
2,3,4,6,7,8-HxCDF	32	19.3	1.24	1.51	0.98
1,2,3,4,6,7,8-HpCDF	54	58.3	1.91	4.41	0.72
1,2,3,4,7,8,9-HpCDF	4	2.57	1.24	0.33	1.30
EPA-TEQ ^c	NA	213	11.1	23.8	2.80

^a Concentrations are given in picograms per gram (pg/g) or parts per trillion (ppt) by wet weight. The mean, median, and standard deviation were calculated using one-half the detection limit for samples that were below the detection limit. In cases where multiple samples were analyzed per site, the value used represents the highest concentration.

^b Detection limits were higher than the few quantified values for 1,2,3,4,7,8,9-HpCDF and 1,2,3,7,8,9-HxCDF. Maximum values listed are measured values.

^c This EPA study used TEF-89 toxicity weighting values but did not analyze concentrations of octachlorodibenzo-*p*-dioxin or octachlorodibenzofurans in fish tissues; therefore, the TEQ value does not include these two compounds or the 12 coplanar PCB congeners.

EPA = U.S. Environmental Protection Agency
 HpCDD = Heptachlorodibenzo-*p*-dioxin
 HpCDF = Heptachlorodibenzofuran
 HxCDD = Hexachlorodibenzo-*p*-dioxin
 HxCDF = Hexachlorodibenzofuran
 NA = Not applicable
 PeCDD = Pentachlorodibenzo-*p*-dioxin
 PeCDF = Pentachlorodibenzofuran
 TCDD = Tetrachlorodibenzo-*p*-dioxin
 TCDF = Tetrachlorodibenzofuran
 TEQ = Toxicity equivalency concentration.

Source: U.S. EPA, 1992c and 1992d.

Dioxins/furans should be considered for analysis primarily in suburban/urban and industrial watersheds at sites of pulp and paper mills using a chlorine bleaching process and at industrial sites where the following organic compounds have been or are currently produced: herbicides (containing 2,4,5-trichlorophenoxy acids and 2,4,5-trichlorophenol), silvex, hexachlorophene, pentachlorophenol, and PCBs as well as at sites of municipal and industrial waste incinerators and combustors (U.S. EPA, 1987d). EPA recommends that all of the 17 2,3,7,8-substituted tetra- through octachlorinated dioxin and dibenzofuran congeners shown in Table 4-9 as well as the 12 dioxin-like PCB congeners shown in Table 4-7 be included as target analytes.

Table 4-9. Dibenzo-p-Dioxins and Dibenzofurans Recommended for Analysis as Target Analytes

Dioxins	Furans
2,3,7,8-TCDD	2,3,7,8-TCDF
1,2,3,7,8-PeCDD	1,2,3,7,8-PeCDF 2,3,4,7,8-PeCDF
1,2,3,4,7,8-HxCDD	1,2,3,4,7,8-HxCDF
1,2,3,6,7,8-HxCDD	1,2,3,6,7,8-HxCDF
1,2,3,7,8,9-HxCDD	1,2,3,7,8,9-HxCDF 2,3,4,6,7,8-HxCDF
1,2,3,4,6,7,8-HpCDD	1,2,3,4,6,7,8-HpCDF 1,2,3,4,7,8,9-HpCDF
OCDD	OCDF

Source: Van den Berg et al., 1998.

4.4 TARGET ANALYTES UNDER EVALUATION

At present, the EPA Office of Water is evaluating one metal (lead) for possible inclusion as a recommended target analyte in state fish and shellfish contaminant monitoring programs. A toxicologic profile for this metal and the status of the evaluation are provided in this section. Other contaminants will be evaluated and may be recommended as target analytes as additional toxicologic data become available.

Note: Any time a state independently deems that an analyte currently under evaluation and/or other contaminants are of public health concern within its jurisdiction, the state should include these contaminants in its fish and shellfish contaminant monitoring program.

4.4.1 Lead

Lead is derived primarily from the mining and processing of limestone and dolomite deposits, which are often sources of lead, zinc, and copper (May and McKinney, 1981). It is also found as a minor component of coal. Historically, lead has had a number of industrial uses, including use in paints, in solder used in plumbing and food cans, and as a gasoline additive. In the past, the primary

source of lead in the environment was the combustion of gasoline; however, use of lead in U.S. gasoline has fallen sharply in recent years due to an EPA phase-down program to minimize the amount of lead in gasoline over time. By 1988, the total lead usage in gasoline had been reduced to less than 1 percent of the amount used in the peak year of 1970 (ATSDR, 1997). At present, lead is used primarily in batteries, electric cable coverings, ammunition, electrical equipment, and sound barriers. Currently, the major points of entry of lead into the environment are from industrial processes, including metals processing, waste disposal and recycling, and chemical manufacturing and from the leachates of landfills (ATSDR, 1997; May and McKinney, 1981).

Lead has been included in five national monitoring programs (Appendix E). Lead has been shown to bioaccumulate, with the organic forms, such as tetraethyl lead, appearing to have the greatest potential for bioaccumulation in fish tissues. High concentrations of lead have been found in marine bivalves and finfish from both estuarine and marine waters (NOAA, 1987, 1989a). In 1984 and 1985, the U.S. Fish and Wildlife Service collected 315 composite samples of whole fish from 109 stations nationwide as part of the National Contaminant Biomonitoring Program (Schmitt and Brumbaugh, 1990). The authors reported that the maximum, geometric mean, and 85th percentile concentrations for lead were 4.88, 0.11, and 0.22 ppm (wet weight), respectively. Lead concentrations in freshwater fish declined significantly from a geometric mean concentration of 0.28 ppm in 1976 to 0.11 ppm in 1984. This trend has been attributed primarily to reductions in the lead content of U.S. gasoline (Schmitt and Brumbaugh, 1990). Kidwell et al. (1995) conducted an analysis of lead levels in tissues from bottom-feeding and predatory fish using the 1984-1985 data from the NCBP study. These authors reported that the mean lead tissue concentrations of 0.18 ± 0.37 ppm in bottom feeders and 0.15 ± 0.43 ppm in predator fish were not significantly different.

In 1993, three states (Massachusetts, Missouri, and Tennessee) and the U.S. territory of American Samoa had fish advisories for lead contamination (RTI, 1993). As of 1998, there were 10 advisories in effect in four states (Hawaii, Louisiana, Missouri, and Ohio) and the U.S. territory of American Samoa for this heavy metal (U.S. EPA, 1999c).

Lead is particularly toxic to children and fetuses. Subtle neurobehavioral effects (e.g., fine motor dysfunction, impaired concept formation, and altered behavior profile) occur in children exposed to lead at concentrations that do not result in clinical encephalopathy (ATSDR, 1997). A great deal of information on the health effects of lead has been obtained through decades of medical observation and scientific research. By comparison to most other environmental toxicants, the degree of uncertainty about the health effects of lead is quite low. It appears that some of these effects, particularly changes in the levels of certain blood enzymes and in aspects of children's neurobehavioral development, may occur at blood lead levels so low as to be essentially without a threshold. EPA's Reference Dose (RfD) Work Group discussed inorganic lead (and lead compounds) in 1985 and considered it inappropriate to develop an RfD for inorganic lead (IRIS, 1999). Lead and its inorganic compounds have been classified as probable human

carcinogens (B2) by EPA (IRIS, 1999). However, EPA has not derived a quantitative estimate of carcinogenic risk from oral exposure to lead because age, health, nutritional status, body burden, and exposure duration influence the absorption, release, and excretion of lead. In addition, current knowledge of lead pharmacokinetics indicates that an estimate derived by standard procedures would not truly describe the potential risk (IRIS, 1999).

Because of the lack of quantitative health risk assessment information for oral exposure to inorganic lead, the EPA Office of Water has not included lead as a recommended target analyte in fish and shellfish contaminant monitoring programs at this time. **Note:** Because of the observation of virtually no-threshold neurobehavioral developmental effects of lead in children, states should include lead as a target analyte in fish and shellfish contaminant programs if there is any evidence that this metal may be present at detectable levels in fish or shellfish in their jurisdictional waters.

SECTION 5

SCREENING VALUES FOR TARGET ANALYTES

For the purpose of this guidance document, screening values are defined as concentrations of target analytes in fish or shellfish tissue that are of potential public health concern and that are used as threshold values against which levels of contamination in similar tissue collected from the ambient environment can be compared. Exceedance of these SVs should be taken as an indication that more intensive site-specific monitoring and/or evaluation of human health risk should be conducted.

The EPA-recommended risk-based method for developing SVs (U.S. EPA, 1989d) is described in this section. This method is considered to be appropriate for protecting the health of fish and shellfish consumers for the following reasons (Reinert et al., 1991):

- It gives full priority to protection of public health.
- It provides a direct link between fish consumption rate and risk levels (i.e., between dose and response).
- It generally leads to conservative estimates of increased risk.
- It is designed for protection of consumers of locally caught fish and shellfish, including susceptible populations such as sport and subsistence fishers who are at potentially greater risk than the general adult population because they tend to consume greater quantities of fish and because they frequently fish the same sites repeatedly.

At this time, the EPA Office of Water is recommending use of this method because it is the basis for developing current water quality criteria. A detailed discussion of the flexibility of the EPA risk-based method and the use of EPA's SVs as compared to FDA action levels is provided in Section 1.2. Further discussion of the EPA Office of Water risk-based approach, including a detailed description of the four steps involved in risk assessment (hazard identification, dose-response assessment, exposure assessment, and risk characterization) is provided in the second guidance document in this series, *Volume 2: Risk Assessment and Fish Consumption Limits*.

5.1 GENERAL EQUATIONS FOR CALCULATING SCREENING VALUES

Risk-based SVs are derived from the general model for calculating the effective ingested dose of a chemical m (E_m) (U.S. EPA, 1989d):

5. SCREENING VALUES FOR TARGET ANALYTES

$$E_m = (C_m \cdot CR \cdot X_m) / BW \quad (5-1)$$

where

E_m = Effective ingested dose of chemical m in the population of concern averaged over a 70-yr lifetime (mg/kg-d)

C_m = Concentration of chemical m in the edible portion of the species of interest (mg/kg; ppm)

CR = Mean daily consumption rate of the species of interest by the general population or subpopulation of concern averaged over a 70-yr lifetime (kg/d)

X_m = Relative absorption coefficient, or the ratio of human absorption efficiency to test animal absorption efficiency for chemical m (dimensionless)

BW = Mean body weight of the general population or subpopulation of concern (kg).

Using this model, the SV for the chemical m (SV_m) is equal to C_m when the appropriate measure of toxicologic potency of the chemical m (P_m) is substituted for E_m . Rearrangement of Equation 5-1, with these substitutions, gives

$$SV_m = (P_m \cdot BW) / (CR \cdot X_m) \quad (5-2)$$

where

P_m = Toxicologic potency for chemical m ; the effective ingested dose of chemical m associated with a specified level of health risk as estimated from dose-response studies; **dose-response variable**.

In most instances, relative absorption coefficients (X_m) are assumed to be 1.0 (i.e., human absorption efficiency is assumed to be equal to that of the test animal), so that

$$SV_m = (P_m \cdot BW) / CR \quad (5-3)$$

However, if X_m is known, Equation 5-2 should be used to calculate SV_m .

Dose-response variables for noncarcinogens and carcinogens are defined in Sections 5.1.1 and 5.1.2, respectively. These variables are based on an assessment of the occurrence of a critical toxic or carcinogenic effect via a specific route of exposure (i.e., ingestion, inhalation, dermal contact). Oral dose-response variables for the recommended target analytes are given in Appendix G. Because of the fundamental differences between the noncarcinogenic and carcinogenic dose-response variables used in the EPA risk-based method, SVs

must be calculated separately for noncarcinogens and potential carcinogens as shown in the following subsections.

5.1.1 Noncarcinogens

The dose-response variable for noncarcinogens is the **reference dose**. The RfD is an estimate of a daily exposure to the human population (including sensitive subpopulations) that is likely to be without appreciable risk of deleterious effects during a lifetime. The RfD is derived by applying uncertainty or modifying factors to a subthreshold dose (i.e., lowest observed adverse effects level [LOAEL] if the no observed adverse effect level [NOAEL] is indeterminate) observed in chronic animal bioassays. These uncertainty or modifying factors range from 1 to 10 for each factor and are used to account for uncertainties in:

- Sensitivity differences among human subpopulations
- Interspecies extrapolation from animal data to humans
- Short-term to lifetime exposure extrapolation from less-than-chronic results on animals to humans when no long-term human data are available
- Deriving an RfD from a LOAEL instead of a NOAEL
- Incomplete or inadequate toxicity or pharmacokinetic databases.

The uncertainty (UF) and modifying (MF) factors are multiplied to obtain a final UF•MF value. This factor is divided into the NOAEL or LOAEL to derive the RfD (Barnes and Dawson, 1988; U.S. EPA, 1989d).

The following equation should be used to calculate SVs for noncarcinogens:

$$SV_n = (RfD \cdot BW)/CR \quad (5-4)$$

where

SV_n = Screening value for a noncarcinogen (mg/kg; ppm)
RfD = Oral reference dose (mg/kg-d)

and BW and CR are defined as in Equation 5-1.

5.1.2 Carcinogens

According to *The Risk Assessment Guidelines of 1986* (U.S. EPA, 1987f), the default model for low-dose extrapolation of carcinogens is a version (GLOBAL 86) of the linearized multistage no-threshold model developed by Crump et al. (1976). This extrapolation procedure provides an upper 95 percent bound risk estimate (referred to as a $q1^*$), which is considered by some to be a conservative estimate of cancer risk. Other extrapolation procedures may be used when justified by the data.

Screening values for carcinogens are derived from: (1) a carcinogenicity potency factor or **cancer slope factor**, which is generally an upper bound risk estimate; and (2) a **risk level** (RL), an assigned level of maximum acceptable individual

lifetime risk (e.g., $RL = 10^{-5}$ for a level of risk not to exceed one excess case of cancer per 100,000 individuals exposed over a 70-yr lifetime) (U.S. EPA, 1997b). The following equation should be used to calculate SVs for carcinogens:

$$SV_c = [(RL / CSF) \cdot BW] / CR \quad (5-5)$$

where

SV_c = Screening value for a carcinogen (mg/kg; ppm)
RL = Maximum acceptable risk level (dimensionless)
CSF = Oral cancer slope factor (mg/kg-d)⁻¹

and BW and CR are defined as in Equation 5-1.

5.1.3 Recommended Values for Variables in Screening Value Equations

The default values for variables used in Equations 5-4 and 5-5 to calculate SVs are based on assumptions for the general adult population. These default values are consistent with values included in the *Methodology for Deriving Ambient Water Quality Criteria for the Protection of Human Health (2000)* (EPA-822-B-00-004). For risk management purposes (e.g., to protect sensitive populations such as pregnant and nursing women), states may choose to use alternative values for consumption rates, etc. different from those recommended in this section.

5.1.3.1 Dose-Response Variables—

EPA has developed oral RfDs and/or CSFs for all of the recommended target analytes in Section 4 (see Appendix G). These are maintained in the EPA Integrated Risk Information System (IRIS, 1999), an electronic database containing health risk and EPA regulatory information on approximately 400 different chemicals. IRIS is available online at:

<http://www.epa.gov/iris/subst/index.html>

The IRIS RfDs and CSFs are reviewed regularly and updated as necessary when new or more reliable information on the toxic or carcinogenic potency of chemicals becomes available.

When IRIS values for oral RfDs and CSFs are available, they should be used to calculate SVs for target analytes from Equations 5-4 and 5-5, respectively. It is important that the most current IRIS values for oral RfDs and CSFs be used to calculate SVs for target analytes unless otherwise recommended.

In cases where IRIS values for oral RfDs or CSFs are not available for calculating SVs for target analytes, estimates of these variables may be derived from the most recent water quality criteria (U.S. EPA, 1992e) according to procedures described in U.S. EPA (1991a, p. IV-12), or from the Classification

5. SCREENING VALUES FOR TARGET ANALYTES

List of Chemicals Evaluated for Carcinogenicity Potential (U.S. EPA 1999b) from the Office of Pesticide Programs Health Effects Division.

5.1.3.2 Body Weight and Consumption Rate—

Values for the variables BW and CR in Equations 5-4 and 5-5 are given in Table 5-1 for various subpopulations including recreational and subsistence fishers. **Note:** In this third edition of this document, EPA’s Office of Water uses a BW of 70 kg, a default CR of 17.5 g/d to calculate the SV for the general populations and recreational fishers, and a default CR of 142.4 g/d to calculate the SV for subsistence fishers. The CR values have been revised since the release of the previous edition.

Table 5-1. Recommended Values for Mean Body Weights (BW) and Fish Consumption Rates (CRs) for Selected Subpopulations

Variable	Recommended value	Subpopulation
BW	70 kg	All adults (U.S. EPA, 1999a)
	78 kg	Adult males (U.S. EPA, 1985b, 1990a)
	65 kg	Adult females (U.S. EPA, 1985b, 1990a)
	12 kg	Children <3 yr (U.S. EPA, 1985b, 1990a)
	17 kg	Children 3 to <6 yr (U.S. EPA, 1985b, 1990a)
	25 kg	Children 6 to <9 yr (U.S. EPA, 1985b, 1990a)
	36 kg	Children 9 to <12 yr (U.S. EPA, 1985b, 1990a)
	51 kg	Children 12 to <15 yr (U.S. EPA, 1985b, 1990a)
	61 kg	Children 15 to <18 yr (U.S. EPA, 1985b, 1990a)
CR^a	17.5 g/d (0.0175 kg/d)	Estimate of the 90th percentile of recreational or sport fishers (USDA/ARS, 1998) and of the average consumption of uncooked fish and shellfish from estuarine and fresh waters by recreational fishers (U.S. EPA, 2000c)
	142.4 g/d (0.1424 kg/d)	Estimate of the 99th percentile of subsistence fishers (USDA/ARS, 1998) and of the average consumption of uncooked fish and shellfish from estuarine and fresh waters by subsistence fishers (U.S. EPA, 2000c)

^a These are recommended default consumption rates only. **Note:** When local consumption rate data are available for recreational and subsistence fishers, they should be used to calculate SVs for noncarcinogens and carcinogens by subsistence fishers, as described in Sections 5.1.1 and 5.1.2, respectively.

The default CR of 6.5 g/d used in the previous edition of Volume I was based on data from a fish consumption survey conducted in 1973 and 1974 by the National Purchase Diaries and funded by the Tuna Institute. This value represented the estimated mean per capita freshwater/estuarine finfish and shellfish consumption rate for the general U.S. population (Jacobs et al., 1998). This value has been revised based on new data from the combined 1994, 1995, and 1996 Continuing Survey of Food Intake by Individuals (CSFII) survey (USDA/ARS, 1998). The

5. SCREENING VALUES FOR TARGET ANALYTES

CSFII survey is a national food consumption survey conducted by the U.S. Department of Agriculture, consisting of multistage, stratified-cluster area probability samples from all states except Alaska and Hawaii.

These data are collected over 3 consecutive days. On the first day of the survey, participants give information to an in-home interviewer, and on the second and third days, data are taken from self-administered dietary records. Meals consumed both at home and away from home are recorded. Average daily individual consumptions of fish in a given fish-by-habitat category were calculated by summing the amount of fish eaten by the individual across 3 reporting days for all fish-related food codes in a given fish-by-habitat category. The total individual consumption was then divided by three to obtain an average daily consumption rate. The 3-day individual food consumption data collection period is one during which a majority of sampled individuals did not consume any finfish or shellfish. The nonconsumption of finfish or shellfish by a majority of individuals, combined with consumption data from high-end consumers, resulted in a wide range of observed fish consumption rates. This range of fish consumption data would tend to produce distributions of fish consumption with larger variances than would be associated with a longer survey period, such as 30 days. The larger variances would reflect greater dispersion, which results in larger upper-percentile estimates, as well as upper confidence intervals associated with parameter estimates. It follows that estimates of the upper percentiles (90th and 99th percentiles) of per capita fish consumption based on 3 days of data will be conservative with regard to risk (U.S. EPA, 1998a).

If states and tribes do not have site-specific fish consumption information concerning their recreational and subsistence fishers, it is EPA's preference that they use as fish intake assumptions the default values from the most recent 1994-1996 CSFII study (USDA/ARS, 1998). The fish consumption default values of 17.5 g/d for the general adult population and recreational fishers and 142.4 g/d for subsistence fishers used in this document are representative of fish intake for these different population groups. These values are based on risk management decisions that EPA has made after evaluating numerous fish consumption surveys (U.S. EPA, 2000c). These default values represent the uncooked weight intake of freshwater/estuarine finfish and shellfish. EPA recognizes the data gaps and uncertainties associated with the analysis of the 1994-1996 CSFII survey conducted in the process of making its default consumption rate recommendations. The estimated mean of freshwater/estuarine fish ingestion for adults is 7.50 g/d, and the median is 0 g/d. The estimated 90th percentile is 17.53 g/d; the estimated 95th percentile is 49.59 g/d; and the estimated 99th percentile is 142.41 g/d. The median value of 0 g/d may reflect the portion of individuals in the population who never eat fish as well as the limited reporting period (2 days) over which intake was actually measured. By applying as a default consumption rate the 17.5-g/d value for the general adult population, EPA intends to select a consumption rate that is protective of the majority of the population (the 90th percentile of consumers and nonconsumers according to the 1994-1996 CSFII survey data). EPA further considers this rate to be indicative of the average consumption among recreational fishers based on

5. SCREENING VALUES FOR TARGET ANALYTES

averages in the studies reviewed (U.S. EPA, 2000c). Similarly, EPA believes that the assumption of 142.4 g/d is within the range of average consumption estimates for subsistence fishers based on the studies reviewed. Experts at a 1992 National Water Quality Workshop acknowledged, however, that the national survey high-end values are representative of average rates for highly exposed groups such as subsistence fishers, specific ethnic groups, or other high-risk populations. EPA is aware that some local and regional studies indicate greater fish consumption among Native Americans, Pacific Asian Americans, and other subsistence consumers and recommends the use of those studies in appropriate cases. States and tribes have the flexibility to choose fish consumption rates higher than an average value for these populations groups. If a state has not identified a separate well-defined population of high-end consumers and believes that the national data from the 1994-1996 CSFII are representative, they may choose these consumption rates.

With respect to consumption rates, EPA recommends that states always evaluate any type of consumption pattern they believe could reasonably be occurring at a site. Evaluating additional consumption rates involves calculating additional SVs only and does not add to sampling or analytical costs.

EPA has published a review and analysis of survey methods that can be used by states to determine fish and shellfish consumption rates of local populations (U.S. EPA, 1992b, 1998b). States should consult these documents to ensure that appropriate values are selected to calculate SVs for site-specific exposure scenarios.

For any given population, there can be a sensitive subpopulation composed of individuals who may be at higher-than-average risk due to their increased exposure or their increased sensitivity to a contaminant or both. For Native American subsistence fishers, there are several exposure issues of concern that should be addressed as part of a comprehensive exposure assessment:

- **Consumption rates and dietary preferences.** Harris and Harper (1997) surveyed traditional tribal members in Oregon with a subsistence lifestyle and determined a consumption rate of 540 g/d, which included fresh, dried, and smoked fish. They also confirmed that the parts of the fish (heads, fins, tails, skeleton, and eggs) eaten by this group were not typically eaten by other groups. Another study conducted of four tribes in the Northwest that also surveyed tribal members in Oregon but did not target subsistence fishers, reported a 99th percentile ingestion rate of 390 g/d for tribal members (CRITFC, 1994). These consumption rates are much higher than the default consumption rates provided in this document for subsistence fishers and emphasize the need for identifying the consumption rate of the Native American subsistence population of concern.
- **Community characteristics** - It is important to consider family-specific fishing patterns in any exposure scenario, and attention should be paid to the role of the fishing family with respect to the tribal distribution of fish, the

5. SCREENING VALUES FOR TARGET ANALYTES

sharing ethic, and providing fish for ceremonial religious events. Entire communities are exposed if fish are contaminated, and the community contaminant burden as a whole must be considered, not just the maximally exposed individual.

- **Multiple contaminant exposure** - Multiple contaminant exposure is significant for Native American subsistence fishers. A large number of contaminants are often detected in fish tissues and their combined risk associated with the higher consumption rates and dietary preferences for certain fish parts could be very high even if individual contaminants do not exceed the EPA reference dose (Harper and Harris, 1999).
- **Other exposure pathways** - For Native American subsistence fishers, overall exposure to a contaminant may be underestimated if it fails to take into account nonfood uses of fish and other animal parts that may contribute to overall exposure, such as using teeth and bones for decorations and whistles, animal skins for clothing, and rendered fish belly fat for body paint (Harper and Harris, 1999). If other wildlife species (e.g., feral mammals, turtles, waterfowl) that also live in or drink from the contaminated waterbody are eaten, or if the contaminated water is used for irrigation of crops or for livestock watering or human drinking water, the relative source contribution of these other pathways of exposure must also be considered. As with fish and wild game, plants are used by Native Americans for more than just nutrition. Daily cleaning, preparation, and consumption of plants and crafting of plant materials into household goods occurs throughout the year (Harris and Harper, 1997).

As in the general population, increased sensitivity to a chemical contaminant for Native Americans can result from factors such as an individual's underlying health status and medications, baseline dietary composition and quality, genetics, socioeconomic status, access to health care, quality of replacement protein, age, gender, pregnancy, and lactation. These factors are only partially considered in the uncertainty factor(s) used to develop the RfD (Harper and Harris, 1999).

Other important issues that need to be considered concern risk characterization and risk management. For Native American subsistence fishers, the use of an acceptable risk level of 1 in 100,000 (10^{-5}) may not be acceptable to all tribes. Each tribe has the right to decide for themselves what an acceptable level of risk is, and, in some cases, it may be zero risk (zero discharge) to protect cultural resources and uses. Ecological well-being or health is another key issue. Human and ecological health are connected in many ways and the ripple effects are often not recognized. For example, human health may be affected by injury to the environment, which affects the economy and the culture (Harper and Harris, 1999).

Native American subsistence fishers should be treated as a special high-risk group of fish consumers distinct from fishers in the general population and

5. SCREENING VALUES FOR TARGET ANALYTES

distinct even from other Native American fish consumers living in more suburbanized communities. Table 5-2 compares fish consumption rates for various fisher populations within the general population and in several surveys of specific Native American tribal populations. EPA currently recommends default fish consumption rates of 17.5 g/d for the general and recreational fishers and 142.4 g/d for subsistence fishers. However, the tribal population fish consumption studies show that some Native American tribal members living in river-based communities (CRITFC, 1994) eat from 3 to 22 times more fish (from 59 g/d up to 390 g/d) than do recreational fishers, but that traditional Native American subsistence fishing families may eat up to 30 times more fish, almost 1.2 lb/d (540 g/d) (Harris and Harper, 1997). The fish consumption rate from Harris and Harper (1997) for Native American subsistence fishers is also 3.8 times higher than the EPA default consumption rate for subsistence fishers (142.4 g/d) in the general population. The difference in fish consumption is due to the fact that the Native American subsistence fisher's lifestyle is not the same as a recreational fisher's lifestyle with additional fish consumption added, nor is it the same as the "average" Native American tribal member living in a fairly suburbanized tribal community. In addition to exposures from direct consumption of contaminated fish, Native American subsistence fishers also receive more exposure to the water and sediments associated with catching and preparing fish and possibly from drinking more unfiltered river water than more suburbanized tribal community members as well. The Native American subsistence fishing population should be treated as a separate group with a unique lifestyle, distinct from recreational and subsistence fishers in the general U.S. population and also distinct from other Native American fisher populations.

5.1.3.3 Risk Level (RL)—

In this guidance document, EPA's Office of Water uses an RL of 10^{-5} to calculate screening values for the general adult population. However, states have the flexibility to choose to use an appropriate RL value typically ranging from 10^{-4} to 10^{-7} . This is the range of risk levels employed in various U.S. EPA programs. Selection of the appropriate RL is a risk management decision that is made by the state.

5.2 SCREENING VALUES FOR TARGET ANALYTES

Target analyte SVs, and the dose-response variables used to calculate them, are given in Tables 5-3 and 5-4. The SVs are provided as default values for the states to use when site-specific information on variables such as consumption rates are not available for local recreational or subsistence fisher populations.

5. SCREENING VALUES FOR TARGET ANALYTES

Table 5-2. Fish Consumption Rates for Various Fisher Populations

Source	Recreational Fishers (g/d)	Subsistence Fishers (g/d)	Native American Subsistence Fishers (g/d)	Native Americans (g/d)	Basis for Consumption Rate
U.S. EPA	17.5 ^a	142.4 ^a	70 (mean) ^b 170 (95 th percentile) ^b	NA	Fish consumption rate from 1994 and 1996 Continuing Survey of Food Intake by Individuals (CSFII)
Harris and Harper (1997)	NA	NA	540 (fresh, smoked and dried)	NA	Surveyed members of the Confederated Tribes of the Umatilla Indian Reservation
CRITFC (1994)	NA	NA	NA	59 (mean) 170 (95 th percentile) 390 (99 th percentile)	Surveyed members of the Umatilla, Nez Perce, Yakama, and Warm Springs Tribes
Toy et al. (1996)	NA	NA	NA	53 (median, males) 34 (median, females) 66 (median, males) 25 (median, females)	Surveyed members of the Tulalip Tribe Surveyed members of the Squaxin Island Tribe

^a These values were revised in this 3rd edition of Volume 1 of this series (USDA/ARS, 1998)

^b These values are from EPA's Exposure Factors Handbook (U.S. EPA, 1997b)

These SVs were calculated from Equations 5-4 or 5-5 using the following values for BW, CR, and RL and the most current IRIS values for oral RfDs and CSFs (IRIS, 1999) unless otherwise noted:

- **For noncarcinogens:**

BW = 70 kg, average adult body weight

CR = 17.5 g/d (0.0175 kg/d), estimate of average consumption of uncooked fish and shellfish from estuarine and fresh waters by recreational fishers, or

= 142.4 g/d (0.1424 kg/d), estimate of average consumption of uncooked fish and shellfish from estuarine and freshwaters by subsistence fishers.

- **For carcinogens:**

BW and CR, as above

RL = 10⁻⁵, a risk level corresponding to one excess case of cancer per 100,000 individuals exposed over a 70-yr lifetime.

If both oral RfD and CSF values are available for a given target analyte, SVs for both noncarcinogenic and carcinogenic effects are listed in Table 5-2 for recreational fishers and Table 5-3 for subsistence fishers. Unless otherwise indicated,

5. SCREENING VALUES FOR TARGET ANALYTES

Table 5-3. Dose-Response Variables and Recommended Screening Values (SVs) for Target Analytes - Recreational Fishers^a

Target analyte	Noncarcinogens RfD (mg/kg-d)	Carcinogens CSF (mg/kg-d) ⁻¹	SV ^b (ppm)	
			Noncarcinogens ^b	Carcinogens ^b (RL=10 ⁻⁵)
Metals				
Arsenic (inorganic) ^c	3 x 10 ⁻⁴	1.5	1.2	0.026
Cadmium	1 x 10 ⁻³	NA	4.0	-
Mercury (methylmercury) ^d	1 x 10 ⁻⁴	NA	0.4	-
Selenium	5 x 10 ⁻³	NA	20	-
Tributyltin ^e	3 x 10 ⁻⁴	NA	1.2	-
Organochlorine Pesticides				
Total chlordane (sum of cis- and trans-chlordane, cis- and trans-nonachlor, and oxychlordane) ^f	5 x 10 ⁻⁴	0.35	2.0	0.114
Total DDT (sum of 4,4'- and 2,4'- isomers of DDT, DDE, and DDD) ^g	5 x 10 ⁻⁴	0.34	2.0	0.117
Dicofol ^h	4 x 10 ⁻⁴	NA ⁱ	1.6	2.5
Dieldrin	5 x 10 ⁻⁵	16	0.2	2.50 x 10 ⁻³
Endosulfan (I and II) ^j	6 x 10 ⁻³	NA	24	-
Endrin	3 x 10 ⁻⁴	NA	1.2	-
Heptachlor epoxide	1.3 x 10 ⁻⁵	9.1	5.2 x 10 ⁻²	4.39 x 10 ⁻³
Hexachlorobenzene	8 x 10 ⁻⁴	1.6	3.2	2.50 x 10 ⁻²
Lindane (g-hexachlorocyclohexane; g-HCH) ^k	3 x 10 ⁻⁴	1.3	1.2	3.07 x 10 ⁻²
Mirex	2 x 10 ⁻⁴	NA ^l	0.8	-
Toxaphene ^{im}	2.5 x 10 ⁻⁴	1.1	1.0	3.63 x 10 ⁻²
Organophosphate Pesticides				
Chlorpyrifos ⁿ	3 x 10 ⁻⁴	NA	1.2	-
Diazinon ^o	7 x 10 ⁻⁴	NA	2.8	-
Disulfoton	4 x 10 ⁻⁵	NA	0.16	-
Ethion	5 x 10 ⁻⁴	NA	2.0	-
Terbufos ^p	2 x 10 ⁻⁵	NA	0.08	-
Chlorophenoxy Herbicides				
Oxyfluorfen ^q	3 x 10 ⁻³	7.32 x 10 ⁻²	12	5.46 x 10 ⁻¹
PAHs^r	NA	7.3	-	5.47 x 10 ⁻³
PCBs				
Total PCBs ^s	2 x 10 ⁻⁵	2.0	0.08	0.02
Dioxins/furans^t	NA	1.56 x 10 ⁵	-	2.56 x 10 ⁻⁷

NA = Not available in EPA's Integrated Risk Information System (IRIS, 1999).

DDD = p,p'-dichlorodiphenyldichloroethane

DDT = p,p'-dichlorodiphenyltrichloroethane

DDE = p,p'-dichlorodiphenyldichloroethylene

PAH = Polycyclic aromatic hydrocarbon

PCB = Polychlorinated biphenyl

RfD = Oral reference dose (mg/kg-d)

CSF = Cancer slope factor (mg/kg-d)⁻¹

5. SCREENING VALUES FOR TARGET ANALYTES

Table 5-3. (continued)

- ^a Based on fish consumption rate of 17.5 g/d, 70kg body weight and, for carcinogens, 10⁻⁵ risk level and 70-yr lifetime. Unless otherwise noted, values listed are the most current oral RfDs and CSF in EPA's IRIS database (IRIS, 1999).
- ^b The shaded screening value (SV) is the recommended SV for each target analyte. States should note that the screening values listed may be below analytical detection limits achievable for some of the target analytes. Please see Table 8-4 for detection limits.
- ^c Total inorganic arsenic rather than total arsenic should be determined.
- ^d Because most mercury in fish and shellfish tissue is present primarily as methylmercury (NAS, 1991; Tollefson, 1989) and because of the relatively high cost of analyzing for methylmercury, it is recommended that total mercury be analyzed and the conservative assumption be made that all mercury is present as methylmercury. This approach is deemed to be most protective of human health and most cost-effective. The National Academy of Sciences conducted an independent assessment of the RfD for methylmercury. They concluded that "On the basis of its evaluation, the committee's consensus is that the value of EPA's current RfD for methylmercury, 0.1 µg/kg per day, is a scientifically justifiable level for the protection of human health".
- ^e The RfD value listed is for tributyltin oxide (IRIS, 1999).
- ^f The RfD and CSF values listed are derived from studies using technical-grade chlordane (IRIS, 1999) for the *cis*- and *trans*-chlordane isomers or the major chlordane metabolite, oxychlordane, or for the chlordane impurities *cis*- and *trans*-nonachlor. It is recommended that total chlordane be determined by summing the concentrations of *cis*- and *trans*-chlordane, *cis*- and *trans*-nonachlor, and oxychlordane.
- ^g The RfD value listed is for DDT. The CSF value (0.34) is for total DDT sum of DDT, DDE and DDD; the CSF value for DDD is 0.24. It is recommended that the total concentration of DDT include the 2,4'- and 4,4'-isomers of DDT and its metabolites, DDE and DDD.
- ^h The RfD value is from Office of Pesticide Programs Reregistration Eligibility Decision (RED) for Dicofol (EPA, 1998c).
- ⁱ The CSF for dicofol was withdrawn from IRIS pending further review by the CRAVE Agency Work Group (IRIS, 1999).
- ^j The RfD value listed is from the Office of Pesticide Program's Reference Dose Tracking Report (U.S. EPA, 1997).
- ^k IRIS (1999) has not provided a CSF for lindane. The CSF value listed for lindane was calculated from the water quality criteria (0.063 mg/L) (U.S. EPA, 1992f).
- ^l No CSF or cancer classification is available for mirex. This compound is undergoing further review by the CRAVE Agency Work Group (IRIS, 1999).
- ^m The RfD value has been agreed upon by the Office of Pesticide Programs and the Office of Water.
- ⁿ Because of the potential for adverse neurological developmental effects from chlorpyrifos, EPA recommends the use of a Population Adjusted Dose (PAD) of 3 x 10⁻⁵ for infants, children under the age of 6 years, and women ages 13 to 50 years (U.S. EPA, 2000b).
- ^o The RfD value is from a memorandum dated April 1, 1998, Diazinon:-Report of the Hazard Identification Assessment Review Committee. HED Doc. No. 012558.
- ^p The RfD value listed is from a memorandum dated September 25, 1997; Terbufos-FQPA Requirement- Report of the Hazard Identification Review.
- ^q The CSF value is from the Office of Pesticide Programs List of Chemicals Evaluated for Carcinogenic Potential (U.S. EPA, 1999b).
- ^r The CSF value listed is for benzo[a]pyrene. Values for other PAHs are not currently available in IRIS (1999). It is recommended that tissue samples be analyzed for benzo[a]pyrene and 14 other PAHs, and that the order-of-magnitude relative potencies given for these PAHs (Nisbet and LaGoy, 1992; U.S. EPA, 1993c) be used to calculate a potency equivalency concentration (PEC) for each sample (see Section 5.3.2.4).
- ^s Total PCBs may be determined as the sum of congeners or Aroclors. The RfD is based on Aroclor 1254 and should be applied to total PCBs. The CSF is based on a carcinogenicity assessment of Aroclors 1260, 1254, 1242, and 1016. The CSF presented is the upper-bound slope factor for food chain exposure. The central estimate is 1.0 (IRIS, 1999).
- ^t The CSF value listed is for 2,3,7,8-tetrachlorodibenzo-p-dioxin (TCDD) (HEAST, 1997). It is recommended that the 17 2,3,7,8-substituted tetra- through octa-chlorinated dibenzo-p-dioxins and dibenzofurans and the 12 dioxin-like PCBs be determined and a toxicity-weighted total concentration be calculated for each sample, using the method for estimating toxicity equivalency concentrations (TEQs) (Van den Berg et al., 1998).

5. SCREENING VALUES FOR TARGET ANALYTES

Table 5-4. Dose-Response Variables and Recommended Screening Values (SVs) for Target Analytes - Subsistence Fishers^a

Target analyte	Noncarcinogens RfD (mg/kg-d)	Carcinogens CSF (mg/kg-d) ⁻¹	SV ^b (ppm)	
			Noncarcinogens ^b	Carcinogens ^b (RL=10 ⁻⁵)
Metals				
Arsenic (inorganic) ^c	3 x 10 ⁻⁴	1.5	0.147	3.27 x 10 ⁻³
Cadmium	1 x 10 ⁻³	NA	0.491	-
Mercury (methylmercury) ^d	1 x 10 ⁻⁴	NA	0.049	-
Selenium	5 x 10 ⁻³	NA	2.457	-
Tributyltin ^e	3 x 10 ⁻⁴	NA	0.147	-
Organochlorine Pesticides				
Total chlordane (sum of cis- and trans-chlordane, cis- and trans-nonachlor, and oxychlordane) ^f	5 x 10 ⁻⁴	0.35	0.245	1.40 x 10 ⁻²
Total DDT (sum of 4,4'- and 2,4'- isomers of DDT, DDE, and DDD) ^g	5 x 10 ⁻⁴	0.34	0.245	1.44 x 10 ⁻²
Dicofol ^h	4 x 10 ⁻⁴	NA ⁱ	0.196	-
Dieldrin	5 x 10 ⁻⁵	16	0.024	3.07 x 10 ⁻⁴
Endosulfan (I and II) ^j	6 x 10 ⁻³	NA	2.949	-
Endrin	3 x 10 ⁻⁴	NA	0.147	-
Heptachlor epoxide	1.3 x 10 ⁻⁵	9.1	6.39 x 10 ⁻³	5.40 x 10 ⁻⁴
Hexachlorobenzene	8 x 10 ⁻⁴	1.6	0.393	3.07 x 10 ⁻³
Lindane (γ-hexachlorocyclohexane; γ-HCH) ^k	3 x 10 ⁻⁴	1.3	0.147	3.78 x 10 ⁻³
Mirex	2 x 10 ⁻⁴	NA ^l	0.098	-
Toxaphene ^{i,m}	2.5 x 10 ⁻⁴	1.1	0.122	4.46 x 10 ⁻³
Organophosphate Pesticides				
Chlorpyrifos ⁿ	3 x 10 ⁻⁴	NA	0.147	-
Diazinon ^o	7 x 10 ⁻⁴	NA	0.344	-
Disulfoton	4 x 10 ⁻⁵	NA	0.019	-
Ethion	5 x 10 ⁻⁴	NA	0.245	-
Terbufos ^p	2 x 10 ⁻⁵	NA	0.009	-
Chlorophenoxy Herbicides				
Oxyfluorfen ^q	3 x 10 ⁻³	7.32 x 10 ⁻²	1.474	6.71 x 10 ⁻²
PAHs^r	NA	7.3	-	6.73 x 10 ⁻⁴
PCBs				
Total PCBs ^s	2 x 10 ⁻⁵	2.0	9.83 x 10 ⁻³	2.45 x 10 ⁻³
Dioxins/furans^t	NA	1.56 x 10 ⁵	-	3.15 x 10 ⁻⁸

NA = Not available in EPA's Integrated Risk Information System (IRIS, 1999).

DDD = p,p'-dichlorodiphenyldichloroethane

DDT = p,p'-dichlorodiphenyltrichloroethane

DDE = p,p'-dichlorodiphenyldichloroethylene

PAH = Polycyclic aromatic hydrocarbon

PCB = Polychlorinated biphenyl

RfD = Oral reference dose (mg/kg-d)

CSF = Cancer slope factor (mg/kg-d)⁻¹

5. SCREENING VALUES FOR TARGET ANALYTES

Table 5-4. (continued)

- ^a Based on fish consumption rate of 142.4 g/d, 70kg body weight and, for carcinogens, 10⁻⁵ risk level and 70-yr lifetime. Unless otherwise noted, values listed are the most current oral RfDs and CSF in EPA's IRIS database (IRIS, 1999)
- ^b The shaded screening value (SV) is the recommended SV for each target analyte. States should note that the screening values listed may be below analytical detection limits achievable for some of the target analytes. Please see Table 8-4 for detection limits.
- ^c Total inorganic arsenic rather than total arsenic should be determined.
- ^d Because most mercury in fish and shellfish tissue is present primarily as methylmercury (NAS, 1991; Tollefson, 1989) and because of the relatively high cost of analyzing for methylmercury, it is recommended that total mercury be analyzed and the conservative assumption be made that all mercury is present as methylmercury. This approach is deemed to be most protective of human health and most cost-effective. The National Academy of Sciences conducted an independent assessment of the RfD for methylmercury. They concluded that "On the basis of its evaluation, the committee's consensus is that the value of EPA's current RfD for methylmercury, 0.1µg/kg per day, is a scientifically justifiable level for the protection of human health".
- ^e The RfD value listed is for tributyltin oxide (IRIS, 1999).
- ^f The RfD and CSF values listed are derived from studies using technical-grade chlordane (IRIS, 1999) for the *cis*- and *trans*-chlordane isomers or the major chlordane metabolite, oxychlordane, or for the chlordane impurities *cis*- and *trans*-nonachlor. It is recommended that total chlordane be determined by summing the concentrations of *cis*- and *trans*-chlordane, *cis*- and *trans*-nonachlor, and oxychlordane.
- ^g The RfD value listed is for DDT. The CSF value (0.34) is for total DDT sum of DDT, DDE and DDD; the CSF value for DDD is 0.24. It is recommended that the total concentration of DDT include the 2,4'- and 4,4'-isomers of DDT and its metabolites, DDE and DDD.
- ^h The RfD value is from Office of Pesticide Programs Reregistration Eligibility Decision (RED) for Dicofol (EPA, 1998c).
- ⁱ The CSF for dicofol was withdrawn from IRIS pending further review by the CRAVE Agency Work Group (IRIS, 1999).
- ^j The RfD value listed is from the Office of Pesticide Program's Reference Dose Tracking Report (U.S. EPA, 1997).
- ^k IRIS (1999) has not provided a CSF for lindane. The CSF value listed for lindane was calculated from the water quality criteria (0.063 mg/L) (U.S. EPA, 1992f).
- ^l No CSF or cancer classification is available for mirex. This compound is undergoing further review by the CRAVE Agency Work Group (IRIS, 1999)
- ^m The RfD value has been agreed upon by the Office of Pesticide Programs and the Office of Water.
- ⁿ Because of the potential for adverse neurological developmental effects from chlorpyrifos, EPA recommends the use of a Population Adjusted Dose (PAD) of 3 x 10⁻⁵ for infants, children under the age of 6 years, and women ages 13 to 50 years (U.S. EPA, 2000b).
- ^o The RfD value is from a memorandum dated April 1, 1998, Diazinon:-Report of the Hazard Identification Assessment Review Committee. HED Doc. No. 012558.
- ^p The RfD value listed is from a memorandum dated September 25, 1997; Terbufos-FQPA Requirement- Report of the Hazard Identification Review.
- ^q The CSF value is from the Office of Pesticide Programs List of Chemicals Evaluated for Carcinogenic Potential (U.S. EPA, 1999b).
- ^r The CSF value listed is for benzo[a]pyrene. Values for other PAHs are not currently available in IRIS (1999). It is recommended that tissue samples be analyzed for benzo[a]pyrene and 14 other PAHs, and that the order-of-magnitude relative potencies given for these PAHs (Nisbet and LaGoy, 1992; U.S. EPA, 1993c) be used to calculate a potency equivalency concentration (PEC) for each sample (see Section 5.3.2.4).
- ^s Total PCBs may be determined as the sum of congeners or Aroclors. The RfD is based on Aroclor 1254 and should be applied to total PCBs. The CSF is based on a carcinogenicity assessment of Aroclors 1260, 1254, 1242, and 1016. The CSF presented is the upper-bound slope factor for food chain exposure. The central estimate is 1.0 (IRIS, 1999).
- ^t The CSF value listed is for 2,3,7,8-tetrachlorodibenzo-p-dioxin (TCDD) (HEAST, 1997). It is recommended that the 17 2,3,7,8-substituted tetra- through octa-chlorinated dibenzo-p-dioxins and dibenzofurans and the 12 dioxin-like PCBs be determined and a toxicity-weighted total concentration be calculated for each sample, using the method for estimating toxicity equivalency concentrations (TEQs) (Van den Berg et al., 1998).

5. SCREENING VALUES FOR TARGET ANALYTES

the lower of the two SVs (generally, the SV for carcinogenic effects) should be used for the respective fisher population. EPA recommends that the SVs in the shaded boxes (Tables 5-3 and 5-4) be used by states when making the decision to implement Tier 2 intensive monitoring. However, states may choose to adjust these SVs for specific target analytes for the protection of sensitive populations (e.g., pregnant women, nursing mothers, and children or for recreational or subsistence fishers based on site-specific consumption rates). EPA recognizes that states may use higher CRs that are more appropriate for recreational and subsistence fishers in calculating SVs for use in their jurisdictions rather than the EPA default values of 17.5 g/d CR for recreational fishers used to calculate the SVs shown in Table 5-3 and the 142.4 g/d CR for subsistence fishers used to calculate the SVs shown in Table 5-4.

Note: States should use the same SV for a given target analyte in both screening and intensive studies. Therefore, it is critical that states clearly define their program objectives and accurately characterize the target fish-consuming population(s) of concern to ensure that appropriate SVs are selected. If the selected analytical methodology is not sensitive enough to reliably quantitate target analytes at or below selected SVs (see Section 8.2.2 and Table 8-4), program managers must determine appropriate fish consumption guidance based on the lowest detectable concentrations or provide justification for adjusting SVs to values at or above achievable method detection limits. It should be emphasized that when SVs are below method detection limits, the failure to detect a target analyte cannot be assumed to indicate that there is no cause for concern for human health effects.

States should recognize the importance of ensuring that the analytical method selected for quantification of any target analyte must have a method detection limit (MDL) lower than the risk-based screening values calculated using the EPA methodology for noncarcinogenic and carcinogenic effects of the target analyte. If the method detection limit for a specific target analyte is higher than the target analyte SV, the following procedure is recommended as a means to reduce the problem of interpreting data results for chemicals that fall in this category. For example, if fish tissue residue values for several replicate samples are above the MDL while other data values are reported as below the method detection limit (<MDL) including not detected (e.g., no observed response), the state may make a risk management decision to use a value of one-half the MDL as the residue concentration in their risk assessment for those data below the MDL rather than using a value of zero. In this way, the calculated mean target analyte concentration for a group of replicate samples may be higher than the SV. If all of the replicate samples from a particular monitoring site are below the MDL or are not detected, the state may choose to use one-half MDL value for all not detected values rather than a value of zero. The use of one-half MDL rather than zero for these data (< MDL) is a risk management policy decision that should be made by the state.

For noncarcinogens, adjusted SVs should be calculated from Equation 5-4 using appropriate alternative values of BW and/or CR. For carcinogens, adjusted SVs

should be calculated from Equation 5-5 using an RL ranging from 10^{-4} to 10^{-7} and/or sufficiently protective alternative values of BW and CR. Examples of SVs calculated for selected populations of concern and for RL values ranging from 10^{-4} to 10^{-7} are given in Table 5-5.

The need to accurately characterize the target fisher population of interest in order to establish sufficiently protective SVs cannot be overemphasized. For example, the recommended consumption rate of 142.4 g/d for subsistence fishers may be an underestimate of consumption rate and exposures for some subsistence populations such as Native American subsistence fishers (see Section 5.1.3.2). In a recent study of a Native American subsistence fishing population, an average daily consumption rate for these subsistence fishers was estimated to be 540 g/d (Harris and Harper, 1997). Using this average consumption rate and an estimated average body weight of 70 kg, the SV for cadmium (RfD = 1×10^{-3} mg/kg/d) is, from Equation 5-4,

$$SV = (0.001 \text{ mg/kg-d} \cdot 70 \text{ kg}) / (0.540 \text{ kg/d}) = 0.129 \text{ mg/kg (ppm)}. \quad (5-7)$$

This value is almost four times lower than the SV of 0.491 ppm for cadmium based on the EPA default consumption rate of 142.4 g/d for subsistence fishers, as shown in Table 5-4.

5.3 COMPARISON OF TARGET ANALYTE CONCENTRATIONS WITH SCREENING VALUES

As noted previously, the same SV for a specific target analyte should be used in both the screening and intensive studies. The measured concentrations of target analytes in fish or shellfish tissue should be compared with their respective SVs in both screening and intensive studies to determine the need for additional monitoring and risk assessment.

Recommended procedures for comparing target analyte concentrations with SVs are provided below. Related guidance on data analysis is given in Section 9.1.

5.3.1 Metals

5.3.1.1 Arsenic—

Most of the arsenic present in fish and shellfish tissue is organic arsenic, primarily pentavalent arsenobetaine, which has been shown in numerous studies to be metabolically inert and nontoxic (Brown et al., 1990; Cannon et al., 1983; Charbonneau et al., 1978; Bos et al., 1985; Kaise et al. 1985; Luten et al., 1982; Sabbioni et al., 1991; Siewicki, 1981; Bryce et al., 1982; Vahter et al., 1983; Yamauchi et al., 1986). Inorganic arsenic, which is of concern for human health effects (ATSDR, 1998a; WHO, 1989), is generally found in seafood at concentra-

5. SCREENING VALUES FOR TARGET ANALYTES

Table 5-5. Example Screening Values (SVs) for Various Target Populations and Risk Levels (RLs)^a

Chemical	Target population ^b	CR ^c	BW	RfD	CSF	RL	SV (ppm)
Noncarcinogens							
Chlorpyrifos	Recreational fisher	17.5	70	3×10^{-4}	—	—	1.2
	Children (<6 yr)	6.5	17 ^d	3×10^{-5e}	—	—	0.078
	Subsistence fisher	142.4	70	3×10^{-4}	—	—	0.147
Cadmium	Recreational fisher	17.5	70	1×10^{-3}	—	—	4.0
	Children	6.5	17 ^d	1×10^{-3}	—	—	2.6
	Subsistence fisher	142.4	70	1×10^{-3}	—	—	0.491
Carcinogens							
Lindane	Recreational fisher	17.5	70	—	1.3	10^{-4}	3.07×10^{-1}
					1.3	10^{-5}	3.07×10^{-2}
					1.3	10^{-6}	3.07×10^{-3}
					1.3	10^{-7}	3.07×10^{-4}
	Children	6.5	17 ^d	—	1.3	10^{-4}	1.98×10^{-1}
					1.3	10^{-5}	1.98×10^{-2}
					1.3	10^{-6}	1.98×10^{-3}
					1.3	10^{-7}	1.98×10^{-4}
	Subsistence fisher	142.4	70	—	1.3	10^{-4}	3.78×10^{-2}
					1.3	10^{-5}	3.78×10^{-3}
					1.3	10^{-6}	3.78×10^{-4}
					1.3	10^{-7}	3.78×10^{-5}
Toxaphene	Recreational fisher	17.5	70	—	1.1	10^{-4}	3.63×10^{-1}
					1.1	10^{-5}	3.63×10^{-2}
					1.1	10^{-6}	3.63×10^{-3}
					1.1	10^{-7}	3.63×10^{-4}
	Children	6.5	17 ^d	—	1.1	10^{-4}	2.35×10^{-1}
					1.1	10^{-5}	2.35×10^{-2}
					1.1	10^{-6}	2.35×10^{-3}
					1.1	10^{-7}	2.35×10^{-4}
	Subsistence fisher	142.5	70	—	1.1	10^{-4}	4.6×10^{-2}
					1.1	10^{-5}	4.6×10^{-3}
					1.1	10^{-6}	4.6×10^{-4}
					1.1	10^{-7}	4.6×10^{-5}

CR = Mean daily fish or shellfish consumption rate (uncooked weight), averaged over a 70-yr lifetime for the population of concern (g/d).

BW = Mean body weight, estimated for the population of concern (kg).

RfD = Oral reference dose for noncarcinogens (mg/kg-d).

CSF = Oral slope factor for carcinogens (mg/kg-d)⁻¹.

RL = Maximum acceptable risk level for carcinogens (dimensionless).

^a See Equations 5-4 and 5-5.

^b See Tables 5-1, 5-2, 5-3 and 5-4 for information on target populations.

^c To calculate SVs, the CRs given in this table must be divided by 1,000 to convert g/d to kg/d.

^d BW used is for children 3 to <6 yr (see Table 5-1).

^e Because of the potential for adverse neurological developmental effects, EPA recommends the use of a Population Adjusted Dose for chlorpyrifos of 3×10^{-5} mg/kg-d for infants, children to the age of 6, and women ages 13 to 50 years (U.S. EPA, 2000b).

tions ranging from <1 to 20 percent of the total arsenic concentration (Edmonds and Francesconi, 1993; Nraigu and Simmons, 1990). It is recommended that, in both screening and intensive studies, total inorganic arsenic tissue concentrations be determined for comparison with the recommended SV for chronic oral exposure. This approach is more rigorous than the current FDA-recommended method of analyzing for total arsenic and estimating inorganic arsenic concentrations based on the assumption that 10 percent of the total arsenic in fish tissue is in the inorganic form (U.S. FDA, 1993). Although the cost of analysis for inorganic arsenic (see Table 8-5) may be three to five times greater than for total arsenic, the increased cost is justified to ensure that the most accurate data are obtained for quantitative assessment of human health risks.

5.3.1.2 Cadmium, Mercury, and Selenium—

For cadmium, mercury, and selenium, the total metal tissue concentration should be determined for comparison with the appropriate target population SV.

Because most mercury in fish and shellfish tissue is present as methylmercury (Kannan et al., 1998; NAS, 1991; Tollefson, 1989), and because of the relatively high analytical cost for methylmercury, it is recommended that total mercury be determined and the conservative assumption be made that all mercury is present as methylmercury. The determination of methylmercury in fish tissue is not recommended even though methylmercury is the compound of greatest concern for human health (NAS, 1991; Tollefson, 1989) and the recommended SVs are for methylmercury (see Tables 5-3 and 5-4). This approach is deemed to be most protective of human health and most cost-effective.

5.3.1.3 Tributyltin—

Tissue samples should be analyzed specifically for tributyltin for comparison with the recommended target population SVs for this compound (see Tables 5-3 and 5-4).

5.3.2 Organics

For each of the recommended organic target analytes that are single compounds, the determination of tissue concentration and comparison with the appropriate SV is straightforward. However, for those organic target analytes that include a parent compound and structurally similar compounds or metabolites (i.e., total chlordane, total DDT, endosulfan I and II) or that represent classes of compounds (i.e., PAHs, PCBs, dioxins/furans, or toxaphene), additional guidance is necessary to ensure that a consistent approach is used to determine appropriate target analyte concentrations for comparison with recommended SVs.

5.3.2.1 Chlordane—

The SVs for total chlordane are derived from technical-grade chlordane. Oral cancer slope factors are not available in IRIS (1999) for *cis*- and *trans*-chlordane, *cis*- and *trans*-nonachlor, and oxychlordane. At this time, as a conservative approach, EPA recommends that, in both screening and intensive studies, the concentrations of all chlordane constituents (*cis*- and *trans*-chlordane, *cis*- and *trans*-nonachlor) and the metabolite of chlordane (oxychlordane) be determined and summed to give a total chlordane concentration for comparison with the recommended SVs (see Tables 5-3 and 5-4).

5.3.2.2 DDT—

DDT and its metabolites (i.e., the 4,4'- and 2,4'-isomers of DDE and DDD) are all potent toxicants, DDE isomers being the most prevalent in the environment. As a conservative approach, EPA recommends that, in both screening and intensive studies, the concentrations of 4,4'- and 2,4'-DDT and their 4,4' and 2,4'-DDE and DDD metabolites be determined and a total DDT concentration be calculated for comparison with the recommended SVs for total DDT (see Tables 5-3 and 5-4).

5.3.2.3 Endosulfan—

Endosulfan collectively refers to two stereoisomers designated I and II. At this time, for both screening and intensive studies, EPA recommends that the concentrations of the two endosulfan constituents (endosulfan I and II) be determined and summed to give a total endosulfan concentration for comparison with the recommended SVs for total endosulfan.

5.3.2.4 Toxaphene—

The SVs for toxaphene are derived from technical-grade toxaphene, a mixture of approximately 670 chlorinated camphenes (ATSDR, 1996). At this time, determination of total toxaphene is recommended rather than individual congener analysis. Research is currently under way to determine the relative health risks of the toxaphene congeners. In the future, it may be possible to develop a congener-specific quantitative risk assessment approach for toxaphene similar to that for PCBs and dioxins/furans. The total toxaphene concentration should be analyzed for comparison with the recommended SVs for toxaphene (see Tables 5-3 and 5-4).

5.3.2.5 PAHs—

Although several PAHs have been classified as B2 carcinogens (probable human carcinogens), benzo[a]pyrene is the only PAH for which a CSF is currently available in IRIS (1999). As a result, EPA quantitative risk estimates for PAH mixtures have often assumed that all carcinogenic PAHs are equipotent to benzo[a]pyrene. The EPA Office of Health and Environmental Assessment has

5. SCREENING VALUES FOR TARGET ANALYTES

issued guidance for quantitative risk assessment of PAHs (Nisbet and LaGoy, 1992; U.S. EPA, 1993c) in which an estimated order of potential potency for 14 PAHs relative to benzo[a]pyrene is recommended, as shown in Table 5-6. Based on this guidance, EPA recommends that, in both screening and intensive studies, tissue samples be analyzed for the PAHs shown in Table 5-6 and that a potency-weighted total concentration be calculated for each sample for comparison with the recommended SVs for benzo[a]pyrene (see Tables 5-3 and 5-4). This potency equivalency concentration should be calculated using the following equation:

$$PEC = \sum_i (RP_i \cdot C_i) \tag{5-8}$$

where

- RP_i = Relative potency for the ith PAH (from Table 5-6)
- C_i = Concentration of the ith PAH.

Table 5-6. Toxicity Equivalency Factors for Various PAHs

Compound	Toxicity Equivalency Factor (TEF)
Dibenz[<i>a,h</i>]anthracene	5
Benzo[<i>a</i>]pyrene	1
Benz[<i>a</i>]anthracene	0
Benzo[<i>b</i>]fluoranthene	0.1
Benzo[<i>k</i>]fluoranthene	0.1
Indeno[1,2,3- <i>cd</i>]pyrene	0.1
Anthracene	0.01
Benzo[<i>g,h,i</i>]perylene	0.01
Chrysene	0.01
Acenaphthene	0.001
Acenaphthylene	0.001
Fluoranthene	0.001
Fluorene	0.001
Phenanthrene	0.001
Pyrene	0.001

Source: Nisbet and LaGoy (1992).

5.3.2.6 PCBs—

Using the approach for PCB analysis recommended by the EPA Office of Water (see Section 4.3.6), total PCB concentrations may be determined as the sum of Aroclor equivalents in screening studies. For intensive studies, the total PCB concentration should be determined as the sum of PCB congeners or the sum of homologue groups. The total PCB concentration should be compared with the recommended SVs for PCBs (see Tables 5-3 and 5-4). The EPA Office of Water recognizes the potential problems associated with PCB congener analysis (i.e.,

standard methods are not yet available but are under development, relatively high analytical cost, and limited number of qualified laboratories), but is recommending these methods for intensive studies because Aroclor analysis does not adequately represent bioconcentrated PCB mixtures found in fish tissue. EPA has developed a draft method for selected PCB congeners (Method 1668) (U.S. EPA, 1997a). This method is being tested and may be revised to include all PCB congeners. Currently, Method 680 is available for PCB homologue analysis.

5.3.2.7 Dioxins and Dibenzofurans—

Note: At this time, EPA's Office of Research and Development is reevaluating the potency of dioxins/furans. Consequently, the following recommendation may change pending the results of this reevaluation.

It is recommended in both screening and intensive studies that the 17 2,3,7,8-substituted tetra- through octa-chlorinated PCDDs and PCDFs and the 12 coplanar congeners with dioxin-like effects be determined and that a toxicity-weighted total concentration be calculated for each sample for comparison with the recommended SVs for 2,3,7,8-TCDD (see Tables 5-3 and 5-4).

The method for estimating total TEQ (Van den Berg et al., 1998) should be used to estimate TCDD equivalent concentrations according to the following equation:

$$TEQ = \sum_i (TEF_i \cdot C_i) \quad (5-9)$$

where

TEF_i = Toxicity equivalency factor for the i th congener (relative to 2,3,7,8-TCDD)

C_i = Concentration of the i th congener.

TEFs for the 2,3,7,8-substituted tetra- through octa-PCDDs and PCDFs and the 12 dioxin-like PCBs are shown in Table 5-7. Note: TEFs for five congeners have changed over those TEFs recommended by Barnes and Bellin (1989).

5. SCREENING VALUES FOR TARGET ANALYTES

Table 5-7. Toxicity Equivalency Factors (TEFs) for Tetra- through Octa-Chlorinated Dibenzo-p-Dioxins and Dibenzofurans and Dioxin-Like PCBs

Analyte	Old TEF-89	TEF-98
Dioxins^a		
2,3,7,8-TCDD	1.00	1.00
1,2,3,7,8-PeCDD	0.50	1.00*
1,2,3,4,7,8-HxCDD	0.10	0.10
1,2,3,6,7,8-HxCDD	0.10	0.10
1,2,3,7,8,9-HxCDD	0.10	0.10
1,2,3,4,6,7,8-HpCDD	0.01	0.01
OCDD	0.001	0.0001*
Furans^a		
2,3,7,8-TCDF	0.10	0.10
1,2,3,7,8-PeCDF	0.05	0.05
2,3,4,7,8-PeCDF	0.50	0.50
1,2,3,4,7,8-HxCDF	0.10	0.10
1,2,3,6,7,8-HxCDF	0.10	0.10
1,2,3,7,8,9-HxCDF	0.10	0.10
2,3,4,6,7,8-HxCDF	0.10	0.10
1,2,3,4,6,7,8-HpCDF	0.01	0.01
1,2,3,4,7,8,9-HpCDF	0.01	0.01
OCDF	0.001	0.0001*
PCBs		
3,3',4,4'-TetraCB (77)	0.0005	0.0001*
3,4,4',5-TetraCB (81)	not available	0.0001*
2,3,3',4,4'-PentaCB (105)	0.0001	0.0001
2,3,4,4',5-PentaCB (114)	0.0005	0.0005
2,3',4,4',5-PentaCB (118)	0.0001	0.0001
2',3,4,4',5-PentaCB (123)	0.0001	0.0001
3,3',4,4',5-PentaCB (126)	0.1	0.1
2,3,3',4,4',5-HexaCB (156)	0.0005	0.0005
2,3,3',4,4',5'-HexaCB (157)	0.0005	0.0005
2,3,4,4',5,5'-HexaCB (167)	0.00001	0.00001
3,3',4,4',5,5'-HexaCB (169)	0.01	0.01
2,3,3',4,4',5,5--HexaCB (189)	0.0001	0.0001

Sources: Barnes and Bellin, 1989; Van den Berg et al., 1998.

*Note: TEF-98 value changed from TEF-89 value.

^aTEFs for all non-2,3,7,8-substituted congeners are zero.

SECTION 6

FIELD PROCEDURES

This section provides guidance on sampling design of screening and intensive studies and recommends field procedures for collecting, preserving, and shipping samples to a processing laboratory for target analyte analysis. Planning and documentation of all field procedures are emphasized to ensure that collection activities are cost-effective and that sample integrity is preserved during all field activities. This section also describes the implications that result when deviations occur in the recommended study design. Some of the deviations in study design most likely to occur include the use of unequal numbers of fish in composite samples, unequal numbers of replicate samples collected at different stations, and sizes of fish within a composite sample exceeding the recommendation for composite samples.

6.1 SAMPLING DESIGN

Prior to initiating a screening or intensive study, the program manager and field sampling staff should develop a detailed sampling plan. As described in Section 2, there are seven major parameters that must be specified prior to the initiation of any field collection activities:

- Site selection
- Target species (and size class)
- Target analytes
- Target analyte screening values
- Sampling times
- Sample type
- Replicate samples.

In addition, personnel roles and responsibilities in all phases of the fish and shellfish sampling effort should be defined clearly. All aspects of the final sampling design for a state's fish and shellfish contaminant monitoring program should be documented clearly by the program manager in a Work/QA Project Plan (see Appendix I). Routine sample collection procedures should be prepared as standard operating procedures (U.S. EPA, 1984b) to document the specific methods used by the state and to facilitate assessment of final data quality and comparability.

The seven major parameters of the sampling plan should be documented on a sample request form prepared by the program manager for each sampling site. The sample request form should provide the field collection team with readily available information on the study objective, site location, site name/number, target species and alternate species to be collected, target analytes to be evaluated, anticipated sampling dates, sample type to be collected, number and

size range of individuals to be collected for each composite sample, sampling method to be used, and number of replicates to be collected. An example of a sample request form is shown in Figure 6-1. The original sample request form should be filed with the program manager and a copy kept with the field logbook. The seven major parameters that must be specified in the sampling plan for screening and intensive studies are discussed in Sections 6.1.1 and 6.1.2, respectively.

6.1.1 Screening Studies (Tier 1)

The primary aim of screening studies is to identify frequently fished sites where commonly consumed fish and shellfish species are chemically contaminated and may pose a risk to human health. Ideally, screening studies should include all waterbodies where commercial, recreational, or subsistence fishing and shellfish harvesting are practiced.

6.1.1.1 Site Selection—

Sampling sites should be selected to identify extremes of the bioaccumulation spectrum, ranging from presumed undisturbed reference sites to sites where existing data (or the presence of potential pollutant sources) suggest significant chemical contamination. Where resources are limited, states initially should target those harvest sites suspected of having the highest levels of contamination and of posing the greatest potential health risk to local fish and shellfish consumers. Screening study sites should be located in frequently fished areas near

- Point source discharges such as
 - Industrial or municipal discharges
 - Combined sewer overflows (CSOs)
 - Urban storm drains
- Nonpoint source inputs such as
 - Landfills, Resource Conservation and Recovery Act (RCRA) sites, or Superfund Comprehensive Environmental Response, Compensation, and Liability Act (CERCLA) sites
 - Areas of intensive agricultural, silvicultural, or resource extraction activities or urban land development
 - Areas receiving inputs through multimedia mechanisms such as hydrogeologic connections or atmospheric deposition (e.g., areas affected by acid rain impacts, particularly lakes with pH <6.0 since elevated mercury concentrations in fish have been reported for such sites)
- Areas acting as potential pollutant sinks where contaminated sediments accumulate and bioaccumulation potential might be enhanced (i.e., areas where water velocity slows and organic-rich sediments are deposited)
- Areas where sediments are disturbed by dredging activities

Sample Request Form	
Project Objective <input type="checkbox"/> Screening Study	<input type="checkbox"/> Intensive Study
Sample Type <input type="checkbox"/> Fish fillets only <input type="checkbox"/> Shellfish (edible portions) <i>(Specify portions if other than whole _____)</i> <input type="checkbox"/> Whole fish or portions other than fillet <i>(Specify tissues used if other than whole _____)</i>	<input type="checkbox"/> Fish fillets only <input type="checkbox"/> Shellfish (edible portions) <i>(Specify portions if other than whole _____)</i> <input type="checkbox"/> Whole fish or portions other than fillet <i>(Specify tissues used if other than whole _____)</i>
Target Contaminants <input type="checkbox"/> All target contaminants <input type="checkbox"/> Additional contaminants <i>(Specify _____)</i>	<input type="checkbox"/> Contaminants exceeding screening study SVs <i>(Specify _____)</i>
INSTRUCTIONS TO SAMPLE COLLECTION TEAM	
Project Number: _____ Site (Name/Number): _____ County/Parish: _____ Lat./Long.: _____ Target Species: _____ Alternate Species: <i>(in order of preference)</i> <input type="checkbox"/> Freshwater _____ <input type="checkbox"/> Estuarine _____ _____ Proposed Sampling Dates: _____ Proposed Sampling Method: _____ <input type="checkbox"/> Electrofishing <input type="checkbox"/> Mechanical grab or tongs <input type="checkbox"/> Seining <input type="checkbox"/> Biological dredge <input type="checkbox"/> Trawling <input type="checkbox"/> Hand collection <input type="checkbox"/> Other <i>(Specify _____)</i>	
Number of Sample Replicates: <input type="checkbox"/> No field replicates (1 composite sample only) <input type="checkbox"/> _____ field replicates <i>(Specify number for each target species)</i>	
Number of Individuals per Composite: _____ Fish per composite _____ Shellfish per composite <i>(specify number to obtain 200 grams of tissue)</i>	

Figure 6-1. Example of a sample request form.

- Unpolluted areas that can serve as reference sites for subsequent intensive studies or as "green areas" that states can designate for unrestricted consumption (see Appendix B). **Note:** Michigan sampled lakes that were in presumed unpolluted areas but discovered mercury contamination in fish from many of these areas and subsequently issued a fish consumption advisory for all of its inland lakes.

The procedures required to identify candidate screening sites near significant point source discharges are usually straightforward. It is often more difficult, however, to identify clearly defined candidate sites in areas affected by pollutants from nonpoint sources. For these sites, assessment information summarized in state Section 305(b) reports should be reviewed before locations are selected. State 305(b) reports are submitted to the EPA Assessment and Watershed Protection Division biennially and provide an inventory of the water quality in each state. The 305(b) reports often contain Section 319 nonpoint source assessment information that may be useful in identifying major sources of nonpoint source pollution to state waters. States may also use a method for targeting pesticide hotspots in estuarine watersheds that employs pesticide use estimates from NOAA's National Coastal Pollutant Discharge Inventory (Farrow et al., 1989).

It is important for states to identify and document at least a few unpolluted sites, particularly for use as reference sites in subsequent monitoring studies. Verification that targeted reference sites show acceptably low concentrations of contaminants in fish or shellfish tissues also provides at least partial validation of the methods used to select potentially contaminated sites. Clear differences between the two types of sites support the site-selection methodology and the assumptions about primary sources of pollution.

In addition to the intensity of subsistence, sport, or commercial fishing, factors that should be evaluated (Versar, 1982) when selecting fish and shellfish sampling sites include

- Proximity to water and sediment sampling sites
- Availability of data on fish or shellfish community structure
- Bottom condition
- Type of sampling equipment
- Accessibility of the site.

The most important benefit of locating fish or shellfish sampling sites near sites selected for water and sediment sampling is the possibility of correlating contaminant concentrations in different environmental compartments (water, sediment, and fish). Selecting sampling sites in proximity to one another is also more cost-effective in that it provides opportunities to combine sampling trips for different matrices.

Availability of data on the indigenous fish and shellfish communities should be considered in final site selection. Information on preferred feeding areas and

migration patterns is valuable in locating populations of the target species (Versar, 1982). Knowledge of habitat preference provided by fisheries biologists or commercial fishermen may significantly reduce the time required to locate a suitable population of the target species at a given site.

Bottom condition is another site-specific factor that is closely related to the ecology of a target fish or shellfish population (Versar, 1982). For example, if only soft-bottom areas are available at an estuarine site, neither oysters (*Crassostrea virginica*) nor mussels (*Mytilus edulis* and *M. californianus*) would likely be present because these species prefer hard substrates. Bottom condition also must be considered in the selection and deployment of sampling equipment. Navigation charts provide depth contours and the locations of large underwater obstacles in coastal areas and larger navigable rivers. Sampling staff might also consult commercial fishers familiar with the candidate site to identify areas where the target species congregates and the appropriate sampling equipment to use.

Another factor closely linked to equipment selection is the accessibility of the sampling site. For some small streams or land-locked lakes (particularly in mountainous areas), it is often impractical to use a boat (Versar, 1982). In such cases the sampling site should have good land access. If access to the site is by land, consideration should be given to the type of vegetation and local topography that could make transport of collection equipment difficult. If access to the sampling site is by water, consideration should be given to the location of boat ramps and marinas and the depth of water required to deploy the selected sampling gear efficiently and to operate the boat safely. Sampling equipment and use are discussed in detail in Section 6.2.1.

The selection of each sampling site must be based on the best professional judgment of the field sampling staff. Once the site has been selected, it should be plotted and numbered on the most accurate, up-to-date map available. Recent 7.5-minute (1:24,000 scale) maps from the U.S. Geologic Survey or blue line maps produced by the U.S. Army Corps of Engineers are of sufficient detail and accuracy for sample site mapping. The type of sampling to be conducted, water depth, and estimated time to the sampling site from an access point should be noted. The availability of landmarks for visual or range fixes should be determined for each site, and biological trawl paths (or other sampling gear transects) and navigational hazards should be indicated. Additional information on site-positioning methods, including Loran-C, VIEWNAV, TRANSIT (NAVSAT), GEOSTAR, and the NAVSTAR Global Positioning System (GPS), is provided in Battelle (1986), Tetra Tech (1986), and Puget Sound Estuary Program (1990a).

Each sampling site must be described accurately because state fish and shellfish contaminant monitoring data may be stored in a database available to users nationwide (see Section 9.2). For example, a sampling site may be defined as a 2-mile section of river (e.g., 1 mile upstream and 1 mile downstream of a reference point) or a 2-mile stretch of lake or estuarine/marine shoreline (U.S. EPA, 1990d). Each sampler should provide a detailed description of each site

using a 7.5-minute USGS map to determine the exact latitude and longitude coordinates for the reference point of the site. This information should be documented on the sample request form and field record sheets (see Section 6.2.3).

One additional consideration associated with sample site selection is whether the sampling area includes waters inhabited by threatened or endangered species. If such waterbodies are to be monitored, the state must obtain a permit from the U.S. Fish and Wildlife Service (USFWS) if their sampling effort could potentially impact a freshwater species (U.S. DOI, 1999) or from the National Marine Fisheries Service (NMFS) if their sampling effort could potentially impact any marine or anadromous species (U.S. DOC, 1999a, 1999b) covered under the Endangered Species Act (ESA) of 1973.

A species is listed under one of two categories, endangered or threatened, depending on its status and the degree of threat it faces. An endangered species is one that is in danger of extinction throughout all or a significant portion of its range. A threatened species is one that is likely to become endangered in the foreseeable future. The U.S. Fish and Wildlife Service maintains a list of all plant and animal species native to the United States that are candidates or proposed for possible addition to the Federal List. A complete listing of the current status of all threatened and endangered species as well as information about each USFWS region is available on-line on the USFWS website at <http://endangered.fws.gov/wildlife.html>

Species information is also available by USFWS region having primary responsibility for that species. The seven major USFWS regions with their respective states are shown in Figure 6-2. States can obtain additional information by contacting the specific USFWS regional office and talking with the regional liaison for endangered species.

Freshwater Threatened and Endangered Species

State conservation agencies typically have cooperative agreements in place with the U.S. Fish and Wildlife Service. Under these agreements, any qualified employee of the state agency may take those endangered species covered by the cooperative agreement for conservation programs. Such taking of these species may be done provided it does not result in the following:

- Death or permanent disabling of the specimen
- Removal of the specimen from the state where the taking occurred
- Introduction of the specimen so taken, or of any progeny derived from the specimen, into an area beyond the historical range of the species
- Holding of the specimen in captivity for a period of more than 45 consecutive days.

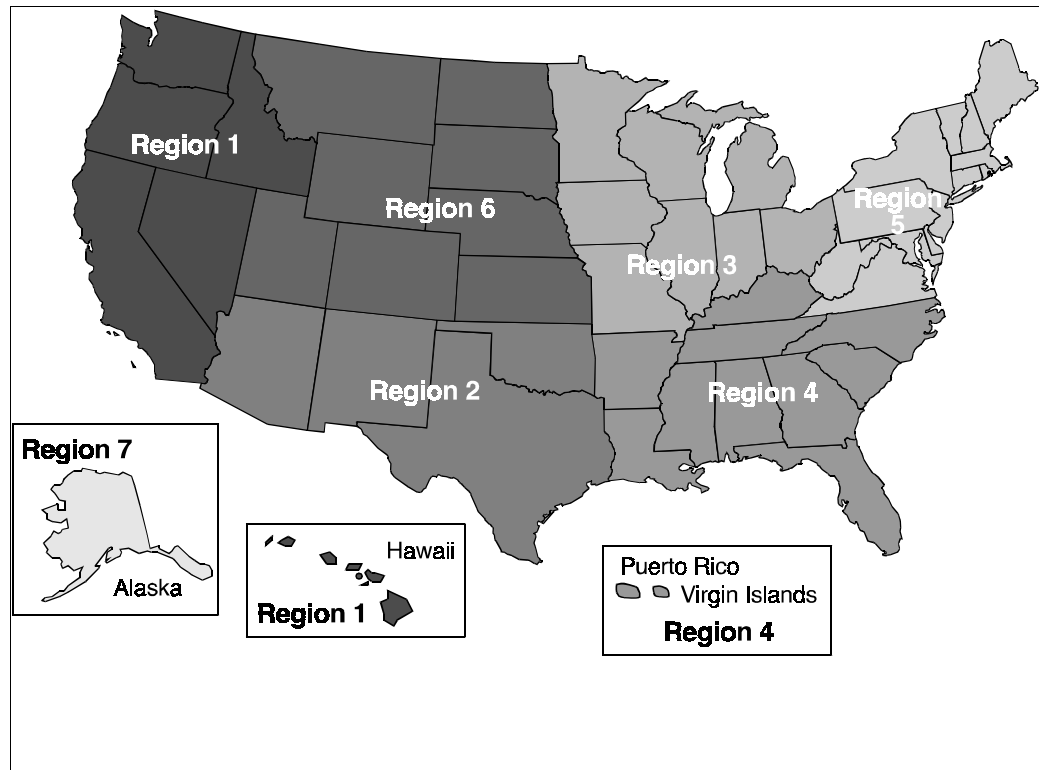

Figure 6-2. U.S. Fish and Wildlife Service Regions.

Additionally, any employee of a state conservation agency that is operating a conservation program with the USFWS (in accordance with section 6(c) of the Endangered Species Act) may take those threatened species of wildlife that are covered by an approved cooperative agreement to carry out conservation programs.

State agencies involved in designing and conducting fish sampling programs in freshwater systems may need to sample fish for human health risk assessments from areas inhabited by threatened or endangered species. In some of these waterbodies under study, threatened or endangered species may be collected incidental to the primary sampling objective. In these cases, the state agency involved in the primary sampling needs to check with the state conservation agency to determine whether a cooperative agreement between the state and the USFWS is in effect. Any questions about the permits for incidental taking of endangered or threatened species resulting from fish sampling programs should be reviewed with the appropriate USFWS regional endangered species liaison officer. If appropriate, the state must apply to the USFWS for an Incidental Take Permit (U.S. DOI, 1999). States are required to submit information on USFWS Form 3-200 with all of the following information provided as part of the permit application:

- A complete description of the sampling activity sought to be authorized
- The common and scientific names of the species sought to be covered by the permit, as well as the number, age, and sex of such species, if known.

The application must also include a conservation plan that specifies

- The impact that will likely result from such incidental taking
- What steps the applicant will take to monitor, minimize, and mitigate such impacts, the funding that will be available to implement such steps, and the procedures to be used to deal with unforeseen circumstances
- What alternative actions to such incidental taking the applicant considered and the reasons why such alternatives are not proposed to be used
- Such other measures that the Director may require as being necessary or appropriate for purposes of the plan.

The completed application should be submitted to

U.S. Fish and Wildlife Service
Ecological Services/Endangered Species Permits
Attention: Regional Permit Coordinator
(see addresses below for each of the seven USFWS regional offices)

Region 1
Pacific Region
Eastside Federal Complex
911 NE 11th Avenue
Portland, OR 97232-4181

Region 2
Southwest Region
P.O. Box 1306
Albuquerque, NM 87103-1306

Region 3
Great Lakes and Big Rivers Region
1 Federal Drive
BHW Federal Building
Fort Snelling, MN 55111

Region 4
Southeast Region
1875 Century Boulevard, Suite 400
Atlanta, GA 30345-3319

Region 5
Northeast Region
300 Westgate Center Drive
Hadley, MA 01035-9589

Region 6
Mountain Prairie Region
134 Union Boulevard
Lakewood, CO 80228

Region 7
Alaska Region
300 Vintage Boulevard, Suite 201
Juneau, AK 99801-7125

States should expect to wait from 3 to 6 months to obtain such a permit and should plan and schedule their permit application submission accordingly.

Marine or Anadromous Threatened and Endangered Species

Each state that intends to sample fish as part of their tissue residue monitoring program and might collect endangered or threatened marine or anadromous species incidental to the purpose of their monitoring effort, must apply to the NMFS for an Incidental Take Permit (U.S. DOC, 1999a). Application forms and detailed instructions for completing these permit applications are available for downloading on the Internet at url:

http://www.nmfs.noaa.gov/prot_res/PR3/Permits/ESAPermit.html. Users should click on <<Incident Take of Listed Species>> under Activity Category and select the PDF or HTML instructions.

States are required to submit information about the following:

- Type of permit
- Date of application
- Name, address, telephone, and fax number of the applicant
- A description of the endangered or threatened species, by common and scientific name, and a description of the status distribution, seasonal distribution, habitat needs, feeding habits, and other biological requirements of the affected species
- A detailed description of the proposed sampling activity, including
 - Anticipated dates and duration of sampling activity
 - Specific location of the activity (latitude and longitude coordinates)
 - An estimate of the total level of activity expected to be conducted

The application must also include a conservation plan based on the best scientific and commercial data available, which specifies

- Anticipated impact of the proposed activity on the listed species, including
 - Estimated number of animals of the listed species and, if applicable, the subspecies or population group and range
 - Type of anticipated taking, such as harassment, predation, competition for space and food, etc.
 - Effects of the take on the listed species, such as descaling, altered spawning activities, potential for mortality

- Anticipated impact of the proposed activity on the habitat of the species and the likelihood of restoration of the affected habitat
- Steps that will be taken to monitor, minimize, and mitigate such impacts, including
 - Specialized equipment, methods of conducting activities, or other means.
 - Detailed monitoring plans
 - Funding available to implement measures taken to monitor, minimize, and mitigate impacts.
- Alternative actions to such taking that were considered and the reasons why those alternatives are not being used.
- A list of all sources of data used in preparation of the plan, including reference reports, environmental assessments and impact statements, and personal communications with recognized experts on the species or activity who may have access to data not published in the current literature.

The application may be submitted electronically if possible (either by e-mail or by mailing a diskette), but one signed original of the complete application must be sent to

Chief, Endangered Species Division
National Marine Fisheries Service, F/PR3
1315 East-West Highway
Silver Spring, Maryland 20910
Telephone (301) 713-1401, Fax (301) 713-0376

States should expect to wait from 3 to 6 months to obtain such a permit and should plan and schedule their permit application submission accordingly.

Threatened or Endangered Sea Turtles

States planning on sampling fish in marine waters inhabited by threatened or endangered species of sea turtles must apply to the NMFS for a Sea Turtle Incidental Take Permit (U.S. DOC, 1999b).

Application forms and detailed instructions for completing these permit applications are available for downloading on the Internet at http://www.nmfs.noaa.gov/prot_res/PR3/Permits/ESAPermit.html.

States are required to submit a cover letter including information on the following:

- Type of permit
- Date of application

- Name, address, telephone, and fax number of the applicant
- A description of each endangered or threatened sea turtle species impacted by the activity, by common and scientific name, and a description of the status, geographic distribution, seasonal distribution, habitat needs, feeding habits, and other biological requirements of the affected species
- A detailed description of the proposed sampling activity (fishery season), including
 - Anticipated dates and duration of sampling activity
 - Specific location of the activity (latitude and longitude coordinates) and fishery effort in that area
 - Other relevant information (e.g., gear description.)

The application must also submit a Conservation Plan based on the best scientific and commercial data available. The Conservation Plan must emphasize techniques, gear types, and general practices to mitigate takes. The Conservation Plan may involve development of new gear types or modification of fishing practices and include the following information

- Anticipated impact of the activity on the listed species of sea turtle, including
 - Estimated number of animals of the listed species impacted, their geographic range, and, if applicable, the subspecies or population group,
 - Type of anticipated taking, such as capture, harassment, predation, competition for space and food, nature of injury
 - Effects of the impact on the listed species, such as descaling, altered reproductive activities, potential for mortality, effects of repeated submergence
- Anticipated impact of the proposed activity on the habitat of the species and the likelihood of restoration of the affected habitat
- Steps that will be taken to monitor, minimize, and mitigate such impacts, including
 - Detailed monitoring plans (e.g., observer programs)
 - Detailed enforcement plans (e.g., monitoring Turtle Excluder Device compliance)
 - Specialized equipment, methods of conducting activities, or other mitigation techniques.
 - Detailed funding plan to implement measures taken to monitor, minimize, and mitigate impacts.
- Alternatives to the activity considered and the reasons why those alternatives are not being used.

- A list of all sources of data used in preparation of the plan, including reference reports, environmental assessments and impact statements, and personal communications with recognized experts on the species or activity who may have access to data not published in the current literature.
- Other measures the Assistant Administrator of NMFS may require as necessary or appropriate for the purposes of the plan.

The following criteria are considered for permit issuance:

- Status of the stock and/or species to be incidentally taken
- Likely direct and indirect impacts of the activity on sea turtles
- Availability and effectiveness of monitoring and enforcement programs
- Public comments received during the 30-day public notice and comment period
- Adequate funding for the Conservation Plan
- The fact that taking will not appreciably reduce the likelihood of survival and recovery of the species in the wild.

An issued permit would

- Require regular reporting and rights of inspection
- Identify species and number of animals allowed to be taken incidentally
- Specify the authorized method of incidental taking
- Require procedures for captured sea turtles (i.e., resuscitation techniques, disposal)
- Potentially impose administrative fees
- Establish duration of the permit
- Specify any other terms or conditions that the Assistant Administrator of NMFS identifies as necessary or appropriate
- The application may be submitted electronically if possible (either by e-mail or by mailing a diskette), but one signed original of the complete application must be sent to

Chief, Endangered Species Division
National Marine Fisheries Service, F/PR
1315 East-West Highway
Silver Spring, Maryland 20910
Telephone (301) 713-1401, Fax (301) 713-0376

States should expect to wait from 3 to 6 months to obtain such a permit and should plan and schedule their permit application submission accordingly.

6.1.1.2 Target Species and Size Class Selection—

After reviewing information on each sampling site, the field collection staff should identify the target species that are likely to be found at the site. Target species recommended for screening studies in freshwater systems are shown in Tables 3-1, 3-2, and 3-4. Tables 3-10 through 3-16 list recommended species for estuarine/marine areas. In freshwater ecosystems, one bottom-feeding and one predator fish species should be collected. In estuarine/marine ecosystems, either one bivalve species and one finfish species or two finfish species should be collected. Second- and third-choice target species should be selected in the event that the recommended target species are not collected at the site. The same criteria used to select the recommended target species (Section 3.2) should be used to select alternate target species. In all cases, the primary selection criterion should be that the target species is commonly consumed locally and is of harvestable size.

EPA recognizes that resource limitations may influence the sampling strategy selected by a state. If monitoring resources are severely limited, precluding performance of any Tier 2 intensive studies (Phase I and Phase II), EPA recommends three sampling options to states for collecting additional samples during the screening studies. These options are:

1. Collecting one composite sample for each of three size (age) classes of each target species
2. Collecting replicate composite samples for each target species
3. Collecting replicate composite samples for each of three size (age) classes of each target species.

Option 1 (single composite analysis for each of three size classes) provides additional information on size-specific levels of contamination that may allow states to issue an advisory for only the most contaminated size classes while allowing other size classes of the target species to remain open to fishing. The state could analyze the composite sample from the largest size class first. If any SVs are exceeded, analysis of the smaller size class composite samples could be conducted. This option, however, does not provide any additional information for estimating the variability of the contamination level in any specific size class. To obtain information for estimating the variability of the contamination level in the target species, states could separately analyze each individual fish specimen in

any composite that exceeded the SVs. **Note:** This option of analyzing individual fish within a composite sample is more resource-intensive with respect to analytical costs but is currently used by some Great Lakes states.

Option 2 (replicate analyses of one size class) provides additional statistical power that would allow states to estimate the variability of contamination levels within the one size class sampled; however, it does not provide information on size-specific contamination levels.

Option 3 (replicate analyses of three size classes) provides both additional information on size-specific contamination levels and additional statistical power to estimate the variability of the contaminant concentrations in each of three size classes of the target species. If resources are limited, the state could analyze the replicate samples for the largest size class first; if the SVs are exceeded, analysis of the smaller size class composite samples could then be conducted.

Note: The correlation between increasing size (age) and contaminant tissue concentration observed for some freshwater finfish species (Voiland et al., 1991) may be much less evident in estuarine/marine finfish species (G. Pollock, California Environmental Protection Agency, personal communication, 1993). The movement of estuarine and marine species from one niche to another as they mature may change their exposure at a contaminated site. Thus, size-based sampling in estuarine/marine systems should be conducted only when it is likely to serve a potential risk management outcome.

6.1.1.3 Target Analyte Selection—

All 25 recommended target analytes listed in Table 4-1 should be considered for inclusion in screening studies unless reliable historic tissue, sediment, or pollutant source data indicate that an analyte is not present at a level of concern for human health. Additional regional or site-specific target analytes should be included in screening studies when there is indication or concern that such contaminants are a potential health risk to local fish or shellfish consumers. Historic data on water, sediment, and tissue contamination and priority pollutant scans from known point source discharges or nonpoint source monitoring should be reviewed to determine whether analysis of additional analytes is warranted.

6.1.1.4 Target Analyte Screening Values—

To enhance national consistency in screening study data, states should use the target analyte screening values listed in Tables 5-3 and 5-4 to evaluate tissue contaminant data. Specific methods used to calculate SVs for noncarcinogenic and carcinogenic target analytes, including examples of SVs calculated for selected subpopulations, are given in Sections 5.1 and 5.2. If target analytes different from those default SVs shown in Tables 5-3 and 5-4 are included in a screening study, these calculation procedures should be used to estimate SVs based on typical exposure assumptions for the fish-consuming public for the

additional compounds. **Note:** If the state chooses to use a different risk level or consumption rate to address site-specific considerations, the corresponding SVs should be calculated prior to initiation of chemical analyses to ensure that the detection limits of the analytical procedures are sufficiently low to allow reliable quantitation at or below the chosen SV. If analytical methodology is not sensitive enough to reliably quantitate target analytes at or below selected SVs (see Sections 5.2 and 8.2.2 and Table 8-4), program managers must determine appropriate fish consumption guidance based on lowest detectable concentrations or provide justification for adjusting SVs to values at or above achievable method detection limits. It should be emphasized that when SVs are below method detection limits, the failure to detect a target analyte cannot be assumed to indicate that there is no cause for concern for human health effects.

6.1.1.5 Sampling Times—

If program resources are sufficient, biennial screening of waterbodies is recommended where commercial, recreational, or subsistence harvesting is commonly practiced (as identified by the state). Data from these screenings can then be used in the biennial state 305(b) reports to document the extent of support of Clean Water Act goals. If biennial screening is not possible, then waterbodies should be screened at least once every 5 years.

Selection of the most appropriate sampling period is very important, particularly when screening studies may be conducted only once every 2 to 5 years. **Note:** For screening studies, sampling should be conducted during the period when the target species is most frequently harvested (U.S. EPA, 1989d; Versar, 1982).

In fresh waters, as a general rule, the most desirable sampling period is from late summer to early fall (i.e., August to October) (Phillips, 1980; Versar, 1982). The lipid content of many species (which represents an important reservoir for organic pollutants) is generally highest at this time. Also, water levels are typically lower during this time, thus simplifying collection procedures. This late summer to early fall sampling period should not be used, however, if (1) it does not coincide with the legal harvest season of the target species or (2) the target species spawns during this period. **Note:** If the target species can be legally harvested during its spawning period, however, then sampling to determine contaminant concentrations should be conducted during this time.

A third exception to the late summer to early fall sampling recommendation concerns monitoring for the organophosphate pesticides. Sampling for these compounds should be conducted during late spring or early summer within 1 to 2 months following pesticide application because these compounds are degraded and metabolized relatively rapidly compared to organochlorine pesticides. **Note:** The target species should be sampled during the spring only if the species can be legally harvested at this time.

In estuarine and coastal waters, the most appropriate sampling time is during the period when most fish are caught and consumed (usually summer for recreational and subsistence fishers). For estuarine/marine shellfish (bivalve molluscs and crustaceans), two situations may exist. The legal harvesting season may be strictly controlled for fisheries resource management purposes or harvesting may be open year round. In the first situation, shellfish contaminant monitoring should be conducted during the legal harvest period. In the second situation, monitoring should be conducted to correspond to the period when the majority of harvesting is conducted during the legal season. state staff may have to consider different sampling times for target shellfish species if differences in the commercial and recreational harvesting period exist.

Ideally, the sampling period selected should avoid the spawning period of the target species, including the period 1 month before and 1 month after spawning, because many aquatic species are subject to stress during spawning. Tissue samples collected during this period may not always be representative of the normal population. For example, feeding habits, body fat (lipid) content, and respiration rates may change during spawning and may influence pollutant uptake and clearance. Collecting may also adversely affect some species, such as trout or bass, by damaging the spawning grounds. Most fishing regulations protect spawning periods to enhance propagation of important fishery species. Species-specific information on spawning periods and other life history factors is available in numerous sources (e.g., Carlander, 1969; Emmett et al., 1991; Pflieger, 1975; Phillips, 1980). In addition, digitized life history information is available in many states through the Multistate Fish and Wildlife Information Systems (1990) on the web at <http://fwie.fw.vt.edu>.

Exceptions to the recommended sampling periods for freshwater and estuarine/marine habitats will be determined by important climatic, regional, or site-specific factors that favor alternative sampling periods. For many states, budgetary constraints may require that most sampling be conducted during June, July, and August when temporary help or student interns are available for hire. The actual sampling period and the rationale for its selection should be documented fully and the final data report should include an assessment of sampling period effects on the results.

6.1.1.6 Sample Type—

Composite samples of fish fillets or of the edible portions of shellfish are recommended for analysis of target analytes in screening studies (U.S. EPA 1987b; 1989d). For health risk assessments, the recommended composite sample type for chemical analysis should be based on both the study objectives and the sample type consumed by the target population of concern. For example, using skinless fillets for assessing mercury exposures for members of the general population and most recreational fishers is most conservative. Because mercury is differentially concentrated in muscle tissue, leaving the skin on the fish fillet actually results in a lower mercury concentration per gram of skin-

on fillet than per gram of skin-off fillet (Gutenmann and Lisk, 1991). In addition, few consumers in the general population eat the skin of the fish, which justifies its removal for analysis, particularly when monitoring concerns are directed solely at mercury contamination. Analysis of skinless fillets may also be more appropriate for some target species such as catfish and other scaleless finfish species. In contrast, using whole fish with skin-on as the sample type for assessing PCBs, dioxins/furans, or organochlorine pesticide exposures in populations of Native Americans, Asian Americans, Caribbean-Americans, or other ethnic groups that consume whole fish in a stew or soup is warranted because these contaminants accumulate in fatty tissues of the fish. Cooking the whole fish to make a stew or soup releases the PCBs, dioxins/furans, or organochlorine contaminants into the broth; thus, the whole fish should be analyzed to mirror the way the consumer prepares the fish. Similarly, using skin-on fillets with belly-flap included for most other scaled fish to evaluate PCB, dioxin/furan, or organochlorine pesticide exposures in the general fishing population or among recreational fishers is appropriate since this is a standard filleting method (see Sections 7.2.2.6 and 7.2.2.7). This method also allows for the inclusion of the fatty belly flap tissue and skin in which organochlorines, PCBs, and dioxins/furans concentrate and takes into account the fact that some consumers may not neatly trim the more highly contaminated fatty tissue from the edible muscle fillet tissue.

For shellfish samples, the recommended composite sample type for chemical analysis also should be based on both the study objectives and the sample type consumed by the target population at risk. The specific tissues considered to be edible will vary among target shellfish species (see Section 7.2.4.4) based on local consumer preference. For example, several states (Maine, Massachusetts, New Hampshire, New Jersey and New York) have issued advisories for a variety of contaminants (PCBs, dioxins/furans, or cadmium) in specific glands or tissues of crustaceans such as lobsters and crabs. Some consumers of lobsters, *Homarus americanus*, enjoy eating the tomalley (digestive gland of the lobster), which has been shown to contain higher concentrations of chemical contaminants than the claw, leg, or tail meat typically consumed by members of the general population. For this reason, the tomalley should be analyzed separately if the target population consumes this organ so that a determination can be made as to whether contaminant concentrations in the tomalley only, or in the claw, leg, and tail meat are above levels of human health concern. Similarly, for the blue crab, *Callinectes sapidus*, as well as other crab species, the hepatopancreas (digestive gland) is consumed by some individuals and has also been found to contain higher concentrations of contaminants than claw, leg, or body muscle tissue. If the target population of concern consumes the hepatopancreas, then to best evaluate the risk of consumption from this tissue, it should be analyzed separately from the claw, leg, and body muscle tissue. A precise description of the sample type (including the number and size of the individual crustaceans in the composite) should be documented in the program record for each target species.

A similar situation exists with respect to selection of the appropriate sample type for bivalve molluscs. For example, while most individuals in the general population consume whole oysters (e.g., *Crassostrea virginica* or *C. gigas*), clams (e.g., *Mercenaria mercenaria*) or mussels (e.g., *Mytilus edulis* or *M. californianus*), only the adductor muscle tissue is typically consumed of the scallops (*Aropecten irradians* or *A. gibbus*). For bivalves in general, the adductor muscle is typically less contaminated than gill, mantle, and digestive organ tissues primarily due to the filter-feeding nature of these animals. Therefore, the adductor muscle of scallops should be analyzed separately for the general population. If the whole body of the scallop is to be consumed as part of a stew or soup by the target population of concern, the state should also conduct analysis of the whole body of the scallop as part of a risk assessment. A precise description of the sample type (including the number and size of the individual bivalves in the composite) should be documented in the program record for each target species.

For freshwater turtles also, the study objectives and sample type consumed by the target population at risk must be of primary consideration. However, EPA recommends use of individual turtle samples rather than composite samples for evaluating turtle tissue contamination. As with shellfish, the tissues of freshwater turtles considered to be edible vary based on the dietary and culinary practices of local populations (see Section 7.2.3.3). For example, New York and Minnesota have advisories for snapping turtles that recommend that consumers who wish to eat turtle meat should trim away all fat and discard the liver and eggs of the turtle (if they are still in the female's body cavity) prior to cooking. These three tissues (fat, liver, and eggs) have been shown to accumulate extremely high concentrations of a variety of contaminants in comparison to muscle tissue (Bishop et al., 1996; Bonin et al. 1995; Bryan et al., 1987; Hebert et al., 1993; Olafsson et al., 1983; 1987; Ryan et al., 1986; and Stone et al., 1980). States should consider monitoring pollutant concentrations in all three tissues in addition to muscle tissue. If residue analysis reveals the presence of high concentrations of contaminants in liver, eggs, and fatty tissue, but not in the muscle tissue, then the state can make the general recommendation to consumers to discard the three most lipophilic tissues to reduce the risk of exposure. This action is most useful when such lipophilic contaminants such as dioxins/furans, PCBs, and organochlorine pesticides are the contaminants involved.

Note: Composite samples are homogeneous mixtures of samples from two or more individual organisms of the same species collected at a particular site and analyzed as a single sample. Because the costs of performing individual chemical analyses are usually higher than the costs of sample collection and preparation, composite samples are most cost-effective for estimating average tissue concentrations of target analytes in target species populations. Besides being cost-effective, composite samples also ensure adequate sample mass to allow analyses for all recommended target analytes. A disadvantage of using composite samples, however, is that extreme contaminant concentration values for individual organisms are lost.

In screening studies, EPA recommends that states analyze one composite sample for each of two target species at each screening site. Organisms used in a composite sample

- Must all be of the same species
- Should satisfy any legal requirements of harvestable size or weight, or at least be of consumable size if no legal harvest requirements are in effect
- Should be of similar size so that the smallest individual in a composite is no less than 75 percent of the total length (size) of the largest individual
- Should be collected at the same time (i.e., collected as close to the same time as possible but no more than 1 week apart) [**Note:** This assumes that a sampling crew was unable to collect all fish needed to prepare the composite sample on the same day. If organisms used in the same composite are collected on different days (no more than 1 week apart), they should be processed within 24 hours as described in Section 7.2 except that individual fish may have to be filleted and frozen until all the fish to be included in the composite are delivered to the laboratory. At that time, the composite homogenate sample may be prepared.]
- Should be collected in sufficient numbers to provide a 200-g composite homogenate sample of edible tissue for analysis of recommended target analytes.

Individual organisms used in composite samples must be of the same species because of the significant species-specific bioaccumulation potential. Accurate taxonomic identification is essential in preventing the mixing of closely related species with the target species. **Note:** Individuals from different species should not be used in a single composite sample (U.S. EPA, 1989d, 1990d).

For cost-effectiveness, EPA recommends that states collect only one size class for each target species and focus on the larger individuals commonly harvested by the local population. Ideally, each composite sample for a specific species should contain the same number of individual fish and the individuals within each target species composite should be of similar size within a target size range so that the composite samples for a particular species are comparable over a wide geographic area. This is particularly important when states want to compare data on an individual species that might be used to establish a statewide advisory.

For persistent chlorinated organic compounds (e.g., DDT, dioxin, PCBs, and toxaphene) and methylmercury, the larger (older) individuals within a population are generally the most contaminated (Phillips, 1980; Voiland et al., 1991). As noted earlier, this correlation between increasing size and increasing contaminant concentration is most striking in freshwater finfish species but is less evident in estuarine and marine species. Size is used as a surrogate for age, which

provides some estimate of the total time the individual organism has been at risk of exposure. Therefore, the primary target size range ideally should include the larger individuals harvested at each sampling site. In this way, the states will maximize their chances of detecting high levels of chemical contamination in the single composite sample collected for each target species. If this ideal condition cannot be met, the field sampling team should retain individuals of similar length that fall within a secondary target size range.

Individual organisms used in composite samples should be of similar size (WDNR, 1988). **Note:** Ideally, for fish or shellfish, the total length (or size) of the smallest individual in any composite sample should be no less than 75 percent of the total length (or size) of the largest individual in the composite sample (U.S. EPA, 1990d). For example, if the largest fish is 200 mm, then the smallest individual included in the composite sample should be at least 150 mm. In the California Mussel Watch Program, a predetermined size range (55 to 65 mm) for the target bivalves (*Mytilus californianus* and *M. edulis*) is used as a sample selection criterion at all sampling sites to reduce size-related variability (Phillips, 1988). Similarly, the Texas Water Commission (1990) specifies the target size range for each of the recommended target fish species collected in the state's fish contaminant monitoring program.

Individual organisms used in a composite sample ideally should be collected at the same time so that temporal changes in contaminant concentrations associated with the reproduction cycle of the target species are minimized.

Each composite sample should contain 200 g of tissue so that sufficient material will be available for the analysis of all recommended target analytes. A larger composite sample mass may be required when the number of target analytes is increased to address regional or site-specific concerns. However, the tissue mass may be reduced in the **Tier 2** intensive studies (Phase I and II) when a limited number of specific analytes of concern have been identified (see Section 7.2.2.9). Given the variability in size among target species, only approximate ranges can be suggested for the number of individual organisms to collect to achieve adequate mass in screening studies (U.S. EPA, 1989d; Versar, 1982). For fish, 3 to 10 individuals should be collected for a composite sample for each target species; for shellfish, 3 to 50 individuals should be collected for a composite sample. In some cases, however, more than 50 small shellfish (e.g., mussels, shrimp, crayfish) may be needed to obtain the recommended 200-g sample mass. **Note:** The same number of individuals should be used in each composite sample for a given target species at each sampling site.

Deviations from the recommended study design have implications that may make the statistical analyses more complicated. The statistical methods for analyzing composite samples are made tractable and easier-to-use by simplifying the study design. Using equal numbers of fish in replicate composite samples is one way to do this. For example, with equal numbers of fish, the arithmetic average of the replicate composite measurements is an unbiased estimator of the population

mean. When unequal numbers are used, the arithmetic average is no longer unbiased. Instead, a weighted average of the composite measurements is calculated, where the weight for each composite reflects the number of fish it is made up of. Oftentimes fish are lost or damaged prior to compositing. When several fish are damaged or lost, the allocation of the remaining fish to composites may be reconfigured to allow equal numbers of fish in composites. If this is not possible, care should be taken to adjust the statistical procedures to account for the unequal allocations.

The use of sizes of fish exceeding the size range recommended for compositing may introduce more variability. If it is the size range within each composite that is broadened (e.g., 100-200 mm instead of 150-200 mm), the variability within the composite may increase. If additional composites are made with fish exceeding the recommended size ranges (e.g., adding composites of fish of size 300-450 mm when the target size is no more than 250 mm), this may increase the variability between composites of different size ranges. Overall inferences made from composites of different size ranges will have increased variability associated with them (e.g., wider confidence intervals).

Differences in the numbers of replicates at different sampling locations may complicate any comparisons to be made between locations or overall conclusions to be obtained by combining the results from different sampling locations. As with unequal numbers of fish in composites, unequal numbers of replicate samples complicate the statistical calculations. The appropriate weighted estimates should be used when combining information from different sampling locations. Consider, for instance, a state that monitors five lakes each year. If the state uses the same target fish species, the same number of fish per composite and the same size ranges, the overall mean level of contamination will be a straightforward average over the five locations if the same number of replicates are used at each location. However, if unequal numbers of replicates are used, the information contributed by each location is not the same and must be weighted accordingly.

As alluded to above, one limitation of using composite samples is that information on extreme levels of chemical contamination in individual organisms is lost. Therefore, EPA recommends that the residual individual homogenates be saved to allow for analyses of individual specimens if resources permit (Versar, 1982). Analysis of individual homogenates allows states to estimate the underlying population variance which, as described in Section 6.1.2.6, facilitates sample size determination for the intensive studies. Furthermore, individual homogenates may also be used to provide materials for split and spike samples for routine QC procedures either for composites or individual organisms (see Section 8.3). The circumstances in which the analysis of individual fish samples might be preferred over the analysis of composite samples is described in more detail in Appendix C.

Recommended sample preparation procedures are discussed in Section 7.2.

6.1.1.7 Replicate Samples—

The collection of sufficient numbers of individual organisms from a target species at a site to allow for the independent preparation of more than one composite sample (i.e., sample replicates) is strongly encouraged but is **option** in screening studies. If resources and storage are available, single replicate (i.e., duplicate) composite samples should be collected at a minimum of 10 percent of the screening sites (U.S. EPA, 1990d). The collection and storage of replicate samples, even if not analyzed at the time due to inadequate resources, allow for followup QC checks. These sites should be identified during the planning phase and sample replication specifications noted on the sample request form. If replicate field samples are to be collected, states should follow the guidance provided in Section 6.1.2.7. **Note:** Additional replicates must be collected at each site for each target species if statistical comparisons with the target analyte SVs are required in the state monitoring programs. The statistical advantages of replicate sampling are discussed in detail in Section 6.1.2.7.

6.1.2 Intensive Studies (Tier 2)

The primary aim of intensive studies is to characterize the magnitude and geographic extent of contamination in harvestable fish and shellfish species at those screening sites where concentrations of target analytes in tissues were found to be above selected SVs. Intensive studies should be designed to verify results of the screening study, to identify specific fish and shellfish species and size classes for which advisories should be issued, and to determine the geographic extent of the fish contamination. In addition, intensive studies should be designed to provide data for states to tailor their advisories based on the consumption habits or sensitivities of specific local fish-consuming subpopulations.

State staff should plan the specific aspects of field collection activities for each intensive study site after a thorough review of the aims of intensive studies (Section 2.2) and the fish contaminant data obtained in the screening study. All the factors that influence sample collection activities should be considered and specific aspects of each should be documented clearly by the program manager on the sample request form for each site.

6.1.2.1 Site Selection—

Intensive studies should be conducted at all screening sites where the selected SV for one or more target analytes was exceeded. The field collection staff should review a 7.5-minute (1:24,000 scale) USGS hydrologic map of the study site and all relevant water, sediment, and tissue contaminant data. The site selection factors evaluated in the screening study (Section 6.1.1.1) must be reevaluated before initiating intensive study sampling.

States should conduct **Tier 2** intensive studies in two phases if program resources allow. **Phase I intensive studies** should be more extensive investigations of the magnitude of tissue contamination at suspect screening sites. **Phase II intensive studies** should define the geographic extent of the contamination around these suspect screening sites in a variety of size (age) classes for each target species. The field collection staff must evaluate the accessibility of these additional sites and develop a sampling strategy that is scientifically sound and practicable.

Selection of Phase II sites may be quite straightforward where the source of pollutant introduction is highly localized or if site-specific hydrologic features create a significant pollutant sink where chemically contaminated sediments accumulate and the bioaccumulation potential might be enhanced (U.S. EPA, 1986d). For example, upstream and downstream water quality and sediment monitoring to bracket point source discharges, outfalls, and regulated disposal sites showing contaminants from surface runoff or leachate can often be used to characterize the geographic extent of the contaminated area. Within coves or small embayments where streams enter large lakes or estuaries, the geographic extent of contamination may also be characterized via multilocational sampling to bracket the areas of concern. Such sampling designs are clearly most effective where the target species are sedentary or of limited mobility (Gilbert, 1987). In addition, the existence of barriers to migration, such as dams, should be taken into consideration.

Site selection considerations should also include the number of samples necessary to characterize different waterbody types (lakes, rivers, estuaries, and coastal marine waters) based on both the hydrodynamics of the waterbody type including waterbody size as well as the inherent migratory nature of the species under consideration. Typically, as the size of a waterbody increases (from small lakes to larger lakes to Great Lakes or from streams, to rivers, to estuaries, to coastal marine waters), the number of samples that need to be collected to maintain a selected statistical power (i.e., 70 percent) as well as the number of sampling stations needed to define the area that should be under advisory both increase. For example, fish inhabiting relatively small lakes are likely to be exposed to a relatively homogeneous aquatic environment of contaminant concentrations. In a riverine, estuarine, or coastal situation, however, the hydrodynamics of the ecosystem can greatly affect the magnitude and nature of contamination in the water that fish encounter as they move up and downstream of areas with distinct nonpoint and point source inputs of contamination. Thus, the amount of time that any fish spends exposed to the contamination may be highly variable as compared to the relatively homogeneous exposures that might occur in smaller, less hydrologically dynamic lake ecosystems.

Overlaid on the hydrodynamic differences of each type of ecosystem and the spatial distribution of both nonpoint and point sources of pollution that can be encountered in larger ecosystems are the inherent behavioral differences in fish and shellfish species with respect to the size of their home range as well as to whether, at some time or times in their life cycle, they migrate widely to other

more or less contaminated areas. Consider the bluegill sunfish, a common inhabitant of small lakes and creeks. The home range for this species is typically less than 0.25 acres (~1,000 m²) in lakes and does not exceed 28 m in streams (Carlander, 1969; Hardy, 1978). Smallmouth bass, a riverine species, have a home range of 500 to 4,500 m², but typically migrate up to 45 km (28 miles) (Reid and Rabeni, 1989; Todd and Rabeni, 1989). In contrast, many Great Lake fish species, as well as riverine, estuarine, and marine species migrate considerable distances during spawning periods. Several Great Lakes species also move upstream considerable distances into tributary rivers to spawn. Lake trout in the Great Lakes have been found to migrate up to 300 km (186 miles) with larger fish migrating 300 miles (483 km) (Daly et al., 1962; Mills, 1971; Willers, 1991). For many marine species, estuaries are the spawning areas for the adults and nursery areas for the developing juveniles, who eventually travel offshore as adults and return again to the estuaries to spawn. For these species, migratory or seasonal movements both from inshore to offshore areas and north and south migrations along the coasts can take place. Obviously, the number of samples needed to define an area under advisory for bluegill sunfish inhabiting a relatively homogeneous environment with respect to contaminant concentrations is quite different from that required for the more mobile species like the smallmouth bass and lake trout.

For shellfish, similar considerations are necessary. Bivalve molluscs like the oyster or mussel cement themselves to hard substrate as young spat and are unable to move away from pollution effects once they have settled out of the water column. Although clams and scallop species are slightly more mobile, they also typically stay in the general area in which they first settled out of the water column. For crustaceans like the blue crab and lobsters, however, movements both into and out of estuaries as well as into deeper water offshore are possible. As the complexity of the hydrodynamics of an ecosystem increases and the mobility of the target species increases, so too does the number of samples and the number of sampling stations required to delineate the area where contaminated individuals may be encountered by the fishing public.

6.1.2.2 Target Species and Size Class Selection—

Whenever possible, the target species found in the screening study to have elevated tissue concentrations of one or more of the target analytes should be resampled in the intensive study. Recommended target species for freshwater sites are listed in Tables 3-1, 3-2, and 3-4; target species for estuarine/marine waters are listed in Tables 3-10 through 3-12 for Atlantic Coast estuaries, in Table 3-13 for Gulf Coast estuaries, and in Tables 3-14 through 3-16 for Pacific Coast estuaries. If the target species used in the screening study are not collected in sufficient numbers, alternative target species should be selected using criteria provided in Section 3.2. The alternative target species should be specified on the sample request form.

For Phase I intensive studies, states should collect replicate composite samples of one size class for each target species and focus sampling on larger individuals commonly harvested by the local population (as appropriate). If contamination of this target size class is high, Phase II studies should include collection of replicate composite samples of three size classes within each target species.

EPA recognizes that resource limitations may influence the sampling strategy selected by a state. If monitoring resources are limited for intensive studies, states may determine that it is more resource-efficient to collect replicate composite samples of three size classes (as recommended for Phase II studies) during Phase I sampling rather than revisit the site at a later time to conduct Phase II intensive studies. In this way, the state may save resources by reducing field sampling costs associated with Phase II intensive studies.

By sampling three size (age) classes, states collect data on the target species that may provide them with additional risk management options. If contaminant concentrations are positively correlated with fish and shellfish size, frequent consumption of smaller (less contaminated) individuals may be acceptable even though consumption of larger individuals may be restricted by a consumption advisory. In this way, states can tailor an advisory to protect human health and still allow restricted use of the fishery resource. Many Great Lakes states have used size (age) class data to allow smaller individuals within a given target species to remain fishable while larger individuals are placed under an advisory.

6.1.2.3 Target Analyte Selection—

Ideally, Phase I intensive studies should include only those target analytes found in the screening study to be present in fish and shellfish tissue at concentrations exceeding selected SVs (Section 5.2). Phase II studies should include only those target analytes found in Phase I intensive studies to be present at concentrations exceeding SVs. In most cases, the number of target analytes evaluated in Phase I and II intensive studies will be significantly smaller than the number evaluated in screening studies.

6.1.2.4 Target Analyte Screening Values—

Target analyte SVs used in screening studies should also be used in Phase I and II intensive studies. Specific methods used to calculate SVs for noncarcinogenic and carcinogenic target analytes, including examples of SVs calculated for various exposure scenarios, are given in Section 5.1.

6.1.2.5 Sampling Times—

To the extent that program resources allow, sampling in intensive studies should be conducted during the same period or periods during which screening studies were conducted (i.e., when the target species are most frequently harvested for consumption) and should be conducted preferably within 1 year of the screening

studies. In some cases, it may be best to combine Phase I and Phase II sampling to decrease both the time required to obtain adequate data for issuance of specific advice relative to species, size classes, and geographic extent and/or the monitoring costs entailed in revisiting the site (see Section 6.1.2.2).

States should follow the general guidance provided in Section 6.1.1.5 for recommended sampling times. The actual sampling period and rationale for its selection should be documented fully for Phase I and II studies.

6.1.2.6 Sample Type—

Composite samples of fish fillets or the edible portions of shellfish are recommended for analysis of target analytes in intensive studies. The general guidance in Section 6.1.1.6 should be followed to prepare composite samples for each target species. In addition, separate composite samples may be prepared for selected size (age) classes within each target species, particularly in Phase II studies after tissue contamination has been verified in Phase I studies. Because the number of replicate composite samples and the number of fish and shellfish per composite required to test whether the site-specific mean contaminant concentration exceeds the selected SV are intimately related, both will be discussed in the next section.

Note: The same number of individual organisms should be used to prepare all replicate composite samples for a given target species at a given site. If this number is outside the recommended range, documentation should be provided.

Recommended sample preparation procedures are discussed in Section 7.2.

States interested in analyzing target analyte residues in individual fish or shellfish samples should review information presented in Appendix C.

6.1.2.7 Replicate Samples—

In intensive studies (Phases I and II), EPA recommends that states analyze replicate composite samples of each target species at each sampling site.

Replicate composite samples should be as similar to each other as possible. In addition to being members of the same species, individuals within each composite should be of similar length (size) (see Section 6.1.1.6). The relative difference between the average length (size) of individuals within any composite sample from a given site and the average of the average lengths (sizes) of individuals in all composite samples from that site should not exceed 10 percent (U.S. EPA, 1990d). To determine this, states should first calculate the average length of the target species fish constituting each composite replicate sample from a site. Then, states should take the average of these averages for the site. In the following example, the average of the average lengths of individuals (± 10 percent) in five replicate composite samples is calculated to be 310 (± 31) mm.

<u>Replicate</u>	<u>Average Length of Individual Fish in Composite Sample (mm)</u>
1	300
2	320
3	330
4	280
5	320

Average of the average length ($\pm 10\%$) = 310 (± 31) mm.

Therefore, the acceptable range for the average length of individual composite samples is 279 to 341 mm, and the average length of individual fish in each of the five replicate composites shown above falls within the acceptable average size range.

All replicate composite samples for a given sampling site should be collected within no more than 1 week of each other so that temporal changes in target analyte concentrations associated with the reproductive cycle of the target species are minimized.

6.1.2.7.1 Guidelines for Determining Sample Sizes—This section provides general guidelines for estimating the number of replicate composite samples per site (n) and the number of individuals per composite (m) required to test the null hypothesis that the mean target analyte concentration of replicate composite samples at a site is equal to the SV versus the alternative hypothesis that the mean target analyte concentration is greater than the SV. These guidelines are applicable to any target species and any target analyte.

Note: It is not possible to recommend a single set of sample size requirements (e.g., number of replicate composite samples per site and the number of individuals per composite sample) for all fish and shellfish contaminant monitoring studies. Rather, EPA presents a more general approach to sample size determination that is both scientifically defensible and cost-effective. At each site, states must determine the appropriate number of replicate composite samples and of individuals per composite sample based on

- Site-specific estimations of the population variance of the target analyte concentration
- Fisheries management considerations
- Statistical power consideration.

If the population variance of the target analyte concentrations at a site is small, fewer replicate composite samples and/or fewer individuals per composite sample may be required to test the null hypothesis of interest with the desired statistical

power. In this case, using sample sizes that are larger than required to achieve the desired statistical power would not be cost-effective.

Alternatively, suppose EPA recommended sample sizes based on an analyte concentration with a population variance that is smaller than that of the target analyte. In this case, the EPA-recommended sample size requirements may be inadequate to test the null hypothesis of interest at the statistical power level selected by the state. Therefore, EPA recommends an approach that provides the flexibility to sample less in those waters where the target analyte concentrations are less variable, thereby reserving sampling resources for those site-specific situations where the population variance of the target analyte tissue concentration is greater.

EPA recommends the following statistical model, which assumes that z_i is the contaminant concentration of the i th replicate composite sample at the site of interest where $i=1,2,3,\dots,n$ and, furthermore, that each replicate composite sample is comprised of m individual fish fillets of equal mass. Let \bar{z} be the mean target analyte concentration of observed replicate composite samples at a site. Ignoring measurement error, the variance of \bar{z} is

$$\text{Var}(\bar{z}) = \sigma^2/(nm) \quad (6-1)$$

where

- σ^2 = Population variance
- n = Number of replicate composite samples
- m = Number of individual samples in each composite sample.

To test the null hypothesis that the mean target analyte concentration across the n replicate composite samples is equal to the SV versus the alternative hypothesis that the mean target analyte concentration is greater than the SV, the estimate of the $\text{Var}(\bar{z})$, s^2 , is

$$s^2 = [\sum(z_i - \bar{z})^2] / [n(n - 1)] \quad (6-2)$$

where the summation occurs over the n composite samples. Under the null hypothesis, the following statistic

$$(\bar{z} - \text{SV}) / s \quad (6-3)$$

has a Student-t distribution with $(n - 1)$ degrees of freedom (Cochran, 1977; Kish, 1965). The degrees of freedom are one less than the number of composite samples.

Note: Use of a single composite sample precludes estimating the variability of the mean target analyte concentration. The estimator s^2 can only be calculated with at least two (but preferably three or more) replicate composite samples.

An optimal sampling design would specify the minimum number of replicate composite samples (n) and of individuals per composite (m) required to detect a minimum difference between the selected SV and the mean target analyte concentration of replicate composite samples at a site. Design characteristics necessary to estimate the optimal sampling design include

- Minimum detectable difference between the site-specific mean target analyte concentration and the selected SV
- Power of the hypothesis test (i.e., the probability of detecting a true difference when one exists)
- Level of significance (i.e., the probability of rejecting the null hypothesis of no difference between the site-specific mean target analyte concentration and the SV when a difference does not exist)
- Population variance, σ^2 (i.e., the variance in target analyte concentrations among individuals from the same species, which the statistician often must estimate from prior information)
- Cost components (including fixed costs and variable sample collection, preparation, and analysis costs).

In the absence of such design specifications, guidance for selecting the number of replicate composite samples at each site and the number of fish per composite sample is provided. This guidance is based on an investigation of the precision of the estimate of σ^2/nm and of statistical power.

Note: Under optimal field and laboratory conditions, at least two replicate composite samples are required at each site for variance estimation. To minimize the risk of a destroyed or contaminated composite sample precluding the site-specific statistical analysis, a **minimum** of three replicate composite samples should be collected at each site if possible. Because three replicate composite samples provide only two degrees of freedom for hypothesis testing, additional replicate composite samples are recommended.

The stability of the estimated standard error of \bar{z} must also be considered because this estimated standard error is the denominator of the statistic for testing the null hypothesis of interest. A measure of the stability of an estimate is its statistical precision. The assumption is made that the z_i 's come from a normal distribution, and then the standard error of $\hat{\sigma}^2 / nm$ is defined as a product of $\hat{\sigma}^2$ and a function of n (the number of replicate composite samples) and m (the number of fish per composite). A fortunate aspect of composite sampling is that the composite target analyte concentrations tend to be normally distributed via the Central Limit Theorem. This formulation is used to determine which combinations of n and m are associated with a more precise estimate of σ^2/nm .

Modifying Cochran (1963) to reflect the normality assumption and the sampling design of n replicate composite samples and m fish per composite sample, the function of n and m of interest is shown in square brackets:

$$se \left(\frac{\hat{\sigma}}{nm} \right) = \sigma^2 \left[\frac{2}{n^2 m^2 (n-1)} \right]^{1/2} \quad (6-4)$$

Table 6-1 provides values of this function for various combinations of m and n. The data presented in Table 6-1 suggest that, as either n or m increases, the standard error of $\hat{\sigma}^2 / nm$ decreases. The advantage of increasing the number of replicate composite samples can be described in terms of this standard error. For example, the standard error of $\hat{\sigma}^2 / nm$ from a sample design of five replicate composite samples and six fish per composite (0.024) will be more than 50 percent smaller than that from a sample design of three replicate composite samples and six fish per composite (0.056). In general, holding the number of fish per composite fixed, the standard error of $\hat{\sigma}^2 / nm$ estimated from five replicate samples will be about 50 percent smaller than that estimated from three replicate samples.

Table 6-1. Values of $\left[\frac{2}{n^2 m^2 (n-1)} \right]^{1/2}$ for Various Combinations of n and m

No. of replicate composite samples (n)	Number of fish per composite sample (m)									
	3	4	5	6	7	8	9	10	12	15
3	0.111	0.083	0.067	0.056	0.048	0.042	0.037	0.033	0.028	0.022
4	0.068	0.051	0.041	0.034	0.029	0.026	0.023	0.020	0.017	0.014
5	0.047	0.035	0.028	0.024	0.020	0.018	0.016	0.014	0.012	0.009
6	0.035	0.026	0.021	0.018	0.015	0.013	0.012	0.011	0.009	0.007
7	0.027	0.021	0.016	0.014	0.012	0.010	0.009	0.008	0.007	0.005
10	0.016	0.012	0.009	0.008	0.007	0.006	0.005	0.005	0.004	0.003
15	0.008	0.006	0.005	0.004	0.004	0.003	0.003	0.003	0.002	0.002

The data in Table 6-1 also suggest that greater precision in the estimated standard error of \bar{z} is gained by increasing the number of replicate samples (n) than by increasing the number of fish per composite (m). If the total number of individual fish caught at a site, for example, is fixed at 50 fish, then, with a design of 10 replicate samples of 5 fish each, the value of the function of n and m in Table 6-1 is 0.009; with 5 replicate samples of 10 fish each, the value is 0.014. Thus, there is greater precision in the estimated standard error of \bar{z} associated with the first design as compared with the second design.

Two assumptions are made to examine the statistical power of the test of the null hypothesis of interest. First, it is assumed that the true mean of the site-specific composite target analyte concentrations (μ) is either 10 percent, 25 percent, or 50 percent higher than the screening value. Second, it is presumed that a factor similar to a coefficient of variation, the ratio of the estimated population standard deviation to the screening value (i.e., σ/SV), is 50, 75 or 100 percent. Nine

scenarios result from joint consideration of these two assumptions. The power of the test of the null hypothesis that the mean composite target analyte concentration at a site is equal to the SV versus the alternative hypothesis that the mean target analyte concentration is greater than the SV is estimated under each set of assumptions. Estimates of the statistical power for six of the nine scenarios are shown in Table 6-2.

Power estimates for the three scenarios where the true mean of the site-specific composite target analyte concentration was assumed to be only 10 percent higher than the screening value are not presented. The power to detect this small difference was very poor: for 242 of the resulting 270 combinations of n and m , the power was less than 50 percent.

Several observations can be made concerning the data in Table 6-2. **Note:** The statistical power increases as either n (number of replicate composite samples) or m (number of fish per composite) increases. However, greater power is achieved by increasing the number of replicate composite samples as opposed to increasing the number of fish per composite. Furthermore, if the number of replicate composite samples per site and the number of fish per composite are held constant, then, as the ratio of the estimated population standard deviation to the SV increases (i.e., σ/SV), the statistical power decreases. Higher variability in the true population of target analyte concentration in fish will require more samples to detect a difference between the mean target analyte concentration and the SV.

States may use these tables as a starting point for setting the number of replicate composite samples per site and the number of fish per composite in their fish and shellfish contaminant monitoring studies. The assumption regarding the ratio of the estimated population standard deviation to the SV presented in Sections A and D of Table 6-2 is unrealistic for some fish and shellfish populations. Data in Sections C through F, which reflect more realistic assumptions concerning the estimated population standard deviation, show that states will be able to detect only large differences between the site-specific mean target analyte concentrations and the selected SV. Specifically, if the assumed ratio of the estimated population standard deviation to the SV is 1.0, using five replicate composite samples and six to seven fish per composite sample, the power to detect a 50 percent increase over the SV is between 70 and 80 percent. However, when the number of fish per composite increases to 8 to 10, the power increases by about 10 percentage points. In comparison, the power to detect a 25 percent increase over the SV is less than 50 percent.

Table 6-2 shows that a statistical power level of (at least) 70 percent is attainable for moderate values of m and n , as long as the ratio σ/SV is not large and/or the desired detectable difference between the target analyte concentration and the SV is not too small.

Table 6-2. Estimates of Statistical Power of Hypothesis of Interest Under Specified Assumptions

No. of Replicate Composite Samples (n)	Number of Fish Per Composite (m)									
	3	4	5	6	7	8	9	10	12	15
A. Ratio of $\sigma/SV = 0.5$ and $\mu = 1.5 \times SV$:										
3	5	6	7	8	9	9	9	9	9	9
4	8	9	9	9	9	9	9	9	9	9
5	9	9	9	9	9	9	9	9	9	9
6	9	9	9	9	9	9	9	9	9	9
7	9	9	9	9	9	9	9	9	9	9
8	9	9	9	9	9	9	9	9	9	9
9	9	9	9	9	9	9	9	9	9	9
10	9	9	9	9	9	9	9	9	9	9
15	9	9	9	9	9	9	9	9	9	9
B. Ratio of $\sigma/SV = 0.75$ and $\mu = 1.5 \times SV$:										
3	-	-	-	-	5	6	6	7	7	8
4	-	6	7	7	8	8	9	9	9	9
5	6	7	8	8	9	9	9	9	9	9
6	7	8	9	9	9	9	9	9	9	9
7	8	9	9	9	9	9	9	9	9	9
8	8	9	9	9	9	9	9	9	9	9
9	9	9	9	9	9	9	9	9	9	9
10	9	9	9	9	9	9	9	9	9	9
15	9	9	9	9	9	9	9	9	9	9
C. Ratio of $\sigma/SV = 1.0$ and $\mu = 1.5 \times SV$:										
3	-	-	-	-	-	-	-	-	5	6
4	-	-	-	5	6	6	7	7	8	8
5	-	5	6	7	7	8	8	8	9	9
6	5	6	7	8	8	8	9	9	9	9
7	6	7	8	8	9	9	9	9	9	9
8	7	8	8	9	9	9	9	9	9	9
9	7	8	9	9	9	9	9	9	9	9
10	8	8	9	9	9	9	9	9	9	9
15	9	9	9	9	9	9	9	9	9	9
D. Ratio of $\sigma/SV = 0.5$ and $\mu = 1.25 \times SV$:										
3	-	-	-	-	-	-	-	-	5	6
4	-	-	-	5	6	6	7	7	8	8
5	-	5	6	7	7	8	8	8	9	9
6	5	6	7	8	8	8	9	9	9	9
7	6	7	8	8	9	9	9	9	9	9
8	7	8	8	9	9	9	9	9	9	9
9	7	8	9	9	9	9	9	9	9	9
10	8	8	9	9	9	9	9	9	9	9
15	9	9	9	9	9	9	9	9	9	9
E. Ratio of $\sigma/SV = 0.75$ and $\mu = 1.25 \times SV$:										
3	-	-	-	-	-	-	-	-	-	-
4	-	-	-	-	-	-	-	-	-	6
5	-	-	-	-	-	-	5	5	6	7
6	-	-	-	-	5	6	6	7	7	8
7	-	-	5	5	6	6	7	7	8	9
8	-	-	5	6	7	7	8	8	8	9
9	-	5	6	7	7	8	8	8	9	9
10	-	6	6	7	8	8	8	9	9	9
15	6	7	8	9	9	9	9	9	9	9

Table 6-2. (continued)

No. of Replicate Composite Samples (n)	Number of Fish Per Composite (m)									
	3	4	5	6	7	8	9	10	12	15
F. Ratio of $\sigma/SV = 1.0$ and $\mu = 1.25 \times SV$:										
3	-	-	-	-	-	-	-	-	-	-
4	-	-	-	-	-	-	-	-	-	-
5	-	-	-	-	-	-	-	-	-	5
6	-	-	-	-	-	-	-	-	5	6
7	-	-	-	-	-	-	5	5	6	7
8	-	-	-	-	-	5	5	6	7	7
9	-	-	-	-	5	5	6	6	7	8
10	-	-	-	5	5	6	6	7	8	8
15	-	5	6	5	7	8	8	8	9	9

-: Power less than 50 percent. 7: Power between 70 and 80 percent.
5: Power between 50 and 60 percent. 8: Power between 80 and 90 percent
6: Power between 60 and 70 percent. 9: Power greater than 90 percent

One final note on determining the number of replicate composite samples per site and the number of fish per composite should be emphasized. According to Section 6.1.2.3, Phase I intensive studies will focus on those target analytes that exceeded the selected SV used in the screening study. Thus, multiple target analytes may be under investigation during Phase I intensive studies, and the population variances of these analytes are likely to differ. **Note:** States should use the target analyte that exhibits the largest population variance when selecting the number of replicate composite samples per site and the number of fish per composite. This conservative approach supports use of the data in Section B of Table 6-2 where the ratio of σ/SV is twice that of the data in Section A. States may estimate population variances from historic fish contaminant data or from composite data as described by U.S. EPA (1989d). This estimate of σ^2 can be used to determine whether the sampling design (i.e., number of replicate composite samples [n] and number of individuals per composite [m]) should be modified to achieve a desired statistical power.

Table 6-3 summarizes some observed ratios (σ/SV) of selected target analytes. These values were estimated from composite samples of siscowet trout and lake trout collected and analyzed by the Great Lakes Indian Fish and Wildlife Commission in a study funded by the Administration for Native Americans.

Table 6-3. Observed Ratios (σ/SV) of Selected Target Analytes

Target Species	Observed σ/SV (Mean)		
	Total PCB SV=0.02 ppm	Toxaphene SV=0.0363 ppm	Heptachlor Epoxide SV=0.00439 ppm
Siscowet trout	4.08 (1.01)	7.07 (2.18)	0.68 (0.01)
Lake trout	10.70 (0.47)	3.01 (0.38)	0.93 (0.007)

Source: Personal communication, Kory Groetsch, Great Lakes Indian Fish and Wildlife Commission, Odana, WI, with Elvessa Aragon, Research Triangle Institute, Research Triangle Park, NC, May 10, 2000.

SV = EPA default value for recreational fishers.

Consider a study of heptachlor epoxide concentrations in lake trout. The observed ratio (σ/SV) is close to 1.0 and the observed mean is approximately $1.5 \times SV$. To determine the appropriate values of n and m , we look at Section C of Table 6-2. To achieve statistical power between 80 and 90 percent, the combination of n and m that requires the smallest number of individual fish is $n=10$ and $m=3$. Ten replicate composite samples, each with three fish, will provide between 80 and 90 percent power for detecting a mean heptachlor epoxide concentration that is higher than the SV , if the difference truly exists. Other combinations of n and m might be more desirable. For instance, if the cost of analyzing composite samples is much higher than the cost of compositing individual fish, a combination that yields fewer replicate composite samples (say, $n=5$ and $m=8$, or $n=6$ and $m=6$) may be chosen. For siscowet trout, the observed ratio (σ/SV) is close to 0.75 while the observed mean is approximately $2.25 \times SV$. A comparison of the combinations of n and m in Sections B and E (for $\sigma/SV = 0.75$) shows that higher values of n and m are required to detect a difference at the same level of statistical power. For instance, in Section B, where $\mu = 1.5 \times SV$, the smallest number of individual fish needed to achieve 80 to 90 percent power is given by $n=7$ and $m=3$. In Section E, where $\mu=1.25 \times SV$, the combination of $n=15$ and $m=5$ achieves 80 to 90 percent power. For the same level of power and the same σ/SV , detecting a larger difference between the SV and the true mean concentration requires larger sample sizes (n or m or both).

After states have implemented their fish and shellfish contaminant monitoring program, collected data on cost and variance components, and addressed other design considerations, they may want to consider using an optimal composite sampling protocol as described in Rohlf et al. (1991) for refining their sampling design. An optimal sampling design is desirable because it detects a specified minimum difference between the site-specific mean contaminant concentration and the SV at minimum cost.

6.1.2.7.2 Comparison of Target Analyte Concentrations with Screening Values for Issuing Fish Advisories—Using the statistical model described in Section 6.1.2.7.1, target analyte concentrations from replicate composite samples at a particular site can be compared to screening values using a t-test. Assume that z_i is the contaminant concentration of the i th replicate composite sample at the site of interest where $i=1,2,3,\dots,n$ and, furthermore, that each replicate composite sample comprises m individual fish fillets of equal mass. To test the null hypothesis that the mean target analyte concentration across the n replicate composite samples is equal to the SV versus the alternative hypothesis that the mean target analyte concentration is greater than the SV , perform the following steps:

1. Calculate \bar{z} , the mean target analyte concentration of observed replicate composite samples at a site:

$$\bar{z} = \sum z_i / n$$

where the summation occurs over the n composite samples.

2. Calculate the estimate of the $\text{Var}(\bar{z})$, s^2 :

$$s^2 = [\sum(z_i - \bar{z})^2] / [n(n - 1)]$$

where the summation occurs over the n composite samples.

3. Calculate the test statistic:

$$t_c = (\bar{z} - \text{SV}) / s$$

4. The null hypothesis of no difference is rejected in favor of the alternative hypothesis of exceedance if

$$t_c > t_{\alpha, n-1}$$

where $t_{\alpha, n-1}$ is the tabulated value of the Student-t distribution corresponding to level of significance α and n-1 degrees of freedom. Note that the inequality is in one direction (>) since it is **exceedance** of the SV that is of interest.

When several sites are sampled and/or fish of different size ranges are collected, it is important to conduct the test separately at each site and for each size range. Combining sites or size ranges introduces variance components that are not accounted for in this procedure. The variance estimate may be larger with the additional sources of variability, and more replicate samples may be needed to detect a significant overall exceedance of the SV.

Example

Samples of siscowet trout were collected by the Great Lakes Indian Fish and Wildlife Commission and composited according to the guidelines discussed in this document. Composites of 12 fish were prepared, and four replicate samples of each of four size classes were analyzed for total mercury, PCBs, and a suite of chlorinated pesticides. Following is a summary of the test for exceedance of the SV for hexachlorobenzene (SV=0.025 ppm) based on the recreational fish consumption default value.

At the 5 percent level of significance the critical value of the Student-t distribution with three degrees of freedom is 2.353. All of the test statistic values are less than the critical value. The mean levels of hexachlorobenzene in the four size ranges of siscowet trout are less than the SV, so no fish advisory is needed.

Size Range (in.)	No. of Replicate Samples (n)	No. of Fish per Composite (m)	Composite Measurements of HCB (ppm)	Mean (Estimated Standard Deviation)	Test Statistic
17.0-18.0	4	12	0.00419 0.00507 0.00483 0.00405	4.53×10^{-3} (2.46×10^{-4})	-83.21
19.5-20.5	4	12	0.00604 0.00780 0.00925 0.00990	8.25×10^{-3} (8.57×10^{-4})	-19.54
22.0-23.0	4	12	0.01800 0.01808 0.01868 0.02389	1.97×10^{-2} (1.42×10^{-3})	-3.73
24.5-25.5	4	12	0.01050 0.00960 0.00850 0.01090	9.88×10^{-3} (5.33×10^{-4})	-28.37

HCb=Hexachlorobenzene.

6.1.2.7.3 Comparison of Target Analyte Concentrations with Screening Values for Rescinding Fish Advisories—The comparison of mean target analyte concentrations to the screening values must be statistically based when considering rescinding a fish advisory. Statistical tests are constructed to control the Type I and Type II errors. The Type I error is defined as rejecting the null hypothesis (based on the evidence from the data) even though it is really true. The Type II error is defined as failing to reject the null hypothesis even though it is really false. In the context of the null and alternative hypotheses presented in the previous section, the Type I error is concluding that the mean target analyte concentration exceeds the SV when in fact it does not. The state concludes that there is a need to issue a fish advisory and proceeds to issue one, albeit unnecessarily. The Type II error is concluding that the mean target analyte concentration tissue residue level does not exceed the SV when in fact it does. The state decides that the mean target analyte concentration is no longer endangering the public health, so the fish advisory is rescinded. The implications of such errors may be costly; a Type II error in this case will put the public at risk without their knowledge. The Type I error is controlled by setting the level of significance to a small value, and the Type II error is controlled by increasing the power of the test. Both error types can be controlled simultaneously by increasing the sample sizes (n or m or both).

There are two basic statistical questions that must be answered before a fish advisory is rescinded:

- Is the screening value still being exceeded?
- If the screening value is no longer being exceeded, can the target analyte concentrations be expected to remain below the screening value?

The first question may be answered with the t-test described in the previous section. The second question may be answered by monitoring the target analyte concentrations long enough to observe a downward trend or a constant trend below the screening value. The simple approach would be to obtain replicate composite samples each year and test for exceedance of the screening value. (Section 6.1.1.5 recommends that screening be done biennially or at least once every 5 years. "Year" then signifies the years when screening is performed.) If the screening value is no longer being exceeded in year X, the state should continue obtaining replicate samples for at least one more year. The state should then test the differences between the tissue residue levels at years X-1, X, and X+1. Significant differences between the levels, especially between years X-1 and X, as well as between years X-1 and X+1, allows verification that the decrease in the target analyte concentration below the screening value at year X was not by chance. Appendix N discusses some statistical methods for comparing samples at different time points.

It is recommended that the yearly studies be as similar in study design as possible. Introducing changes in the study design will add more sources of variability and may necessitate increasing the number of replicate samples or accounting for the additional variance components in the statistical methods used.

6.1.2.7.4 Issuing Statewide Advisories—In addition to issuing fish consumption advisories for individual waterbodies, 18 states have also issued blanket statewide advisories for certain types of waterbodies within their jurisdictions (U.S. EPA, 1999c). States have issued statewide advisories for their freshwater lakes and/or rivers and their coastal waters, which can include estuaries and/or coastal marine waters. States often issue statewide advisories for certain waterbody types to warn the public of the potential for widespread contamination of certain species of fish or shellfish in these waterbodies. In these cases, the state has typically found a level of contamination of a specific pollutant in a particular fish species over a relatively wide geographic area that warrants advising the public of the situation. A state often issues a statewide advisory when, for example, it has many lakes that need to be monitored but has limited resources to collect fish (can sample only four or five lakes per year). If the state has even 100 lakes that need monitoring at the level of resources available, it could take 10 to 20 years to adequately monitor all 100 lakes. As an alternative, some states monitor a small percentage of their lakes and, based on the level of contamination found, many have determined that a statewide advisory should be issued to be conservative with respect to protection of public health. Methylmercury, because it is dispersed and transported via the atmosphere, is the leading pollutant responsible for the issuance of statewide advisories in 15 states, although PCBs, dioxins/furans, cadmium, chlordane, mirex, and DDT are also responsible for statewide advisories in a smaller number of states. Assuming that the levels of contamination are determined based on the fish compositing guidelines in this document, the biggest question is determining which waterbodies to monitor. Finding a "representative" sample of waterbodies is a daunting task since there are many different ways to determine representativeness: size of waterbody,

species of interest, dynamics of dispersion of pollutants of interest, or geographical location. Taking a simple random sample of lakes may not achieve sufficient coverage, whereas taking a stratified random sample approach may require more lakes be sampled than can be afforded. A conservative approach may be to look at the "worst case scenario". States may decide to sample the lakes that are believed to have the highest levels of pollutants, based on historical contaminant data, current water and sediment sampling results, or other variables. Another approach would be to select one or two of the factors described above ("representativeness"), stratify the lakes according to these factors, and select a random sample within each stratum. The set of factors for stratification may change every few years or so if it is deemed that some other factors are becoming more indicative of the levels of contamination.

6.2 SAMPLE COLLECTION

Sample collection activities should be initiated in the field only after an approved sampling plan has been developed. This section discusses recommended sampling equipment and its use, considerations for ensuring preservation of sample integrity, and field recordkeeping and chain-of-custody procedures associated with sample processing, preservation, and shipping.

6.2.1 Sampling Equipment and Use

In response to the variations in environmental conditions and target species of interest, fisheries biologists have had to devise sampling methods that are intrinsically selective for certain species and sizes of fish and shellfish (Versar, 1982). Although this selectivity can be a hindrance in an investigation of community structure, it is not a problem where tissue contaminant analysis is of concern because tissue contaminant data can best be compared only if factors such as differences in taxa and size are minimized.

Collection methods can be divided into two major categories, active and passive. Each collection method has advantages and disadvantages. Various types of sampling equipment, their use, and their advantages and disadvantages are summarized in Table 6-4 for fish and in Table 6-5 for shellfish. **Note:** Either active or passive collection methods may be used as long as the methods selected result in collection of a representative fish sample of the type consumed by local sport and subsistence fishers.

A basic checklist of field sampling equipment and supplies is shown in Table 6-6. Safety considerations associated with the use of a boat in sample collection activities are summarized in Table 6-7.

6.2.1.1 Active Collection—

Active collection methods employ a wide variety of sampling techniques and devices. Devices for fish sampling include electroshocking units, seines, trawls,

Table 6-4. Summary of Fish Sampling Equipment

Device	Use	Advantages	Disadvantages
ACTIVE METHODS			
Electrofishing	Shallow rivers, lakes, and streams.	Most efficiency nonselection method. Minimal damage to fish. Adaptable to a number of sampling conditions (e.g., boat, wading, shorelines). Particularly useful at sites where other active methods cannot be used (e.g., around snags and irregular bottom contours).	Nonselective—stuns or kills most fish. Cannot be used in brackish, salt, or extremely soft water. Requires extensive operator training. DANGEROUS when not used properly.
Seines	Shallow rivers, lakes, and streams. Shoreline areas of estuaries.	Relatively inexpensive and easily operated. Mesh size selection available for target species.	Cannot be used in deep water or over substrates with an irregular contour. Not completely efficient as fish can evade the net during seining operation.
Trawls	Various sizes can be used from boats in moderate to deep open bodies of water (10 to >70 m depths).	Effective in deep waters not accessible by other methods. Allows collection of a large number of samples.	Requires boat and trained operators.
Angling	Generally species selective involving use of hook and line.	Most selective method. Does not require use of large number of personnel or expensive equipment.	Inefficient and not dependable.
Purchasing specimens from commercial fishers	Only in areas where target species are commercially harvested.	Most cost-effective and efficient means of obtaining commercially valuable species from harvested waters.	Limited use; commercially harvested areas may not include sampling sites chosen for fish contaminant monitoring. The field collection staff should accompany the commercial fishers and should remove the required samples from the collection device. This will ensure the proper handling of the specimens and accurate recording of the collection time and sampling location.
PASSIVE METHODS			
Gill nets	Lakes, rivers, and estuaries. Where fish movement can be expected or anticipated.	Effective for collecting pelagic fish species. Relatively easy to operate. Requires less fishing effort than active methods. Selectivity can be controlled by varying mesh size.	Not effective for bottom-dwelling fish or populations that do not exhibit movement patterns. Nets prone to tangling or damage by large and sharp spined fish. Gill nets will kill captured specimens, which, when left for extended periods, may undergo physiological changes.
Trammel nets	Lakes, rivers, and estuaries. Where fish movement can be expected or anticipated. Frequently used where fish may be scared into the net.	Slightly more efficient than a straight gill net.	(Same as for gill nets.) Tangling problems may be more severe. Method of scaring fish into net requires more personnel or possibly boats in deep water areas.
Hoop, Fyke and Pound Nets	Shallow rivers, lakes, and estuaries when currents are present or when movements of fish are predictable. Frequently used in commercial operations.	Unattended operation. Very efficient in regard to long-term return and expended effort. Particularly useful in areas where active methods are impractical.	Inefficient for short term. Difficult to set up and maintain.
D-Traps	Used for long-term capture of slow-moving fish, particularly bottom species. Can be used in all environments.	Easy to operate and set. Unattended operation. Particularly useful for capturing bottom-dwelling organisms in deep waters or other types of inaccessible areas. Relatively inexpensive—often can be hand made.	Efficiency is highly variable. Not effective for pelagic fish or fish that are visually oriented. Less efficient for all species when water is clear rather than turbid. Not a good choice for a primary sampling technique, but available as backup for other methods.

Source: Versar, 1982.

Table 6-5. Summary of Shellfish Sampling Equipment

Device	Use	Advantages	Disadvantages
ACTIVE METHODS			
Seines	Shallow shoreline areas of estuaries.	Relatively inexpensive and easily operated. Mesh size selection available for target crustacean species (e.g., shrimp and crabs).	Cannot be used in deep water or over substrates with an irregular contour. Not completely efficient as crustaceans can evade the net during seining operation.
Trawls	Various sizes can be used from boats in moderate to deep open bodies of water (10 to >70 m depths).	Effective in deeper waters not accessible by other methods. Allows collection of a large number of samples.	Requires boat and trained operators.
Mechanical grabs Double-pole-operated grab buckets	Used from boat or pier. Most useful in shallow water areas less than 6 m deep including lakes, rivers, and estuaries.	Very efficiency means of sampling bivalves (e.g., clams and oysters) that are located on or buried in bottom sediments.	At depths greater than 6 m, the pole-operated devices become difficult to operate manually.
Tongs or double-handled grab sampler	Most useful in shallow water, lakes, rivers, and estuaries. Generally used from a boat.	Very efficient means of sampling oysters, clams, and scallops. Collection of surrounding or overlying sediments is not required and the jaws are generally open baskets. This reduces the weight of the device and allows the washing of collected specimens to remove sediments.	At depths greater than 6 m, the pole-operated devices become difficult to operate manually.
Line or cable-operated grab buckets			
Ekman grab	Used from boat or pier to sample soft to semisoft substrates.	Can be used in water of varying depths in lakes, rivers, and estuaries.	Possible incomplete closure of jaws can result in sample loss. Must be repeatedly retrieved and deployed. Grab is small and is not particularly effective in collecting large bivalves (clams and oysters).
Petersen grab	Deep lakes, rivers, and estuaries for sampling most substrates.	Large sample is obtained; grab can penetrate most substrates.	Grab is heavy, may require winch for deployment. Possible incomplete closure of jaws can result in sample loss. Must be repeatedly retrieved and deployed.
Ponar grab	Deep lakes, rivers, and estuaries for sampling sand, silt, or clay substrates.	Most universal grab sampler. Adequate on most substrates. Large sample is obtained intact.	Possible incomplete closure of jaws can result in sample loss. Must be repeatedly retrieved and deployed.
Orange peel grab	Deep lakes, rivers, and estuaries for sampling most substrates.	Designed for sampling hard substrates.	Grab is heavy, may require winch for deployment. Possible incomplete closure of jaws can result in sample loss. Must be repeatedly retrieved and deployed. Grab is small and not particularly effective in collecting large bivalves (clams and oysters).
Biological or hydraulic dredges	Dragged along the bottom of deep waterbodies to collect large stationary invertebrates.	Qualitative sampling of large area of bottom substrate and benthic community. Length of tows can be relatively short if high density of shellfish exists in sampling area.	If the length of the tow is long, it is difficult to pinpoint the exact location of the sample collection area. Because of the scouring operation of the dredge, bivalve shells may be damaged. All bivalve specimens should be inspected and individuals with cracked or damaged shells should be discarded.

(continued)

Table 6-5. (continued)

Device	Use	Advantages	Disadvantages
ACTIVE METHODS (continued)			
Scoops, shovels	Used in shallow waters accessible by wading or SCUBA equipment for collection of hard clams (<i>Mercenaria mercenaria</i>) or soft-shell clam (<i>Mya arenaria</i>).	Does not require a boat; sampling can be done from shore.	Care must be taken not to damage the shells of bivalves while digging in substrate.
Scrapers	Used in shallow waters accessible by wading or SCUBA equipment for collection of oysters (<i>Crassostrea virginica</i>) or mussels (<i>Mytilus sp.</i>).	Does not require a boat; sampling can be done from shore.	Care must be taken not to damage shells of bivalves while removing them from hard substrate.
Rakes	Used in shallow waters accessible by wading or can be used from a boat.	Does not require a boat; sampling can be done close to shore. Can be used in soft sediments to collect clams or scallops and can also be used to dislodge oysters or mussels that are attached to submerged objects such as rocks and pier pilings.	Care must be taken not to damage the shells of the bivalves while raking or dislodging them from the substrate.
Purchasing specimens from commercial fishers	Only in areas where target species are commercially harvested.	Most cost-effective and efficient means of obtaining bivalves for pollutant analysis from commercially harvested waters.	Limited use; commercially harvested areas may not include sampling sites chosen for shellfish contaminant monitoring. The field collection staff should accompany the commercial fishers and should remove the required samples from the collection device. This will ensure the proper handling of the specimens and accurate recording of the exact collection time and sampling location.
PASSIVE METHODS			
D-traps	Used for capture of slow-moving crustaceans (crabs and lobsters) that move about on or just above the substrate.	Can be used in a variety of environments. Particularly useful for capturing bottom-dwelling organisms in deep water or other inaccessible areas. Relatively inexpensive, can be hand made.	Catch efficiency is highly variable. Not a good choice for a primary sampling technique, but valuable as a backup for other methods.

**Table 6-6. Checklist of Field Sampling Equipment and Supplies
for Fish and Shellfish Contaminant Monitoring Programs**

- Boat supplies
 - Fuel supply (primary and auxiliary supply)
 - Spare parts repair kit
 - Life preservers
 - First aid kit (including emergency phone numbers of local hospitals, family contacts for each member of the sampling team)
 - Spare oars
 - Nautical charts of sampling site locations

 - Collection equipment (e.g., nets, traps, electroshocking device)

 - Recordkeeping/documentation supplies
 - Field logbook
 - Sample request forms
 - Specimen identification labels
 - Chain-of-Custody (COC) Forms and COC tags or labels
 - Indelible pens

 - Sample processing equipment and supplies
 - Holding trays
 - Fish measuring board (metric units)
 - Calipers (metric units)
 - Shucking knife
 - Balance to weigh representative specimens for estimating tissue weight (metric units)
 - Aluminum foil (extra heavy duty)
 - Freezer tape
 - String
 - Several sizes of plastic bags for holding individual or composite samples
 - Resealable watertight plastic bags for storage of Field Records, COC Forms, and Sample Request Forms

 - Sample preservation and shipping supplies
 - Ice (wet ice, blue ice packets, or dry ice)
 - Ice chests
 - Filament-reinforced tape to seal ice chests for transport to the central processing laboratory
-
-

Table 6-7. Safety Considerations for Field Sampling Using a Boat

- Field collection personnel **should not** be assigned to duty alone in boats.
 - Life preservers should be worn at all times by field collection personnel near the water or on board boats.
 - If electrofishing is the sampling method used, there must be two shutoff switches--one at the generator and a second on the bow of the boat.
 - All deep water sampling should be performed with the aid of an experienced, licensed boat captain.
 - All sampling during nondaylight hours, during severe weather conditions, or during periods of high water should be avoided or minimized to ensure the safety of field collection personnel.
 - All field collection personnel should be trained in CPR, water safety, boating safety, and first aid procedures for proper response in the event of an accident. Personnel should have local emergency numbers readily available for each sampling trip and know the location of the hospitals or other medical facilities nearest each sampling site.
-

and angling equipment (hook and line). Rotenone, a chemical piscicide, has been used extensively to stun fish prior to their collection with seines, trawls, or other sampling devices. Rotenone has not been found to interfere with the analysis of the recommended organic target analytes (see Table 4-1) when the recommended analysis procedures are used. See Section 8 for additional information on appropriate analysis methods for the recommended organic target analytes. Devices for shellfish sampling include seines, trawls, mechanical grabs (e.g., pole- or cable-operated grab buckets and tongs), biological and hydraulic dredges, scoops and shovels, rakes, and dip nets. Shellfish can also be collected manually by SCUBA divers. Although active collection requires greater fishing effort, it is usually more efficient than passive collection for covering a large number of sites and catching the relatively small number of individuals needed from each site for tissue analysis (Versar, 1982). Active collection methods are particularly useful in shallow waters (e.g., streams, lake shorelines, and shallow coastal areas of estuaries).

One aspect of sample collection that is of paramount importance is that the sampling team must ensure the collection of live, intact fish and shellfish for use in sample analysis for human risk assessment. It is highly desirable to collect live, intact fish and shellfish that have not been mutilated by the collection gear and that do not have any skin, shell, or carapace lacerations or fin deterioration that would allow body fluids to leak out of the specimen or contaminants to pass into the specimen after collection. For example, some fish collected by electroshocking methods may have ruptured organs due to the electroshocking procedure. Fish that are found floating dead at a site should not be used for sample analysis for human risk assessments. For these reasons, EPA recommends that any specimens that show any skin, shell, or carapace lacerations or fin deterioration of any kind not used for chemical analysis.

Active collection methods have distinct disadvantages for deep water sampling. They require more field personnel and more expensive equipment than passive collection methods. This disadvantage may be offset by coordinating sampling efforts with commercial fishing efforts. Purchasing fish and shellfish from commercial fishers using active collection devices is acceptable; however, field sampling staff should accompany the commercial fishers during the collection operation to ensure that samples are collected and handled properly and to verify the sampling site location. The field sampling staff then remove the target species directly from the sampling device and ensure that sample collection, processing, and preservation are conducted as prescribed in sample collection protocols, with minimal chance of contamination. This is an excellent method of obtaining specimens of commercially important target species, particularly from the Great Lakes and coastal estuarine areas (Versar, 1982). More detailed descriptions of active sampling devices and their use are provided in Battelle (1975), Bennett, et al., (1970), Gunderson and Ellis (1986), Hayes (1983), Mearns and Allen (1978), Pitt (1981), Puget Sound Estuary Program (1990b), Versar (1982), and Weber (1973).

6.2.1.2 Passive Collection—

Passive collection methods employ a wide array of sampling devices for fish and shellfish, including gill nets, fyke nets, trammel nets, hoop nets, pound nets, and d-traps. Passive collection methods generally require less fishing effort than active methods but are usually less desirable for shallow water sample collection because of the ability of many species to evade these entanglement and entrapment devices. These methods normally yield a much greater catch than would be required for a contaminant monitoring program and are time consuming to deploy. In deep water, however, passive collection methods are generally more efficient than active methods. Crawford and Luoma (1993) caution that passive collection devices (e.g., gill nets) should be checked frequently to ensure that captured fish do not deteriorate prior to removal from the sampling device. Versar (1982, 1984) and Hubert (1983) describe passive sampling devices and their use in more detail. It is highly desirable to collect live, intact fish that have not been mutilated by the collection gear and that do not have any skin lacerations or fin deterioration. For these reasons, EPA recommends that fish captured in passive collection devices not remain in the water for more than 24 hours after the passive collection device is first deployed and that specimens that show any skin or fin deterioration or external lacerations of any kind not used for chemical analysis.

Purchasing fish and shellfish from commercial fishers using passive collection methods is acceptable; however, field sampling staff should accompany the fishers during both the deployment and collection operations to ensure that samples are collected and handled properly and to verify the sampling site location. The field sampling staff can then ensure that sample collection, processing, and preservation are conducted as prescribed in sample collection protocols, with minimal chance of contamination.

6.2.2 Preservation of Sample Integrity

The primary QA consideration in sample collection, processing, preservation, and shipping procedures is the preservation of sample integrity to ensure the accuracy of target analyte analyses. Sample integrity is preserved by prevention of loss of contaminants already present in the tissues and prevention of extraneous tissue contamination (Smith, 1985).

Loss of contaminants already present in fish or shellfish tissues can be prevented in the field by ensuring that the skin on fish specimens has not been lacerated by the sampling gear or that the carapace of crustaceans or shells of bivalves have not been cracked during sample collection resulting in loss of tissues and/or fluids that may contain contaminants. Once the samples have reached the laboratory, further care must be taken during thawing (if specimens are frozen) to ensure that all liquids from the thawed specimens are retained with the tissue sample as appropriate (see Sections 7.2.2, 7.2.3, and 7.2.4).

Sources of extraneous tissue contamination include contamination from sampling gear, grease from ship winches or cables, spilled engine fuel (gasoline or diesel), engine exhaust, dust, ice chests, and ice used for cooling. All potential sources of contamination in the field should be identified and appropriate steps taken to minimize or eliminate them. For example, during sampling, the boat should be positioned so that engine exhausts do not fall on the deck. Ice chests should be scrubbed clean with detergent and rinsed with distilled water after each use to prevent contamination. To avoid contamination from melting ice, samples should be placed in waterproof plastic bags (Stober, 1991). Sampling equipment that has obviously been contaminated by oils, grease, diesel fuel, or gasoline should not be used. All utensils or equipment that will be used directly in handling fish or shellfish (e.g., fish measuring board or calipers) should be cleaned in the laboratory prior to each sampling trip, rinsed in acetone and pesticide-grade hexane, and stored in aluminum foil until use (Versar, 1982). Between sampling sites, the field collection team should clean each measurement device by rinsing it with ambient water and rewrapping it in aluminum foil to prevent contamination.

Note: Ideally, all sample processing (e.g., resections) should be performed at a sample processing facility under cleanroom conditions to reduce the possibility of sample contamination (Schmitt and Finger, 1987; Stober, 1991). However, there may be some situations in which state staff find it necessary to fillet finfish or resect edible turtle or shellfish tissues in the field prior to packaging the samples for shipment to the processing laboratory. This practice should be avoided whenever possible. If states find that filleting fish or resecting other edible tissues must be performed in the field, a clean area should be set up away from sources of diesel exhaust and areas where gasoline, diesel fuel, or grease are used to help reduce the potential for surface and airborne contamination of the samples from PAHs and other contaminants. Use of a mobile laboratory or use of a portable resection table and enclosed hood would provide the best environment for sample processing in the field. General guidance for conducting sample

processing under cleanroom conditions is provided in Section 7.2.1. States should review this guidance to ensure that procedures as similar as possible to those recommended for cleanroom processing are followed. If sample processing is conducted in the field, a notation should be made in the field records and on the sample processing record (see Figure 7-2). Procedures for laboratory processing and resection are described in Section 7.2. Procedures for assessing sources of sample contamination through the analyses of field and processing blanks are described in Section 8.3.3.6.

6.2.3 Field Recordkeeping

Thorough documentation of all field sample collection and processing activities is necessary for proper interpretation of field survey results. For fish and shellfish contaminant studies, it is advisable to use preprinted waterproof data forms, indelible ink, and writing implements that can function when wet (Puget Sound Estuary Program, 1990b). When multicopy forms are required, no-carbon-required (NCR) paper is recommended because it allows information to be forwarded on the desired schedule and retained for the project file at the same time.

Four separate preprinted sample tracking forms should be used for each sampling site to document field activities from the time the sample is collected through processing and preservation until the sample is delivered to the processing laboratory. These are

- Field record form
- Chain-of-custody (COC) label or tag
- Sample identification label
- COC form.

6.2.3.1 Field Record Form—

The following information should be included on the field record for each sampling site in both **Tier 1** screening (Figures 6-3 and 6-4) and **Tier 2** intensive studies as appropriate (Figures 6-5 and 6-6):

- Project number
- Sampling date and time (give date in a Year 2000 compliant format [YYYYMMDD] and specify convention used for time, e.g., 24-h clock)
- Sampling site location (including site name and number, county/parish, latitude/longitude, waterbody name/segment number, waterbody type, and site description)
- Sampling depth (specify units of depth)
- Collection method
- Collectors' names and signatures
- Agency (including telephone number and address)

Field Record for Fish Contaminant Monitoring Program — Screening Study

Project Number: _____ Sampling Date and Time: _____

SITE LOCATION _____

Site Name/Number: _____

County/Parish: _____ Lat./Long.: _____

Waterbody Name/Segment Number: _____

Waterbody Type: RIVER LAKE ESTUARY

Site Description: _____

Collection Method: _____

Collector Name: _____
(print and sign)

Agency: _____ Phone: (____) _____

Address: _____

FISH COLLECTED _____

Bottom Feeder—Species Name: _____

Composite Sample #: _____ Number of Individuals: _____

Fish #	Length (mm)	Sex	Fish #	Length (mm)	Sex
001	_____	___	006	_____	___
002	_____	___	007	_____	___
003	_____	___	008	_____	___
004	_____	___	009	_____	___
005	_____	___	010	_____	___

Minimum size _____ x 100 = _____ >75% Composite mean length _____ mm

Maximum size _____

Notes (e.g., morphological anomalies): _____

Predator—Species Name: _____

Composite Sample #: _____ Number of Individuals: _____

Fish #	Length (mm)	Sex	Fish #	Length (mm)	Sex
001	_____	___	006	_____	___
002	_____	___	007	_____	___
003	_____	___	008	_____	___
004	_____	___	009	_____	___
005	_____	___	010	_____	___

Minimum size _____ x 100 = _____ ≥ 75% Composite mean length _____ mm

Maximum size _____

Notes (e.g., morphological anomalies): _____

Figure 6-3. Example of a field record for fish contaminant monitoring program—screening study.

Field Record for Shellfish Contaminant Monitoring Program — Screening Study

Project Number: _____ Sampling Date and Time: _____

SITE LOCATION

Site Name/Number: _____

County/Parish: _____ Lat./Long.: _____

Waterbody Name/Segment Number: _____

Waterbody Type: RIVER LAKE ESTUARY

Site Description: _____

Collection Method: _____

Collector Name: _____
(print and sign)

Agency: _____ Phone: (____) _____

Address: _____

SHELLFISH COLLECTED

Bivalve Species Name: _____

Composite Sample #: _____ Number of Individuals: _____

Bivalve #	Size (mm)	Bivalve #	Size (mm)	Bivalve #	Size (mm)
001	_____	018	_____	035	_____
002	_____	019	_____	036	_____
003	_____	020	_____	037	_____
004	_____	021	_____	038	_____
005	_____	022	_____	039	_____
006	_____	023	_____	040	_____
007	_____	024	_____	041	_____
008	_____	025	_____	042	_____
009	_____	026	_____	043	_____
010	_____	027	_____	044	_____
011	_____	028	_____	045	_____
012	_____	029	_____	046	_____
013	_____	030	_____	047	_____
014	_____	031	_____	048	_____
015	_____	032	_____	049	_____
016	_____	033	_____	050	_____
017	_____	034	_____		

Minimum size _____ x 100 = _____ ≥ 75% Composite mean size _____ mm

Maximum size _____

Notes (e.g., morphological anomalies): _____

Figure 6-4. Example of a field record for shellfish contaminant monitoring program—screening study.

Field Record for Fish Contaminant Monitoring Program — Intensive Study

Project Number: _____ Sampling Date and Time: _____

SITE LOCATION

Site Name/Number: _____

County/Parish: _____ Lat./Long.: _____

Waterbody Name/Segment Number: _____

Waterbody Type: RIVER LAKE ESTUARY

Site Description: _____

Collection Method: _____

Collector Name: _____
(print and sign)

Agency: _____ Phone: (____) _____

Address: _____

FISH COLLECTED

Species Name: _____ **Replicate Number:** _____

Composite Sample #: _____ Number of Individuals: _____

Fish #	Length (mm)	Sex (M, F, or I)	Fish #	Length (mm)	Sex (M, F, or I)
001	_____	___	006	_____	___
002	_____	___	007	_____	___
003	_____	___	008	_____	___
004	_____	___	009	_____	___
005	_____	___	010	_____	___

Minimum length _____ x 100 = _____ % Composite mean length _____ mm

Maximum length _____

Notes (e.g., morphological anomalies): _____

Species Name: _____ **Replicate Number:** _____

Composite Sample #: _____ Number of Individuals: _____

Fish #	Length (mm)	Sex (M, F, or I)	Fish #	Length (mm)	Sex (M, F, or I)
001	_____	___	006	_____	___
002	_____	___	007	_____	___
003	_____	___	008	_____	___
004	_____	___	009	_____	___
005	_____	___	010	_____	___

Minimum length _____ x 100 = _____ ≥ 75% Composite mean length _____ mm

Maximum length _____

Notes (e.g., morphological anomalies): _____

page 1 of 2

Figure 6-5. Example of a field record for fish contaminant monitoring program—intensive study.

Field Record for Fish Contaminant Monitoring Program — Intensive Study (con.)

Project Number: _____ Sampling Date and Time: _____

SITE LOCATION:

Site Name/Number: _____

County/Parish: _____ Lat./Long.: _____

FISH COLLECTED

Species Name: _____ **Replicate Number:** _____

Composite Sample #: _____ Number of Individuals: _____

Fish #	Length (mm)	Sex (M, F, or I)	Fish #	Length (mm)	Sex (M, F, or I)
001	_____	_____	006	_____	_____
002	_____	_____	007	_____	_____
003	_____	_____	008	_____	_____
004	_____	_____	009	_____	_____
005	_____	_____	010	_____	_____

Minimum length _____ x 100 = _____ % Composite mean length _____ mm

Maximum length _____

Notes (e.g., morphological anomalies): _____

Species Name: _____ **Replicate Number:** _____

Composite Sample #: _____ Number of Individuals: _____

Fish #	Length (mm)	Sex (M, F, or I)	Fish #	Length (mm)	Sex (M, F, or I)
001	_____	_____	006	_____	_____
002	_____	_____	007	_____	_____
003	_____	_____	008	_____	_____
004	_____	_____	009	_____	_____
005	_____	_____	010	_____	_____

Minimum length _____ x 100 = _____ % Composite mean length _____ mm

Maximum length _____

Notes (e.g., morphological anomalies): _____

Species Name: _____ **Replicate Number:** _____

Composite Sample #: _____ Number of Individuals: _____

Fish #	Length (mm)	Sex (M, F, or I)	Fish #	Length (mm)	Sex (M, F, or I)
001	_____	_____	006	_____	_____
002	_____	_____	007	_____	_____
003	_____	_____	008	_____	_____
004	_____	_____	009	_____	_____
005	_____	_____	010	_____	_____

Minimum length _____ x 100 = _____ ≥ 75% Composite mean length _____ mm

Maximum length _____

Notes (e.g., morphological anomalies): _____

Figure 6-5. (continued)

Field Record for Shellfish Contaminant Monitoring Program — Intensive Study

Project Number: _____ Sampling Date and Time: _____

SITE LOCATION

Site Name/Number: _____

County/Parish: _____ Lat./Long.: _____

Waterbody Name/Segment Number: _____

Waterbody Type: RIVER LAKE ESTUARY

Site Description: _____

Collection Method: _____

Collector Name: _____
(print and sign)

Agency: _____ Phone: (____) _____

Address: _____

SHELLFISH COLLECTED

Species Name: _____ Replicate Number: _____

Composite Sample #: _____ Number of Individuals: _____

Shellfish #	Size (mm)	Sex	Shellfish #	Size (mm)	Sex	Shellfish #	Size (mm)	Sex
001	_____	_____	018	_____	_____	035	_____	_____
002	_____	_____	019	_____	_____	036	_____	_____
003	_____	_____	020	_____	_____	037	_____	_____
004	_____	_____	021	_____	_____	038	_____	_____
005	_____	_____	022	_____	_____	039	_____	_____
006	_____	_____	023	_____	_____	040	_____	_____
007	_____	_____	024	_____	_____	041	_____	_____
008	_____	_____	025	_____	_____	042	_____	_____
009	_____	_____	026	_____	_____	043	_____	_____
010	_____	_____	027	_____	_____	044	_____	_____
011	_____	_____	028	_____	_____	045	_____	_____
012	_____	_____	029	_____	_____	046	_____	_____
013	_____	_____	030	_____	_____	047	_____	_____
014	_____	_____	031	_____	_____	048	_____	_____
015	_____	_____	032	_____	_____	049	_____	_____
016	_____	_____	033	_____	_____	050	_____	_____
017	_____	_____	034	_____	_____			

Minimum size _____ x 100 = _____ ≥ 75% Composite mean size _____ mm

Maximum size _____

Notes (e.g., morphological anomalies): _____

Figure 6-6. Example of a field record for shellfish contaminant monitoring program—intensive study.

- Species collected (including species common and scientific name, composite sample number, individual specimen number, number of individuals per composite sample, number of replicate samples, total length/size [mm], sex [male, female, indeterminate])

Note: States should specify a unique numbering system to track samples for their own fish and shellfish contaminant monitoring programs.

- Percent difference in size between the smallest and largest specimens to be composited (smallest individual length [or size] divided by the largest individual length [or size] x 100; should be ≥ 75 percent) and mean composite length or size (mm)
- Notes (including visible morphological abnormalities, e.g., fin erosion, skin ulcers, cataracts, skeletal and exoskeletal anomalies, neoplasms, or parasites).

6.2.3.2 Sample Identification Label—

A sample identification label should be completed in indelible ink for each individual fish or shellfish specimen after it is processed to identify each sample uniquely (Figure 6-7). The following information should be included on the sample identification label:

- Species scientific name or code number
- Total length/size of specimen (mm)
- Specimen number
- Sample type: F (fish fillet analysis only)
 S (shellfish edible portion analysis only)
 W (whole fish analysis)
 O (other fish tissue analysis)

Species Name or Code					Sample Type		
Total Length or Size (mm)			Sampling Site (name/number)				
Specimen Number						Sampling Date (YYYYMMDD)	
<input type="text"/>	<input type="text"/>	<input type="text"/>	<input type="text"/>	<input type="text"/>	<input type="text"/>	<input type="text"/>	<input type="text"/>
						Time (24-h clock)	

Figure 6-7. Example of a sample identification label.

- Sampling site—waterbody name and/or identification number
- Sampling date/time (give date in a Year 2000 compliant format [YYYYMMDD] and specify convention for time, e.g., 24-h clock).

A completed sample identification label should be taped to each aluminum-foil-wrapped specimen and the specimen should be placed in a waterproof plastic bag.

6.2.3.3 Chain-of-Custody Label or Tag—

A COC label or tag should be completed in indelible ink for each individual fish specimen. The information to be completed for each fish is shown in Figure 6-8.

Project Number		Collection Agency (name, address, phone)			
Sampling Site (name and/or ID number)			Sampler (name and signature)		
Composition Number/Specimen Number(s)		Chemical Analyses <input type="checkbox"/> All target analytes <input type="checkbox"/> Others (specify) _____		Study Type	
Sampling Date (YYYYMMDD) Time (24-h clock)				Screening	Intensive Phase I <input type="checkbox"/>
					Phase II <input type="checkbox"/>
Species Name or Code		Processing		Type of Ice	
		Whole Body	Resection	Wet	Dry
Comments					

Figure 6-8. Example of a chain-of-custody tag or label.

After all information has been completed, the COC label or tag should be taped or attached with string to the outside of the waterproof plastic bag containing the individual fish sample. Information on the COC label/tag should also be recorded on the COC form (Figure 6-9).

Because of the generally smaller size of shellfish, several individual aluminum-foil-wrapped shellfish specimens (within the same composite sample) may be placed in the same waterproof plastic bag. A COC label or tag should be completed in indelible ink for each shellfish composite sample. If more than 10 individual

shellfish are to be composited, several waterproof plastic bags may have to be used for the same composite. It is important not to place too many individual specimens in the same plastic bag to ensure proper preservation during shipping, particularly during summer months. Information on the COC label/tag should also be recorded on the COC form (Figure 6-9).

6.2.3.4 Chain-of-Custody Form—

A COC form should be completed in indelible ink for each shipping container (e.g., ice chest) used. Information recommended for documentation on the COC form (Figure 6-9) is necessary to track all samples from field collection to receipt at the processing laboratory. In addition, this form can be used for tracking samples through initial laboratory processing (e.g., resection) as described in Section 7.2.

Prior to sealing the ice chest, one copy of the COC form and a copy of the field record sheet should be sealed in a resealable waterproof plastic bag. This plastic bag should be taped to the inside cover of the ice chest so that it is maintained with the samples being tracked. Ice chests should be sealed with reinforced tape for shipment.

6.2.3.5 Field Logbook—

In addition to the four sample tracking forms discussed above, the field collection team should document in a field logbook any additional information on sample collection activities, hydrologic conditions (e.g., tidal stage), weather conditions, boat or equipment operations, or any other unusual activities observed (e.g., dredging) or problems encountered that would be useful to the program manager in evaluating the quality of the fish and shellfish contaminant monitoring data.

6.3 SAMPLE HANDLING

6.3.1 Sample Selection

6.3.1.1 Species Identification—

As soon as fish, shellfish, and turtles are removed from the collection device, they should be identified by species. Nontarget species or specimens of target species that do not meet size requirements (e.g., juveniles) should be returned to the water. Species identification should be conducted only by experienced personnel knowledgeable of the taxonomy of species in the waterbodies included in the contaminant monitoring program. Taxonomic keys, appropriate for the waters being sampled, should be consulted for species identification. Because the objective of both the screening and intensive monitoring studies is to determine the magnitude of contamination in specific fish, shellfish, and turtle species, it is necessary that all individuals used in a composite sample be of a single species.

Note: Correct species identification is important and different species should never be combined in a single composite sample.

When sufficient numbers of the target species have been identified to make up a composite sample, the species name and all other appropriate information should be recorded on the field record forms (Figures 6-3 through 6-6).

Note: EPA recommends that, when turtles are used as the target species, target analyte concentrations be determined for each turtle rather than for a composite turtle sample.

6.3.1.2 Initial Inspection and Sorting—

Individual fish of the selected target species should be rinsed in ambient water to remove any foreign material from the external surface. Large fish should be stunned by a sharp blow to the base of the skull with a wooden club or metal rod. This club or rod should be used solely for the purpose of stunning fish, and care should be taken to keep it reasonably clean to prevent contamination of the samples (Versar, 1982). Small fish may be placed on ice immediately after capture to stun them, thereby facilitating processing and packaging procedures. Once stunned, individual specimens of the target species should be grouped by species and general size class and placed in clean holding trays to prevent contamination. All fish should be inspected carefully to ensure that their skin and fins have not been damaged by the sampling equipment, and damaged specimens should be discarded (Versar, 1982).

Freshwater turtles should be rinsed in ambient water and their external surface scrubbed if necessary to remove any foreign matter from their carapace and limbs. Each turtle should be inspected carefully to ensure that the carapace and extremities have not been damaged by the sampling equipment, and damaged specimens should be discarded (Versar, 1982). Care should be taken when handling large turtles, particularly snapping turtles; many can deliver severe bites. Particularly during procedures that place fingers or hands within striking range of the sharp jaws, covering the turtle's head, neck, and forelimbs with a cloth towel or sack and taping it in place is often sufficient to prevent injury to the field sampling crew (Frye, 1994).

After inspection, each turtle should be placed individually in a heavy burlap sack or canvas bag tied tightly with a strong cord and then placed in an ice-filled cooler. Placing turtles on ice will slow their metabolic rate, making them easier to handle.

Note: It is recommended that each turtle be analyzed as an individual sample, especially if the target turtle species is not abundant in the waterbody being sampled or if the collected individuals differ greatly in size or age. Analysis of individual turtles can provide an estimate of the maximum contaminant concentrations to which recreational or subsistence fishers are exposed. Target analyte concentrations in composite samples represent averages for a specific target species population. The use of these values in risk assessment is appropriate if the objective is to estimate the average concentration to which consumers of the target species are exposed over a long period of time. The use of long exposure periods (e.g., 70 years) is typical for the assessment of

carcinogenic effects, which may be manifest over an entire lifetime (see Volume II of this guidance series). Noncarcinogenic effects, on the other hand, may cause acute health effects over a relatively short period of time (e.g., hours or days) after consumption. The maximum target analyte contaminant concentration may be more appropriate than the average target analyte concentration for use with noncarcinogenic target analytes (U.S. EPA, 1989d). This is especially important for those target analytes for which acute exposures to very high concentrations may be toxic to consumers.

Stone et al. (1980) reported extremely high concentrations of PCBs in various tissues of snapping turtles from a highly contaminated site on the Hudson River. Contaminant analysis of various turtle tissues showed mean PCB levels of 2,991 ppm in fatty tissue, 66 ppm in liver tissue, and 29 ppm in eggs as compared to 4 ppm in skeletal muscle. Clearly, inclusion of the fatty tissue, liver, and eggs with the muscle tissues as part of the edible tissues will increase observed residue concentrations over those detected in muscle tissue only. States interested in using turtles as target species should review Appendix C for additional information on the use of individual samples in contaminant monitoring programs.

Bivalves (oysters, clams, scallops, and mussels) adhering to one another should be separated and scrubbed with a nylon or natural fiber brush to remove any adhering detritus or fouling organisms from the exterior shell surfaces (NOAA, 1987). All bivalves should be inspected carefully to ensure that the shells have not been cracked or damaged by the sampling equipment and damaged specimens should be discarded (Versar, 1982). Crustaceans, including shrimp, crabs, crayfish, and lobsters, should be inspected to ensure that their exoskeletons have not been cracked or damaged during the sampling process, and damaged specimens should be discarded (Versar, 1982). After shellfish have been rinsed, individual specimens should be grouped by target species and placed in clean holding trays to prevent contamination.

A few shellfish specimens may be resected (edible portions removed) to determine wet weight of the edible portions. This will provide an estimate of the number of individuals required to ensure that the recommended sample weight (200 g) is attained. **Note:** Individuals used to determine the wet weight of the edible portion should not be used for target analyte analyses.

6.3.1.3 Length or Size Measurements—

Each fish within the selected target species should be measured to determine total body length (mm). To be consistent with the convention used by most fisheries biologists in the United States, maximum body length should be measured as shown in Figure 6-10. The maximum body length is defined as the length from the anterior-most part of the fish to the tip of the longest caudal fin ray (when the lobes of the caudal fin are compressed dorsoventrally) (Anderson and Gutreuter, 1983).

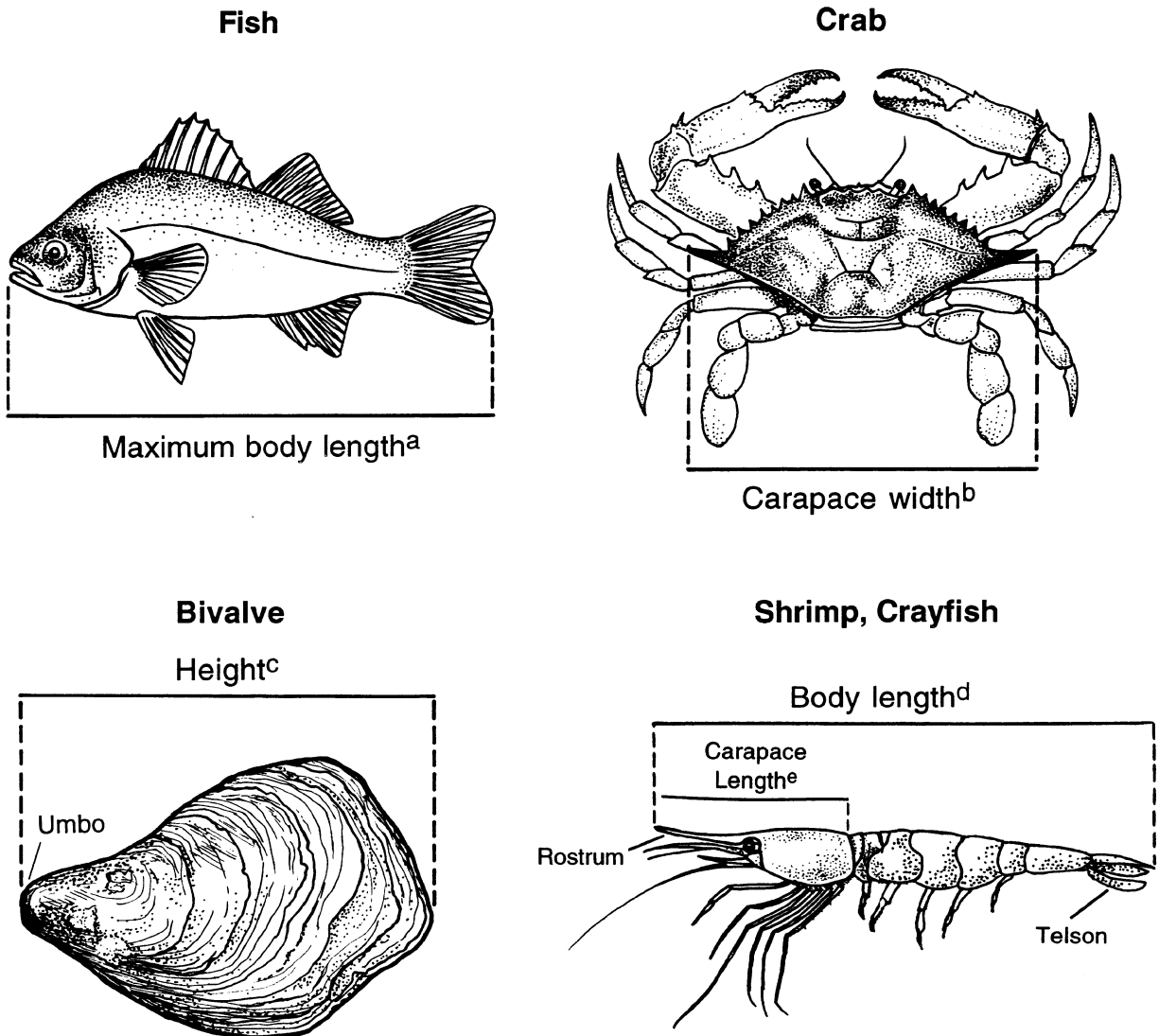

- ^a Maximum body length is the length from the anterior-most part of the fish to the tip of the longest caudal fin ray (when the lobes of the caudal fin are compressed dorsoventrally (Anderson and Gutreuter, 1983).
- ^b Carapace width is the lateral distance across the carapace (from tip of spine to tip of spine (U.S. EPA, 1990c).
- ^c Height is the distance from the umbo to the anterior (ventral) shell margin (Galtsoff, 1964).
- ^d Body length is the distance from the tip of the rostrum to the tip of the telson (Texas Water Commission, 1990).
- ^e Carapace length is distance from top of rostrum to the posterior margin of the carapace.

Figure 6-10. Recommended measurements of body length and size for fish, shellfish, and turtles.

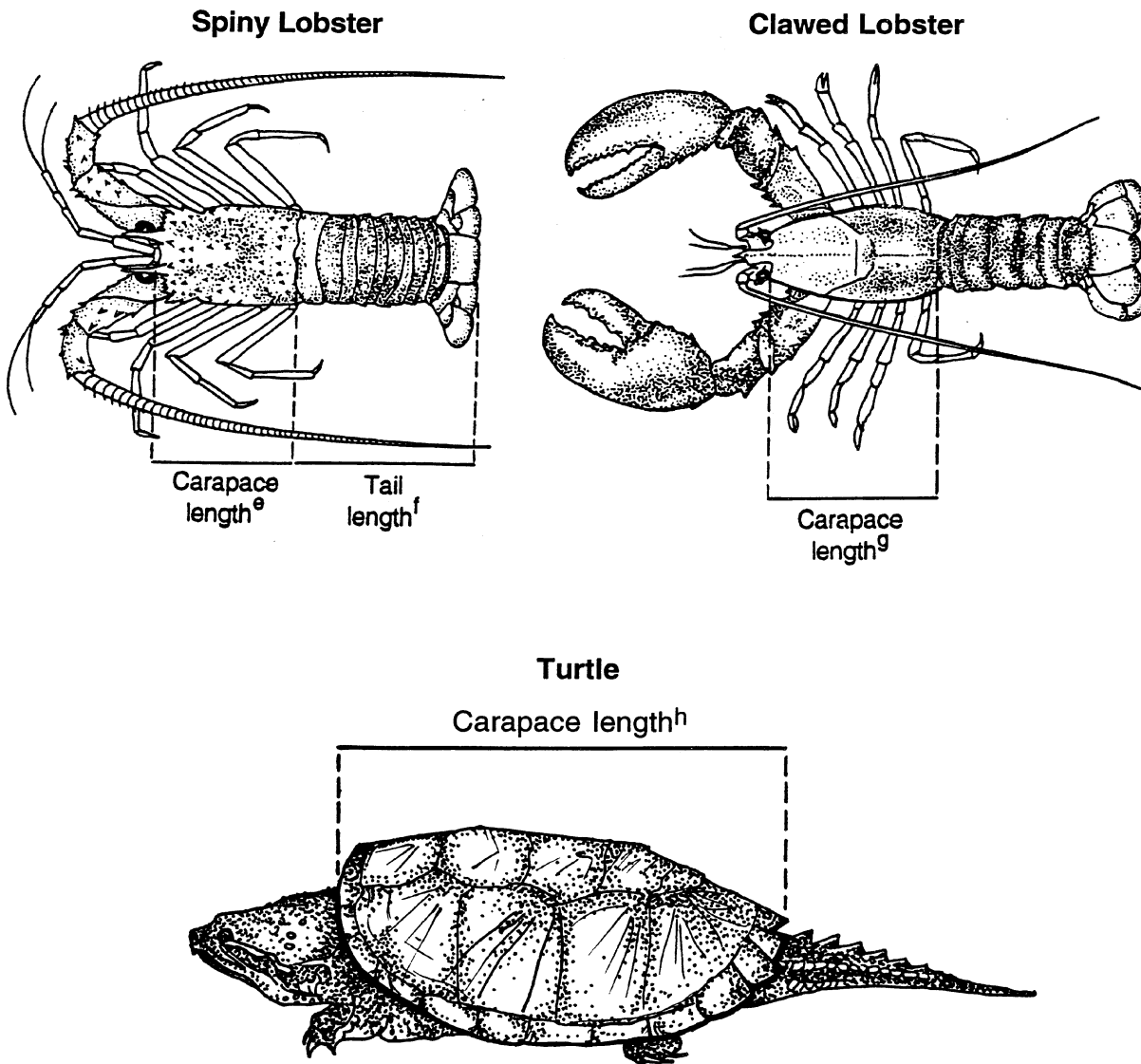

- ^e Carapace length is the distance from the anterior-most edge of the groove between the horns directly above the eyes, to the rear edge of the top part of the carapace as measured along the middorsal line of the back (Laws of Florida Chapter 46-24.003).
- ^f Tail length is the distance measured lengthwise along the top middorsal line of the entire tail to rear-most extremity (this measurement shall be conducted with the tail in a flat straight position with the tip of the tail closed) (Laws of Florida Chapter 46-24.003).
- ^g Carapace length is the distance from the rear of the eye socket to the posterior margin of the carapace (New York Environmental Conservation Law 13-0329.5.a and Massachusetts General Laws Chapter 130).
- ^h Carapace length is the straight-line distance from the anterior margin to the posterior margin of the shell (Conant and Collins, 1991).

Figure 6-10. (continued)

Each turtle within the selected target species should be measured to determine total carapace length (mm). To be consistent with the convention used by most herpetologists in the United States, carapace length should be measured as shown in Figure 6-10. The maximum carapace length is defined as the straight line distance from the anterior edge of the carapace to the posterior edge of the carapace (Conant and Collins, 1991).

For shellfish, each individual specimen should be measured to determine the appropriate body size (mm). As shown in Figure 6-9, the recommended body measurements differ depending on the type of shellfish being collected. Height is a standard measurement of size for oysters, mussels, clams, scallops, and other bivalve molluscs (Abbott, 1974; Galtsoff, 1964). The height is the distance from the umbo to the anterior (ventral) shell margin. For crabs, the lateral width of the carapace is a standard size measurement (U.S. EPA, 1990c); for shrimp and crayfish, the standard measurement of body size is the length from the rostrum to the tip of the telson (Texas Water Commission, 1990); and for lobsters, two standard measurements of body size are commonly used. For clawed and spiny lobsters, the standard size is the length of the carapace. For spiny lobsters, the length of the tail is also used as a standard size measurement.

6.3.1.4 Sex Determination (Optional)—

An experienced fisheries biologist can often make a preliminary sex determination for fish by visual inspection. The body of the fish should not be dissected in the field to determine sex; sex can be determined through internal examination of the gonads during laboratory processing (Section 7.2.2.4).

An experienced herpetologist can often make a preliminary sex determination of a turtle by visual inspection in the field. The plastron (ventral portion of the carapace) is usually flatter in the female and the tail is less well developed than in the male. The plastron also tends to be more concave in the male (Holmes, 1984). For the common snapping turtle (*Chelydra serpentina*), the cloaca of the female is usually located inside or at the perimeter of the carapace, while the cloaca of the male extends slightly beyond the perimeter of the carapace. The carapace of the turtle should never be resected in the field to determine sex; sex can be determined through internal examination of the gonads during laboratory processing (Section 7.2.3.4.). For shellfish, a preliminary sex determination can be made by visual inspection only for crustaceans. Sex cannot be determined in bivalve molluscs without shucking the bivalves and microscopically examining gonadal material. Bivalves should not be shucked in the field to determine sex; sex determination through examination of the gonads can be performed during laboratory processing if desired (Section 7.2.4.2).

6.3.1.5 Morphological Abnormalities (Optional)—

If resources allow, states may wish to consider documenting external gross morphological conditions in fish from contaminated waters. Severely polluted

aquatic habitats have been shown to produce a higher frequency of gross pathological disorders than similar, less polluted habitats (Krahn et al., 1986; Malins et al., 1984, 1985; Mix, 1986; Sinderman, 1983; and Sinderman et al., 1980).

Sinderman et al. (1980) reviewed the literature on the relationship of fish pathology to pollution in marine and estuarine environments and identified four gross morphological conditions acceptable for use in monitoring programs:

- Fin erosion
- Skin ulcers
- Skeletal anomalies
- Neoplasms (i.e., tumors).

Fin erosion is the most frequently observed gross morphological abnormality in polluted areas and is found in a variety of fishes (Sinderman, 1983). In demersal fishes, the dorsal and anal fins are most frequently affected; in pelagic fishes, the caudal fin is primarily affected.

Skin ulcers have been found in a variety of fishes from polluted waters and are the second most frequently reported gross abnormality. Prevalence of ulcers generally varies with season and is often associated with organic enrichment (Sinderman, 1983).

Skeletal anomalies include abnormalities of the head, fins, gills, and spinal column (Sinderman, 1983). Skeletal anomalies of the spinal column include fusions, flexures, and vertebral compressions.

Neoplasms or tumors have been found at a higher frequency in a variety of polluted areas throughout the world. The most frequently reported visible tumors are liver tumors, skin tumors (i.e., epidermal papillomas and/or carcinomas), and neurilemmomas (Sinderman, 1983).

The occurrence of fish parasites and other gross morphological abnormalities that are found at a specific site should be noted on the field record form. States interested in documenting morphological abnormalities in fish should review the protocols for fish pathology studies recommended in the Puget Sound Estuary Program (1990c) and those described by Goede and Barton (1990).

6.3.2 Sample Packaging

6.3.2.1 Fish—

After initial processing to determine species, size, sex, and morphological abnormalities, each fish should be individually wrapped in extra heavy duty aluminum foil. Spines on fish should be sheared to minimize punctures in the aluminum foil packaging (Stober, 1991). The sample identification label shown in Figure 6-7 should be taped to the outside of each aluminum foil package, each individual fish should be placed into a waterproof plastic bag and sealed, and the

COC tag or label should be attached to the outside of the plastic bag with string or tape. All of the packaged individual specimens in a composite sample should be kept together (if possible) in one large waterproof plastic bag in the same shipping container (ice chest) for transport. Once packaged, samples should be cooled on ice immediately.

6.3.2.2 Turtles—

After initial processing to determine the species, size (carapace length), and sex, each turtle should be placed on ice in a separate burlap or canvas bag and stored on ice for transport to the processing laboratory. A completed sample identification label (Figure 6-7) should be attached with string around the neck or one of the turtle's extremities and the COC tag or label should be attached to the outside of the bag with string or tape. **Note:** Bagging each turtle should not be undertaken until the specimen has been sufficiently cooled to induce a mild state of torpor, thus facilitating processing. The samplers should work rapidly to return each turtle to the ice chest as soon as possible after packaging as the turtle may suddenly awaken as it warms thus becoming a danger to samplers (Frye, 1994). As mentioned in Section 6.3.1, states should analyze turtles individually rather than compositing samples. This is especially important when very few specimens are collected at a sampling site or when specimens of widely varying size or age are collected.

Note: When a large number of individual specimens in the same composite sample are shipped together in the same waterproof plastic bag, the samples must have adequate space in the bag to ensure that contact with ice can occur, thus ensuring proper preservation during shipping. This is especially important when samples are collected during hot weather and/or when the time between field collection and delivery to the processing laboratory approaches the maximum shipping time (Table 6-8).

6.3.2.3 Shellfish—

After initial processing to determine species, size, sex, and morphological abnormalities, each shellfish specimen should be wrapped individually in extra heavy duty aluminum foil. A completed sample identification label (Figure 6-7) should be taped to the outside of each aluminum foil package. **Note:** Some crustacean species (e.g., blue crabs and spiny lobsters) have sharp spines on their carapace that might puncture the aluminum foil wrapping. Carapace spines should never be sheared off because this would destroy the integrity of the carapace. For such species, one of the following procedures should be used to reduce punctures to the outer foil wrapping:

- Double-wrap the entire specimen in extra heavy duty aluminum foil.
- Place clean cork stoppers over the protruding spines prior to wrapping the specimen in aluminum foil.

Table 6-8. Recommendations for Preservation of Fish, Shellfish, and Turtle Samples from Time of Collection to Delivery at the Processing Laboratory

Sample type	Number per composite	Container	Preservation	Maximum shipping time
Fish^a				
Whole fish (to be filleted)	3-10	Extra heavy duty aluminum foil wrap of each fish. ^b Each fish is placed in a waterproof plastic bag.	Cool on wet ice or blue ice packets (preferred method) or Freeze on dry ice only if shipping time will exceed 24 hours	24 hours 48 hours
Whole fish	3-10	Same as above.	Cool on wet ice or blue ice packets or Freeze on dry ice	24 hours 48 hours
Shellfish^a				
Whole shellfish (to be resected for edible tissue)	3-50 ^c	Extra heavy duty aluminum foil wrap of each specimen. ^b Shellfish in the same composite sample may be placed in the same waterproof plastic bag.	Cool on wet ice or blue ice packets (preferred method) or Freeze on dry ice if shipping time will exceed 24 hours	24 hours 48 hours
Whole shellfish	3-50 ^c	Same as above.	Cool on wet ice or blue ice packets or Freeze on dry ice	24 hours 48 hours
Whole turtles (to be resected for edible tissue)	1 ^d	Heavy burlap or canvas bags.	Cool on wet ice or blue ice packets (preferred method) or Freeze on dry ice if shipping time to exceed 24 hours	24 hours 48 hours

^a Use only individuals that have attained at least legal harvestable or consumable size.

^b Aluminum foil should not be used for long-term storage of any sample (i.e., whole organisms, fillets, or homogenates) that will be analyzed for metals.

^c Species and size dependent. For very small shellfish species, more than 50 individuals may be required to achieve the 200-g composite sample mass recommended for screening studies.

^d Turtles should be analyzed as individual rather than as composite samples.

- Wrap the spines with multiple layers of foil before wrapping the entire specimen in aluminum foil.

All of the individual aluminum-foil-wrapped shellfish specimens (in the same composite sample) should be placed in the same waterproof plastic bag for transport. In this case, a COC tag or label should be completed for the composite sample and appropriate information recorded on the field record sheet and COC form. The COC label or tag should then be attached to the outside of the plastic

bag with string or tape. For composite samples containing more than 10 shellfish specimens or especially large individuals, additional waterproof plastic bags may be required to ensure proper preservation. Once packaged, composite samples should be cooled on ice immediately. **Note:** When a large number of individual specimens in the same composite sample are shipped together in the same waterproof plastic bag, the samples must have adequate space in the bag to ensure that contact with ice can occur; thus ensuring proper preservation during shipping. This is especially important when samples are collected during hot weather and/or when the time between field collection and delivery to the processing laboratory approaches the maximum shipping time (Table 6-8).

6.3.3 Sample Preservation

The type of ice to be used for shipping should be determined by the length of time the samples will be in transit to the processing laboratory and the sample type to be analyzed (Table 6-8).

6.3.3.1 Fish, Turtles, or Shellfish To Be Resected—

Note: Ideally fish, turtles, and shellfish specimens should not be frozen prior to resection if analyses will include edible tissue only because freezing may cause some internal organs to rupture and contaminate fillets or other edible tissues (Stober, 1991; U.S. EPA, 1986b). Wet ice or blue ice (sealed prefrozen ice packets) is recommended as the preservative of choice when the fish fillet, turtle meat, or shellfish edible portions are the primary tissues to be analyzed. Samples shipped on wet or blue ice should be delivered to the processing laboratory within 24 hours (Smith, 1985; U.S. EPA, 1990d). If the shipping time to the processing laboratory will exceed 24 hours, dry ice should be used.

Note: One exception to the use of dry ice for long-term storage is if fish or shellfish are collected as part of extended offshore field surveys. States involved in these types of field surveys may employ shipboard freezers to preserve samples for extended periods rather than using dry ice. Ideally, all fish should be resected in cleanrooms aboard ship prior to freezing.

6.3.3.2 Fish, Turtles, or Shellfish for Whole-Body Analysis—

At some sites, states may deem it necessary to collect fish, turtles, or shellfish for whole-body analysis if a local subpopulation of concern typically consumes whole fish, turtles, or shellfish. If whole fish, turtles, or shellfish samples are to be analyzed, either wet ice, blue ice, or dry ice may be used; however, if the shipping time to the processing laboratory will exceed 24 hours, dry ice should be used.

Dry ice requires special packaging precautions before shipping by aircraft to comply with U.S. Department of Transportation (DOT) regulations. The *Code of Federal Regulations* (49 CFR 173.217) classifies dry ice as Hazard Class 9 UN1845 (Hazardous Material). These regulations specify the amount of dry ice

that may be shipped by air transport and the type of packaging required. For each shipment by air exceeding 5 pounds of dry ice per package, advance arrangements must be made with the carrier. Not more than 441 pounds of dry ice may be transported in any one cargo compartment on any aircraft unless the shipper has made special written arrangements with the aircraft operator.

The regulations further specify that the packaging must be designed and constructed to permit the release of carbon dioxide gas to prevent a buildup of pressure that could rupture the package. If samples are transported in a cooler, several vent holes should be drilled to allow carbon dioxide gas to escape. The vents should be near the top of the vertical sides of the cooler, rather than in the cover, to prevent debris from falling into the cooler. Wire screen or cheesecloth should be installed in the vents to keep foreign materials from contaminating the cooler. When the samples are packaged, care should be taken to keep these vents open to prevent the buildup of pressure.

Dry ice is exempted from shipping certification requirements if the amount is less than 441 pounds and the package meets design requirements. The package must be marked "Carbon Dioxide, Solid" or "Dry Ice" with a statement indicating that the material being refrigerated is to be used for diagnostic or treatment purposes (e.g., frozen tissue samples).

6.3.4 Sample Shipping

The fish, turtle, and shellfish samples should be hand-delivered or shipped to the processing laboratory as soon as possible after collection. The time the samples were collected and time of their arrival at the processing laboratory should be recorded on the COC form (Figure 6-9).

If the sample is to be shipped rather than hand-delivered to the processing laboratory, field collection staff must ensure the samples are packed properly with adequate ice layered between samples so that sample degradation does not occur. In addition, a member of the field collection staff should telephone ahead to the processing laboratory to alert them to the anticipated delivery time of the samples and the name and address of the carrier to be used. Field collection staff should avoid shipping samples for weekend delivery to the processing laboratory unless prior plans for such a delivery have been agreed upon with the processing laboratory staff.

SECTION 7

LABORATORY PROCEDURES I — SAMPLE HANDLING

This section provides guidance on laboratory procedures for sample receipt, chain-of-custody, processing, distribution, analysis, and archiving. Planning, documentation, and quality assurance and quality control of all laboratory activities are emphasized to ensure that (1) sample integrity is preserved during all phases of sample handling and analysis, (2) chemical analyses are performed cost-effectively and meet program data quality objectives, and (3) data produced by different states and regions are comparable.

Laboratory procedures should be documented in a Work/QA Project Plan (U.S. EPA, 1980b) as described in Appendix I. Routine sample processing and analysis procedures should be prepared as standard operating procedures (SOPs) (U.S. EPA, 1984b).

7.1 SAMPLE RECEIPT AND CHAIN-OF-CUSTODY

Fish, shellfish, and turtle samples may be shipped or hand-carried from the field according to one or more of the following pathways:

- From the field to a state laboratory for sample processing and analysis
- From the field to a state laboratory for sample processing and shipment of composite sample aliquots to a contract laboratory for analysis
- From the field to a contract laboratory for sample processing and analysis.

Sample processing and distribution for analysis ideally should be performed by one processing laboratory. Transportation of samples from the field should be coordinated by the sampling team supervisor and the laboratory supervisor responsible for sample processing and distribution (see Section 6.3.4). An accurate written custody record must be maintained so that possession and treatment of each sample can be traced from the time of collection through analysis and final disposition.

Fish, shellfish, and turtle samples should be brought or shipped to the sample processing laboratory in sealed containers accompanied by a copy of the sample request form (Figure 6-1), a chain-of-custody form (Figure 6-9), and the field records (Figures 6-3 through 6-6). Each time custody of a sample or set of samples is transferred, the Personnel Custody Record of the COC form must be completed and signed by both parties. Corrections to the COC form should be made in indelible ink by drawing a single line through the original entry, entering

7. LABORATORY PROCEDURES I — SAMPLE HANDLING

the correct information and the reason for the change, and initialing and dating the correction. The original entry should never be obscured.

When custody is transferred from the field to the sample processing laboratory, the following procedure should be used:

- Note the shipping time. If samples have been shipped on wet or blue ice, check that the shipping time has not exceeded 24 hours.
- Check that each shipping container has arrived undamaged and that the seal is intact.
- Open each shipping container and remove the copy of the sample request form, the COC form, and the field records.
- Note the general condition of the shipping container (samples iced properly with no leaks, etc.) and the accompanying documentation (dry, legible, etc.).
- Locate individuals in each composite sample listed on the COC form and note the condition of their packaging. Individual specimens should be properly wrapped and labeled. Note any problems (container punctured, illegible labels, etc.) on the COC form.
- If individuals in a composite are packaged together, check the contents of each composite sample container against the field record for that sample to ensure that the individual specimens are properly wrapped and labeled. Note any discrepancies or missing information on the COC form.
- Initial the COC form and record the date and time of sample receipt.
- Enter the following information for each composite sample into a permanent laboratory record book and, if applicable, a computer database:
 - Sample identification number (specify conventions for the composite sample number and the specimen number) **Note:** EPA recommends processing and analysis of turtles as individual samples.
 - Receipt date (use Year 2000 compliant format [YYYYMMDD])
 - Sampling date (use Year 2000 compliant format [YYYYMMDD])
 - Sampling site (name and/or identification number)
 - Fish, turtle, and shellfish species (scientific name or code number)
 - Total length of each fish, carapace length of each turtle, or size of each shellfish (mm)

- If samples have been shipped on wet or blue ice, distribute them immediately to the technician responsible for resection (see Section 7.2). See Section 7.2.3 for the procedure for processing turtle samples as individual samples. If samples have been shipped on dry ice, they may be distributed immediately to the technician for processing or stored in a freezer at ≤ -20 °C for later processing. Once processed, fillets or edible portions of fish, turtles, or shellfish or tissue homogenates, should be stored according to the procedures described in Section 7.2 and in Table 7-1. **Note:** Holding times in Table 7-1 are maximum times recommended for holding samples from the time they are received at the laboratory until they are analyzed. These holding times are based on guidance that is sometimes administrative rather than technical in nature; there are no promulgated holding time criteria for tissues (U.S. EPA, 1995i). If states choose to use longer holding times, they must demonstrate and document the stability of the target analyte residues over the extended holding times.

7.2 SAMPLE PROCESSING

This section includes recommended procedures for preparing composite homogenate samples of fish fillets and edible portions of shellfish and individual samples of edible portions of freshwater turtles as required in screening and intensive studies. Recommended procedures for preparing whole fish composite homogenates are included in Appendix J for use by states in assessing the potential risk to local subpopulations known to consume whole fish or shellfish.

7.2.1 General Considerations

All laboratory personnel performing sample processing procedures (see Sections 7.2.2, 7.2.3, and 7.2.4) should be trained or supervised by an experienced fisheries biologist. Care must be taken during sample processing to avoid contaminating samples. Schmitt and Finger (1987) have demonstrated that contamination of fish flesh samples is likely unless the most exacting clean dissection procedures are used. Potential sources of contamination include dust, instruments, utensils, work surfaces, and containers that may contact the samples. All sample processing (i.e., filleting, removal of other edible tissue, homogenizing, compositing) should be done in an appropriate laboratory facility under cleanroom conditions (Stober, 1991). Cleanrooms or work areas should be free of metals and organic contaminants. Ideally, these areas should be under positive pressure with filtered air (HEPA filter class 100) (California Department of Fish and Game, 1990). Periodic wipe tests should be conducted in clean areas to verify the absence of significant levels of metal and organic contaminants. All instruments, work surfaces, and containers used to process samples must be of materials that can be cleaned easily and that are not themselves potential sources of contamination. More detailed guidance on establishing trace metal cleanrooms is provided in U.S. EPA (1995a).

7. LABORATORY PROCEDURES I — SAMPLE HANDLING

Table 7-1. Recommendations for Container Materials, Preservation, and Holding Times for Fish, Shellfish, and Turtle Tissues from Receipt at Sample Processing Laboratory to Analysis

Analyte	Matrix	Sample container	Storage	
			Preservation	Holding time ^a
Mercury	Tissue (fillets and edible portions, homogenates)	Plastic, borosilicate glass, quartz, PTFE	Freeze at ≤ -20 °C	28 days ^b
Other metals	Tissue (fillets and edible portions, homogenates)	Plastic, borosilicate glass, quartz, PTFE	Freeze at ≤ -20 °C	6 months ^c
Organics	Tissue (fillets and edible portions, homogenates)	Borosilicate glass, PTFE, quartz, aluminum foil	Freeze at ≤ -20 °C	1 year ^d
Metals and organics	Tissue (fillets and edible portions, homogenates)	Borosilicate glass, quartz, PTFE	Freeze at ≤ -20 °C	28 days (for mercury); 6 months (for other metals); and 1 year (for organics)
Lipids	Tissue (fillets and edible portions, homogenates)	Plastic, borosilicate glass, quartz, PTFE	Freeze at ≤ -20 °C	1 year

PTFE = Polytetrafluoroethylene (Teflon).

^a Maximum holding times recommended by EPA (1995i).

^b This maximum holding time is also recommended by the Puget Sound Estuary Program (1990e). The California Department of Fish and Game (1990) and the USGS National Water Quality Assessment Program (Crawford and Luoma, 1993) recommend a maximum holding time of 6 months for all metals, including mercury.

^c This maximum holding time is also recommended by the California Department of Fish and Game (1990), the 301(h) monitoring program (U.S. EPA, 1986b), and the USGS National Water Quality Assessment Program (Crawford and Luoma, 1993). The Puget Sound Estuary Program (1990e) recommends a maximum holding time of 2 years.

^d This maximum holding time is also recommended by the Puget Sound Estuary Program (1990e). The California Department of Fish and Game (1990) and the USGS National Water Quality Assessment Program (Crawford and Luoma, 1993) recommend a more conservative maximum holding time of 6 months. U.S. EPA (1995b) recommends a maximum holding time of 1 year at ≤ -10 °C for dioxins/furans.

To avoid cross-contamination, all equipment used in sample processing (i.e., resecting, homogenizing, and compositing) should be cleaned thoroughly before each composite sample is prepared. Verification of the efficacy of cleaning procedures should be documented through the analysis of processing blanks or rinsates (see Section 8.3.3.6).

Because sources of organic and metal contaminants differ, it is recommended that duplicate samples be collected, if time and funding permit, when analyses of both organics and metals are required (e.g., for screening studies). One sample can then be processed and analyzed for organics and the other can be processed independently and analyzed for metals (Batelle, 1989; California Department of Fish and Game, 1990; Puget Sound Estuary Program, 1990c, 1990d). If fish are of adequate size, separate composites of individual fillets may be prepared and

analyzed independently for metals and organics. If only one composite sample is prepared for the analyses of metals and organics, the processing equipment must be chosen and cleaned carefully to avoid contamination by both organics and metals.

Suggested sample processing equipment and cleaning procedures by analysis type are discussed in Sections 7.2.1.1 through 7.2.1.3. Other procedures may be used if it can be demonstrated, through the analysis of appropriate blanks, that no contamination is introduced (see Section 8.3.3.6).

7.2.1.1 Samples for Organics Analysis—

Equipment used in processing samples for organics analysis should be of stainless steel, anodized aluminum, borosilicate glass, polytetrafluoroethylene (PTFE), ceramic, or quartz. Polypropylene and polyethylene (plastic) surfaces, implements, gloves, and containers are a potential source of contamination by organics and should not be used. If a laboratory chooses to use these materials, there should be clear documentation that they are not a source of contamination. Filleting should be done on glass or PTFE cutting boards that are cleaned properly between fish or on cutting boards covered with heavy duty aluminum foil that is changed after each filleting. Tissue should be removed with clean, high-quality, corrosion-resistant stainless steel or quartz instruments or with knives with titanium blades and PTFE handles (Lowenstein and Young, 1986). Fillets or tissue homogenates may be stored in borosilicate glass, quartz, or PTFE containers with PTFE-lined lids or in heavy duty aluminum foil (see Table 7-1).

Prior to preparing each composite sample, utensils and containers should be washed with detergent solution, rinsed with tap water, soaked in pesticide-grade isopropanol or acetone, and rinsed with organic-free, distilled, deionized water. Work surfaces should be cleaned with pesticide-grade isopropanol or acetone, washed with distilled water, and allowed to dry completely. Knives, fish scalers, measurement boards, etc., should be cleaned with pesticide-grade isopropanol or acetone followed by a rinse with contaminant-free distilled water between each fish sample (Stober, 1991).

7.2.1.2 Samples for Metals Analysis—

Equipment used in processing samples for metals analyses should be of quartz, PTFE, ceramic, polypropylene, or polyethylene. The predominant metal contaminants from stainless steel are chromium and nickel. If these metals are not of concern, the use of high-quality, corrosion-resistant stainless steel for sample processing equipment is acceptable. Quartz utensils are ideal but expensive. For bench liners and bottles, borosilicate glass is preferred over plastic (Stober, 1991). Knives with titanium blades and PTFE handles are recommended for performing tissue resections (Lowenstein and Young, 1986). Borosilicate glass bench liners are recommended. Filleting may be done on glass or PTFE cutting boards that are cleaned properly between fish or on cutting

boards covered with heavy duty aluminum foil that is changed after each fish. Fillets or tissue homogenates may be stored in plastic, borosilicate glass, quartz, or PTFE containers (see Table 7-1).

Prior to preparing each composite sample, utensils and containers should be cleaned thoroughly with a detergent solution, rinsed with tap water, soaked in acid, and then rinsed with metal-free water. Quartz, PTFE, glass, or plastic containers should be soaked in 50 percent HNO₃, for 12 to 24 hours at room temperature. **Note:** Chromic acid should not be used for cleaning any materials. Acids used should be at least reagent grade. Stainless steel parts may be cleaned as stated for glass or plastic, omitting the acid soaking step (Stober, 1991).

7.2.1.3 Samples for Both Organics and Metals Analyses—

As noted above, several established monitoring programs, including the Puget Sound Estuary Program (1990c, 1990d), the NOAA Mussel Watch Program (Battelle, 1989), and the California Mussel Watch Program (California Department of Fish and Game, 1990), recommend different procedures for processing samples for organics and metals analyses. However, this may not be feasible if fish are too small to allow for preparing separate composites from individual fillets or if resources are limited. If a single composite sample is prepared for the analyses of both organics and metals, precautions must be taken to use materials and cleaning procedures that are noncontaminating for both organics and metals.

Quartz, ceramic, borosilicate glass, and PTFE are recommended materials for sample processing equipment. If chromium and nickel are not of concern, high-quality, corrosion-resistant stainless steel utensils may be used. Knives with titanium blades and PTFE handles are recommended for performing tissue resections (Lowenstein and Young, 1986). Borosilicate glass bench liners are recommended. Filleting should be done on glass or PTFE cutting boards that are cleaned properly between fish or on cutting boards covered with heavy duty aluminum foil that is changed after each filleting. Fillets or tissue homogenates should be stored in clean borosilicate glass, quartz, or PTFE containers with PTFE-lined lids.

Prior to preparing each composite sample, utensils and containers should be cleaned thoroughly with a detergent solution, rinsed with tap water, soaked in 50 percent HNO₃, for 12 to 24 hours at room temperature, and then rinsed with organics- and metal-free water. **Note:** Chromic acid should not be used for cleaning any materials. Acids used should be at least reagent grade. Stainless steel parts may be cleaned using this recommended procedure with the acid soaking step method omitted (Stober, 1991).

Aliquots of composite homogenates taken for metals analysis (see Section 7.3.1) may be stored in plastic containers that have been cleaned according to the

procedure outlined above, with the exception that aqua regia must not be used for the acid soaking step.

7.2.2 Processing Fish Samples

Processing in the laboratory to prepare fish fillet composite homogenate samples for analysis (diagrammed in Figure 7-1) involves

- Inspecting individual fish
- Weighing individual fish
- Removing scales and/or otoliths for age determination (optional)
- Determining the sex of each fish (optional)
- Examining each fish for morphological abnormalities (optional)
- Scaling all fish with scales (leaving belly flap on); removing skin of scaleless fish (e.g., catfish)
- Filleting (resection)
- Weighing fillets
- Homogenizing fillets
- Preparing a composite homogenate
- Preparing aliquots of the composite homogenate for analysis
- Distributing frozen aliquots to one or more analytical laboratories.

Whole fish should be shipped or brought to the sample processing laboratory from the field on wet or blue ice within 24 hours of sample collection. Fillets should be resected within 48 hours of sample collection. Ideally, fish should not be frozen prior to resection because freezing may cause internal organs to rupture and contaminate edible tissue (Stober, 1991; U.S. EPA, 1986b). However, if resection cannot be performed within 48 hours, the whole fish should be frozen at the sampling site and shipped to the sample processing laboratory on dry ice. Fish samples that arrive frozen (i.e., on dry ice) at the sample processing laboratory should be placed in a ≤ -20 °C freezer for storage until filleting can be performed. The fish should then be partially thawed prior to resection. **Note:** If the fillet tissue is contaminated by materials released from the rupture of the internal organs during freezing, the state may eliminate the fillet tissue as a sample or, alternatively, the fillet tissues should be rinsed in contaminant-free, distilled deionized

7. LABORATORY PROCEDURES I — SAMPLE HANDLING

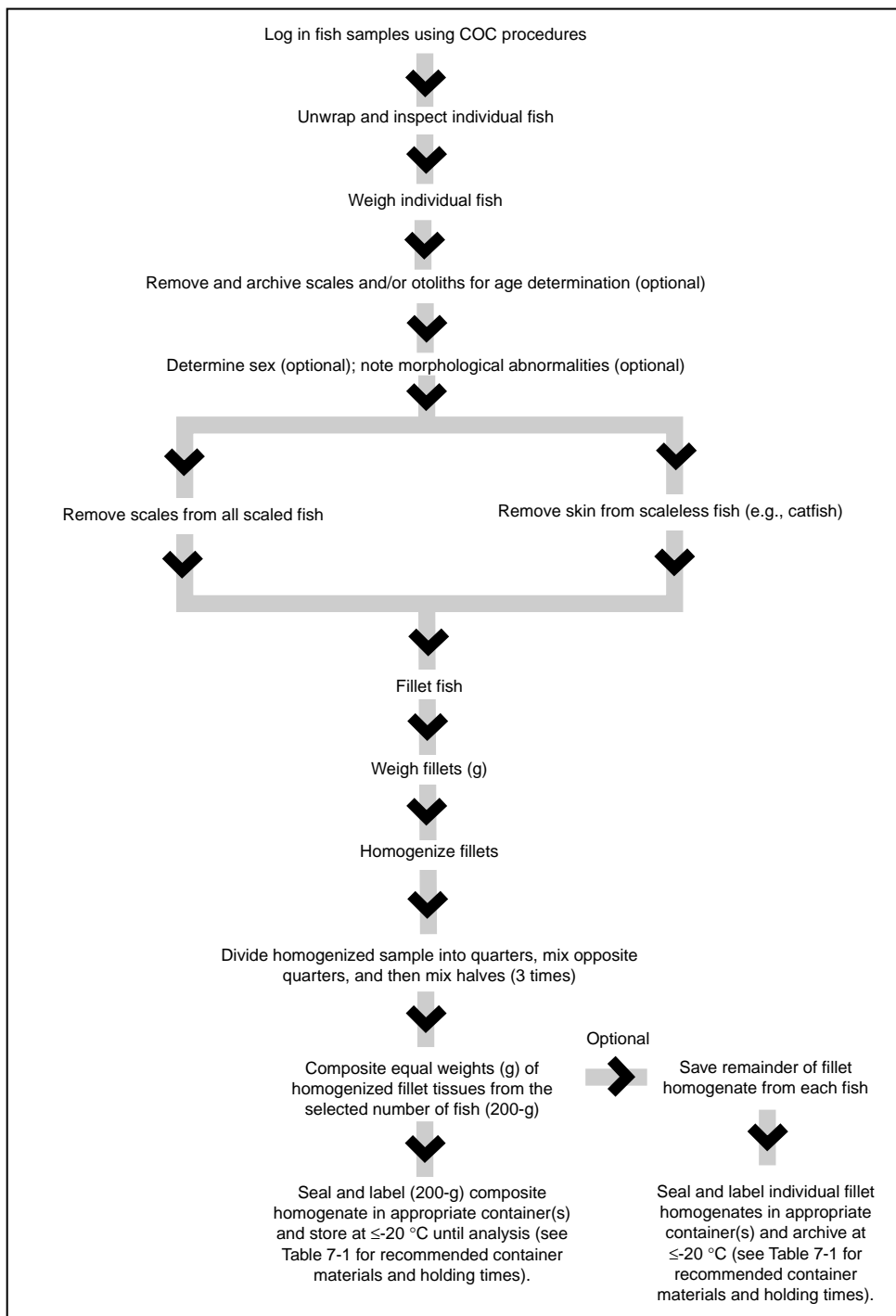

COC = Chain of custody.

Figure 7-1. Preparation of fish fillet composite homogenate samples.

water and blotted dry. Regardless of the procedure selected, a notation should be made in the sample processing record.

Sample processing procedures are discussed in the following sections. Data from each procedure should be recorded directly in a bound laboratory notebook or on forms that can be secured in the laboratory notebook. A sample processing record for fish fillet composites is shown in Figure 7-2.

7.2.2.1 Sample Inspection—

Individual fish received for filleting should be unwrapped and inspected carefully to ensure that they have not been compromised in any way (i.e., not properly preserved during shipment). Any specimen deemed unsuitable for further processing and analysis should be discarded and identified on the sample processing record.

7.2.2.2 Sample Weighing—

A wet weight should be determined for each fish. All samples should be weighed on balances that are properly calibrated and of adequate accuracy and precision to meet program data quality objectives. Balance calibration should be checked at the beginning and end of each weighing session and after every 20 weighings in a weighing session.

Fish shipped on wet or blue ice should be weighed directly on a foil-lined balance tray. To prevent cross contamination between individual fish, the foil lining should be replaced after each weighing. Frozen fish (i.e., those shipped on dry ice) should be weighed in clean, tared, noncontaminating containers if they will thaw before the weighing can be completed. **Note:** Liquid from the thawed whole fish sample will come not only from the fillet tissue but from the gut and body cavity, which are not part of the final fillet sample. Consequently, inclusion of this liquid with the sample may result in an overestimate of target analyte and lipid concentrations in the fillet homogenate. Nevertheless, it is recommended, as a conservative approach, that all liquid from the thawed whole fish sample be kept in the container as part of the sample.

All weights should be recorded to the nearest gram on the sample processing record and/or in the laboratory notebook.

7.2.2.3 Age Determination (Optional)—

Age provides a good indication of the duration of exposure to pollutants (Versar, 1982). A few scales or otoliths (Jearld, 1983) should be removed from each fish and delivered to a fisheries biologist for age determination. For most warm water inland gamefish, 5 to 10 scales should be removed from below the lateral line and behind the pectoral fin. On soft-rayed fish such as trout and salmon, the scales should be taken just above the lateral line (WDNR, 1988). For catfish and other

Sample Processing Record for Fish Contaminant Monitoring Program — Fish Fillet Composites

Project Number: _____ Sampling Date and Time: _____

STUDY PHASE: Screening Study ; Intensive Study: Phase I Phase II

SITE LOCATION

Site Name/Number: _____

County/Parish: _____ Lat./Long.: _____

Waterbody Name/Segment Number: _____ Waterbody Type: _____

Sample Type (bottom feeder, predator, etc.) _____ **Species Name:** _____

Composite Sample #: _____ Replicate Number: _____ Number of Individuals: _____

Fish #	Weight (g)	Scales/Otoliths Removed (✓)	Sex (M,F)	Resection Performed (✓)	First Fillet (F1) or Combined Fillets (C)			Second Fillet (F2)		
					Weight (g)	Homogenate Prepared (✓)	Wt. of Homog. for Composite (g)	Weight (g)	Homogenate Prepared (✓)	Wt. of Homog. for Composite (g)
001	_____	_____	_____	_____	_____	_____	_____	_____	_____	_____
002	_____	_____	_____	_____	_____	_____	_____	_____	_____	_____
003	_____	_____	_____	_____	_____	_____	_____	_____	_____	_____
004	_____	_____	_____	_____	_____	_____	_____	_____	_____	_____
005	_____	_____	_____	_____	_____	_____	_____	_____	_____	_____
006	_____	_____	_____	_____	_____	_____	_____	_____	_____	_____
007	_____	_____	_____	_____	_____	_____	_____	_____	_____	_____
008	_____	_____	_____	_____	_____	_____	_____	_____	_____	_____
009	_____	_____	_____	_____	_____	_____	_____	_____	_____	_____
010	_____	_____	_____	_____	_____	_____	_____	_____	_____	_____
Analyst	_____	_____	_____	_____	_____	_____	_____	_____	_____	_____
Date	_____	_____	_____	_____	_____	_____	_____	_____	_____	_____
Total Composite Weight (g)					(F1 or C) _____			(F2) _____		

Notes: _____

Figure 7-2. Sample processing record for fish contaminant monitoring program—fish fillet composites.

scaleless fish, the pectoral fin spines should be clipped and saved (Versar, 1982). The scales, spines, or otoliths may be stored by sealing them in small envelopes (such as coin envelopes) or plastic bags labeled with, and cross-referenced by, the identification number assigned to the tissue specimen (Versar, 1982). Removal of scales, spines, or otoliths from each fish should be noted (by a check mark) on the sample processing record.

7.2.2.4 Sex Determination (Optional)—

Fish sex should be determined before filleting. To determine the sex of a fish, an incision should be made on the ventral surface of the body from a point immediately anterior to the anus toward the head to a point immediately posterior to the pelvic fins. If necessary, a second incision should be made on the left side of the fish from the initial point of the first incision toward the dorsal fin. The resulting flap should be folded back to observe the gonads. Ovaries appear whitish to greenish to golden brown and have a granular texture. Testes appear creamy white and have a smooth texture (Texas Water Commission, 1990). The sex of each fish should be recorded on the sample processing form.

7.2.2.5 Assessment of Morphological Abnormalities (Optional)—

Assessment of gross morphological abnormalities in finfish is optional. This assessment may be conducted in the field (see Section 6.3.1.5) or during initial inspection at the processing laboratory prior to filleting. States interested in documenting morphological abnormalities should consult Sinderman (1983) and review recommended protocols for fish pathology studies used in the Puget Sound Estuary Program (1990c) and those described by Goede and Barton (1990).

7.2.2.6 Scaling or Skinning—

To control contamination, separate sets of utensils and cutting boards should be used for skinning or scaling fish and for filleting fish. Fish with scales should be scaled and any adhering slime removed prior to filleting. Fish without scales (e.g., catfish) should be skinned prior to filleting. These fillet types are recommended because it is believed that they are most representative of the edible portions of fish prepared and consumed by sport anglers. However, it is the responsibility of each program manager, in consultation with state fisheries experts, to select the fillet or sample type most appropriate for each target species based on the dietary customs of local populations of concern.

A fish is scaled by laying it flat on a clean glass or PTFE cutting board or on one that has been covered with heavy duty aluminum foil and removing the scales and adhering slime by scraping from the tail to the head using the blade edge of a clean stainless steel, ceramic, or titanium knife. Cross-contamination is controlled by rinsing the cutting board and knife with contaminant-free distilled water between fish. If an aluminum-foil-covered cutting board is used, the foil should be

changed between fish. The skin should be removed from fish without scales by loosening the skin just behind the gills and pulling it off between knife blade and thumb or with pliers as shown in Figure 7-3.

Once the scales and slime have been scraped off or the skin removed, the outside of the fish should be washed with contaminant-free distilled water and it should be placed on a second clean cutting board for filleting.

7.2.2.7 Filleting—

Filleting should be conducted only by or under the supervision of an experienced fisheries biologist. If gloves are worn, they should be talc- or dust-free, and of noncontaminating materials. Prior to filleting, hands should be washed with Ivory soap and rinsed thoroughly in tap water, followed by distilled water (U.S. EPA, 1991d). Specimens should come into contact with noncontaminating surfaces only. Fish should be filleted on glass or PTFE cutting boards that are cleaned properly between fish or on cutting boards covered with heavy duty aluminum foil that is changed between fish (Puget Sound Estuary Program, 1990d, 1990e). Care must be taken to avoid contaminating fillet tissues with material released from inadvertent puncture of internal organs. **Note:** If the fillet tissue is contaminated by materials released from the inadvertent puncture of the internal organs during resection, the state may eliminate the fillet tissue as a sample or, alternatively, the fillet tissue should be rinsed in contaminant-free, deionized distilled water and blotted dry. Regardless of the procedure selected, a notation should be made in the sample processing record.

Ideally, fish should be filleted while ice crystals are still present in the muscle tissue. Therefore, if fish have been frozen, they should not be allowed to thaw completely prior to filleting. Fish should be thawed only to the point where it becomes possible to make an incision into the flesh (U.S. EPA, 1991d).

Clean, high-quality stainless steel, ceramic, or titanium utensils should be used to remove one or both fillets from each fish, as necessary. The general procedure recommended for filleting fish is illustrated in Figure 7-3 (U.S. EPA, 1991d).

The belly flap should be included in each fillet. Any dark muscle tissue in the vicinity of the lateral line should not be separated from the light muscle tissue that constitutes the rest of the muscle tissue mass. Bones still present in the tissue after filleting should be removed carefully (U.S. EPA, 1991d).

If both fillets are removed from a fish, they can be combined or kept separate for duplicate QC analysis, analysis of different analytes, or archival of one fillet. Fillets should be weighed (either individually or combined, depending on the analytical requirements) and the weight(s) recorded to the nearest gram on the sample processing record.

7. LABORATORY PROCEDURES I — SAMPLE HANDLING

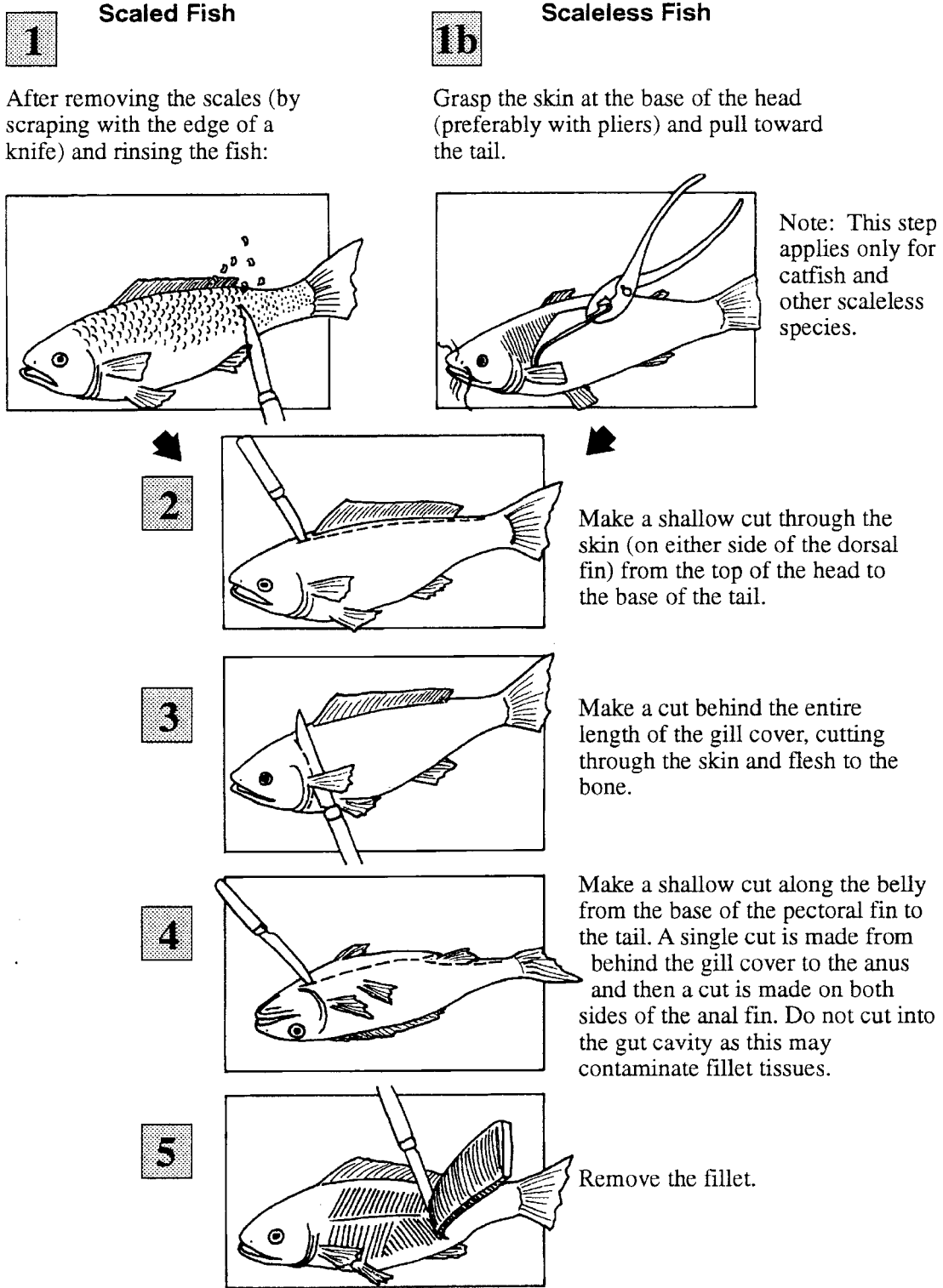

Source: U.S. EPA, 1991d.

Figure 7-3. Illustration of basic fish filleting procedure.

If fillets are to be homogenized immediately, they should be placed in a properly cleaned glass or PTFE homogenization container. If samples are to be analyzed for metals only, plastic homogenization containers may be used. To facilitate homogenization, it may be necessary or desirable to chop each fillet into smaller pieces using a titanium or stainless steel knife prior to placement in the homogenization container.

If fillets are to be homogenized later, they should be wrapped in heavy duty aluminum foil and labeled with the sample identification number, the sample type (e.g., "F" for fillet), the weight (g), and the date of resection. If composite homogenates are to be prepared from only a single fillet from each fish, fillets should be wrapped separately and the designation "F1" and "F2" should be added to the sample identification number for each fillet. The individual fillets from each fish should be kept together. All fillets from a composite sample should be placed in a plastic bag labeled with the composite identification number, the individual sample identification numbers, and the date of resection and stored at ≤ -20 °C until homogenization.

7.2.2.8 Preparation of Individual Homogenates—

To ensure even distribution of contaminants throughout tissue samples and to facilitate extraction and digestion of samples, the fillets from individual fish must be ground and homogenized prior to analysis. The fillets from an individual fish may be ground and homogenized separately or combined, depending on the analytical requirements and the sample size.

Fish fillets should be ground and homogenized using an automatic grinder or high-speed blender or homogenizer. Large fillets may be cut into 2.5-cm cubes with high-quality stainless steel or titanium knives or with a food service band saw prior to homogenization. Parts of the blender or homogenizer used to grind the tissue (i.e., blades, probes) should be made of tantalum or titanium rather than stainless steel. Stainless steel blades and/or probes have been found to be a potential source of nickel and chromium contamination (due to abrasion at high speeds) and should be avoided.

Grinding and homogenization of tissue is easier when it is partially frozen (Stober, 1991). Chilling the grinder/blender briefly with a few chips of dry ice will also help keep the tissue from sticking to it (Smith, 1985).

The fillet sample should be ground until it appears to be homogeneous. The ground sample should then be divided into quarters, opposite quarters mixed together by hand, and the two halves mixed together. The grinding, quartering, and hand-mixing steps should be repeated at least two more times. If chunks of tissue are present at this point, the grinding and homogenization should be repeated. **Note:** Skin-on fillets are the fish fillet sample type recommended for use in state fish contaminant monitoring programs. However, skin-on fillets of some finfish species are especially difficult to homogenize completely. No chunks

of tissue or skin should remain in the sample homogenate because these may not be extracted or digested efficiently and could bias the analytical results. If complete homogenization of skin-on fillets for a particular target species is a chronic problem or if local consumers are likely to prepare skinless fillets of the species, the state should consider analyzing skinless fillet samples. If the sample is to be analyzed for metals only, the ground tissue may be mixed by hand in a polyethylene bag (Stober, 1991). The preparation of each individual homogenate should be noted (marked with a check) on the sample processing record. At this time, individual homogenates may be either processed further to prepare composite homogenates or frozen separately and stored at ≤ -20 °C (see Table 7-1).

7.2.2.9 Preparation of Composite Homogenates—

Composite homogenates should be prepared from equal weights of individual homogenates. The same type of individual homogenate (i.e., either single fillet or combined fillet) should always be used in a given composite sample.

If individual homogenates have been frozen, they should be thawed partially and rehomogenized prior to weighing and compositing. Any associated liquid should be kept as a part of the sample. The weight of each individual homogenate used in the composite homogenate should be recorded, to the nearest gram, on the sample processing record.

Each composite homogenate should be blended as described for individual homogenates in Section 7.2.2.8. The composite homogenate may be processed immediately for analysis or frozen and stored at ≤ -20 °C (see Table 7-1).

The remainder of each individual homogenate should be archived at ≤ -20 °C with the designation "Archive" and the expiration date recorded on the sample label. The location of the archived samples should be indicated on the sample processing record under "Notes."

It is essential that the weights of individual homogenates yield a composite homogenate of adequate size to perform all necessary analyses. Weights of individual homogenates required for a composite homogenate, based on the number of fish per composite and the weight of composite homogenate recommended for analyses of all screening study target analytes (see Table 4-1), are given in Table 7-2. The total composite weight required for intensive studies may be less than that for screening studies if the number of target analytes is reduced significantly.

The recommended sample size of 200 g for screening studies is intended to provide sufficient sample material to (1) analyze for all recommended target analytes (see Table 4-1) at appropriate detection limits; (2) meet minimum QC requirements for the analyses of laboratory duplicate, matrix spike, and matrix spike duplicate samples (see Sections 8.3.3.4 and 8.3.3.5); and (3) allow for

Table 7-2. Weights (g) of Individual Homogenates Required for Screening Study Composite Homogenate Sample^{a,b}

Number of fish per sample	Total composite weight		
	100 g (minimum)	200 g (recommended)	500 g (maximum)
3	33	67	167
4	25	50	125
5	20	40	100
6	17	33	84
7	14	29	72
8	13	25	63
9	11	22	56
10	10	20	50

^a Based on total number of fish per composite and the total composite weight required for analysis in screening studies. The total composite weight required in intensive studies may be less if the number of target analytes is reduced significantly.

^b Individual homogenates may be prepared from one or both fillets from a fish. A composite homogenate should be prepared only from individual homogenates of the same type (i.e., **either** from individual homogenates each prepared from a single fillet **or** from individual homogenates each prepared from both fillets).

reanalysis if the QC control limits are not met or if the sample is lost. However, sample size requirements may vary among laboratories and the analytical methods used. Each program manager must consult with the analytical laboratory supervisor to determine the actual weights of composite homogenates required to analyze for all selected target analytes at appropriate detection limits.

7.2.3 Processing Turtle Samples

Processing in the laboratory to prepare individual turtle homogenate samples for analysis (diagrammed in Figure 7-4) involves

- Inspecting individual turtles
- Weighing individual turtles
- Removing edible tissues
- Determining the sex of each turtle (optional)
- Determining the age of each turtle (optional)
- Weighing edible tissue or tissues
- Homogenizing tissues
- Preparing individual homogenate samples
- Preparing aliquots of the individual homogenates for analysis
- Distributing frozen aliquots to one or more analytical laboratories.

7. LABORATORY PROCEDURES I — SAMPLE HANDLING

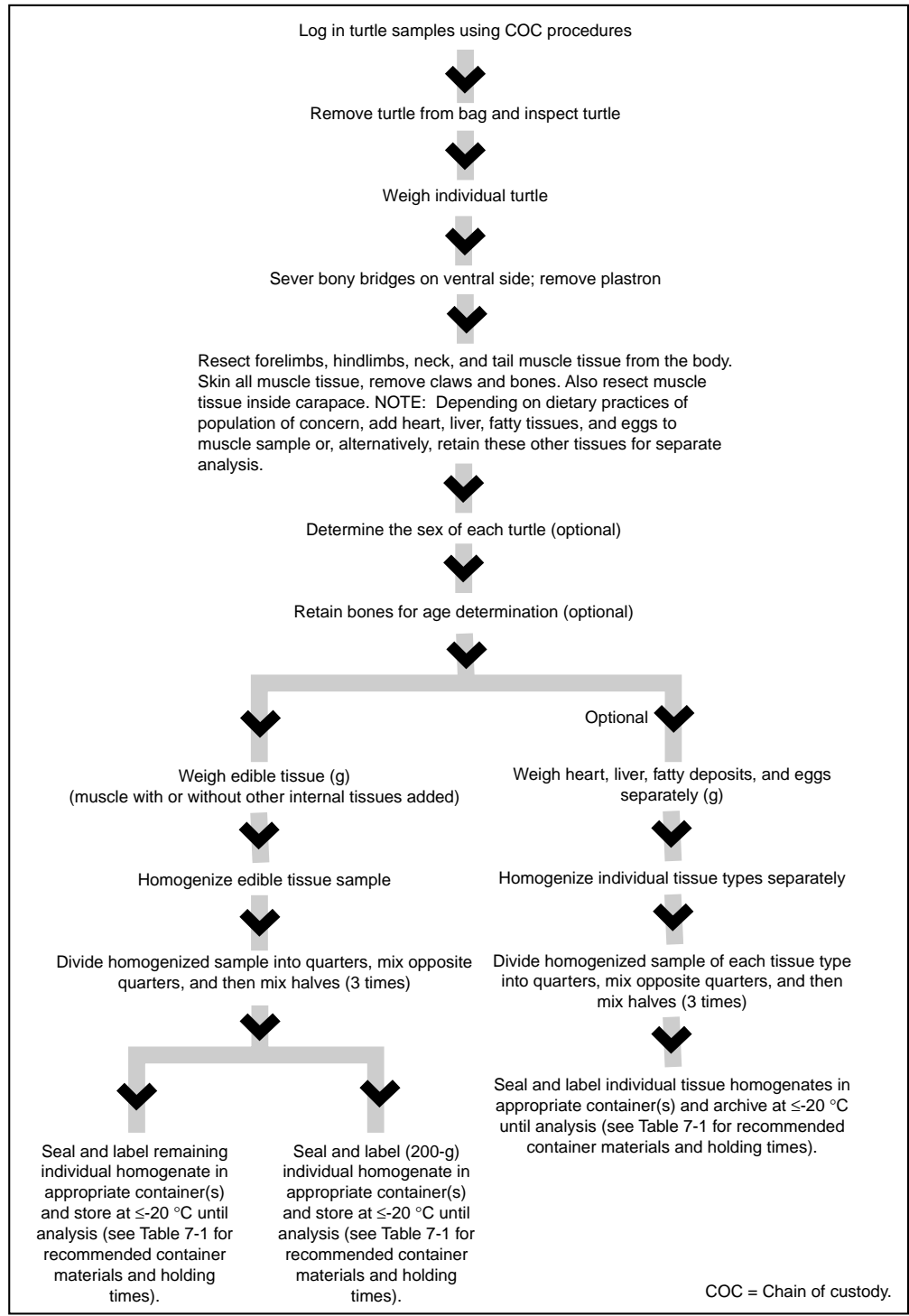

Figure 7-4. Preparation of individual turtle homogenate samples.

Whole turtles should be shipped or brought to the sample processing laboratory from the field on wet or blue ice within 24 hours of sample collection. The recommended euthanizing method for turtles is freezing (Frye, 1994) and a minimum of 48 hours or more may be required for large specimens. Turtles that arrive on wet or blue ice or frozen (i.e., on dry ice) at the sample processing laboratory should be placed in a ≤ -20 °C freezer for storage until resection can be performed. If rupture of internal organs is noted for an individual turtle, the specimen may be eliminated as a sample or, alternatively, the edible tissues should be rinsed in distilled deionized water and blotted dry.

Sample processing procedures are discussed in the following sections. Data from each procedure should be recorded directly in a bound laboratory notebook or on forms that can be secured in the laboratory notebook. A sample processing record for individual turtle samples is shown in Figure 7-5.

7.2.3.1 Sample Inspection—

Turtles received for resection should be removed from the canvas or burlap collection bags and inspected carefully to ensure that they have not been compromised in any way (i.e., not properly preserved during shipment). Any specimen deemed unsuitable for further processing and analysis should be discarded and identified on the sample processing record.

7.2.3.2 Sample Weighing—

A wet weight should be determined for each turtle. All samples should be weighed on balances that are properly calibrated and of adequate accuracy and precision to meet program data quality objectives. Balance calibration should be checked at the beginning and end of each weighing session and after every 20 weighings in a weighing session.

Turtles euthanized by freezing should be weighed in clean, tared, noncontaminating containers if they will thaw before the weighing can be completed. **Note:** Liquid from the thawed whole turtle sample will come not only from the muscle tissue but from the gut and body cavity, which may not be part of the desired edible tissue sample. Consequently, inclusion of this liquid with the sample may result in an overestimate of target analyte and lipid concentrations in the edible tissue homogenate. Nevertheless, it is recommended, as a conservative approach, that all liquid from the thawed whole turtle be kept in the container as part of the sample.

All weights should be recorded to the nearest gram on the sample processing record and/or in the laboratory notebook.

Sample Processing Record for Turtle Contaminant Monitoring Program — Individual Samples

Project Number: _____ Sampling Date and Time: _____

STUDY PHASE: Screening Study ; Intensive Study: Phase I Phase II

SITE LOCATION

Site Name/Number: _____

County/Parish: _____ Lat./Long.: _____

Waterbody Name/Segment Number: _____ Waterbody Type: _____

Sample Type (bottom feeder, predator, etc.) _____ Species Name: _____

Composite Sample #: _____ Replicate Number: _____ Number of Individuals: _____

Turtle #	Weight (g)	Carapace Length (mm)	Sex (M,F)	Resection Performed (✓)	Tissue Type Used	Tissue Weight (g)	Homogenate Prepared (✓)
001	_____	_____	_____	_____	_____	_____	_____
002	_____	_____	_____	_____	_____	_____	_____
003	_____	_____	_____	_____	_____	_____	_____
004	_____	_____	_____	_____	_____	_____	_____
005	_____	_____	_____	_____	_____	_____	_____
006	_____	_____	_____	_____	_____	_____	_____
007	_____	_____	_____	_____	_____	_____	_____
008	_____	_____	_____	_____	_____	_____	_____
009	_____	_____	_____	_____	_____	_____	_____
010	_____	_____	_____	_____	_____	_____	_____
Analyst	_____	_____	_____	_____	_____	_____	_____
Date	_____	_____	_____	_____	_____	_____	_____
Total Composite Weight (g)						_____	

Notes: Define tissues used in edible sample; indicate whether fatty tissues, liver, heart, eggs, or other tissues are being analyzed individually or with muscle tissue as part of the edible sample.

Figure 7-5. Sample processing record for a contaminant monitoring program—individual turtle samples.

7.2.3.3 Removal of Edible Tissues—

Edible portions of a turtle should consist only of those tissues that the population of concern might reasonably be expected to eat. Edible tissues should be clearly defined in site-specific sample processing protocols. A brief description of the edible portions used should also be provided on the sample processing record. General procedures for removing edible tissues from a turtle are illustrated in Appendix K.

Resection should be conducted only by or under the supervision of an experienced fisheries biologist. If gloves are worn, they should be talc- or dust-free and of noncontaminating materials. Prior to resection, hands should be washed with soap and rinsed thoroughly in tap water, followed by distilled water (U.S. EPA, 1991d). Specimens should come into contact with noncontaminating surfaces only. Turtles should be resected on glass or PTFE cutting boards that are cleaned properly between each turtle or on cutting boards covered with heavy duty aluminum foil that is changed between each turtle (Puget Sound Estuary Program, 1990d, 1990e). A turtle is resected by laying it flat on its back and removing the plastron by severing the two bony ridges between the forelimbs and hindlimbs. Care must be taken to avoid contaminating edible tissues with material released from the inadvertent puncture of internal organs.

Ideally, turtles should be resected while ice crystals are still present in the muscle tissue. Thawing of frozen turtles should be kept to a minimum during tissue removal to avoid loss of liquids. A turtle should be thawed only to the point where it becomes possible to make an incision into the flesh (U.S. EPA, 1991d).

Clean, high-quality stainless steel, ceramic, or titanium utensils should be used to remove the muscle tissue and, depending on dietary or culinary practices of the population of concern, some of the other edible tissues from each turtle. The general procedure recommended for resecting turtles is illustrated in Figure 7-6.

Skin on the forelimbs, hindlimbs, neck, and tail should be removed. Claws should be removed from the forelimbs and hindlimbs. Bones still present in the muscle tissue after resection should be removed carefully (U.S. EPA, 1991d) and may be used in age determination (see Section 7.2.3.5).

To control contamination, separate sets of utensils and cutting boards should be used for skinning muscle tissue and resecting other internal tissues from the turtle (e.g., heart, liver, fatty deposits, and eggs). These other tissue types are recommended for inclusion with the muscle tissue as part of the edible tissue sample because it is believed that they are most representative of the edible portions of turtles that are prepared and consumed by sport anglers and subsistence fishers. Alternatively, states may choose to analyze some of these other lipophilic tissues separately. It is the responsibility of each program manager, in consultation with state fisheries experts, to select the tissue sample

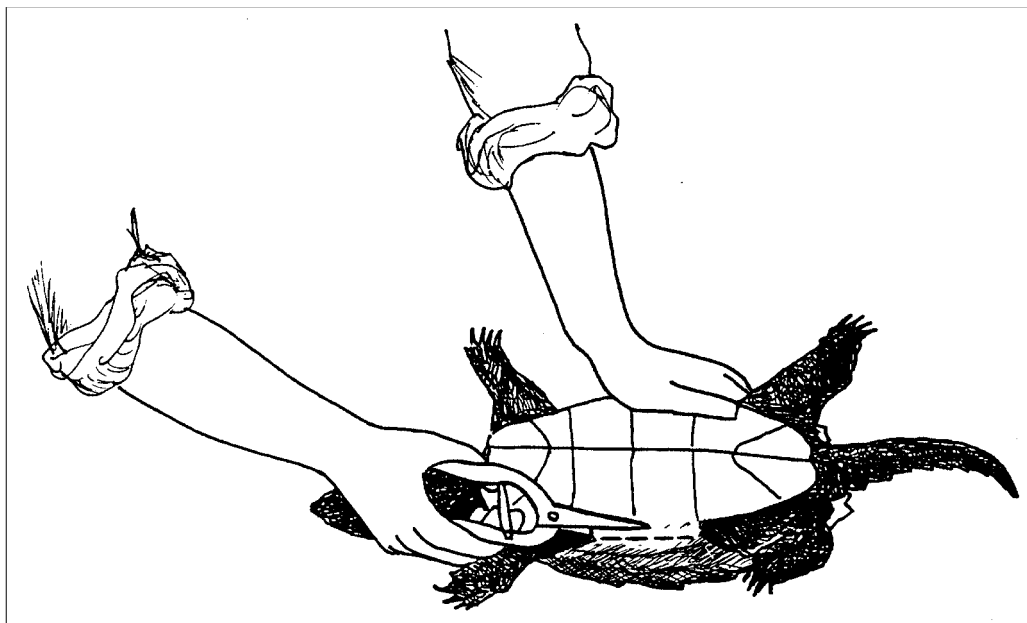

Figure 7-6. Illustration of basic turtle resection procedure.

type most appropriate for each target species based on the dietary customs of local populations of concern.

The edible turtle tissues should be weighed and the weight recorded to the nearest gram on the sample processing record. If the state elects to analyze the heart, liver, fatty deposits, or eggs separately from the muscle tissue, these other tissues should be weighed separately and the weights recorded to the nearest gram in the sample processing record.

If the tissues are to be homogenized immediately, they should be placed in a properly cleaned glass or PTFE homogenization container. If samples are to be analyzed for metals only, plastic homogenization containers may be used. To facilitate homogenization, it may be necessary or desirable to chop each of the large pieces of muscle tissue into smaller pieces using a titanium or stainless steel knife prior to placement in the homogenization container.

If the tissues are to be homogenized later, they should be wrapped in heavy duty aluminum foil and labeled with the sample identification number, the sample type (e.g., "M" for muscle, "E" for eggs, or "FD" for fatty deposits), the weight (g), and the date of resection. The individual muscle tissue samples from each turtle should be packaged together and given an individual sample identification number. The date of resection should be recorded and the sample should be stored at $\leq -20^{\circ}\text{C}$ until homogenization. **Note:** State staff may determine that the most appropriate sample type is muscle tissue only, with internal organ tissues analyzed separately (liver, heart, fatty deposits, or eggs). Alternatively, state staff may determine that the most appropriate sample type is muscle tissue with several other internal organs included as the turtle tissue sample. This latter

sample type typically will provide a more conservative estimate of contaminant residues, particularly with respect to lipophilic target analytes (e.g., PCBs, dioxins, and organochlorine pesticides).

7.2.3.4 Sex Determination (Optional)—

Turtle sex should be determined during resection if it has not already been determined in the field. Once the plastron is removed, the ovaries or testes can be observed posterior and dorsal to the liver. Each ovary is a large egg-filled sac containing yellow spherical eggs in various stages of development (Ashley, 1962) (see Appendix K). Each testes is a spherical organ, yellowish in color, attached to the ventral side of each kidney. The sex of each turtle should be verified and recorded on the sample processing form.

7.2.3.5 Age Determination (Optional)—

Age provides a good indication of the duration of exposure to pollutants (Versar, 1982). Several methods have been developed for estimating the age of turtles (Castanet, 1994; Frazer et al., 1993; Gibbons, 1976). Two methods are appropriate for use in contaminant monitoring programs where small numbers of animals of a particular species are to be collected and where the animals must be sacrificed for tissue residue analysis. These methods include (1) the use of external annuli (scute growth marks) on the plastron and (2) the use of growth rings on the bones.

The surface of epidermal keratinous scutes on the plastron of turtle shells develops successive persistent grooves or growth lines during periods of slow or arrested growth (Zangerl, 1969). Because these growth rings are fairly obvious, they have been used extensively for estimating age in various turtle species (Cagle, 1946, 1948, 1950; Gibbons, 1968; Legler, 1960; Sexton, 1959). This technique is particularly useful for younger turtles where the major growth rings are more definitive and clear cut than in older individuals (Gibbons, 1976). However, a useful extension of the external annuli method is presented by Sexton (1959) showing that age estimates can be made for adults on which all annuli are not visible. This method involves visually examining the plastron of the turtle during the resection or tagging the plastron with the sample identification number of the turtle and retaining it for later analysis.

The use of bone rings is the second method that may be used to estimate age in turtles (Enlow and Brown, 1969; Peabody, 1961). Unlike the previous visual method, this method requires that the bones of the turtle be removed during resection and retained for later analysis. The growth rings appear at the surface or inside primary compacta of bone tissues. There are two primary methods for observing growth marks: either directly at the surface of the bone as in flat bones using transmitted or reflected light or inside the long bones using thin sections (Castanet, 1994; Dobie, 1971; Galbraith and Brooks, 1987; Hammer, 1969; Gibbons, 1976; Mattox, 1935; Peabody, 1961). The methods of preparation of

whole bones and histological sections of fresh material for growth mark determinations are now routinely performed. Details of these methods can be found in Castanet (1974 and 1987), Castanet et al. (1993), and Zug et al. (1986). State staff interested in using either of these methods for age determination of turtles should read the review articles by Castanet (1994) and Gibbons (1976) for discussions of the advantages and disadvantages of each method, and the associated literature cited in these articles on turtle species of particular interest within their jurisdictions.

7.2.3.6 Preparation of Individual Homogenates—

To ensure even distribution of contaminants throughout tissue samples and to facilitate extraction and digestion of samples, the edible tissues from individual turtles must be ground and homogenized prior to analysis. The various tissues from an individual turtle may be ground and homogenized separately, or combined, depending on the sampling program's definition of edible tissues.

Turtle tissues should be ground and homogenized using an automatic grinder or high-speed blender or homogenizer. Large pieces of muscle or organ tissue (e.g., liver or fatty deposits) may be cut into 2.5-cm cubes with high-quality stainless steel or titanium knives or with a food service band saw prior to homogenization. Parts of the blender or homogenizer used to grind the tissue (i.e., blades, probes) should be made of tantalum or titanium rather than stainless steel. Stainless steel blades and/or probes have been found to be a potential source of nickel and chromium contamination (due to abrasion at high speeds) and should be avoided.

Grinding and homogenization of tissue is easier when it is partially frozen (Stober, 1991). Chilling the grinder/blender briefly with a few chips of dry ice will also help keep the tissue from sticking to it (Smith, 1985).

The tissue sample should be ground until it appears to be homogeneous. The ground sample should then be divided into quarters, opposite quarters mixed together by hand, and the two halves mixed together. The grinding, quartering, and hand-mixing steps should be repeated at least two more times. If chunks of tissue are present at this point, the grinding and homogenization should be repeated. No chunks of tissue should remain because these may not be extracted or digested efficiently and could bias the analytical results. This is particularly true when lipophilic tissues (e.g., fatty deposits, liver, or eggs) are not completely homogenized throughout the sample. Portions of the tissue sample that retain unhomogenized portions of tissues may exhibit higher or lower residues of target analytes than properly homogenized samples.

If the sample is to be analyzed for metals only, the ground tissue may be mixed by hand in a polyethylene bag (Stober, 1991). The preparation of each individual homogenate should be noted (marked with a check) on the sample processing record. At this time, individual homogenates may be frozen separately and stored at ≤ -20 °C (see Table 7-1).

The remainder of each individual homogenate should be archived at ≤ -20 °C with the designation "Archive" and the expiration date recorded on the sample label. The location of the archived samples should be indicated on the sample processing record under "Notes."

It is essential that the weight of individual homogenate samples is of adequate size to perform all necessary analyses. The recommended sample size of 200 g for screening studies is intended to provide sufficient sample material to (1) analyze for all recommended target analytes (see Table 4-1) at appropriate detection limits; (2) meet minimum QC requirements for the analyses of laboratory duplicate, matrix spike, and matrix spike duplicate samples (see Sections 8.3.3.4 and 8.3.3.5); and (3) allow for reanalysis if the QC control limits are not met or if the sample is lost. However, sample size requirements may vary among laboratories and the analytical methods used. Each program manager must consult with the analytical laboratory supervisor to determine the actual weights of homogenates required to analyze for all selected target analytes at appropriate detection limits. The total sample weight required for intensive studies may be less than that for screening studies if the number of target analytes is reduced significantly.

7.2.4 Processing Shellfish Samples

Laboratory processing of shellfish to prepare edible tissue composite homogenates for analysis (diagrammed in Figure 7-7) involves

- Inspecting individual shellfish
- Determining the sex of each shellfish (optional)
- Examining each shellfish for morphological abnormalities (optional)
- Removing the edible parts from each shellfish in the composite sample (3 to 50 individuals, depending upon the species)
- Combining the edible parts in an appropriate noncontaminating container
- Weighing the composite sample
- Homogenizing the composite sample
- Preparing aliquots of the composite homogenate for analysis
- Distributing frozen aliquots to one or more analytical laboratories.

Sample aliquotting and shipping are discussed in Section 7.3; all other processing steps are discussed in this section. Shellfish samples should be processed following the general guidelines in Section 7.2.1 to avoid contamination. In

7. LABORATORY PROCEDURES I — SAMPLE HANDLING

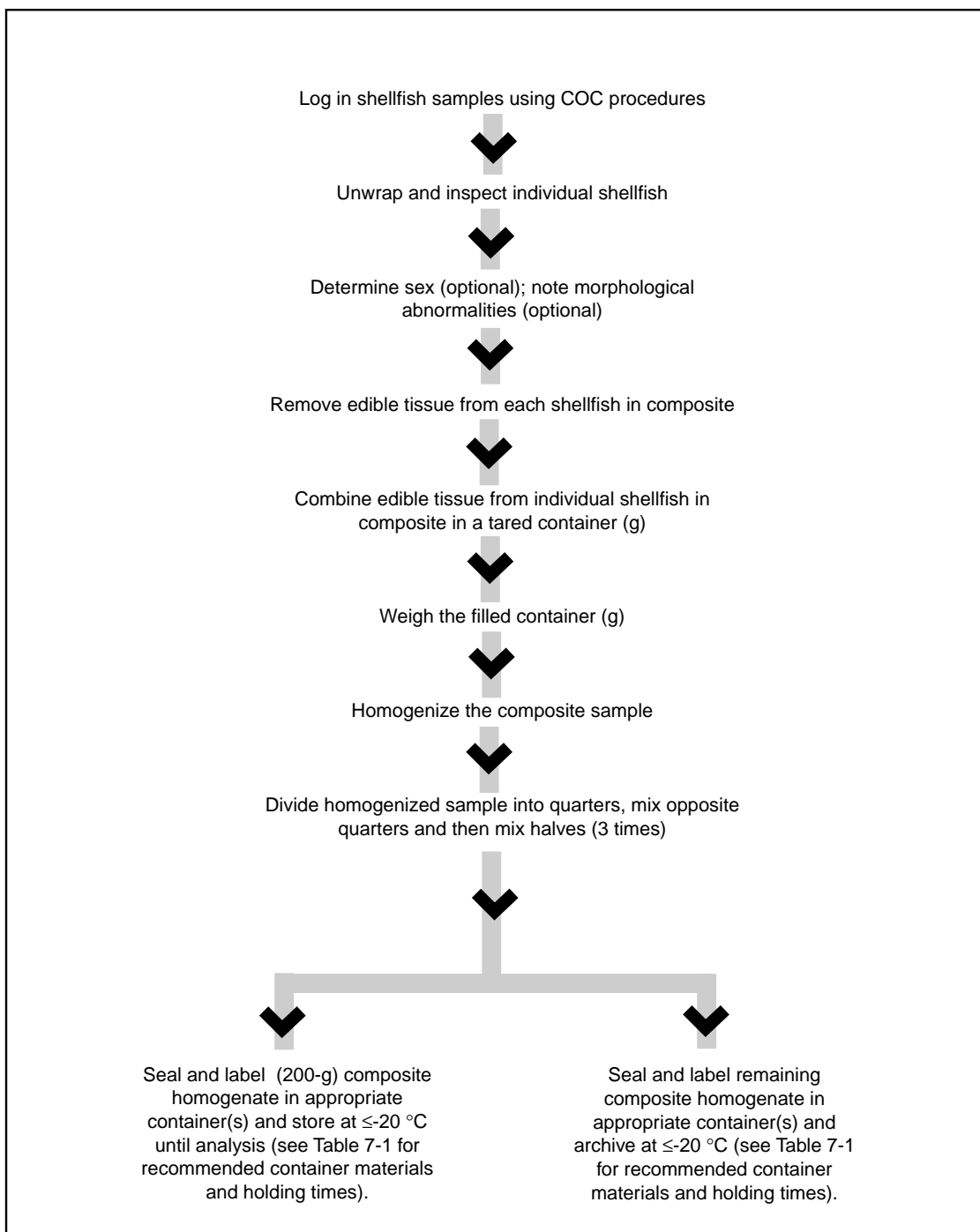

COC = Chain of custody.

Figure 7-7. Preparation of shellfish edible tissue composite homogenate samples.

particular, it is recommended that separate composite homogenates be prepared for the analysis of metals and organics if resources allow. A sample processing record for shellfish edible tissue composite samples is shown in Figure 7-8.

Shellfish samples should be shipped or brought to the sample processing laboratory either on wet or blue ice (if next-day delivery is assured) or on dry ice (see Section 6.3.3). Shellfish samples arriving on wet ice or blue ice should have edible tissue removed and should be frozen to $\leq -20^{\circ}\text{C}$ within 48 hours after collection. Shellfish samples that arrive frozen (i.e., on dry ice) at the processing laboratory should be placed in a $\leq -20^{\circ}\text{C}$ freezer for storage until edible tissue is removed.

7.2.4.1 Sample Inspection—

Individual shellfish should be unwrapped and inspected carefully to ensure that they have not been compromised in any way (i.e., not properly preserved during shipment). Any specimen deemed unsuitable for further processing and analysis should be discarded and identified on the sample processing record.

7.2.4.2 Sex Determination (Optional)—

The determination of sex in shellfish species is impractical if large numbers of individuals of the target species are required for each composite sample.

For bivalves, determination of sex is a time-consuming procedure that must be performed after shucking but prior to removal of the edible tissues. Once the bivalve is shucked, a small amount of gonadal material can be removed using a Pasteur pipette. The gonadal tissue must then be examined under a microscope to identify egg or sperm cells.

For crustaceans, sex also should be determined before removal of the edible tissues. For many species, sex determination can be accomplished by visual inspection. Sexual dimorphism is particularly striking in many species of decapods. In the blue crab, *Callinectes sapidus*, the female has a broad abdomen suited for retaining the maturing egg mass or sponge, while the abdomen of the male is greatly reduced in width. For shrimp, lobsters, and crayfish, sexual variations in the structure of one or more pair of pleopods are common. States interested in determining the sex of shellfish should consult taxonomic keys for specific information on each target species.

7.2.4.3 Assessment of Morphological Abnormalities (Optional)—

Assessment of gross morphological abnormalities in shellfish is optional. This assessment may be conducted in the field (see Section 6.3.1.5) or during initial inspection at the processing laboratory prior to removal of the edible tissues. States interested in documenting morphological abnormalities should consult Sinderman and Rosenfield (1967), Rosen (1970), and Murchelano (1982) for

7. LABORATORY PROCEDURES I — SAMPLE HANDLING

Sample Processing Record for Shellfish Contaminant Monitoring Program — Edible Tissue Composites

Project Number: _____ Sampling Date and Time: _____

STUDY PHASE: Screening Study ; Intensive Study: Phase I Phase II

SITE LOCATION
 Site Name/Number: _____
 County/Parish: _____ Lat./Long.: _____
 Waterbody Name/Segment Number: _____ Waterbody Type: _____

SHELLFISH COLLECTED
 Species Name: _____
 Description of Edible Tissue _____
 Composite Sample #: _____ Number of Individuals: _____

Shellfish #	Included in Composite (✓)	Shellfish #	Included in Composite (✓)	Shellfish #	Included in Composite (✓)
001	_____	018	_____	035	_____
002	_____	019	_____	036	_____
003	_____	020	_____	037	_____
004	_____	021	_____	038	_____
005	_____	022	_____	039	_____
006	_____	023	_____	040	_____
007	_____	024	_____	041	_____
008	_____	025	_____	042	_____
009	_____	026	_____	043	_____
010	_____	027	_____	044	_____
011	_____	028	_____	045	_____
012	_____	029	_____	046	_____
013	_____	030	_____	047	_____
014	_____	031	_____	048	_____
015	_____	032	_____	049	_____
016	_____	033	_____	050	_____
017	_____	034	_____		

Preparation of Composite:
 Weight of container + shellfish _____ g
 Weight of container (tare weight) _____ g
 Total weight of composite _____ g + _____ = _____
of specimens Average weight of specimen

Notes: _____

Analyst _____ Date _____

Figure 7-8. Sample processing record for shellfish contaminant monitoring program—edible tissue composites.

detailed information on various pathological conditions in shellfish and review recommended protocols for pathology studies used in the Puget Sound Estuary Program (1990c).

7.2.4.4 Removal of Edible Tissue—

Edible portions of shellfish should consist only of those tissues that the population of concern might reasonably be expected to eat. Edible tissues should be clearly defined in site-specific sample processing protocols. A brief description of the edible portions used should also be provided on the sample processing record. General procedures for removing edible tissues from a variety of shellfish are illustrated in Appendix L.

Thawing of frozen shellfish samples should be kept to a minimum during tissue removal to avoid loss of liquids. Shellfish should be rinsed well with organics- and metal-free water prior to tissue removal to remove any loose external debris.

Bivalve molluscs (oysters, clams, mussels, and scallops) typically are prepared by severing the adductor muscle, prying open the shell, and removing the soft tissue. The soft tissue includes viscera, meat, and body fluids (Smith, 1985). Byssal threads from mussels should be removed with a knife before shucking and should not be included in the composite sample.

Edible tissue for **crabs** typically includes all leg and claw meat, back shell meat, and body cavity meat. Internal organs generally are removed. Inclusion of the hepatopancreas should be determined by the eating habits of the local population or subpopulations of concern. If the crab is soft-shelled, the entire crab should be used in the sample. Hard- and soft-shelled crabs must not be combined in the same composite (Smith, 1985).

Typically, **shrimp** and **crayfish** are prepared by removing the cephalothorax and then removing the tail meat from the shell. Only the tail meat with the section of intestine passing through the tail muscle is retained for analysis (Smith, 1985). Edible tissue for **lobsters** typically includes the tail and claw meat. If the tomalley (hepatopancreas) and gonads or ovaries are consumed by local populations of concern, these parts should also be removed and analyzed separately (Duston et al., 1990).

7.2.4.5 Sample Weighing—

Edible tissue from all shellfish in a composite sample (3 to 50 individuals) should be placed in an appropriate preweighed and labeled noncontaminating container. The weight of the empty container (tare weight) should be recorded to the nearest gram on the sample processing record. All fluids accumulated during removal of edible tissue should be retained as part of the sample. As the edible portion of each shellfish is placed in the container, it should be noted on the sample processing record. When the edible tissue has been removed from all shellfish

in the composite, the container should be reweighed and the weight recorded to the nearest gram on the sample processing record. The total composite weight should be approximately 200 g for screening studies. If the number of target analytes is significantly reduced in intensive studies, a smaller composite homogenate sample may suffice (see Section 7.2.2.9). At this point, the composite sample may be processed for analysis or frozen and stored at $\leq -20^{\circ}\text{C}$ (see Table 7-1).

7.2.4.6 Preparation of Composite Homogenates—

Composite samples of the edible portions of shellfish should be homogenized in a grinder, blender, or homogenizer that has been cooled briefly with dry ice (Smith, 1985). For metals analysis, tissue may be homogenized in 4-oz polyethylene jars (California Department of Fish and Game, 1990) using a Polytron equipped with a titanium generator. If the tissue is to be analyzed for organics only, or if chromium and nickel contamination are not of concern, a commercial food processor with stainless steel blades and glass container may be used. The composite should be homogenized to a paste-like consistency. Larger samples may be cut into 2.5-cm cubes with high-quality stainless steel or titanium knives before grinding. If samples were frozen after dissection, they can be cut without thawing with either a knife-and-mallet or a clean bandsaw. The ground samples should be divided into quarters, opposite quarters mixed together by hand, and the two halves mixed together. The quartering and mixing should be repeated at least two more times until a homogeneous sample is obtained. No chunks should remain in the sample because these may not be extracted or digested efficiently. At this point, the composite homogenates may be processed for analysis or frozen and stored at $\leq -20^{\circ}\text{C}$ (see Table 7-1).

7.3 SAMPLE DISTRIBUTION

The sample processing laboratory should prepare aliquots of the composite homogenates for analysis, distribute the aliquots to the appropriate laboratory (or laboratories), and archive the remainder of each composite homogenate.

7.3.1 Preparing Sample Aliquots

Note: Because lipid material tends to migrate during freezing, frozen composite homogenates must be thawed and rehomogenized before aliquots are prepared (U.S. EPA, 1991d). Samples may be thawed overnight in an insulated cooler or refrigerator and then homogenized. Recommended aliquot weights and appropriate containers for different types of analyses are shown in Table 7-3. The actual sample size required will depend on the analytical method used and the laboratory performing the analysis. Therefore, the exact sample size required for each type of analysis should be determined in consultation with the analytical laboratory supervisor.

Table 7-3. Recommended Sample Aliquot Weights and Containers for Various Analyses

Analysis	Aliquot weight (g)	Shipping/storage container
Metals	1-5	Polystyrene, borosilicate glass, or PTFE jar with PTFE-lined lid
Organics	20-50	Glass or PTFE jar with PTFE-lined lid
Dioxins/furans	20-50	Glass or PTFE jar with PTFE-lined lid

PTFE = Polytetrafluoroethylene (Teflon).

The exact quantity of tissue required for each digestion or extraction and analysis should be weighed and placed in an appropriate container that has been labeled with the aliquot identification number, sample weight (to the nearest 0.1 g), and the date aliquots were prepared (Stober, 1991). The analytical laboratory can then recover the entire sample, including any liquid from thawing, by rinsing the container directly into the digestion or extraction vessel with the appropriate solvent. It is also the responsibility of the processing laboratory to provide a sufficient number of aliquots for laboratory duplicates, matrix spikes, and matrix spike duplicates so that the QC requirements of the program can be met (see Sections 8.3.3.4 and 8.3.3.5), and to provide extra aliquots to allow for reanalysis if the sample is lost or if QC control limits are not met.

It is essential that accurate records be maintained when aliquots are prepared for analysis. Use of a carefully designed form is recommended to ensure that all the necessary information is recorded. An example of a sample aliquot record is shown in Figure 7-9. The composite sample identification number should be assigned to the composite sample at the time of collection (see Section 6.2.3.1) and carried through sample processing (plus "F1," "F2," or "C" if the composite homogenate is comprised of individual or combined fillets). The aliquot identification number should indicate the analyte class (e.g., MT for metals, OR for organics, DX for dioxins) and the sample type (e.g., R for routine sample; RS or a routine sample that is split for analysis by a second laboratory; MS1 and MS2 for sample pairs, one of which will be prepared as a matrix spike). For example, the aliquot identification number may be WWWW-XX-YY-ZZZ, where WWWW is a 5-digit sample composite identification number, XX indicates individual (F1 or F2) or combined (C) fillets, YY is the analyte code, and ZZZ is the sample type.

Blind laboratory duplicates should be introduced by preparing two separate aliquots of the same composite homogenate and labeling one aliquot with a "dummy" composite sample identification. However, the analyst who prepares the laboratory duplicates must be careful to assign a "dummy" identification number that has not been used for an actual sample and to indicate clearly on the

Fish and Shellfish Monitoring Program Sample Aliquot Record						
Aliquot prepared by _____		(name)		Date _____	Time _____	
Comments _____						
Samples from:						
Project No. _____		Site # _____		<input type="checkbox"/> Screening study	Intensive study	<input type="checkbox"/> Phase I <input type="checkbox"/> Phase II
Composite Sample ID	Analyte Code __ __		Analyte Code __ __		Analyte Code __ __	
	Aliquot ID	Aliquot Weight (g)	Aliquot ID	Aliquot Weight (g)	Aliquot ID	Aliquot Weight (g)
Archive Location:	Analyze for: _____		Analyze for: _____		Analyze for: _____	
	Ship to: _____		Ship to: _____		Ship to: _____	

Figure 7-9. Example of a fish and shellfish monitoring program sample aliquot record.

7-31

7. LABORATORY PROCEDURES I — SAMPLE HANDLING

processing records that the samples are blind laboratory duplicates. The analytical laboratory should not receive this information.

When the appropriate number of aliquots of a composite sample have been prepared for all analyses to be performed on that sample, the remainder of the composite sample should be labeled with "ARCHIVE" and the expiration date and placed in a secure location at ≤ -20 °C in the sample processing laboratory. The location of the archived samples should be indicated on the sample aliquot record. Unless analyses are to be performed immediately by the sample processing laboratory, aliquots for sample analysis should be frozen at ≤ -20 °C before they are transferred or shipped to the appropriate analytical laboratory.

7.3.2 Sample Transfer

The frozen aliquots should be transferred on dry ice to the analytical laboratory (or laboratories) accompanied by a sample transfer record such as the one shown in Figure 7-10. Further details on federal regulations for shipping biological specimens in dry ice are given in Section 6.3.3.2. The sample transfer record may include a section that serves as the analytical laboratory COC record. The COC record must be signed each time the samples change hands for preparation and analysis.

SECTION 8

LABORATORY PROCEDURES II — SAMPLE ANALYSES

Sample analyses may be conducted by one or more state or private contract laboratories. Because of the toxicity of dioxins/furans and the difficulty and cost of these analyses, relatively few laboratories currently have the capability of performing them. Table 8-1 lists contract laboratories experienced in dioxin/furan analyses. This list is provided for information purposes only and is not an endorsement of specific laboratories.

8.1 RECOMMENDED ANALYTES

8.1.1 Target Analytes

All recommended target analytes listed in Table 4-1 should be included in screening studies unless reliable historic tissue, sediment, or pollutant source data indicate that an analyte is not present at a level of concern for human health. Additional target analytes should be included in screening studies if states have site-specific information (e.g., historic tissue or sediment data, discharge monitoring reports from municipal and industrial sources) that these contaminants may be present at levels of concern for human health.

Intensive studies should include only those target analytes found to exceed screening values in screening studies (see Section 5.2).

8.1.2 Lipid

A lipid analysis should also be performed and reported (as percent lipid by wet weight) for each composite tissue sample in both screening and intensive studies. This measurement is necessary to ensure that gel permeation chromatography columns are not overloaded when used to clean up tissue extracts prior to analysis of organic target analytes. In addition, because bioconcentration of nonpolar organic compounds is dependent upon lipid content (i.e., the higher the lipid content of the individual organism, the higher the residue in the organism), lipid analysis is often considered essential by users of fish and shellfish monitoring data. Consequently, it is important that lipid data are obtained for eventual inclusion in a national database of fish and shellfish contaminant data.

8. LABORATORY PROCEDURES II — SAMPLE ANALYSES

Table 8-1. Contract Laboratories Conducting Dioxin/Furan Analyses In Fish and Shellfish Tissues^a

Alta Analytical Laboratory ^b 5070 Robert J. Matthews Parkway, Suite 2 Eldorado Hills, CA 95762 916/933-1640 FAX: 916/933-0940 Bill Luksemburg	Pace Analytical Services ^b 7726 Moller Road Indianapolis, IN 46268 317/875-5894 FAX: 317/872-6189 Mick Mayse
Battelle-Columbus Laboratories ^b 505 King Avenue Columbus, OH 43201 614/424-7379 Karen Riggs	Triangle Laboratories ^b Alston Technical Park 801 Capitola Drive Durham, NC 27713 919/544-5729 FAX: 919/544-5491 Phil Albro
Midwest Research Institute ^b 425 Volker Boulevard Kansas City, MO 64110 816/753-7600, ext. 1160/1557 FAX: 816/753-8240 John Stanley/Tom Sack e-mail: JStanley@mriresearch.org tsack@mriresearch.org	Wellington Environmental Consultants ^b 398 Laird Road Guelph, Ontario N1G 3X7 Canada 519/822-2436 Judy Sparling/Brock Chittin/Colleen Tashiro
New York State Department of Health ^b Wadsworth Center Empire State Plaza P.O. Box 509 Albany, NY 12201-0509 518/473-3378 FAX: 518/473-2895 Patrick O'Keefe	Wright State University ^b 175 Brehm Laboratory 3640 Colonel Glen Highway Dayton, OH 45435 937/775-2202 FAX: 937/775-3122 Thomas Tiernan/Garrett Van Ness
Pacific Analytical, Inc. ^b 6349 Paseo Del Argo Carlsbad, CA 92009 760/438-3100 FAX: 760/931-9479 Bruce Colby	Quanterra Environmental Services Knoxville Laboratory 5815 Middlebrook Pike Knoxville, TN 37921 423/588-6401 FAX: 423/584-4315 David Thal/Tom Yoder
Axys Analytical Services ^b P.O. Box 2219 2045 Mills Road Sidney, BC V8L 3 Canada 250/656-0881; Toll Free 1-888-373-0881 Coreen Hamilton/Dale Hover/Laurie Phillips	

^a This list should not be construed as an endorsement by EPA of these laboratories, but is provided for information purposes only.

^b Laboratory participating in Method 1613 interlaboratory (round-robin) dioxin study (May 1991).

Note: Because the concentrations of contaminants, particularly nonpolar organics, are often correlated with the percentage of lipid in a tissue sample, contaminant data are often normalized to the lipid concentration before statistical analyses are performed. This procedure can, in some instances, improve the power of the statistical tests. States wishing to examine the relationship between contaminant concentrations and percentage of lipid should refer to Hebert and Keenleyside (1995) for a discussion of the possible statistical approaches.

8.2 ANALYTICAL METHODS

This section provides guidance on selecting methods for analysis of recommended target analytes. Analytical methods should include appropriate procedures for sample preparation (i.e., for digestion of samples to be analyzed for metals and for extraction and extract cleanup of samples to be analyzed for organics).

8.2.1 Lipid Method

It is recommended that a gravimetric method be used for lipid analysis. This method is easy to perform and is commonly used by numerous laboratories, employing various solvent systems such as chloroform/methanol (Bligh and Dyer, 1959), petroleum ether (California Department of Fish and Game, 1990; U.S. FDA, 1990), and dichloromethane (NOAA, 1993a; Schmidt et al., 1985). The results of lipid analyses may vary significantly (i.e., by factors of 2 or 3), however, depending on the solvent system used for lipid extraction (Randall et al., 1991; D. Swackhamer, University of Minnesota, personal communication, 1993; D. Murphy, Maryland Department of the Environment, Water Quality Toxics Division, personal communication, 1993). Therefore, to ensure consistency of reported results among fish contaminant monitoring programs, it is recommended that dichloromethane be used as the extraction solvent in all lipid analyses.

In addition to the effect of solvent systems on lipid analysis, other factors can also increase the inter- and intralaboratory variation of results if not adequately controlled (Randall et al., 1991). For example, high temperatures have been found to result in decomposition of lipid material and, therefore, should be avoided during extraction. Underestimation of total lipids can also result from denaturing of lipids by solvent contaminants, lipid decomposition from exposure to oxygen or light, and lipid degradation from changes in pH during cleanup. Overestimation of total lipids may occur if a solvent such as alcohol is used, which results in substantial coextraction of nonlipid material. It is essential that these potential sources of error be considered when conducting and evaluating results of lipid analyses.

8.2.2 Target Analyte Methods

EPA has published interim procedures for sampling and analysis of priority pollutants in fish tissue (U.S. EPA, 1981); however, official EPA-approved methods are available only for the analysis of low parts-per-billion concentrations of some metals in fish and shellfish tissues (U.S. EPA, 1991g). Because of the lack of official EPA-approved methods for all recommended target analytes, and to allow states and Regions flexibility in developing their analytical programs, specific analytical methods for recommended target analytes in fish and shellfish monitoring programs are not included in this guidance document.

Note: A performance-based analytical program is recommended for the analysis of target analytes. This recommendation is based on the assumption that the analytical results produced by different laboratories and/or different methods will be comparable if appropriate QC procedures are implemented within each laboratory and if comparable analytical performance on round-robin comparative analyses of standard reference materials or split sample analyses of field samples can be demonstrated. This approach is intended to allow states to use cost-effective procedures and to encourage the use of new or improved analytical methods without compromising data quality. Performance-based analytical programs currently are used in several fish and shellfish monitoring programs, including the NOAA Status and Trends Program (Battelle, 1989b; Cantillo, 1991; NOAA, 1987), the EPA Environmental Monitoring and Assessment Program (EMAP) (U.S. EPA, 1991e), and the Puget Sound Estuary Program (1990d, 1990e).

Analytical methods used in fish and shellfish contaminant monitoring programs should be selected using the following criteria:

- Technical merit—Methods should be technically sound; they should be specific for the target analytes of concern and based on current, validated analytical techniques that are widely accepted by the scientific community.
- Sensitivity—Method detection and quantitation limits should be sufficiently low to allow reliable quantitation of the target analytes of concern at or below selected screening values. Ideally, the method detection limit (in tissue) should be at least five times lower than the selected SV for a given target analyte (Puget Sound Estuary Program, 1990e).
- Data quality—The accuracy and precision should be adequate to ensure that analytical data are of acceptable quality for program objectives.
- Cost-efficiency—Resource requirements should not be unreasonably high.

A review of current EPA guidance for chemical contaminant monitoring programs and of analytical methods currently used or recommended in several of these programs (as shown in Table 8-2) indicates that a limited number of analytical

Table 8-2. Current References for Analytical Methods for Contaminants in Fish and Shellfish Tissues

-
-
- Analytical Chemistry of PCBs (Erickson, 1991)
 - Analytical Methods for Pesticides and Plant Growth Regulators, Vol. 11 (Zweig and Sherma, 1980)
 - Analytical Procedures and Quality Assurance Plan for the Determination of Mercury in Fish (U.S. EPA, 1989a)
 - Analytical Procedures and Quality Assurance Plan for the Determination of Xenobiotic Chemical Contaminants in Fish (U.S. EPA, 1989c)
 - Analytical Procedures and Quality Assurance Plan for the Determination of PCDD/PCDF in Fish (U.S. EPA, 1989b)
 - Arsenic Speciation by Coupling High-Performance Liquid Chromatography with Inductively Coupled Plasma Mass Spectrometry (Demesmay et al., 1994)
 - Assessment and Control of Bioconcentratable Contaminants in Surface Water (U.S. EPA, 1991a).
 - Bioaccumulation Monitoring Guidance: 4. Analytical Methods for U.S. EPA Priority Pollutants and 301(h) Pesticides in Tissues from Marine and Estuarine Organisms (U.S. EPA, 1986a)
 - Determination of Arsenic Species by High-Performance Liquid Chromatography - Inductively Coupled Plasma Mass Spectrometry (Beauchemin et al., 1989)
 - Determination of Arsenic Species in Fish by Directly Coupled High-Performance Liquid Chromatography-Inductively Coupled Plasma Mass Spectrometry (Branch et al., 1994)
 - The quantitation of butyltin and cyclohexyltin compounds in the marine environment of British Columbia. *Appl. Organometal. Chem.* 4:581-590 (Cullen et al., 1990)
 - Determination of Butyltin, Methyltin and Tetraalkyltin in Marine Food Products with Gas Chromatography-Atomic Absorption Spectrometry (Forsyth and Cleroux, 1991)
 - Determination of Tributyltin Contamination in Tissues by Capillary Column Gas Chromatography-Flame Photometric Detection with Confirmation by Gas Chromatography-Mass Spectroscopy (Wade et al., 1988)
 - Determination of Tributyltin in Tissues and Sediments by Graphite Furnace Atomic Absorption Spectrometry (Stephenson and Smith, 1988)
 - Environmental Monitoring and Assessment Program Near Coastal Virginian Province Quality Assurance Project Plan (Draft) (U.S. EPA, 1991e)
 - Guidelines for Studies of Contaminants in Biological Tissues for the National Water-Quality Assessment Program (Crawford and Luoma, 1993)
 - Interim Methods for the Sampling and Analysis of Priority Pollutants in Sediments and Fish Tissue (U.S. EPA, 1981)
 - Laboratory Quality Assurance Program Plan (California Department of Fish and Game, 1990)
 - Methods for Organic Analysis of Municipal and Industrial Wastewater (40 CFR 136, Appendix A).
 - Methods for the Chemical Analysis of Water and Wastes (U.S. EPA, 1979b)
 - Methods for the Determination of Metals in Environmental Samples (U.S. EPA, 1991g)
 - Official Methods of Analysis of the Association of Official Analytical Chemists (Williams, 1984)
 - Pesticide Analytical Manual (PAM Vols. I and II) (U.S. FDA, 1990)
 - Puget Sound Estuary Program Plan (1990d, 1990e)
 - Quality Assurance/Quality Control (QA/QC) for 301(h) Monitoring Programs: Guidance on Field and Laboratory Methods (U.S. EPA, 1987e)
-

(continued)

8. LABORATORY PROCEDURES II — SAMPLE ANALYSES

Table 8-2 (continued)

-
-
- Sampling and Analytical Methods of the National Status and Trends Program National Benthic Surveillance and Mussel Watch Projects 1984-92. Volume II. Comprehensive Descriptions of Complementary Measurements (NOAA, 1993a)
 - Sampling and Analytical Methods of the National Status and Trends Program National Benthic Surveillance and Mussel Watch Projects 1984-92. Volume III. Comprehensive Descriptions of Elemental Analytical Methods (NOAA, 1993b)
 - Sampling and Analytical Methods of the National Status and Trends Program National Benthic Surveillance and Mussel Watch Projects 1984-92. Volume IV. Comprehensive Descriptions of Trace Organic Analytical Methods (NOAA, 1993c)
 - Separation of Seven Arsenic Compounds by High-performance Liquid Chromatography with On-line Detection by Hydrogen-Argon Flame Atomic Absorption Spectrometry and Inductively Coupled Plasma Mass Spectrometry (Hansen et al., 1992)
 - Speciation of Selenium and Arsenic in Natural Waters and Sediments by Hydride Generation Followed by Atomic Absorption Spectroscopy (Crecelius et al., 1986)
 - Standard Analytical Procedures of the NOAA National Analytical Facility (Krahn et al., 1988; MacLeod et al., 1985)
 - Standard Methods for the Examination of Water and Wastewater (Greenburg et al., 1992)
 - Test Methods for the Chemical Analysis of Municipal and Industrial Wastewater (U.S. EPA, 1982)
 - Test Methods for the Evaluation of Solid Waste, Physical/Chemical Methods (SW-846) (U.S. EPA, 1986d)
 - U.S. EPA Contract Laboratory Program Statement of Work for Inorganic Analysis (U.S. EPA, 1991b)
 - U.S. EPA Contract Laboratory Program Statement of Work for Organic Analysis (U.S. EPA, 1991c)
 - U.S. EPA Method 1613B: Tetra- through Octa-Chlorinated Dioxins and Furans by Isotope Dilution HRGC/HRMS (U.S. EPA, 1995b)
 - U.S. EPA Method 1625: Semivolatile Organic Compounds by Isotope Dilution GC/MS (40 CFR 136, Appendix A)
 - U.S. EPA Method 1631: Mercury in Water by Oxidation, Purge and Trap, and Cold Vapor Atomic Fluorescence Spectrometry (U.S. EPA, 1995c)
 - U.S. EPA Method 1632: Determination of Inorganic Arsenic in Water by Hydride Generation Flame Atomic Absorption (U.S. EPA, 1995d)
 - U.S. EPA Method 1637: Determination of Trace Elements in Ambient Waters by Chelation Preconcentration with Graphite Furnace Atomic Absorption (U.S. EPA, 1995e)
 - U.S. EPA Method 1638: Determination of Trace Elements in Ambient Waters by Inductively Coupled Plasma-Mass Spectrometry (U.S. EPA, 1995f)
 - U.S. EPA Method 1639: Determination of Trace Elements in Ambient Waters by Stabilized Temperature Graphite Furnace Atomic Absorption (U.S. EPA, 1995g)
 - U.S. EPA Method 625: Base/Neutrals and Acids by GC/MS (40 CFR 136, Appendix A).
 - U.S. EPA Method 8290: Polychlorinated Dibenzodioxins (PCDDs) and Polychlorinated Dibenzofurans (PCDFs) by High Resolution Gas Chromatography/High Resolution Mass Spectrometry (HRGC/HRMS) (U.S. EPA, 1990b)
 - U.S. EPA Method 1668: Draft Method 1668 Toxic Polychlorinated Biphenols by Isotope Dilution High Gas Chromatography/High Resolution Mass Spectrometry (U.S. EPA, 1997a)
-
-

8. LABORATORY PROCEDURES II — SAMPLE ANALYSES

techniques are most commonly used for the determination of the recommended target analytes. These techniques are listed in Table 8-3. As shown in Table 8-4, analytical methods employing these techniques have typically achievable detection and/or quantitation limits that are well below the recommended SVs for most target analytes, with the possible exception of dieldrin, heptachlor epoxide, toxaphene, PCBs, and dioxins/furans. Recommended procedures for determining method detection and quantitation limits are given in Section 8.3.3.3.

If lower SVs are used in a study (e.g., for susceptible populations), it is the responsibility of program managers to ensure that the detection and quantitation limits of the analytical methods are sufficiently low to allow reliable quantitation of target analytes at or below these SVs. If analytical methodology is not sensitive enough to reliably quantitate target analytes at or below selected SVs (e.g., dieldrin, heptachlor epoxide, toxaphene, PCBs, dioxins/furans), program managers must determine appropriate fish consumption guidance based on lowest detectable concentrations or provide justification for adjusting SVs to values at or above achievable method detection limits. It should be emphasized that when SVs are below detection limits, the failure to detect a target analyte cannot be assumed to mean that there is no cause for concern for human health effects.

The analytical techniques identified in Table 8-3 are recommended for use in state fish and shellfish contaminant monitoring programs. However, alternative techniques may be used if acceptable detection limits, accuracy, and precision can be demonstrated. **Note:** Neither rotenone, the most widely used piscicide in the United States, nor its biotransformation products (e.g., rotenolone, 6',7'-dihydro-6',7'-dihydroxyrotenone, 6',7'-dihydro-6',7'-dihydroxyrotenolone) would be expected to interfere with the analyses of organic target analytes using the recommended gas chromatographic methods of analysis. Furthermore, rotenone has a relatively short half-life in water (3.7, 1.3, and 5.2 days for spring, summer, and fall treatments, respectively) (Dawson et al., 1991) and does not bioaccumulate significantly in fish (bioconcentration factor= 26 in fish carcass) (Gingerich and Rach, 1985), so that tissue residues should not be significant.

Laboratories should select analytical methods for routine analyses of target analytes that are most appropriate for their programs based on available resources, experience, program objectives, and data quality requirements. A recent evaluation of current methods for the analyses of organic and trace metal target analytes in fish tissue provides useful guidance on method selection, validation, and data reporting procedures (Capuzzo et al., 1990).

The references in Table 8-2 should be consulted in selecting appropriate analytical methods. **Note:** Because many laboratories may have limited experience in determining inorganic arsenic, a widely accepted method for this analysis is included in Appendix H.

8. LABORATORY PROCEDURES II — SAMPLE ANALYSES

Table 8-3. Recommended Analytical Techniques for Target Analytes

Target analyte	Analytical technique
Metals	
Arsenic (inorganic)	HAA, or HPLC with ICP-MS
Cadmium	GFAA or ICP ^a
Mercury	CVAA
Selenium	GFAA, ICP, or HAA ^{a,b}
Tributyltin	GFAA or GC/FPD ^c
Organics	
PAHs	GC/MS or HRGC/HRMS ^d
PCBs	
Total Aroclors	GC/ECD ^{e,f,g,h}
Non-ortho coplanar PCBs	HRGC/HRMS ⁱ
Other congeners/homologs	HRGC/LRMS
Organochlorine pesticides	GC/ECD ^{f,g}
Organophosphate pesticides	GC/MS, GC/FPD, or GC/NPD ^j
Chlorophenoxy herbicides	GC/ECD ^{f,g}
Dioxins/dibenzofurans	HRGC/HRMS ^{k,l}

CVAA	= Cold vapor atomic absorption spectrophotometry.
GC/ECD	= Gas chromatography/electron capture detection.
GC/FPD	= Gas chromatography/flame photometric detection.
GC/MS	= Gas chromatography/mass spectrometry.
GC/NPD	= Gas chromatography/nitrogen-phosphorus detection.
GFAA	= Graphite furnace atomic absorption spectrophotometry.
HAA	= Hydride generation atomic absorption spectrophotometry.
HPLC	= High-performance liquid chromatography.
HRGC/HRMS	= High-resolution gas chromatography/high-resolution mass spectrometry.
ICP	= Inductively coupled plasma emission spectrometry.
ICP-MS	= Inductively coupled plasma mass spectrometry.
LRMS	= Low resolution mass spectrometry.
PAHs	= Polycyclic aromatic hydrocarbons.
PCBs	= Polychlorinated biphenyls.

^a Atomic absorption methods require a separate determination for each element, which increases the time and cost relative to the broad-scan ICP method. However, GFAA detection limits are typically more than an order of magnitude lower than those achieved with ICP.

^b Use of HAA can lower detection limits for selenium by a factor of 10-100 (Crecelius, 1978; Skoog, 1985).

^c GC/FPD is specific for tributyltin and the most widely accepted analytical method. GFAA is less expensive (see Table 8-5) but is not specific for tributyltin. Depending on the extraction scheme, mono-, di-, and tetrabutyltin and other alkyltins may be included in the analysis. Contamination of samples with tin may also be a potential problem, resulting in false positives (E. Crecelius, Battelle Pacific Northwest Laboratories, Marine Sciences Laboratory, Sequim, WA, personal communication, 1999).

^d GC/MS is also recommended for base/neutral organic target analytes (except organochlorine pesticides and PCBs) that may be included in a study. Detection limits of less than 1 ppb can be achieved for PAHs using HRGC/HRMS. It is recommended that, in both screening and intensive studies, tissue samples be analyzed for benzo[a]pyrene and 14 other PAHs and that the relative potencies given for these PAHs (Nesbit and LaGoy, 1992; U.S. EPA, 1993c) be used to calculate PEC for each sample for comparison with the recommended SV for benzo[a]pyrene (see Section 5.3.2.4).

^e Analysis of total PCBs, as the sum of PCB congeners or sum of Aroclors, is recommended for conducting human health risk assessments for PCBs. A standard method for Aroclor analyses is available (EPA Method 608). EPA is currently testing a draft method (1668) for PCB congener analysis; however, it has not been finalized.

(continued)

8. LABORATORY PROCEDURES II — SAMPLE ANALYSES

Table 8-3 (continued)

- ^f GC/ECD does not provide definitive compound identification, and false positives due to interferences are commonly reported. Confirmation by an alternative GC column phase (with ECD), or by GC/MS with selected ion monitoring, is required for positive identification of PCBs, organochlorine pesticides, and chlorophenoxy herbicides.
- ^g GC/MS with selected ion monitoring may be used for quantitative analyses of these compounds if acceptable detection limits can be achieved.
- ^h PCB congener analysis using capillary GC columns is recommended (NOAA, 1989b; Dunn et al., 1984; Schwartz et al., 1984; Mullin et al., 1984; Stalling et al., 1987). An enrichment step, employing an activated carbon column, may also be required to separate and quantify coeluting congeners or congeners present at very low concentrations (Smith, 1981; Schwartz et al., 1993).
- ⁱ Includes PCBs -77, -81, -126 and -169.
- ^j Some of the chlorinated organophosphate pesticides (e.g., chlorpyrifos) may be analyzed by GC/ECD (USGS, 1987).
- ^k The analysis of the 1,2,3,7,8-substituted congeners of tetra- through octa-chlorinated dibenzo-*p*-dioxins (PCDDs) and dibenzofurans (PCDFs) using isotope dilution is recommended.
- ^l Because of the toxicity of dioxins/furans and the difficulty and cost of these analyses, relatively few laboratories currently have the capability of performing these analyses. Contract laboratories experienced in conducting dioxin/furan analyses are listed in Table 8-1.

8. LABORATORY PROCEDURES II — SAMPLE ANALYSES

Table 8-4. Range of Detection and Quantitation Limits of Current Analytical Methods for Recommended Target Analytes^a

Target analyte	Recreational SV	Subsistence SV ^b	Range of detection limits	Range of quantitation limits
Metals				
Arsenic (inorganic)	26 ppb	3.27 ppb	5-50 ppb ^c ; 50-100 ppb ^d	5-25 ppb
Cadmium	4,000 ppb	491 ppb	5-46 ppb ^e , 400 ppb ^f	5-500 ppb
Mercury	400 ppb	49 ppb	1.3-100 ppb ^g	2-10 ppb
Selenium	20,000 ppb	2,457 ppb	17-150 ppb ^c ; 20 ppb ^h , 600 ppb ^f	20-600 ppb
Tributyltin	1,200 ppb	147 ppb	2.5 ppb ^e ; 2-5 ppb ⁱ	2-10 ppb
Organochlorine Pesticides^j				
Chlordane (total)	—	—		
<i>cis</i> -Chlordane	114 ppb	14 ppb	1-5 ppb	2-20 ppb ^{j,k}
<i>trans</i> -Chlordane			1-5 ppb	2-15 ppb
<i>cis</i> -Nonachlor			1-5 ppb	2-15 ppb
<i>trans</i> -Nonachlor			1-7 ppb	2-15 ppb
Oxychlordane			1-5 ppb	2-15 ppb
DDT (total)	117 ppb	14.4 ppb		
4,4'-DDT			0.1-13 ppb	2-20 ppb
2,4'-DDT			0.1-10 ppb	2-15 ppb
4,4'-DDD			0.1-10 ppb	2-15 ppb
2,4'-DDD			0.1-10 ppb	2-15 ppb
4,4'-DDE			0.1-38 ppb	2-15 ppb ^{j,k}
2,4'-DDE			0.1-10 ppb	2-15 ppb
Dicofol	1,600 ppb	196 ppb	1-5 ppb	2-10 ppb
Dieldrin	2.50 ppb	0.307 ppb	0.1-5 ppb	2-15 ppb
Endosulfan (total)	24,000 ppb	2,949 ppb	5-70 ppb	10-70 ppb
Endosulfan I			5-10 ppb	2-15 ppb
Endosulfan II			5-70 ppb	10-70 ppb
Endrin	1,200 ppb	147 ppb	0.1-15 ppb	2-15 ppb ^{j,k}
Heptachlor epoxide	4.39 ppb	0.54 ppb	0.1-5 ppb	2-15 ppb ^{j,k}
Hexachlorobenzene	25 ppb	3.07 ppb	0.1-2 ppb	2-15 ppb ^{j,k}
Lindane	30 ppb	3.78 ppb	0.1-5 ppb	2-15 ppb ^{j,k}
Mirex	800 ppb	98 ppb	0.1-5 ppb	2-15 ppb ^{j,k}
Toxaphene	36 ppb	4.46 ppb	3-100 ppb	60-153 ppb
Organophosphate Pesticides^j				
Chlorpyrifos	18,000 ppb	147 ppb	2-5 ppb	2-15 ppb ^k
Diazinon	4,200 ppb	344 ppb	2-5 ppb	2-15 ppb
Disulfoton	240 ppb	19 ppb	2-5 ppb	2-15 ppb
Ethion	3,000 ppb	245 ppb	2-5 ppb	2-15 ppb
Terbufos	120 ppb	9 ppb	2-5 ppb	2-15 ppb
Chlorophenoxy Herbicides				
Oxyfluorfen	546 ppb	679 ppb	10-20 ppb	20-200 ppb
PAHs^l				
	5.47 ppb	0.67 ppb	1-10 ppt	2-20 ppt
PCBs total				
(sum of Aroclors) ^j	20 ppb	2.45 ppb	—	—
Non-ortho coplanar PCBs ^k			(20-62 ppb) ^m	(110-170 ppb) ^m
Other congeners/ homologues ⁿ			2-5 ppt	2-10 ppt
			2-5 ppb	10 ppb
Dioxins/furans^k (total)				
	0.256 ppt	0.031 ppt	1.0 ppt	5-10 ppt
TCDD/TCDF			0.1 ppt	0.5 ppt
PeCDD/PeCDF			0.5 ppt	2.5 ppt
HxCDD/HxCDF			0.5 ppt	2.5 ppt
HpCDD/HpCDF			0.5 ppt	2.5 ppt
OCDD/OCDF			1.0 ppt	5 ppt

PAHs = Polycyclic aromatic hydrocarbons. PCBs = Polychlorinated biphenyls. SV = Screening value (wet weight).

(continued)

8. LABORATORY PROCEDURES II — SAMPLE ANALYSES

Table 8-4. (continued)

- ^a Target analyte concentrations are given based on wet weight of fish tissue.
- ^b From Tables 5-2 and 5-3. SVs shown here are for fish consumers using RfDs or CSFs available in the EPA IRIS (1999) database and assuming a consumption rate (CR) for recreational fishers of 12 g/d and for subsistence fishers of 124 g/d, average adult body weight (BW) = 72 kg, lifetime (70-yr) exposure, and, for carcinogens, a risk level (RL) = 10^{-5} . **Note:** Increasing CR, decreasing BW, and/or using an RL $<10^{-5}$ will decrease the SV. Program managers must ensure that detection and quantitation limits of analytical methods are sufficient to allow reliable quantitation of target analytes at or below selected SVs. If analytical methodology is not sensitive enough to reliably quantitate target analytes at or below selected SVs (e.g., inorganic arsenic, dieldrin, heptachlor epoxide, toxaphene, PCBs, dioxins/furans), the program managers must determine appropriate fish consumption guidance based on lowest detectable concentrations or provide justification for adjusting SVs to values at or above achievable method detection or quantitation limits. It should be emphasized that when SVs are below method detection limits, the failure to detect a target analyte cannot be assumed to indicate that there is no cause for concern for human health effects.
- ^c Analysis by hydride generation atomic absorption spectrophotometry (HAA) with preconcentration (E. Crecelius, Battelle Pacific Northwest Laboratories, Marine Sciences Laboratory, Sequim, WA, personal communication, July 1999).
- ^d Analysis by high-performance liquid chromatography/mass spectrometry (HPLC/MS) (E. Crecelius, Battelle Pacific Northwest Laboratories, Marine Sciences Laboratory, Sequim, WA, personal communication, July 1999).
- ^e Analysis by graphite furnace atomic absorption spectrophotometry (GFAA). **Note:** This method is not specific for tributyltin. Depending on the extraction procedure, mono-, di-, and tetrabutyltin may also be included in the analysis. Also, this method does not distinguish between butyltins and other alkyltins (E. Crecelius, Battelle Pacific Northwest Laboratories, Marine Sciences Laboratory, Sequim, WA, personal communication, July 1999).
- ^f Analysis by inductively coupled plasma atomic emission spectrophotometry (ICP).
- ^g Analysis by cold vapor atomic absorption spectrophotometry (CVAA).
- ^h Analysis by HAA.
- ⁱ Analysis by gas chromatography/flame photometric detection (GC/FPD) (E. Crecelius, Battelle Pacific Northwest Laboratories, Marine Sciences Laboratory, Sequim, WA, personal communication, July 1999).
- ^j Analysis by gas chromatography/electron capture detection (GC/ECD), except where otherwise noted.
- ^k Analysis by high-resolution GC/high-resolution mass spectrometry (HRGC/HRMS).
- ^l Analysis by gas chromatography/mass spectrometry. Detection limits of less than 1 ppb can be achieved using high-resolution gas chromatography/mass spectrometry (HRGC/HRMS).
- ^m Values in parentheses represent ranges for individual Aroclors.
- ⁿ Analysis by high-resolution GC/low resolution mass spectrometry (HRGC/LRMS).

An additional resource for method selection is the EPA Environmental Monitoring Methods Index System (EMMI), an automated inventory of information on environmentally significant analytes and methods for their analysis (U.S. EPA, 1991f). The EMMI database includes information on more than 4,000 analytes from over 80 regulatory and nonregulatory lists and more than 900 analytical methods in a variety of matrices, including tissue. This searchable database provides a comprehensive cross-reference between analytes and analytical methods with detailed information on each analytical method, including sponsoring organization, sample matrix, and estimates of detection limits, accuracy, and precision.

EMMI is available from the EPA Sample Control Center for all EPA personnel and from National Technical Information Service (NTIS) for all other parties. EMMI is also available through the EPA Local Area Network (LAN).

The private sector may purchase EMMI Version 2.0 through the:

National Technical Information Service (NTIS)
5285 Port Royal Road
Springfield, VA 22161
USA
Phone: (703) 605-6000
Fax: (703) 605-6900
Rush Orders: (800) 553-NTIS
Online Orders: <http://www.ntis.gov>

The order number is PB97-5026371NC for a single user, PB97-5026451NC for a five-user LAN package, and PB97-5026521NC for an unlimited user LAN package. Further information may be obtained by contacting:

EMMI User Support
Tech Calls
EPA Assistant Administrator for Water
Office of Science and Technology
(703) 461-2104
Alexandria, VA 22313

Because chemical analysis is frequently one of the most expensive components of a sampling and analysis program, the selection of an analytical method often will be influenced by its cost. In general, analytical costs increase with increased sensitivity (i.e., lower detection limits) and reliability (i.e., accuracy and precision). Analytical costs will also be dependent on the number of samples to be analyzed, the requested turnaround time, the number and type of analytes requested, the level of QC effort, and the amount of support documentation requested (Puget Sound Estuary Program, 1990d). However, differences in protocols, laboratory experience, and pricing policies of laboratories often introduce large variation into analytical costs. Approximate costs per sample for the analysis of target analytes by the recommended analytical techniques are provided in Table 8-5.

8.3 QUALITY ASSURANCE AND QUALITY CONTROL CONSIDERATIONS

Quality assurance and quality control must be integral parts of each chemical analysis program. The QA process consists of management review and oversight at the planning, implementation, and completion stages of the analytical data collection activity to ensure that data provided are of the quality required. The QC process includes those activities required during data collection to produce the data quality desired and to document the quality of the collected data.

During the planning of a chemical analysis program, QA activities focus on defining data quality criteria and designing a QC system to measure the quality of data being generated. During the implementation of the data collection effort, QA activities ensure that the QC system is functioning effectively and that the

8. LABORATORY PROCEDURES II — SAMPLE ANALYSES

Table 8-5. Approximate Range of Costs per Sample for Analysis of Recommended Target Analytes^a

Target analyte	Approximate cost range (1999 \$)
Metals^b	
Arsenic (inorganic) ^c	200 - 400
Cadmium	55 - 60
Mercury (total)	45 - 60
Selenium	35 - 60
Tributyltin ^d	200 - 400
Organochlorine pesticides^{e,f}	285 - 500
Organophosphate pesticides^g	250 - 500
Chlorophenoxy herbicides^h	250 - 500
PAHsⁱ	250 - 525
PCBs	
Total Aroclors ^e	210 - 500
Non-ortho coplanar PCBs ^j	1,000 - 2,000
Other congeners/homologs ^k	800 - 1,000
Dioxins/furans^l	
TCDD/TCDF only	600 - 1,000
TCDD/TCDF through OCDD/OCDF isomers	800 - 1,600
2,3,7,8-substituted dioxins/furans	1,000 - 2,000
Lipid	30 - 40

OCDD = Octachlorodibenzo-*p*-dioxin.

OCDF = Octachlorodibenzofuran.

PAHs = Polycyclic aromatic hydrocarbons.

PCBs = Polychlorinated biphenyls.

TCDD = 2,3,7,8-Tetrachlorodibenzo-*p*-dioxin.

TCDF = 2,3,7,8-Tetrachlorodibenzofuran.

^a These costs include sample digestion or extraction and cleanup, but not sample preparation (i.e., resection, grinding, homogenization, compositing). Estimated cost of sample preparation for a composite homogenate of five fish is \$200 to \$500.

^b Analysis of inorganic arsenic by hydride generation atomic absorption spectroscopy (HAA) or high-performance liquid chromatography-inductively coupled plasma mass spectrometry (HPLC-ICP/MS). Analysis of cadmium by graphite furnace atomic absorption spectrophotometry (GFAA). Analysis of selenium by GFAA or HAA. Analysis of mercury by cold vapor atomic absorption spectrophotometry (CVAA). Analysis of tributyltin by GFAA or gas chromatography/flame photometric detection (GC/FPD).

^c Estimated costs are for total inorganic arsenic. Estimated cost of analysis by HAA is \$200. Estimated cost of analysis by HPLC-ICP/MS is \$400.

^d Estimated cost of analysis by GFAA is \$200. Estimated cost of analysis by GC/FPD is \$400. **Note:** Analysis by GFAA is not specific for tributyltin. Depending on the extraction procedure, other butyl- and alkyltin species may be detected.

^e Analysis by gas chromatography/electron capture detection (GC/ECD).

^f Estimated costs are for analysis of all recommended target analyte organochlorine pesticides (see Table 4-1).

^g Analysis by GC/FPD or gas chromatography/nitrogen-phosphorus detection (GC/NPD). Some of the chlorinated organophosphate pesticides (e.g., chlorpyrifos) may be analyzed as organochlorine pesticides by GC/ECD (USGS, 1987).

^h Analysis by GC/ECD.

ⁱ Costs are for analysis by gas chromatography/mass spectrometry (GC/MS) or gas chromatography/flame ionization detection (GC/FID). Cost for analysis by high-resolution gas chromatography/high resolution mass spectrometry (HRGC/HRMS) is approximately \$1,000 per sample.

^j Analysis by HRGC/HRMS.

^k Analysis by HRGC/low resolution mass spectrometry (LRMS).

deficiencies uncovered by the QC system are corrected. After the analytical data are collected, QA activities focus on assessing the quality of data obtained to determine its suitability to support decisions for further monitoring, risk assessments, or issuance of advisories.

The purpose of this section is to describe the general QA and QC requirements for chemical analysis programs.

8.3.1 QA Plans

Each laboratory performing chemical analyses in fish and shellfish contaminant monitoring programs must have an adequate QA program (U.S. EPA, 1984b). The QA program should be documented fully in a QA plan or in a combined Work/QA Project Plan (U.S. EPA, 1980b). (See Appendix I.) Each QA and QC requirement or procedure should be described clearly. Documentation should clearly demonstrate that the QA program meets overall program objectives and data quality requirements. The QA guidelines in the Puget Sound Estuary Program (1990d, 1990e), the NOAA Status and Trends Program (Battelle, 1989b; Cantillo, 1991; NOAA, 1987), the EPA 301(h) Monitoring Programs (U.S. EPA, 1987e), the EPA EMAP Near Coastal (EMAP-NC) Program (U.S. EPA, 1991e), and the EPA Contract Laboratory (CLP) Program (U.S. EPA, 1991b, 1991c) are recommended as a basis for developing program-specific QA programs. Additional method-specific QC guidance is given in references in Table 8-2.

8.3.2 Method Documentation

Methods used routinely for the analyses of contaminants in fish and shellfish tissues must be documented thoroughly, preferably as formal standard operating procedures (U.S. EPA, 1984b). Recommended contents of an analytical SOP are shown in Figure 8-1. Analytical SOPs must be followed exactly as written. A published method may serve as an analytical SOP only if the analysis is performed exactly as described. Any significant deviations from analytical SOPs must be documented in the laboratory records (signed and dated by the responsible person) and noted in the final data report. Adequate evidence must be provided to demonstrate that an SOP deviation did not adversely affect method performance (i.e., detection or quantitation limits, accuracy, precision). Otherwise, the effect of the deviation on data quality must be assessed and documented and all suspect data must be identified.

8.3.3 Minimum QA and QC Requirements for Sample Analyses

The guidance provided in this section is derived primarily from the protocols developed for the Puget Sound Estuary Program (1990d, 1990e). These protocols have also provided the basis for the EPA EMAP-NC QA and QC requirements (U.S. EPA, 1991e). QA and QC recommendations specified in this document are intended to provide a uniform performance standard for all analytical protocols used in state fish and shellfish contaminant monitoring

8. LABORATORY PROCEDURES II — SAMPLE ANALYSES

- | | |
|---|---|
| <ul style="list-style-type: none">• Scope and application• Method performance characteristics (accuracy, precision, method detection and quantitation limits) for each analyte• Interferences• Equipment, supplies, and materials• Sample preservation and handling procedures• Instrument calibration procedures• Sample preparation (i.e., extraction, digestion, cleanup) procedures | <ul style="list-style-type: none">• Sample analysis procedures• Quality control procedures• Corrective action procedures• Data reduction and analysis procedures (with example calculations)• Recordkeeping procedures (with standard data forms, if applicable)• Safety procedures and/or cautionary notes• Disposal procedures• References |
|---|---|

Figure 8-1. Recommended contents of analytical standard operating procedures (SOPs).

programs and to enable an assessment of the comparability of results generated by different laboratories and different analytical procedures. These recommendations are intended to represent minimum QA and QC procedures for any given analytical method. Additional method-specific QC procedures should always be followed to ensure overall data quality.

For sample analyses, minimum QA and QC requirements consist of (1) initial demonstration of laboratory capability and (2) routine analyses of appropriate QA and QC samples to demonstrate continued acceptable performance and to document data quality.

Initial demonstration of laboratory capability (prior to analysis of field samples) should include

- Instrument calibration
- Documentation of detection and quantitation limits
- Documentation of accuracy and precision
- Analysis of an accuracy-based performance evaluation sample provided by an external QA program.

Ongoing demonstration of acceptable laboratory performance and documentation of data quality should include

- Routine calibration and calibration checks
- Routine assessment of accuracy and precision
- Routine monitoring of interferences and contamination
- Regular assessment of performance through participation in external QA interlaboratory comparison exercises, when available.

The QA and QC requirements for the analyses of target analytes in tissues should be based on specific performance criteria (i.e., warning or control limits) for data quality indicators such as accuracy and precision. **Warning limits** are numerical criteria that serve to alert data reviewers and data users that data quality may be questionable. A laboratory is not required to terminate analyses when a warning limit is exceeded, but the reported data may be qualified during subsequent QA review. **Control limits** are numerical data criteria that, when exceeded, require

8. LABORATORY PROCEDURES II — SAMPLE ANALYSES

suspension of analyses and specific corrective action by the laboratory before the analyses may resume.

Typically, warning and control limits for accuracy are based on the historical mean recovery plus or minus two or three standard deviation units, respectively. Warning and control limits for precision are typically based on the historical standard deviation or coefficient of variation (or mean relative percent difference for duplicate samples) plus two or three standard deviation units, respectively. Procedures incorporating control charts (ASTM, 1976; Taylor, 1985) and/or tabular presentations of historical data should be in place for routine monitoring of analytical performance. Procedures for corrective action in the event of excursion outside warning and control limits should also be in place.

The results for the various QC samples analyzed with each batch of samples should be reviewed by qualified laboratory personnel immediately following the analysis of each sample batch to determine when warning or control limits have been exceeded. When established control limits are exceeded, appropriate corrective action should be taken and, if possible, all suspect samples reanalyzed before resuming routine analyses. If reanalyses cannot be performed, all suspect data should be identified clearly. **Note:** For the purposes of this guidance manual, a batch is defined as any group of samples from the same source that is processed at the same time and analyzed during the same analytical run.

Recommended QA and QC samples (with definitions and specifications), frequencies of analyses, control limits, and corrective actions are summarized in Table 8-6.

Note: EPA recognizes that resource limitations may prevent some states from fully implementing all recommended QA and QC procedures. Therefore, as additional guidance, the minimum numbers of QA and QC samples recommended for routine analyses of target analytes are summarized in Table 8-7. It is the responsibility of each program manager to ensure that the analytical QC program is adequate to meet program data quality objectives for method detection limits, accuracy, precision, and comparability.

Recommended QA and QC procedures and the use of appropriate QA and QC samples are discussed in Sections 8.3.3.2 through 8.3.3.8. Recommended procedures for documenting and reporting analytical and QA and QC data are given in Section 8.4. Because of their importance in assessing data quality and interlaboratory comparability, reference materials are discussed separately in the following section.

Table 8-6. Recommended Quality Assurance and Quality Control Samples

Sample type (definition; specifications)	Objective	Recommended frequency of analysis ^a	Recommended control limits ^b	Recommended corrective action
External Calibration				
Calibration standards (3-5 standards over the expected range of sample target analyte concentrations, with the lowest concentration standard at or near the MDL; see Section 8.3.3.2.1)	Full calibration: Establish relationship between instrument response and target analyte concentration. Used for organics analysis by GC/ECD and for metals analysis.	Instrument/method-dependent; follow manufacturer's recommendations or procedures in specific analytical protocols. At a minimum, perform a 3-point calibration each time an instrument is set up for analysis, after each major equipment change or disruption, and when routine calibration check exceeds specific control limits.	<i>Organics:</i> RSD of RFs of calibration standards $\leq 20\%$. <i>Metals:</i> %R of all calibration standards = 95-105.	Determine cause of problem (e.g., instrument instability or malfunction, contamination, inaccurate preparation of calibration standards) and take appropriate corrective action. Recalibrate and reanalyze all suspect samples or flag all suspect data.
Internal Standard Calibration				
Instrument internal standards (e.g., 2,2'-difluorobiphenyl) (see Section 8.3.3.2.1 for definition)	Full calibration: Determine RRFs of organic target analytes for quantitative analysis. Required for internal calibration of GC/MS systems. Optional calibration technique for GC/ECD.	In every calibration standard, sample, and blank analyzed; added to final sample extract. Internal standard calibration performed at same frequency recommended for external calibration.	RSD of RRFs of calibration standards $\leq 30\%$.	Determine cause of problem (e.g., instrument instability or malfunction, contamination, inaccurate preparation of internal standards or calibration standards) and take appropriate corrective action. Recalibrate and reanalyze all suspect samples or flag all suspect data.
Calibration Verification				
Calibration check standards (minimum of one mid-range standard prepared independently from initial calibration standards; an instrument internal standard must be added to each calibration check standard when internal standard calibration is being used; see Section 8.3.3.2.1)	Verify calibration.	<i>Organics (GC/MS):</i> After initial calibration or recalibration. At beginning and end of each work shift, and once every 12 h (or every 10-12 analyses, whichever is more frequent). <i>Organics (GC/ECD):</i> After initial calibration or recalibration. At beginning and end of each work shift, and once every 6 h (or every 6 samples, whichever is less frequent). <i>Metals:</i> After initial calibration or recalibration. Every 10 samples or every 2 h, whichever is more frequent.	<i>Organics:</i> Percent difference between the average RF (or RRF) from initial calibration and the RF (or RRF) from the calibration check $\leq 25\%$. <i>Mercury:</i> %R = 80-120. <i>Other Metals:</i> %R = 90-110.	Determine cause of problem (e.g., instrument instability or malfunction, contamination, inaccurate preparation of calibration standards) and take appropriate corrective action. Recalibrate and reanalyze all suspect samples or flag all suspect data.

(continued)

Table 8-6. (continued)

Sample type (definition; specifications)	Objective	Recommended frequency of analysis ^a	Recommended control limits ^b	Recommended corrective action
Method Detection Limit Determination				
Spiked matrix samples (analyte-free tissue samples to which known amounts of target analytes have been added; one spike for each target analyte at 3-5 times the estimated MDL; see Section 8.3.3.3.1)	Establish or confirm MDL for analyte of interest (Keith, 1991a; Keith et al., 1983).	Seven replicate analyses prior to use of method for routine analyses, and after any significant change to a method currently in use. Reevaluation of MDL annually.	Determined by program manager.	Redetermine MDL.
Accuracy and Precision Assessment				
Reference materials^c (see Section 8.3.3.1 for definitions) (SRMs or CRMs, prepared from actual contaminated fish or shellfish tissue if possible, covering the range of expected target analyte concentrations.	Assess method performance (initial method validation and routine accuracy assessment).	<i>Method validation:</i> As many as required to assess accuracy (and precision) of method before routine analysis of samples (i.e., when using a method for the first time or after any method modification). <i>Routine accuracy assessment:</i> one (preferably blind) per 20 samples or one per batch, whichever is more frequent.	<i>Organics:</i> Measured value <95% confidence intervals, if certified. Otherwise, %R = 70-130. ^d <i>Metals:</i> %R = 85-115. ^d <i>Organics:</i> Measured value <95% confidence intervals, if certified. Otherwise, %R = 70-130. ^d <i>Metals:</i> %R = 85-115. ^d	NA Determine cause of problem (e.g., inaccurate calibration, contamination), take appropriate corrective action, and reanalyze all suspect samples or flag all suspect data.
Laboratory control samples (Accuracy-based samples consisting of fish or shellfish tissue homogenates spiked with target analytes of interest; may be SRMs or CRMs; sometimes referred to as QC samples. When available, CRMs are recommended for routine use as laboratory control samples; see Appendix M)	Assess method performance (initial method validation and routine accuracy assessment). Used for initial accuracy assessment only if reference materials prepared from actual contaminated fish or shellfish are not available.	<i>Method validation:</i> As many as required to assess accuracy (and precision) of method before routine analysis of samples (i.e., when using a method for the first time or after any method modification). <i>Routine accuracy assessment:</i> One per 20 samples or one per batch, whichever is more frequent.	Determined by program manager. <i>Organics:</i> %R = 70-130. ^d <i>Metals:</i> %R = 85-115. ^d	NA Determine cause of problem (e.g., inaccurate calibration, inaccurate preparation of control samples), take appropriate corrective action, and reanalyze all suspect samples or flag all suspect data. Zero percent recovery requires rejection of all suspect data.

(continued)

8. LABORATORY PROCEDURES II — SAMPLE ANALYSES

Table 8-6. (continued)

Sample type (definition; specifications)	Objective	Recommended frequency of analysis ^a	Recommended control limits ^b	Recommended corrective action
Matrix spikes (composite tissue homogenates of field samples to which known amounts of target analytes have been added; 0.5 to 5 times the concentration of the analyte of interest or 5 times the MQL)	Assess matrix effects and accuracy (%R) routinely.	One per 20 samples or one per batch, whichever is more frequent.	<i>Organics:</i> %R \geq 50 with good precision. <i>Metals:</i> %R = 75-125.	Determine cause of problem (e.g., incomplete extraction or digestion, contamination), take appropriate corrective action, and reanalyze all suspect samples or flag all suspect data. Zero percent recovery requires rejection of all suspect data.
Matrix spike replicates (replicate aliquots of matrix spike samples; 0.5 to 5 times the concentration of the analyte of interest or 5 times the MQL)	Assess method precision routinely.	One duplicate per 20 samples or one per batch, whichever is more frequent.	<i>Organics:</i> A difference of no more than a factor of 2 among replicates (i.e., approximately 50% coefficient of variation). Note: Pooling of variances in duplicate analyses from different sample batches is recommended for estimating the standard deviation or coefficient of variation of replicate analyses. <i>Metals:</i> IRPDI \leq 20 for duplicates.	Determine cause of problem (e.g., incomplete extraction or digestion, contamination, instrument instability or malfunction), take appropriate corrective action, and reanalyze all suspect samples or flag all suspect data.
Laboratory replicates^c (replicate aliquots of composite tissue homogenates of field samples)	Assess method precision routinely.	One blind duplicate sample per 20 samples or one per batch, whichever is more frequent.	<i>Organics:</i> A difference of no more than a factor of 2 among replicates (i.e., approximately 50% coefficient of variation). Note: Pooling of variances in duplicate analyses from different sample batches is recommended for estimating the standard deviation or coefficient of variation of replicate analyses. <i>Metals:</i> IRPDI \leq 20 for duplicates.	Determine cause of problem (e.g., composite sample not homogeneous, instrument instability or malfunction), take appropriate corrective action, and reanalyze all suspect samples or flag all suspect data.
Analytical Replicates (replicate aliquots of final sample extract or digestate)	Assess analytical precision.	Duplicate injections for all metal analyses. ^f	Determined by program manager. ^g	Determine cause of problem (e.g., instrument instability or malfunction), take appropriate corrective action, and reanalyze sample.

(continued)

8. LABORATORY PROCEDURES II — SAMPLE ANALYSES

Table 8-6. (continued)

Sample type (definition; specifications)	Objective	Recommended frequency of analysis ^a	Recommended control limits ^b	Recommended corrective action
Field replicates (replicate composite tissue samples)	Assess total variability (i.e., population variability, field or sampling variability, and analytical method variability).	<i>Screening studies:</i> OPTIONAL ; if program resources allow, a minimum of one blind replicate (i.e., duplicate) for each primary target species at 10 percent of screening sites. ⁹ <i>Intensive studies:</i> Blind replicate samples for each target species (and size, age or sex class, if appropriate) at each sampling site. Number of replicates determined by program manager (see Section 6.1.2.7).	Determined by program manager. ⁹	Determined by program manager.
Contamination Assessment				
Blanks (field, method, processing, bottle, reagent) (see Section 8.3.3.6 for definitions)	Assess contamination from equipment, reagents, etc.	One field blank per sampling site. One method blank per 20 samples or one per batch, whichever is more frequent. At least one processing blank per study. At least one bottle blank per lot or per batch of samples, whichever is more frequent. One reagent blank prior to use of a new batch of reagent and whenever method blank exceeds control limits.	Concentration of any analyte <MDL or MQL, as determined by program manager.	Determine cause of problem (e.g., contaminated reagents, equipment), remove sources of contamination, and reanalyze all suspect samples or flag all suspect data.
Routine Monitoring of Method Performance for Organic Analyses				
Surrogate spikes (see Section 8.3.3.7.1 for definition)	Assess method performance and estimate recovery of organic target analytes analyzed by GC/MS. Determine RRFs of organic target analytes quantitated by isotope dilution techniques.	In every calibration standard, sample, and blank analyzed for organics by isotope dilution GC/MS; added to samples prior to extraction.	Determined by program manager.	Determine cause of problem (e.g., incomplete extraction or digestion, contamination, inaccurate preparation of internal standard), take appropriate corrective action, and reanalyze all suspect samples or flag all suspect data.

(continued)

8. LABORATORY PROCEDURES II — SAMPLE ANALYSES

Table 8-6. (continued)

Sample type (definition; specifications)	Objective	Recommended frequency of analysis ^a	Recommended control limits ^b	Recommended corrective action
Prepared from other surrogate compounds	Assess method performance and estimate the recovery of organic target analytes analyzed by GC/MS or GC/ECD.	In every calibration standard, sample, and blank analyzed for organics, unless isotope dilution technique is used: <i>Semivolatiles:</i> 3 for neutral fraction 2 for acid fraction <i>Volatiles:</i> 3 <i>Pesticides/PCBs:</i> 1 Added to samples prior to extraction.	Determined by program manager according to most recent EPA CLP guidelines. ^h	Determine cause of problem (e.g., incomplete extraction or digestion, contamination, inaccurate preparation of surrogates), take appropriate corrective action, and reanalyze all suspect samples or flag all suspect data.
External QA Assessment				
Accuracy-based performance evaluation samples (QA samples from NOAA interlaboratory comparison program; see Section 8.3.3.8.1)	Initial demonstration of laboratory capability. Ongoing demonstration of laboratory capability.	Once prior to routine analysis of field samples (blind). One exercise (four to six samples) per year (blind).	<i>Organics:</i> %R=70-130. ^d <i>Metals:</i> %R=85-115. ^d Determined by NOAA. Based on consensus value of all participating laboratories.	Determine cause of problem and reanalyze sample. Do not begin analysis of field samples until performance evaluation sample results are acceptable. Determine cause of problem. Do not continue analysis of field samples until laboratory capability is clearly demonstrated.

(continued)

Table 8-6. (continued)

Sample type (definition; specifications)	Objective	Recommended frequency of analysis ^a	Recommended control limits ^b	Recommended corrective action
Split samples (laboratory replicates analyzed by different laboratories; see Section 8.3.3.8.2)	Assess interlaboratory comparability.	5-10% of composite homogenates split between states and/or Regions that routinely share monitoring results, or as determined by program managers. ^g	Determined by program managers.	Review sampling and analytical methods. Identify sources of noncomparability. Standardize and validate methods to document comparability.
CLP = Contract laboratory program. CRM = Certified reference material (see Section 8.3.3.1).		NA = Not applicable. NOAA = National Oceanic and Atmospheric Administration.	RPD = Relative percent difference (see Section 8.3.3.5). RRF = Relative response factor (see Section 8.3.3.2.1).	
GC/ECD = Gas chromatography/electron capture detection.		PCBs = Polychlorinated biphenyls. QA = Quality assurance. %R = Percent recovery (see Sections 8.3.3.4 and 8.3.3.7.1).	RSD = Relative standard deviation (see Section 8.3.3.5). SRM = Standard reference material (see Section 8.3.3.1).	
GC/MS = Gas chromatography/mass spectrometry. MDL = Method detection limit (see Section 8.3.3.3.1). MQL = Method quantitation limit (see Section 8.3.3.3.2).		RF = Response factor (see Section 8.3.3.2.1).		

^a Recommended frequencies are based primarily on recommendations in U.S. EPA (1986d, 1987e, 1989c, 1991b, 1991c), Puget Sound Estuary Program (1990d, 1990e), and Battelle (1989b).
^b From Puget Sound Estuary Program (1990d, 1990e) action limits, except where otherwise noted. **Note:** Individual programs may require more stringent control limits. It is the responsibility of each program manager to set control limits that will ensure that the measurement data meet program data quality objectives.
^c As available (see Table 8-8 and Appendix M).
^d From U.S.EPA (1991e).
^e Sometimes referred to as analytical replicates (e.g., in Puget Sound Estuary Program, 1990d).
^f From U.S. EPA (1987e).
^g Recommended by EPA for this guidance document.
^h From U.S. EPA (1991b, 1991c).

Table 8-7. Minimum Recommended QA and QC Samples for Routine Analysis of Target Analytes^a

Sample Type	Target analyte	
	Metals	Organics
Accuracy-based performance evaluation sample ^b	Once prior to routine analysis of field samples, plus one exercise (four to six samples) per year.	Once prior to routine analysis of field samples, plus one exercise (four to six samples) per year.
Method blank	1	1
Laboratory duplicate	1	1
Matrix spike/matrix spike replicate	1	1
Laboratory control sample (SRM or CRM, if available)	1	1
Calibration check standard	2 ^c	2 ^c
Surrogate spike (isotopically labeled target analyte or other surrogate compound added prior to extraction)	NA	Each sample
Instrument (injection) internal standard; added prior to injection	NA	Each calibration or calibration check standard and each sample or blank analyzed by GC/MS ^d

CRM = Certified reference material (see Section 8.3.3.1).
 GC/MS = Gas chromatography/mass spectroscopy.
 NA = Not applicable.

QA = Quality assurance.
 QC = Quality control.
 SRM = Standard reference material (see Section 8.3.3.1).

^a Unless otherwise specified, the number given is the recommended number of QC samples per 20 samples or per batch, whichever is more frequent. Additional method-specific QC requirements should always be followed provided these minimum requirements have been met.
^b QA samples from National Oceanic and Atmospheric Administration interlaboratory comparison program (see Section 8.3.3.8.1).
^c One every 10 samples (plus one at beginning and end of each analytical run).
^d Optional for analyses by GC/electron capture detection (ECD), GC/flame ionization detection (FID), or GC with other nonspecific detectors.

8.3.3.1 Reference Materials—

The appropriate use of reference materials is an essential part of good QA and QC practices for analytical chemistry. The following definitions of reference materials (Puget Sound Estuary Program, 1990d) are used in this guidance document:

- A **reference material** is any material or substance of which one or more properties have been sufficiently well established to allow its use for instrument calibration, method evaluation, or characterization of other materials.
- A **certified reference material (CRM)** is a reference material of which the value(s) of one or more properties has (have) been certified by a variety of technically valid procedures. CRMs are accompanied by or traceable to a certificate or other documentation that is issued by the certifying organization (e.g., U.S. EPA, NIST, National Research Council of Canada [NRCC]).
- A **standard reference material (SRM)** is a CRM issued by the NIST.

Reference materials may be used to (1) provide information on method accuracy and, when analyzed in replicate, on precision, and (2) obtain estimates of intermethod and/or interlaboratory comparability. An excellent discussion of the use of reference materials in QA and QC procedures is given in Taylor (1985). The following general guidelines should be followed to ensure proper use of reference materials (NOAA, 1992):

- When used to assess the accuracy of an analytical method, the matrix of the reference material should be as similar as possible to that of the samples of interest. If reference materials in matrices other than fish or shellfish tissue are used, possible matrix effects should be addressed in the final data analysis or interpretation.
- Concentrations of reference materials should cover the range of possible concentrations in the samples of interest. **Note:** Because of a lack of low- and high-concentration reference materials for most analytes in fish and shellfish tissue matrices, potential problems at low or high concentrations often cannot be documented.
- Reference materials should be analyzed prior to beginning the analyses of field samples to assess laboratory capability and regularly thereafter to detect and document any changes in laboratory performance over time. Appropriate corrective action should be taken whenever changes are observed outside specified performance limits (e.g., accuracy, precision).
- If possible, reference material samples should be introduced into the sample stream as double blinds, that is, with identity and concentration unknown to the analyst. However, because of the limited number of certified fish and

8. LABORATORY PROCEDURES II — SAMPLE ANALYSES

shellfish tissue reference materials available, the results of analyses of these materials may be biased by an analyst's increasing ability to recognize these materials with increased use.

- Results of reference material analyses are essential to assess interlaboratory or intermethod comparability. However, the results of sample analyses should not be corrected based on percent recoveries of reference materials. Final reported results should include both uncorrected sample results and percent recoveries of reference materials.

Sources of reference materials for the analysis of priority pollutants and selected related compounds in fish and shellfish tissues are given in Appendix M. Available marine or estuarine tissue reference materials that may be appropriate for use by analytical laboratories in fish and shellfish contaminant monitoring programs are given in Table 8-8.

8.3.3.2 Calibration and Calibration Checks—

General guidelines for initial calibration and routine calibration checks are provided in this section. Method-specific calibration procedures are included in the references in Table 8-2. It is the responsibility of each program manager to ensure that proper calibration procedures are developed and followed for each analytical method to ensure the accuracy of the measurement data.

All analytical instruments and equipment should be maintained and calibrated properly to ensure optimum operating conditions throughout a measurement program. Calibration and maintenance procedures should be performed according to SOPs based on the manufacturers' specifications and the requirements of specific analytical procedures. Calibration procedures must include provisions for documenting calibration frequencies, conditions, standards, and results to describe adequately the calibration history of each measurement system. Calibration records should be inspected regularly to ensure that these procedures are being performed at the required frequency and according to established SOPs. Any deficiencies in the records or deviations from established procedures should be documented and appropriate corrective action taken.

Calibration standards of known and documented accuracy must be used to ensure the accuracy of the analytical data. Each laboratory should have a program for verifying the accuracy and traceability of calibration standards against the highest quality standards available. If possible, NIST-SRMs or other certified reference standards should be used for calibration standards (see Section 8.3.3.4 and Appendix M). A log of all calibration materials and standard solutions should be maintained. Appropriate storage conditions (i.e., container specifications, shelf-life, temperature, humidity, light condition) should be documented and maintained.

8. LABORATORY PROCEDURES II — SAMPLE ANALYSES

Table 8-8. Fish and Shellfish Tissue Reference Materials

Identification code	Analytes	Source	Matrix
DOLT-1	Elements	NRCC	Dogfish liver (freeze-dried)
DORM-1	Elements	NRCC	Dogfish muscle (freeze-dried)
LUTS-1	Elements	NRCC	Non-defatted lobster hepatopancreas
TORT-1	Elements	NRCC	Lobster hepatopancreas
GBW-08571	Elements	NRCCRM	Mussel tissue (freeze-dried)
GBW-08572	Elements	NRCCRM	Prawn tissue
MA-A-1/OC	Organic compounds	IAEA	Copepod homogenate (freeze-dried)
MA-A-3/OC	Organic compounds	IAEA	Shrimp homogenate (freeze-dried)
MA-B-3/OC	Organic compounds	IAEA	Fish tissue (freeze-dried)
MA-M-2/OC	Organic compounds	IAEA	Mussel tissue
MA-A-1/TM	Elements	IAEA	Copepod homogenate (freeze-dried)
MA-A-2/TM	Elements	IAEA	Fish flesh homogenate
MA-B-3/TM	Elements	IAEA	Fish tissue (freeze-dried)
MA-B-3/RN	Isotopes	IAEA	Fish tissue (freeze-dried)
IAEA-350	Elements	IAEA	Tuna homogenate (freeze-dried)
IAEA-351	Organic compounds	IAEA	Tuna homogenate (freeze-dried)
IAEA-352	Isotopes	IAEA	Tuna homogenate (freeze-dried)
CRM-278	Elements	BCR	Mussel tissue (freeze-dried)
CRM-422	Elements	BCR	Cod muscle (freeze-dried)
EPA-FISH	Pesticides	EPA1	Fish tissue
EPA-SRS903	Chlordane	EPA2	Fish tissue
EPA-0952	Mercury	EPA1	Fish tissue
EPA-2165	Mercury	EPA1	Fish tissue
RM-50	Elements	NIST	Albacore tuna (freeze-dried)
SRM-1566a	Elements	NIST	Oyster tissue (freeze-dried)
SRM-1974	Organic compounds	NIST	Mussel tissue (frozen)
SRM-2974	Organic compounds	NIST	Mussel tissue (freeze-dried)
NIES-6	Elements	NIES	Mussel tissue

Sources:

- BCR = Community Bureau of Reference, Commission of the European Communities, Directorate General for Science, Research and Development, 200 rue de la Loi, B-1049 Brussels, Belgium.
- EPA = U.S. Environmental Protection Agency, Quality Assurance Branch, EMSL-Cincinnati, Cincinnati, OH, 45268, USA. (EPA1: Material available from Supelco, Inc., Supelco Park, Bellefonte, PA, 16823-0048, USA. EPA2: Material available from Fisher Scientific, 711 Forbes Ave., Pittsburgh, PA 15219.)
- IAEA = International Atomic Energy Agency, Analytical Quality Control Service, Laboratory Seibersdorf, P. O. Box 100, A-1400 Vienna, Austria.
- NRCCRM = National Research Center for CRMs, Office of CRMs, No. 7, District 11, Hepingjie, Chaoyangqu, Beijing, 100013, China.
- NRCC = National Research Council of Canada, Institute for Environmental Chemistry, Marine Analytical Chemistry Standards Program, Division of Chemistry, Montreal Road, Ottawa, Ontario K1A 0R9, Canada.
- NIST = National Institute of Standards and Technology, Office of Standard Reference Materials, Gaithersburg, MD, 20899, USA.
- NIES = National Institute for Environmental Studies, Yatabe-machi, Tsukuba, Ibaraki, 305, Japan.

8.3.3.2.1 Initial and routine calibration

Prior to beginning routine analyses of samples, a minimum of three (and preferably five) calibration standards should be used to construct a calibration curve for each target analyte, covering the normal working range of the instrument or the expected target analyte concentration range of the samples to be analyzed. The lowest-concentration calibration standard should be at or near the estimated method detection limit (see Section 8.3.3.3.1). Calibration standards should be prepared in the same matrix (i.e., solvent) as the final sample extract or digestate. Criteria for acceptable calibration (e.g., acceptable limits for r^2 , slope, intercept, percent recovery, response factors) should be established for each analytical method. If these control limits are exceeded, the source of the problem (e.g., inaccurate standards, instrument instability or malfunction) should be identified and appropriate corrective action taken. No analyses should be performed until acceptable calibration has been achieved and documented.

In addition to the initial calibration, an established schedule for the routine calibration and maintenance of analytical instruments should be followed, based on manufacturers' specifications, historical data, and specific procedural requirements. At a minimum, calibration should be performed each time an instrument is set up for analysis, after any major disruption or failure, after any major maintenance, and whenever a calibration check exceeds the recommended control limits (see Table 8-6).

Two types of calibration procedures are used in the analytical methods recommended for the quantitation of target analytes: external calibration and internal standard calibration.

External calibration

In external calibration, calibration standards with known concentrations of target analytes are analyzed, independent of samples, to establish the relationship between instrument response and target analyte concentration. External calibration is used for the analyses of metals and, at the option of the program manager, for the analyses of organics by gas chromatography/electron capture detection (GC/ECD), gas chromatography/flame ionization detection (GC/FID), or GC methods using other nonspecific detectors.

External calibration for metals analysis is considered acceptable if the percent recovery of all calibration standards is between 95 and 105 percent; external calibration for organic analyses is considered acceptable if the relative standard deviation (RSD) of the response factors (RFs) is ≤ 20 percent (see Table 8-6). If these limits are exceeded, the initial calibration should be repeated.

Internal standard calibration

Calibration of GC/mass spectrometry (MS) systems used for the analysis of organic target analytes requires the addition of an **internal standard** to each calibration standard and determination of the response of the target analyte of interest relative to that of the internal standard. Internal standard calibration may also be used with nonspecific detector GC methods such as GC/ECD and GC/FID. Internal standards used to determine the relative response factors (RRFs) are termed instrument or injection internal standards (Puget Sound Estuary Program, 1990d; U.S. EPA, 1991e). The addition of instrument internal standards to both calibration standards and sample extracts ensures rigorous quantitation, particularly accounting for shifts in retention times of target analytes in complex sample extracts relative to calibration standards. Recommended instrument internal standards for semivolatile organic compounds are included in analytical methods for these compounds (see references in Table 8-2).

The RRF for each target analyte is calculated for each calibration standard as follows:

$$RRF_t = (A_t) (C_{is}) / (A_{is}) (C_t) \quad (8-1)$$

where

- A_t = Measured response (integrated peak area) for the target analyte
- C_{is} = Concentration of the instrument internal standard in the calibration standard
- A_{is} = Measured response (integrated peak area) for the instrument internal standard
- C_t = Concentration of the target analyte in the calibration standard.

If the RSD of the average RRF_t for all calibration standards ($\overline{RRF_t}$) is ≤ 30 percent, RRF_t can be assumed to be constant across the working calibration range and RRF_t can be used to quantitate target analyte concentrations in the samples as follows:

$$C_t \text{ (ppm or ppb, wet weight)} = (A_t) (C_{is}) (V_e) / (A_{is}) (\overline{RRF_t}) (W) \quad (8-2)$$

where

- C_t = Concentration of the target analyte in the sample
- C_{is} = Concentration of the instrument internal standard in the sample extract
- V_e = Volume of the final sample extract (mL)
- W = Weight of sample extracted (g)

and A_t , A_{is} , and \overline{RRF}_t are defined as in Equation (8-1).

If the RSD of \overline{RRF}_t for all calibration standards is >30 percent, the initial calibration should be repeated (see Table 8-6).

8.3.3.2.2 Routine calibration checks

After initial calibration has been achieved and prior to the routine analyses of samples, the accuracy of the calibration should be verified by the analysis of a calibration check standard. A **calibration check standard** is a mid-range calibration standard that has been prepared independently (i.e., using a different stock) from the initial calibration standards. When internal standard calibration is being used, an instrument internal standard must be added to each calibration check standard.

Routine calibration checks should be conducted often enough throughout each analysis run to ensure adequate maintenance of instrument calibration (see Table 8-6). A calibration check should always be performed after analyzing the last sample in a batch and at the end of each analysis run.

If a calibration check does not fall within specified calibration control limits, the source of the problem should be determined and appropriate corrective action taken (see Table 8-6). After acceptable calibration has been reestablished, all suspect analyses should be repeated. If resources permit, it is recommended that all samples after the last acceptable calibration check be reanalyzed. Otherwise, the last sample analyzed before the unacceptable calibration check should be reanalyzed first and reanalysis of samples should continue in reverse order until the difference between the reanalysis and initial results is within the control limits specified in Table 8-6. If reanalysis is not possible, all suspect data (i.e., since the last acceptable calibration check) should be identified clearly in the laboratory records and the data report.

8.3.3.2.3 Calibration range and data reporting

As noted in Section 8.3.2.1, the lowest-concentration calibration standard should be at or near the method detection limit. The highest-concentration calibration standard should be selected to cover the full range of expected concentrations of the target analyte in fish and shellfish tissue samples. If a sample concentration occurs outside the calibration range, the sample should be diluted or concentrated as appropriate and reanalyzed or the calibration range should be extended. Extremely high concentrations of organic compounds may indicate that the extraction capabilities of the method have been saturated and extraction of a smaller sample or modification of the extraction procedure may be required.

All reported concentrations must be within the upper limit of the demonstrated working calibration range. Procedures for reporting data, with appropriate

qualifications for data below method detection and quantitation limits, are given in Section 8.3.3.3.3.

8.3.3.3 Assessment of Detection and Quantitation Limits—

It is the responsibility of each laboratory to determine appropriate detection and quantitation limits for each analytical method for each target analyte in a fish or shellfish tissue matrix. When available scientific literature demonstrates that the selected SVs are analytically attainable, the laboratory is responsible for ensuring that these limits are sufficiently low to allow reliable quantitation of the analyte at or below the selected SVs (see Section 5.2). Detection and quantitation limits must be determined prior to the use of any method for routine analyses and after any significant changes are made to a method during routine analyses. Several factors influence achievable detection and quantitation limits regardless of the specific analytical procedure. These include amount of sample available, matrix interferences, and stability of the instrumentation. The limits of detection given in Table 8-4 are considered to be representative of typically attainable values. Depending upon individual laboratory capabilities and fish tissue matrix properties, it should be noted that SVs for some recommended target analytes (e.g., inorganic arsenic, dieldrin, heptachlor epoxide, toxaphene, PCBs, and dioxins/furans) may not always be analytically attainable quantitation limits. In these instances, all historic and current data on contaminant sources and on water, sediment, and fish and shellfish contaminant tissue data should be reviewed to provide additional information that could aid in the risk assessment process and in making risk management decisions.

The EPA has previously issued guidance on detection limits for trace metal and organic compounds for analytical methods used in chemical contaminant monitoring programs (U.S. EPA, 1985a). However, at present there is no clear consensus among analytical chemists on a standard procedure for determining and reporting the limits of detection and quantitation of analytical procedures. Furthermore, detection and quantitation limits reported in the literature are seldom clearly defined. Reported detection limits may be based on instrument sensitivity or determined from the analyses of method blanks or low-level matrix spikes; quantitation limits may be determined from the analyses of method blanks or low-level matrix spikes (Puget Sound Estuary Program, 1990d).

8.3.3.3.1 Detection limits

The EPA recommends that the method detection limit (MDL) defined below and determined according to 40 CFR 136, Appendix B, be used to establish the limits of detection for the analytical methods used for analyses of all target analytes:

- **Method Detection Limit:** The minimum concentration of an analyte in a given matrix (i.e., fish or shellfish tissue homogenates for the purposes of this guidance) that can be measured and reported with 99 percent confidence that the concentration is greater than zero. The MDL is determined by multiplying

8. LABORATORY PROCEDURES II — SAMPLE ANALYSES

the appropriate (i.e., n-1 degrees of freedom) one-sided 99 percent Student's t-statistic ($t_{0.99}$) by the standard deviation (**S**) obtained from a minimum of seven replicate analyses of a **spiked matrix sample** containing the analyte of interest at a concentration three to five times the estimated MDL (Glaser et al., 1981; 40 CFR 136, Appendix B):

$$\text{MDL} = (t_{0.99}) (S). \quad (8-3)$$

It is important to emphasize that all sample processing steps of the analytical method (e.g., digestion, extraction, cleanup) must be included in the determination of the MDL.

In addition to the MDL, three other types of detection limits have been defined by the American Chemical Society Committee on Environmental Improvement (Keith, 1991a):

- **Instrument Detection Limit (IDL):** The smallest signal above background noise that an instrument can detect reliably.
- **Limit of Detection (LOD):** The lowest concentration that can be determined to be statistically different from a method blank at a specified level of confidence. The recommended value for the LOD is three times the standard deviation of the blank in replicate analyses, corresponding to a 99 percent confidence level.
- **Reliable Detection Limit (RDL):** The concentration level of an analyte in a given matrix at which a detection decision is extremely likely. The RDL is generally set higher than the MDL. When $\text{RDL}=\text{MDL}$, the risk of a false positive at 3σ from zero is <1 percent, whereas the corresponding risk of a false negative is 50 percent. When $\text{RDL}=2\text{MDL}$, the risk of either a false positive or a false negative at 3σ from zero is <1 percent.

Each of these estimates has its practical limitations. The IDL does not account for possible blank contaminants or matrix interferences. The LOD accounts for blank contaminants but not for matrix effects or interferences. In some instances, the relatively high value of the MDL or RDL may be too stringent and result in the rejection of valid data; however, these are the only detection limit estimates that account for matrix effects and interferences and provide a high level of statistical confidence in sample results. The MDL is the recommended detection limit in the EPA EMAP-NC Program (U.S. EPA, 1991e).

The MDL, expressed as the concentration of target analyte in fish tissue, is calculated from the measured MDL of the target analyte in the sample extract or digestate according to the following equation:

$$\text{MDL}_{\text{tissue}} \text{ (ppm or ppb)} = (\text{MDL}_{\text{extract}} \cdot V) / W \quad (8-4)$$

where

V = Final extract or digestate volume, after dilution or concentration (mL)
W = Weight of sample digested or extracted (g).

Equation 8-4 clearly illustrates that the MDL in tissue may be improved (reduced) by increasing the sample weight (W) and/or decreasing the final extract or digestate volume (V).

The initial MDL is a statistically derived empirical value that may differ in actual samples depending on several factors, including sample size, matrix effects, and percent moisture. Therefore, it is recommended that each laboratory reevaluate annually all MDLs for the analytical methods used for the sample matrices typically encountered (U.S. EPA, 1991e).

Experienced analysts may use their best professional judgment to adjust the measured MDL to a lower "typically achievable" detection limit (Puget Sound Estuary Program, 1990e; U.S. EPA, 1985a) or to derive other estimates of detection limits. For example, EPA recommends the use of lower limits of detection (LLDs) for GG/MS methods used to analyze organic pollutants in bioaccumulation monitoring programs (U.S. EPA, 1986a). Estimation of the LLD for a given analyte involves determining the noise level in the retention window for the quantitation mass of the analyte for at least three field samples in the sample set being analyzed. The LLD is then estimated as the concentration corresponding to the signal required to exceed the average noise level observed by at least a factor of 2. Based on the best professional judgment of the analyst, this LLD is applied to samples in the set with comparable or lower interference; samples with significantly higher interferences (i.e., by at least a factor of 2) are assigned correspondingly higher LLDs. LLDs are greater than IDLs but usually are less than the more rigorously defined MDLs. Thus, data quantified between the LLD and the MDL have a lower statistical confidence associated with them than data quantified above the MDL. However, these data are considered valid and useful in assessing low-level environmental contamination.

If estimates of detection limits other than the MDL are developed and used to qualify reported data, they should be clearly defined in the analytical SOPs and in all data reports, and their relationship to the MDL should be clearly described.

8.3.3.3.2 Quantitation limits

In addition to the MDL, a method quantitation limit (MQL), or minimum concentration allowed to be reported at a specified level of confidence without qualifications, should be derived for each analyte. Ideally, MQLs should account for matrix effects and interferences. The MQL can be greater than or equal to the MDL. At present, there is no consistent guidance in the scientific literature for determining MQLs; therefore, it is not possible to provide specific recommendations for determining these limits at this time.

The American Chemical Society Committee on Environmental Improvement (Keith, 1991b; Keith et al., 1983) has defined one type of quantitation limit:

- **Limit of Quantitation (LOQ):** The concentration above which quantitative results may be obtained with a specified degree of confidence. The recommended value for the LOQ is 10 times the standard deviation of a method blank in replicate analyses, corresponding to an uncertainty of ± 30 percent in the measured value ($10\sigma \pm 3\sigma$) at the 99 percent confidence level.

The LOQ is the recommended quantitation limit in the EPA EMAP-NC Program (U.S. EPA, 1991e). However, the LOQ does not account for matrix effects or interferences.

The U.S. EPA (1986d) has defined another type of quantitation limit:

- **Practical Quantitation Limit (PQL):** The lowest concentration that can be reliably reported within specified limits of precision and accuracy under routine laboratory operating conditions.

The Puget Sound Estuary Program (1990d) and the National Dioxin Study (U.S. EPA, 1987d) used a PQL based on the lowest concentration of the initial calibration curve (C, in $\mu\text{g}/\text{mL}$), the amount of sample typically analyzed (W, in g), and the final extract volume (V, in mL) of that method:

$$\text{PQL } (\mu\text{g} / \text{g}[\text{ppm}]) = \frac{C (\mu\text{g} / \text{mL}) \cdot V(\text{mL})}{W (\text{g})} \quad (8-5)$$

However, this PQL is also applicable only to samples without substantial matrix effects or interferences.

A reliable detection limit (RDL) equal to 2 MDL may also be used as an estimate of the MQL (see Section 8.3.3.3.1). The RDL accounts for matrix effects and provides a high level of statistical confidence in analytical results.

Analysts must use their expertise and professional judgment to determine the best estimate of the MQL for each target analyte. MQLs, including the estimated degree of confidence in analyte concentrations above the quantitation limit, should be clearly defined in the analytical SOPs and in all data reports.

8.3.3.3.3 Use of detection and quantitation limits in reporting data

The analytical laboratory does not have responsibility or authority to censor data. Therefore, all data should be reported with complete documentation of limitations and problems. Method detection and quantitation limits should be used to qualify reported data for each composite sample as follows (Keith, 1991b):

8. LABORATORY PROCEDURES II — SAMPLE ANALYSES

- "Zero" concentration (no observed response) should be reported as not detected (ND) with the MDL noted, e.g., "ND(MDL=X)".
- Concentrations below the MDL should be reported with the qualification that they are below the MDL.
- Concentrations between the MDL and the MQL should be reported with the qualification that they are below the quantitation limit.
- Concentrations at or above the MQL may be reported and used without qualification.

The use of laboratory data for comparing target analyte concentrations to SVs in screening and intensive studies is discussed in Sections 9.1.1 and 9.1.2.

8.3.3.4 Assessment of Method Accuracy—

The accuracy of each analytical method should be assessed and documented for each target analyte of interest, in a fish or shellfish tissue matrix, prior to beginning routine analyses and on a regular basis during routine analyses.

Method accuracy may be assessed by analysis of appropriate reference materials (i.e., SRMs or CRMs prepared from actual contaminated fish or shellfish tissue, see Table 8-8, **laboratory control samples** (i.e., accuracy-based samples consisting of fish and shellfish tissue homogenates spiked with compounds representative of the target analytes of interest), and/or **matrix spikes**. If possible, laboratory control samples should be SRMs or CRMs. **Note:** Only the analysis of fish or shellfish tissue SRMs or CRMs prepared from actual contaminated fish or shellfish tissue allows rigorous assessment of total method accuracy, including the accuracy with which an extraction or digestion procedure isolates the target analyte of interest from actual contaminated fish or shellfish. The analysis of spiked laboratory control samples or matrix spikes provides an assessment of method accuracy including sample handling and analysis procedures but does not allow rigorous assessment of the accuracy or efficiency of extraction or digestion procedures for actual contaminated fish or shellfish. Consequently, these samples should not be used for the primary assessment of total method accuracy unless SRMs or CRMs prepared from actual contaminated fish or shellfish tissue are not available.

The concentrations of target analytes in samples used to assess accuracy should fall within the range of concentrations found in the field samples; however, this may not always be possible for reference materials or laboratory control samples because of the limited number of these samples available in fish and shellfish tissue matrices (see Table 8-8). Matrix spike samples should be prepared using spike concentrations approximately equal to the concentrations found in the unspiked samples. An acceptable range of spike concentrations is 0.5 to 5 times

8. LABORATORY PROCEDURES II — SAMPLE ANALYSES

the expected sample concentrations (U.S. EPA, 1987e). Spikes should always be added to the sample homogenates prior to digestion or extraction.

Accuracy is calculated as percent recovery from the analysis of reference materials, or laboratory control samples, as follows:

$$\% \text{ Recovery} = 100 (M/T) \quad (8-6)$$

where

M = Measured value of the concentration of target analyte
T = "True" value of the concentration of target analyte.

Accuracy is calculated as percent recovery from the analysis of matrix spike samples as follows:

$$\% \text{ Recovery} = [(M_s - M_u)/T_s] \times 100 \quad (8-7)$$

where

M_s = Measured concentration of target analyte in the spiked sample
M_u = Measured concentration of target analyte in the unspiked sample
T_s = "True" concentration of target analyte added to the spiked sample.

When sample concentrations are less than the MDL, the value of one-half the MDL should be used as the concentration of the unspiked sample (M_u) in calculating spike recoveries.

8.3.3.4.1 Initial assessment of method accuracy

As discussed above, method accuracy should be assessed initially by analyzing appropriate SRMs or CRMs that are prepared from actual contaminated fish or shellfish tissue. The number of reference samples required to be analyzed for the initial assessment of method accuracy should be determined by each laboratory for each analytical procedure with concurrence of the program manager. If such SRMs or CRMs are not available, laboratory control samples or matrix spikes may be used for initial assessment of method accuracy.

8.3.3.4.2 Routine assessment of method accuracy

Laboratory control samples and matrix spikes should be analyzed for continuous assessment of accuracy during routine analyses. It is recommended that one laboratory control sample and one matrix spike sample be analyzed with every 20 samples or with each sample batch, whichever is more frequent (Puget Sound Estuary Program, 1990d, 1990e). Ideally, CRMs or SRMs should also be analyzed at this recommended frequency; however, limited availability and cost of these materials may make this impractical.

For organic compounds, isotopically labeled or surrogate recovery standards that must be added to each sample to monitor overall method performance also provide an assessment of method accuracy (see Section 8.3.3.7.1).

Percent recovery values for spiked samples must fall within established control limits (see Table 8-6). If the percent recovery falls outside the control limit, the analyses should be discontinued, appropriate corrective action taken, and, if possible, the samples associated with the spike reanalyzed. If reanalysis is not possible, all suspect data should be clearly identified.

Note: Reported data should not be corrected for percent recoveries. Recovery data should be reported for each sample to facilitate proper evaluation and use of analytical results.

Poor performance on the analysis of reference materials or poor spike recovery may be caused by inadequate mixing of the composite homogenate sample before aliquotting, inconsistent digestion or extraction procedures, matrix interferences, or instrumentation problems. If replicate analyses are acceptable (see Section 8.3.3.5), matrix interferences or loss of target analytes during sample preparation are indicated. To check for loss of target analytes during sample preparation, a step-by-step examination of the procedure using spiked blanks should be conducted. For example, to check for loss of metal target analytes during digestion, a postdigestion spike should be prepared and analyzed and the results compared with those from a predigestion spike. If the results are significantly different, the digestion technique should be modified to obtain acceptable recoveries. If there is no significant difference in the results of pre- and postdigestion spikes, the sample should be diluted by at least a factor of 5 and reanalyzed. If spike recovery is still poor, then the method of standard additions or use of a matrix modifier is indicated (U.S. EPA, 1987e).

8.3.3.5 Assessment of Method Precision—

The precision of each analytical method should be assessed and documented for each target analyte prior to the performance of routine analyses and on a regular basis during routine analysis.

Precision is defined as the agreement among a set of replicate measurements without assumption of knowledge of the true value. Method precision (i.e., total variability due to sample preparation and analysis) is estimated by means of the analyses of duplicate or replicate tissue homogenate samples containing concentrations of the target analyte of interest above the MDL. All samples used for assessment of total method precision must be carried through the complete analytical procedure, including extraction or digestion.

The most commonly used estimates of precision are the relative standard deviation or coefficient of variation (CV) for multiple samples, and the relative percent

difference (RPD) when only two samples are available. These are defined as follows:

$$\text{RSD} = \text{CV} = 100 S/\bar{x}_i \quad (8-8)$$

where

S = Standard deviation of the x_i measurements
 \bar{x}_i = Arithmetic mean of the x_i measurements

and

$$\text{RPD} = 100 \{(x_1 - x_2)/[(x_1 + x_2)/2]\} . \quad (8-9)$$

8.3.3.5.1 Initial assessment of method precision

Method precision should be assessed prior to routine sample analyses by analyzing replicate samples of the same reference materials, laboratory control samples, and/or matrix spikes that are used for initial assessment of method accuracy (see Section 8.3.3.4.1). The number of replicates required to be analyzed for the initial assessment of method precision should be determined by each laboratory for each analytical procedure with concurrence of the program manager. Because precision may be concentration-dependent, initial assessments of precision across the estimated working range should be obtained.

8.3.3.5.2 Routine assessment of method precision

Ongoing assessment of method precision during routine analysis should be performed by analyzing replicate aliquots of tissue homogenate samples taken prior to sample extraction or digestion (i.e., **laboratory replicates**) and **matrix spike replicates**. Matrix spike concentrations should approximate unspiked sample concentrations; an acceptable range for spike concentrations is 0.5 to 5 times the sample concentrations (U.S. EPA, 1987e).

For ongoing assessment of method precision, it is recommended that one laboratory duplicate and one matrix spike duplicate be analyzed with every 20 samples or with each sample batch, whichever is more frequent. In addition, it is recommended that a **laboratory control sample** be analyzed at the above frequency to allow an ongoing assessment of method performance, including an estimate of method precision over time. Specific procedures for estimating method precision by laboratory and/or matrix spike duplicates and laboratory control samples are given in ASTM (1983). This reference also includes procedures for estimating method precision from spike recoveries and for testing for significant change in method precision over time.

Precision estimates obtained from the analysis of laboratory duplicates, matrix spike duplicates, and repeated laboratory control sample analyses must fall within

specified control limits (see Table 8-6). If these values fall outside the control limits, the analyses should be discontinued, appropriate corrective action taken, and, if possible, the samples associated with the duplicates reanalyzed. If reanalysis is not possible, all suspect data should be clearly identified.

Unacceptable precision estimates derived from the analysis of duplicate or replicate samples may be caused by inadequate mixing of the sample before aliquotting; inconsistent contamination; inconsistent digestion, extraction, or cleanup procedures; or instrumentation problems (U.S. EPA, 1987e).

8.3.3.5.3 Routine assessment of analytical precision

The analysis of replicate aliquots of final sample extracts or digestates (**analytical replicates**) provides an estimate of analytical precision only; it does not provide an estimate of total method precision. For organic target analytes, analytical replicates may be included at the discretion of the program manager or laboratory supervisor. For the analysis of target metal analytes by graphite furnace atomic absorption spectrophotometry (GFAA) and cold vapor atomic absorption spectrophotometry (CVAA), it is recommended that duplicate injections of each sample be analyzed and the mean concentration be reported. The RPD should be within control limits established by the program manager or laboratory supervisor, or the sample should be reanalyzed (U.S. EPA, 1987e).

8.3.3.5.4 Assessment of overall variability

Estimates of the overall variability of target analyte concentrations in a sample fish or shellfish population and of the sampling and analysis procedures can be obtained by collecting and analyzing **field replicates**. Replicate field samples are optional in screening studies; however, if resources permit, it is recommended that duplicate samples be collected at 10 percent of the screening sites as a minimal QC check. Analysis of replicate field samples provides some degree of variability in that the samples themselves are typically collected and exposed to the same environmental conditions and contaminants. There are many points of potential dissimilarity between samples of the type described here; however, this variability is reduced when well-homogenized composite samples are analyzed. In intensive studies, replicate samples should be collected at each sampling site (see Section 6.1.2.7). Although the primary purpose of replicate field samples in intensive studies is to allow more reliable estimates of the magnitude of contamination, extreme variability in the results of these samples may also indicate that sampling and/or analysis procedures are not adequately controlled.

8.3.3.6 Routine Monitoring of Interferences and Contamination—

Because contamination can be a limiting factor in the reliable quantitation of target contaminants in tissue samples, the recommendations for proper materials and handling and cleaning procedures given in Sections 6.2.2 and 7.2 should be followed carefully to avoid contamination of samples in the field and laboratory.

8. LABORATORY PROCEDURES II — SAMPLE ANALYSES

Many metal contamination problems are due to airborne dust. High zinc blanks may result from airborne dust or galvanized iron, and high chromium and nickel blanks often indicate contamination from stainless steel. Mercury thermometers should not be used in the field because broken thermometers can be a source of significant mercury contamination. In the laboratory, samples to be analyzed for mercury should be isolated from materials and equipment (e.g., polarographs) that are potential sources of mercury contamination. Cigarette smoke is a source of cadmium. Consequently, care should be taken to avoid the presence of cigarette smoke during the collection, handling, processing, and analysis of samples for cadmium. In organic analyses, phthalates, methylene chloride, and toluene are common laboratory contaminants that are often detected in blanks at concentrations above the MDL (U.S. EPA, 1987e).

Cross-contamination between samples should be avoided during all steps of analysis of organic contaminants by GC-based methods. Injection micro-syringes must be cleaned thoroughly between uses. If separate syringes are used for the injection of solutions, possible differences in syringe volumes should be assessed and, if present, corrected for. Particular care should be taken to avoid carryover when high- and low-level samples are analyzed sequentially. Analysis of an appropriate method blank may be required following the analysis of a high-level sample to assess carryover (U.S. EPA, 1987e).

To monitor for interferences and contamination, the following blank samples should be analyzed prior to beginning sample collection and analyses and on a routine basis throughout each study (U.S. EPA, 1987e):

- **Field blanks** are rinsates of empty field sample containers (i.e., aluminum foil packets and plastic bags) that are prepared, shipped, and stored as actual field samples. Field blanks should be analyzed to evaluate field sample packaging materials as sources of contamination. Each rinsate should be collected and the volume recorded. The rinsate should be analyzed for target analytes of interest and the total amount of target analyte in the rinsate recorded. It is recommended that one field blank be analyzed with every 20 samples or with each batch of samples, whichever is more frequent.
- **Processing blanks** are rinsates of utensils and equipment used for dissecting and homogenizing fish and shellfish. Processing blanks should be analyzed, using the procedure described above for field blanks, to evaluate the efficacy of the cleaning procedures used between samples. It is recommended that processing blanks be analyzed at least once at the beginning of a study and preferably once with each batch of 20 or fewer samples.
- **Bottle blanks** are rinsates of empty bottles used to store and ship sample homogenates. Bottle blanks should be collected after the bottles are cleaned prior to use for storage or shipment of homogenates. They should be analyzed, using the procedure described above for field blanks, to evaluate their potential as sources of contamination. It is recommended that one bottle

8. LABORATORY PROCEDURES II — SAMPLE ANALYSES

blank be analyzed for each lot of bottles or with each batch of 20 or fewer samples, whichever is more frequent.

- **Method blanks** are samples of extraction or digestion solvents that are carried through the complete analytical procedure, including extraction or digestion; they are also referred to as **procedural blanks**. Method blanks should be analyzed to evaluate contaminants resulting from the total analytical method (e.g., contaminated glassware, reagents, solvents, column packing materials, processing equipment). It is recommended that one method blank be analyzed with every 20 samples or with each batch of samples, whichever is more frequent.
- **Reagent blanks** are samples of reagents used in the analytical procedure. It is recommended that each lot of analytical reagents be analyzed for target analytes of interest prior to use to prevent a potentially serious source of contamination. For organic analyses, each lot of alumina, silica gel, sodium sulfate, or Florasil used in extract drying and cleanup should also be analyzed for target analyte contamination and cleaned as necessary. Surrogate mixtures used in the analysis of organic target analytes have also been found to contain contaminants and the absence of interfering impurities should be verified prior to use (U.S. EPA, 1987e).

Because the contamination in a blank sample may not always translate into contamination of the tissue samples, analysts and program managers must use their best professional judgment when interpreting blank analysis data. Ideally, there should be no detectable concentration of any target analyte in any blank sample (i.e., the concentration of target analytes in all blanks should be less than the MDL). However, program managers may set higher control limits (e.g., \leq MQL) depending on overall data quality requirements of the monitoring program. If the concentration of a target analyte in any blank is greater than the established control limit, all steps in the relevant sample handling, processing, and analysis procedures should be reviewed to identify the source of contamination and appropriate corrective action should be taken. If there is sufficient sample material, all samples associated with the unacceptable blank should be reanalyzed. If reanalysis is not possible, all suspect data should be identified clearly.

Note: Analytical data should not be corrected for blank contamination by the reporting laboratory; however, blank concentrations should always be reported with each associated sample value.

8.3.3.7 Special QA and QC Procedures for the Analysis of Organic Target Analytes—

8.3.3.7.1 Routine monitoring of method performance

To account for losses during sample preparation (i.e., extraction, cleanup) and to monitor overall method performance, a standard compound that has chemical and physical properties as similar as possible to those of the target analyte of interest should be added to each sample prior to extraction and to each calibration standard. Such compounds may be termed **surrogate recovery standards**. A stable, **isotopically labeled analog of the target analyte** is an ideal surrogate recovery standard for GC/MS analysis.

If resources permit, an isotope dilution GC/MS technique such as EPA Method 1625 (40 CFR 136, Appendix A) is recommended for the analysis of organic target analytes for which isotopically labeled analogs are available. In this technique, RRFs used for quantitation may be calculated from measured isotope ratios in calibration standards and not from instrument internal standards. However, an instrument internal standard still must be added to the final sample extract prior to analysis to determine the percent recoveries of isotopically labeled recovery standards added prior to extraction. Thus, in isotope dilution methods, instrument internal standards may be used only for QC purposes (i.e., to assess the quality of data) and not to quantify analytes. Control limits for the percent recovery of each isotopically labeled recovery standard should be established by the program manager, consistent with program data quality requirements. Control limits for percent recovery and recommended corrective actions given in EPA Method 1625 (40 CFR 136, Appendix A) should be used as guidance.

If isotopically labeled analogs of target analytes are not available or if the isotope dilution technique cannot be used (e.g., for chlorinated pesticides and PCBs analyzed by GC/ECD), other surrogate compounds should be added as recovery standards to each sample prior to extraction and to each calibration standard. These surrogate recovery standards should have chemical and physical properties similar to the target analytes of interest and should not be expected to be present in the original samples. Recommended surrogate recovery standards are included in the methods referenced in Table 8-2 and in EMMI (U.S. EPA, 1991f).

Samples to which surrogate recovery standards have been added are termed **surrogate spikes**. The percent recovery of each surrogate spike (% R_s) should be determined for all samples as follows:

$$\% R_s = 100 (C_m/C_a) \quad (8-10)$$

where

- % R_s = Surrogate spike percent recovery
- C_m = Measured concentration of surrogate recovery standard

C_a = Actual concentration of surrogate recovery standard added to the sample.

Control limits for the percent recovery of each surrogate spike should be established by the program manager consistent with program data quality requirements. The control limits in the most recent EPA CLP methods (U.S. EPA, 1991c) are recommended for evaluating surrogate recoveries.

Note: Reported data should not be corrected for percent recoveries of surrogate recovery standards. Recovery data should be reported for each sample to facilitate proper evaluation and use of the analytical results.

8.3.3.7.2 Other performance evaluation procedures

The following additional procedures are required to evaluate the performance of GC-based analytical systems prior to the routine analysis of field samples (U.S. EPA, 1989c; U.S. EPA, 1991c). It is the responsibility of each program manager to determine specific evaluation procedures and control limits appropriate for their data quality requirements.

Evaluation of the GC system

GC system performance should be evaluated by determining the number of theoretical plates of resolution and the relative retention times of the internal standards.

Column Resolution: The number of theoretical plates of resolution, N , should be determined at the time the calibration curve is generated (using chrysene- d_{10}) and monitored with each sample set. The value of N should not decrease by more than 20 percent during an analysis session. The equation for N is given as follows:

$$N = 16 (RT/W)^2 \quad (8-11)$$

where

RT = Retention time of chrysene- d_{10} (s)

W = Peak width of chrysene- d_{10} (s).

Relative Retention Time: Relative retention times of the internal standards should not deviate by more than ± 3 percent from the values calculated at the time the calibration curve was generated.

If the column resolution or relative retention times are not within the specified control limits, appropriate corrective action (e.g., adjust GC parameters, flush GC column, replace GC column) should be taken.

Evaluation of the MS system

The performance of the mass spectrometer should be evaluated for sensitivity and spectral quality.

Sensitivity: The signal-to-noise value should be at least 3.0 or greater for m/z 198 from an injection of 10 ng decafluorotriphenylphosphine (DFTPP).

Spectral Quality: The intensity of ions in the spectrum of a 50-ng injection of DFTPP should meet the following criteria (U.S. EPA, 1991c):

<u>m/z</u>	<u>Criteria</u>
51	30-80% mass 198
68	<2% mass 69
69	present
70	<2% mass 69
127	25-75% mass 198
197	<1% mass 198
198	base peak, 100% relative abundance
199	5-9% mass 198
275	10-30% mass 198
365	>0.75% mass 198
441	present and <mass 443
442	40-110% mass 198
443	15-24% mass 442

If the control limits for sensitivity or spectral quality are not met, appropriate corrective action (e.g., clean MS, retune MS) should be taken.

Evaluation of cleanup columns

Because the fatty content of many tissue samples may overload the cleanup columns, these columns should be calibrated and monitored regularly to ensure that target analytes are consistently collected in the proper fraction. Gel permeation columns should be monitored by visual inspection (for column discoloration, leaks, cracks, etc.) and by measurement of flow rate, column resolution, collection cycle, and method blanks (see Section 8.3.3.6). Silica gel columns should be evaluated by their ability to resolve cholesterol from a selected target analyte.

8.3.3.8 External QA Assessment of Analytical Performance—

Participation in an external QA program by all analytical laboratories in state fish and shellfish consumption advisory programs is strongly recommended for several reasons:

- To demonstrate laboratory capability prior to conducting routine analyses of field samples
- To provide an independent ongoing assessment of each laboratory's capability to perform the required analyses
- To enhance the comparability of data between states and Regions.

Two types of external QA programs are recommended: **round-robin interlaboratory comparisons** (often referred to as **interlaboratory calibration programs**) and **split-sample interlaboratory comparisons**.

8.3.3.8.1 Round-robin analysis interlaboratory comparison program

At present, the only external round-robin QA program available for analytical laboratories conducting fish and shellfish tissue analyses for environmental pollutants is administered by NOAA in conjunction with its National Status and Trends (NS&T) Program (Cantillo, 1991). This QA program has been designed to ensure proper documentation of sampling and analysis procedures and to evaluate both the individual and collective performance of participating laboratories. Recently, NOAA and EPA have agreed to conduct the NS&T Program and the EMAP-NC Program as a coordinated effort. As a result, EMAP-NC now cosponsors and cooperatively funds the NS&T QA Program, and the interlaboratory comparison exercises include all EMAP-NC laboratories (U.S. EPA, 1991e).

Note: Participation in the NS&T QA program by all laboratories performing chemical analyses for state fish and shellfish contaminant monitoring programs is recommended to enhance the credibility and comparability of analytical data among the various laboratories and programs.

Each laboratory participating in the NS&T QA program is required to demonstrate its analytic capability prior to the analysis of field samples by the blind analysis of a fish and shellfish tissue sample that is uncompromised, homogeneous, and contains the target analytes of interest at concentrations of interest. A laboratory's performance generally will be considered acceptable if its reported results are within ± 30 percent (for organics) and ± 15 percent (for metals) of the actual or certified concentration of each target analyte in the sample (U.S. EPA, 1991e). If any of the results exceed these control limits, the laboratory will be required to repeat the analysis until all reported results are within the control limits. Routine analysis of field samples will not be allowed until initial demonstration of laboratory capability is acceptable.

Following the initial demonstration of laboratory capability, each participating laboratory is required to participate in one intercomparison exercise per year as a continuing check on performance. This intercomparison exercise includes both organic and inorganic (i.e., trace metals) environmental and standard reference

samples. The organic analytical intercomparison program is coordinated by NIST, and the inorganic analytical intercomparison program is coordinated by the NRCC. Sample types and matrices vary yearly. Performance evaluation samples used in the past have included accuracy-based solutions, sample extracts, and representative matrices (e.g., tissue or sediment samples). Laboratories are required to analyze the performance evaluation samples blind and to submit their results to NIST or NRCC, as instructed. Individual laboratory performance is evaluated against the consensus values (i.e., grand means) of the results reported by all participating laboratories. Laboratories that fail to achieve acceptable performance must take appropriate corrective action. NIST and NRCC will provide technical assistance to participating laboratories that have problems with the intercomparison analyses. At the end of each calendar year, the results of the intercomparison exercises are reviewed at a workshop sponsored by NIST and NRCC. Representatives from each laboratory are encouraged to participate in these workshops, which provide an opportunity for discussion of analytical problems encountered in the intercomparison exercises.

Note: Nonprofit laboratories (e.g., EPA and other federal laboratories, state, municipal, and nonprofit university laboratories) may participate in the NS&T QA program at no cost on a space-available basis. The cost of participation in the NIST Intercomparison Exercise Program for Organic Contaminants in the Marine Environment is \$2,500 for private laboratories within and outside the United States. This cost covers samples for one exercise per year. Samples may be obtained directly from NIST by contacting Ms. Michele Shantz, NIST, 100 Bureau Drive, Stop 8392, Gaithersburg, MD 20899-8392; Tel: 301-975-3106, FAX: 301-997-0685. Trace inorganic samples are available directly from NRCC by contacting Mr. Scott Willis, NRCC, Ottawa, Ontario, Canada K1A029, e-mail: scott.willie@NRC.CA, Tel: 613-993-4969.

To obtain additional information about participation in the NS&T QA program, contact Dr. Adriana Cantillo, QA Manager, NOAA/National Status and Trends Program, NYSCI1, 1305 East West Highway, Silver Spring, MD 20910; Tel: 301-713-3028, ext. 147, FAX: 301-713-4388.

8.3.3.8.2 Split sample analysis interlaboratory comparison programs

Another useful external QA procedure for assessing interlaboratory comparability of analytical data is a split-sample analysis program in which a percentage (usually 5 to 10 percent) of all samples analyzed by each state or Region are divided and distributed for analyses among laboratories from other states or Regions. Because actual samples are used in a split-sample analysis program, the results of the split-sample analyses provide a more direct assessment of the comparability of the reported results from different states or Regions.

The NS&T QA program does not include an interlaboratory split-sample analysis program. However, it is recommended that split-sample analysis programs be established by states and/or Regions that routinely share results.

8.4 Documentation and Reporting of Data

The results of all chemical analyses must be documented adequately and reported properly to ensure the correct evaluation and interpretation of the data.

8.4.1 Analytical Data Reports

The documentation of analytical data for each sample should include, at a minimum, the following information:

- Study identification (e.g., project number, title, phase)
- Description of the procedure used, including documentation and justification of any deviations from the standard procedure
- Method detection and quantitation limits for each target analyte
- Method accuracy and precision for each target analyte
- Discussion of any analytical problems and corrective action taken
- Sample identification number
- Sample weight (wet weight)
- Final dilution volume/extract volume
- Date(s) of analysis
- Identification of analyst
- Identification of instrument used (manufacturer, model number, serial number, location)
- Summary calibration data, including identification of calibration materials, dates of calibration and calibration checks, and calibration range(s); for GC/MS analyses, include DFTPP spectra and quantitation report
- Reconstructed ion chromatograms for each sample analyzed by GC/MS
- Mass spectra of detected target compounds for each sample analyzed by GC/MS
- Chromatograms for each sample analyzed by GC/ECD and/or GC/FID
- Raw data quantitation reports for each sample

8. LABORATORY PROCEDURES II — SAMPLE ANALYSES

- Description of all QC samples associated with each sample (e.g., reference materials, field blanks, rinsate blanks, method blanks, duplicate or replicate samples, spiked samples, laboratory control samples) and results of all QC analyses. QC reports should include quantitation of all target analytes in each blank, recovery assessments for all spiked samples, and replicate sample summaries. Laboratories should report all surrogate and matrix spike recovery data for each sample; the range of recoveries should be included in any reports using these data.
- Analyte concentrations with reporting units identified (as ppm or ppb wet weight, to two significant figures unless otherwise justified). **Note:** Reported data should not be recovery- or blank-corrected.
- Lipid content (as percent wet weight)
- Specification of all tentatively identified compounds (if requested) and any quantitation data.
- Data qualifications (including qualification codes and their definitions, if applicable, and a summary of data limitations).

To ensure completeness and consistency of reported data, standard forms should be developed and used by each laboratory for recording and reporting data from each analytical method. Standard data forms used in the EPA Contract Laboratory Program (U.S. EPA, 1991b, 1991c) may serve as useful examples for analytical laboratories.

All analytical data should be reviewed thoroughly by the analytical laboratory supervisor and, ideally, by a qualified chemist who is independent of the laboratory. In some cases, the analytical laboratory supervisor may conduct the full data review, with a more limited QA review provided by an independent chemist. The purpose of the data review is to evaluate the data relative to data quality specifications (e.g., detection and quantitation limits, precision, accuracy) and other performance criteria established in the Work/QA Project Plan. In many instances, it may be necessary to qualify reported data values; qualifiers should always be defined clearly in the data report. Recent guidance on the documentation and evaluation of trace metals data collected for Clean Water Act compliance monitoring (U.S. EPA, 1995h) provides additional useful information on data review procedures.

8.4.2 Summary Reports

Summaries of study data should be prepared for each target species at each sampling site. Specific recommendations for reporting data for screening and intensive studies are given in Section 9.2.

SECTION 9

DATA ANALYSIS AND REPORTING

This section provides guidance on (1) analysis of laboratory data for both screening and intensive studies that should be included in state data reports, (2) data reporting requirements for both state-conducted screening and intensive studies, and (3) data reporting requirements for a national data repository for state-collected fish tissue data housed within the National Listing of Fish and Wildlife Advisories (NLFWA) database.

All data analysis and reporting procedures should be documented fully as part of the Work/QA Project Plan for each study, prior to initiating the study (see Appendix I). All routine data analysis and reporting procedures should be described in standard operating procedures. In particular, the procedures to be used to determine if the concentration of a target analyte in fish or shellfish tissue differs significantly from the selected screening value must be clearly documented.

9.1 DATA ANALYSIS

9.1.1 Screening Studies

The primary objective of **Tier 1** screening studies is to assist states in identifying potentially contaminated harvest areas where further investigation of fish and shellfish contamination may be warranted. The criteria used to determine whether the measured target analyte concentration in a fish or shellfish tissue composite sample is different from the SV (greater than or less than) should be clearly documented. If a reported target analyte concentration exceeds the SV in the screening study, a state should initiate a **Tier 2, Phase I**, intensive study (see Section 6.1.2.1) to verify the level of contamination in the target species. Because of resource limitations, some states may choose to conduct a risk assessment using screening study data; however, this approach is not recommended because a valid statistical analysis cannot be performed on a single composite sample. If a reported analyte concentration is close to the SV but does not exceed the SV, the state should reexamine historic data on water, sediment, and fish tissue contamination at the site and evaluate data on laboratory performance. If these data indicate that further examination of the site is warranted, the state should initiate a **Tier 2, Phase I**, intensive study to verify the magnitude of the contamination.

Because replicate composite samples are not required as part of a screening study, estimating the variability of the composite target analyte concentration at any site is precluded. The following procedure is recommended for use by states for analysis of the individual target analyte concentration for each composite sample from reported laboratory data (see Section 8.3.3.3)

- A datum reported below the method detection limit, including a datum reported as not detected (i.e., ND, no observed response) should be assigned a value of one-half the MDL or zero.
- A datum reported between the MDL and the method quantitation limit should be assigned a value of the MDL plus one-half the difference between the MQL and the MDL.
- A datum reported at or above the MQL should be used as reported.

This approach is similar to that published in 40 CFR Parts 122, 123, 131, and 132—Proposed Water Quality Guidance for the Great Lakes System.

If resources permit and replicate composite samples are collected at a suspected site of contamination, then a state may conduct a statistical analysis of differences between the mean target analyte concentration and the SV, as described in Section 9.1.2.

9.1.2 Intensive Studies

The primary objectives of **Tier 2** intensive studies are to confirm the findings of the screening study by assessing the magnitude and geographic extent of the contamination in various size classes of selected target species. The EPA Office of Water recommends that states collect replicate composite samples of three size classes of each target species in the study area to verify whether the mean target analyte concentration of replicate composite samples for any size class exceeds the SV for any target analyte identified in the screening study. The statistical approach for this comparison is described in Section 6.1.2.7.

The following procedure is recommended for use by states in calculating the mean arithmetic target analyte concentration from reported laboratory data (see Section 8.3.3.3.3).

- Data reported below the MDL, including data reported as not detected (i.e., ND, no observed response) should be assigned a value of one-half the MDL.
- Data reported between the MDL and the MQL should be assigned a value of the MDL plus one-half the difference between the MQL and the MDL.
- Data reported at or above the MQL should be used as reported.

This approach is similar to that published in 40 CFR Parts 122, 123, 131, and 132—Proposed Water Quality Guidance for the Great Lakes System.

Secondary objectives that may be assessed as part of **Tier 2** intensive studies

can include defining the geographical region where fish contaminant concentrations exceed screening values; identifying geographical distribution of contaminant concentrations; and, in conjunction with historical data or future data collection, assessing changes in fish contaminant concentrations over time. The statistical considerations involved in comparing fish contaminant levels measured at different locations or times are discussed in Appendix N.

State staff should consult a statistician in interpreting intensive study tissue residue results to determine the need for additional monitoring, risk assessment, and issuance of a fish or shellfish consumption advisory. Additional information on risk assessment, risk management, and risk communication procedures will be provided in later volumes in this guidance series (see Section 1.4).

9.2 DATA REPORTING

9.2.1 State Data Reports

State data reports should be prepared by the fish contaminant monitoring program manager responsible for designing the screening and intensive studies. Summaries of **Tier 1** screening study data should be prepared for each target species sampled at each screening site. For **Tier 2** intensive studies (**Phase I** and **Phase II**), data reports should be prepared for each target species (by size class, as appropriate) at each sampling site within the waterbody under investigation (see Section 6.1.2). Screening and intensive study data reports should include, at a minimum, the information shown in Figure 9-1.

9.2.2 Reports to the National Fish Tissue Residue Data Repository (NFTRDR)

The EPA Office of Science and Technology within the Office of Water has established the NFTRDR, which is housed within the NLFWA database. This repository is a collection of fish and shellfish contaminant monitoring data gathered by various state, federal, and local agencies for advisory purposes. The objectives of the repository are to:

- Facilitate the exchange of fish and shellfish contaminant monitoring data nationally by improving the comparability and integrity of state data
- Encourage greater cooperation among regional and state fish advisory programs
- Assist states in their fish tissue data collection efforts by providing ongoing technical assistance.

The NLFWA database now contains a facility for storing fish tissue residue data as well as for documenting and mapping active and rescinded fish consumption advisories. Since 1996, a stand-alone version of the NLFWA database has been available for Internet downloads. Internet WEB-based tools have recently been developed to support queries and interactive mapping of both the general advisory information as well as fish tissue residue data. Internet-based tools are also being

<ul style="list-style-type: none"> • Study identification (e.g., project number, title, and study type) • Program manager • Sampling site name • Latitude (decimal degrees preferred) • Longitude (decimal degrees preferred) • Type of waterbody (lake, river, estuary, etc.) • Name of waterbody • Sampling date (e.g., YYYYMMDD, Year 2000 compliant format) • Sampling time (e.g., HH, MM in a 24-h format) • Sampling gear type used (e.g., dredge, seine, trawl, gill net) • Sampling depth (feet or meters) • Standard common name of target species (preferably name sanctioned by American Fisheries Society for inland waters or by NOAA for coastal waters) • Composite sample numbers • Number of individuals in each composite sample • Number of replicate composite samples • Predominant characteristics of specimens used in each composite sample <ul style="list-style-type: none"> - Predominant life stage of individuals in composite - Predominant sex of individuals in composite (if applicable) - Average age of individuals in composite (if applicable) - Average body length (cm) - Description of edible portion (tissue type) • Analytical methods used (including method for lipid analysis) • Method detection and quantitation limits for each target analyte analyzed 	<ul style="list-style-type: none"> • Sample cleanup procedures (e.g., additional steps taken to further purify the sample extracts or digestates) • Data qualifiers (e.g., additional qualifying information about the measurement) • Percent lipid (wet weight basis) in each composite sample • For each target analyte in each composite sample: <ul style="list-style-type: none"> - Total wet weight of composite sample (g) used in analysis - Measured concentration (wet weight basis) as reported by the laboratory (see Section 8.3.3.3.3) - Units of measurement for target analyte concentration (e.g., ppm) - Evaluation of laboratory performance (i.e., description of all QA and QC samples associated with the sample(s) and results of all QA and QC analyses) • In screening studies with only one composite sample for each target species, the state should provide for each target analyte a comparison of reported concentration with selected SV (see Section 4 tables) and indication of whether SV was exceeded for recreational or subsistence fishers (see Section 9.1.1). • In intensive studies, for each target analyte in each set of replicate composite samples, the state should provide <ul style="list-style-type: none"> - Range of target analyte concentrations for each set of replicate composite samples - Mean (arithmetic) target analyte concentration for each set of replicate composite samples (see Section 9.1.2) - Standard deviation of mean target analyte concentration - Comparison of target analyte arithmetic mean concentration with selected SV (see Section 5) and indication of whether SV was exceeded for recreational or subsistence fishers
--	--

Figure 9-1. Recommended data reporting requirements for screening and intensive studies.

developed as a way for state agencies to add fish advisory and contaminant monitoring data to the NLFWA database and may be developed to perform some types of standard data analysis on the fish tissue residue data.

EPA has recently developed an Internet-based data entry facility for the NLFWA using some of the data elements included in Figure 9-1. This Internet-based data entry facility is housed within the EPA's NLFWA database and allows states to archive fish advisory information as well as fish tissue residue data generated through their fish contaminant monitoring programs. States may prepare their own data tables and arrange to transfer these to EPA to be formatted and reviewed before entry into the repository. The information in the NFTRDR can be organized into three different tables (STATIONS, SAMPLES, and RESULTS tables) using such readily available PC relational database packages as ACCESS (Figure 9-2). If states submit their monitoring data in other file formats (e.g., spreadsheet files or ASCII files exported from other in-house database systems), a short data dictionary (metadata) file should be included (ASCII, Wordperfect, or WORD format) clearly documenting the meaning of all data fields and any codes, abbreviations, or measurement units used in the files.

State, regional, and local agency staff may obtain further information on the new Internet WEB-based database EPA now has available by contacting:

U.S. Environmental Protection Agency
Office of Science and Technology
National Fish and Wildlife Contamination Program-4305
1200 Pennsylvania Avenue, NW
Washington, DC 20460
PHONE: 202-260-7301
FAX: 202-260-9830

Jeffrey D. Bigler
U.S. Environmental Protection Agency-4305
1200 Pennsylvania Avenue, NW
Washington, DC 20460
PHONE: 202-260-1305
E-MAIL: bigler.jeff@epa.gov

Fish Tissue Chemical Residue Data Tables: STATIONS, SAMPLES and RESULTS	
The STATIONS table includes basic locational data.	
Field name	Field description
STATION_ID	Waterbody, Station or Monitoring Site Identifier. This field becomes a database key field. Each record must have a unique STATION_ID.
STATE	State 2-character postal code abbreviation.
WATERBODY (or SITENAME)	A short caption to identify the waterbody or sampling station.
LOCATION	Additional descriptive information on the waterbody or station location.
ADVNUM	If the waterbody or site is associated with an advisory (active or rescinded), include the number assigned to this advisory in the current National Listing of Fish and Wildlife Advisories (NLFWA) database.
COUNTY	County name.
LAT	Station latitude. A format in decimal degrees is preferred.
LNG	Station longitude. A format in decimal degrees is preferred.
The SAMPLES table includes data on the type of tissue sample collected.	
Field name	Field description
SAMPLE_ID	An identifier to each specific fish tissue sample from a waterbody or station. This is used as a database key, so each record must have a unique SAMPLE_ID
STATION_ID	Waterbody, Station or Monitoring Site Identifier as defined in the STATIONS table.
SAMPLE_DATE	The date the sample was collected in the field. Give date in a Year 2000 compliant format (YYYYMMDD).
FISH_SPECIES	Fish species names. Standard English common names as established by the American Fisheries Society for inland waters or NOAA for coastal water are preferred.
SAMPLE_TYPE	How the sample was prepared (e.g., fillet with skin-on or skin-off, whole fish). In the NUMBER_OF_FISH field below, multiple fish in a sample indicate a composite sample.
LENGTH	The length of the sample fish. For composites, an average length should be given.
LENGTH_UNIT	Length units of fish (cm or inches)
WEIGHT	Specimen or composite weight used for residue analysis.
WEIGHT_UNIT	Weight units (usually in grams).
LIPID	Percent extractable lipids.
NUMBER_OF_FISH	Number of fish (specimens) in sample. Number greater than a value of 1 indicates a composite sample.
The RESULTS table includes chemical-specific tissue sample concentrations.	
Field name	Field description
SAMPLE_ID	An identifier to each specific fish tissue sample from a waterbody or station. This is used as a database key, so each record must have a unique SAMPLE_ID
PARAMETER	Chemical name. File should specify all acronyms or abbreviations used.
DETECTION_INFO	A caption to document detection limit information (e.g., "less than detection limit").
RESULT	A number representing the concentration of a chemical (or the detection limit).
RESULT_UNIT	Units associated with concentration (e.g., "ppm").

Figure 9-2. Key information fields for the National Fish Tissue Residue Data Repository.

SECTION 10

LITERATURE CITED

- Abbott, R.T. 1974. *American Seashells—The Marine Molluscs of the Atlantic and Pacific Coasts of North America*. 2nd Edition. Van Nostrand Reinhold Company, New York, NY.
- Agocs, M.M., R.A. Etzel, R.G. Parrish, D.C. Paschal, P.R. Campagna, D.S. Cohon, E.M. Kilbourne, and J.L. Hesse. 1990. Mercury exposure from interior latex paint. *New England Journal of Medicine* 323(16):1096-1101.
- Amato, J.R., D.I. Mount, E.J., Durhan, et al. 1992. An example of the identification of diazinon as a primary toxicant in an effluent. *Environ. Toxic. Chem.* 11:209-216.
- Anderson, R.O., and S.J. Gutreuter. 1983. Length, weight, and associated structural indices. pp. 283-300. In: *Fisheries Techniques*. L.A. Nielson and D.L. Johnson (eds). American Fisheries Society, Bethesda, MD.
- Ashley, L.M. 1962. *Laboratory Anatomy of the Turtle*. W.C. Brown Company, Dubuque, IA.
- ASTER, 1995. Ecotoxicity profile: Arsenic. Office of Research and Development, National Health and Environmental Effects Research Laboratory, U.S. Environmental Protection Agency, Duluth, MN.
- ASTM (American Society for Testing and Materials). 1976. *ASTM Manual on Presentation of Data and Control Chart Analysis*. ASTM STP-ILSD. Committee E-11, Philadelphia, PA.
- ASTM (American Society for Testing and Materials). 1983. *Standard Practice for Intralaboratory Quality Control Procedures and a Discussion on Reporting Low-Level Data*. D4210-83. Committee D-19, Philadelphia, PA.
- ATSDR (Agency for Toxic Substances and Disease Registry). 1991. *Toxicological Profile for Dieldrin*. U.S. Department of Health and Human Services, Public Health Service, Atlanta, GA.
- ATSDR (Agency for Toxic Substances and Disease Registry). 1992. *Toxicological Profile for Tin and Tin Compounds*. U. S. Department of Health and Human Services, Public Health Service, Atlanta, GA.

- ATSDR (Agency for Toxic Substances and Disease Registry). 1995. *Toxicological Profile for Polycyclic Aromatic Hydrocarbons*. U.S. Department of Health and Human Services, Public Health Service, Atlanta, GA.
- ATSDR (Agency for Toxic Substances and Disease Registry). 1996. *Toxicological Profile for Toxaphene*. U.S. Department of Health and Human Services, Public Health Service, Atlanta, GA.
- ATSDR (Agency for Toxic Substances and Disease Registry). 1997. *Toxicological Profile for Lead*. U.S. Department of Health and Human Services, Public Health Service, Atlanta, GA.
- ATSDR (Agency for Toxic Substances and Disease Registry). 1998a. *Toxicological Profile for Arsenic*. U.S. Department of Health and Human Services, Public Health Service, Atlanta, GA.
- ATSDR (Agency for Toxic Substances and Disease Registry). 1998b. *Toxicological Profile for Selected PCBs*. U.S. Department of Health and Human Services, Public Health Service, Atlanta, GA.
- ATSDR (Agency for Toxic Substances and Disease Registry). 1998c. *Toxicological Profile for Endosulfan (Draft)*. U.S. Department of Health and Human Services, Public Health Service, Atlanta, GA.
- Bache, C.A., W.H. Gutenmann, and D.J. Lisk. 1971. Residues of total mercury and methylmercuric salts in lake trout as a function of age. *Science* 172:951.
- Bahnick, D., C. Sauer, B. Butterworth, and D.W. Kuehl. 1994. A national study of mercury contamination of fish. IV: Analytical methods and results. *Chemosphere* 29(3):537-546.
- Ballschmitter, K., and M. Zell. 1980. Analysis of polychlorinated biphenyls (PCBs) by glass capillary gas chromatography, composition of technical Aroclor- and Clophen-PCB mixtures. *Fresenius Anal. Chem.* 302:20-31.
- Barnes, D.G., and J.S. Bellin. 1989. *Interim Procedures for Estimating Risks Associated with Exposures to Mixtures of Chlorinated Dibenzo-p-Dioxins and -Dibenzofurans (CDDs and CDFs)*. Risk Assessment Forum, U.S. Environmental Protection Agency, Washington, DC.
- Barnes, D.G., and M. Dourson. 1988. Reference dose (RfD): Description and use in health risk assessments. *Regulatory Toxicology and Pharmacology*. 8:471-486.
- Barron, M.G., S. M. Plakas, and P.C. Wilga. 1991. Chlorpyrifos pharmacokinetics and metabolism following intravascular and dietary administration in channel catfish. *Toxicol. Appl. Pharmacol.* 108:474-482.

- Battelle Memorial Institute. 1975. *Environmental Impact Monitoring of Nuclear Power Plants: Source Book of Monitoring Methods*. Volume 2. Atomic Industrial Forum, Inc., Washington, DC.
- Battelle Memorial Institute. 1989. *Work/Quality Assurance Project Plan for the National Status and Trends Mussel Watch Program. Collection of Bivalve Molluscs and Superficial Sediments for Coastal U.S. Atlantic and Pacific Locations and Analyses for Organic Chemicals and Toxic Trace Elements*. Prepared for U.S. Department of Commerce, National Oceanic and Atmospheric Administration by Battelle Ocean Sciences, Duxbury, MA.
- Battelle New England Marine Research Laboratory. 1986. *Phase II Mussel Watch Field Manual*. NOAA Contract No. 50-DGNC-5-0263. Prepared for U.S. Department of Commerce, National Oceanic and Atmospheric Administration by Battelle Ocean Sciences, Duxbury, MA.
- Beauchemin, D., K.W.M. Siu, J.W. McLaren, and S.S. Berman. 1989. Determination of arsenic species by high-performance liquid chromatography-inductively coupled plasma mass spectrometry. *Journal of Analytical Atomic Spectrometry* 4 (3):285-289.
- Benkert, K.A. 1992. *Contaminant Assessment of Biota and Sediments in the Albemarle-Pamlico Region*. Contract 40190-0-6823. Prepared for U.S. Fish and Wildlife Service, Raleigh, NC.
- Bennett, G.W. 1970. *Management of Lakes and Ponds*. Van Nostrand Reinhold Company, New York, NY.
- Besser, J.M., J.P. Giesy, R.W. Brown, J.M. Buell, and G.A. Dawson. 1996. Selenium bioaccumulation and hazards in a fish community affected by coal fly ash effluent. *Ecotox. and Environ. Safety* 35:7-15.
- Bishop, C.A., P. Ng, R.J. Norstrom, R.J. Brooks, and K. E. Pettit. 1996. Temporal and geographic variation of organochlorine residues in eggs of the common snapping turtle (*Chelydra serpentina serpentina*) (1981-1991) and comparisons to trends in the herring gull (*Larus argentatus*) in the Great Lakes basin in Ontario, Canada. *Arch. Environ. Contam. Toxicol.* 31: 512-524.
- Bligh, E.G., and W.J. Dyer. 1959. A rapid method of total lipid extraction and purification. *Can. J. Biochem. Physiol.* 37:911-917.
- Bloom, N.S. 1992. On the chemical form of mercury in edible fish and marine invertebrate tissue. *Can. J. Fish. Aquat. Sci.* 49(5):1010-1017.

- Bonin, J., L. DesGranges, C.A. Bishop, J. Rodrigue, A. Gendron, and J.E. Elliot. 1995. Comparative study of contaminants in the mudpuppy (*Amphibia*) and the common snapping turtle (*Reptilia*), St. Lawrence River, Canada. *Arch. Environ. Contam. Toxicol.* 28:184-194.
- Borneff, J., and H. Kunte. 1965. Carcinogenic substances in water and soil. Part XVII. Concerning the origin and estimation of the polycyclic aromatic hydrocarbons in water. *Arch. Hyg. (Berlin)* 149:226-243.
- Bos, P.M.J., J.M. Cardinaals, W.M.F. Jongen, and P. Hagel. 1985. Genotoxicity testing of arsenobetaine, the predominant form of arsenic in marine fishery products. *Food and Chem. Toxicol.* 23(7):669.
- Branch, S., L. Ebdon, and P. O'Neill. 1994. Determination of arsenic species in fish by directly coupled high-performance liquid chromatography-inductively coupled plasma mass spectrometry. *J. Anal. Atomic Spec.* 9:33.
- Broutman, M.A., and D.L. Leonard. 1988. *The Quality of Shellfish Growing Waters in the Gulf of Mexico*. Strategic Assessment Branch, National Oceanic and Atmospheric Administration, U.S. Department of Commerce, Rockville, MD.
- Brown, R.M., D. Newton, C.J. Pickford, et al. 1990. Human metabolism of arsenobetaine ingested with fish. *Hum. Exp. Toxicol.* 9:41-46.
- Bryan, A.M., W.B. Stone, and P.G. Olafsson. 1987. Disposition of toxic PCB congeners in snapping turtle eggs: expressed as toxic equivalents of TCDD. *Bull. Environ. Contam. Toxicol.* 39(5):791-796.
- Bryce, F., S.M. Charbonneau, E. Sandi, and G.K. Tam. 1982. Excretion of a single oral dose of fish-arsenic in man. *Bull. Environ. Contam. Toxicol.* 28(6):669-673.
- Burkhard, L.P., and J.J. Jensen. 1993. Identification of ammonia, chlorine and diazinon as toxicants in a municipal effluent. *Arch. of Environ. Chem.* 25:506-515.
- Cagle, F.R. 1946. The growth of the slider turtle, *Pseudemys scripta elegans*. *Am. Midl. Nat.* 35:685-729.
- Cagle, F.R. 1948. Growth of turtles in Lake Glendale, Illinois. *Copeia* 3:197-203.
- Cagle, F.R. 1950. The life history of the slider turtle, *Pseudemys scripta troostii* (Holbrook). *Ecol. Monogr.* 20:31-54.

- California Department of Fish and Game. 1990. *Laboratory Quality Assurance Program Plan*. Environmental Services Division, Sacramento, CA.
- Cannon, J.R., J.B. Saunders, and R.F. Toia. 1983. Isolation and preliminary toxicological evaluation of arsenobetaine—the water-soluble arsenical constituent from the hepatopancreas of the western rock lobster. *Sci. Total Environ.* 31:181-185.
- Cantillo, A.Y. 1991. Reference materials for marine science. *Sea Tech.* May:45-47.
- Capuzzo, J.M., J.W. Farrington, G.T. Wallace, and A.E. McElroy. 1990. *Chemical Contaminants in Fish and Shellfish: Development of Uniform Testing and Reporting Standards*. Project No. NA89-EA-D-00014. Prepared for National Oceanic and Atmospheric Administration. Woods Hole Oceanographic Institution, Woods Hole, MA.
- Carlander, K.D. 1969. *Handbook of Freshwater Fishes of the United States and Canada*. 3rd Ed. Iowa State University Press, Ames, IA.
- Castanet, J. 1974. Etude histologique des marques squelettiques de croissance chez *Vipera aspis* (L.) (Ophidia, Viperidae). *Zool Scr* 3:137-151.
- Castanet, J. 1987. La squelettochronologie chez les reptiles. III. Applications. *Ann Sci Nat Zool Paris* 8:157-172.
- Castanet, J. 1994. Age estimation and longevity in reptiles. *Gerontology* 40:174-192.
- Castanet, J., H. Francillon-Vieillot, F.J. Meunier, and A. de Ricqlès. 1993. Bone and individual aging. In *Bone, Volume 7 - Bone Growth*. B.K. Hall (ed.). CRC Press, Boca Raton, Florida. pp. 245-283.
- Charbonneau, S.M., K. Spencer, F. Bryce, and E. Sandi. 1978. Arsenic excretion by monkeys dosed with arsenic-containing fish or with inorganic arsenic. *Bull. Environ. Contam. Toxicol.* 20(4):470-477.
- Cochran, W.G. 1963. *Sampling Techniques*. John Wiley & Sons, New York, NY.
- Cochran, W.G. 1977. *Sampling Techniques*. John Wiley & Sons, New York, NY.
- Cogliano, J.V. 1998. Assessing cancer risks from environmental PCBs. *Environ. Health Perspec.* 106 (6):317-323.
- Conant, R., and J.T. Collins. 1991. *A Field Guide to Reptiles and Amphibians of Eastern/Central North America*. 2nd Edition. Peterson Field Guide Series. Houghton Mifflin Company, Boston, MA.

- Crawford, J.K., and S.N. Luoma. 1993. *Guidelines for Studies of Contaminants in Biological Tissues for the National Water-Quality Assessment Program*. USGS Open-File Report 92-494. U.S. Geological Survey, Lemoyne, PA.
- Creelius, E.D. 1978. Modification of the arsenic speciation technique using hydride generation. *Anal. Chem* 50(6):826-827.
- Creelius, E.A., N.S. Bloom, C.E. Cowan, and E.A. Jenne. 1986. *Speciation of Selenium and Arsenic in Natural Waters and Sediments. Vol. 2: Arsenic Speciation*. EPRI report #EA-4641.
- Creelius, E.A. 1999. Battelle Pacific NW Labs, Sequim, WA. Personal communication.
- Crump, K.S., D.G. Hoel, C.H. Langley, and R. Peto. 1976. Fundamental carcinogenic processes and their implications for low dose risk assessment. *Cancer Res.* 36:2973-2979.
- Cullen, W.R., and K.J. Reimer. 1989. Arsenic speciation in the environment. *Chem. Rev.* 89:713-764.
- Cullen, W.R., G.K. Eigendorf, B.U. Nwata, and A. Takatsu. 1990. The quantitation of butyltin and cyclohexyltin compounds in the marine environment of British Columbia. *Appl. Organometal. Chem.* 4:581-590.
- Cunningham, P.A. 1979. The use of bivalve molluscs in heavy metal pollution research: In *Marine Pollution: Functional Responses*. W.B. Vernberg, F.P. Thurberg, A. Calabrese and F.J. Vernberg (eds.). Academic Press, New York, NY.
- Cunningham, P.A. 1998. Summary of state responses to the 1997 Listing of Fish and Wildlife Advisories (LFWA) questionnaire. Prepared for the Office of Science and Technology, Office of Water, Washington DC. March 1998.
- Cunningham, P.A., J.M. McCarthy, and D. Zeitlin. 1990. *Results of the 1989 Census of State Fish/Shellfish Consumption Advisory Programs*. Prepared for Assessment and Watershed Protection Division, Office of Water Regulations and Standards, U.S. Environmental Protection Agency. Research Triangle Institute, Research Triangle Park, NC.
- Cunningham, P.A., and E. Sullivan. 1999. Summary of state responses to the 1998 National Listing of Fish and Wildlife Advisories (NLFWA) questionnaire. Prepared for the Office of Science and Technology, Office of Water, Washington DC. June 1999.

- Cunningham, P.A., and C.O. Whitaker. 1989. *A Survey of the Status of Biomonitoring in State NPDES and Nonpoint Source Monitoring Programs*. Prepared for the Office of Policy, Planning, and Evaluation, U.S. Environmental Protection Agency. Research Triangle Institute, Research Triangle Park, NC.
- Czapla, T.C., M.E. Pattillo, D.M. Nelson, and M.E. Monaco. 1991. *Distribution and Abundance of Fishes and Invertebrates in Central Gulf of Mexico Estuaries*. ELMR Report No. 7. Strategic Assessment Branch, National Oceanic and Atmospheric Administration, U.S. Department of Commerce, Rockville, MD.
- Daly, R., V.A. Hacker, and L. Wiegart. 1962. *The Lake Trout—Its Life History, Ecology, and Management*. Wisconsin Conservation Department Publication 233. Madison, Wisconsin.
- Dawson, V.K., W.H. Gingerich, R.A. Davis, and P.A. Gilderhus. 1991. Rotenone persistence in freshwater ponds: Effects of temperature and sediment adsorption. *North American Journal of Fisheries Management* 11:226-231.
- Demesmay, C., M. Olle, and M. Porthault. 1994. Arsenic speciation by coupling high-performance liquid chromatography with inductively coupled plasma mass spectrometry. *Presenius J. Anal. Chem.* 348:205-210.
- Dobie, J.L. 1971. Reproduction and growth in the alligator snapping turtle, *Macrolemys temmincki* (Troost). *Copeia* 4:645-658.
- Driscoll, C.T., C. Yan, C.L. Scholfield, R. Munson, and J. Holsapple. 1994. The mercury cycle and fish in the Adirondack lakes. *Environ. Sci. Technol.* 28 (3):136-143.
- Dunn, W.J., III, D.L. Stallings, T.R. Schwartz, J.W. Hogan, J.D. Petty, E. Johanson, and S. Wold. 1984. Pattern recognition for classification and determination of polychlorinated biphenyls in environmental samples. *Anal. Chem.* 56:1308-1313.
- Durfee, R.L., G. Contos, F.C. Whitmore, J.D. Borden, E.E. Hackman, and R.A. Westin. 1976. *PCBs in the United States; Industrial Use and Environmental Distributions*. Office of Toxic Substances, U.S. Environmental Protection Agency, Washington, DC.
- Duston, N.M., C.A. Batdorf, and J.P. Schwartz. 1990. *Progress Report: Metal Concentrations in Marine Fish and Shellfish from Boston and Salem Harbors, and Coastal Massachusetts*. Executive Office of Environmental Affairs, Department of Fisheries, Wildlife, and Environmental Law Enforcement, Division of Marine Fisheries, Salem, MA.

- Ebdon, L., K. Evans, and S. Hill. 1989. The accumulation of organotins in adult and seed oysters from selected estuaries prior to the introduction of U.K. regulations governing the use of tributyltin-based antifouling paints. *Sci. Total Environ.* 83(1-2):63-84.
- Edmonds, J.S., and K.A. Francesconi. 1987. Transformations of arsenic in the marine environment. *Experientia* 43:553-557.
- Edmonds, J.S., and K.A. Francesconi. 1993. Arsenic in seafoods: Human health aspects and regulations. *Mar. Pollution Bull.* 26(12):665-674.
- Eisler, R. 1986. *Polychlorinated Biphenyl Hazards to Fish, Wildlife and Invertebrates: A Synoptic Review*. U.S. Fish and Wildlife Services Biol. Rep. 85(1.7). Patuxent Wildlife Research Center, Laurel, MD. 72 pp.
- Eisler, R. 1987. *Polycyclic Aromatic Hydrocarbon Hazards to Fish, Wildlife and Invertebrates: A Synoptic Review*. U.S. Fish and Wildlife Services Biol. Rep. 85 (1.14). Patuxent Wildlife Research Center, Laurel MD. 134 pp.
- Eisler, R. 1988. Arsenic Hazards to Fish, Wildlife, and Invertebrates: A Synoptic Review. Biological Report 85 (1.12), Contaminant Hazard Reviews, Report No. 12. Fish and Wildlife Service, U.S. Department of the Interior, Laurel, MD.
- Eisler, R. 1989. *Tin Hazards to Fish, Wildlife, and Invertebrates: A Synoptic Review. Contaminant Hazard Reviews. Report #15*. Fish and Wildlife Service, U.S. Department of the Interior, Laurel, MD.
- Emmett, R.L., S.A. Hinton, S.L. Stone, and M.E. Monaco. 1991. *Distribution and Abundance of Fishes and Invertebrates in West Coast Estuaries. Volume II: Life History Summaries*. ELMR Report No. 8. Strategic Assessment Division, National Oceanic and Atmospheric Administration, Rockville, MD.
- Enlow, D.H., and S.O. Brown. 1969. The bone of reptiles. In *Biology of the Reptilia*. C. Gans (ed.). Academic Press, New York. Volume 1, pp. 45-80.
- Erickson, M.D. (ed.). 1991. *Analytical Chemistry of PCBs*. OCLC No. 24542805. Lewis Publishers, Boca Raton, FL.
- Fairey, R., K. Taberski, S. Lamerdin, and M. Petreas. 1997. Organochlorines and other environmental contaminants in muscle tissues of sportfish collected in San Francisco Bay. *Mar. Pollution Bull.* 34(12):1058-1071.
- Frag, A.M., D.F. Woodward, J. N. Goldstein, W. Brumbaugh, and J.S. Meyer. 1998. Concentrations of metals associated with mining waste in sediments, biofilm, benthic macroinvertebrates, and fish from the Coeur D'Alene River Basin, Idaho. *Arch. Environ. Contam. Toxicol.* 34:119-127.

- Farrow, D.R., A.S. Pait, and D.J. Basta. 1989. Targeting pesticide hotspots in estuarine watersheds. In: *Coastal Zone '89, Proceedings of the Sixth Symposium on Coastal and Ocean Management*, Charleston, SC.
- Farm Chemicals Handbook*. 1989. Meister Publishing Company, Willoughby, OH.
- Forsyth, D.S., and C. Cleroux. 1991. Determination of butyltin, methyltin and tetraalkyltin in marine food products with gas chromatography-atomic absorption spectrometry. *Talanta* 38(9):951-957.
- Frazer, N.B., J.L. Greene, and J.W. Gibbons. 1993. Temporal variation in growth rate and age at maturity of male painted turtles, *Chrysemys picta*. *Am. Midl. Nat.* 130:314-324.
- Friberg, L., and D. Vostal (eds.). 1972. *Mercury in the Environment*. The Chemical Rubber Company, CRC Press, Cleveland, OH.
- Frost, D.V. 1967. Arsenicals in biology—retrospect and prospect. *Fed. Proc.* 26:194-208.
- Frye, F.L. 1994. *Reptile Clinician's Handbook: A Compact Clinical and Surgical Reference*. Krieger Publishing Company, Malabar, FL.
- Galbraith, D.A., and R.J. Brooks. 1987. Addition of annual growth lines in adult snapping turtles, *Chelydra serpentina*. *J. Herpetol.* 21:359-363.
- Galtsoff, P.S. 1964. *The American Oyster (Crassostrea virginica Gmelin)*. Fishery Bulletin of the Fish and Wildlife Service, Volume 64. U.S. Department of the Interior, Washington, DC.
- Gardner, A.M., and K.D. White. 1990. Polychlorinated dibenzofurans in the edible portion of selected fish. *Chemosphere* 21 (1-2):215-222.
- George, G. 1987. The current status of the alligator snapping turtle, *Macrolemys temmincki*, with a review of its natural history. In: *Proc. 11th Inter. Herpetol. Symp.* Rosenberg, M. (ed.). pp 75-81.
- Gibbons, J.W. 1968. Population structure and survivorship in the painted turtle, *Chrysemys picta*. *Copeia* 2:260-268.
- Gibbons, J.W. 1976. Aging phenomena in reptiles. In *Special Review of Experimental Aging Research*. M.F. Elias, B.E. Eleftheriou, and P.K. Elias (eds.). Experimental Aging Research, Bar Harbor, Maine. pp. 454-475.
- Gibbons, J.W. 1988. The management of amphibians, reptiles and small mammals in North America: The need for an environmental attitude

- adjustment. *Proc. Symp: Management of Amphibians, Reptiles and Small Mammals in North America*. July 19-21, 1988. Flagstaff, AZ. pp. 4-10.
- Gilbert, R.O. 1987. *Statistical Methods for Environmental Pollution Monitoring*. Van Nostrand Reinhold Company, New York, NY. 320 pp.
- Gingerich, W.H., and J.J. Rach. 1985. Uptake, biotransformation, and elimination of rotenone by bluegills (*Lepomis macrochirus*). *Aquatic Toxicol.* 6:179-196.
- Glaser, J.A., D.L. Forest, G.D. McKee, S. Quave, and W.L. Budde. 1981. Trace analyses for wastewaters. *Environ. Sci. Technol.* 15:1425-1450.
- Glass, G.E., J.A. Sorenson, K.W. Schmidt, and G.R. Rapp. 1990. New source identification of mercury contamination in the Great Lakes. *Environ. Sci. Technol.* 24:1059-1069.
- Goede, R.W., and B.A. Barton. 1990. Organismic indices and an autopsy-based assessment as indicators of health and condition of fish. pp. 93-108. In: *American Fisheries Society Symposium, 8. Biological Indicators of Stress in Fish*. S.M. Adams (ed.) American Fisheries Society, Bethesda, MD.
- Goldstein, R.M., M.E. Brigham, and J.C. Stauffer. 1996. Comparison of mercury concentrations in liver muscle, whole bodies, and composites of fish from the Red River of the North. *Can. J. Fish. Aquat. Sci.* 53: 244-252.
- Golub, M.S., J.M. Donald, and J.A. Reyes. 1991. Reproductive toxicity of commercial PCB Mixtures: LOAELS and NOAELS from animal studies. *Environ. Health Perspect.* 94:245-253.
- Greene, R.W. 1992. *Comparison of Aroclor and Chlorobiphenyl Content in Striped Bass from the Lower Delaware River*. Delaware Department of Natural Resources and Environmental Control, Dover, DE.
- Greene, R.W. 1999. *Chemical Contaminants in Finfish from the Chesapeake and Delaware Canal and Implications to Human Health Risk*. Delaware Department of Natural Resources and Environmental Control, Dover, DE.
- Greenburg, A.E., L.S. Clesceri, and A.D. Eaton (eds.). 1992. *Standard Methods for the Examination of Water and Wastewater*. 18th edition. American Public Health Association and American Water Works Association, Washington, DC. 1268 pp.
- Grimmer, G., H. Bohnke, and H. Borwitzky. 1978. Profile analysis of polycyclic aromatic hydrocarbons in sewage sludge by gas chromatography. *Fresenius Z. Anal. Chem.* 289:91-95.

- Gunderson, D.R., and I.E. Ellis. 1986. Development of a plumb staff beam trawl for sampling demersal fauna. *Fisheries Rev.* 4:35-41.
- Hammer, D.A. 1969. Parameters of a marsh snapping turtle population Lacreek Refuge, South Dakota. *J. Wildl. Manag.* 33:996-1005.
- Hansen, S.H., E.H. Larsen, G. Pritzi, and C. Cornett. 1992. Separation of seven arsenic compounds by high-performance liquid chromatography with on-line detection by hydrogen-argon flame atomic absorption spectrometry and inductively coupled plasma mass spectrometry. *J. Analy. Atomic Spectrom.* 7:629.
- Hardy, J.D., Jr. 1978. *Development of Fishes of the Mid-Atlantic Bight. Volume III Aphredoderidae through Rachycentridae.* U.S. Fish and Wildlife Service, Washington, DC.
- Harris, S.G., and B.L. Harper. 1997. A Native American exposure scenario. *Risk Analysis* 17(6):789-795.
- Harper, B.L., and S.G. Harris. 1999. *Tribal Technical Issues in Risk Reduction Through Fish Advisories.* Joint EPA/American Fisheries Society Meeting. October 15-17, Alexandria, VA.
- Hayes, M.L. 1983. Active capture techniques. In: *Fisheries Techniques.* L.A. Nielsen and D.L. Johnson (eds.). American Fisheries Society, Bethesda, MD. pp. 123-146.
- Hayes, W.J., and E.R. Laws. 1991. *Handbook of Pesticide Toxicology, Vols. 1-3.* Academic Press, Inc., San Diego.
- HEAST (Health Effects Assessment Summary Tables). 1997. *Health Effects Summary Tables.* EPA 540-R-97-036. Office of Solid Waste and Emergency Response, U.S. Environmental Protection Agency, Cincinnati, OH.
- Hebert, C.E., V. Glooschenko, G.D. Haffner, and R. Lazar. 1993. Organic contaminants in snapping turtle (*Chelydra serpentina*) populations from southern Ontario, Canada. *Arch. Environ. Contam. Toxicol.* 24:35-43.
- Hebert, C.E., and K.A. Keenleyside. 1995. To normalize or not to normalize? Fat is the question. *Environ. Toxicol. Chem.* 14(5):801-807.
- Helwig, D.D., and M.E. Hora. 1983. Polychlorinated biphenyl, mercury and cadmium concentrations in Minnesota snapping turtles. *Bull. Contamin. Toxicol.* 30:186-190.

- Henry, K.S., K. Kannan, B.W. Nagy, N.R. Kevern, J.J. Zabik, and J.P. Giesy. 1998. Concentrations and Hazard Assessment of Organochlorine Contaminants and Mercury in Smallmouth Bass from a Remote Lake in the Upper Peninsula of Michigan. *Arch. Environ. Contam. Toxicol.* 34:81-96.
- Hesse, J. 1991. Michigan Department of Public Health. Personal communication.
- Hesse, J.L. 1976. Polychlorinated biphenyl usage and sources of loss to the environment. In: *National Conference on Polychlorinated Biphenyls*. J.L. Buckley et al. (eds.). QV 633 N277c 1975. U.S. Environmental Protection Agency, Washington, DC.
- Hodges, L. 1977. *Environmental Pollution*. Holt, Rinehart and Winston, New York, NY.
- Holder, J.W. 1986. *The Assessment of the Carcinogenicity of Dicofol (Kelthane), DDT, DDE, and DDD (TDE)*. EPA-600/6-86/001. Carcinogen Assessment Group. U.S. Environmental Protection Agency, Office of Pesticide Programs, Washington, DC.
- Holmes, D.D. 1984. *Clinical Laboratory Animal Medicine—An Introduction*. The Iowa State University Press, Ames, IA.
- Hora, M.E. 1981. Reduction of polychlorinated biphenyl (PCB) concentrations in carp (*Cyprinus carpio*) fillets through skin removal. *Bull. Environ. Contamin. Toxicol.* 26: 364-366.
- HSDB (Hazardous Substance Data Bank). 1999. National Library of Medicine. Toxicology Information Program, Bethesda, MD. Please note that 1999 is the year that HSDB was searched and is not necessarily the year that the HSDB file was updated for the specific information. In some cases, the HSDB file update may have occurred many years earlier.
- Hubert, W.A. 1983. Passive capture techniques. pp. 95-122. In: *Fisheries Techniques*. L.A. Nielsen and D.L. Johnson (eds.). American Fisheries Society, Bethesda, MD.
- Huckins, J.N., T.R. Schwartz, J.D. Petty, and L.M. Smith. 1988. Determination, fate, and potential significance of PCBs in fish and sediment with emphasis on selected AHH-inducing congeners. *Chemosphere* 17(10):1995-2016.
- Hueter, R.E., W.G. Fong, G. Henderson, et al. 1995. Methylmercury concentration in shark muscle by species, size, and distribution of sharks in Florida Coastal waters. In: Pocella D.B., and B. Wheatley (eds).

- Mercury as a Global Pollutant*. Proceedings of the Third International Conference, British Columbia, Canada, July 1994. Kluwer Academic Publishers, Boston, MA. pp. 893-399.
- IARC (International Agency for Research on Cancer). 1987. *IARC Monographs on the Evaluation of the Carcinogenic Risk of Chemicals to Humans*. Supplement 7. World Health Organization, Lyon, France.
- IRIS (Integrated Risk Information System). 1999. U.S. Environmental Protection Agency, Washington, DC. <http://www.epa.gov/iris> (Please note that 1999 is the year that IRIS was searched and is not the year that the IRIS file was updated for the specific chemical. In some cases, the IRIS file update may have occurred many years earlier).
- Jacobs, H.L., H.D. Kahn, K.A. Stralka, and B. Phan. 1998. Estimates of per capita fish consumption in the U.S. based on the continuing survey of food intake by individuals (CSFII). *Risk Anal.* 18(3): 283-291.
- Jacobson, S.W., G.G. Fein, J.L. Jacobson, P.M. Schwartz, and J.K. Douter. 1985. The effects of intrauterine PCB exposure on visual recognition memory. *Child Dev.* 56:853-60.
- Jacobson, J.L., S.W. Jacobson, and H.E. Humphrey. 1990. Effects of in utero exposure to polychlorinated biphenyls and related contaminants on cognitive functioning in young children. *J. Pediatrics* 116(1):38-45.
- Jansson, B., and U. Widequist. 1983. Identification of toxaphene (PCC) and chlordane in biological samples by NCI mass spectrometry. *Inter. J. Environ. Analy. Chem.* 13:309-322.
- Jearld, A. 1983. Age determination. In: *Fisheries Techniques*. L.A. Nielsen and D. Johnson (eds.). American Fisheries Society, Bethesda, MD. pp. 301-324.
- Johnson, M.G. 1987. Trace element loadings to sediments of fourteen Ontario lakes and correlation in fish. *Can. J. Fish Aquat. Sci.* 44:3-13.
- Jury, SH., J.D. Field, S.L. Stone, D.M. Nelson, and M.E. Monaco. 1994. *Distribution and Abundance of Fishes and Invertebrates in North Atlantic Estuaries*. ELMR Rep. No. 13. NOAA/NOS Strategic Environmental Assessments Division, Silver Spring, MD.
- Kaise, T., S. Watanabe, and K. Itoh. 1985. The acute toxicity of arsenobetaine. *Chemosphere* 14:1327-1332.
- Kaiser, K.L.E. 1978. The rise and fall of mirex. *Environ. Sci. Technol.* 12:520-528.

- Kannan, N., S. Tanabe, M. Ono, and R. Tatsukawa. 1989. Critical evaluation of polychlorinated biphenyl toxicity in terrestrial and marine mammals: increasing impact of non-ortho and mono-ortho coplanar polychlorinated biphenyls from land to ocean. *Arch. Environ. Contam. Toxicol.* 18(6):850-857.
- Kannan, K., R.G. Smith Jr., R.F. Lee, H.L. Windom, P.T. Heitmuller, J.M. Macauley, J.K. Summers. 1998. Distribution of total mercury and methyl mercury in water, sediment, and fish from south Florida estuaries. *Arch. Environ. Contam. Toxicol.* 34:109-118.
- Keith, L.H. 1991a. Report Results Right! Part 1. *Chemtech* June:352-356.
- Keith, L.H. 1991b. Report Results Right! Part 2. *Chemtech* August:486-489.
- Keith, L.H., W. Crommett, J. Deegan, Jr., R.A. Libby, J.K. Taylor, and G. Wentler. 1983. Principles of environmental analysis. *Analy. Chem.* 55:1426-1435.
- Kidwell, J.M., L.J. Phillips, and G. F. Birchard. 1995. Comparative analyses of contaminant levels in bottom feeding and predatory fish using the National Contaminant Biomonitoring Program Data. *Bull. Environ. Contamin. Tox.* 54:919-923.
- Kimbrough, R.D., and A.A. Jensen. 1989. *Topics in Environmental Health: Halogenated Biphenyls, Terphenyls, Naphthalenes, Dibenzodioxins and Related Products*. Vol. 4, 2nd Edition. Elsevier, North Holland, NY.
- Kish, L. 1965. *Survey Sampling*. John Wiley & Sons, New York, NY.
- Klaassen, C.D., M.D. Amdur, and J. Doull (eds.). 1986. *Casarett and Doull's Toxicology, The Basic Science of Poisons*. 3rd edition. MacMillan Publishing Co., New York, NY.
- Klaassen C.D. (ed.). 1996. *Casarett and Doull's Toxicology, The Basic Science of Poisons*. 5th edition. McGraw-Hill, New York.
- Korach, K.S. P. Sarver, K. Chae, J.A. McLachlan, and J.D. McKinney. 1988. Estrogen receptor-binding activity of polychlorinated hydroxybiphenyls: conformationally restricted structural probes. *Mol. Pharmacol.* 33:120-126.
- Krahn, M.M., L.D. Rhodes, M.S. Myers, L.K. Moore, W.D. MacLeod, and D.C. Malins. 1986. Associations between metabolites of aromatic compounds in bile and the occurrence of hepatic lesions in English sole (*Parophrys vetulus*) from Puget Sound, Washington. *Arch. Environ. Contam. Toxicol.* 15:61-67.

- Krahn, M.M., C.A. Wigren, R.W. Pearce, L.K. Moore, R.G. Bogar, W.D. MacLeod, Jr., S.L. Chan, and D.W. Brown. 1988. *Standard Analytical Procedures for the NOAA National Analytical Facility. New HPLC Cleanup and Revised Extraction Procedures for Organic Contaminants*. NOAA Tech. Memo NMFS F/NWC-153. National Oceanic and Atmospheric Administration, U.S. Department of Commerce, Northwest and Alaska Fisheries Center, Seattle, WA. 52 pp.
- Kubiak, T.J., H.J. Harris, L.M. Smith, T.R. Schwartz, D.L. Stalling, J.A. Trick, L. Sileo, D.E. Docherty, and T.C. Erdman. 1989. Microcontaminants and reproductive impairment of the Forster's tern on Green Bay, Lake Michigan—1983. *Arch. Environ. Contam. Toxicol.* 18(5):706-727.
- Kuehl, D.W., B. Butterworth, and P.J. Marquis. 1994. A national study of chemical residues in fish III: Study results. *Chemosphere* 29 (3): 523-535.
- Kurland, L.T., S.N. Faro, and H. Siedler. 1960. Minamata Disease: The outbreak of a neurological disorder in Minamata, Japan, and its relationship to the ingestion of seafood contaminated by mercuric compounds. *World Neurol.* 1:370-391.
- Kutz, F.W., S.C. Strassman, C. R. Stroup, U.C. Carra, C.C. Leininger, D.L. Watts, and C.M. Sparacino. 1985. The human body burden of mirex in the southeastern United States. *Toxicol. Environ. Health* 15:385-394.
- Lake, J.L., R. McKinney, C.A. Lake, F.A. Osterman, and J. Heltshe. 1995. Comparisons of patterns of polychlorinated biphenyls congeners in water, sediment, and indigenous organisms from New Bedford Harbor, Massachusetts. *Arch. Environ. Contamin. Toxicol.* 29(2):207-220.
- Lamb, T., J.W. Bickham, J.W. Gibbons, M.J. Smolen, and S. McDowell. 1991. Genetic damage in a population of slider turtles (*Trachemys scripta*) inhabiting a radioactive reservoir. *Arch. Environ. Contam. Toxicol.* 20:138-142.
- Legler, J.M. 1960. Natural history of the ornate box turtle, *Terrapene ornata ornata* Agassiz, University of Kansas. *Publ. Mus. Nat. Hist.* 11:527-669.
- Leonard, D.L., M.A. Broutman, and K. E. Harkness. 1989. *The Quality of Shellfish Growing Waters on the East Coast of the United States*. Strategic Assessment Branch, National Oceanic and Atmospheric Administration, U.S. Department of Commerce, Rockville, MD.
- Leonard, D.L., and E.A. Slaughter. 1990. *The Quality of Shellfish Growing Waters on the West Coast of the United States*. Strategic Assessment Branch, National Oceanic and Atmospheric Administration, U.S. Department of Commerce, Rockville, MD.

- Li, M. 1975. Pollution in nation's estuaries originating from the agricultural use of pesticides. In: *Estuarine Pollution Control and Assessment*. Office of Water Planning and Standards, U.S. Environmental Protection Agency, Washington, DC. pp. 451-466.
- Lonky, E., J. Reihman, T. Darvill, J. Mather, and H. Daly. 1996. Neonatal behavioral assessment scale performance in humans influenced by maternal consumption of environmentally contaminated Lake Ontario fish. *J. Great Lakes Res.* 22(2):198-212.
- Lowe, T.P., T.W. May, W.G. Brumbaugh, and D.A. Kane. 1985. National Contaminant Biomonitoring Program: Concentrations of seven elements in freshwater fish, 1978-1981. *Arch. Environ. Contam. and Toxicol.* 14:363-388.
- Lowenstein, G.G., and D.R. Young. 1986. *National Status and Trends Program for Marine Environmental Quality, Benthic Surveillance Project: Cycle III Field Manual*. NOAA Tech. Memorandum NOS OMA 28. National Oceanic and Atmospheric Administration, U.S. Department of Commerce, Rockville, MD.
- Luten, J.R., G. Riekwel-Booy, and A. Rauchbaar. 1982. Occurrence of arsenic in plaice (*Pleuronectes platessa*), nature of organoarsenic compound present and its excretion by man. *Environ. Health Perspect.* 45:165-170.
- Maack, L., and W.C. Sonzogni. 1988. Analysis of polychlorobiphenyl congeners in Wisconsin fish. *Arch. Environ. Toxicol.* 17(6):711-719.
- MacKenzie, M.J., and J.V. Hunter. 1979. Sources and fates of aromatic compounds in urban stormwater runoff. *Environ. Sci. and Technol.* 13(2):179-183.
- MacLeod W., Jr., D. Brown, A. Friedman, O. Maynes, and R. Pierce. 1985. *Standard Analytical Procedures of the NOAA National Analytical Facility, 1984-85, Extractable Toxic Organic Compounds*. NOAA Technical Memorandum NMFS F/NWC-64. Prepared for the National Status and Trends Program, National Oceanic and Atmospheric Administration, U.S. Department of Commerce, Rockville, MD.
- Malins, D.C., B.B. McCain, D.W. Brown, S.L. Chan, M.S. Myers, J.T. Landahl, P.G. Prohaska, A.J. Friedman, L.D. Rhodes, D.G. Burrows, W.D. Gronlund, and H.O. Hodgins. 1984. Chemical pollutants in sediments and diseases of bottom-dwelling fish in Puget Sound, WA. *Environ. Sci. Technol.* 18:705-713.

- Malins, D.C., M.M. Krahn, M.S. Myers, L.D. Rhodes, D.W. Brown, C.A. Krone, B.B. McCain, and S.L. Chan. 1985. Toxic chemicals in sediments and biota from a creosote-polluted harbor: Relationships with hepatic neoplasms and other hepatic lesions in English sole (*Parophrys vetulus*). *Carcinogenesis* 6:1463-1469.
- Marsh, D.O. 1987. Dose-response relationships in humans: Methyl mercury epidemics in Japan and Iraq. In: *The Toxicity of Methyl Mercury*. C.U. Eccles and Z. Annau (eds). Johns Hopkins University Press, Baltimore, MD.
- Marsh, D.O., T.W. Clarkson, C. Cox, G.J. Meyers, L. Amin-Zaki, and S. Al-Tikriti. 1987. Fetal methylmercury poisoning: relationship between concentration in single strands of maternal hair and child effects. *Arch. Neurol.* 44:1017-1022.
- Martin, R.C., D.G. Dixon, R.J. Maguire, P.V. Hodson, and R. J. Tkacz. 1989. Acute toxicity, uptake, depuration, and tissue distribution of tri-n-butyltin in rainbow trout *Salmo gairdneri*. *Aquatic Toxicol.* 15:37-52.
- May, T.W., and G.L. McKinney. 1981. Cadmium, lead, mercury, arsenic and selenium concentrations in freshwater fish, 1976-1977—National Pesticide Monitoring Program. *Pesticides Monitoring Journal* 15(1):14-38
- McConnell, E.E. 1980. In: *Topics in Environmental Health: Halogenated Biphenyls, Terphenyls, Naphthalenes, Dibenzodioxins and Related Products*. R.D. Kimbrough (ed.). Elsevier, North Holland, New York, NY. pp. 109-150.
- McFarland, V.A., and J.U. Clarke. 1989. Environmental occurrence, abundance, and potential toxicity of polychlorinated biphenyl congeners: considerations for a congener-specific analysis. *Environ. Health Perspect.* 81:225-239.
- Mearns, A.J., and M.J. Allen. 1978. *Use of Small Trawls in Coastal Biological Surveys*. Final Report. Prepared for Corvallis Environmental Research Laboratory, Office of Research and Development, U.S. Environmental Protection Agency, Corvallis, OR. Southern California Coastal Water Research Project, El Segundo, CA.
- The Merck Index. 1989. *An Encyclopedia of Chemicals, Drugs, and Biologicals*. 11th Edition. S.Budavari, ed., Merck and Company, Inc., Rahway, NJ.
- Mes, J., and D. Weber. 1989. Non-ortho-chlorine substituted coplanar polychlorinated biphenyl congeners in Canadian adipose tissue, breast milk, and fatty foods. *Chemosphere* 19(8-9):1357-1365.

- Miller, G.T. 1979. *Living in the Environment*. Wadsworth Publishing Company, Belmont, CA.
- Mills, D. 1971. *Salmon and Trout: A Resource, its Ecology, Conservation, and Management*. Oliver and Boyd Publishers, Edinburgh, Canada.
- Minnesota Department of Health. 1994. Minnesota Fish Consumption Advisory. Minneapolis, MN.
- Mix, M.C. 1986. Cancerous diseases in aquatic animals and their association with environmental pollutants: A critical literature review. *Mar. Environ. Res.* 20:1-141.
- Monaco, M.E., D.M. Nelson, T.C. Czaplak, and M.E. Patillo. 1989. *Distribution and Abundance of Fishes and Invertebrates in Texas Estuaries*. ELMR Report No. 3. Strategic Assessment Branch, National Oceanic and Atmospheric Administration, U.S. Department of Commerce, Rockville, MD.
- Monaco, M.E., D.M. Nelson, R.L. Emmett, and S.A. Hinton. 1990. *Distribution and Abundance of Fishes and Invertebrates in West Coast Estuaries. Volume I: Data Summaries*. ELMR Report No. 4. Strategic Assessment Branch, National Oceanic and Atmospheric Administration, U.S. Department of Commerce, Rockville, MD.
- Moore, J.W., and Ramamoorthy, S. 1984. *Organic Chemicals in Natural Waters*. Springer-Verlag, New York, NY. 289 pp.
- Morris, C.R., and J.R.P. Cabral (eds.). 1986. Hexachlorobenzene: Proceedings of an international symposium. *IARC Scientific Publication No. 77*. World Health Organization, Lyon, France.
- Mullin, M.D., C.M. Pochini, S. McCrindle, M. Romkes, S.H. Safe, and L.M. Safe. 1984. High-resolution PCB analysis: Synthesis and chromatographic properties of all 209 PCB congeners. *Environ. Sci. Technol.* 18:468-476.
- Multistate Fish and Wildlife Information Systems. 1990. *Second Annual Progress Report (July 1-July 30, 1990)*. Department of Fisheries and Wildlife, Virginia Polytechnical Institute, Blacksburg, VA.
- Murchelano, R.A. 1982. Some pollution-associated diseases and abnormalities of marine fish and shellfish: A perspective for the New York Bight. In: *Ecological Stress and the New York Bight: Science and Management*. G.F. Mayer (ed.). Estuarine Research Federation, Columbia, SC. pp. 327-346.

- Murphy, D. 1993. Maryland Department of Environment, Water Quality, Toxic Division. Personal communication.
- NAS (National Academy of Sciences). 1976. *Selenium*. Committee on Medical and Biologic Effects of Environmental Pollutants, National Research Council, Washington, DC.
- NAS (National Academy of Sciences). 1977. *Arsenic*. Committee on Medical and Biologic Effects of Environmental Pollutants, National Research Council, Washington, DC.
- NAS (National Academy of Sciences). 1991. *Seafood Safety*. Committee on Evaluation of the Safety of Fishing Products, National Academy Press, Washington, DC.
- NAS (National Academy of Sciences). 2000. *Toxicological Effects of Methylmercury*. National Research Council, Washington, DC.
- National Marine Fisheries Service. 1987. *Marine Recreational Fishery Statistics Survey, Pacific Coast, 1986*. Current Fishery Statistics Number 8393. National Oceanic and Atmospheric Administration, U.S. Department of Commerce, Rockville, MD.
- NCI (National Cancer Institute). 1978. *Bioassay of Dicofol for Possible Carcinogenicity*. NCI Carcinogenesis Technical Report Series #90. Rockville, MD.
- Neff, J.M. 1979. *Polycyclic Aromatic Hydrocarbons in the Aquatic Environment: Sources, Fates and Biological Effects*. Applied Science Publishers, Ltd, London, England.
- Neff, J.M. 1985. Polycyclic aromatic hydrocarbons. In: *Fundamentals of Aquatic Toxicology*. G.M. Rand and S.R. Petrocelli (eds.). Hemisphere Publishing Corporation, Washington, DC.
- Nelson, J.M. (ed.). 1992. *Distribution and Abundance of Fishes and Invertebrates in Gulf of Mexico Estuaries, Vol. 1: Data Summaries*. ELMR Rep. No. 10. NOAA/NOS Strategic Environmental Assessments Division, Rockville, MD.
- Nelson, D.M., M.E. Monaco, E.A. Irlandi, L.R. Settle, and L. Coston-Clements. 1991. *Distribution and Abundance of Fishes and Invertebrates in Southeast Estuaries*. ELMR Report No. 9. Strategic Assessment Division, National Oceanic and Atmospheric Administration, U.S. Department of Commerce, Rockville, MD.

- NESCAUM (Northeast States and Eastern Canadian Provinces). 1998. *Mercury Study, A Framework for Action*. Boston, MA.
- Neumann, C.M., K.W. Kaufman, and D.J. Gilroy. 1997. Methylmercury in Fish from Owyhee Reservoir in Southeast Oregon: Scientific Uncertainty and Fish Advisories. *Sci. Total Environ.*:205-214.
- New York State Department of Health. 1994. *Health Advisory—Chemicals in Sportfish and Game 1994-1995*. #40820042. Division of Environmental Health Assessments, Albany, NY.
- Nicholls, T.P., R. Perry, and J.N. Lester. 1979. The influence of heat treatment on the metallic and polycyclic aromatic hydrocarbon content of sewage sludge. *Sci. Total Environ.* 12:137-150.
- Niimi, A.J. 1987. Biological half-lives of chemicals in fishes. *Rev. Environ. Contam. Toxicol.* 99:1-46. Springer-Verlag, New York, NY.
- Nimmo, D.R. 1985. Pesticides. In: *Fundamentals of Aquatic Toxicology*, G.M. Rand and S.R. Petrocelli (eds.). Hemisphere Publishing Corporation, Washington, DC.
- Nisbet, I.C.T., and P.K. LaGoy. 1992. Toxic equivalency factors (TEFs) for polycyclic aromatic hydrocarbons (PAHs). *Reg. Toxicol. Pharmacol.* 16:290-300.
- NOAA (National Oceanic and Atmospheric Administration). 1987. *National Status and Trends Program for Marine Environmental Quality—Progress Report: A Summary of Selected Data on Chemical Contaminants in Tissues Collected During 1984, 1985 and 1986*. NOAA Technical Memorandum NOS OMA 38. U.S. Department of Commerce, Rockville, MD.
- NOAA (National Oceanic and Atmospheric Administration). 1989a. *National Status and Trends Program for Marine Environmental Quality - Progress Report: A Summary of Selected Data on Tissue Contamination from the First Three Years (1986-1988) of the Mussel Watch Project*. NOAA Technical Memorandum NOS OMA 49. U.S. Department of Commerce, Rockville, MD.
- NOAA (National Oceanic and Atmospheric Administration). 1989b. *Standard Analytical Procedures of the NOAA National Analytical Facility*. 2nd ed. NOAA Tech. Mem. NMFS F/NWC-92, 1985-86. National Status and Trends Program, U.S. Department of Commerce, Rockville, MD.

- NOAA (National Oceanic and Atmospheric Administration). 1992. *Standard and Reference Materials for Marine Science*. Third Edition. U.S. Department of Commerce, Rockville, Maryland.
- NOAA (National Oceanic and Atmospheric Administration). 1993a. *Sampling and Analytical Methods of the National Status and Trends Program, National Benthic Surveillance and Mussel Watch Projects 1984-1992. Volume II. Comprehensive Descriptions of Complementary Measurements*. NOAA Technical Memorandum NOS ORCA 71. Coastal Monitoring and Bioeffects Assessment Division, Office of Ocean Resources Conservation and Assessment, National Ocean Service, Silver Spring, MD. July.
- NOAA (National Oceanic and Atmospheric Administration). 1993b. *Sampling and Analytical Methods of the National Status and Trends Program, National Benthic Surveillance and Mussel Watch Projects 1984-1992. Volume III. Comprehensive Descriptions of Elemental Analytical Methods*. NOAA Technical Memorandum NOS ORCA 71. Coastal Monitoring and Bioeffects Assessment Division, Office of Ocean Resources Conservation and Assessment, National Ocean Service, Silver Spring, MD. July.
- NOAA (National Oceanic and Atmospheric Administration). 1993c. *Sampling and Analytical Methods of the National Status and Trends Program, National Benthic Surveillance and Mussel Watch Projects 1984-1992. Volume IV. Comprehensive Descriptions of Trace Organic Analytical Methods*. NOAA Technical Memorandum NOS ORCA 71. Coastal Monitoring and Bioeffects Assessment Division, Office of Ocean Resources Conservation and Assessment, National Ocean Service, Silver Spring, MD. July.
- Norstrom, R.J. 1988. In: *Hazards, Decontamination and Replacement of Polychlorinated Biphenyls*. J.P. Crine (ed.). Plenum Publishing Corporation, New York, NY.
- NPCA (National Paint and Coatings Association). 1988. Annual Report. Washington, DC.
- Nriagu, J.O., and M.S. Simmons (eds.). 1990. *Food Contamination from Environmental Sources*. J. Wiley and Sons, New York, NY.
- Olafsson, P.G., A.M. Bryan, B. Bush, and W. Stone. 1983. Snapping turtles—A biological screen for PCBs. *Chemosphere* 12 (11/12):1525-1532.
- Olafsson, P.G., A.M. Bryan, and W. Stone. 1987. PCB congener specific analysis: A critical evaluation of toxic levels in biota. *Chemosphere* 16 (10-12):2585-2593.

- Oliver, B.G., and A.J. Niimi. 1988. Trophodynamic analysis of polychlorinated biphenyl congeners and other chlorinated hydrocarbons in the Lake Ontario ecosystem. *Environ. Sci. Technol.* 22(4):388-397.
- Patillo, M.E., T.E. Czapla, D.M. Nelson, and M.E. Monaco. 1997. *Distribution and Abundance of Fishes and Invertebrates in Gulf of Mexico Estuaries. Volume II: Species Life History Summaries.* ELHR Report No. 14. NOAA/NOS Strategic Environmental Assessments Division, Silver Spring, MD.
- Peabody, F.E. 1961. Annual growth zones in vertebrates (living and fossil). *J. Morphol.* 108:11-62.
- Penrose, W.R. 1974. Arsenic in the marine and aquatic environments: Analysis, occurrence and significance. *C.R.C. Crit. Rev. in Environ. Contam.* 4:465-482.
- Pflieger, W.H. 1975. *The Fishes of Missouri.* Missouri Department of Conservation, Jefferson City, MO.
- Phillips, D.J.H. 1980. *Quantitative Aquatic Biological Indicators.* Pollution Monitoring Series. Applied Science Publishers Ltd, London, England.
- Phillips, P.T. 1988. *California State Mussel Watch—Ten Year Data Summary (1977-1987) Water Quality Monitoring Report No. 87-3.* State Water Resources Control Board, Division of Water Quality, Sacramento, CA.
- Pillay, K.K.S., C.C. Thomas, and J.W. Kaminski. 1969. Neutron activation analysis of the selenium content of fossil fuels. *Nucl. Appl. Technol.* 7:478-483.
- Piotrowski, J.K., and M.J. Inskip. 1981. *Health Effects of Mercury; A Technical Report (1981).* MARC Report Number 24. Chelsea College, University of London. 82 pp.
- Pitt, T.K., R. Wells, and W.D. McKone. 1981. A critique of research otter trawl surveys by the St. John's Research and Resource Services. *Canadian Fish Aquatic Sci. Spec. Publ.* 58:42-61.
- Poland, A., and J.C. Knutson. 1982. 2,3,7,8-Tetrachlorodibenzo-*p*-dioxin and related halogenated aromatic hydrocarbons: Examination of the mechanism of toxicity. *Annu. Rev. Pharmacol. Toxicol.* 22:517-554.
- Pollock, G. 1993. California Environmental Protection Agency. Personal communication.

- Pritchard, P.C.H. 1989. *The Alligator Snapping Turtle: Biology and Conservation*. Milwaukee Public Museum, Milwaukee, WI. 104 pp.
- Puget Sound Estuary Program. 1990a (revised). Recommended protocols for station positioning in Puget Sound. In: *Recommended Protocols and Guidelines for Measuring Selected Environmental Variables in Puget Sound*. Prepared by PTI Environmental Services, Bellevue, WA. Region 10, U.S. Environmental Protection Agency, Seattle, WA. (Looseleaf)
- Puget Sound Estuary Program. 1990b (revised). Recommended protocols for sampling soft-bottom demersal fishes by beach seine and trawl in Puget Sound. In: *Recommended Protocols and Guidelines for Measuring Selected Environmental Variables in Puget Sound*. Prepared by PTI Environmental Services, Bellevue, WA. Region 10, U.S. Environmental Protection Agency, Seattle, WA. (Looseleaf)
- Puget Sound Estuary Program. 1990c (revised). Recommended protocols for fish pathology studies in Puget Sound. In: *Recommended Protocols and Guidelines for Measuring Selected Environmental Variables in Puget Sound*. Prepared by PTI Environmental Services, Bellevue, WA. Region 10, U.S. Environmental Protection Agency, Seattle, WA. (Looseleaf)
- Puget Sound Estuary Program. 1990d (revised). Recommended guidelines for measuring organic compounds in Puget Sound sediments and tissue samples. In: *Recommended Protocols and Guidelines for Measuring Selected Environmental Variables in Puget Sound*. Prepared by PTI Environmental Services, Bellevue, WA. Region 10, U.S. Environmental Protection Agency, Seattle, WA. (Looseleaf)
- Puget Sound Estuary Program. 1990e (revised). Recommended protocols for measuring metals in Puget Sound water, sediment, and tissue samples. In: *Recommended Protocols and Guidelines for Measuring Selected Environmental Variables in Puget Sound*. Prepared by PTI Environmental Services, Bellevue, WA. Region 10, U.S. Environmental Protection Agency, Seattle, WA. (Looseleaf)
- Randall, R.C., H. Lee II, R.J. Ozretich, J.L. Lake, and R.J. Pruell. 1991. Evaluation of selected lipid methods for normalizing pollutant bioaccumulation. *Environ. Toxicol. Chem.* 10:1431-1436.
- Rappe, C., H.R. Buser, D.L. Stalling, L.M. Smith, and R.C. Dougherty. 1981. Identification of polychlorinated dibenzofurans in environmental samples. *Nature* 292:524-526.
- Reed, M.S., and C.F. Rabeni. 1989. Characteristics of an unexploited smallmouth bass population in a Missouri Ozark stream. *Am. J. Fish. Man.* 9:420-426.

- Reinert, R.E., B.A. Knuth, M.A. Kamrin, and Q.J. Stober. 1991. Risk assessment, risk management, and fish consumption advisories in the United States. *Fisheries* (6):5-12.
- Robinson, J.C., W.S. Pease, D.S. Albright, et al. 1994. *Pesticides in the Home and Community: Health Risks and Policy Alternatives. California Policy Seminar Report*. Center for Occupational and Environmental Health, School of Public Health, University of California, Berkeley, CA.
- Rohlf, F.J., H.R. Akcakaya, and S.P. Ferraro. 1991. *Optimizing Composite Sampling Protocols*. Contract 68-CO-0051. Prepared for the U.S. Environmental Protection Agency. Applied Biomathematics, Corvallis, OR.
- Rosen, B. 1970. Shell disease of aquatic crustaceans. pp. 409-415. In: *A Symposium of Diseases of Fish and Shellfishes*. S.F. Sniezko (ed.). Amer. Fish. Soc. Spec. Publ. No. 5. American Fisheries Society, Washington, DC.
- RTI (Research Triangle Institute). 1993. *National Listing of State Fish and Shellfish Consumption Advisories and Bans*. Prepared for Office of Science and Technology, U.S. Environmental Protection Agency. Research Triangle Park, NC.
- Ryan, J.J., P.Y. Lau, and J.A. Hardy. 1986. 2,3,7,8, Tetrachlorodibenzo-p-dioxin and related dioxans and furans in snapping turtle (*Chelydra serpentina*) tissues from the upper St. Lawrence River. *Chemosphere* 15 (5):537-548.
- Rylander, L., U. Stromberg, and L. Hagmar. 1998. Agreement between reported fish consumption obtained by two interviews and its impact on the results in a reproduction study. *European J. Epidemiol.* 14(1):93-97.
- Sabbioni, E., M. Fischbach, G. Pozzi, R. Pietra, M. Gallorini, and J.L. Piette. 1991. Cellular retention, toxicity and carcinogenic potential of seafood arsenic. I. Lack of cytotoxicity and transforming activity of arsenobetaine in the BAL3/3T3 cell line. *Carcinogenesis* 12:1287-1291.
- Safe, S. 1985. *CRC Critical Reviews in Toxicology. Polychlorinated Biphenyls (PCBs) and Polybrominated Biphenyls (PBBs): Biochemistry, Toxicology and Mechanism of Action*. CRC Press, Cleveland, OH.
- Safe, S. 1990. Polychlorinated biphenyls (PCBs), dibenzo-p-dioxins (PCDDs), dibenzofurans (PCDFs), and related compounds: Environmental and mechanistic considerations which support the development of toxic equivalency factors (TEFs). *Critical Reviews in Toxicology* 21(1):51-88.

- Safe, S., B. Astroff, M. Harris, T. Zacharewski, R. Dickerson, M. Romkes, and L. Biegel. 1991. 2,3,7,8-Tetrachlorodibenzo-p-dioxin and related compounds as antiestrogens: Characterization and mechanism of action. *Pharmacology and Toxicology* 69:400-409.
- Saleh, M.A. 1991. Toxaphene: Chemistry, biochemistry, toxicity, and environmental fate. *Rev. Environ. Contam. Toxicol.* 118:1-66.
- Sax, I.N. 1984. *Dangerous Properties of Industrial Materials*. 6th Edition. Van Nostrand Reinhold Company, New York, NY.
- Schmitt, C.J., and W.G. Brumbaugh. 1990. National Contaminant Biomonitoring Program: Concentrations of arsenic, cadmium, copper, lead, mercury, selenium, and zinc in U.S. freshwater fish, 1978-1984. *Arch. Environ. Contam. Toxicol.* 19:731-747.
- Schmitt, C.J., and S.E. Finger. 1987. The effects of sample preparation on measured concentrations of eight elements in edible tissues of fish from streams contaminated by lead mining: *Arch. Environ. Contam. Toxicol.* 16:185-207.
- Schmitt, C.J., M.A. Ribick, J.K. Ludke, and T.W. May. 1983. *National Pesticide Monitoring Program: Organochlorine Residues in Freshwater Fish, 1976-1979*. Resource Publication 152. Fish and Wildlife Service, U.S. Department of the Interior, Washington, DC.
- Schmitt, C.J., J.L. Zajicek, and P.H. Peterman. 1990. National Contaminant Biomonitoring Program: Residues of organochlorine chemicals in U.S. freshwater fish, 1976-1984. *Arch. Environ. Contam. Toxicol.* 19:748-781.
- Schmitt, C.J., J.L. Zajicek, and M.A. Ribick. 1985. National Pesticide Monitoring Program: Residues of organochlorine chemicals in freshwater fish, 1980-1981. *Arch. Environ. Contam. Toxicol.* 14:225-260.
- Schwartz, T.R., R.D. Campbell, D.L. Stalling, R.L. Little, J.D. Petty, J.W. Hogan, and E.M. Kaiser. 1984. Laboratory data base for isomer-specific determination of polychlorinated biphenyls. *Anal. Chem.* 56:1303-1308.
- Schwartz, T.R., D.L. Stalling, and C.L. Rice. 1987. Are polychlorinated biphenyl residues adequately described by Aroclor mixture equivalents? Isomer-specific principal components analysis of such residues in fish and turtles. *Environ. Sci. Technol.* 21(1):72-76.
- Schwartz, T.R., D.E. Tilitt, K.P. Feltz, and P.H. Peterman. 1993. Determination of mono- and non-O, Omin-chlorine substituted polychlorinated biphenyls in Aroclors and environmental samples. *Chemosphere* 26(8):1443-1461.

- Scott, D.E., F.W. Whicker, and J.W. Gibbons. 1986. Effect of season on the retention of ¹³⁷Cs and ⁹⁰Sr by the yellow-bellied slider turtle (*Pseudemys scripta*). *Can. J. Zool.* 64:2850-2853
- Sexton, O.J. 1959. A method of estimating the age of painted turtles for use in demographic studies. *Ecology* 40:716-718.
- Shain, W., B. Bush, and R. Seegal. 1991. Neurotoxicity of polychlorinated biphenyls: structure-activity relationship of individual congeners. *Toxicol. Appl. Pharmacol.* 111:33-42.
- Sheffy, T.B. 1987. *A Review of Mercury in Wisconsin's Environment. Recommendations for Studying and Identifying the Cause of the Problem.* Bureau of Air Management, Wisconsin Department of Natural Resources, Madison, WI.
- Short, J.W., and F.P. Thrower. 1987a. Accumulations of butyltins in muscle tissue of chinook salmon reared in sea pens treated with tri-n-butyltin. *Aquaculture* 61:181-192.
- Short, J.W., and F.P. Thrower. 1987b. Toxicity of tri-n-butyltin to chinook salmon, *Oncorhynchus tshawytscha*, adapted to seawater. *Aquaculture* 61:193-200.
- Siewicki, T.C. 1981. Tissue retention of arsenic in rats fed witch flounder or cacodylic acid. *J. Nutr.* 111:602-609.
- Sinderman, C.J. 1983. An examination of some relationships between pollution and disease. *Rapp. P. V. Reun. Cons. Int. Explor. Mer.* 182:37-43.
- Sinderman, C.J., F.B. Bang, N.O. Christensen, V. Dethlefsen, J.C. Harshbarger, J.R. Mitchell, and M.F. Mulcahy. 1980. The role and value of pathology in pollution effects monitoring programs. *Rapp. P. V. Reun. Cons. Int. Explor. Mer.* 179:135-151.
- Sinderman, C.J., and A. Rosenfield. 1967. Principal diseases of commercially important marine bivalve mollusca and crustacea. *Fish. Bull.* 66:335-385.
- Skerfving, S. B.G. Svensson, L. Asplund, and L. Hagmar. 1994. Exposure to mixtures and congeners of polychlorinated biphenyls. *Clinical Chemistry*, 40(7):1409-1415.
- Skerfving, S. 1988. Mercury in women exposed to methylmercury through fish consumption, and in their newborn babies and breast milk. *Bull. Environ. Contam. Toxicol.* 41:475-482.

- Skoog, D.A. 1985. *Principles of Instrumental Analysis*. 3rd ed. Saunders Press, Philadelphia, PA. pp. 270-277, 282-284, 303-304.
- Sloan, K., and J.E. Lovich. 1995. Exploitation of the alligator snapping turtle, *Macrolemys temminckii*, in Louisiana: A case study. *Chelonian Conserv. Biol.* 1(3):221-222.
- Smith, L.M. 1981. Carbon dispersed on glass fibers as an adsorbent for contaminant enrichment and fractionation. *Anal. Chem.* 53:2152-2154.
- Smith, R.L. 1985. *Guidance on Sampling Aquatic Organisms for Tissue Analyses during FY 1986*. Environmental Services Division, Region 3, U.S. Environmental Protection Agency, Philadelphia, PA.
- Smith, L.M., T.R. Schwartz, and K. Feltz. 1990. Determination and occurrence of AHH-active polychlorinated biphenyls, 2,3,7,8-tetrachloro-p-dioxin and 2,3,7,8-tetrachlorodibenzofuran in Lake Michigan sediment and biota, the question of their relative toxicological significance. *Chemosphere* 21(9):1063-1085.
- Smith, R.A., R.B. Alexander, and M.G. Wolman. 1987. Water quality trends in the nation's rivers. *Science* 235:1607-1615.
- Spry, D.S., and J.G. Wiener. 1991. Metal availability and toxicity to fish in low-alkalinity lakes: a critical review. *Environ. Pollut.* 71(2-4):243-304.
- Stalling, D.L., T.R. Schwartz, W.J. Dunn III, and S. Wold. 1987. Classification of polychlorinated biphenyl residues. *Anal. Chem.* 59:1853-1859.
- Stegeman, J.J., and J.J. Lech. 1991. Cytochrome P-450 monooxygenase systems in aquatic species: carcinogen metabolism and biomarkers for carcinogen and pollutant exposure. *Environ. Health Perspect.* 90:101-109.
- Stephenson, M.D., and D.R. Smith. 1988. Determination of tributyltin in tissues and sediments by graphite furnace atomic absorption spectrometry. *Anal. Chem.* 60:696-698.
- Stober, Q.J. 1991. *Guidelines for Fish Sampling and Tissue Preparation for Bioaccumulative Contaminants*. Environmental Services Division, Region 4, U.S. Environmental Protection Agency, Athens, GA.
- Stone, W.B., E. Kiviat, and S.A. Butkas. 1980. Toxicants in snapping turtles. *New York Fish and Game J.* 27 (1):39-50.

- Stone, S.L., T.A. Lowery, J.D. Field, C.D. Williams, D.M. Nelson, S.H. Jury, M.E. Monaco, and L. Andreasen. 1994. *Distribution and Abundance of Fishes and Invertebrates in Mid-Atlantic Estuaries*. ELMR Rep. No. 12. NOAA/NOS Strategic Environmental Assessments Division, Silver Spring, MD.
- Swackhamer, D. 1993. University of Minnesota. Personal communication.
- Tanabe, S., N. Kannan, A. Subramanian, S. Watanabe, and R. Tatsukawa. 1987. *Environ. Poll.* 47:147-163.
- Taylor, J.K. 1985. *Standard Reference Materials: Handbook for SRM Users*. NBS Special Publication 260-100. Center for Analytical Chemistry, U.S. Department of Commerce, National Bureau of Standards, Gaithersburg, MD.
- Tetra Tech. 1986. *Evaluation of Survey Positioning Method for Near-Shore and Estuarine Waters*. Prepared for Office of Marine and Estuarine Protection, U.S. Environmental Protection Agency. Bellevue, WA.
- Tetra Tech. 1995. *Assessing Human Health Risks from Chemically Contaminated Fish in the Lower Columbia River*. Draft report prepared for the Lower Columbia Bi-State Program. Redmond, WA.
- Texas Water Commission. 1990. *Texas Tissue Sampling Guidelines*. Texas Water Commission, Austin, TX.
- Tilson, H.A., J.L. Jacobson, and W.J. Rogan. 1990. Polychlorinated biphenyls and the developing nervous systems: Cross-species comparisons. *Neurotox. Teratol.* 12:239-248.
- Todd, B. L., and C.F. Rabeni. 1989. Movement and habitat use by stream-dwelling smallmouth bass. *Transact. Am. Fish. Soc.* 118 (3):229-242.
- Tollefson, Linda. 1989. Methylmercury in fish: Assessment of risk for U.S. consumers. In: *The Risk Assessment of Environmental and Human Health Hazards: A Textbook of Case Studies*. Dennis J. Paustenback (ed.). John Wiley & Sons, New York, NY.
- Toy, K.A., N.L. Polissar, S. Liao, and G.D. Mittelstaedt. 1996. *A Fish Consumption Survey of the Tulalip and Squaxin Island Tribes of the Puget Sound Region*. Tulalip Tribes, Department of Environment, Marysville, WA.
- Tsuda, T., H. Nakanishi, S. Aoki, and J. Takebayashi. 1988. Bioconcentration and metabolism of butyltin compounds in carp. *Water Res.* 22:647-651.

- Tsuda, T., M. Kojima, H. Harada, et al. 1997. Acute toxicity, accumulation and excretion of organophosphorous insecticides and their oxidation products in killifish. *Chemosphere* 35: 939-49, 1997.
- USDA/ARS (U.S. Department of Agriculture, Agricultural Research Service). 1998. *1994-1996 Continuing Survey of Foods Intakes by Individuals and 1994-1996 Diet and Health Knowledge Survey*. CD-ROM, accession number PB-98-500457. (Available from the National Technical Information Service, 5285 Port Royal Road, Springfield, VA 22161. Phone: 203-487-4650.)
- U.S. DOC (Department of Commerce). 1999a. *General Endangered and Threatened Marine Species, Permits for Incidental Taking of Species*. 50 CFR Part 222, Section 222.307. National Marine Fisheries Service, Washington, DC.
- U.S. DOC (Department of Commerce). 1999b. *General Endangered and Threatened Marine Species, Permits for Listed Species of Sea Turtles Involving the US Fish and Wildlife Service*. 50 CFR Part 222, Section 222.309. National Marine Fisheries Service, Washington, DC.
- U.S. DOI (Department of the Interior). 1999. *Endangered and Threatened Wildlife and Plants. Permits for Scientific Purposes, Enhancement of Propagation or Survival, or for Incidental Taking*. 50 CFR Part 17, Section 17.22. Fish and Wildlife Service, Washington, DC.
- U.S. EPA (U.S. Environmental Protection Agency). 1978. *Metal Bioaccumulation in Fish and Aquatic Invertebrates*. EPA-600/3-78-103. Environmental Research Laboratory, Office of Research and Development, Springfield, VA.
- U.S. EPA (U.S. Environmental Protection Agency). 1979a. *Health Assessment Document for Cadmium*. EPA-600/8-79-003. Environmental Standards and Criteria, Office of Research and Development, Research Triangle Park, NC.
- U.S. EPA (U.S. Environmental Protection Agency). 1979b. *Methods for the Chemical Analysis of Water and Wastes*. EPA-600/4-79-020. Environmental Monitoring and Support Laboratory, Cincinnati, OH.
- U.S. EPA (U.S. Environmental Protection Agency). 1980a. *Ambient Water Quality Criteria for Endrin*. EPA-440/5-80-047. Office of Water Regulations and Standards, Washington, DC.
- U.S. EPA (U.S. Environmental Protection Agency). 1980b. *Interim Guidelines and Specifications for Preparing Quality Assurance Project Plans*. QAMS-005/80. Quality Assurance Management Staff, Washington, DC.

- U.S. EPA (U.S. Environmental Protection Agency). 1981. *Interim Methods for the Sampling and Analysis of Priority Pollutants in Sediments and Fish Tissue*. EPA-600/4-81-055. Environmental Monitoring and Support Laboratory, Cincinnati, OH.
- U.S. EPA (U.S. Environmental Protection Agency). 1982a. *Methods for the Chemical Analysis of Municipal and Industrial Wastewater*. EPA-600/4-82-057. Environmental Monitoring and Support Laboratory, Cincinnati, OH.
- U.S. EPA (U.S. Environmental Protection Agency). 1982b. Arsenic. In: *Intermedia Priority Pollutant Guidance Documents*. Office of Pesticides and Toxic Substances, Washington, DC.
- U.S. EPA (U.S. Environmental Protection Agency). 1983a. *Analyses of the Risks and Benefits of Seven Chemicals Used for Subterranean Termite Control*. EPA-540/9-83-005. Office of Pesticide Programs, Washington, DC.
- U.S. EPA (U.S. Environmental Protection Agency). 1984a. Internal memorandum from G. LaRocca to B. Burnam et al., August 16, 1984. Office of Pesticide Programs, Washington, DC.
- U.S. EPA (U.S. Environmental Protection Agency). 1984b. *Policy and Program Requirements to Implement the Quality Assurance Program*. EPA Order 5360.1. Quality Assurance Management Staff, Washington, DC.
- U.S. EPA (U.S. Environmental Protection Agency). 1985a. *Bioaccumulation Monitoring Guidance: 3. Recommended Analytical Detection Limits*. EPA-503/6-90-001. Office of Marine and Estuarine Protection, Washington, DC.
- U.S. EPA (U.S. Environmental Protection Agency). 1985b. *Development of Statistical Distribution for Ranges of Standard Factors Used in Exposure Assessment*. EPA-600/8-85-010. Office of Health and Environmental Assessment, Washington, DC.
- U.S. EPA (U.S. Environmental Protection Agency). 1985c. *Guidance for the Registration of Pesticide Products Containing Lindane as the Active Ingredient*. EPA-540/RS-86-121. Office of Pesticide Programs, Washington, DC.
- U.S. EPA (U.S. Environmental Protection Agency). 1985d. *Pesticide Fact Sheet—Terbufos*. Office of Pesticides and Toxic Substances, Office of Pesticide Programs, Washington, DC.

- U.S. EPA (U.S. Environmental Protection Agency). 1986a. *Bioaccumulation Monitoring Guidance: 4. Analytical Methods for U.S. EPA Priority Pollutants and 301(h) Pesticides in Tissues from Marine and Estuarine Organisms*. EPA-503/6-90-002. Office of Marine and Estuarine Protection, Washington, DC.
- U.S. EPA (U.S. Environmental Protection Agency). 1986b. *Pesticide Fact Sheet—Diazinon*. Office of Pesticides and Toxic Substances, Office of Pesticide Programs, Washington, DC.
- U.S. EPA (U.S. Environmental Protection Agency). 1986c. *Research and Development Methodology for Evaluating Potential Carcinogenicity in Support of Reportable Quality Adjustments to CERCLA Section 102*. OHEA-C-073 Draft. Carcinogen Assessment Group Office of Environmental Assessment, Washington, DC.
- U.S. EPA (U.S. Environmental Protection Agency). 1986d. *Test Methods for the Evaluation of Solid Waste, Physical/Chemical Methods*. SW-846; 3rd Edition (with 1990 updates). Office of Solid Waste and Emergency Response, Washington, DC.
- U.S. EPA (U.S. Environmental Protection Agency). 1987a. *Bioaccumulation Monitoring Guidance: 2. Selection of Target Species and Review of Available Data*. EPA-430/9-86-005. Office of Marine and Estuarine Protection, Washington, DC.
- U.S. EPA (U.S. Environmental Protection Agency). 1987b. *Bioaccumulation Monitoring Guidance: 5. Strategies for Sample Replication and Compositing*. EPA-430/9-87-003. Office of Marine and Estuarine Protection, Washington, DC.
- U.S. EPA (U.S. Environmental Protection Agency). 1987c. *Cadmium Health Advisory Draft*. Office of Drinking Water, Washington, DC.
- U.S. EPA (U.S. Environmental Protection Agency). 1987d. *National Dioxin Study. Tiers 3, 5, 6, and 7*. EPA-440/4-87-003. Office of Water Regulations and Standards, Washington, DC.
- U.S. EPA (U.S. Environmental Protection Agency). 1987e. *Quality Assurance/Quality Control (QA/QC) for 301(h) Monitoring Programs: Guidance on Field and Laboratory Methods*. EPA-430/9-86-004. Office of Marine and Estuarine Protection, Washington, DC.
- U.S. EPA (U.S. Environmental Protection Agency). 1987f. *The Risk Assessment Guidelines of 1986*. EPA/600/8-87/045. Office of Health and Environmental Assessment, Washington, DC.

- U.S. EPA (U.S. Environmental Protection Agency). 1988a. *Drinking Water Criteria Document for Polychlorinated Biphenyls (PCBs)*. ECAO-CIN-414. Prepared by Environmental Criteria and Assessment Office for Office of Drinking Water, Washington, DC.
- U.S. EPA (U.S. Environmental Protection Agency). 1988b. *Pesticide Fact Sheet: Tributyltin (Antifouling Paints)*. Number 143. September 23, 1988. Office of Pesticides and Toxic Substances, Office of Pesticide Programs, Washington, DC.
- U.S. EPA (U.S. Environmental Protection Agency). 1989a. *Analytical Procedures and Quality Assurance Plan for the Determination of Mercury in Fish*. Draft. Environmental Research Laboratory, Duluth MN.
- U.S. EPA (U.S. Environmental Protection Agency). 1989b. *Analytical Procedures and Quality Assurance Plan for the Determination of PCDD/PCDF in Fish*. EPA-600/3-90-022. Environmental Research Laboratory, Duluth, MN.
- U.S. EPA (U.S. Environmental Protection Agency). 1989c. *Analytical Procedures and Quality Assurance Plan for the Determination of Xenobiotic Chemical Contaminants in Fish*. EPA-600/3-90-023. Environmental Research Laboratory, Duluth, NM.
- U.S. EPA (U.S. Environmental Protection Agency). 1989d. *Assessing Human Health Risks from Chemically Contaminated Fish and Shellfish: A Guidance Manual*. EPA-503/8-89-002. Office of Water Regulations and Standards, Office of Marine and Estuarine Protection, Washington, DC.
- U.S. EPA (U.S. Environmental Protection Agency). 1989e. *Pesticide Fact Sheet—Ethion*. Office of Pesticides and Toxic Substances, Office of Pesticide Programs, Washington, DC.
- U.S. EPA (U.S. Environmental Protection Agency). 1990a. *Exposure Factors Handbook*. EPA 600/8-89/043. Office of Health and Environmental Assessment, Washington, DC.
- U.S. EPA (U.S. Environmental Protection Agency). 1990b. *Test Methods for Evaluating Solid Waste, Physical/Chemical Methods*. SW-846, 3rd edition, proposed Update II. Office of Solid Waste and Emergency Response, Washington, DC.
- U.S. EPA (U.S. Environmental Protection Agency). 1990c. *Tetrachlorodibenzo-p-Dioxins and-Dibenzofurans in Edible Fish Tissue at Selected Sites in Arkansas and Texas*. Water Quality Management Branch and Surveillance Branch, Region 6, Dallas, TX.

- U.S. EPA (U.S. Environmental Protection Agency). 1990d. *Work Plan for FY 91 Regional Ambient Fish Tissue Monitoring Program Activity No. ELR 80*. Environmental Monitoring and Compliance Branch, Region 7, Kansas City, KS.
- U.S. EPA (U.S. Environmental Protection Agency). 1991a. *Assessment and Control of Bioconcentratable Contaminants in Surface Waters*. Draft. Office of Research and Development, Washington, DC.
- U.S. EPA (U.S. Environmental Protection Agency). 1991b. *Contract Laboratory Program Statement of Work for Inorganic Analysis, Multi-Media, Multi-Concentration*. SOW 788, July. Washington, DC.
- U.S. EPA (U.S. Environmental Protection Agency). 1991c. *Contract Laboratory Program Statement of Work for Organic Analysis*. Washington, DC.
- U.S. EPA (U.S. Environmental Protection Agency). 1991d. *Environmental Monitoring and Assessment Program (EMAP) Near Coastal Program Laboratory Methods for Filleting and Compositing Fish for Organic and Inorganic Contaminant Analyses*. Draft. Office of Research and Development, Environmental Research Laboratory, Narragansett, RI.
- U.S. EPA (U.S. Environmental Protection Agency). 1991e. *Environmental Monitoring and Assessment Program (EMAP) Near Coastal Virginian Province Quality Assurance Project Plan*. Draft. Office of Research and Development, Environmental Research Laboratory, Narragansett, RI.
- U.S. EPA (U.S. Environmental Protection Agency). 1991f. *Environmental Monitoring Methods Index, Version 1.0 Software, User's Manual, EMMI User Support*. Office of Water, Sample Control Center, Alexandria, VA.
- U.S. EPA (U.S. Environmental Protection Agency). 1991g. *Methods for the Determination of Metals in Environmental Samples*. EPA-600/4-91/010. Environmental Monitoring Systems Laboratory, Office of Research and Development, Cincinnati, OH.
- U.S. EPA (U.S. Environmental Protection Agency). 1991h. *National Bioaccumulation Study*. Draft. Office of Water Regulations and Standards, Washington, DC.
- U.S. EPA (U.S. Environmental Protection Agency). 1992a. *Classification List of Chemicals Evaluated for Carcinogenicity Potential*. Office of Pesticide Programs, Washington, DC.
- U.S. EPA (U.S. Environmental Protection Agency). 1992b. *Consumption Surveys for Fish and Shellfish: A Review and Analysis of Survey Methods*. EPA-822/R-92-001. Office of Water, Washington, DC.

- U.S. EPA (U.S. Environmental Protection Agency). 1992c. *National Study of Chemical Residues in Fish*. Volume I. EPA-823/R-92-008a. Office of Science and Technology, Washington, DC.
- U.S. EPA (U.S. Environmental Protection Agency). 1992d. *National Study of Chemical Residues in Fish*. Volume II. EPA-823/R-92-008b. Office of Science and Technology, Washington, DC.
- U.S. EPA (U.S. Environmental Protection Agency). 1992e. *304(a) Criteria and Related Information for Toxic Pollutants*. Spreadsheet. Water Quality Standards Unit, Water Management Division, Region 4, Atlanta, GA.
- U.S. EPA (U.S. Environmental Protection Agency). 1993a. *Fate One Liner Database*. Office of Pesticide Programs, Washington, DC.
- U.S. EPA (U.S. Environmental Protection Agency). 1993b. Notice of receipt of requests for amendments to delete uses in certain pesticide registration. *Federal Register* 58(220):60630-60631.
- U.S. EPA (U.S. Environmental Protection Agency). 1993c. *Provisional Guidance for Quantitative Risk Assessment of Polycyclic Aromatic Hydrocarbons*. EPA/600/R-93/089. Environmental Criteria and Assessment Office, Office of Health and Environmental Assessment, Cincinnati, OH.
- U.S. EPA (U.S. Environmental Protection Agency). 1993d. *Reference Dose Tracking Report*. Office of Pesticide Programs, Health Effects Division, Washington, DC.
- U.S. EPA (U.S. Environmental Protection Agency). 1993e. *Workshop Report on Developmental Neurotoxic Effects Associated with Exposure to PCBs*. September 14-15, 1992, Research Triangle Park, NC. Risk Assessment Forum, Washington, DC.
- U.S. EPA (U.S. Environmental Protection Agency). 1994. *Endangered and Threatened Wildlife and Plants*. 50 CFR 17.11 and 17.12. June 30.
- U.S. EPA (U.S. Environmental Protection Agency). 1995a. *Guidance on Establishing Trace Metal Clean Rooms in Existing Facilities*. Draft. EPA 821-B-95-001. Office of Water, Engineering and Analysis Division, Washington, DC.
- U.S. EPA (U.S. Environmental Protection Agency). 1995b. *Method 1613b. Tetra- through Octa-Chlorinated Dioxins and Furans by Isotope Dilution HRGC/HRMS*. Final Draft. Office of Water, Office of Science and Technology, Washington, DC.

- U.S. EPA (U.S. Environmental Protection Agency). 1995c. *Method 1631: Mercury in Water by Oxidation, Purge and Trap, and Cold Vapor Atomic Fluorescence Spectrometry*. Draft. EPA 821-R-95-027. Office of Water, Engineering and Analysis Division, Washington, DC.
- U.S. EPA (U.S. Environmental Protection Agency). 1995d. *Method 1632: Determination of Inorganic Arsenic in Water by Hydride Generation Flame Atomic Absorption*. Draft. EPA 821-R-95-028. Office of Water, Engineering and Analysis Division, Washington, DC.
- U.S. EPA (U.S. Environmental Protection Agency). 1995e. *Method 1637: Determination of Trace Elements in Ambient Waters by Chelation Preconcentration with Graphite Furnace Atomic Absorption*. EPA 821-R-95-030. Office of Water, Engineering and Analysis Division, Washington, DC.
- U.S. EPA (U.S. Environmental Protection Agency). 1995f. *Method 1638: Determination of Trace Elements in Ambient Waters by Inductively Coupled Plasma-Mass Spectrometry*. Office of Water, Engineering and Analysis Division, Washington, DC.
- U.S. EPA (U.S. Environmental Protection Agency). 1995g. *Method 1639: Determination of Trace Elements in Ambient Waters by Stabilized Temperature Graphite Furnace Atomic Absorption*. EPA 321-R-95-032. Office of Water, Engineering and Analysis Division, Washington, DC.
- U.S. EPA (U.S. Environmental Protection Agency). 1995h. *Guidance on the Documentation and Evaluation of Trace Metals Data Collected for Clean Water Act Compliance Monitoring*. EPA 821-B-95-002. Office of Water, Engineering and Analysis Division, Washington, DC.
- U.S. EPA (U.S. Environmental Protection Agency). 1995i. *QA/QC Guidance for Sampling and Analysis of Sediments, Water, and Tissues for Dredged Material Evaluations—Chemical Evaluations*. EPA 823-B-95-001. Office of Water, Washington, DC, and Department of the Army, U.S. Army Corps of Engineers, Washington, DC.
- U.S. EPA (U.S. Environmental Protection Agency). 1995j. *Health Effects Document for Terbufos*. Office of Pesticide Programs, Washington, DC.
- U.S. EPA (U.S. Environmental Protection Agency). 1996. *PCBs: Cancer Dose-Response Assessment and Application to Environmental Mixtures*. EPA/6001P-96/00F. National Center for Environmental Assessment, Office of Research and Development, Washington, DC.

- U.S. EPA (U.S. Environmental Protection Agency). 1997a. *Draft Method 1668 Toxic Polychlorinated Biphenols by Isotope Dilution High Gas Chromatography/High Resolution Mass Spectrometry*. Office of Water, Washington, DC. March.
- U.S. EPA (U.S. Environmental Protection Agency). 1997b. *Exposure Factors Handbook, Volume 1, General Factors*. EPA/600/P-95/002Fa. Office of Research and Development, Washington, DC. August.
- U.S. EPA (Environmental Protection Agency). 1997c. *Mercury Study Report to Congress*. EPA-452R-96-001a and b. Office of Air Quality Planning and Standards and Office of Research and Development.
- U.S. EPA (Environmental Protection Agency). 1998a. *Daily average per capita fish consumption estimates based on the combined USDA 1989, 1990, and 1991 continuing survey of food intakes by individuals (CSFII)*. Volume I: Uncooked Fish Consumption National Estimates. Office of Science and Technology, Washington, DC (unpublished report).
- U.S. EPA (U.S. Environmental Protection Agency). 1998b. *Guidance for Conducting Fish and Wildlife Surveys*. EPA-823-B-98-007, November. Office of Water, Washington, DC.
- U.S. EPA (U.S. Environmental Protection Agency). 1998c. *Reregistration Eligibility Decision (RED). Dicofol*. Office of Pesticide Programs and Toxic Substances, Washington, DC.
- U.S. EPA (Environmental Protection Agency) 1998d. *Health Effects Test Guidelines, OPPTS 870.1000. Acute Toxicity Testing - Background: Prevention, Pesticides and Toxic Substances*. EPA-712-C-98-189. Office of Pesticide Programs, Washington, DC.
- U.S. EPA (U.S. Environmental Protection Agency). 1998e. Memorandum dated September 24, 1998. *Reused Oxyfluofen (Goal) Quantitative Risk Assessment (Q1) based on CD-1 male mouse dietary study with 3/4's Interspecies Scaling Factor*. HRD Doc. No. 012879.
- U.S. EPA (U.S. Environmental Protection Agency). 1999a. *National Listing of Fish and Wildlife Advisories database-1998*. Office of Science and Technology, Office of Water, Washington DC.
- U.S. EPA (U.S. Environmental Protection Agency). 1999b. *Classification List of Chemicals Evaluated for Carcinogenicity Potential*. Office of Pesticide Programs and Toxic Substances, Washington, DC.

- U.S. EPA (Environmental Protection Agency), 1999c. *EPA Fact Sheet -Update: National Listing of Fish and Wildlife Advisories*. EPA-823-F-99-005. Office of Water, Washington DC.
- U.S. EPA (Environmental Protection Agency). 1999d. *The National Survey of Mercury Concentrations in Fish - Database Summary 1990-1995*. EPA-823-R-99-014. Office of Water, Washington, DC.
- U.S. EPA (U.S. Environmental Protection Agency). 2000a. *Guidance for Assessing Chemical Contaminant Data for Use in Fish Advisories—Risk Assessment and Fish Consumption Limits*. Volume 2. 3rd Edition. EPA 823-B-00-008. Office of Water, Washington, DC.
- U.S. EPA (Environmental Protection Agency). 2000b. *Revised Human Health Risk Assessment for Chlorpyrifos*. Office of Pesticide Programs, Washington, DC.
- U.S. EPA (Environmental Protection Agency). 2000c. *Estimated Per Capita Fish Consumption in the United States*. EPA-821-R-00-025. Office of Science and Technology, Washington, DC.
- U.S. FDA (Food and Drug Administration). 1990. *Pesticide Analytical Manual, Volumes I and II*. Report No. FDA/OM0-90/15A. U.S. Department of Health and Human Services, Washington, DC.
- U.S. FDA (Food and Drug Administration). 1993. *Guidance Document for Arsenic in Shellfish*. Center for Food Safety and Applied Nutrition, Washington, DC. January.
- U.S. FDA (Food and Drug Administration). 1998. *Action Levels for Poisonous or Deleterious Substances in Human Food and Animal Feed. Industry Activities*. Staff Booklet. Washington, DC.
- U.S. FWS (Fish and Wildlife Service). 1994. *Endangered Species Database*. December 1994.
- USGS (U.S. Geological Survey). 1987. Methods for the determination of organic substances in water and fluvial sediments. Chapter A3. In: *Techniques of Water-Resources Investigations of the United States Geological Survey*. R.L. Wershaw, M.J. Fishman, R.R. Grable, and L.E. Lowe (eds). Books and Open-File Reports Section, Denver, CO.
- Vahter, M., and J. Envall. 1983. In vivo reduction of arsenate in mice and rabbits. *Environ. Res.* 32:14-24.
- Vahter, M., E. Marafante, and L. Dencker. 1983. Metabolism of arsenobetaine in mice, rats and rabbits. *Sci. Total Environ.* 30:197-211.

- Vallee, B.L., D.D. Ulmer, and W.E.C. Wacker. 1960. Arsenic toxicology and biochemistry. *Arch. Ind. Health* 21:132-151.
- Van den Berg, M., L. Birnbaum, A.T.C. Bosveld, et al. 1998. Toxic equivalency factors (TEFs) for PCBs, PCDDs, PCDFs for human and wildlife *Environ. Health Perspect.* 106(12):775-792.
- Varanasi, U., and D.J. Gmur. 1980. Metabolic activation and covalent binding of benzo[a]pyrene to deoxyribonucleic acid catalyzed by liver enzymes of marine fish. *Biochem. Pharmacol.* 29:753-762.
- Varanasi, U., and D.J. Gmur. 1981. In vivo metabolism of naphthalene and benzo[a]pyrene of flatfish. In: *Chemical Analysis and Biological Fate: Polynuclear Aromatic Hydrocarbons*. M. Cooke and A.J. Dennis (eds.). Fifth International Symposium, Columbus, OH, Battelle Press. pp. 367-376.
- Varanasi, U., W.L. Reichert, J.E. Stein, et al. 1985. Bioavailability and biotransformation of aromatic hydrocarbons in benthic organisms exposed to sediment from an urban estuary. *Environ. Sci. Technol.* 19:836-841.
- Versar, Inc. 1982. *Sampling Protocols for Collecting Surface Water, Bed Sediment, Bivalves and Fish for Priority Pollutant Analysis—Final Draft Report*. EPA Contract 68-01-6195. Prepared for Office of Water Regulations and Standards, U.S. Environmental Protection Agency. Springfield, VA.
- Versar, Inc. 1984. *Sampling Guidance Manual for the National Dioxin Study—Final Draft Report*. EPA Contract 68-01-6160. Prepared for Office of Water Regulations and Standards, U.S. Environmental Protection Agency. Springfield, VA.
- Voiland, M.P., K.L. Gall, D.J. Lisk, and D.B. MacNeill. 1991. Effectiveness of recommended fat-trimming procedures on the reduction of PCB and Mirex levels in Brown trout (*Salmo trutta*) from Lake Ontario. *J. Great Lakes Res.* 17(4):454-460.
- Wade, T.L., B. Garcia-Romero, and J.M. Brooks. 1988. Tributyltin contamination of bivalves from U.S. coastal estuaries. *Env. Sci. Technol.* 22:1488-1492.
- Walsh, P.R., R.A. Duce, and J.L. Fasching. 1979. Considerations of the enrichment, sources, and flux of arsenic in the troposphere. *J. Geophys Res.* 84(C4):1719-1726.
- Wanderstock, J., W. Iskat, W. Gutenmann, and D. Lisk. 1971. Effect of several cooking methods on concentration of DDT residues in lake trout and coho salmon. *New York Fish and Game J.* 18:70-72.

- Wania, F., and D. Mackay. 1993. Global fractionation and cold condensation of low volatility organochlorine compounds in polar regions. *Ambio* 22:10-18.
- Wania, F., and D. Mackay. 1996. Tracking the distribution of persistent organic pollutants. *Environ. Sci. Technol.* 30(9):390A-396A.
- Ward, G.S., G.C. Cramm, P.R. Parrish, H. Trachman, and A. Slesinger. 1981. Bioaccumulation and chronic toxicity of bis(tributyltin) oxide (TBTO): tests with a saltwater fish. In: *Aquatic Toxicology and Hazard Assessment*. D.R. Branson and K.L. Dickson (eds.). American Society of Testing and Materials, Publication No. ASTM STP 737, Philadelphia, PA. pp. 183-200.
- Ware, G.W. 1978. *The Pesticide Book*. W.H. Freeman and Company, San Francisco, CA.
- WDNR (Wisconsin Department of Natural Resources). 1988. *Fish Contaminant Monitoring Program—Field and Laboratory Guidelines*. Report No. 1005.1. Madison, WI.
- Weber, C.I. (ed.) 1973. *Biological Field and Laboratory Methods for Measuring the Quality of Surface Waters and Effluents*. EPA/670/4-73-001. Office of Research and Development, U.S. Environmental Protection Agency, Cincinnati, OH.
- WHO (World Health Organization). 1976. *Environmental Health Criteria. 1. Mercury*. Geneva, Switzerland.
- WHO (World Health Organization). 1989. *Toxicological Evaluation of Certain Food Additives and Contaminants. Arsenic*. WHO Food Additive Series, 24, pp. 155-162, Cambridge University Press, Cambridge.
- WHO (World Health Organization). 1990. *Environmental Health Criteria 101: Methylmercury*. Geneva, Switzerland.
- WHO (World Health Organization). 1999. *Concise International Chemical Assessment. Document Number 14: Tributyltin Oxide*. Geneva, Switzerland.
- Willers, W. 1991. *Trout Biology*. Lyons and Burford, New York, NY.
- Wiener, J.G. 1987. Metal contamination of fish in low-pH lakes and potential implications for piscivorous wildlife. *Trans N. Am. Wildl. Nat. Res. Conf.* 52:654-657.

- Williams, S. (ed.). 1984. *Official Methods of Analysis of the Association of Official Analytical Chemists*. Fourteenth edition. The Association of Official Analytical Chemists, Inc., Arlington, VA.
- Williams, C.D., D.M. Nelson, M.E. Monaco, S.L. Stone, C. Iancu, L. Coston-Clements, L.R. Settle, and E.A. Irlandi. 1990. *Distribution and Abundance of Fishes and Invertebrates in Eastern Gulf of Mexico Estuaries*. ELMR Report No. 6. Strategic Assessment Branch, National Oceanic and Atmospheric Administration, U.S. Department of Commerce, Rockville, MD.
- Wolf, R.J., and R.J. Walker. 1987. Economies in Alaska: Productivity, geography, and development impacts. *Arctic Anthropol.* 24:56-81.
- Wood, J.M. 1974. Biological cycles for toxic elements in the environment. *Science* 183:1049-1052.
- Woolson, E.A. (ed.). 1975. *Arsenical pesticides*. Am. Chem. Soc. Symp. Ser. 7. 176 pp.
- Worthing, C.R. 1991. *The Pesticide Manual: A World Compendium*. 9th edition. British Crop Protection Council, Croydon, England.
- Wynder, E.L., and D. Hoffman. 1959. A study of tobacco carcinogenesis. VII. The role of higher polycyclic hydrocarbons. *Cancer* 12:1079-1086.
- Yamauchi, H., T. Kaise, and Y. Yamamura. 1986. Metabolism and excretion of orally administered arsenobetaine in the hamster. *Bull. Environ. Contam. Toxicol.* 36:350-355.
- Zabik, M., C. Hoojjat, and D. Weaver. 1979. Polychlorinated biphenyls, dieldrin, and DDT in lake trout cooked by broiling, roasting, or microwave. *Bull. Environ. Contamin. Toxicol.* 21:136-143.
- Zabik, M.E., M.J. Zabik, and H. Humphrey. 1994. *Assessment of Contaminants in Five Species of Great Lakes Fish at the Dinner Table*. Final Report to the Great Lakes Protection Fund, Chicago, Illinois. March 1994.
- Zabik, M.E., M.J. Zabik, A.M. Booren, M. Nettles, J.H. Song, R. Welch and H. Humphrey. 1995b. Pesticides and total polychlorinated biphenyls in chinook salmon and carp harvested from the Great Lakes: Effects of skin-on and skin-off processing and selected cooking methods. *J. Agric. Food Chem.* 43:993-1001.
- Zabik, M.E., A.M. Booren, M.J. Zabik, R. Welch, and H. Humphrey. 1996. Pesticide residues, PCBs and PAHs in baked, charbroiled, salt boiled, and smoked Great Lakes lake trout. *Food Chem.* 55 (3): 231-239.

- Zabik, M.E., and M.J. Zabik. 1995. Tetrachlorodibenzo-p-dioxin residue reduction by cooking/processing of fish fillets harvested from the Great Lakes. *Bull. Environ. Contam. Toxicol.* 55:264-269.
- Zabik, M.E., and M.J. Zabik. 1996. Influence of processing on environmental contaminants in foods. *Food Tech.* 50: 225-229.
- Zangerl, R. 1969. The turtle shell. In *Biology of the Reptilia*. C. Gans (ed.). Academic Press, New York. Volume 1, pp. 311-339.
- Zarogian, G.E., and G.L. Hoffman. 1982. Arsenic uptake and loss in the American oyster, *Crassostrea virginica*. *Environ. Monitor. Assess.* 1:345-358.
- Zug, G.R., A.H. Wynn, and C. Ruckdeschel. 1986. Age determination of loggerhead sea turtles, *Caretta caretta*, by incremental growth marks in the skeleton. *Smithson. Contrib. Zool.* 427:1-34.
- Zweig, G., and J. Sherma (eds.). 1980. *Updated General Techniques and Additional Pesticides. Volume 11. In: Analytical Methods for Pesticides and Plant-Growth Regulators.* Academic Press, New York, NY.

APPENDIX A

1993 FISH CONTAMINANT WORKGROUP

A. 1993 FISH CONTAMINANT WORKGROUP

These individuals representing EPA Headquarters, EPA Regions, State and Federal agencies, Native American groups and others provided technical information, reviews, and recommendations throughout the preparation of the first edition of this document. Participation in the review process does not imply concurrence by these individuals with all concepts and methods described in this document.

A.1 EPA Headquarters Staff

Charles Abernathy	EPA/Office of Water
Thomas Armitage	EPA/Office of Water
Jeffrey Bigler	EPA/Office of Water (Workgroup Chairman)
Carin Bisland	EPA/Office of Water
Dennis Borum	EPA/Office of Water
Robert Cantilli	EPA/Office of Water
Julie Du	EPA/Office of Water
Richard Hoffman	EPA/Office of Water
Clyde Houseknecht	EPA/Office of Water
Henry Kahn	EPA/Office of Water
Amal Mahfouz	EPA/Office of Water
Michael Kravitz	EPA/Office of Water
Elizabeth Southerland	EPA/Office of Water
Margaret Stasikowski	EPA/Office of Water
Irene Suzukida-Horner	EPA/Office of Water
Elizabeth Tam	EPA/Office of Water
William Telliard	EPA/Office of Water
Charles White	EPA/Office of Water
Jennifer Orme Zavala	EPA/Office of Water
Tina Levine	EPA/Office of Pesticide Programs
Michael Metzger	EPA/Office of Pesticide Programs
Richard Whiting	EPA/Office of Pesticide Programs
Jacqueline Moya	EPA/Office of Health and Environmental Assessment

A.2 Other EPA Office Staff

David DeVault	EPA/Great Lakes National Program Office
Brian Melzian	EPA/Office of Reserach and Development- Narragansett, RI
John Paul	EPA/Office of Research and Development- Narragansett, RI
Dennis McMullen	EPA/Environmental Monitoring and Systems Laboratory-Cincinnati, OH
Laurence Burkhard	EPA/Office of Research and Development- Duluth, MN

Michael Dourson	EPA/Office of Health and Environmental Assessment-Cincinnati, OH
Donald Klemm	EPA/Office of Health and Environmental Assessment-Cincinnati, OH

A.3 EPA Regional Staff

Charles Kanetsky	Region 3
Jerry Stober	Region 4
Peter Redmon	Region 5
Diane Evans	Region 6
Philip Crocker	Region 7
Bruce Herbold	Region 9

A.4 Other Federal Agency Staff

Michael Bolger	FDA
Leon Sawyer	FDA
Lee Barclay	FWS
Frank De Luise	FWS
Donald Steffeck	FWS
Jerry Schulte	ORSANCO
Adriana Cantillo	NOAA
Maxwell Eldridge	NOAA
Betty Hackley	NOAA
Alicia Jarboe	NOAA
Bruce Morehead	NOAA
Don Dycus	TVA
J. Kent Crawford	USGS

A.5 State Agency Staff

Robert Cooner	Alabama
Brian Hughes	Alabama
William Keith	Arkansas
Thomas McChesney	Arkansas
Randall Mathis	Arkansas
Gerald Pollock	California
Robert McConnell	Colorado
Richard Greene	Delaware
Eldert Hartwig	Florida
Randall Manning	Georgia
Robert Flentge	Illinois
C. Lee Bridges	Indiana
Emelise Cormier	Louisiana
Albert Hindrichs	Louisiana
Elaine Sorbet	Louisiana

Deirdre Murphy	Maryland
Jack Schwartz	Massachusetts
John Hesse	Michigan
Richard Powers	Michigan
Lisa Williams	Michigan
Pamela Shubat	Minnesota
Alan Buchanan	Missouri
David Tunink	Nebraska
Donald Normandeau	New Hampshire
Paul Hauge	New Jersey
Lawrence Skinner	New York
Ken Eagleson	North Carolina
Jay Sauber	North Carolina
Luanne Williams	North Carolina
Michael Ell	North Dakota
Martin Schock	North Dakota
Abul Anisuzzaman	Ohio
Gene Foster	Oregon
Barbara Britton	Texas
Peter Sherertz	Virginia
Ram Tripathi	Virginia
Jim Amrhein	Wisconsin
Bruce Baker	Wisconsin

A.6 Other Organizations

James Wiener	American Fisheries Society
Deborah Schwackhamer	University of Minnesota
Alvin Braswell	North Carolina State Museum of Natural Science
J. Whitfield Gibbons	University of Georgia Savannah River Ecology Laboratory

APPENDIX B

SCREENING VALUES FOR DEFINING GREEN AREAS

APPENDIX B

Recommendations for Designating Areas of Unrestricted Fish Consumption as Part of State Fish Advisory Programs

Fish consumption advisories issued across the United States have increased over the past 5 years from 1,266 advisories in 1993 to 2,506 advisories in 1998. Many states are now advising their citizens either (1) not to consume any fish or any fish of a specific species or specific size class from specified waterbodies, or (2) to restrict their consumption of these fish to a specified number of meals per time interval (such as one meal per week or two meals per month). This comes at a time when the health benefits of consuming fish have also become widely recognized (Burr et al., 1989; Dolecek and Granditis, 1991; Kimbrough, 1991; Knapp and Fitzgerald, 1989; Kromhout, 1993; Kromhout et al., 1985; McVeigh, 1990; Norell et al., 1986; Shekelle et al., 1985; Simopoulous, 1991). In an attempt to promote consumption of fish with relatively low body burdens of chemical contaminants as part of a healthy diet, some states have defined certain waterbodies as containing fish that are safe for "unrestricted consumption." These areas that are identified as safe for unrestricted fish consumption are often referred to as "green" areas. The U.S. Environmental Protection Agency (EPA) National Fish and Wildlife Contamination Program is recommending that states develop an approach for designating and communicating the location of these safe fishing areas to the fish-consuming public. This risk management tool encourages both fishing as a recreational activity and the consumption of fish that are low in chemical contaminant residues, high in protein, and low in fat content.

This green area concept, already in use in several U.S. states and Canadian provinces, would enable states, territories, and tribes to define areas where fish tissue monitoring data and appropriate risk assessments have determined that fish may be safely consumed at unrestricted levels (as defined by the state) from a particular waterbody or waterbodies in a particular watershed. The green areas concept is in contrast to the more traditionally issued fish advisory that discourages fish consumption from specified waterbodies altogether or advises reduced consumption of fish. These green areas may comprise watersheds that are relatively undeveloped from an industrial and agricultural perspective, such as wilderness areas, or areas that border county, state, or national forests or preserves. One cautionary note with regard to waterbodies in very remote areas must be made, however. Several studies have monitored what were perceived as pristine watersheds and unexpectedly found elevated chemical contamination in fish tissues at levels of potential human health concern (Datta et al., 1999; Grieb et al., 1990; Henry et al., 1998; Sorensen et al., 1990; Swackhamer and Hites, 1998). Although these waterbodies were removed from direct industrial point source discharges and agricultural nonpoint source pollution, several chemical contaminants such as mercury, toxaphene, and PCBs, can be transported in the atmosphere from highly contaminated areas and be deposited relatively long distances from the actual pollutant sources. This atmospheric transportation of

some chemical contaminants has resulted in the issuance of statewide freshwater advisories for mercury in 10 states (U.S. EPA, 2000).

Most states sample fish from a variety of waters during their annual fish monitoring programs. Not all waterbodies sampled are found to be contaminated to such a degree that issuance of advisories is necessary. It is those waterbodies containing fish with lower chemical residues (below human health screening values) that would potentially fall under the broad category of green areas. Within the green areas, however, there need to be criteria for distinguishing those waterbodies that are only slightly below the human health levels of concern from those that are truly pristine with respect to chemical contaminant levels in fish tissues. Once these green areas have been identified, states can use appropriate information on fish-consuming populations to establish appropriate consumption information.

To designate a waterbody as a green area where unrestricted fish consumption (as defined by the state) is sanctioned, EPA recommends that a state

- Collect a variety of fish species in the waterbody under review for green area status, but particularly target those species that are generally consumed by the local recreational or subsistence fishers using the waterbody.
- Assess levels of contamination for all of the 25 target analytes identified in this guidance document in the sampled fish tissue that are likely to impact that waterbody and compare residue levels to selected human health screening values.
- Conduct a risk assessment of the resulting chemical analysis data to determine whether the waterbody can be designated a green area and to more clearly define “unrestricted consumption” for the fish-consuming population given the specific levels of contamination for each of the target analytes found
- Clearly define for and communicate to the fish-consuming public the definition of “unrestricted consumption” based on the specific assumption used in the risk assessment procedure for the green area waters so that all segments of the fish-consuming public including sensitive populations (e.g., pregnant women/fetuses, nursing mothers, and children) understand the limitations of this unrestricted consumption status.

EPA suggests that the states follow the guidance in this volume for designing a monitoring program (Sections 2, 3, and 6), including the selection and sampling of appropriate target species in adequate numbers and of appropriate size classes. Two distinct screening values are available to the states based on different consumption rates of two distinct fisher populations: recreational fishers and subsistence fishers. State-collected information from creel surveys or interviews with these two distinct populations is most desirable for use in deriving

screening values. (See U.S. EPA, 1998, *Guidance for Conducting Fish and Wildlife Consumption Surveys* for further information.) If local information on these fisher populations is not available, states may use the EPA default consumption rate values of 17.5 g/d and 142.4 g/d for recreational and subsistence populations, respectively, to calculate screening values.

Table B-1 summarizes the screening values (SVs) that states may choose to use to initially identify green areas. Screening values for the 25 target analytes are provided for both recreational and subsistence fishers based on the EPA default consumption rates (see Tables 5-3 and 5-4 in Section 5.2 for additional information on calculating screening values.) These calculated SVs for each of the target analytes should not be exceeded in fish tissues for the respective target fish-consuming population. The SVs listed in the table for target analytes such as inorganic arsenic, chlordane, DDT, dieldrin, heptachlor epoxide, hexachlorobenzene, lindane, toxaphene, oxyfluorfen, and PCBs that have both noncancer and cancer health endpoints are represented by the more conservative or protective of the two calculated SVs.

One concern states must address relates to the detection limit of the analytical method selected for chemical analysis of each target analyte in fish tissue samples. Just because an analyte cannot be detected in fish tissue, does not ensure that the area is safe for unrestricted consumption. For some of the target analytes, especially those calculated using subsistence consumption rates, the SVs are at or below the detection limit for even the most state-of-the-art residue analysis methods (see Table B-1). Thus, the analytical result of a sample being less than the mean detection limit for a particular analyte will not provide the state with adequate information about the actual contaminant level to accurately determine the meal size and meal frequency that can safely be consumed.

States in many cases have been forced by limited monitoring resources to target the collection and analysis of fish tissues to those waterbodies deemed most likely to be contaminated by chemical pollutants. Unlike sampling to determine whether a fish consumption advisory should be issued for a chemical contaminant, which requires only that one chemical be found in exceedance of a human health SV, sampling and analysis to determine green area status must confirm that there are no chemical contaminants in exceedance of the selected human health SVs. It is also important that the state directly monitor the contaminant tissue levels of the various chemical contaminants of concern in fish tissue rather than rely on indirect methods such as measuring water or sediment contaminant levels to estimate the level of fish tissue contamination in a particular waterbody.

EPA further recommends that states clearly define for the fish-consuming population the meaning of "unrestricted consumption." For example, a state may choose a green area designation for their jurisdictional waters that are primarily used by recreational fishers. These waters must then not exceed SVs for

Table B-1. Screening Values for Defining Green Areas Based on Recreational or Subsistence Use of the Waterbody (ppm)

Target Analyte	SV Based on Recreational Fisher Consumption	SV Based on Subsistence Fisher Consumption	Analytical Detection Limits
Arsenic (inorganic)	0.026	3.87×10^{-3} ^a	0.005
Cadmium	4	0.58	0.005
Mercury	0.4	5.8×10^{-2}	0.001
Selenium	20	2.9	0.017
Tributyltin	1.2	0.17	0.002
Chlordane (Total)	0.114	0.016	0.001
DDT (Total)	0.117	0.017	1×10^{-4}
Dicofol	1.6	0.23	0.001
Dieldrin	2.5×10^{-3}	3.07×10^{-4} ^a	1×10^{-4}
Endosulfan (I and II)	24	2.949	0.005
Endrin	1.2	0.147	1×10^{-4}
Heptachlor epoxide	4.39×10^{-3}	5.40×10^{-4} ^a	1×10^{-4}
Hexachlorobenzene	2.50×10^{-2}	3.07×10^{-3}	1×10^{-4}
Lindane	3.07×10^{-2}	3.78×10^{-3}	1×10^{-4}
Mirex	0.8	0.098	1×10^{-4}
Toxaphene	3.63×10^{-2}	4.46×10^{-3} ^a	0.003
Chlorpyrifos	1.2	1.147	0.002
Diazinon	2.8	0.344	0.002
Disulfoton	0.16	0.019	0.002
Ethion	2	0.245	0.002
Terbufos	0.08	0.009	0.002
Oxyfluorfen	0.546	0.067	0.010
PAHs	5.47×10^{-3}	6.73×10^{-4}	1×10^{-6}
PCBs (Total)			
Sum of Aroclors ^a	0.02	2.45×10^{-3} ^a	0.020
Non-ortho coplanar PCBs			2×10^{-6}
Other congeners/ homologues			0.002
Dioxins/Furans	2.56×10^{-7} ^a	3.15×10^{-8} ^a	1×10^{-6}

^a Target analyte (total)s for which the analytical detection limit is likely to be at or above the calculated SV depending on the analytical method selected. States must ensure that the analytical method chosen provides detection limits lower than the selected SVs for all 25 target analytes for designation of green area waters.

recreational fishers and the state must define “unrestricted consumption” for the consumer. For example, the state’s green areas may be defined as areas from which fish consumers may safely eat four 8-ounce fish meals per month (or approximately one fish meal per week) without any additional health risks. This definition must be clearly communicated, particularly to members of high-end fish-consuming groups such as some Native Americans, certain ethnic groups, and subsistence fishers as well as to sensitive populations (pregnant women/fetuses, nursing women and children). The state should clearly define for the public both the **meal size** and **meal frequency** used in their green area designations so that high-end fish consumers do not erroneously assume that the unrestricted consumption designation that is protective of recreational fishers based on their consumption rate is also protective of subsistence fishers. In addition, the state should provide the fish-consuming public with information on the types of fish samples (whole fish, skin-on fillets, skin-off fillets, or other sample types) used to establish the green area designation. Because skinning, trimming, and certain cooking procedures also help reduce chemical residues in fish tissues (EPA, 1999) (see Volume 2 of this series, Appendix C—Dose Modification Due to Food Preparation), the state should also provide information on these procedures particularly to fisher populations who consume whole fish or portions of the fish other than the standard fillet. If the green area concept is to be effective in promoting fishing and the consumption of fish, it is essential that the fish-consuming public be given adequate information to understand the definition of unrestricted fish consumption from these green areas.

One approach is to communicate these locations to the public in fishing brochures annually distributed as part of the existing fish advisory programs. In addition to publishing this information in state fishing brochures, EPA anticipates making this information a new choice of advisory designations available to the states and tribes for incorporation into the National Listing of Fish and Wildlife Advisories (NLFWA) database. EPA realizes that this new designation will be successful only if the states and tribes receive guidance and the information is presented in an easily implemented format.

In addition to implementation of green areas within their jurisdictions, states are also encouraged to initiate or expand the use of general fish consumption guidance for all fish. Several states provide advise on catching, cleaning, cooking, and consumption of fish species. In some jurisdictions, states have issued unlimited consumption or restricted consumption advisories for smaller size classes of those species that are particularly popular with consumers. In this way, the state is still encouraging the recreational aspects of fishing and continued consumption of smaller-sized fish within a given species that typically contain lower residues of chemical contaminants. As a result, the public is encouraged to enjoy both the sport of fishing and the health benefits of eating fish within the specific consumption guidance provided by the state.

References

- Burr, M.L., A.M. Fehily, J.F. Gilbert, S. Rogers, R.M. Holliday, P.M. Sweetnam, P.C. Elwood, and N.M. Deadman. 1989. Effects of changes in fat, fish, and fibre intakes on death and myocardial reinfarction: Diet and Reinfarction Trial (DART). *Lancet* 2 (8666):757-761.
- Datta, S., K. Ohyama, D.Y. Dunlap, and F. Matsumura. 1999. Evidence for organochlorine contamination in tissues of salmonids in Lake Tahoe. *Ecotoxicol. and Environ. Safety* 42: 94-101.
- Dolecek, T.A., and G. Granditis. 1991. Dietary polyunsaturated fatty acids and mortality in the Multiple Risk Factor Intervention Trial (MRFIT). *World Rev. Nutr. Diet* 66:205-216.
- Grieb, T.M., C.T. Driscoll, S.P. Gloss, C.L. Schofield, G.L. Bowie, and D.B. Porcella. 1990. Factors affecting mercury accumulation in fish in the Upper Michigan Peninsula. *Environ. Toxicol. Chem.* 9:919-930.
- Henry, K.S., K. Kannan, B.W. Nagy, N.R. Kevern, M.J. Zabik, and J.P. Giesy. 1998. Concentrations and hazard assessment of organochlorine contaminants and mercury in smallmouth bass from a remote lake in the Upper Peninsula of Michigan. *Arch. Environ. Contam Toxicol.* 34:81-86.
- Kimbrough, R.D. 1991. Consumption of fish: Benefits and perceived risk. *J. Toxicol. Environ. Health* 33 (1):81-91.
- Knapp, H.R., and G.A. Fitzgerald. 1989. The antihypertensive effects of fish oil. A controlled study of polyunsaturated fatty acid supplements in essential hypertension. *N. Engl. J. Med.* 320 (16):1037-1043.
- Kromhout, D. 1993. Epidemiological aspects of fish in the diet. *Proc. Nutr. Soc.* 52 (3):437-439.
- Kromhout, D., E.B. Bosschieter, and C.dL. Coulander. 1985. The inverse relation between fish consumption and 20-year mortality from coronary heart disease. *N. Engl. J. Med.* 312 (19):1205-1209.
- McVeigh, G. 1990. Arthritis and diet: a new look. *Prevention* 42 (10):40-45.
- Norell, S.E., A. Ahlbom, M. Feychting, and N.L. Pedersen. 1986. Fish consumption and mortality from coronary heart disease. *Br Med. J. (Clin. Res. Ed.)* 293(6544):426.

Shekelle, R.B., L. Missell, O. Paul, A. M. Shryock, and J. Stamler. 1985. Fish consumption and mortality from coronary heart disease (letter). *N. Engl. J. Med.* 313 (13):820

Simopoulos, A.P. 1991. Omega-3 fatty acids in health and disease and in growth and development. *Am. J. of Clin. Nutr.* 54(3):438-463.

Sorensen, J.A., G.E. Glass, K.W. Schmidt, J.K. Huber, and G.R. Rapp Jr. 1990. Airborne mercury deposition and watershed characteristics in relation to mercury concentrations in water, sediments, plankton, and fish of eighty northern Minnesota lakes. *Environ. Sci. Technol.* 24:1716-1727.

Swackhamer, D.L., and R.A. Hites. 1988. Occurrence and bioaccumulation of organochlorine compounds in fishes from Siskiwit Lake, Isle Royale, Lake Superior. *Environ. Sci. Technol.* 22:543-548.

U.S. EPA (Environmental Protection Agency). 1998. *Guidance for Conducting Fish and Wildlife Consumption Surveys*. EPA-823-B-98-007. Office of Water, Washington, DC.

U.S. EPA (Environmental Protection Agency). 2000. *Guidance for Assessing Chemical Contaminant Data for Use in Fish Advisories—Risk Assessment and Fish Consumption Limits*. Volume 2. 3rd Edition, EPA-823-B-99-009. Office of Water, Washington, DC.

APPENDIX C

USE OF INDIVIDUAL SAMPLES IN FISH CONTAMINANT MONITORING PROGRAMS

APPENDIX C

USE OF INDIVIDUAL SAMPLES IN FISH CONTAMINANT MONITORING PROGRAMS

The use of composite samples is often the most cost-effective method for estimating average tissue concentrations of analytes in target species populations to assess chronic human health risks. However, there are some situations in which individual sampling can be more appropriate from both ecological and risk assessment perspectives. Individual sampling provides a direct measure of the range and variability of contaminant levels in target fish populations. Information on maximum contaminant concentrations in individual fish is useful in evaluating acute human health risks. Estimates of the variability of contaminant levels among individual fish can be used to ensure that studies meet desired statistical objectives. For example, the population variance of a contaminant can be used to estimate the sample size needed to detect statistically significant differences in the mean contaminant concentration compared to the contaminant screening values. Finally, the analysis of individual samples may be desirable, or necessary, when the objective is to minimize the impacts of sampling on certain vulnerable target populations, such as predators in headwater streams and aquatic turtles, and in cases where the cost of collecting enough individuals for a composite sample is excessive.

Analyzing individual fish incurs additional expenses, particularly when one considers that a number of individual analyses are required to achieve measurements of a reasonable statistical power. However, the recommendation that states archive the individual fish homogenates from which composite samples are prepared for both screening and intensive studies (see Section 6.1.1.6) would make it possible to perform individual analyses where needed without incurring additional sampling costs.

Individual analysis is especially well-suited for intensive studies, in which results from multiple stations and time periods are to be compared. The remainder of this appendix discusses how the sampling design might be affected by analyzing individual rather than composite samples and how contaminant data from individuals versus composites might be used in risk assessments.

C.1 SAMPLING DESIGN

There are seven major components of the sampling design for a fish or shellfish monitoring program: site selection, target species, target analytes, target analyte screening values (SVs), sampling time, sampling type and size class, and repli-

cate samples. Of these, only the number of replicate samples and possibly the target species would be expected to differ if individual samples were analyzed rather than composites. Target species becomes a limiting factor when individuals of the target species are not large enough to provide adequate tissue mass for all the required chemical analyses.

The five factors that determine the optimal number of fish or shellfish to analyze are presented in Section 6.1.2.7. Briefly, the five factors are

- Cost components
- Minimum detectable difference between measured site-specific mean target analyte concentration and SV
- Level of significance
- Population variance
- Power of the hypothesis test.

Each of these characteristics will be examined in detail for the collection and analysis of individual samples.

C.1.1 Cost Components

The cost of obtaining contaminant data from individual fish or shellfish is compared to the cost of obtaining contaminant data from composite samples in Table C-1. These costs are dependent on the separate costs of collecting, preparing, and analyzing the samples.

Table C-1. Relative Cost of Obtaining Contaminant Data from Individual Versus Composite Samples

Cost component	Relative cost	
	Composite samples	Individual samples
Collection	Moderate to high	Low to moderate
Preparation	Very low to moderate	Very low to low
Analysis	Low to moderate	Moderate to high

Typically, the cost of collecting individual samples will be less than that of collecting composite samples when the target species is scarce or difficult to capture. The cost of collecting individuals may not be a factor if the sample collection method used typically allows for the collection of a large number of individuals in a short period of time. In some situations, seines or gill nets might have this characteristic. Also, in estuaries, coastal water, or large lakes where productivity is high, the additional cost of collecting large numbers of individuals for composite sampling may be minimal compared to the effort expended for collecting individual samples.

The cost of preparing individual samples for analysis is typically lower than either the costs of collection or analysis. Generally, the cost of preparing composite samples for analysis will be greater than that of preparing individual samples. Sample preparation procedures can range in complexity from the grinding of whole fish to delicate and time-consuming operations to resect specific tissues. Costs of composite sampling depend largely on the number of individuals required per composite sample and the number of replicate composite samples required to achieve the desired statistical power; however, these costs can be somewhat controlled (see Section 6.1.2.7).

The cost of analyzing individual samples is also typically higher than the cost of analyzing composite samples. The cost differential between the two approaches is directly correlated to the cost for the analysis of a single sample. For some intensive studies, the number of target analytes exceeding the SV is small, so few analyses are required. In these cases, the relative costs between the two approaches may not differ greatly if the number of samples analyzed using the two different approaches is similar (e.g., three to five samples). A sampling design with such a small number of individual samples would be appropriate only if the expected mean target analyte concentration was much greater than the SV.

C.1.2 Minimum Detectable Difference

The difference between the mean target analyte concentration at a site and the SV will not often be known before the screening study has been performed. The minimum detectable difference between the mean concentration and the SV will depend on the level of significance (see Section C.1.3), population variance (Section C.1.4), and the number of replicates collected. In practice, the sample size is often determined by establishing the minimum detectable difference prior to the study according to the objectives of the project. For an SV that has not been multiplied by an uncertainty factor, the cost of detecting a 10 percent difference may be warranted. The issue of minimum detectable difference is discussed in greater detail in Section C.1.5.

C.1.3 Level of Significance

The level of significance (LS) refers to the probability of incorrectly rejecting the null hypothesis that there is no difference between the mean target analyte concentration and the SV. This probability is also called Type I error. The LS can be thought of as the chance of a "false positive" or of detecting a difference that does not exist. The LS affects the sampling design by modifying the required power (thus impacting the sample size) of the statistical test to detect a significant difference between the mean target analyte concentration and the SV (see Section C.1.5). A typical LS used in biological sampling is 0.05. In some cases, an LS other than 0.05 could be appropriate. If the ramifications of a statistically significant difference are severe, a more conservative LS (e.g., 0.01) might be used. On the other hand, if the statistical test is being conducted to identify

whether additional sampling should be performed (i.e., a screening survey), then a less conservative LS (e.g., 0.10) might be used.

C.1.4 Population Variance

The variability in target analyte concentrations within a given fish or shellfish population is a critical factor in determining how many individual samples to collect and analyze. The population variance directly affects the power of the statistical test to detect a significant difference between the mean target analyte concentration and the SV (see Section C.1.5) by impacting the sample size. The population variance may not be known prior to sampling, but it can be estimated from similar data sets from the same target species, which could in many cases be obtained by analyzing individual fish homogenates if these have been archived as recommended in Section 6.1.1.6. In using historical data to estimate population variance, it is important to consider contaminant data only from individual fish or shellfish of the same species. By its very nature, a data set consisting of replicate composite samples tends to smooth out the variability inherent in a group of individual organisms. An extreme example of this phenomenon was presented by Fabrizio et al. (1995) in a study on procedures for compositing fish samples. They used computer simulations to predict PCB concentrations in composite samples of striped bass that had previously been analyzed individually. The predicted variance in these concentrations in the composite samples was approximately 20 percent of the variance obtained from individual analyses.

C.1.5 Power of Statistical Test

Another critical factor in determining the sample size is the power of the statistical test, that is, the probability of detecting a true difference between the mean target analyte concentration and the SV. Because of its profound influence on sample size, it is the power of the test that may ultimately control whether the objectives of the survey are met. The effect of joint consideration of the desired power, the population variance, and the minimum detectable difference on the sample size is described by the following formula (Steel and Torrie, 1980):

$$n = \frac{(Z_{\alpha} + Z_{\beta})^2 2\sigma^2}{\delta^2}$$

where

- n = sample size
- Z_{α} = Z statistic for Type I error (α)
- Z_{β} = Z statistic for Type II error (β)
- σ^2 = population variance (estimated from historical data)
- δ = minimum detectable difference between mean target analyte concentration and SV.

Recall that the Type I error is equal to the LS, and the value is generally between 0.01 and 0.10. Type II error is the probability of accepting the null hypothesis (that there is no difference between the mean target population concentration and the SV) when it is actually false. This type of error can be thought of as the chance of a "false negative," or not detecting a difference that does in fact exist. The complement of Type II error ($1-\beta$) is the power of the statistical test.

The above equation for determining sample size was solved for powers ranging from 0.5 to 0.9 (50 to 90 percent; Figure C-1) assuming an LS of 0.05. The values for σ (standard deviation) and δ were set relative to the SV. A similar exercise was performed in Section 6.1.2.7 and two examples were provided. In example A, both the standard deviation and minimum detectable difference were set to 0.5 SV. Example A corresponds to a ratio of 1 on the x-axis of Figure C-1. Applying example A to the collection of individual fish, the recommended sample size would range from approximately 6 individual samples for a power of 50 percent to 18 individual samples for a power of 90 percent (Figure C-1). In example B, the standard deviation was set to 1.0 SV, while the minimum detectable difference was kept at 0.5 SV. Example B corresponds to a ratio of 2 on the x-axis of Figure C-1. Applying example B to the collection of individual samples, the sample size would have to be almost 40 individual samples to achieve even a modest statistical power (i.e., 70 percent).

It is common to set the power of the statistical test to at least 80 percent (Fairweather, 1991). Figure C-1 indicates that, to achieve a statistical power of 80 percent using the variability assumptions in examples A and B, 13 and 50 fish would have to be collected, respectively. The estimated sample sizes for individual fish or shellfish is similar to those calculated for composite samples (see Section 6.1.2.7). For example A as applied to composite samples, 12 to 18 fish would have to be collected. For example B as applied to composite samples, 30 to 50 fish would have to be collected. Thus, the cost of collecting the fish to achieve a power of 80 percent would not be significantly different for composite versus individual samples (see Section C.1.1). The number of analyses, however, would be considerably less for composite samples (3 to 10 analyses of composite samples versus 13 or 50 analyses of individual samples).

Figure C-1 also indicates that 10 or fewer individual fish or shellfish should be analyzed only if the ratio of the standard deviation to the minimum detectable difference is 0.85 or less. For ratios less than 0.5, the effect of sample size on the statistical power is minor. If the expected mean target analyte concentration is many times greater than the SV, it may not be necessary to allocate resources toward the collection and analysis of more than a minimum number (e.g., three to five samples) of individual fish or shellfish.

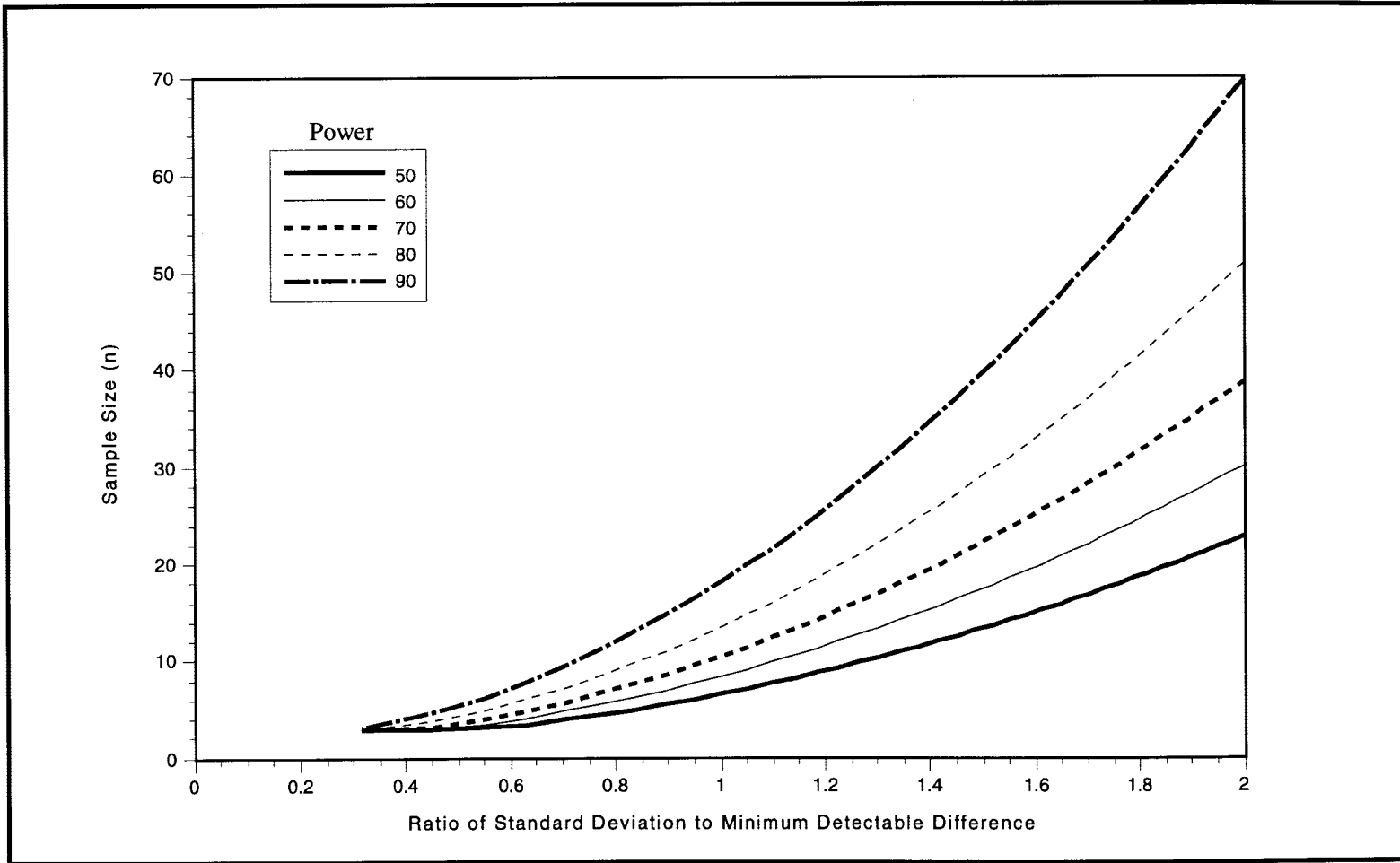

Figure C-1. Recommended sample sizes to achieve various statistical powers.

C.2 USE OF CONTAMINANT DATA FROM INDIVIDUAL FISH/SHELLFISH IN RISK ASSESSMENTS

Target analyte concentrations in composite samples represent averages for specific target species populations. The use of these values in risk assessments is appropriate if the objective is to estimate the average concentration to which consumers of the target species might be exposed over a long period of time. The use of long exposure durations (e.g., 30 to 70 years) is typical of the assessment of carcinogenic target analytes, the health effects of which may be manifested over an entire lifetime (see Volume 2 of this series). Target analytes that produce noncarcinogenic effects, on the other hand, may cause acute effects to human health over a relatively short period of time on the order of hours or days. The use of average contaminant concentrations derived from the analysis of composite samples may not be protective against acute health effects because high concentrations in an individual organism may be masked by lower concentrations in other individuals in the composite sample. Contaminant data from individual samples permits the use of alternative estimates of contaminant concentration for a group of fish or shellfish (e.g., maximum). Therefore, the decision whether to collect and analyze individual fish or shellfish may depend on the target analytes included in the monitoring program.

EPA has recommended that 25 target analytes be included in screening studies (see Section 4). All of the target analytes except PCBs, PAHs, and dioxins/furans have reference doses for noncarcinogenic health effects, although the carcinogenic risk is likely to be greater than the noncarcinogenic risk for eight other target analytes (see Tables 5-2 and 5-3). EPA's reassessment of the health effects of 2,3,7,8-TCDD (dioxin) indicated that this chemical may also pose a significant noncarcinogenic health risk in some cases (U.S. EPA, 1994).

C.3 EXAMPLE CASE STUDY

The presentation of a case study will illustrate some of the sample size and data interpretation issues discussed in Sections C.1 and C.2, respectively. A State has prepared a composite sample of target species A from a particular waterbody of concern. This composite sample was analyzed for all 25 target analytes listed in Table 4-1. Of the 25 target analytes, only cadmium was detected at a concentration exceeding the state selected SV (10 ppm) for cadmium. Cadmium was detected at 20 ppm, twice the SV calculated for cadmium. Because the SV for at least one target analyte was exceeded, an intensive study was warranted. The state decided to collect and analyze individual fish in the intensive study for the following reasons: (1) the cost of collecting individual fish is less than the cost of collecting fish for composites, (2) the analytical costs for analyzing cadmium are relatively low (<\$50 sample), and (3) the cadmium concentrations in individual fish should more accurately reflect the potential acute (noncarcinogenic) health risk from cadmium than the mean cadmium concentration derived from composite samples.

The first issue the state must decide is how many individual fish to collect and analyze. The important factors in this decision are the minimum detectable difference the state wishes to test and the variability in cadmium concentrations within the target species population. The first factor can be obtained from the results of the screening survey. The state wishes to test whether the difference between the concentration detected in the single composite sample (20 ppm) and the selected SV (10 ppm) is significant. This assumes that the mean cadmium concentration for the individual is also 20 ppm. The expected standard deviation (8 ppm) was obtained from a previous investigation performed on individuals of the target species and was equal to 0.8 of the SV (10 ppm). Using Figure C-1, it can be seen that, for a ratio of standard deviation ($0.8 \times SV$) to detectable difference ($1.0 \times SV$) of 0.8, the sample size necessary to achieve a statistical power of 80 percent would be eight fish.

The state determines that the mean cadmium concentration of eight individual fish of the target species is 30 ppm and the standard deviation is equal to the predicted value of 8 ppm. The state performs a *t*-test to determine if the mean concentration is significantly greater than the SV. As described in Section 6.1.2.7, the statistic

$$(\text{mean} - \text{SV})/\text{standard deviation}$$

has a *t*-distribution with $n-1$ degrees of freedom. For this example, the *t* statistic is 2.5 ($[(30-10)/8]$) with 7 degrees of freedom. This value exceeds the critical *t*-statistic (1.895) for a one-tailed LS of 0.05. Therefore, the state determines that the mean cadmium concentration for these eight individual fish of the target species is significantly greater than the SV and a risk assessment is performed.

C.4 REFERENCES

- Fabrizio, M.C., A.M. Frank, and J.F. Savino. 1995. Procedures for formation of composite samples from segmented populations. *Environmental Science and Technology* 29(5):1137-1144.
- Fairweather, P.G. 1991. Statistical power and design requirements for environmental monitoring. *Aust. J. Freshwater Res.* 42:555-567.
- Steel, R.G.D., and J.H. Torrie. 1980. *Principles and Procedures of Statistics. A Biometrical Approach*. Second Edition. McGraw-Hill Book Company. New York, NY. 633 pp.
- U.S. EPA (U.S. Environmental Protection Agency). 1994. *Health Assessment for 2,3,7,8-TCDD and Related Compounds*. Public Review Draft. EPA/600/EP-92/001.

APPENDIX D

FISH AND SHELLFISH SPECIES FOR WHICH STATE CONSUMPTION ADVISORIES HAVE BEEN ISSUED

APPENDIX D

FISH AND SHELLFISH SPECIES FOR WHICH STATE CONSUMPTION ADVISORIES HAVE BEEN ISSUED

FRESHWATER FINFISH SPECIES FOR WHICH STATE CONSUMPTION ADVISORIES HAVE BEEN ISSUED

1993 and 1998 (**Bold type**)

1998 only (Normal type)

1993 only (*Italic type*)

- AL **fish species (unspecified), catfish (unspecified), bigmouth buffalo, brown bullhead, channel catfish, white bass**
smallmouth buffalo, channel catfish, largemouth bass, spotted bass, striped bass, crappie, king mackerel
- AK **no consumption advisories**
- AS fish species (unspecified), shellfish (unspecified)
- AZ **fish species (unspecified)**
largemouth bass, yellow bullhead, channel catfish, black crappie, bluegill sunfish, green sunfish, redear sunfish
- AR **fish species (unspecified)**
bass (unspecified), black bass, largemouth bass, bowfin, buffalo, catfish (unspecified), blue catfish, channel catfish, flathead catfish, crappie, freshwater drum, gar, pickerel, redhorse, sucker, sunfish
- CA **goldfish, Sacramento blackfish, brown bullhead, crappie (unspecified), hitch, largemouth bass, smallmouth bass, channel catfish, white catfish, trout (unspecified), rainbow trout, croaker (unspecified), orangemouth corvina, sargo, tilapia (unspecified), fish species (unspecified)**
brown trout, bullhead (unspecified), white crappie, black crappie, carp (unspecified), corbina, striped bass, kelp bass, gobies, queenfish, rockfish, sculpin, shark, shellfish (unspecified), surfperch
squawfish, sucker (unspecified)

-
- CO **rainbow trout, yellow perch, northern pike, walleye, smallmouth bass, largemouth bass, black crappie, kokanee salmon, channel catfish, fish species (unspecified)**
bullhead, common carp, crappie (unspecified), brown trout
trout (unspecified)
- CT **common carp, fish species (unspecified)**
largemouth bass, smallmouth bass, striped bass, bluefish, bullhead, catfish (unspecified), American eel, chain pickerel, trout (unspecified)
- DE **white catfish, channel catfish, fish species (unspecified)**
striped bass, white perch, carp (unspecified), largemouth bass, catfish (unspecified)
- DC **American eel**
carp (unspecified), catfish (unspecified)
channel catfish, common carp
- FL **largemouth bass, gar, bowfin, warmouth sunfish, yellow bullhead, Mayan cichlid, oscar, spotted sunfish**
gafftopsail catfish, jack crevalle, ladyfish, Spanish mackerel, king mackerel, spotted sea trout, shark
- GA **common carp, largemouth bass, catfish (unspecified), fish species (unspecified)**
hybrid bass, redeye bass, shoal bass, spotted bass, striped bass, Suwannee bass, white bass, bowfin, smallmouth buffalo, bullhead (unspecified), brown bullhead, spotted bullhead, yellow bullhead, channel catfish, flathead catfish, white catfish, black crappie, Atlantic croaker, black drum, red drum, flounder, striped mullet, silver perch, chain pickerel, grayfin redhorse, silver redhorse, spotted sea trout, greater jumprock sucker, spotted sucker, sunfish, redbreast sunfish, rainbow trout, walleye, clams, blue crab, mussels, oysters, shrimp
- GU **no consumption advisories**
- HI all fish species (unspecified), shellfish (unspecified)
- ID smallmouth bass, catfish (unspecified), black crappie, white crappie, yellow perch
- IL **lake trout, coho salmon, chinook salmon, brown trout, common carp, catfish (unspecified), channel catfish, shovelnose sturgeon, bluegill, freshwater drum, largemouth bass, spotted bass, alewife**
white bass, blue catfish, black crappie, white crappie, yellow perch, sauger, smelt
bigmouth buffalo, flathead catfish, smallmouth buffalo, crappie (unspecified)
-

-
- IN **fish species (unspecified), common carp, catfish (unspecified), coho salmon, brown trout, lake trout, chinook salmon, channel catfish**
largemouth bass, rock bass, smallmouth bass, spotted bass, striped bass, hybrid striped bass, white bass, yellow bass, bloater, bowfin, bigmouth buffalo, black buffalo, smallmouth buffalo, bullhead (unspecified), black bullhead, yellow bullhead, carp (unspecified), carpsucker, quillback carpsucker, river carpsucker, flathead catfish, creek chub, black crappie, white crappie, freshwater drum, round goby, northern hogsucker, paddlefish, yellow perch, northern pike, redhorse (unspecified), black redhorse, golden redhorse, river redhorse, shorthead redhorse, silver redhorse, sauger, gizzard shad, shovelnose sturgeon, blue sucker, longnose sucker, spotted sucker, white sucker, bluegill sunfish, green sunfish, longear sunfish, brook trout, rainbow trout, steelhead trout, walleye, whitefish (unspecified), lake whitefish
- IA **common carp, fish species (unspecified)**
quillback carpsucker
channel catfish, carpsucker (unspecified)
- KS **buffalo (unspecified), common carp, freshwater drum, carpsucker (unspecified)**
blue catfish, channel catfish, flathead catfish, bullhead catfish, shovelnose sturgeon
catfish (unspecified), sturgeon (unspecified)
- KY **channel catfish, paddlefish, white bass, common carp, fish species (unspecified)**
largemouth bass
- LA **bass (unspecified), fish species (unspecified)**
largemouth bass, spotted bass, striped bass, white bass, bowfin, bigmouth buffalo, carp (unspecified), channel catfish, flathead catfish, crappie, black crappie, white crappie, freshwater drum, gar, king mackerel, shad, shellfish (unspecified), bluegill sunfish, redear sunfish
- ME **fish species (unspecified)**
striped bass, bluefish, American lobster, freshwater fish, cold water fish, warm water fish
- MD **channel catfish, American eel, black crappie, common carp**
bullhead (unspecified), sunfish (unspecified)
-

- MA brown trout, yellow perch, white sucker, American eel, smallmouth bass, largemouth bass, lake trout, channel catfish, brown bullhead, common carp, white catfish, fish species (unspecified)**
bottom fish, bass (unspecified), yellow bullhead, black crappie, flounder, white perch, scup, chain pickerel, bivalves (unspecified), lobster (unspecified), American lobster, tautog
- MI common carp, rock bass, yellow perch, largemouth bass, smallmouth bass, walleye, northern pike, muskellunge, white bass, longnose sucker, white perch, brown bullhead, bullhead (unspecified), bluegill, brown trout, siscowet trout, lake trout, coho salmon, chinook salmon, splake, catfish (unspecified), rainbow trout, sucker (unspecified), gizzard shad, freshwater drum, white sucker, lake whitefish**
fish species (unspecified), yellow bullhead, burbot, quillback carpsucker, channel catfish, black crappie, white crappie, redhorse, smelt, lake sturgeon
crappie (unspecified), sauger, carpsucker (unspecified), sturgeon (unspecified), brook trout
- MN yellow perch, brown bullhead, black bullhead, yellow bullhead, quillback carpsucker, brown trout, brook trout, lake trout, chinook salmon, ciscowet, walleye, northern pike, muskellunge, splake, smallmouth bass, largemouth bass, rock bass, white bass, rainbow trout, white sucker, bluegill, black crappie, white crappie, shorthead redhorse, silver redhorse, common carp, smallmouth buffalo, sauger, bigmouth buffalo, channel catfish, lake whitefish, freshwater drum, pumpkinseed, lake herring, flathead catfish, bowfin, siscowet trout**
bass (unspecified), burbot, carp (unspecified), cisco, crappie (unspecified), redhorse, golden redhorse, coho salmon, lake sturgeon
tullibee, redhorse sucker, chub bloater
- MS fish species (unspecified), catfish (unspecified)**
largemouth bass, spotted bass, king mackerel
buffalo (unspecified)
- MO sturgeon (unspecified),, buffalo (unspecified), sucker (unspecified), paddlefish, catfish (unspecified), redhorse, freshwater drum**
carp (unspecified), fish species (unspecified), sunfish
common carp, channel catfish, flathead catfish
- MT fish species (unspecified), largemouth bass, smallmouth bass, burbot, black crappie, yellow perch, northern pike, kokanee salmon, white sucker, brook trout, brown trout, bull trout, cutthroat trout, lake trout, rainbow trout, walleye, lake whitefish, mountain whitefish**

-
- NE **common carp, channel catfish**
largemouth bass, catfish (unspecified), northern pike, fish species (unspecified)
- NV **fish species (unspecified)**
- NH freshwater fish (unspecified), largemouth bass, bluefish, American lobster
fish species (unspecified)
- NJ **striped bass, American eel, white perch, white catfish, fish species (unspecified)**
largemouth bass, bluefish, chain pickerel, blue crab, crustaceans (unspecified), American lobster, molluscs (unspecified)
- NM **white crappie, channel catfish, common carp, brown trout, river carpsucker, kokanee salmon, largemouth bass, bluegill, white bass, white sucker, yellow perch, black bullhead, black crappie, bass (unspecified), crappie (unspecified), rainbow trout, longnose dace, walleye, northern pike, bullhead (unspecified), black bass**
smallmouth bass, spotted bass
trout (unspecified), carpsucker (unspecified)
- NY **common carp, lake trout, brown trout, yellow perch, smallmouth bass, splake, American eel, goldfish, striped bass, white perch, bluefish, largemouth bass, brown bullhead, white catfish, walleye, rainbow smelt, tiger muskellunge, white sucker, chinook salmon, coho salmon, rainbow trout**
fish species (unspecified), sportfish (unspecified), channel catfish, Atlantic needlefish, blue crab, American lobster, brook trout
northern pike
- NC **largemouth bass, fish species (unspecified)**
bowfin, common carp, catfish (unspecified), white catfish, black crappie, white crappie, green sunfish, redear sunfish
- ND **walleye, white bass, yellow perch, northern pike, bigmouth buffalo, common carp, crappie (unspecified), white sucker, channel catfish, goldeye, sauger, smallmouth bass**
largemouth bass, brown bullhead, black crappie, white crappie, paddlefish, bluegill, brown trout, rainbow trout
bullhead (unspecified), chinook salmon, carpsucker (unspecified), sunfish (unspecified)

-
- OH **common carp, catfish (unspecified), white bass, sucker (unspecified), fish species (unspecified)**
largemouth bass, rock bass, smallmouth bass, spotted bass, hybrid striped bass, brown bullhead, yellow bullhead, channel catfish, flathead catfish, white crappie, freshwater drum, white perch, chinook salmon, coho salmon, sauger, white sucker, lake trout, steelhead trout, walleye
- OK **largemouth bass**
catfish (unspecified)
channel catfish, fish species (unspecified)
- OR **fish species (unspecified), crayfish**
largescale sucker, brown trout, black crappie, squawfish, largemouth bass, smallmouth bass, common carp, peamouth chub
- PA **white sucker, white perch, common carp, American eel, channel catfish, goldfish, largemouth bass, quillback carpsucker, white bass, lake trout, walleye, smallmouth bass, shorthead redhorse, sucker (unspecified), fish species (unspecified)**
spotted bass, hybrid striped bass, bowfin, flathead catfish, crappie, freshwater drum, muskellunge, northern pike, coho salmon, sauger, sunfish, bluegill, brown trout, rainbow trout, lake whitefish
green sunfish
- PR **no fish consumption advisories**
- RI **striped bass**
fish species (unspecified), bluefish
- SC **fish species (unspecified)**
largemouth bass, bowfin, catfish (unspecified), channel catfish, bluegill sunfish, redear sunfish
shellfish (unspecified)
- SD **no fish consumption advisories**
- TN **catfish (unspecified), largemouth bass, common carp, striped bass, sauger, white bass, smallmouth buffalo, fish species (unspecified)**
hybrid striped bass, redbreast sunfish
crappie (unspecified), rainbow trout
- TX **catfish (unspecified), fish species (unspecified)**
largemouth bass, hybrid striped bass, white bass, freshwater drum, king mackerel, crab (unspecified), blue crab
-

-
- UT **fish species (unspecified)**
- VT **brown trout, lake trout**
fish species (unspecified)
walleye
- VA **fish species (unspecified)**
smallmouth bass, striped bass, white bass, common carp, channel catfish,
flathead catfish
- VI **no fish consumption advisories**
- WA bottomfish species (unspecified), common carp, rockfish, shellfish
(unspecified), crab (unspecified), sucker, bridgelip sucker, lake whitefish,
mountain whitefish
no fish consumption advisories in 1993
- WV **channel catfish, common carp, sucker (unspecified), fish species
(unspecified)**
bottomfish species (unspecified), non-sportfish (unspecified), largemouth
bass, smallmouth bass, hybrid striped bass, white bass, flathead catfish,
freshwater drum, sauger
brown bullhead
- WI **coho salmon, chinook salmon, common carp, catfish (unspecified),
splake, rainbow trout, lake trout, brown trout, siscowet trout, northern
pike, white bass, white sucker, walleye, yellow perch, muskellunge,
flathead catfish, freshwater drum, channel catfish, bullhead
(unspecified), bluegill, black crappie, crappie (unspecified), rock bass,
smallmouth bass, redhorse (unspecified), largemouth bass, lake
sturgeon, buffalo (unspecified), fish species (unspecified)**
bigmouth buffalo, brown bullhead, carp (unspecified), chub, lake herring,
white perch, northern redhorse, sauger, sheepshead, smelt, green sunfish,
pumpkinseed, lake whitefish, panfish species (unspecified)
brook trout
- WY **no fish consumption advisories**

**ESTUARINE/MARINE FISH AND SHELLFISH SPECIES FOR WHICH STATE
CONSUMPTION ADVISORIES HAVE BEEN ISSUED**

1993 and 1998 (**Bold type**)

1998 only (Normal type)

1993 only (*Italic type*)

- AL king mackerel
no consumption advisories in 1993
- AK **no consumption advisories**
- AS **fish and shellfish species (unspecified)**
- CA **white croaker, black croaker, corbina, surfperch, queenfish, sculpin,
rockfish, kelp bass, striped bass, fish and shellfish species
(unspecified)**
bullhead, croaker (unspecified), gobies, shark
- CT **striped bass, bluefish**
- DE fish species (unspecified), striped bass, channel catfish, white catfish, white
perch, carp, catfish (unspecified), largemouth bass
no consumption advisories in 1993
- DC no consumption advisories in 1998
channel catfish, American eel
- FL **shark (unspecified)**
gafftopsail catfish, crevalle jack, ladyfish, king mackerel, Spanish mackerel,
spotted sea trout, yellow bullhead, gar, warmouth sunfish, bowfin
- GA Atlantic croaker, black drum, red drum, flounder, silver perch, spotted sea
trout, clams, blue crab, mussels, oysters
no consumption advisories in 1993
- GU **no consumption advisories**
- HI fish and shellfish species (unspecified)
no consumption advisories in 1993
- LA **fish and shellfish species (unspecified)**
king mackerel
- ME striped bass, bluefish, American lobster,
no consumption advisories in 1993
- MD **channel catfish, American eel**

-
- MA **American eel, flounder, American lobster, bivalves (unspecified), fish species (unspecified)**
bottomfish (unspecified), scup, tautog
- MS king mackerel
no consumption advisories in 1993
- NH bluefish, American lobster
no consumption advisories in 1993
- NJ **striped bass, bluefish, American eel, white perch, white catfish, blue crab**
American lobster
fish and shellfish species (unspecified)
- NY **American eel, striped bass, bluefish, white perch, white catfish, rainbow smelt, Atlantic needlefish, blue crab**
American lobster, fish species (unspecified), largemouth bass, smallmouth bass, common carp, goldfish, walleye
- NC **fish species except herring, shad, striped bass, and shellfish species (unspecified)**
- OR **no consumption advisories**
- PA **white perch, channel catfish, American eel**
- PR **no consumption advisories**
- RI **striped bass, bluefish**
- SC bluegill, bowfin, largemouth bass
fish and shellfish species (unspecified)
- TX **blue crab, catfish (unspecified), fish species (unspecified)**
crab (unspecified), king mackerel
- VA no consumption advisories
fish species (unspecified)
- VI **no consumption advisories**
- WA bottomfish species (unspecified), rockfish, shellfish (unspecified), crab (unspecified)
no consumption advisories in 1993

SOURCES

RTI (Research Triangle Institute). 1993. *National Listing of State Fish and Shellfish Consumption Advisories and Bans*. (Current as of July 22, 1993.) Research Triangle Park, NC.

U.S. EPA (Environmental Protection Agency). 1999. *National Listing of Fish and Wildlife Consumption Advisories Database*. Office of Water. Washington, DC.

APPENDIX E

TARGET ANALYTES ANALYZED IN NATIONAL OR REGIONAL MONITORING PROGRAMS

Table E-1. Target Analytes Analyzed in National or Regional Monitoring Programs Reviewed by the 1993 Fish Contaminant Workgroup

Analyte	Monitoring program							
	a	b	c ¹	d	e	f	g	h
Metals								
Aluminum (Al)				●				●
Antimony (Sb)	●			●				●
Arsenic (As) (total)	●		●	●		●		●
Barium (Ba)								●
Beryllium (Be)	●							●
Cadmium (Cd)	●		●	●		●		●
Chromium (Cr)	●		●	●				●
Copper (Cu)	●		●	●		●		●
Cyanide	●							
Iron (Fe)				●				●
Lead (Pb)	●		●	●		●		●
Manganese (Mn)			●	●				●
Mercury (Hg)	●	●	●	●		●		●
Methylmercury	●							
Molybdenum								●
Nickel (Ni)	●			●				●
Selenium (Se)	●			●		●		●
Silicon (Si)				●				
Silver (Ag)	●			●				●
Thallium (Tl)	●			●				
Tin (Sn)				●				
Tributyltin								
Vanadium								●
Zinc (Zn)	●			●		●		●
Pesticides								
Aldrin	●		●	●		●	●	
Butachlor								●
Chlordane (cis & trans)	●	●	●	● ²		●	●	●
Chlorpyrifos		●						
Danitol							●	

(continued)

Table E-1. (continued)

Analyte	Monitoring program							
	a	b	c ¹	d	e	f	g	h
DCPA (chlorthal)						●		
DDT (total)			●	●		●		
2,4'-DDD (2,4'-TDE)			●	●		●		●
4,4'-DDD (4,4'-TDE)	●		●	●		●	●	●
2,4'-DDE			●	●		●		●
4,4'-DDE	●	●	●	●		●	●	●
2,4'-DDT			●	●		●		●
4,4'-DDT	●		●	●		●	●	●
Demeton	●							
Dicofol		●					●	●
Dieldrin	●	●	●	●		●	●	●
Diphenyl disulfide		●						
Endosulfan								
α-Endosulfan (endosulfan I)	●							
β-Endosulfan (endosulfan II)	●							
Endosulfan sulfate	●							
Endrin	●	●	●			●		●
Endrin aldehyde	●							
Ethyl-p-nitrophenylphenylphosphorothioate (EPN)							●	
Fonofos								
Guthion	●							
Heptachlor	●	●	●	●		●	●	●
Heptachlor epoxide	●	●		●		●	●	●
Hexachlorocyclohexane (HCH) also known as Benzene hexachloride (BHC)								
α-Hexachlorocyclohexane	●	●	●			●	●	●
β-Hexachlorocyclohexane	●		●				●	●
δ-Hexachlorocyclohexane	●		●					●
γ-Hexachlorocyclohexane (lindane)	●	●	●	●		●	●	●
Technical-hexachlorocyclohexane							●	
Hexachlorophene							●	
Isopropalin		●						●
Kepone								●

(continued)

Table E-1. (continued)

Analyte	Monitoring program							
	a	b	c ¹	d	e	f	g	h
Malathion	●							
Methoxychlor	●	●	●					●
Mirex	●	●	●	●		●	●	●
Nitrofen		●						
cis-Nonachlor		●				●		●
trans-Nonachlor		●		●		●		●
Oxychlorane		●				●		●
Parathion	●							
Toxaphene (mixture)	●		●			●	●	
Triazine herbicides								
Trichloronate								●
Trifluralin		●						●
Base/Neutral Organic Compounds								
Acenaphthene	●			●				●
Acenaphthylene	●			●				●
Anthracene	●			●				●
Benzidine	●							
Benzo(a)anthracene	●			●				●
Benzo(a)pyrene	●			●				●
Benzo(e)pyrene				●				
Benzo(b)fluoranthene	●			●				●
Benzo(k)fluoranthene	●			●				●
Benzo(g,h,i)perylene	●			●				●
Benzyl butyl phthalate	●							
Biphenyl		●		●				
4-Bromophenyl ether	●							
bis(2-Chloroethoxy)methane	●							
bis(2-Chloroethyl)ether	●							
bis(2-Chloroisopropyl)ether	●							
bis(2-Ethylhexyl)phthalate (BEHP)							●	
Chlorinated benzenes								
2-Chloronaphthalene	●							

(continued)

Table E-1. (continued)

Analyte	Monitoring program							
	a	b	c ¹	d	e	f	g	h
4-Chlorophenyl ether	●							
Chrysene	●			●				●
Dibenzo(a,h)anthracene	●			●				●
Di-n-butyl phthalate	●							
1,2-Dichlorobenzene	●							
1,3-Dichlorobenzene	●							
1,4-Dichlorobenzene	●							
3,3'-Dichlorobenzidine	●						●	
Diethyl phthalate	●							
2,6-Dimethylnaphthalene				●				●
2,3,5-Trimethylnaphthalene				●				
Dimethyl phthalate	●							
2,4-Dinitrotoluene	●							
2,6-Dinitrotoluene	●							
Di-n-octyl phthalate	●							
1,2-Diphenylhydrazine	●							
bis(2-Ethylhexyl) phthalate	●							
Fluoranthene	●			●				●
Fluorene	●			●				●
Heptachlorostyrene			●					
Hexachlorostyrene			●					
Hexachlorobenzene	●	●	●	●		●	●	●
Hexachlorobutadiene	●	●						
Hexachlorocyclopentadiene	●							●
Hexachloroethane	●							
Indeno(1,2,3-cd)pyrene	●			●				
Isophorone	●							
4,4'-Methylene bis(N,N'-dimethyl)aniline							●	
1-Methylnaphthalene				●				
2-Methylnaphthalene				●				
1-Methylphenanthrene				●				
Naphthalene	●			●				●

(continued)

Table E-1. (continued)

Analyte	Monitoring program							
	a	b	c ¹	d	e	f	g	h
Nitrobenzene	●							
N-Nitroso-di-n-butylamine							●	
N-Nitrosodimethylamine	●							
N-Nitrosodiphenylamine	●							
N-Nitrosodipropylamine	●							
Octachlorostyrene		●	●					●
PAHs (polycyclic aromatic hydrocarbons)								
PBBs (polybrominated biphenyls)			●					
PCBs (polychlorinated biphenyls)		●	●	●				●
Aroclor 1016 (mixture)	●						●	
Aroclor 1221 (mixture)	●						●	
Aroclor 1232 (mixture)	●						●	
Aroclor 1242 (mixture)	●					●	●	
Aroclor 1248 (mixture)	●					●	●	
Aroclor 1254 (mixture)	●					●	●	
Aroclor 1260 (mixture)	●					●	●	
Selected individual congeners				●				
Pentachloroanisole (PCA)		●				●		●
Pentachlorobenzene		●					●	●
Pentachloronitrobenzene (PCNB)		●						●
Pentachlorophenyl methyl ether								
Pentachlorophenyl methyl sulfide								
Pentachlorostyrene			●					
Perthane		●						●
Perylene				●				
Phenanthrene	●			●				●
Pyrene	●			●				●
Terphenyl			●					
1,2,3,4-Tetrachlorobenzene		●						●
1,2,3,5-Tetrachlorobenzene		●						●
1,2,4,5-Tetrachlorobenzene		●					●	●
1,2,3-Trichlorobenzene		●						

(continued)

Table E-1. (continued)

Analyte	Monitoring program							
	a	b	c ¹	d	e	f	g	h
1,2,4-Trichlorobenzene	●	●						●
1,3,5-Trichlorobenzene		●						●
Triphenyl phosphate								●
Dioxins								
1,2,3,7,8-Pentachlorodibenzodioxin (PeCDD)		●						●
2,3,7,8-Tetrachlorodibenzodioxin (TCDD)	●	●	●		●		●	●
1,2,3,4,6,7,8-Heptachlorodibenzodioxin (HpCDD)		●						●
1,2,3,4,7,8-Hexachlorodibenzodioxin (HxCDD)		●						●
1,2,3,6,7,8-Hexachlorodibenzodioxin (HxCDD)		●						●
1,2,3,7,8,9-Hexachlorodibenzodioxin (HxCDD)		●						●
Dibenzofurans								
1,2,3,4,6,7,8-Heptachlorodibenzofuran (HpCDF)		●						●
1,2,3,4,7,8,9-Heptachlorodibenzofuran (HpCDF)		●						●
1,2,3,4,7,8-Hexachlorodibenzofuran (HxCDF)		●						●
1,2,3,6,7,8-Hexachlorodibenzofuran (HxCDF)		●						●
1,2,3,7,8,9-Hexachlorodibenzofuran (HxCDF)		●						●
2,3,4,6,7,8-Hexachlorodibenzofuran (HxCDF)		●						●
1,2,3,7,8-Pentachlorodibenzofuran (PeCDF)		●						●
2,3,4,7,8-Pentachlorodibenzofuran (PeCDF)		●						●
2,3,7,8-Tetrachlorodibenzofuran (TCDF)		●						●
Acidic Organic Compounds								
Chlorinated phenols								
4-Chloro-3-cresol	●							
2-Chlorophenol	●							
2,4-Dichlorophenol	●							
2,4-Dimethylphenol	●							
4,6-Dinitro-2-cresol	●							
2,4-Dinitrophenol	●							
2-Nitrophenol	●							
4-Nitrophenol	●							
Pentachlorophenol (PCP)	●							●

(continued)

Table E-1. (continued)

Analyte	Monitoring program							
	a	b	c ¹	d	e	f	g	h
Phenol	●							
2,4,6-Trichlorophenol	●							
Volatile Organic Compounds								
Acrolein	●							
Acrylonitrile	●							
Benzene	●							
Bromodichloromethane	●							
Bromoform	●							
Bromomethane	●							
Carbon tetrachloride	●							
Chlorobenzene	●							
Chloroethane	●							
2-Chloroethylvinyl ether	●							
Chloroform	●							
Chloromethane	●							
Dibromochloromethane	●							
1,1-Dichloroethane	●							
1,2-Dichloroethane	●							
1,1-Dichloroethene	●							
trans-1,2-Dichloroethene	●							
1,2-Dichloropropane	●							
cis-1,3-Dichloropropene	●							
trans-1,3-Dichloropropene	●							
Ethylbenzene	●							
Methylene chloride	●							
1,1,2,2-Tetrachloroethane	●							
Tetrachloroethene	●							
Toluene	●							
1,1,1-Trichloroethane	●							
1,1,2-Trichloroethane	●							
Trichloroethene	●							
Vinyl chloride	●							

(continued)

Table E-1. (continued)

-
-
- ¹ Contaminants listed were monitored by at least one Great Lakes state. NOTE: Contaminants monitored exclusively by the Canadian Province of Ontario were not included.
- ² Only the *cis*-isomer is monitored.
- ^a 301(h) Monitoring Program. Source: U.S. EPA. 1985. *Bioaccumulation Monitoring Guidance: 1. Estimating the Potential for Bioaccumulation of Priority Pollutants and 301(h) Pesticides Discharged into Marine and Estuarine Waters*. EPA 503/3-90-001. Office of Marine and Estuarine Protection, Washington, DC.
- ^b National Study of Chemical Residues in Fish. Source: U.S. EPA. 1992. *National Study of Chemical Residues in Fish*. Volumes I and II. EPA 823/R-92-008a and 008b. Office of Science and Technology, Washington, DC.
- ^c Great Lakes Sport Fish Contaminant Advisory Program. Source: Hesse, J. L. 1990. *Summary and Analyses of Existing Sportfish Consumption Advisory Programs in the Great Lakes Basin—the Great Lakes*. Fish Consumption Advisory Task Force, Michigan Department of Health, Lansing, MI.
- ^d NOAA Status and Trends Program. Source: NOAA. 1989. *National Status and Trends Program for Marine Environmental Quality--Progress Report: A Summary of Selected Data on Tissue Contamination from the First Three Years (1986-1988) of the Mussel Watch Project*. NOAA Technical Memorandum NOS OMA 49. U.S. Department of Commerce, Rockville, MD.
- ^e EPA National Dioxin Study. Source: U.S. EPA. 1987. *National Dioxin Study. Tiers 3, 5, 6 and 7*. EPA 440/4-87-003. Office of Water Regulations and Standards, Washington, DC.
- ^f U.S. Fish and Wildlife Service National Contaminant Biomonitoring Program. Sources: C. J. Schmitt, J. L. Zajicek, and P. H. Peterman. 1990. National Contaminant Biomonitoring Program: Residues of organochlorine chemicals in U.S. freshwater fish, 1976-1984. *Arch. Environ. Contam. Toxicol.* 19:748-781; and T. P. Lowe, T. W. May, W. G. Brumbaugh, and D. A. Kane. 1985. National Contaminant Biomonitoring Program: Concentrations of seven elements in freshwater fish, 1978-1981. *Arch. Environ. Contam. Toxicol.* 14:363-388.
- ^g U.S. EPA. 1991. *Assessment and Control of Bioconcentratable Contaminants in Surface Waters*. Draft. Office of Water, Office of Research and Development, Washington, DC.
- ^h U.S. Geological Survey National Water-Quality Assessment Program. Source: J.K. Crawford and S.N. Luoma. 1993. *Guidelines for Studies of Contaminants in Biological tissues for the National Water-Quality Assessment Program*. USGS Open-File Report 92-494. U.S. Geological Survey, Lemoyne, PA.

APPENDIX F

PESTICIDES AND HERBICIDES RECOMMENDED AS TARGET ANALYTES

Table F-1. Pesticides and Herbicides Recommended as Target Analytes

Pesticide	Family	Use	Registration	EPA toxicity class ^a	EPA carcinogenicity classification ^b
Metal Containing Pesticides					
Arsenicals (including arsenic acid, arsenic trioxide, copper acetoarsenite, lead arsenate, calcium arsenate, sodium arsenite)	Inorganic arsenicals	A variety of inorganic arsenic compounds are used as herbicides, fungicides, insecticides and rodenticides, but registered uses of some were superseded because of their hazard to man and other nontarget species (<i>Farm Chemicals Handbook</i> , 1989)	Some inorganic arsenic compound registrations have been canceled; others are under restricted use application and others are in special review (U.S. EPA, 1993)	I	A
Tributyltins (tribylytin oxide)	Organotins	A variety of organotin compounds are used as wood preservatives, antifoulants, biocides, and disinfectants (<i>Farm Chemicals Handbook</i> , 1989)	Some organotin compounds have been actively registered since the mid-1960s. Several registrations have been canceled or manufacturers discontinued production (U.S. EPA, 1988a)	II	D
Organochlorines					
Chlordane	Chlorinated cyclodiene	Termite control. Historically used for control of fire ants, cutworms, grasshoppers, and on other insects on corn, grapes, strawberries, and other crops and as a dip for nonfood roots and tips of plants (Hartley and Kidd, 1987).	In March 1978, EPA issued a cancellation proceeding on chlordane, allowing only limited use on certain crops and pests until July 1983, but no use thereafter except for underground termite control (43 FR 12372). All uses were canceled in 1988.	II	B2
DDT	Chlorinated hydrocarbon	Insecticide	All uses in U.S. were canceled as of January 1, 1973, except for emergency public health uses.	III	B2
Dicofol	Chlorinated hydrocarbon	Miticide/pesticide on many fruit, vegetable, ornamental, and field crops. Used to control mites on cotton and citrus (80%). Other uses include control of mites on ornamental plants, fruits, and vegetables. Most of the usage is in California and Florida (U.S. EPA, 1998b).	Active registration since 1957. ^c	III	C ^d
Dieldrin	Chlorinated cyclodiene	Formerly used to control locusts, tropical disease carriers (e.g., mosquitoes), and termites, use as wood preservative, and moth proofing for woolen clothes and carpets (Worthing, 1991).	All uses on food products were suspended in 1974 (ATSDR, 1993). All registered uses in the U.S. were canceled in 1985.	II	B2
Endosulfan (I and II)	Chlorinated bicyclid sulfite	Insecticide and acaricide on citrus, deciduous, small fruits, coffee, tea, fiber crops, forage crops, forest, grains, nuts, oil crops, tobacco, ornamentals, and vegetables (ATSDR, 1999).	Active registration since 1954. ^c	I	E ^e

See notes and references at end of table.

(continued)

Table F-1. (continued)

Pesticide	Family	Use	Registration	EPA toxicity class ^a	EPA carcinogenicity classification ^b
Endrin	Chlorinated cyclodiene	Historically used to control cotton bollworms, as a foliar treatment for citrus, potatoes, small grains, apple orchards, sugarcane, and as flower and bark treatment on trees. Endrin has also been used to control populations of birds and rodents (U.S. EPA, 1980).	In 1964, endrin persistence in soils led to cancellation of its use on tobacco (U.S. EPA, 1980). By 1979, specified uses on cotton, small grains, apple orchards, sugarcane and ornamentals were also restricted (44 FR 43632). All uses in the U.S. were canceled in 1984 (U.S. EPA, 1984a).	I	D
Heptachlor epoxide	Chlorinated cyclodiene	Heptachlor epoxide is an oxidation product of heptachlor. It is a contaminant of both heptachlor and chlordane. Heptachlor was widely used as a termiticide and insecticide, primarily for ant control (Hodges, 1977). Chlordane was widely used for termite control as well as for control of fire ants, cutworms, grasshoppers and other insects (Hartley and Kidd, 1987).	Restrictions on heptachlor were first instituted in 1978 and heptachlor has not been sold in the U.S. since August 1987 (ATSDR, 1987).	NA	B2
Hexachlorobenzene	Chlorinated benzene	Primary use prior to 1985 was as a fungicide seed protectant in small grain crops, particularly wheat.	Registration for all uses was canceled in 1984 (Morris and Cabral, 1986).	IV	B2
Lindane (γ -hexachloro-cyclohexane)	Chlorinated hydrocarbon	Seed treatments, soil treatments for tobacco transplants, foliage applications on fruit and nut trees, vegetables, and wood and timber protection (ATSDR, 1998).	Active registration. Use of lindane in smoke fumigation devices for indoor domestic purposes was banned in 1985 (48 FR 48512, 50 FR 5424). Use in dog dips permitted only for veterinary use (U.S. EPA, 1985a). Application permitted only under supervision of certified applicator (U.S. EPA, 1985a). ^c	II	B2 ^e
Mirex	Chlorinated cyclodiene	Historically used primarily in fire ant control in southeastern states (Kutz et al., 1985) and was used industrially as a fire retardant and polymerizing agent in plastics under the name dechlorane (ATSDR, 1995).	Registration for all uses on field crops was canceled in 1977 (41 FR 56703) (NAS, 1978).	II	B2 ^f
Toxaphene	Chlorinated camphene	Historically used extensively on cotton (<i>Farm Chemicals Handbook</i> , 1989).	Registration for all uses was canceled in 1982 (47 FR 53784) and uses were canceled in 1990 (55 FR 31164-31174).	II	B2

See notes and references at end of table.

(continued)

Table F-1. (continued)

Pesticide	Family	Use	Registration	EPA toxicity class ^a	EPA carcinogenicity classification ^b
Organophosphates					
Chlorpyrifos	Heterocyclic organothio-phosphate	Insecticide primarily used to control soil and foliar insect pests on cotton, peanuts, and sorghum (Worthing, 1983; U.S. EPA, 1986a). In addition, it is used to control root-infesting and boring insects on a variety of fruits (e.g., citrus crops, apples, bananas, peaches, grapes, nectarines), nuts (e.g., almonds, walnuts), vegetables (e.g., beans, broccoli, brussel sprouts, cauliflower, soybeans, cabbage, peas) and field crops (e.g., alfalfa and corn) (U.S. EPA, 1986a) and to control ticks on cattle and sheep (Thomson, 1985). As a household insecticide it has been used to control ants, cockroaches, fleas, and mosquitoes (Worthing, 1983) and is registered for use in controlling subsurface termites in California (U.S. EPA, 1983).	Active registration since 1965 (U.S. EPA, 1984b). ^c Use patterns will change by the end of 2001. Virtually all residential use will end, as will use on tomatoes. Use on apples and grapes will be substantially reduced (U.S. EPA, 2000).	II	E ^g
Diazinon	Heterocyclic organothio-phosphate	Insecticide and nematicide for control of soil insects and pests of fruits, vegetables, tobacco, forage, field crops, range, pasture, grasslands, and ornamentals. Used to control cockroaches and other household insects; and grubs and nematodes in turf; as a seed treatment and for fly control (<i>Farm Chemicals Handbook</i> , 1989).	Active registration since 1952 (U.S. EPA, 1986b). ^c	II	Not likely ^e
Disulfoton	Aliphatic organothio-phosphate	Systemic insecticide and acaricide on grain, nut, cole, and root crops; pome, strawberry, and pineapple fruits; forage, field and vegetable crops, sugarcane, seed crops, forest plantings, ornamentals and potted plants (houseplants) (U.S. EPA, 1984c).	Active registration since 1958 (U.S. EPA, 1984c). ^c	I	E ^e
Ethion	Organothio-phosphate	Insecticide (nonsystemic) for control of leaf-feeding insects, mites, and scale insects. Citrus accounts for 86%-89% of total pounds of ethion used in the U.S. with the remaining 11%-14% applied to cotton, a variety of fruit trees, nut trees, and vegetables (U.S. EPA, 1989).	Active registration since 1965 (U.S. EPA, 1989). ^c	II	E ^e

See notes and references at end of table.

(continued)

Table F-1. (continued)

Pesticide	Family	Use	Registration	EPA toxicity class ^a	EPA carcinogenicity classification ^b
Terbufos	Organothiophosphate	Systemic insecticide and nematicide on corn, sugar beets, and grain sorghum (U.S. EPA, 1985c).	Active since 1974; however, granular end-use products containing 15% or more terbufos were classified as "Restricted Use" after September 1985 (U.S. EPA, 1985c; 1985b). ^c	I	E ^e
Chlorophenoxy Herbicides					
Oxyfluorfen	Diphenyl ether	Pre- and postemergence herbicide for a wide spectrum of annual broadleaf weeds and grasses in apples, artichokes, corn, cotton, tree fruit, grapes, nuts, spearmint, peppermint, certain topical plantation, and ornamental crops (<i>Farm Chemicals Handbook</i> , 1989)	Active since 1979. ^c	IV	C ^e

^a Designations are from EPA (1998a):

- I = Oral LD₅₀ up to and including 50 mg/kg in laboratory animals.
- II = Oral LD₅₀ >50 through 500 mg/kg in laboratory animals.
- III = Oral LD₅₀ >500 through 5,000 mg/kg in laboratory animals.
- IV = Oral LD₅₀ >5,000 mg/kg in laboratory animals.
- NA = No value available.

^b Designations are from IRIS (1999) unless otherwise noted: NA = not available; A = human carcinogen; B1, B2 = probable human carcinogen; C = possible human carcinogen; D = not classifiable as to human carcinogenicity; E = evidence of noncarcinogenicity for humans.

^c This pesticide has an active registration for agricultural use. The EPA Office of Pesticide Programs is responsible for registration and reregistration of pesticides. The 1988 Amendment of FIFRA requires EPA to reregister each "registered pesticide containing any active ingredient contained in any pesticide first registered before November 1, 1984, except for any pesticide as to which the Administration has determined, after November 1, 1984 . . . that—(1) there are no outstanding data requirements; and (2) the requirements of section 3(c)(5) have been satisfied" (U.S. EPA, 1988b). The Agency will review all relevant data submitted by the registrant for each pesticide reregistration and will use the data to conduct a risk assessment. Any subsequent regulatory action will be based on the results of the risk assessment. If the data submitted are incomplete at the predetermined review time, the pesticide may be suspended. Under the provisions of the Food Quality Protection Act of 1996, all pesticides with active registrations are undergoing review to determine if restrictions on their use are necessary for the protection of the health of infants and children. Contact EPA for further information on the status of the review process for specific pesticides.

^d EPA carcinogenicity classification based on Reregistration Eligibility Decision (RED) Dicofol (U.S. EPA, 1998b).

^e EPA carcinogenicity classification based on List of Chemicals Evaluated for Carcinogenic Potential (U.S. EPA, 1999).

^f EPA carcinogenicity classification based on HEAST, (1997).

^g EPA carcinogenicity classification based on Revised Human Health Risk Assessment for Chlorpyrifos (U.S. EPA 2000).

Note: The potential human toxicity of currently regulated pesticides is undergoing assessment as a result of provisions of the Food Quality Protection Act (1996). Consult EPA for the latest assessment information on the Internet at: <http://www.epa.gov/oppsrrd1/op/status.htm>.

Table F-1. (continued)

References:

- ATSDR (Agency for Toxic Substances and Disease Registry). 1987. *Draft Toxicological Profile for Heptachlor*. U.S. Public Health Service, Washington, DC.
- ATSDR (Agency for Toxic Substances and Disease Registry). 1993. *Toxicological Profile for Aldrin/Dieldrin (Update)*. U.S. Public Health Service, Washington, DC.
- ATSDR (Agency for Toxic Substances and Disease Registry). 1995. *Toxicological Profile for Mirex/Chlordecone*. U.S. Public Health Service, Washington, DC.
- ATSDR (Agency for Toxic Substances and Disease Registry). 1998. *Toxicological Profile for Alpha-, Beta-, Gamma-, and Delta-Hexachlorocyclohexane (Update)*. U.S. Public Health Service, Washington, DC.
- ATSDR (Agency for Toxic Substances and Disease Registry). 1999. *Draft Toxicological Profile for Endosulfan*. U.S. Public Health Service, Washington, DC.
- Farm Chemicals Handbook*. 1989. Meister Publishing Company, Willoughby, OH.
- Hartley, D., and H. Kidd (eds.). 1987. *Agrochemicals Handbook*. Royal Society of Chemistry, Nottingham, England.
- Hodges, L. 1977. *Environmental Pollution*. Holt, Rinehart and Winston, New York, NY.
- IRIS (Integrated Risk Information System). 1999. U.S. Environmental Protection Agency, Duluth, MN.
- Kutz, F.W., S.C. Strassman, C.R. Stroup, J.C. Carra, C.C. Leininger, D.L. Watts, and C.M. Sparacino. 1985. The human body burden of mirex in the southeastern United States. *J. Toxicol. and Environ. Health* 15:385-394.
- Morris, C.R., and J.R.P. Cabral (eds.). 1986. Hexachlorobenzene: Proceedings of an International Symposium. *IARC Scientific Publication No. 77*. World Health Organization, Lyon, France.
- NAS (National Academy of Sciences). 1978. *Kepon/Mirex/Hexachlorocyclopentadiene: An Environmental Assessment*. National Academy of Sciences, National Research Council, Washington, DC.
- Thomson, W.T. 1985. *Agricultural Chemicals Book I - Insecticide*, 1985 revision. Thomas Publication, Davis, CA.
- U.S. EPA (U.S. Environmental Protection Agency). 1980. *Ambient Water Quality Criteria for Endrin*. EPA-440/5-80-047. Office of Water Regulations and Standards, Washington, DC.
- U.S. EPA (U.S. Environmental Protection Agency). 1983. *Analyses of the Risks and Benefits of Seven Chemicals Used for Subterranean Termite Control*. EPA-540/9-83-005. Office of Pesticide Programs, Washington, DC.
- U.S. EPA (U.S. Environmental Protection Agency). 1984a. Internal memorandum from G. LaRocca to B. Burnam et al., August 16, 1984. Office of Pesticide Programs, Washington, DC.
- U.S. EPA (U.S. Environmental Protection Agency). 1984b. *Pesticide Fact Sheet—Chlorpyrifos*. Office of Pesticides and Toxic Substances, Office of Pesticide Programs, Washington, DC.
- U.S. EPA (U.S. Environmental Protection Agency). 1984c. *Pesticide Fact Sheet—Disulfoton*. Office of Pesticides and Toxic Substances, Office of Pesticide Programs, Washington, DC.
- U.S. EPA (U.S. Environmental Protection Agency). 1985a. *Guidance for the Registration of Pesticide Products Containing Lindane as the Active Ingredient*. EPA-540/RS-86-121. U.S. EPA Office of Pesticide Programs. Washington, DC.
- U.S. EPA (U.S. Environmental Protection Agency). 1985b. *Suspended, Cancelled, and Restricted Pesticides*. U.S. EPA Office of Pesticides and Toxic Substances, Washington, DC.
- U.S. EPA (U.S. Environmental Protection Agency). 1985c. *Pesticide Fact Sheet—Terbufos*. Office of Pesticides and Toxic Substances, Office of Pesticide Programs, Washington, DC.
- U.S. EPA (U.S. Environmental Protection Agency). 1986a. *Ambient Water Quality Criteria for Chlorpyrifos*. EPA-440/5-86-005. Office of Water Regulations and Standards, Washington, DC.
- U.S. EPA (U.S. Environmental Protection Agency). 1986b. *Pesticide Fact Sheet—Diazinon*. Office of Pesticides and Toxic Substances, Office of Pesticide Programs, Washington, DC.

Table F-1. (continued)

-
- U.S. EPA (U.S. Environmental Protection Agency). 1988a. *Pesticide Fact Sheet—Tributyltin Antifouling Paint*. Office of Pesticides and Toxic Substances, Office of Pesticide Programs, Washington, DC.
- U.S. EPA (U.S. Environmental Protection Agency). 1988b. *The Federal Insecticide, Fungicide, and Rodenticide Act as Amended*. EPA-540/09-89-012. Office of Pesticide Programs, Washington, DC.
- U.S. EPA (U.S. Environmental Protection Agency). 1989. *Pesticide Fact Sheet—Ethion*. Office of Pesticides and Toxic Substances, Office of Pesticide Programs, Washington, DC.
- U.S. EPA (U.S. Environmental Protection Agency). 1990. *Suspended, Cancelled, and Restricted Pesticides*. Document 20T-1002, Office of Pesticides and Toxic Substances, Washington, DC.
- U.S. EPA (U.S. Environmental Protection Agency). 1993. *Status of Pesticides in Reregistration and Special Review. Prevention, Pesticides and Toxic Substances*. EPA 738-R-93-009. Washington, DC.
- U.S. EPA (U.S. Environmental Protection Agency). 1998a. *Health Effects Test Guidelines*, OPPTS 870.1000. *Acute Toxicity Testing—Background: Prevention, Pesticides and Toxic Substances*. EPA-712-C-98-189. Washington, DC.
- U.S. EPA (U.S. Environmental Protection Agency). 1998b. *Reregistration Eligibility Decision for Dicofol*. Office of Pesticide Programs, Washington, DC.
- U.S. EPA (U.S. Environmental Protection Agency). 1999. *List of Chemicals Evaluated for Carcinogenic Potential*. Office of Pesticide Programs, Health Effects Division, Washington, DC.
- U.S. EPA (U.S. Environmental Protection Agency). 2000. *Revised Human Health Risk Assessment for Chlorpyrifos*. Office of Pesticide Programs, Washington, DC.
- Worthing, C.R. 1991. *The Pesticide Manual: A World Compendium*. 9th edition. British Crop Protection Council, Croydon, England.

APPENDIX G

TARGET ANALYTE DOSE-RESPONSE VARIABLES AND ASSOCIATED INFORMATION

Table G-1. Target Analyte Dose-Response Variables and Associated Information

Target analyte	Noncarcinogens		Carcinogens		
	RfD ^a (degree of confidence; uncertainty factor)	Critical toxic effect	CSF ^b (discussion of confidence)	Critical carcinogenic effect ^c	EPA carcinogenicity classification ^d
Metals					
Arsenic (inorganic)	3 × 10 ⁻⁴ (medium; 3)	Hyperpigmentation, keratosis and possible vascular complications in humans	1.5	—	A
Cadmium	1 × 10 ⁻³ (high; 10)	Significant proteinuria in humans	NA	—	B1
Mercury (as methylmercury)	1 × 10 ^{-4e} (medium; 10)	Developmental neurological abnormalities in human infants	NA	—	C
Selenium ^f	5 × 10 ⁻³ (high; 3)	Selenosis in humans	NA	—	D
Tributyltin ^g	3 × 10 ⁻⁴ (high; 100)	Immunotoxicity in rats	NA	—	D
Organochlorine Pesticides					
Chlordane (sum of <i>cis</i> - and <i>trans</i> -chlordane, <i>cis</i> - and <i>trans</i> -nonachlor, and oxychlordane) ^h	5 × 10 ⁻⁴ (medium; 300)	Hepatic necrosis in mice	0.35 (Adequate number of animals observed. CSF is the geometric mean of CSFs for five data sets).	Hepatocellular carcinomas in 5 strains of mice (male and female)	B2
DDT (sum of 4,4'- and 2,4'- isomers of DDT, DDE, and DDD) ⁱ	5 × 10 ⁻⁴ (medium; 100)	Liver lesions in rats	0.34 (CSF is geometric mean of CSFs from 10 data sets).	DDT: Liver tumors in seven studies in various mouse strains and three studies in three rat strains	B2

See notes and references at end of table.

(continued)

Table G-1. (continued)

Target analyte	Noncarcinogens		Carcinogens		
	RfD ^a (degree of confidence; uncertainty factor)	Critical toxic effect	CSF ^b (discussion of confidence)	Critical carcinogenic effect ^c	EPA carcinogenicity classification ^d
Dicofol	4 x 10 ^{-4j} (NA, 300)	Inhibition of ACTH stimulated release of cortisol in both sexes in 1-yr dog feeding study.	NA	—	C ^k
Dieldrin	5 x 10 ⁻⁵ (medium; 100)	Liver lesions (focal proliferation and focal hyperplasia) in one strain of female rats	16 (CSF is the geometric mean of CSFs from 13 data sets. Individual CSFs ranged within a factor of 8.)	Liver carcinomas in five strains of mice (male and female)	B2
Endosulfan (sum of endosulfan I and II)	6 x 10 ⁻³ (medium; 100)	Decreased body weight gain in male and female rat and progressive glomerulonephrosis and blood vessel aneurysms in one strain of male rats	NA	—	E ^l
Endrin	3 x 10 ⁻⁴ (medium; 100)	Mild histological lesions in livers, occasional convulsions in dogs (both sexes)	NA	—	D
Heptachlor epoxide	1.3 x 10 ⁻⁵ (low; 1000)	Increased liver-to-body weight ratios in male and female dogs	9.1 (Adequate number of animals observed in both studies, but survival in one study was low. This CSF is consistent with CSF = 5.8 for one strain of seven rats.)	Hepatocellular carcinomas in two strains of mice (male and female)	B2

See notes and references at end of table.

(continued)

Table G-1. (continued)

Target analyte	Noncarcinogens		Carcinogens		
	RfD ^a (degree of confidence; uncertainty factor)	Critical toxic effect	CSF ^b (discussion of confidence)	Critical carcinogenic effect ^c	EPA carcinogenicity classification ^d
Hexachlorobenzene	8 × 10 ⁻⁴ (medium; 100)	Liver effects (hepatic centrilobular basophilic chromogenesis) in one strain of rats (both sexes)	1.6 (Significant increases in malignant tumors observed among an adequate number of animals observed for their lifetime.)	Hepatocellular carcinomas in one strain of rats (females only)	B2
Lindane (γ-HCH)	3 × 10 ⁻⁴ (medium; 1,000)	Liver and kidney toxicity (liver hypertrophy, kidney tubular degeneration, hyaline droplets, tubular distension, interstitial nephritis, and basophilic tubules) in both sexes of one strain of rats	1.3 ^m	—	B2/C ^l
Mirex	2 × 10 ⁻⁴ (high; 300)	Liver cytomegaly, fatty metamorphosis, angiectasis and thyroid cystic follicles in one strain of rats.	NA	—	B2 ^m
Toxaphene	2.5 × 10 ⁻⁴ⁿ (NA, 1,000)	Slight liver degeneration—granularity and vacuolization of hepatocytes.	1.1 (Adequate number of animals observed. A dose-response effect was seen in a study with three non-zero dose levels.)	Hepatocellular carcinomas and neoplastic nodules in one strain of mice (males only)	B2

See notes and references at end of table.

(continued)

Table G-1. (continued)

Target analyte	Noncarcinogens		Carcinogens		
	RfD ^a (degree of confidence; uncertainty factor)	Critical toxic effect	CSF ^b (discussion of confidence)	Critical carcinogenic effect ^c	EPA carcinogenicity classification ^d
<u>Organophosphate Pesticides</u>					
Chlorpyrifos	3 x 10 ⁻⁴ ° (NA, 10)	Decreased plasma ChE activity observed in various animal feeding studies.	NA	—	E°
Diazinon	7 x 10 ⁻⁴ ^p (NA, 30)	Inhibition of plasma ChE observed in 90-d rat feeding study.	NA	—	Not likely E ¹
Disulfoton	4 x 10 ⁻⁵ (medium, 100)	ChE inhibition and degeneration of the optic nerve observed in 2-yr rat feeding study.	NA	—	E ¹
Ethion	5 x 10 ⁻⁴ (medium, 100)	Plasma ChE inhibition (in 21-d human feeding study) and inhibition of brain ChE observed in 90-d dog feeding study.	NA	—	E ¹
Terbufos	2 x 10 ⁻⁵ ^q (NA, 300)	Inhibition of plasma ChE observed in 28-d dog feeding study.	NA	—	E ¹
<u>Chlorophenoxy Herbicides</u>					
Oxyfluorfen	3 x 10 ⁻³ (high, 100)	Increased absolute liver weight and nonneoplastic lesions observed in 20-mo mouse feeding study.	7.32 x 10 ⁻²¹	Evidence of carcinogenicity (liver tumors) in mice.	C ¹

See notes and references at end of table.

(continued)

Table G-1. (continued)

Target analyte	Noncarcinogens		Carcinogens		
	RfD ^a (degree of confidence; uncertainty factor)	Critical toxic effect	CSF ^b (discussion of confidence)	Critical carcinogenic effect ^c	EPA carcinogenicity classification ^d
PAHs^f					
Benzo[a]pyrene	NA	—	7.3 (Data less than optimal, but acceptable. Four data sets used from two different studies using two different species (rats and mice; both sexes) to derive geometric mean of four calculated slope factors.)	Squamous cell carcinoma of the forestomach in one strain of mice (both sexes). Forestomach, larynx, and esophagus papillomas and carcinomas in one strain of rats (both sexes)	B2
PCBs					
Total PCBs (sum of Aroclors)	2×10^{-5} ^g (medium; 300)	Ocular exudate, inflamed, prominent Meibomian glands, distorted growth of fingernails, and toenails, decreased antibody response to sheep erythrocytes in monkey clinical and immunologic studies	2.0 ^h (Adequate number of animals observed for their normal lifespan. Only one non-zero test dose used.)	Trabecular carcinomas/adenocarcinomas, neoplastic nodules in one strain of rats (females only)	B2
Dioxins/furans					
	NA	—	1.56×10^5 ^u	NA	B2 ^u

NA = Not available in IRIS (1992).

PAHs = Polycyclic aromatic hydrocarbons.

PCBs = Polychlorinated biphenyls.

DDT = p,p'-Dichlorodiphenyl trichloroethane.

DDD = p,p'-Dichlorodiphenyl dichloroethylene.

DDE = p,p'-Dichlorodiphenyl trichloroethane.

Table G-1. (continued)

- ^a RfD = Oral reference dose (mg/kg-d); from IRIS (1999) unless otherwise noted (see Section 5.1.1).
- ^b CSF = Oral cancer slope factor (mg/kg-d)⁻¹; from IRIS (1999) unless otherwise noted (see Section 5.1.2).
- ^c The critical effect is the effect observed in oral dose response studies used to determine the CSF.
- ^d Except where noted, all EPA carcinogenicity classifications are taken from IRIS (1999):
- A = Human carcinogen based on sufficient evidence from epidemiologic studies.
 - B1 = Probable human carcinogen based on limited evidence of carcinogenicity to humans.
 - B2 = Probable human carcinogen based on sufficient evidence in animals and inadequate or no data in humans.
 - C = Possible human carcinogen based on limited evidence of carcinogenicity in animals in the absence of human data.
 - D = Not classifiable based on lack of data or inadequate evidence of carcinogenicity from human or animal data.
 - E = No evidence of carcinogenicity for humans (no evidence of carcinogenicity in at least two adequate animal tests in different species or in both epidemiologic and animal studies).
- ^e The RfD for methylmercury should be considered an interim value. The National Academy of Sciences (NAS) conducted an independent assessment of the RfD and concluded, "On the basis of its evaluation, the committee consensus is that the value of EPA's current RfD for a scientifically justifiable level for the protection of human health." (NAS 2000).
- ^f The evidence of carcinogenicity for various selenium compounds in animals and mutagenicity studies is conflicting and difficult to interpret. However, evidence for selenium sulfides is sufficient for a B2 classification (IRIS, 1999).
- ^g The oral RfD and cancer classification are for tributyltin oxide (IRIS, 1999).
- ^h The RfD and CSF values listed are derived from studies using technical-grade chlordane (IRIS, 1999) for the *cis*- and *trans*-chlordane isomers or the major chlordane metabolite, oxychlordane, or for the chlordane impurities *cis*- and *trans*-nonachlor. It is recommended that the total chlordane concentration be determined by summing the individual concentrations of *cis*- and *trans*-chlordane, *cis*- and *trans*-nonachlor, and oxychlordane.
- ⁱ The RfD value listed is for DDT. The CSF value is for total DDT (sum of DDT, DDE, and DDD) or DDE; the CSF value for DDD is 0.24. The U.S. EPA Carcinogenicity Assessment Group recommended the use of CSF = 0.34 for any combination of DDT, DDE, DDD, and dicofol (Holder, 1986). It is recommended that the total concentration of the 2,4'- and 4,4'-isomers of DDT and its metabolites, DDE and DDD, be determined.
- ^j The RfD value is from a memorandum dated December 12, 1997. Dicofol: Report of the Hazard Identification Assessment Review Committee. HED Document No. 012439 (U.S. EPA, 1997b).
- ^k EPA carcinogenicity classification based on Reregistration Eligibility Decision (RED) Dicofol (U.S. EPA, 1998b).
- ^l EPA carcinogenicity classification based on U.S. EPA, (1999).
- ^m EPA CSF based on HEAST (1997).
- ⁿ Reference dose information is taken from the Office of Pesticide Programs Reference Dose Tracking Report (U.S. EPA, 1997a).
- ^o Oral RfD based on the Revised Human Health Risk Assessment for Chlorpyrifos (U.S. EPA, 2000).
- ^p The RfD value is from a memorandum dated April 1, 1998, Diazinon: Report of the Hazard Identification Assessment Review Committee. HED Doc. No. 012558 (U.S. EPA, 1998a).
- ^q The RfD value listed is from a memorandum dated September 25, 1997; Terbufos-FQPA Requirement- Report of the Hazard Identification Review. (U.S. EPA, 1997c).

Table G-1. (continued)

- ^r This CSF is for benzo[a]pyrene (IRIS, 1999). There are no other RfDs or CSFs listed for other PAHs in IRIS (1999). It is recommended that, tissue samples be analyzed for benzo[a]pyrene and 14 other PAHs (Nisbet and LaGoy, 1992; U.S. EPA, 1993) and that the order-of-magnitude relative potencies given for these PAHs be used to calculate a potency equivalency concentration (PEC) for each sample for comparison with the recommended SV for benzo[a]pyrene (see Section 5.3.2.4).
- ^s This RfD for PCBs is based on the chronic toxicity of Aroclor 1254 (IRIS, 1999).
- ^t This CSF is based on a carcinogenicity assessment of Aroclor 1260, 1254, 1242, and 1016. The CSF represented is the upper bound slope factor for food chain exposure. The central estimate is 1.0 (IRIS, 1999).
- ^u The CSF value listed is for 2,3,7,8-tetrachlorodibenzo-p-dioxin 2,3,7,8-TCDD (HEAST, 1997). It is recommended that, in both screening and intensive studies, the 17 tetra- through octa-chlorinated dibenzo-p-dioxins (PCDDs) and dibenzofurans (PCDFs) and the 12 dioxin-like PCBs be determined and a toxicity-weighted total concentration be calculated for each sample for comparison with the recommended SV, using the method for estimating Toxicity Equivalency Concentration (TEQ) (Van den Berg et al., 1998).

References:

- HEAST. 1997. *Health Effects Summary Tables*. Office of Emergency and Remedial Response, U.S. Environmental Protection Agency, Washington, DC.
- Holder, J.W. 1986. *The Assessment of the Carcinogenicity of Dicofol (Kelthane), DDT, DDE, and DDD (TDE)*. EPA-600/6-86/001. Carcinogenicity Assessment Group, Office of Pesticide Programs, U.S. Environmental Protection Agency, Washington, DC.
- IRIS (Integrated Risk Information System). 1999. U.S. Environmental Protection Agency, Duluth, MN.
- NAS (National Academy of Sciences). 2000. *Toxicological Effects of Methylmercury*. National Research Council, Washington, DC.
- Nisbet and LaGoy. 1992. Toxic equivalency factors (TEFs) for polycyclic aromatic hydrocarbons (PAHs). *Reg. Toxicol. Pharmacol.* 16:290-300.
- U.S. EPA (U.S. Environmental Protection Agency). 1993. *Provisional Guidance for Quantitative Risk Assessment of Polycyclic Aromatic Hydrocarbons*. EPA/600/R-93/089. Environmental Criteria and Assessment Office, Office of Health and Environmental Assessment, Cincinnati, OH.
- U.S. EPA (U.S. Environmental Protection Agency). 1997a. *Reference Dose Tracking Report*. Office of Pesticide Programs, Health Effects Division, Washington, DC.
- U.S. EPA (U.S. Environmental Protection Agency). 1997b. Memorandum dated December 12, 1997. *Dicofol: Report of the Hazard Identification Assessment Review Committee*. HED DOC No. 012439. Office of Pesticide Programs, Health Effects Division, Washington, DC.
- U.S. EPA (U.S. Environmental Protection Agency). 1997c. *Terbufos-FQPA Requirement—Report of the Hazardous Assessment Identification Review*. Office of Pesticide Programs, Washington, DC.
- U.S. EPA (U.S. Environmental Protection Agency). 1998a. Memorandum dated April 1, 1998. *Diazinon: Report of the Hazard Identification Assessment Review Committee*. HED DOC No. 012558. Office of Pesticide Programs, Health Effects Division, Washington, DC.
- U.S. EPA (U.S. Environmental Protection Agency). 1998b. *Reregistration Eligibility Decision for Dichofof*. Office of Pesticide Programs and Toxic Substances, Washington, DC.
- U.S. EPA (U.S. Environmental Protection Agency). 1999. *Classification List of Chemical Evaluated for Carcinogenicity Potential*. Office of Pesticide Programs, Washington, DC.
- U.S. EPA (U.S. Environmental Protection Agency). 2000. *Revised Human Health Risk Assessment for Chlorpyrifos*. Office of Pesticide Programs, Washington, DC.
- Van den Berg, et al. 1998. Toxic equivalency factors (TEFs) for PCBs, PCDDs, PCDFs for human and wildlife. *Environ. Health Perspec.* 106(12):775-792.

(continued)

APPENDIX H

A RECOMMENDED METHOD FOR INORGANIC ARSENIC ANALYSIS

Extracted from:

Creelius, E.A., N.S. Bloom, C.E. Cowan, and E.A. Jenne. 1986. *Speciation of Selenium and Arsenic in Natural Waters and Sediments*. Volume 2: Arsenic Speciation, Section 2, in EPRI report #EA-4641, Vol. 2, pp. 2-1 to 2-28.

APPENDIX H

A RECOMMENDED METHOD FOR INORGANIC ARSENIC ANALYSIS

Note: EPA is currently revising Method 1632: Determination inorganic arsenic in water by hydride generation flame atomic absorption to include fish tissue.

Section 2

DETERMINATION OF ARSENIC SPECIES IN LIMNOLOGICAL SAMPLES BY HYDRIDE GENERATION ATOMIC ABSORPTION SPECTROSCOPY

INTRODUCTION

This section describes the analytical methods used to determine the arsenic species in waters and sediments. Also, sample storage tests were conducted to select methods of storing and shipping environmental samples that would minimize changes in speciation. Based on results of previous studies we selected hydride generation coupled with atomic absorption spectroscopy as the method of quantification of arsenic. In this technique arsenate, arsenite, methylarsonic acid, and dimethylarsinic acid are volatilized from solution at a specific pH after reduction to the corresponding arsines with sodium borohydride (1). The volatilized arsines are then swept onto a liquid nitrogen cooled chromatographic trap, which upon warming, allows for a separation of species based on boiling points. The released arsines are swept by helium carrier gas into a quartz cuvette burner cell (2), where they are decomposed to atomic arsenic. Arsenic concentrations are determined by atomic absorption spectroscopy. Strictly speaking, this technique does not determine the species of inorganic arsenic but rather the valence states of arsenate (V) and arsenite (III). The actual species of inorganic arsenic are assumed to be those predicted by the geochemical equilibrium model described in Section 1 of this report.

EXPERIMENTAL SECTION

Apparatus

The apparatus needed for the volatilization, separation and quantitation of arsenic species is shown schematically in Figure 2-1-a. Briefly, it consists of a reaction vessel, in which arsenic compounds are reduced to volatile arsines, a liquid nitrogen cooled gas chromatographic trap, and a H-2 flame atomic absorption detector.

Reaction Vessel. The reaction vessel is made by grafting a side-arm inlet onto a 30-ml "Midget Impinger" (Ace Glass #7532-20), as illustrated in Figure 2-1-b. The 8-mm diameter side arm may then be sealed with a silicone rubber-stopper type septum (Ace Glass #9096-32) to allow the air-free injection of sodium borohydride. The standard impinger assembly is replaced with a 4-way Teflon stopcock impinger (Laboratory Data control #700542) to allow rapid and convenient switching of the helium from the purge to the analysis mode of operation.

GC Trap. The low temperature GC trap is constructed from a 6 mm o.d. borosilicate glass U-tube about 30-cm long with a 2-cm radius of bend (or similar dimensions to fit into a tall widemouth Dewar flask. Before packing the trap, it is silanized to reduce the number of active adsorption sites on the glass. This is accomplished using a standard glass silanizing compound such as Sylon-Ct® (Supelco Inc.). The column is half-packed with 15% OV-3 on Chromasorb® WAW-DMCS (45-60

mesh). A finer mesh size should not be used, as the restriction of the gas flow is sufficient to overpressurize the system. After packing, the ends of the trap are plugged with silanized glass wool.

The entire trap assembly is then preconditioned as follows: The input side of the trap (nonpacked side) is connected via silicone rubber tubing to helium at a flow rate of $40\text{-ml} \cdot \text{min}^{-1}$ and the whole assembly is placed into an oven at 175°C for 2 hours. After this time, two $25\text{-}\mu\text{l}$ aliquots of GC column conditioner (Silyl-8®, Supelco Inc.) are injected by syringe through the silicone tubing into the glass tubing. The column is then left in the oven with helium flowing through it for 24 hours. This process, which further neutralizes active adsorption sites and purges the system of foreign volatiles, may be repeated whenever anomalous peaks are observed to show broadening.

Once the column is conditioned, it is evenly wrapped with about 1.8 m of nichrome wire (22 gauge) the ends of which are affixed to crimp on electrical contacts. The wire-wrapped column is then coated about 2-mm thick all over with silicone rubber caulking compound and allowed to dry overnight. The silicone rubber provides an insulating layer which enhances peak separation by providing a longer temperature ramp time.

The unpacked side of the column is connected via silicone rubber tubing to the output from the reaction vessel. The output side of the trap is connected by a nichrome-wire wrapped piece of 6-mm diameter borosilicate tubing to the input of the flame atomizer. It is very important that the system be heated everywhere ($\sim 80^{\circ}\text{C}$) from the trap to the atomizer to avoid the condensation of water. Such condensation can interfere with the determination of dimethylarsine. All glass-to-glass connections in the system are made with silicone rubber sleeves.

Atomizer. The eluted arsines are detected by flame atomic absorption, using a special atomizer designed by Andreae (2). This consists of a quartz cross tube as shown in Figure 2-1-c. Air is admitted into one of the 6-mm o.d. side tubes (optimal flows are given in Table 2-1), while a mixture of hydrogen and the carrier gas from the trap is admitted into the other. This configuration is superior to that in which the carrier gas is mixed with the air (Andreae, personal communication 1983) due to the reduction of flame noise and possible extinguishing of the flame by microexplosions when H_2 is generated in the reaction vessel. To light the flame, all of the gases are turned on, and a flame brought to the ends of the quartz cuvette. At this point a flame will be burning out of the ends of the tube. After allowing the quartz tube to heat up (~ 5 minutes) a flat metal spatula is put smoothly first over one end of the tube, and then the other. An invisible air/hydrogen flame should now be burning in the center of the cuvette. This may be checked by placing a mirror near the tube ends and checking for water condensation. Note that the flame must be burning only inside the cuvette for precise, noise-free operation of the detector.

Precision and sensitivity are affected by the gas flow rates and these must be individually optimized for each system, using the figures in Table 2-1 as an initial guide. We have observed that as the O_2/H_2 ratio goes up, the sensitivity increases and the precision decreases. As this system is inherently very sensitive, adjustments are made to maximize precision.

Detector. Any atomic absorption unit may serve as a detector, once a bracket has been built to hold the quartz cuvette burner in the wave path. This work has been done using a Perkin-Elmer Model 5000® spectrophotometer with electrodeless discharge arsenic lamp. An analytical wavelength of 197.3 nm and slit width of 0.7 nm (low) are used throughout. This wavelength has been shown to have a longer linear range, though about half the sensitivity of the 193.7 nm line (2). Background

correction is not used as it increases the system noise and has never been found necessary on the types of sample discussed in this paper.

Standards and Reagents

Arsenite (As(III)) Standards. A 1000 • mg l⁻¹ stock solution is made up by the dissolution of 1.73 grams of reagent grade NaAsO₂ in 1.0-liter deionized water containing 0.1% ascorbic acid. This solution is kept refrigerated in an amber bottle. A 1.0 mg • l⁻¹ working stock solution is made by dilution with 0.1% ascorbic acid solution and stored as above. Under these conditions this solution has been found stable for at least one year.

Further dilutions of As(III) for analysis, or of samples to be analyzed for As(III), are made in filtered Dungeness River water. It has been observed both here and elsewhere (Andreae 1983) that deionized water can have an oxidizing potential that causes a diminished As(III) response at low levels (1 µg l⁻¹ and less). Dilute As(III) standards are prepared daily.

Arsenate (As(V)) Standards. To prepare a 1000 mg • l⁻¹ stock solution, 4.16 g of reagent grade Na₂HASO₄ • 7H₂O are dissolved in 1.0 liter of deionized water. Working standards are prepared by serial dilution with deionized water and prepared monthly.

Monomethylarsonate (MMA) Standards. To prepare a stock solution of 1000 mg • l⁻¹, 3.90 g of CH₃AsO(ONa)₂ • 6H₂O is dissolved in 1.0 liter of deionized water. Working standards are prepared by serial dilution with deionized water. Dilute standards are prepared weekly.

Dimethylarsinate (DMA) Standards. To prepare a stock solution of 1000mg l⁻¹, 2.86 g of reagent grade (CW3)2AsO₂Na 3H₂O (cacodylic acid, sodium salt) is dissolved in 1.0 liter deionized water. Dilute standards are handled as for MMA.

6M Hydrochloric Acid. Equal volumes of reagent grade concentrated HCl and deionized water are combined to give a solution approximately 6M in HCl.

Tris Buffer. 394 g of Tris HCl (tris (hydroxymethyl) aminomethane hydrochloride) and 2.5 g of reagent grade NaOH are dissolved in deionized water to make 1.0 liter. This solution is 2.5 M in tris and 2.475 M in HCl, giving a pH of about 6.2 when diluted 50-fold with deionized water.

Sodium Borohydride Solution. Four grams of >98% NaBH₄ (previously analyzed and found to be low in arsenic) are dissolved in 100 ml of 0.02 M NaOH solution. This solution is stable 8-10 hours when kept covered at room temperature. It is prepared daily.

Phosphoric Acid Leaching Solution. To prepare 1.0 liter of 0.10 M phosphoric acid solution, 6.8 ml of reagent grade 85% H₃PO₄ are dissolved in deionized water.

Trisodium Phosphate Leaching Solution. To prepare 1.0 liter of 0.10 M trisodium phosphate solution, 6.8 ml of 85% H₃PO₄ and 12 g of reagent grade NaOH are dissolved in deionized water.

Acid Digestion Mixture. With constant stirring, 200 ml of concentrated reagent grade H₂SO₄ are slowly added to 800 ml concentrated HNO₃.

METHODS

Total Arsenic Determination

An aqueous sample (5-30 ml) is placed into the reaction vessel and 1.0 ml of 6M HCl is added. The 4-way valve is put in place and turned to begin purging the vessel. The G.C. trap is lowered into a Dewar flask containing liquid nitrogen (LN_2) and the flask topped off with LN_2 to a constant level. A 2.0-ml aliquot of NaBH_4 solution is then introduced through the silicone rubber septum with a disposable 3-ml hypodermic syringe and the timer turned on. The NaBH_4 is slowly added over a period of about 1 minute, being careful that the H_2 liberated by the reduction of water does not overpressurize the system or foam the contents out of the reaction vessel.

After purging the vessel for 8 minutes, the stopcock is turned to pass helium directly to the G.C. trap. In rapid order, the LN_2 flask is removed, the trap heating coil is turned on, and the chart recorder is turned on. The arsines are eluted in the order: AsH_3 , CH_3AsH_2 , $(\text{CH}_3)_2\text{AsH}$ according to their increasing boiling points given in Table 2.2 (1).

Arsenic (III) Determination

The same procedure as above is used to determine arsenite, except that the initial pH is buffered at about 5 to 7 rather than <1 , so as to isolate the arsenous acid by its pK_a (1). This is accomplished by the addition of 1.0 ml of Tris buffer to a 5- to 30-ml aliquot of unacidified sample. (If the sample is acidic or basic, it must be neutralized first, or the buffer will be exhausted.) For the As(III) procedure, 1.0 ml of NaBH_4 is added in a single short (~10 seconds) injection, as the rapid evolution of H_2 does not occur at this pH.

Small, irreproducible quantities of organic arsines may be released at this pH and should be ignored. The separation of arsenite, however, is quite reproducible and essentially 100% complete. As(V) is calculated by subtracting the As(III) determined in this step from the total inorganic arsenic determined on an aliquot of the same sample previously.

SEDIMENTS

Total Inorganic Arsenic

A 1.00-g aliquot of freeze-dried and homogenized sediment is placed into a 100-ml snap-cap volumetric flask. Five milliliters of deionized water is added to form a slurry and then 7 ml of the acid digestion mixture is added. After 5 minutes, the caps are replaced and the flasks heated at 80 to 90°C for 2 hours. Upon cooling the samples are diluted to the mark with deionized water, shaken, and allowed to settle overnight. An appropriate-sized aliquot of the supernatant liquid (25-100 μl) is added to 20 ml of deionized water and run as for total arsenic.

Leachable Arsenite

An aliquot (~1-2 g) of fresh or freshly thawed wet homogeneous sediment is weighed to the nearest 10 mg directly into a 40-ml acid-cleaned Oak Ridge type centrifuge tube. To this is added 25 ml of 0.10 M H_3PO_4 solution and the tubes are agitated with the lids on. Periodic agitation is maintained

for 18 to 24 hours, at which time the tubes are centrifuged for 30 minutes at 2500 RPM. Twenty milliliter aliquots of the supernatant liquid are removed by pipetting into cleaned polyethylene vials and saved in the refrigerator until analysis. Analysis should be accomplished within the next couple days.

For analysis, an appropriate-sized aliquot (10-100 μ l) is added to 20 ml of well-characterized filtered river water (or other nonoxidizing/nonreducing water). Enough 1.0 M NaOH solution is added to approximately naturalize the H_3PO_4 (1/3 the volume of the sample aliquot), and then 1.0 ml of Tris buffer is added. The sample is then analyzed as for As(III).

Leachable Arsenate, MMA and DMA

An aliquot (~1-2 g) of wet sediment is weighed into a centrifuge tube, as above. To this are added 25 ml of 0.1 M Na_3PO_4 solution, and the tubes agitated periodically for 18 to 24 hours. After centrifugation the supernatant liquid (dark brown due to released humic materials) is analyzed as for total arsenic using an appropriate-sized aliquot in 20 ml of deionized water. The total inorganic arsenic in this case should be only As(V), as As(III) is observed to not be released at this pH. No pre-neutralization of the sample is necessary as the HCl added is well in excess of the sample alkalinity.

Interstitial Water Analysis

Interstitial water samples may be treated just as ordinary water, except that as they are quite high in arsenic, usually an aliquot of 100 to 1000 μ l diluted in deionized water or river water is appropriate in most cases.

Storage Experiments

Storage experiments designed to preserve the original arsenic speciation of samples were carried out for a wide variety of conditions. For water samples, 30-ml and 60-ml polyethylene bottles pre-cleaned in 1 M HCl were used.

Conditions of temperature ranging from 20°C to -196°C were assessed, as well as preservation with HCl and ascorbic acid. Storage tests were carried out over a period of one month for water samples.

The stability of the As(III)/As(V) ratio in interstitial water at room temperature, in the presence of air was carried out over a 24-hour period to determine the feasibility of the field collection of interstitial water.

Because of the time-consuming nature of sediment analysis, a two-point storage test was carried out with triplicate samples analyzed for two sediments at two temperatures (0°C and -18°C). Mud samples were stored in polyethylene vials and analyzed at time zero and one month.

RESULTS AND DISCUSSION

Data Output

Using the procedures outlined above, and a mixed standard containing As(V), MMA, and DMA, standard curves were prepared for each of the arsines generated. A typical chromatogram from this procedure is illustrated in Figure 2.2. Under the conditions described in this paper, the elution times for the various arsines are as follows: AsH₃, 24 ± 2 s; CH₃AsH₂, 53 ± 2 s; and (CH₃)₂AsH, 66 ± 2 s. Notice that the peaks are broadened and that the sensitivity decreases as the boiling point of the compound increases. The small amount of signal after the DMA peak is probably a higher boiling impurity in the DMA, or some DMA that is lagging in the system during elution. We had previously noted much larger, multiple peaks in this region when water was allowed to condense between the trap and the detector. Such peaks were effectively eliminated and the DMA peak sharpened with the addition of the heating coil between the trap and the detector.

The typical standard curves in Figure 2.3 are prepared from the mean of two determinations at each concentration. Arsenic peak-height response appears to be linear to at least 600 mau (milliabsorbance units), which is the full scale setting used on our chart recorder. Andreae (3) shows that arsenic response is extremely nonlinear above this for the peak height mode, and recommends the use of peak area integration to increase the linear range. We have chosen to simply use a small enough sample aliquot to remain within 600 mau.

As arsenic response is quite sensitive to the H₂/O₂ ratio in the flame, it is necessary to restandardize the instrument whenever it is set up. Usually, however, the response is quite constant and stable over the entire day.

Precision, Accuracy, and Detection Limits

Precision and accuracy are the greatest and the detection limits the lowest for inorganic arsenic. The precision and accuracy of the inorganic arsenic determination is illustrated at two concentrations in Table 2-3. The standard seawater, NASS-1 (National Research Council of Canada) was run in 5.0-ml aliquots and the "standard river water" (National Bureau of Standards) was run in 100- μ l aliquots. In either case, both the precision (RSD) and accuracy were about 5%. Precision begins to decrease, as the boiling point of the compound increases, as is illustrated in Table 2-4, for spiked river water. No standard reference material has been found for the organic species.

The detection limit of this technique has not been explored to the extreme as the usual environmental sample benefits from less, not more sensitivity. For a chart recorder expansion of 600 mau full scale, and the parameters given in the text, and for a 30-ml sample aliquot, the following approximate detection limits are found: As(V), 0.006 $\mu\text{g} \cdot \text{l}^{-1}$ (twice the standard deviation of the blank); As(III) 0.003 $\mu\text{g} \cdot \text{l}^{-1}$ (0.5 chart units); MMA, 0.010 $\mu\text{g} \cdot \text{l}^{-1}$ as As (0.5 chart units); DMA, 0.012 $\mu\text{g} \cdot \text{l}^{-1}$ as As (0.5 chart units). For As(III), MMA and DMA, no contribution to the blank has been found due to reagents, except for the As(III) present in the river water used as a dilutant. As for As(V) a small contribution is found, mostly from the NaBH₄, and to a smaller extent from H₃PO₄. These may be minimized by selecting reagent lots of reagents found to be low in arsenic.

Water Storage Experiments

From the many experiments undertaken to determine a storage regime for arsenic species, the following general conclusion can be made: Almost any storage scheme will preserve the total arsenic, MMA, and DMh concentrations of river water in the $\mu \cdot 1^{-1}$ range. This is illustrated in the Figures 2-4a-p, where the final concentration of these parameters was within $\pm 20\%$ of the initial in all cases. The noise in the data is due mostly to the day-to-day analytical variability, which has been observed to be about twice that of same-day replicate analysis. On the other hand, these data also show that it is very difficult to preserve the original As(III)/As(V) ratio in samples, even for a short time. Two major observations are made: first, river water (Oungeness River water) tends to spontaneously reduce As(V) to As(III), even though the water has been filtered to 0.4 μ , thus removing most living creatures. This is also curious, as the natural equilibrium As(III)/As(V) ratio is about 0.2 in Dungeness River water. It is surmised that dissolved organic materials in the water are responsible for its reducing properties, a conclusion that is supported by work involving the reduction of Hg(II) to Hg(0) by humic acids (Bloom, unpublished work). The second observation is that the freezing of water inexplicably, but reproducibly causes the oxidation of As(III) to As(V) (Figure 2-4-g, i), except in the case of very rapid freezing by immersion in LN₂ (Figure 2-4-m, o).

In light of these observations, the following storage regimes are recommended for arsenic in aqueous solution:

1. If only total inorganic arsenic plus MMA and DMA are to be determined, the sample should be stored at 0 to 4°C in polyethylene bottles until analysis. No chemical preservative is needed or desired and the analysis should be carried out as soon as possible.
2. If the As(III)/As(V) ratio is to be maintained, the sample must be quick-frozen to -196°C in liquid nitrogen, and then stored at at least -80°C until analysis. Note that Figure 4-k shows that even in the case of rapid freezing to -196°C, followed by storage at -18°C, a definite oxidation of As(III) to As(V) was observed.

A convenient and safe way to quick-freeze samples is to place 55 ml of sample into a 60-ml narrow-mouth polyethylene bottle, screw on the cap (which has a 2 mm diameter hole) tightly, and drop into a Dewar flask full of liquid nitrogen. These bottles have been shown not to crack if less than 58 ml of water is placed in them, and not to float in the LN₂ if more than 50 ml is placed in them. After returning to the laboratory, the bottles may be placed into a low temperature freezer until analysis. Note of caution, if a small hole is not placed in the lid of the bottles, which are frozen in liquid nitrogen, the bottles may explode when removed from the liquid nitrogen.

Determination of Arsenic Species in Sediments

Two procedures were investigated in the determination of arsenic in sediments. One, a wet-acid digestion was used to determine total arsenic. The second was a mild, pH-selective leach to remove various arsenic species intact.

Total Arsenic. In applying the hot HNO₃/H₂SO₄ digestion to standard sediments and air particulate matter, good agreement was attained between the established values and the measured values (Table 2-5). Also, in the case of estuarine and riverine sediments collected in the Puget Sound area, there was good agreement between X-ray fluorescence spectroscopy and tffis method (Table 2-6). In either case, all observed arsenic was in the inorganic form.

However, when Lake Washington sediment spiked with inorganic as well as organic forms was analyzed by this method, the following was observed:

1. All of the MMA was recovered as MMA.
2. All of the inorganic arsenic was recovered as inorganic arsenic.
3. None of the DMA was recovered, but an unidentified higher boiling peak was generated.

This peak is clearly illustrated in Figure 2-5. Even after the above samples were redigested to near-dryness (white fumes) in HNO_3 plus HClO_4 , the same results were obtained. Therefore, at this point we recommend no hydride generation method to determine total arsenic in sediments, though this may be achieved using either neutron activation analysis or X-ray fluorescence spectroscopy. On the other hand, since no organic forms have been detected in any natural sediment and since both MMA and DMA give observable peaks if they are present, it is safe to assume as a general guideline that if only an inorganic arsenic peak is generated by a given sample, then it probably represents close to the total arsenic content of the sample.

Arsenic Speciation of Sediments. Maher (4) has shown that various arsenic species that may be removed from solids at different pH values. This approach was tested on a sample of spiked Lake Washington mud, over a wide range of pH using phosphate buffers. The results of these experiments, shown as arsenic recovered versus pH for all four species, are illustrated in Figure 2-6. Notice that the maximum recovery of As(III) occurs at about pH = 2.8 and that the maximum for As(V), MMA and DMA occur at pH >12. From these data, the two convenient buffers of 0.1 M H_3PO_4 (pH = 1.5) and Na_3PO_4 (pH = 12) were chosen to selectively extract the arsenic species from sediments. Samples extracted with H_3PO_4 (final pH = 2.3) are analyzed only for As(III) whereas those extracted with Na_3PO_4 (final pH = 11.9) are analyzed only for total As, which gives As(V), MMA and DMA, as As(III) is not extracted at this pH. On untested sediment types it would be wise to test this relationship to be sure it holds true before instituting an analytical regime.

Recovery of arsenic species from spiked Lake Washington mud is illustrated in Table 2-7. The calculated spike was added to the mud, which was then aged 14 days at 4°C before analysis. All analysis were carried out in quintuplicate. The yields are good and within the day-to-day variability for the respective species.

The values of the above analysis were then taken as the time zero values, and the mud divided and stored in one of two ways. Three aliquots each of Lake Washington mud (LWM) and spiked LWM were placed into polyethylene bottles and frozen at -18°C, while three aliquots were kept refrigerated at 0 to 4°C. After 30 days these samples were analyzed for arsenic species, the results of which are shown in Table 2-8. These data indicate that small changes in the concentrations of the various species may be occurring, with significant decreases (20-30%) in the organic species being seen. These changes are small enough, however, that if the samples were analyzed as soon as possible after collection, they should not be of great importance.

Interstitial Water. Interstitial water is collected from mud by pressure filtration under nitrogen. An aliquot (~100 g) of mud is placed into a plastic pressure filtration vessel with 1.0 μ acid-cleaned filter, and tapped down to remove air bubbles. The system is pressurized to 75 psi, and after discarding the first 1 to 2 ml of filtrate, the interstitial water is collected into a 30-ml polyethylene bottle under nitrogen. The As(III) stability curve in Figure 2-7 was generated on a sample in contact with air. Within 5 minutes, the sample had changed from colorless to brown, indicating that Fe(II)

had oxidized to Fe(III), and precipitated as colloidal $\text{Fe}(\text{OH})_3$. If an aliquot of sediment is filtered under nitrogen and then frozen at -196°C , as for water samples, within 5 to 10 minutes, minimal changes in the As(III)/As(V) ratio should have taken place.

Using the above technique, a sample of spiked, Lake Washington sediment was analyzed for interstitial water arsenic speciation 30 days after spiking with arsenic. This data is presented in Table 2-9 and shows that the distribution coefficients (K_d) of the various species between the solid and aqueous phases increase in the following order: $\text{DMA} \ll \text{MMA} < \text{As(III)} < \text{As(V)}$. In fact, a sizable fraction (4.3%) of the DMA is in the interstitial water in a given sample, a fact which is important considering the intimate interaction of the interstitial water and living creatures.

Interlaboratory Comparison

An interlaboratory comparison exercise was conducted between Battelle-Northwest (BNW) and Dr. M.O. Andreae of Florida State University (FSU) to demonstrate the effectiveness of the sample storage and shipping procedure and verify the accuracy of the analytical technique for determination of arsenic species in fresh water. Three samples were prepared as follows: (1) Dungeness River water (DRW) was filtered, (2) filtered DRW was spiked with nominally $0.45 \mu\text{g L}^{-1}$ of As (V) and $2 \mu\text{g L}^{-1}$ each of DMA and MMA, and (3) coal fly ash, standard reference material NBS-1633, was leached with DRW then filtered. All solutions were frozen immediately after preparation in liquid nitrogen then transferred and stored at -80°C . Samples were shipped on dry ice. Samples were analyzed at BNW and FSU the same week approximately two months after preparation. The results in Table 2-10 show good agreement between these two laboratories even for concentrations below $0.1 \mu\text{g L}^{-1}$. We believe this interlaboratory exercise has demonstrated that these storage and shipping procedures are appropriate for freshwater samples and the analytical method used for arsenic speciation is sensitive and accurate for concentrations of inorganic arsenic greater than approximately 0.05 and for organic arsenic concentrations greater than $0.2 \mu\text{g L}^{-1}$.

Precision for Sediments and Water

The precision or reproducibility for replicate analyses of arsenic species in field samples is shown in Table 2-11. Collection of these field samples is described in Section 3 of this report. The sediment was analyzed for leachable As (III) and As (V). Interstitial water and water from Hyco Reservoir were also analyzed for As (III) and (V). The results indicate that the relative standard deviations (RSD) for arsenic (III) and (V) in sediment are approximately 20% while the RSD for these species in interstitial water and in the water column are approximately 15% and 7%.

CONCLUSIONS AND RECOMMENDATIONS FOR FURTHER WORK

Arsenic speciation of a variety of materials in the limnological environment is simply and reproducibly achieved using selective hydride generation/low-temperature trapping techniques in conjunction with atomic absorption detection. The most difficult problem is the unambiguous determination of total arsenic in solids by this technique. Other related techniques that might be investigated include dry ashing, lithium metaborate fusion, and graphite furnace atomic absorption. An alternate method is to analyze select samples by X-ray fluorescence spectrometry.

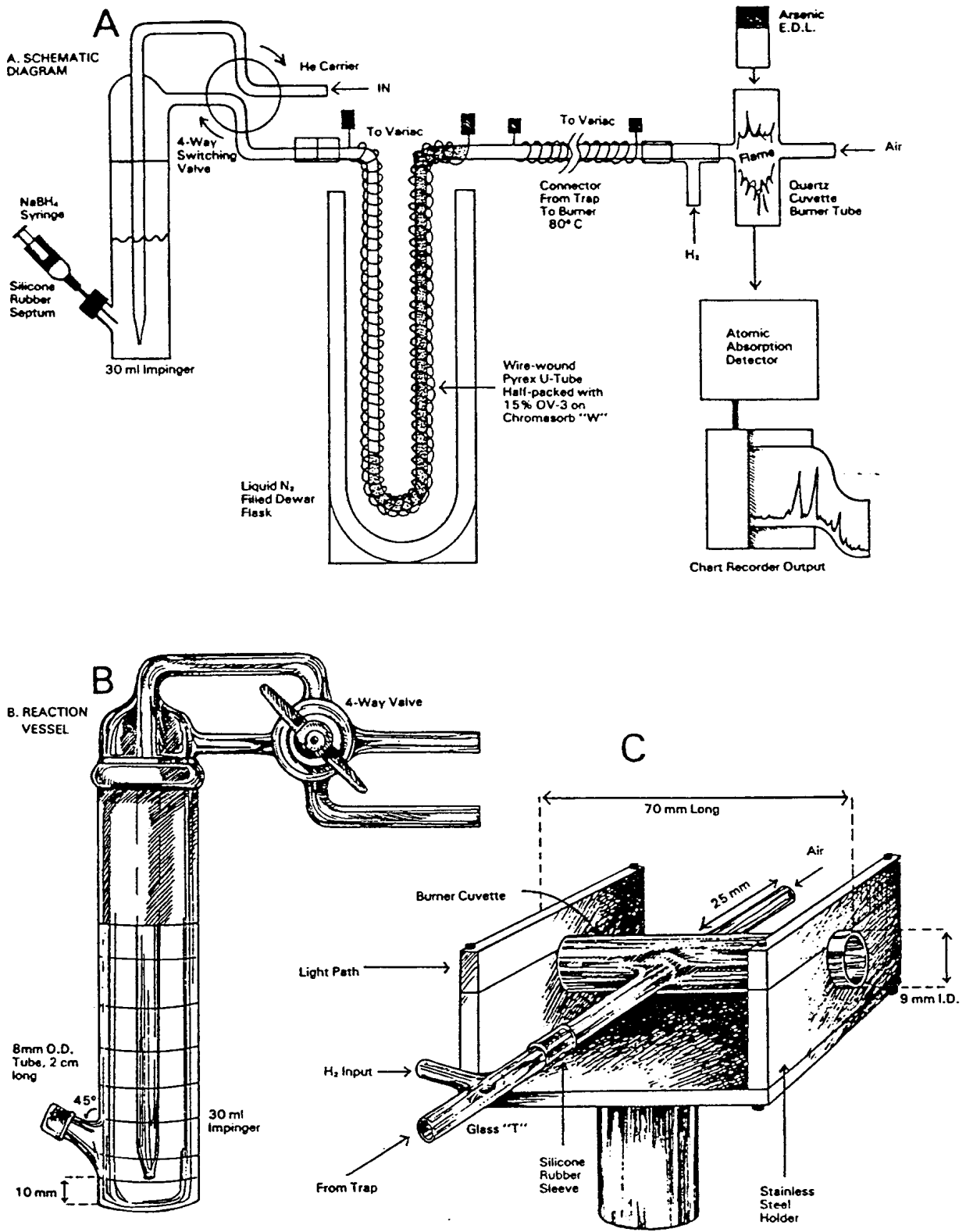

Figure 2-1. Arsenic Speciation Apparatus: (a) Schematic Diagram, (b) Reaction Vessel, (c) Quartz Cuvette Burner Tube.

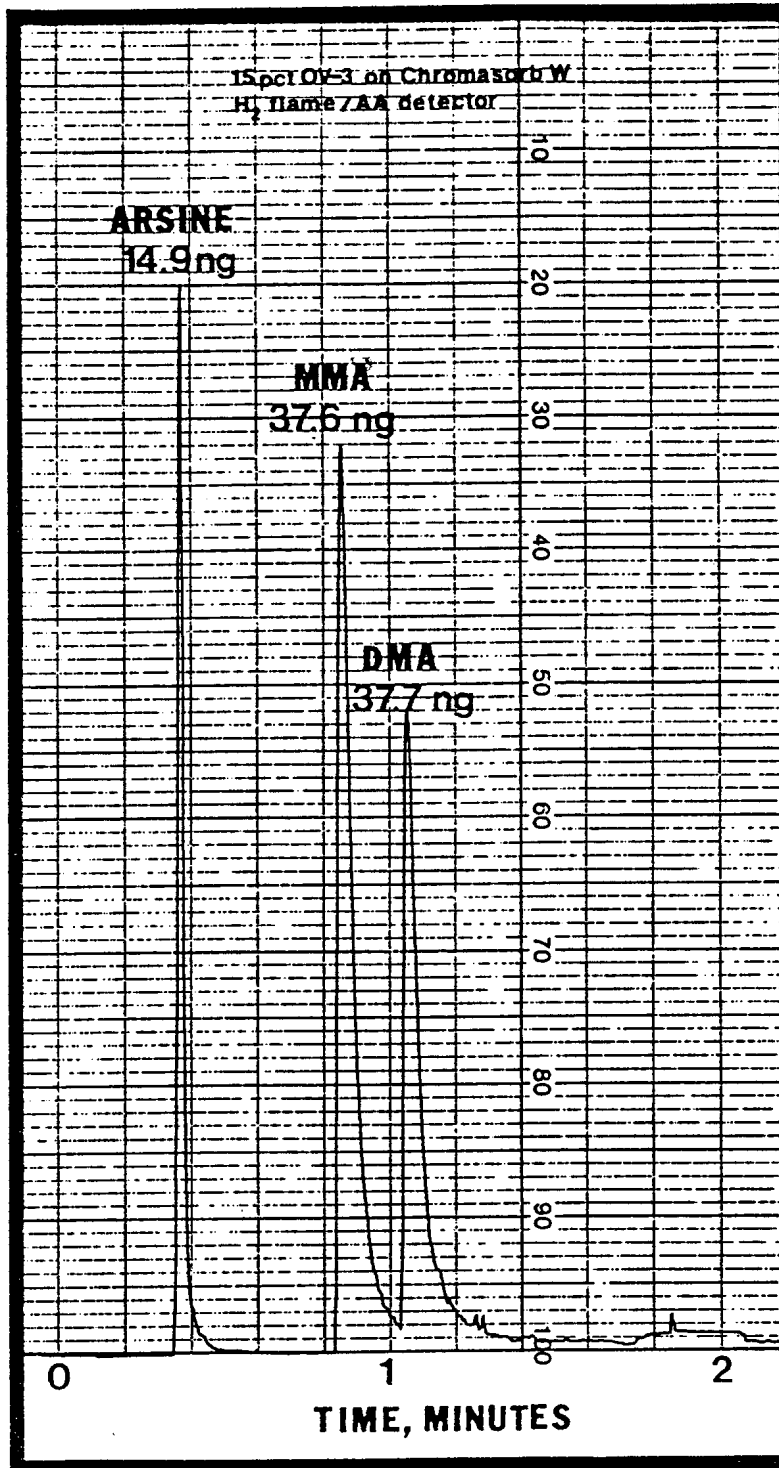

Figure 2-2. Typical chromatogram of arsenic hydride species. Vertical axis absorbance, horizontal axis time.

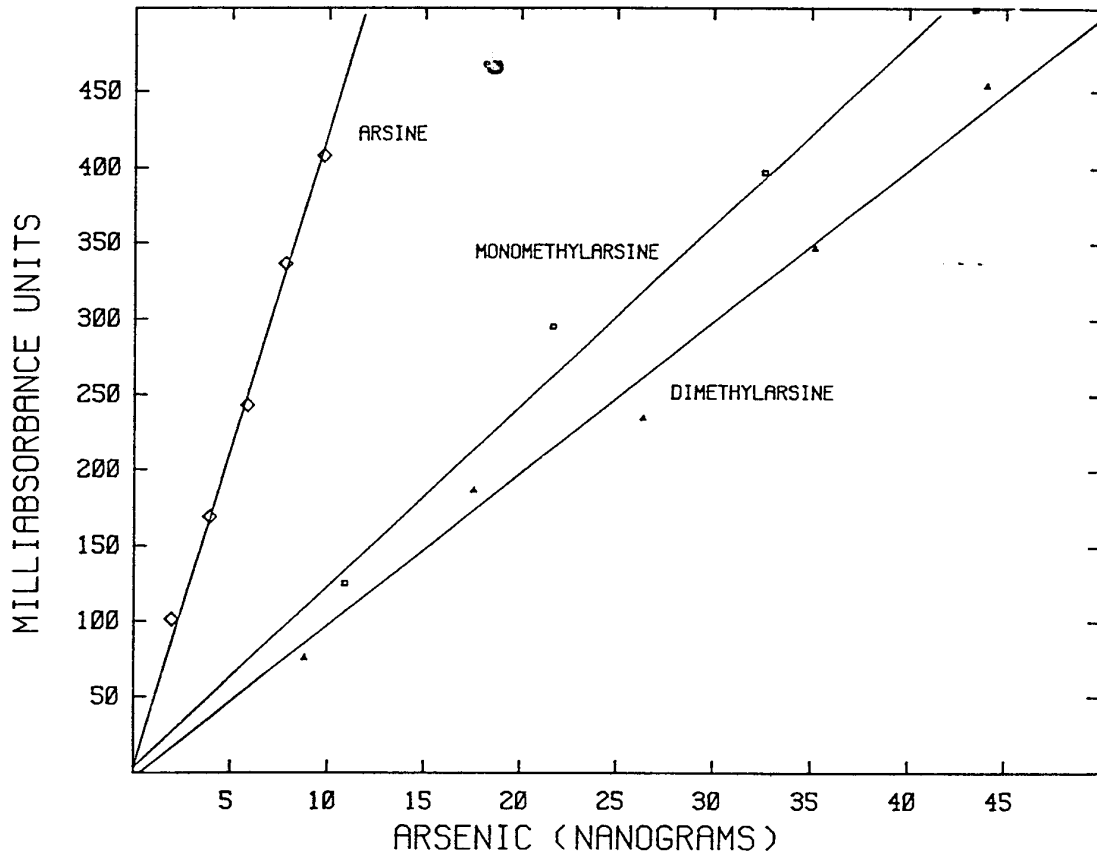

Figure 2-3. Standard curves, absorbance versus concentration for arsenic hydride species, atomic absorption detector.

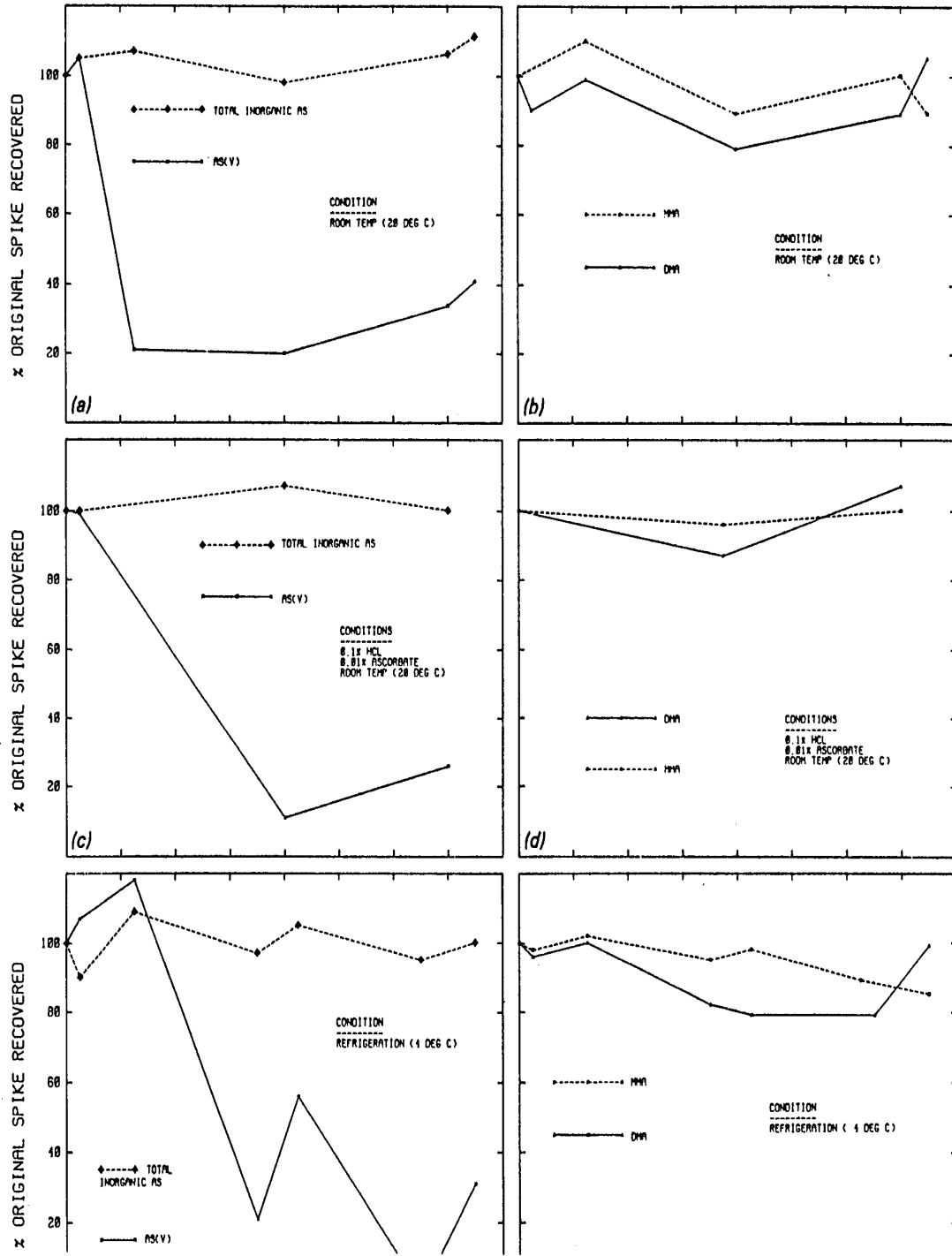

Figure 2-4a-p. Results of aqueous arsenic species storage tests. Plotted are the percentages of soluble arsenic species remaining versus storage time.

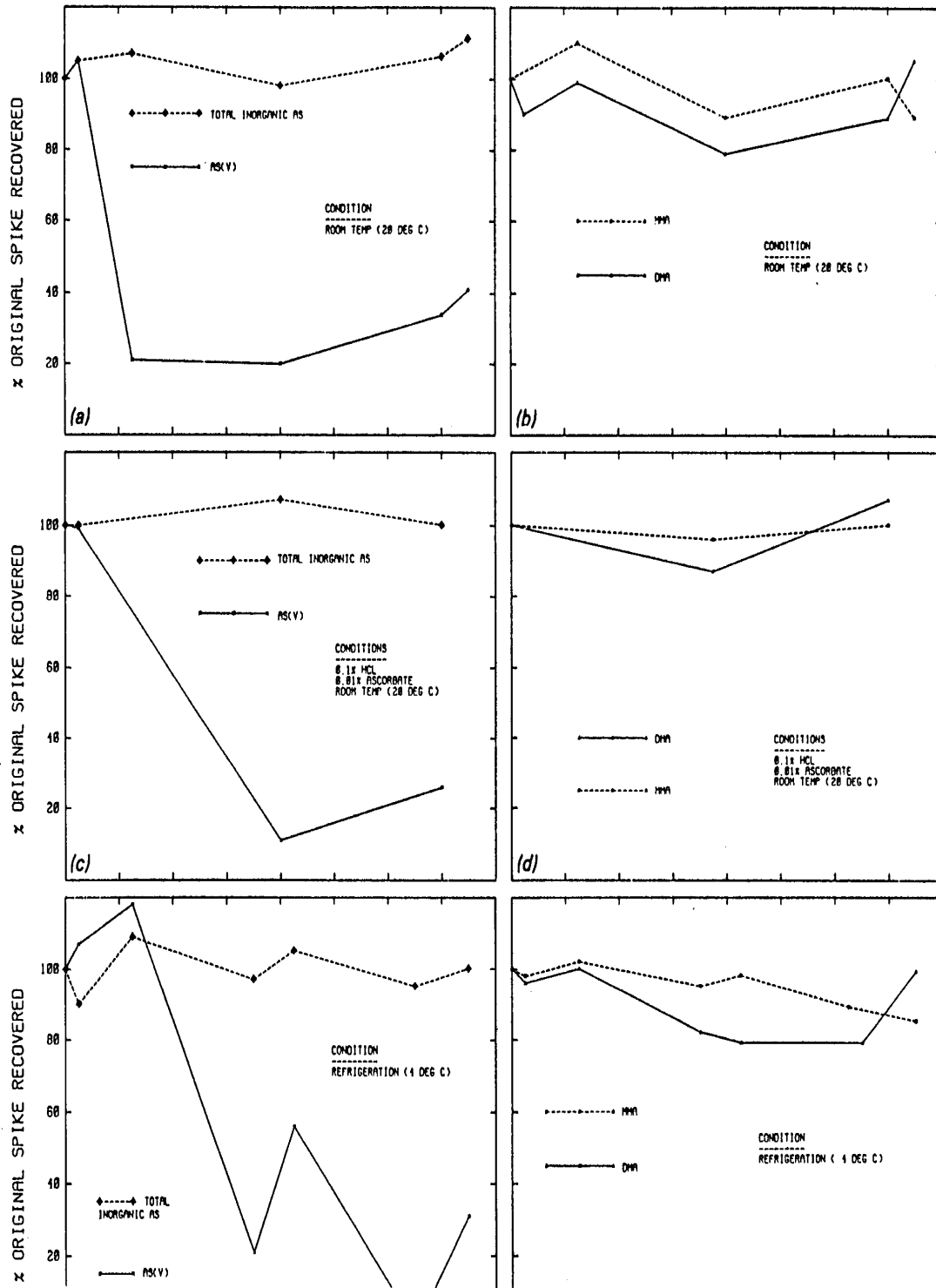

Figure 2-4a-p. (continued)

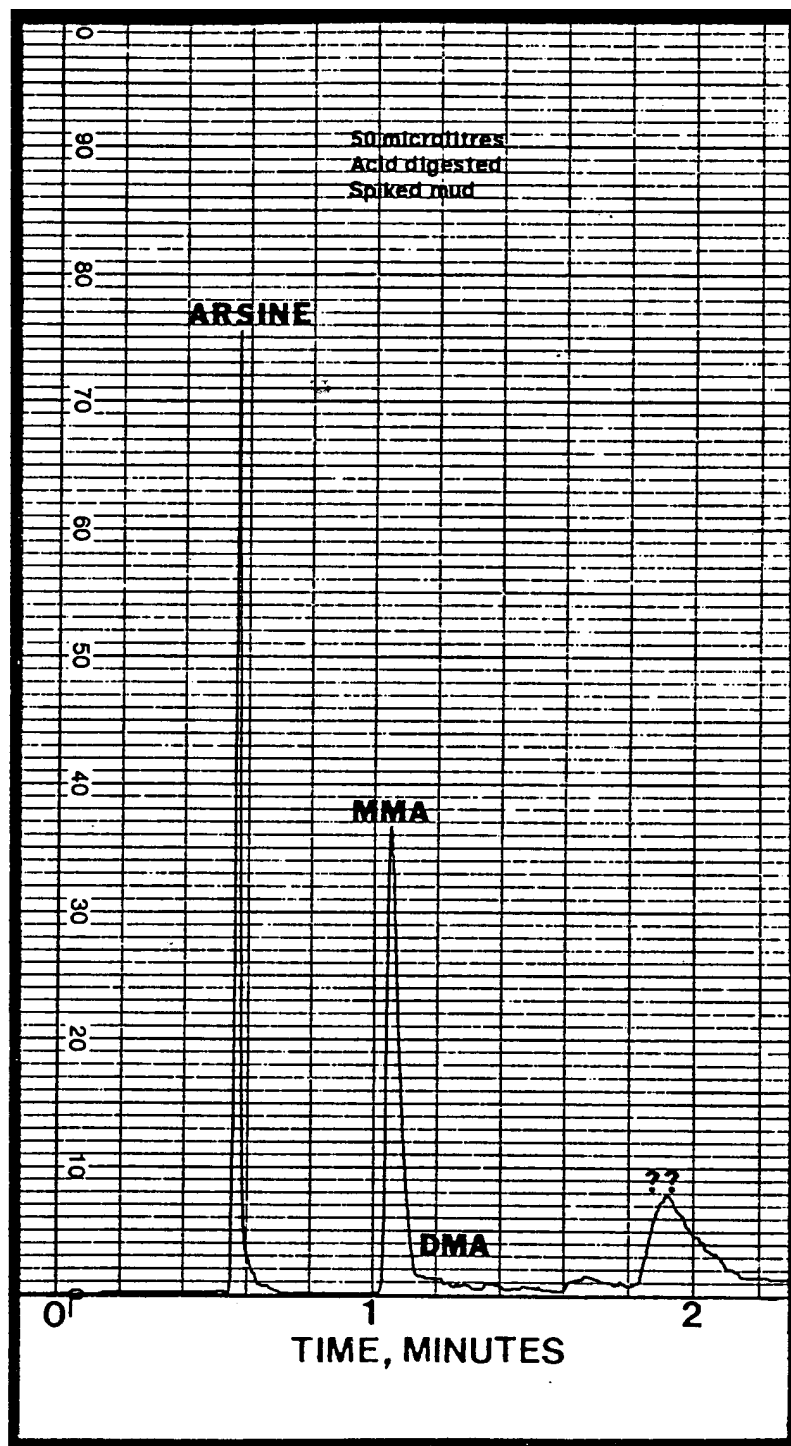

Figure 2-5. Chromatogram of digested ($\text{HNO}_3/\text{H}_2\text{SO}_4$) spiked Lake Washington mud. Vertical axis absorbance, horizontal axis time. Note absence of DMA peak and presence of unidentified higher boiling compound.

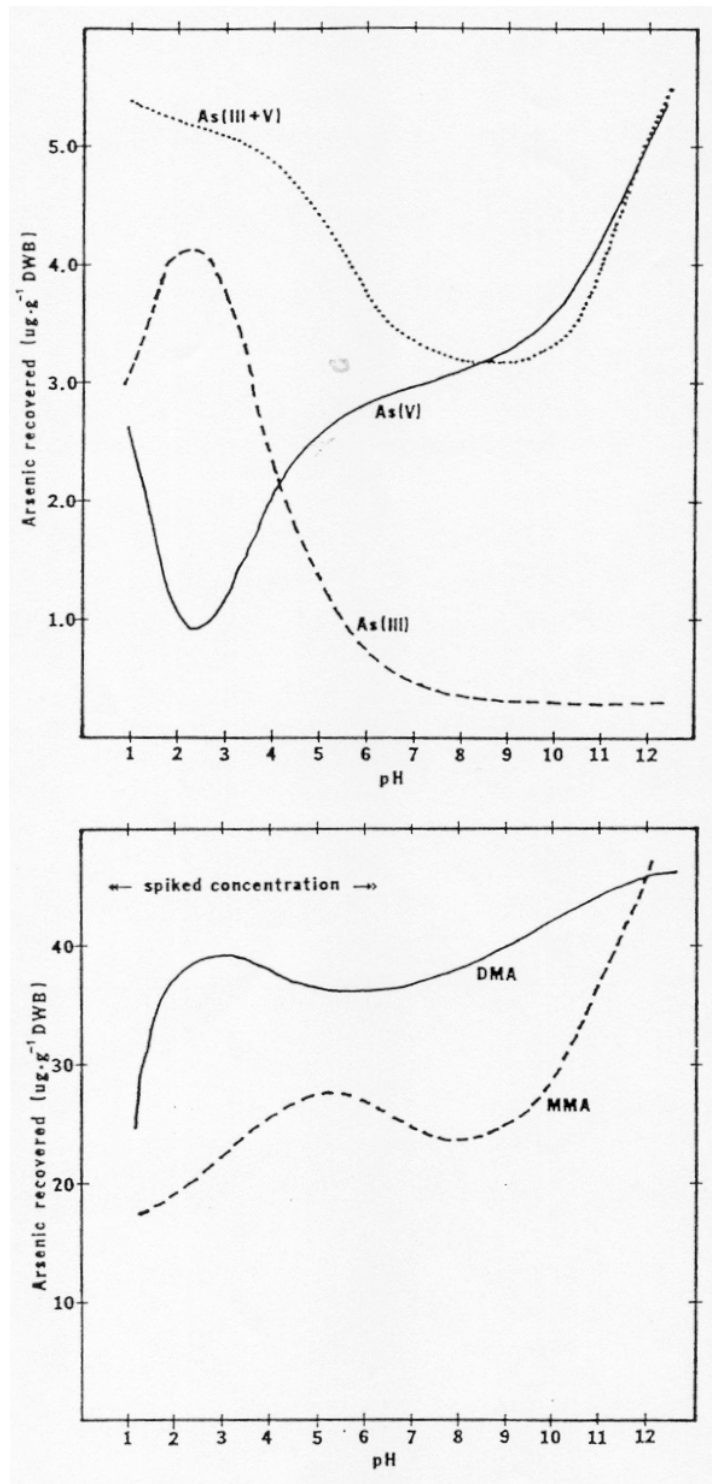

Figure 2-6. Arsenic species released from sediments as a function of solution pH. Plot of arsenic in sediment leached, µg g⁻¹ dry weight basis (DWB), versus pH of leachate.

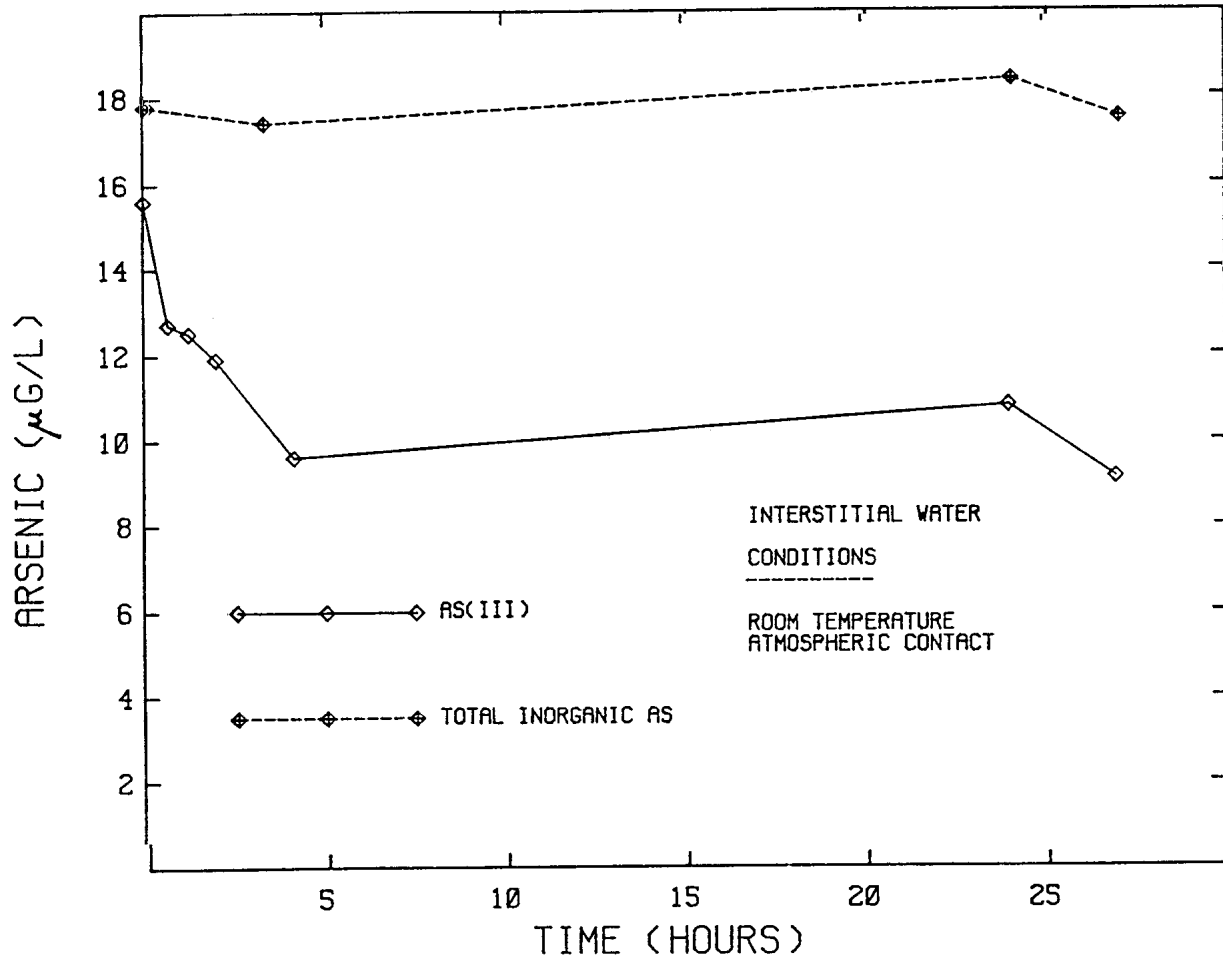

Figure 2-7. Plot of the concentration of As(III) and total inorganic arsenic versus storage time in interstitial water.

Table 2-1

Optimal Flows and Pressures for Gases
 in the Hydride Generation System

Gas	Flow rate ml • min ⁻¹	Pressure lb • in ⁻²
He	150	10
H ₂	350	20
Air	180	20

Table 2-2

Reduction Products and Their Boiling Points
 of Various Aqueous Arsenic Species

Aqueous form	Reduction product	B.P., °C
As(III), arsenous acid, HAsO ₂	AsH ₃	-55
As(V), arsenic acid, H ₃ AsO ₄	AsH ₃	-55
MMA, CH ₃ AsO(OH) ₂	CH ₃ AsH ₂	2
DMA, (CH ₃) ₂ AsO(OH)	(CH ₃) ₂ AsH	35.6

Table 2-3

Replicate Determinations of Total Inorganic Arsenic in Some Standard Waters

Replicate	Total (inorganic) arsenic, $\mu\text{g}\cdot\text{l}^{-1}$	
	NASS-1 Seawater	NBS River water
1	1.579	81.5
2	1.556	74.5
3	1.591	71.8
4	1.493	79.0
5	1.529	79.3
N	5	5
\bar{X}	1.550	77.2
S	0.040	4.0
RSD	2.6%	5.2%
Certified	1.65	76.0
\pm	0.19	7.0

\bar{M} = number of replicates.
 \bar{X} = mean
 S = + one standard deviation
 RSD = relative standard deviation

Table 2-4

Precision Data for Three Arsenic Species, Illustrating The Decrease in Precision with Increasing Boiling Point of Species. These Samples Were Spiked River Water Used in Water Storage Tests

Replicate	Arsenic concentrations, $\text{ng}\cdot\text{l}^{-1}$		
	Inorganic arsenic	MMA	DMA
N (8-24-83)	3	3	3
\bar{X}	937	2483	2173
S	44	79	181
RSD	4.7%	3.2%	8.3%
N (9-11-83)	3	4	4
\bar{X}	800	2342	2393
S	24	165	260
RSD	3.0%	7.0%	10.9%

Table 2-5

Total Inorganic Arsenic in Standard Sediments by HNO₃/H₂SO₄

Replicate	Total (inorganic) arsenic $\mu\text{g}\cdot\text{g}^{-1}$ dry weight basis			
	MESS-1 Estuarine sediment	BCSS-1 Estuarine sediment	NBS-1646 Estuarine sediment	NBS-1648 Air particulate matter
1	8.9	10.9	9.8	123.0
2	8.8	8.5	10.0	136.0
3	8.8	9.4	9.8	115.0
4	9.6	9.8	8.5	-
5	10.1	10.7	11.0	-
N	5	5	5	3
X	9.2	9.9	9.8	125.0
S	0.6	1.0	0.9	11.0
RSD	6.5%	10.1%	9.2%	8.8%
Certified	10.6	11.1	11.6	115.0
\pm	1.2	1.4	1.3	10.0

Table 2-6

Comparison of X-ray Fluorescence Spectroscopy and Hydride Generation Aa in the Determination of Total Arsenic Environmental Sediments. All Represent Total Inorganic Arsenic by Hot Acid Digestion Except (*) Slwm, Which Is the Sum of Species by Leaching

Types of Sediment	Total arsenic, $\mu\text{g}\cdot\text{g}^{-1}$ dry weight basis			
	XRF		Hydride AA	
Lake Washington (silt)	14.6 + 0.1	n=3	14.5 + 1.1	n=6
Spiked Lake Washington (silt)	124.1 + 3.4	n=3	120.0 + 7.5	n=5*
BCSS-1, clean estuarine (mud)	11.7 + 0.7	n=3	9.9 + 1.0	n=5
Contaminated Puget Sound (sandy)	108.0 + 24.0	n=3	93.0 + 21.0	n=3
Duwamish River (sand)	8.0	n=1	2.6	n=1

Table 2-7

Recovery of Arsenic Species from Spiked Lake Washington Mud by Selective Leaching

Arsenic species	$\mu\text{g}\cdot\text{g}^{-1}$ Arsenic, dry weight basis			
	Lake Washington mud	Spike added	Total recovered	Percent recovery
As(III)	2.2 + 0.3	5.8	8.2 + 14	103%
As(V)	4.4 + 0.3	9.5	13.5 + 17	96%
MMA	<0.8	58.0	51.3 + 6.0	88%
DMA	<0.8	54.0	47.0 + 4.2	87%

Table 2-8

Thirty-day Storage Results for Arsenic Speciation in Sediments

Lake Washington mud

Arsenic species	$\mu\text{g} \cdot \text{g}^{-1}$ Arsenic, dry weight basis		
	Initial concentration	Concentrations after 30-day aging	
		Refrigerated, 0-4°C	Frozen, -18°C
As(III)	2.2 + 0.3	2.2 + 0.4	2.3 + 0.3
As(V)	4.4 + 0.3	5.2 + 0.4	5.4 + 0.4
MMA	<0.8	<0.8	<0.8
DMA	<0.8	<0.8	<0.8

Spiked Lake Washington mud

Arsenic species	$\mu\text{g} \cdot \text{g}^{-1}$ Arsenic, dry weight basis		
	Initial concentration	Concentrations after 30-day aging	
		Refrigerated, 0-4°C	Frozen, -18°C
As(III)	8.2 ± 1.4	7.1 ± 2.7	9.9 ± 1.3
As(V)	13.5 ± 1.7	13.8 ± 1.0	16.0 ± 0.5
MMA	51.3 ± 6.0	39.9 ± 1.6	46.2 ± 3.5
DMA	47.0 ± 4.2	46.5 ± 3.2	40.0 ± 2.4

Table 2-9

Arsenic Speciation of Spiked Lake Washington Mud
 Interstitial Water K_d Values Represent [As (Dry Weight Sediment)]/[As (Interstitial Water)]

Species	Arsenic concentration $\mu\text{g} \cdot \text{g}^{-1}$		
	Dry sediment	Interstitial water	K_d
As(V)	20	<0.002	>10,000
As(III)	5.2	0.014	371
MMA	40	0.11	364
DMA	38	1.72	23

Table 2-10

Arsenic Speciation Intercomparison Exercise

Sample	$\mu\text{g } \ell^{-1}$							
	AS (III)		As (V)		MMA		DMW	
	BNW	Andreae	BNW	Andreae	BNW	Andreae	BNW	Andreae
DRW	0.061 ± 0.004	0.067	0.042 ± 0.008	0.023	<0.01	0.002	<0.01	0.067
SDRW	0.061 ± 0.005	0.066	0.468 ± 0.028	0.421	1.96 ± 0.11	1.67	1.92 ± 0.13	1.82
FA	0.052 ± 0.006	0.031	12.9 ± 0.2	12.0	<0.01	ND	<0.01	ND

Intercomparison exercise results with Meinrat 0. Andreae for arsenic speciation in limnological samples. DRW is filtered Dungeness River water; SDRW is Dungeness River water spiked with nominally $0.45 \mu\text{g} \cdot \ell^{-1}$ As (V), and $2 \mu\text{g} \cdot \ell^{-1}$ each DMA and MMA. FA is the filtrate of 1000 mg Q-1 NBS coal fly ash leached with DRW. BNW results are the mean of (3) determinations. ND means not detected. \pm = one standard deviation.

Table 2-11

Precision of Arsenic Speciation HYCO Reservoir
(February 1984)

Replicate	Sediment As, Sta. 5 $\mu\text{g g}^{-1}$ dry wt			Interstitial As, Sta. 5 $\mu\text{g L}^{-1}$			Water column, Sta. 4 $\mu\text{g L}^{-1}$		
	Total	AS (V)	AS (III)	Total	As (V)	AS (III)	Total	As (V)	As (III)
1	38.33	25.15	13.18	75.8	41.1	34.7	1.222	1.128	0.094
2	36.61	21.74	14.87	67.1	29.9	37.2	1.082	0.983	0.099
3	25.27	15.24	10.03	77.2	32.0	45.2	1.186	1.079	0.107
4	21.28	12.75	8.53	--	--	--	--	--	--
5	29.49	17.26	12.23	--	--	--	--	--	--
6	28.71	16.97	11.74	--	--	--	--	--	--
N	6	6	6	3	3	3	3	3	3
X	29.95	18.19	11.76	73.4	34.4	39.0	1.163	1.063	0.100
S	6.53	4.51	2.26	5.5	6.0	5.5	0.073	0.074	0.007
RSD	21.8%	24.8%	19.2%	7.5%	17.4%	14.1%	6.3%	6.9%	6.6%

REFERENCES

1. Braman, R. S., L. L. Johnson, C. C. Foreback, J. M. Ammons and J. L. Bricker. "Separation and determination of nanogram amounts of inorganic arsenic and methylarsenic compounds." *Analytical Chemistry* 49 (4):621-625 (1977).
2. Andreae, M. O. "Determination of arsenic species in natural waters." *Analytical Chemistry* 49:820, May 1977.
3. Andreae, M. O. "Methods of Seawater Analysis." Arsenic (by hydride generation/AAS), pp. 168-173 Verlag Chemie, Florida, (1983).
4. Maher, W. A. "Determination of inorganic and methylated arsenic species in marine organisms and sediments." *Analytica Chimica Acta* 126:157-165 (1981).

APPENDIX I

QUALITY ASSURANCE AND QUALITY CONTROL GUIDANCE

APPENDIX I

QUALITY ASSURANCE(QA) AND QUALITY CONTROL (QC) GUIDANCE

I.1 GENERAL QA AND QC CONSIDERATIONS

The primary objective of the specific QA and QC guidance provided in this document is to ensure that

- Appropriate data quality objectives or requirements are established **prior** to sample collection and analysis.
- Samples are collected, processed, and analyzed according to scientifically valid, cost-effective, standardized procedures.
- The integrity and security of samples and data are maintained at all times.
- Recordkeeping and documentation procedures are adequate to ensure the traceability of all samples and data from initial sample collection through final reporting and archiving and to ensure the verifiability and defensibility of reported results.
- Data quality is assessed, documented, and reported properly.
- Reported results are complete, accurate, and comparable with those from other similar monitoring programs.

I.2 QA PLAN REQUIREMENTS

To ensure the quality, defensibility, and comparability of the data used to determine exposure assessments and fish consumption advisories, it is essential that an effective QA program be developed as part of the overall design for each monitoring program. The specific QA activities should be documented in a written QA Project Plan (QAPP) or in a combined Work/QA Plan and should be implemented strictly throughout all phases of the monitoring program.

The QAPP should follow the guidelines and requirements specified in *EPA Guidance for Quality Assurance Project Plans* (EPA QA/G-5) and *EPA Requirements for Quality Assurance Project Plans for Environmental Data* (EPA

QA/R-5), where applicable. To obtain the type and quality of environmental data needed for decision making or a specified end use, the QAPP needs to provide a project-specific strategy for applying QA and quality control (QC) procedures.

The QAPP should be composed of standardized, recognizable elements that cover the entire project. These elements should be organized under four general categories that correspond to the planning, implementation, assessment, and validation phases of the project. Although project-specific tailoring of the EPA guidance for developing QA plans is encouraged, all required information must be included either in full or by reference to appropriate standard operating procedures (SOPs). The following summarizes the pertinent elements of a QAPP for each phase of the project.

1. Project Management

- a. A historical and scientific perspective of the project including a description of the problem to be solved or the decision to be made
- b. A clear statement of the project goals and the approach to be used and an overview of the work to be performed and the schedule of implementation
- c. A description of the program organization and personnel roles and responsibilities, including responsibility for ensuring adherence to the QA plan
- d. Specification of data quality objectives in terms of accuracy, precision, representativeness, and completeness, for data generated from each type of measurement system
- e. Identification of special training for project personnel
- f. A description of the procedure for obtaining approval for substantive changes in the monitoring program
- g. Detailed description of health and safety procedures

2. Measurement and Data Acquisition

- a. Detailed descriptions of field sample collection and handling procedures, including documentation of
 - Target species and size (age) class
 - Sampling site locations
 - Target contaminants
 - Sampling times/schedules

-
- Numbers of samples and sample replication strategy
 - Sample collection procedures
 - Sample processing procedures, including sample identification, labeling, preservation, and storage conditions
 - Sample shipping procedures
- b. A detailed description of chain-of-custody procedures, including specification of standard chain-of-custody forms and clear assignment of field and laboratory personnel responsibilities for sample custody
- c. Detailed descriptions of laboratory procedures for sample receipt, storage, and preparation, including specification of the kinds of samples to be prepared for analyses (e.g., composite vs. individual, whole body vs. fillet, replicates)
- d. Detailed descriptions of the analytical methods used for quantitation of target contaminants and percent lipid determination
- e. Detailed descriptions of methods routinely used to assess data accuracy, precision, and completeness, including
- Internal QC checks using field, reagent, or method blanks; spiked samples; split samples; QC samples prepared from standard reference materials; and replicate analyses
 - Calibration checks
 - Data quality assessments
- f. Detailed descriptions of preventive maintenance procedures for sampling and analysis equipment
- g. Detailed descriptions of calibration procedures for all measurement instruments, including specification of reference materials used for calibration standards and calibration schedules
- h. Detailed descriptions of recordkeeping and documentation procedures, including requirements for
- Maintaining field and laboratory logs and notebooks
 - Use of standard data collection and reporting forms
 - Making changes to original records
 - Number of significant figures to be recorded for each type of data
 - Units of reporting
 - Routine procedures to assess the accuracy and completeness of records

3. Assessment and Oversight
 - a. Detailed descriptions of data management and reporting procedures, including requirements for
 - Technical reports
 - QA and QC reports
 - Data coding procedures
 - Database specifications
 - QA review of reported data
 - Data storage and archiving procedures
 - b. Detailed descriptions of procedures for internal QC performance and/or systems audits for sampling and analysis programs
 - c. Detailed descriptions of procedures for external QA performance and/or systems audits for sampling and analysis programs, including participation in certified QA proficiency testing or interlaboratory comparison programs
 - d. Detailed descriptions of corrective action procedures in both sampling and analysis programs, including
 - Criteria and responsibility for determining the need for corrective action
 - Procedures for ensuring that effective corrective action has been taken
 - Procedures for documenting and reporting corrective actions
4. Data Validation and Usability
 - a. Provide the criteria to be used in reviewing and validating the data and for deciding the degree to which each data item has met its quality specification
 - b. Describe the process to be used for validating and verifying data, including the chain of custody for data throughout the project
 - c. Include detailed descriptions of data analysis procedures, including
 - Statistical treatment of data
 - Data summary formats (e.g., plots, tables)
 - d. Precisely define and interpret how validation issues differ from verification issues

Guidance for addressing each of the QA or QC elements outlined above, including a list of recommended standard reference materials and external QA or interlaboratory comparison programs for the analyses of target analytes, is incorporated in the appropriate sections of this guidance document. The EPA guidance and requirements documents (EPA QA/G-5 and EPA QA.R-5) should be referenced for more detailed discussions of the elements to be included in the QA plan (available at http://es.epa.gov/ncercqa/qaqa_docs.html).

APPENDIX J

RECOMMENDED PROCEDURES FOR PREPARING WHOLE FISH COMPOSITE HOMOGENATE SAMPLES

APPENDIX J

RECOMMENDED PROCEDURES FOR PREPARING WHOLE FISH COMPOSITE HOMOGENATE SAMPLES

J.1 GENERAL GUIDELINES

Laboratory processing to prepare whole fish composite samples (diagrammed in Figure J-1) involves

- Inspecting individual fish for foreign material on the surface and rinsing if necessary
- Weighing individual fish
- Examining each fish for morphological abnormalities (optional)
- Removing scales or otoliths for age determination (optional)
- Determining the sex of each fish (optional)
- Preparing individual whole fish homogenates
- Preparing a composite whole fish homogenate.

Whole fish should be shipped on wet or blue ice from the field to the sample processing laboratory if next-day delivery is assured. Fish samples arriving in this manner (chilled but not frozen) should be weighed, scales and/or otoliths removed, and the sex of each fish determined within 48 hours of sample collection. The grinding/homogenization procedure may be carried out more easily and efficiently if the sample has been frozen previously (Stober, 1991). Therefore, the samples should then be frozen (≤ -20 °C) in the laboratory prior to being homogenized.

If the fish samples arrive frozen (i.e., on dry ice) at the sample processing laboratory, precautions should be taken during weighing, removal of scales and/or otoliths, and sex determination to ensure that any liquid formed in thawing remains with the sample. **Note:** The liquid will contain target analyte contaminants and lipid material that should be included in the sample for analysis.

The thawed or partially thawed whole fish should then be homogenized individually, and equal weights of each homogenate should be combined to form the composite sample. Individual homogenates and/or composite homogenates may be frozen; however, frozen individual homogenates must be rehomogenized before compositing, and frozen composite homogenates must be rehomogenized before aliquotting for analysis. The maximum holding time from sample collection to analysis for mercury is 28 days at ≤ -20 °C; for all other analytes, the holding time is 1 year at ≤ -20 °C (Stober, 1991). Recommended container materials,

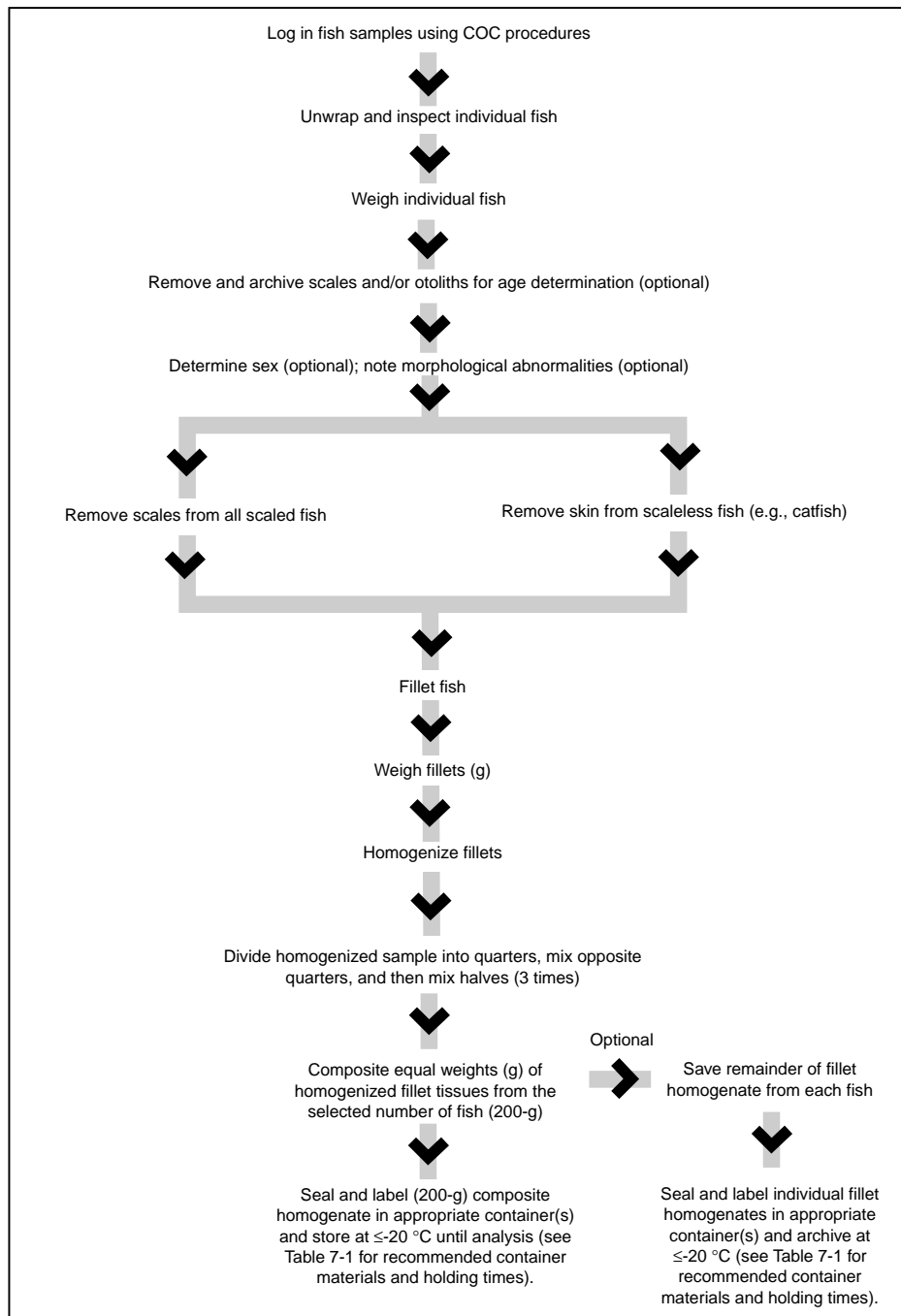

COC = Chain of custody.

Figure J-1. Laboratory sample preparation and handling for whole fish composite homogenate samples.

preservation temperatures, and holding times are given in Table J-1. **Note:** Holding times in Table J-1 are maximum times recommended for holding samples from the time they are received at the laboratory until they are analyzed. These holding times are based on guidance that is sometimes administrative rather than technical in nature; there are no promulgated holding time criteria for tissues (U.S. EPA, 1995b). If states choose to use longer holding times, they must demonstrate and document the stability of the target analyte residues over the extended holding times.

J.2 SAMPLE PROCESSING PROCEDURES

Fish sample processing procedures are discussed in more detail in the sections below. Each time custody of a sample or set of samples is transferred from one person to another during processing, the Personal Custody Record of the chain-of-custody (COC) form that originated in the field (Figure 6-8) must be completed and signed by both parties so that possession and location of the samples can be traced at all times (see Section 7.1). As each sample processing procedure is performed, it should be documented directly in a bound laboratory notebook or on standard forms that can be taped or pasted into the notebook. The use of a standard form is recommended to ensure consistency and completeness of the record. Several existing programs have developed forms similar to the sample processing record for whole fish composite samples shown in Figure J-2.

J.2.1 Sample Inspection

Individual fish received for filleting should be unwrapped and inspected carefully to ensure that they have not been compromised in any way (i.e., not properly preserved during shipment). Any specimen deemed unsuitable for further processing and analysis should be discarded and identified on the sample processing record.

J.2.2 Sample Weighing

A wet weight should be determined for each fish. All samples should be weighed on balances that are properly calibrated and of adequate accuracy and precision to meet program data quality objectives. Balance calibration should be checked at the beginning and end of each weighing session and after every 20 weighings in a weighing session.

Fish shipped on wet or blue ice should be weighed directly on a foil-lined balance tray. To prevent cross contamination between individual fish, the foil lining should be replaced after each weighing. Frozen fish (i.e., those shipped on dry ice) should be weighed in clean, tared, noncontaminating containers if they will thaw before the weighing can be completed. Liquid from the thawed sample must be

Table J-1. Recommendations for Container Materials, Preservation, and Holding Times for Fish, Shellfish, and Turtle Tissues from Receipt at Sample Processing Laboratory to Analysis

Analyte	Matrix	Sample container	Storage	
			Preservation	Holding time ^a
Mercury	Tissue (whole specimens, homogenates)	Plastic, borosilicate glass, quartz, and PTFE	Freeze at ≤ -20 °C	28 days ^b
Other metals	Tissue (whole specimens, homogenates)	Plastic, borosilicate glass, quartz, and PTFE	Freeze at ≤ -20 °C	6 months ^c
Organics	Tissue (whole specimens, homogenates)	Borosilicate glass, quartz, PTFE, and aluminum foil	Freeze at ≤ -20 °C	1 year ^d
Metals and organics	Tissue (whole specimens, homogenates)	Borosilicate glass, quartz, and PTFE	Freeze at ≤ -20 °C	28 days (mercury); 6 months (for other metals); and 1 year (for organics)
Lipids	Tissue (whole specimens, homogenates)	Plastic, borosilicate glass, quartz, PTFE	Freeze at ≤ -20 °C	1 year

PTFE = Polytetrafluoroethylene for Teflon.

^a Maximum holding times recommended by U.S. EPA (1995b).

^b This maximum holding time is also recommended by the Puget Sound Estuary Program (1990). The California Department of Fish and Game (1990) and the USGS National Water Quality Assessment Program (Crawford and Luoma, 1993) recommend a maximum holding time of 6 months for all metals, including mercury.

^c This maximum holding time is also recommended by the California Department of Fish and Game (1990), the 301(h) monitoring program (U.S. EPA, 1986), and the USGS National Water Quality Assessment Program (Crawford and Luoma, 1993). The Puget Sound Estuary Program (1990) recommends a maximum holding time of 2 years.

^d This maximum holding time is also recommended by the Puget Sound Estuary Program (1990). The California Department of Fish and Game (1990) and the USGS National Water Quality Assessment Program (Crawford and Luoma, 1993) recommend a more conservative maximum holding time of 6 months. EPA (1995a) recommends a maximum holding time of 1 year at ≤ -10 °C for dioxins and dibenzofurans.

Sample Processing Record for Fish Contaminant Monitoring Program — Whole Fish Composites

Project No. _____ Sampling Date and Time: _____

STUDY PHASE: Screening ; Intensive: Phase I Phase II

SITE LOCATION

Site Name/Number: _____

County/Parish: _____ Lat./Long.: _____

State Waterbody Segment Number: _____ Waterbody Type: _____

Bottom Feeder – Species Name: _____

Composite Sample #: _____ Number of Individuals: _____

Fish #	Weight (g)	Scales/Otoliths Removed (✓)	Sex (M, F)	Homogenate Prepared (✓)	Weight of homogenate taken for composite (g)
001	_____	_____	_____	_____	_____
002	_____	_____	_____	_____	_____
003	_____	_____	_____	_____	_____
004	_____	_____	_____	_____	_____
005	_____	_____	_____	_____	_____
006	_____	_____	_____	_____	_____
007	_____	_____	_____	_____	_____
008	_____	_____	_____	_____	_____
009	_____	_____	_____	_____	_____
010	_____	_____	_____	_____	_____
Analyst Initials/Date	_____/_____	_____/_____	_____/_____	_____/_____	_____/_____
Total Composite Homogenate Weight					_____

Predator – Species Name: _____

Composite Sample #: _____ Number of Individuals: _____

Fish #	Weight (g)	Scales/Otoliths Removed (✓)	Sex (M, F)	Homogenate Prepared (✓)	Weight of homogenate taken for composite (g)
001	_____	_____	_____	_____	_____
002	_____	_____	_____	_____	_____
003	_____	_____	_____	_____	_____
004	_____	_____	_____	_____	_____
005	_____	_____	_____	_____	_____
006	_____	_____	_____	_____	_____
007	_____	_____	_____	_____	_____
008	_____	_____	_____	_____	_____
009	_____	_____	_____	_____	_____
010	_____	_____	_____	_____	_____
Analyst Initials/Date	_____/_____	_____/_____	_____/_____	_____/_____	_____/_____
Total Composite Homogenate Weight					_____

Notes: _____

Figure J-2. Example of a sample processing record for fish contaminant monitoring program—whole fish composites.

kept in the container as part of the sample because it will contain lipid material that has separated from the tissue (Stober, 1991).

All weights should be recorded to the nearest gram on the sample processing record and/or in the laboratory notebook.

J.2.3 Age Determination

Age provides a good indication of the duration of exposure to pollutants (Versar, 1982). A few scales or otoliths (Jearld, 1983) should be removed from each fish and delivered to a fisheries biologist for age determination. For most warm water inland gamefish, 5 to 10 scales should be removed from below the lateral line and behind the pectoral fin. On soft-rayed fish such as trout and salmon, the scales should be taken just above the lateral line (WDNR, 1988). For catfish and other scaleless fish, the pectoral fin spines should be clipped and saved (Versar, 1982). The scales, spines, or otoliths may be stored by sealing them in small envelopes (such as coin envelopes) or plastic bags labeled with, and cross-referenced by, the identification number assigned to the tissue specimen (Versar, 1982). Removal of scales, spines, or otoliths from each fish should be noted (by a check mark) on the sample processing record.

J.2.4 Sex Determination (Optional)

To determine the sex of a fish, an incision should be made on the ventral surface of the body from a point immediately anterior to the anus toward the head to a point immediately posterior to the pelvic fins. If necessary, a second incision should be made on the left side of the fish from the initial point of the first incision toward the dorsal fin. The resulting flap should be folded back to observe the gonads. Ovaries appear whitish to greenish to golden brown and have a granular texture. Testes appear creamy white and have a smooth texture (Texas Water Commission, 1990). The sex of each fish should be recorded on the sample processing record.

J.2.5 Assessment of Morphological Abnormalities (Optional)

Assessment of gross morphological abnormalities in finfish is optional. This assessment may be conducted in the field (see Section 6.3.1.5) or during initial inspection at the central processing laboratory prior to filleting. States interested in documenting morphological abnormalities should consult Sinderman (1983) and review recommended protocols for fish pathology studies used in the Puget Sound Estuary Program (1990).

J.2.6 Preparation of Individual Homogenates

To ensure even distribution of contaminants throughout tissue samples, whole fish must be ground and homogenized prior to analyses.

Smaller whole fish may be ground in a hand crank meat grinder (fish < 300 g) or a food processor (fish 300-1,000 g). Larger (>1,000 g) fish may be cut into 2.5-cm cubes with a food service band saw and then ground in either a small or large homogenizer. To avoid contamination by metals, grinders and homogenizers used to grind and blend tissue should have tantalum or titanium blades and/or probes. Stainless steel blades and probes have been found to be a potential source of nickel and chromium contamination (due to abrasion at high speeds) and should be avoided.

Grinding and homogenization of biological tissue, especially skin from whole fish samples, is easier when the tissue is partially frozen (Stober, 1991). Chilling the grinder/homogenizer briefly with a few chips of dry ice will reduce the tendency of the tissue to stick to the grinder.

The ground sample should be divided into quarters, opposite quarters mixed together by hand, and the two halves mixed back together. The grinding, quartering, and hand mixing should be repeated two more times. If chunks of tissue are present at this point, the grinding/homogenizing should be repeated. No chunks of tissue should remain because these may not be extracted or digested efficiently. If the sample is to be analyzed for metals only, the ground tissue may be mixed by hand in a polyethylene bag (Stober, 1991). Homogenization of each individual fish should be noted on the sample processing record. At this time, individual whole fish homogenates may be either composited or frozen and stored at ≤ -20 °C in cleaned containers that are noncontaminating for the analyses to be performed (see Table J-1).

J.2.7 Preparation of Composite Homogenates

Composite homogenates should be prepared from equal weights of individual homogenates. If individual whole fish homogenates have been frozen, they should be thawed partially and rehomogenized prior to compositing. Any associated liquid should be maintained as a part of the sample. The weight of each individual homogenate that is used in the composite homogenate should be recorded, to the nearest gram, on the sample processing record.

Each composite homogenate should be blended by dividing it into quarters, mixing opposite quarters together by hand, and mixing the two halves together. The quartering and mixing should be repeated at least two more times. If the sample is to be analyzed only for metals, the composite homogenate may be mixed by hand in a polyethylene bag (Stober, 1991). At this time, the composite homogenate may be processed for analysis or frozen and stored at ≤ -20 °C (see Table J-1).

The remainder of each individual homogenate should be archived at ≤ -20 °C with the designation "Archive" and the expiration date recorded on the sample label. The location of the archived samples should be indicated on the sample processing record under "Notes."

It is essential that the weights of individual homogenates yield a composite homogenate of adequate size to perform all necessary analyses. Weights of individual homogenates required for a composite homogenate, based on the number of fish per composite and the weight of composite homogenate recommended for analyses of all screening study target analytes (see Table 4-1), are given in Table J-2. The total composite weight required for intensive studies may be less than in screening studies if the number of target analytes is reduced significantly.

The recommended sample size of 200 g for screening studies is intended to provide sufficient sample material to (1) analyze for all recommended target analytes (see Table 4-1) at appropriate detection limits, (2) meet minimum QA and QC requirements for the analyses of replicate, matrix spike, and duplicate matrix spike samples (see Section 8.3.3.4), and (3) allow for reanalysis if the QA and QC control limits are not met or if the sample is lost. However, sample size requirements may vary among laboratories and the analytical methods used. Therefore, it is the responsibility of each program manager to consult with the analytical laboratory supervisor to determine the actual weights of composite homogenates required to analyze for all selected target analytes at appropriate detection limits.

J.3 REFERENCES

- California Department of Fish and Game. 1990. *Laboratory Quality Assurance Program Plan*. Environmental Services Division, Sacramento, CA.
- Crawford, J.K., and S.N. Luoma. 1993. *Guidelines for Studies of Contaminants in Biological Tissues for the National Water-Quality Assessment Program*. USGS Open-File Report 92-494. U.S. Geological Survey, Lemoyne, PA.
- Jearld, A. 1983. Age determination. pp. 301-324. In: *Fisheries Techniques*. L.A. Nielsen and D. Johnson (eds.). American Fisheries Society, Bethesda, MD.
- Puget Sound Estuary Program. 1990 (revised). Recommended protocols for fish pathology studies in Puget Sound. Prepared by PTI Environmental Services, Bellevue, WA. In: *Recommended Protocols and Guidelines for Measuring Selected Environmental Variables in Puget Sound*. Region 10, U.S. Environmental Protection Agency, Seattle, WA. (Looseleaf)
- Sinderman, C. J. 1983. An examination of some relationships between pollution and disease. *Rapp. P. V. Reun. Cons. Int. Explor. Mer.* 182:37-43.
- Stober, Q. J. 1991. *Guidelines for Fish Sampling and Tissue Preparation for Bioaccumulative Contaminants*. Environmental Services Division, Region 4, U.S. Environmental Protection Agency, Athens, GA.

- Texas Water Commission. 1990. *Texas Tissue Sampling Guidelines*. Texas Water Commission, Austin, TX.
- U.S. EPA (U.S. Environmental Protection Agency). 1986. *Bioaccumulation Monitoring Guidance: 4. Analytical Methods for U.S. EPA Priority Pollutants and 301(h) Pesticides in Tissues from Marine and Estuarine Organisms*. EPA-503/6-90-002. Office of Marine and Estuarine Protection, Washington, DC.
- U.S. EPA (U.S. Environmental Protection Agency). 1995a. *Method 1613b. Tetra- through Octa-Chlorinated Dioxins and Furans by Isotope Dilution HRGC/HRMS*. Final Draft. Office of Water, Office of Science and Technology, Washington, DC.
- U.S. EPA (Environmental Protection Agency). 1995b. *QA/QC Guidance for Sampling and Analysis of Sediments, Water, and Tissues for Dredged Material Evaluations—Chemical Evaluations*. EPA 823-B-95-001. Office of Water, Washington, DC, and Department of the Army, U.S. Army Corps of Engineers, Washington, DC.
- Versar, Inc. 1982. *Sampling Protocols for Collecting Surface Water, Bed Sediment, Bivalves and Fish for Priority Pollutant Analysis--Final Draft Report*. EPA Contract 68-01-6195. Prepared for U.S. EPA Office of Water Regulations and Standards. Versar, Inc., Springfield, VA.
- WDNR (Wisconsin Department of Natural Resources). 1988. *Fish Contaminant Monitoring Program—Field and Laboratory Guidelines (1005.1)*. Madison, WI.

APPENDIX K

GENERAL PROCEDURES FOR REMOVING EDIBLE TISSUES FROM FRESHWATER TURTLES

APPENDIX K

GENERAL PROCEDURES FOR REMOVING EDIBLE TISSUES FROM FRESHWATER TURTLES

1. Turtles brought to the processing laboratory on wet, blue, or dry ice should be placed in a freezer for a minimum of 48 hours prior to resection. Profound hypothermia can be employed to induce death (Frye, 1994) Decapitation of alert animals is not recommended because there is evidence that decapitation does not produce instantaneous loss of consciousness (Frye, 1994).
2. The turtle should be placed on its back with the plastron (ventral plate) facing upward. The carapace and plastron are joined by a bony bridge on each side of the body extending between the fore and hindlimbs (Figure K-1). Using a bone shears, pliers, or sharp knife, break away the two sides of the carapace from the plastron between the fore and hind legs on each side of the body.
3. Remove the plastron to view the interior of the body cavity. At this point, muscle tissue from the forelimbs, hindlimbs, tail (posterior to the anus), and neck can be resected from the body. The muscle tissue should be skinned and the bones should be removed prior to homogenization of the muscle tissue. Typically, the muscle tissue is the primary tissue consumed, and turtle meat sold in local markets usually contains lean meat and bones only (Liner, 1978).

Dietary and culinary habits concerning which turtle tissues are edible, however, differ greatly among various populations. In some populations, the liver, heart, eggs, fatty deposits, and skin are also used (Liner, 1978). Therefore only general information on the types of turtle tissues most frequently considered edible can be presented here. State staff familiar with the dietary and culinary habits of the turtle-consuming populations within their jurisdictions are the best judge of which edible tissues should be included as part of the tissue samples used to assess the health risks to the turtle-consuming public.

4. Several of the tissue types that are considered edible include the fatty deposits found in various parts of the body, the heart, liver (usually with the gall bladder removed), and the eggs (if the specimen is a female). These edible tissues are shown in Figure K-2.

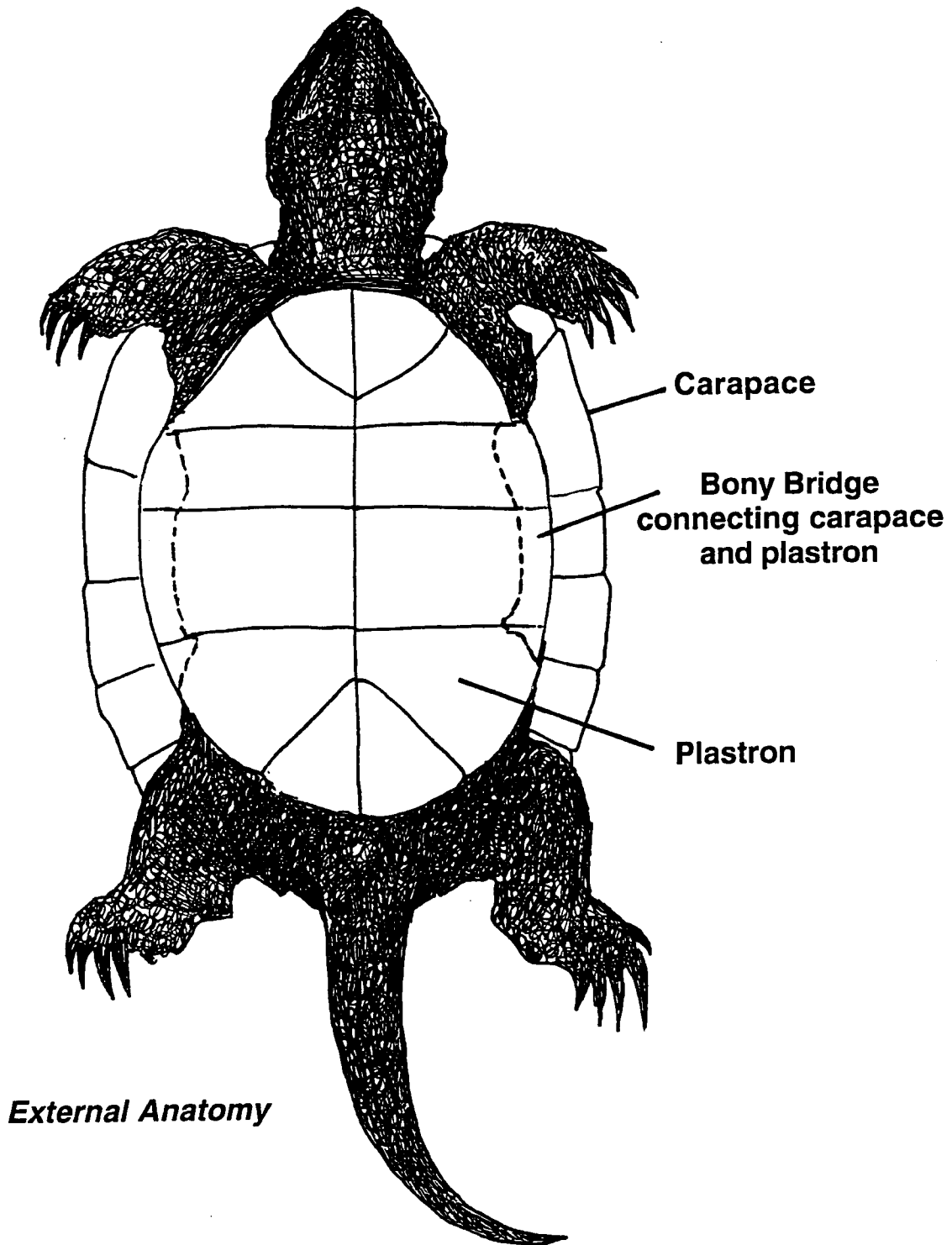

Source: Ashley, 1962.

Figure K-1.

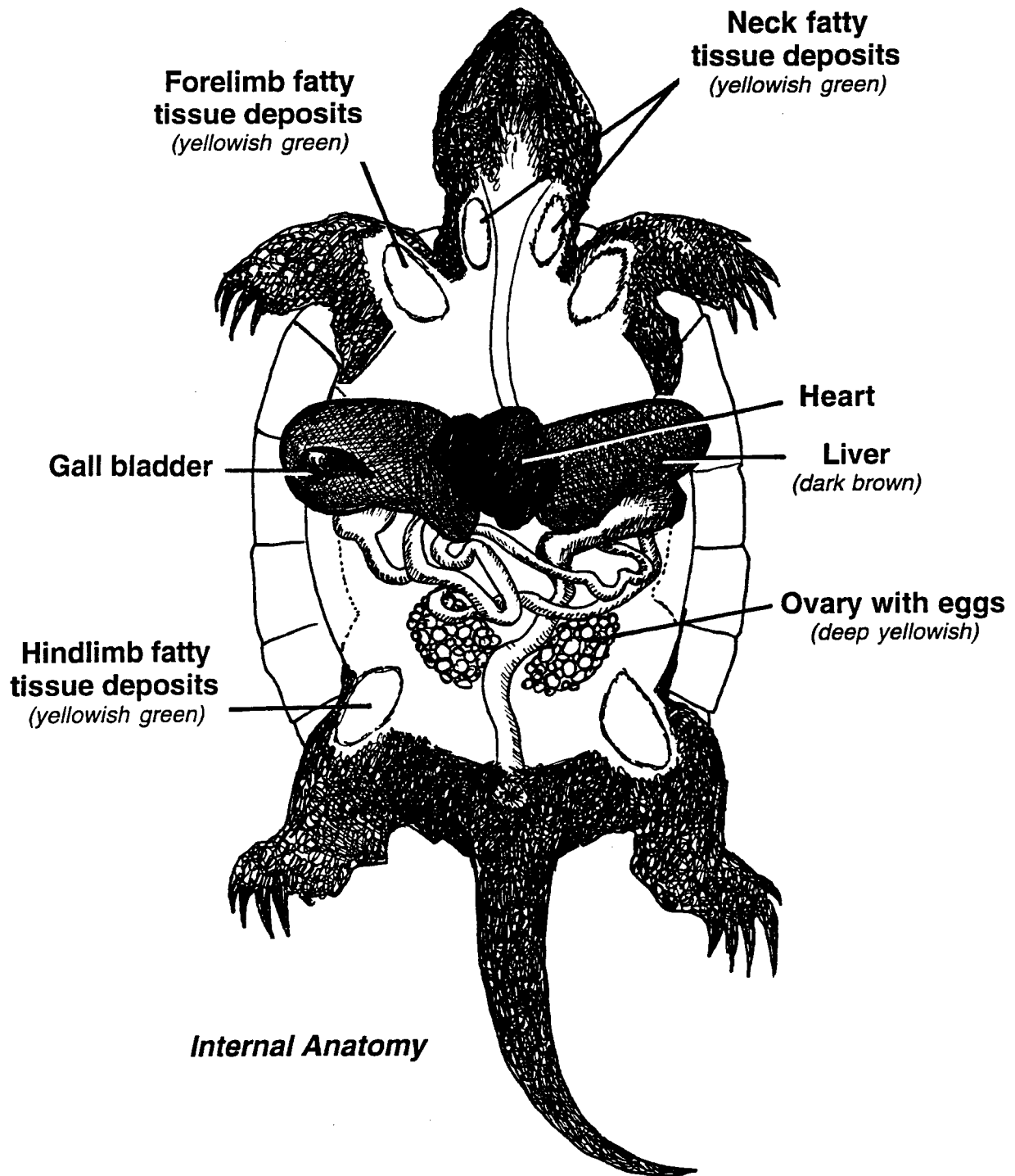

Source: Ashley, 1962.

Figure K-2.

- Masses of yellowish-green fatty deposits may be removed from above the forelimbs and from above and in front of the hindlimbs. Fatty deposits can also be found at the base of the neck near the point where the neck enters the body cavity.
- The centrally located heart is positioned anterior to the liver.
- The large brownish liver is the predominant tissue in the body cavity and is an edible tissue eaten by some populations. Note: The small greenish-colored gall bladder lies on the dorsal side of the right lobe of the liver (not visible unless the liver is lifted upward and turned over). The gall bladder is usually removed and discarded by consumers because of its acrid taste (Liner, 1978).
- If the turtle specimen is a female, ovaries containing bright yellow-colored spherical eggs of varying sizes are located posterior to the liver and lie against the dorsal body wall.

Note: The fatty deposits, liver tissue, and eggs are highly lipophilic tissues and have been shown to accumulate chemical contaminants at concentrations 10 to more than 100 times the concentrations reported from muscle tissue (Bryan et al., 1987; Hebert et al., 1993; Olafsson et al., 1983, 1987; Ryan et al., 1986; Stone et al., 1980). States may wish to resect the fatty tissues, liver, heart, and eggs for inclusion in the turtle muscle tissue sample to obtain a conservative estimate of the concentration to which the turtle-consuming public would be exposed. Alternatively, states may want to retain these tissues for individual analysis. Some states already advise their residents who consume turtles to remove all fatty tissues (Minnesota Department of Health, 1994; New York State Department of Health, 1994) and not to consume the liver and eggs (New York State Department of Health, 1994). These cleaning procedures are recommended as a risk-reducing strategy.

REFERENCES

- Ashley, L.M. 1962. *Laboratory Anatomy of the Turtle*. W.C. Brown Company Publishers, Dubuque, IA.
- Bryan, A.M., P.G. Olafsson, and W.B. Stone. 1987. Disposition of low and high environmental concentrations of PCBs in snapping turtle tissues. *Bull. Environ. Contam. Toxicol.* 38:1000-1005.
- Frye, F.L. 1994. *Reptile Clinician's Handbook: A Compact Clinical and Surgical Reference*. Krieger Publishing Company, Malabar, FL.

- Hebert, C.E., V. Glooschenko, G.D. Haffner, and R. Lazar. 1993. Organic contaminants in snapping turtle (*Chelydra serpentina*) populations from Southern Ontario, Canada. *Arch. Environ. Contam. Toxicol.* 24:35-43.
- Liner, E.A. 1978. *A Herpetological Cookbook: How to Cook Amphibians and Reptiles*. Privately printed, Houma, LA.
- Minnesota Department of Health. 1994. *Minnesota Fish Consumption Advisory*. Minneapolis, MN.
- New York State Department of Health. 1994. *Health Advisory-Chemicals in Sportfish and Game 1994-1995*. #40820042. Division of Environmental Health Assessment, Albany, NY.
- Olafsson, P.G., A.M. Bryan, B. Bush, and W. Stone. 1983. Snapping turtles—A biological screen for PCBs. *Chemosphere* 12 (11/12):1525-1532.
- Olafsson, P.G., A.M. Bryan, and W. Stone. 1987. PCB congener specific analysis: A critical evaluation of toxic levels in biota. *Chemosphere* 16 (10-12):2585-2593.
- Ryan, J.J., P.Y. Lau, and J.A. Hardy. 1986. 2,3,7,8, Tetrachlorodibenzo-p-dioxin and related dioxans and furans in snapping turtle (*Chelydra serpentina*) tissues from the upper St. Lawrence River. *Chemosphere* 15 (5):537-548.
- Stone, W.B., E. Kiviat, and S.A. Butkas. 1980. Toxicants in snapping turtles. *New York Fish and Game Journal* 27 (1):39-50.

APPENDIX L

GENERAL PROCEDURES FOR REMOVING EDIBLE TISSUES FROM SHELLFISH

Source: UNC Sea Grant Publication. 1988. UNC-SG-88.02. The Water Resources Institute, North Carolina State University, Raleigh, NC

Heading, peeling and deveining shrimp

1

To head a shrimp, hold it in one hand. With your thumb behind shrimp head, push head off. Be sure to push just the head off so that you do not lose any meat.

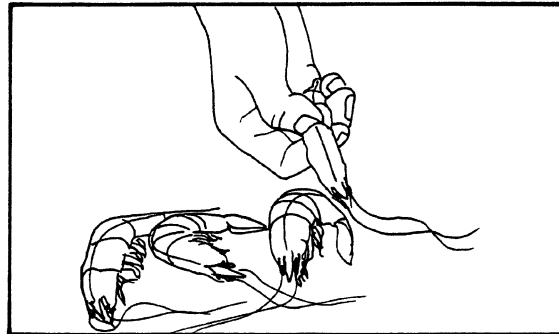

2

If using a deveiner, insert it at head end, just above the vein.

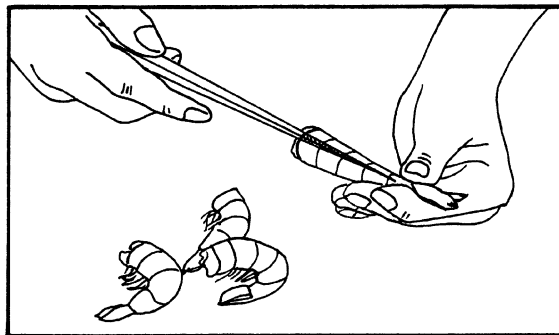

3

Push through shrimp to the tail and split and remove shell. This removes vein at the same time.

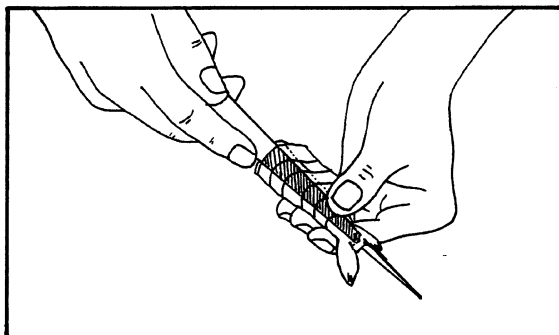

4

If you prefer to use a paring knife, shell shrimp with your fingers or knife. Then use knife to gently remove vein.

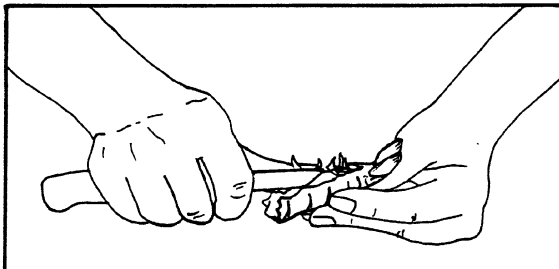

Source: UNC Sea Grant. 1988. Publication UNC-SG-88-02. The Water Resources Research Institute, North Carolina State University, Raleigh, NC.

1

Hold crab in one hand and cut across body just behind eyes to remove eyes and mouth.

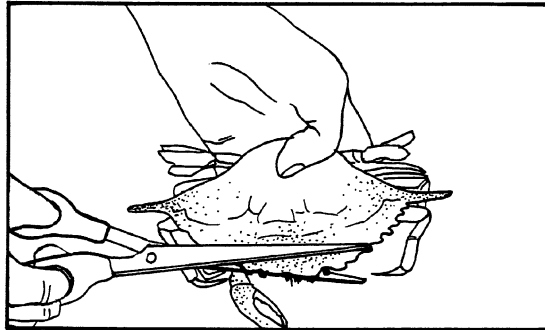
**2**

Turn crab on its back. Lift and remove apron and vein attached to it.

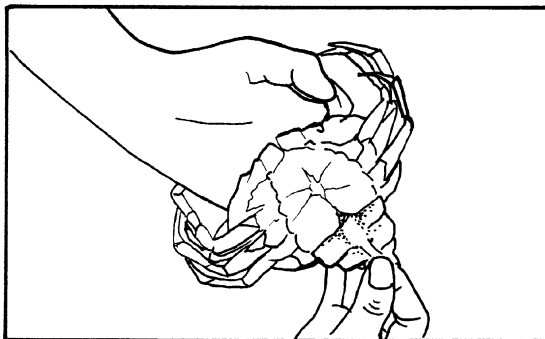
**3**

Turn crab over and lift one side of top shell.

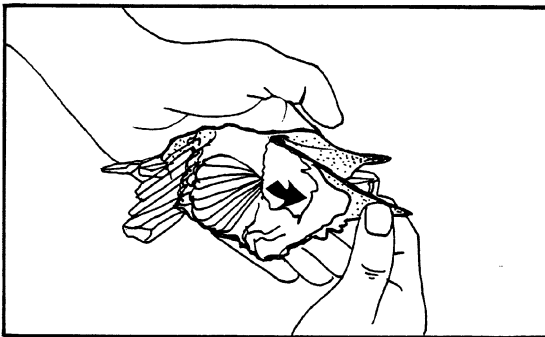
**4**

With a small knife, scrape off grayish-feathery gills. Repeat procedure on other side.

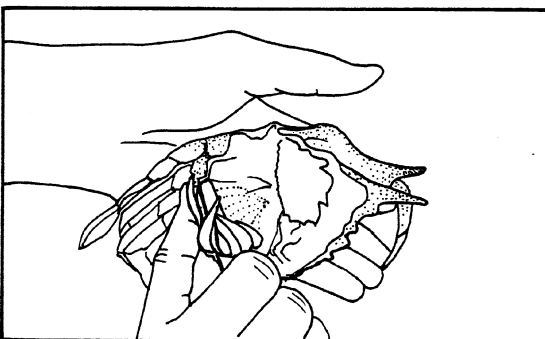

1

Hold crab in one hand. Turn crab over and stab straight down at point of apron with a knife.

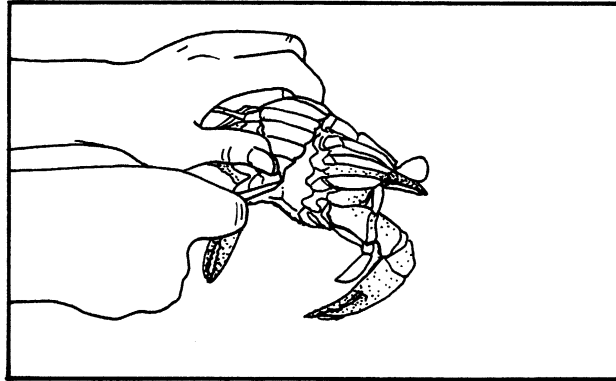

2

Make two cuts from this point to form a V-pattern that will remove mouth.

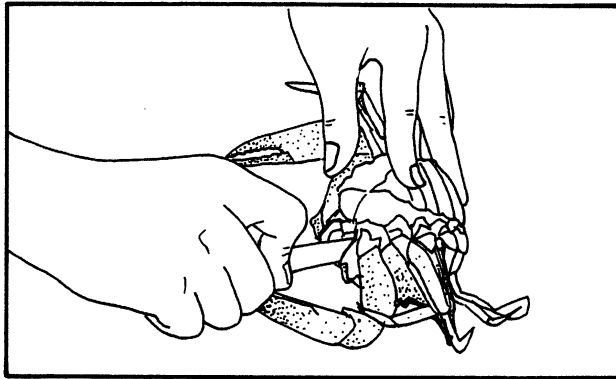

3

Do not remove knife after making second cut. Firmly press crab shell to cutting surface without breaking back shell. With other hand, grasp crab by legs and claws on the side where you are holding knife, and pull up. This should pull crab body free from back shell.

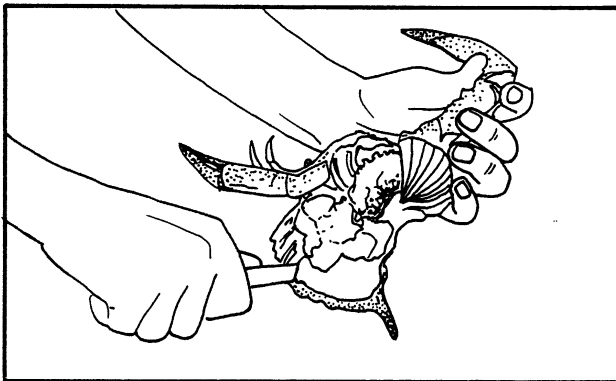

4

Remove gray, feathery gills, which are attached just above legs. Cut and scrape upward to remove gills.

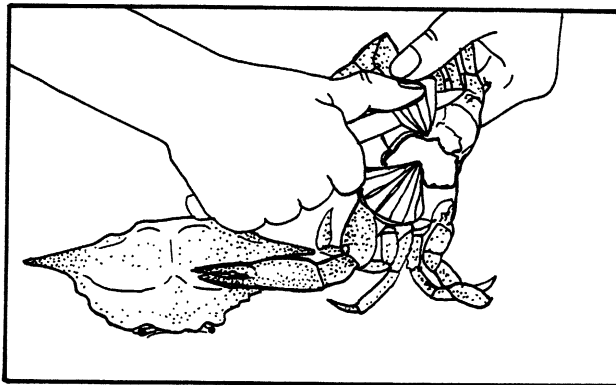

5

Remove all loose material—viscera and eggs—from body cavity.

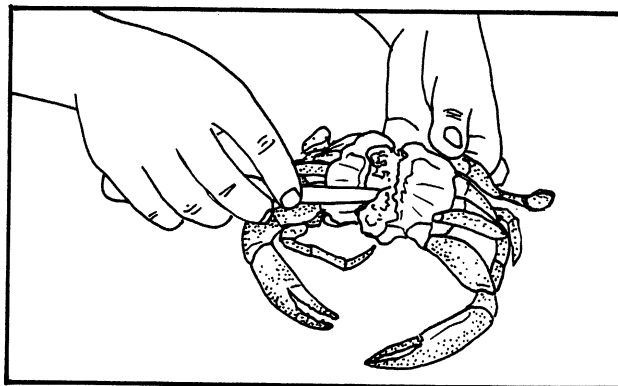

6

If apron did not come loose with shell, remove it.

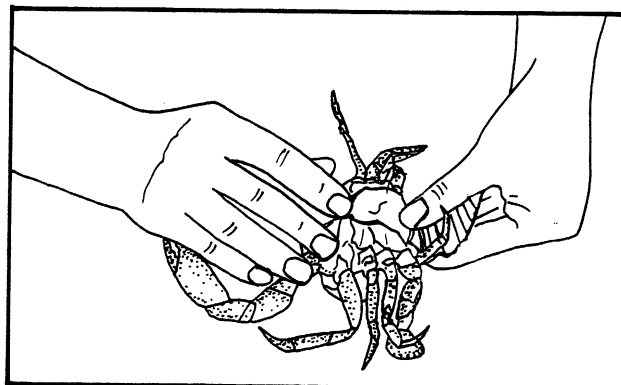

1

Oyster shells are especially sharp; be sure to wear gloves to protect your hands. Chip off a small piece of shell from the thin lip of the oyster until there is a small opening.

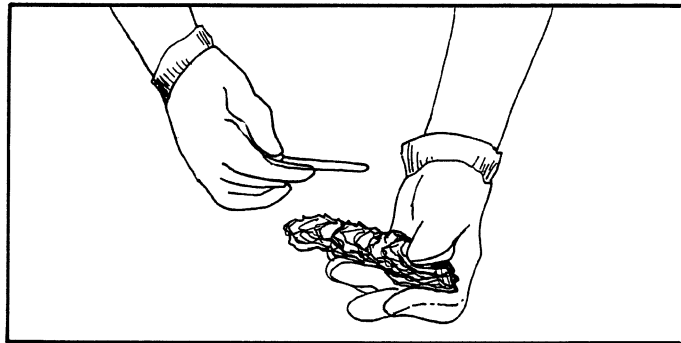
**2**

Insert knife blade into the opening and cut muscle free from top and bottom shells.

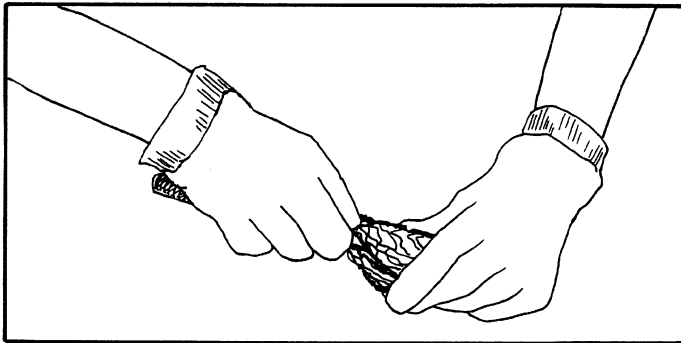
**3**

Remove oyster meat from the shell.

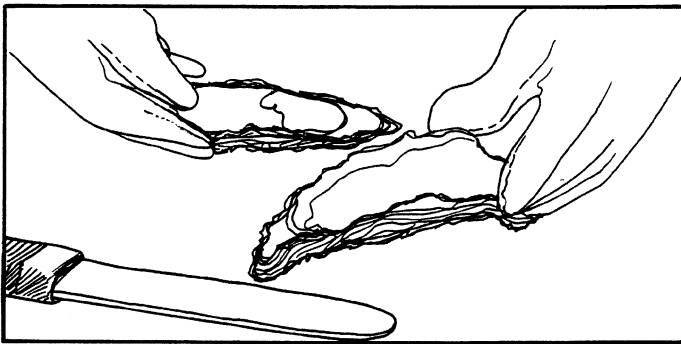

1

In the back of clam near the hinge is a black ligament. Toward the front where ligament ends is a weak spot. Insert your knife at this spot.

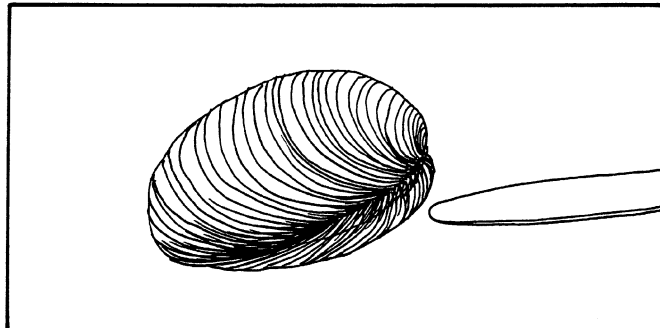
**2**

Inside are two muscles. Run the knife around the shell to sever both muscles.

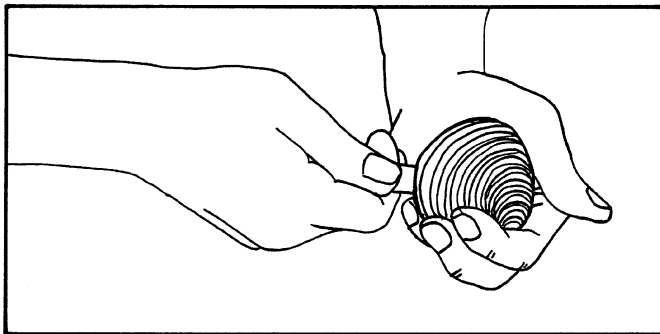
**3**

Now insert the knife blade into the front of the shell and separate the two shells.

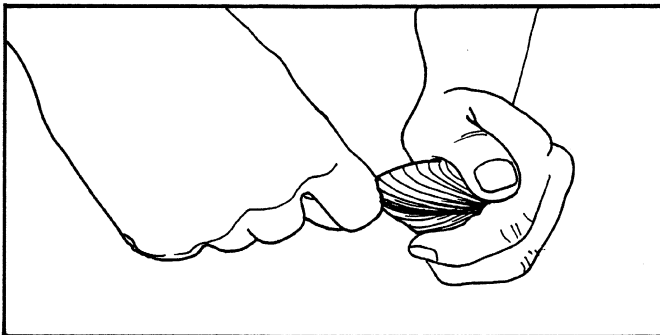
**4**

Scrape the meat free from the top and bottom shell.

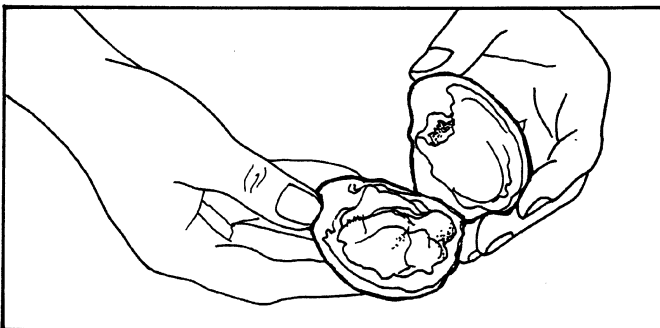

APPENDIX M

SOURCES OF REFERENCE MATERIALS AND STANDARDS

APPENDIX M

SOURCES OF REFERENCE MATERIALS AND STANDARDS

M.1 SOURCES OF REFERENCE MATERIALS

Analytical reference materials for priority pollutants and related compounds are currently produced for: organic quality control samples; organic solution standards; organic neat standards; inorganic quality control standards; and solid matrix quality control standards as listed below.

Note: Mention of trade names or commercial products does not constitute endorsement or recommendation for use. Identification of retailers of these products does not constitute their endorsement.

M.2 RETAILERS OF ORGANIC QUALITY CONTROL SAMPLES

Accustandard
125 Market Street
New Haven, CT 06513
Tel: 203-786-5290
FAX: 203-786-5287
Contact: Mike Bolgar

Aldrich Chemical Company, Inc.
940 West Saint Paul Avenue
Milwaukee, WI 53233
Tel: 414-273-3850
FAX: 800-962-9591

Analytical Products Group
2730 Washington Boulevard
Belpre, OH 45714
Tel: 704-423-4200
FAX: 704-423-5588
1-800-272-4442
Contact: Tom Coyner/
Melissa McNamara

Crescent Chemical Corporation
1324 Motor Parkway
Hauppauge, NY 11788
Tel: 516-348-0333

FAX: 516-348-0913
Contact: Fran Seiss

Environmental Research Associates
5540 Marshall Street
Arvada, CO 80002
Tel: 303-431-8454
FAX: 303-421-0159
Contact: Mark Carter

NSI Environmental Solutions, Inc.
P. O. Box 12313
2 Triangle Drive
Research Triangle Park, NC 27709
Tel: 1-800-234-7837 or
1-919-549-8980
FAX: 1-919-544-0334

Restek Corporation
110 Benner Circle
Bellefonte, PA 16823
Tel: 814-353-1300
FAX: 814-353-1309
Contact: Eric Steindle

Supelco
Supelco Park
Bellefonte, PA 16823-0048
Tel: 800-247-6628 or
814-359-3441
FAX: 814-359-3044

Ultra Scientific
250 Smith Street
North Kingstown, RI 02852
Tel: 401-294-9400
FAX: 401-295-2330

M.3 RETAILERS OF ORGANIC SOLUTION STANDARDS

Absolute Standards, Inc.
P.O. Box 5585
Hamden, NJ 06518-0585
Tel: 800-368-1131
FAX: 800-410-2577
Contact: Jack Criscio

NSI Environmental Solutions, Inc.
P.O. Box 12313
2 Triangle Drive
Research Triangle Park, NC 27709
Tel: 800-234-7837 or 919-549-8980
FAX: 919-544-0334
Contact: Zora Bunn

Accustandard
125 Market St.
New Haven, CT 06513
Tel: 203-786-5290
FAX: 203-786-5287
Contact: Mike Bolgar

Research Technology Corporation
2931 Soldier Springs Road
P. O. Box 1346
Laramie, WY 82070
Tel: 307-742-6343
FAX: 307-745-7936
Contact: Robert Rucinski

Alameda Chemical and Scientific
922 East Southern Pacific Drive
Phoenix, AZ 85034
Tel: 602-256-7044
FAX: 602-256-6566
Contact: Jim Stauffer

Cambridge Isotope Laboratories
50 Frontage Road
Andover, MA 01801-5413
Tel: 800-322-1174 or
978-749-8000
FAX: 978-749-2768
Contact: Jim Grim

M.4 RETAILERS OF NEAT ORGANIC STANDARDS

Accustandard
125 Market St.
New Haven, CT 06513
Tel: 203-786-5290
FAX: 203-786-5287
Contact: Mike Bolgar

NSI Environmental Solutions, Inc.
P. O. Box 12313
2 Triangle Drive
Research Triangle Park, NC 27709
Tel: 1-800-234-7837 or
1-919-549-8980
FAX: 1-919-544-0334

M.5 RETAILERS OF INORGANIC QUALITY CONTROL SAMPLES

SPEX Industries, Inc.
203 Norcross Ave.
Metuchen, NJ 08840
Tel: 732-549-7144 or
1-800-522-7739
FAX: 732-603-9647

NSI Environmental Solutions, Inc.
P. O. Box 12313
2 Triangle Drive
Research Triangle Park, NC 27709
Tel: 1-800-234-7837 or
1-919-549-8980
FAX: 1-919-544-0334

M.6 RETAILERS OF SOLID MATRIX QUALITY CONTROL SAMPLES

Fisher Scientific
711 Forbes Avenue (Corporate
address)
Pittsburgh, PA 15219
Tel: 1-800-227-6701
FAX: 1-800-926-1166

NSI Environmental Solutions, Inc.
P. O. Box 12313
2 Triangle Drive
Research Triangle Park, NC 27709
Tel: 1-800-234-7837 or
1-919-549-8980
FAX: 1-919-544-0334

M.7 RECOMMENDED PUBLICATIONS ON CERTIFIED STANDARDS AND REFERENCE MATERIALS

- **Standard and Reference Materials for Marine Science (NOAA, 1992). Available from**

Dr. Adrianna Cantillo
National Ocean Service
National Oceanic and Atmospheric Administration
U.S. Department of Commerce
1305 East West Highway
Silver Spring, MD 20910

This catalog lists approximately 2,000 reference materials from 16 producers and includes information on their use, sources, matrix type, analyte concentrations, proper use, availability, and costs. Reference materials are categorized as follows: ashes, gases, instrumental performance, oils, physical properties, rocks, sediments, sludges, tissues, and waters. This catalog has been published independently by both NOAA and IOC/UNEP and is available in electronic form from the Office of Ocean Resources, Conservation, and Assessment, NOAA/NOS.

- **Biological and Environmental Reference Materials for Trace Elements, Nuclides and Organic Microcontaminants (Toro et al., 1990). Available from**

Dr. R.M. Parr
Section of Nutritional and Health-Related Environmental Studies
International Atomic Energy Agency
P.O. Box 100
A-1400 Vienna, Austria

This report contains approximately 2,700 analyte values for 117 analytes in 116 biological and 77 nonbiological environmental reference materials from more than 20 sources. Additional information on cost, sample size available, and minimum amount of material recommended for analysis is also provided.

M.8 REFERENCES

- NOAA (National Oceanic and Atmospheric Administration). 1992. *Standard and Reference Materials for Marine Science*. Third Edition. U.S. Department of Commerce, Rockville, MD.
- Toro, E. C., R. M. Parr, and S. A. Clements. 1990. *Biological and Environmental Reference Materials for Trace Elements, Nuclides and Organic Microcontaminants: A Survey*. IAEA/RL/128(Rev. 1). International Atomic Energy Agency, Vienna, Austria.

APPENDIX N

STATISTICAL METHODS FOR COMPARING SAMPLES: SPATIAL AND TEMPORAL CONSIDERATIONS

APPENDIX N

STATISTICAL METHODS FOR COMPARING SAMPLES: SPATIAL AND TEMPORAL CONSIDERATIONS

The primary objective of Tier 2 intensive studies is to assess the magnitude and geographic extent of contamination in selected target species by determining whether the mean contaminant concentration exceeds the screening value (SV) for any target analyte. Secondary objectives of intensive studies may include defining the geographical region where fish contaminant concentrations exceed screening values (SVs), identifying geographic distribution of contaminant concentrations, and, in conjunction with historical or future data collection, assessing changes in fish contaminant concentrations over time. This appendix discusses some of the statistical methods that may be used to compare fish contaminant levels measured at different locations or over time.

The recommended statistical approach for comparing replicated contaminant measurements between two or more groups is outlined below and in Figure N-1. For each type of test, several options are provided, each of which may be appropriate in specific cases. State staff should consult a statistician as to the specific statistical tests to use for a particular data set.

Statistical tests of significant differences between means (or other measures of central tendency) can be divided into parametric and nonparametric types. Parametric tests assume that the contaminant concentrations in the population being sampled are normally distributed and that the population variances in the groups being tested are not significantly different from each other (Gilbert, 1987). If either of these assumptions is violated, a nonparametric test may be more appropriate. However, nonparametric tests should be used only when necessary because the power of parametric tests generally is greater than the power of nonparametric tests when the assumptions of the parametric test have been met (Sokal and Rohlf, 1981).

Because the populations of many environmental measurements are not normally distributed, logarithmic transformation is often performed on the sampled data (Gilbert, 1987). However, transformation may not be appropriate in all cases. If the data are sampled from a population that is normally distributed, then there is no need for transformation (Figure N-1).

If the assumptions of normality and equality of variance are met, parametric tests of significant differences between means, such as the one-way Analysis of

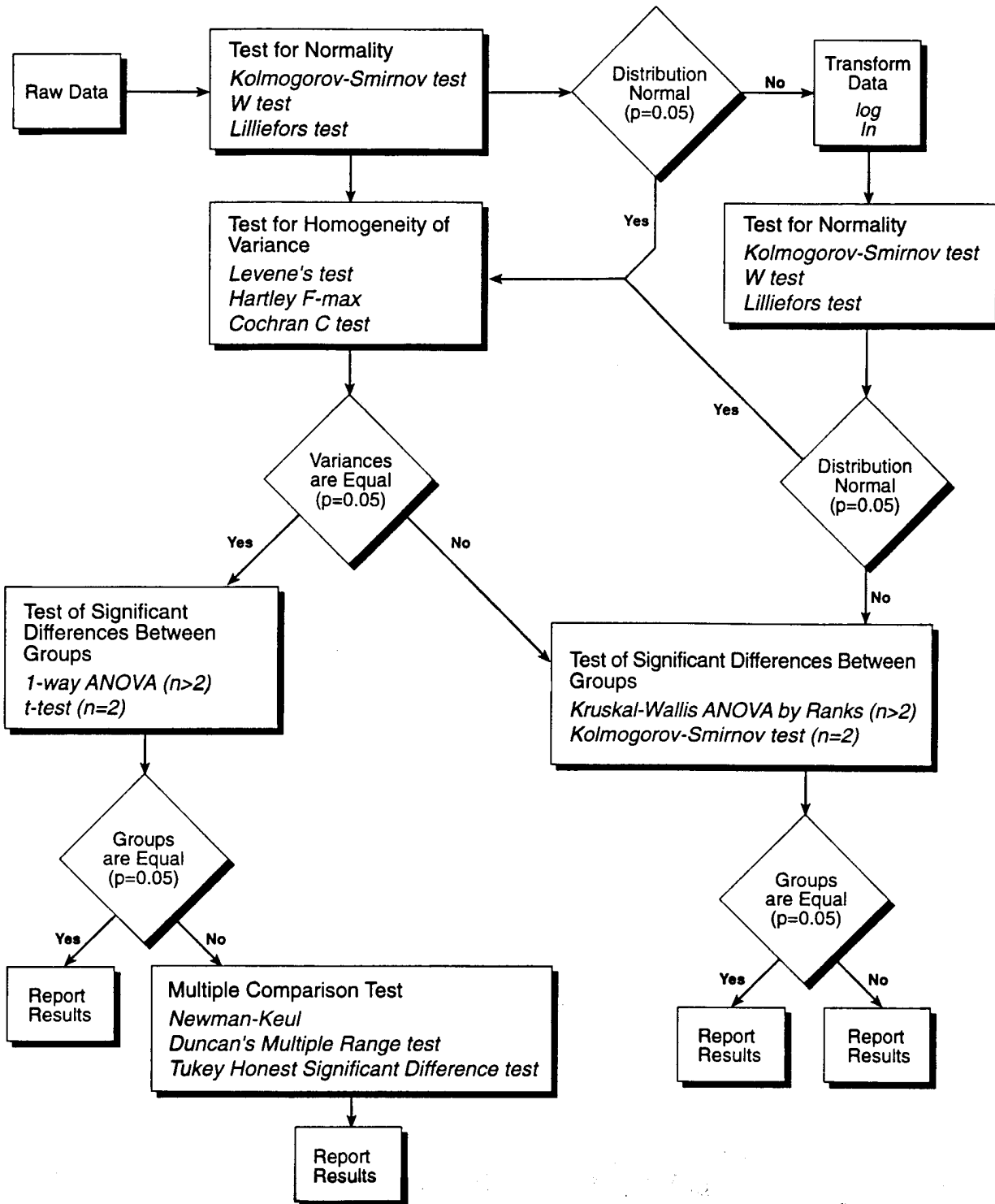

Figure N-1. Statistical approach to testing for significant differences between different groups of contaminant monitoring data.

Variance (ANOVA) and the *t*-test, should be performed. If three or more groups are compared using the ANOVA that results in a significant difference, the difference in mean concentrations between two group means can be further investigated using a multiple comparison test (Figure N-1). These tests indicate which specific means are significantly different from each other, rather than just indicating that one or more means are different, as the ANOVA does.

If the underlying assumptions for parametric testing are not met, nonparametric tests of significance can be employed. Nonparametric tests of significant differences in central tendencies are often performed on transformed data, that is, the ranks. Multiple comparison tests comparable to those used for parametric data sets are not available for nonparametric data sets. For data sets including three or more groups, a series of two-sample tests can be performed that can yield similar information to that derived from multiple comparison tests.

Because the concentrations of contaminants, particularly nonpolar organics, are often correlated with the percentage of lipid in a tissue sample (see Section 8.1.2), contaminant data are often normalized to the lipid concentration before statistical analyses are performed. This procedure can, in some instances, improve the power of the statistical tests. States wishing to examine the relationship between contaminant concentrations and percentage of lipid should refer to Hebert and Keenleyside (1995) for a discussion of the possible statistical approaches.

Intensive studies may include the collection of fish contaminant data from several locations within a region of interest or for multiple time periods (e.g., seasons or years) from a single location, or a combination of both. Data from intensive studies such as these may be used to perform spatial (i.e., between stations) or temporal (i.e., over time) analyses. It should be noted that these types of analyses, if performed, are performed in addition to the statistical comparisons of mean target analyte concentrations with SVs described in Section 6.1.2.7. It is only the latter type of comparison that should be used to make decisions regarding the necessity of performing risk assessments and the issuance of fish consumption advisories. Spatial and temporal comparisons of contaminant data, however, may yield important information about the variability of target analyte concentrations in specific populations of a particular target species.

N.1 SPATIAL COMPARISON OF STATIONS

Intensive studies also may involve the collection of contaminant data from multiple stations within a waterbody of interest. The stations could be located in different lakes within a single drainage basin, upstream and downstream of a point source of concern along a single river, or randomly located within a single waterbody if an estimate of random spatial variability is desired. The use of an example will serve to illustrate how a spatial analysis of contaminant data might be performed. In this example, a state has determined from a screening study on a river that cadmium is present in a target species at 20 ppm, which is two times the state selected SV of 10 ppm. An intensive survey was undertaken in which eight

Table N-1. Hypothetical Cadmium Concentrations (ppm) in Target Species A at Three River Locations

Replicate samples	Station 1	Station 2	Station 3
1	20	28	33
2	18	27	30
3	25	34	30
4	22	28	28
5	21	30	20
6	22	29	39
7	23	30	31
8	21	29	30
Mean	21.5	29.4	31.3
Standard deviation	2.07	2.13	3.45
p-Value for <i>t</i> -test with SV	<0.001	<0.001	<0.001
p-Value for W test	0.97	0.83	0.78
p-Value for Levene's test		0.52	
p-Value for ANOVA		<0.0001	
p-Value for Duncan's-1 vs. 2		<0.0001	
p-Value for Duncan's-1 vs. 3		>0.0001	
p-Value for Duncan's-2 vs. 3		0.17	

samples were collected from three locations on the river of potential concern and analyzed for cadmium. The results of the analyses for each location and the statistical comparisons between the three groups are presented in Table N-1.

The mean cadmium concentration at each of three locations was more than twice the selected SV of 10 ppm (Table N-1). The most important statistical test, as indicated in Section 6.1.2.7, is a comparison of the mean target analyte concentration for each location with the appropriate SV for that target analyte using a *t*-test. These tests must be performed before any analysis of spatial trends is performed. The results of the *t*-tests indicate that each of the three mean tissue concentrations is significantly greater than the SV (Table N-1). By itself, these results indicate that a risk assessment is warranted.

A general statistical flowchart for comparing contaminant concentration data from several stations is presented in Figure N-1. The cadmium data in Table N-1 may be additionally analyzed using the tests in Figure N-1. All of the statistical tests in Figure N-1 can be performed using commercial statistical software packages. By performing a spatial analysis of the data, the details of the risk assessment might be further refined. For example, one component of a fish advisory is often the establishment of risk-based consumption limits (see Volume 2 of this series). In order to calculate these limits, an estimate of the contaminant concentration in the target species must be available. In the example shown in Table N-1, there

are three estimates of cadmium concentration. A spatial analysis of these data can help to identify which of the concentrations (if any) to use in establishing risk-based consumption limits.

The initial steps in the flowchart on Figure N-1 are to determine whether parametric or nonparametric statistical tests should be used. The first step is to test whether each of the three groups of data are from populations that are normally distributed. Three tests that may be used for this purpose are the Kolmogorov-Smirnov test for normality (Massey, 1951), Shapiro and Wilk's W test (Shapiro et al., 1968; Royston, 1982), and Lilliefors' test (Lilliefors, 1967). The results for the W test on each of the three groups of data indicate that each group was sampled from populations that are normally distributed (Table N-1). The next step is to test for homogeneity of variances between the three groups. Three tests that may be used for this purpose are Levene's test (Milliken and Johnson, 1984), the Hartley F-max test (Sokal and Rohlf, 1981), and the Cochran C test (Winer, 1962). The result of Levene's test indicates that the variances of the three groups of data are not significantly different from each other (Table N-1). These test results mean that parametric statistics (the left side of Figure N-1) are appropriate for this dataset.

An appropriate parametric test to perform to determine whether the three mean cadmium concentrations are significantly different from each other is a 1-way ANOVA. The result of this test indicates that the three means are significantly different (Table N-1). What this result does not show, however, is whether each mean concentration is significantly different from both of the other mean concentrations. For this answer, multiple comparison tests can be used to perform all possible pairwise comparisons between each mean.

Three tests that can be used to perform a multiple comparison are the Newman-Keul test (Sokal and Rohlf, 1981), Duncan's Multiple Range test (Hays, 1988; Milliken and Johnson, 1984), and the Tukey Honest Significant Difference test (Hays, 1988; Milliken and Johnson, 1984). Three pairwise comparisons are possible between three means (1 vs. 2, 1 vs. 3, and 2 vs. 3). The results of Duncan's Multiple Range test indicate that the mean concentration at station 1 (21.5 ppm) is significantly lower than the mean concentrations at both station 2 (29.4 ppm) and station 3 (31.3 ppm), which in turn are not significantly different from each other. Therefore, to be most conservative (i.e., protective), the state could use the mean of the 16 replicate samples from stations 2 and 3 to calculate risk-based consumption limits. In this example, use of the concentration from any single station would not truly represent the potential contaminant exposure to fish consumers in the waterbody of concern.

N.2 TEMPORAL COMPARISON OF STATIONS

Both screening and intensive studies are often repeated over time to ensure that public health is adequately protected. By examining monitoring data from several time periods from a single site, it may be possible to detect trends in contaminant

concentrations in fish tissues. Trend analysis data should never be used to conduct risk assessments. Procedures for conducting risk assessments are adequately covered elsewhere in this document (see Section 6.1.2.7). Trend analysis may, however, be useful for monitoring the effects of various environmental changes or policies on the contaminant concentrations in the target species. For example, a state may have issued a fish advisory for a contaminant for which the source is known or suspected. Source control for this contaminant is the obvious solution to the environmental problem. An evaluation of the effectiveness of the source control may be made easier by trend analysis. The state would still need to perform statistical calculations comparing data from each sampling site to the selected SV, but trend analysis could yield valuable information about the success of remediation efforts even if the fish advisory remained in place because of SV exceedances.

Trend analysis can be performed using the statistical framework outlined in Figure N-1, but complexities in pollution data collected over time may make this approach unsuitable in some instances. The types of complexities for which other statistical approaches might be warranted can be divided into four groups: (1) changes in sampling and/or analysis procedures, (2) seasonality, and (3) correlated data (Gilbert, 1987). Each of these subjects is discussed briefly here.

Changes in the designation of an analytical laboratory to perform analyses or changes in sampling and/or analytical procedures are not uncommon in long-term monitoring programs. These changes may result in shifts in the mean or variance of the measured values, which could be incorrectly attributed to natural or manmade changes in the processes generating the pollution (Gilbert, 1987). Ideally, when changes occur in the methods used by the monitoring program, comparative studies should be performed to estimate the magnitude of these changes.

Seasonality may introduce variability that masks any underlying long-term trend. Statistically, this problem can be alleviated by removing the cycle before applying tests or by using tests unaffected by cycles (Gilbert, 1987). Such tests will not be discussed here. States interested in performing temporal analyses with data for which a seasonal effect is hypothesized should consult the nonparametric test developed by Sen (1968) or the seasonal Kendall test (Hirsch et al., 1982).

Measurements of contaminant concentrations taken over relatively short periods of time are likely to be positively correlated. Most statistical tests, however, including those in Figure N-1, require uncorrelated data. Gilbert (1987) discusses several methods for performing the required analyses in these cases.

Temporal trends in contaminant concentrations may be detected by regression analyses, whereby the hypothesis is tested that concentrations are not changing in a predictable fashion (usually linear) over time. If the hypothesis is rejected, a trend may be inferred. States interested in performing regression analyses should

consult statistics textbooks such as Gilbert (1987) or Snedecor and Cochran (1980).

N.3 REFERENCES

- Gilbert, R.O. 1987. *Statistical Methods for Environmental Pollution Monitoring*. Van Nostrand Reinhold Company, New York, NY. 320 pp.
- Hays, W.L. 1988. *Statistics*. Fourth Edition. CBS College Publishing, New York, NY.
- Hebert, C.E. and K.A. Keenleyside. 1995. To normalize or not to normalize? Fat is the question. *Environmental Toxicology and Chemistry* 14(5):801-807.
- Hirsch, R.M., J.R. Slack, and R.A. Smith. 1982. Techniques of trend analysis for monthly water quality data. *Water Resources Research* 18:107-121.
- Lilliefors, H.W. 1967. The Kolmogorov-Smirnov test for normality with mean and variance unknown. *J. Amer. Stat. Assoc.* 62:399-402.
- Massey, F.J., Jr. 1951. The Kolmogorov-Smirnov test for goodness of fit. *J. Amer. Stat. Assoc.* 46:68-78.
- Milliken, G.A., and D.E. Johnson. 1984. *Analysis of Messy Data: Volume 1. Designed Experiments*. Van Nostrand Reinhold Company, New York, NY.
- Royston, J.P. 1982. An extension of Shapiro and Wilk's W test for normality to large samples. *Applied Statistics* 31:115-124.
- Sen, P.K. 1968. On a class of aligned rank order tests in two-way layouts. *Annals of Mathematical Statistics* 39:1115-1124.
- Shapiro, S.S., M.B. Wilk, and H.J. Chen. 1968. A comparative study of various tests of normality. *J. Amer. Stat. Assoc.* 63:1343-1372.
- Snedecor, G.W., and W.G. Cochran. 1980. *Statistical Methods*. 7th edition. Iowa State University Press, Ames, IA.
- Sokal, R.R., and F.J. Rohlf. 1981. *Biometry. The Principles and Practice of Statistics in Biological Research*. Second Edition. W.H. Freeman and Company, New York, NY. 859 pp.
- Winer, B.J. 1962. *Statistical Principles in Experimental Design*. McGraw-Hill, New York, NY.

Annex X:

References

Annex X: References

Annex I: Indicative Tables of most consumed species of fish and seafood for different (sub) regions. JRC Technical Report 2010.

Bustamante P, Caurant F, Fowler SW, Miramand P. Cephalopods as a vector for the transfer of cadmium to top marine predators in the north-east Atlantic Ocean. *Sci. Total Environ.* 1998; 220: 71–80.

Commission Regulation (EU) No 835/2011 amending Regulation (EC) No 1881/2006 as regards maximum levels for polycyclic aromatic hydrocarbons in foodstuffs.

Commission Regulation (EU) No 836/2011 amending Regulation (EC) No 333/2006 laying down the methods of sampling and analysis for the official control of the levels of lead, cadmium, mercury, inorganic tin, 3-MCPD and benzo(a)pyrene in foodstuffs

EC (2010). Guidance Document No: 25 Guidance on chemical monitoring of sediment and biota under the Water Framework Directive

EU Commission Regulation (EC) No 333/2007, laying down the methods of sampling and analysis for the official control of the levels of lead, cadmium, mercury, inorganic tin, 3-MCPD and benzo(a)pyrene in foodstuffs

EU Commission Regulation (EC) No 644/2017), laying down methods of sampling and analysis for the official control of levels of dioxins and dioxin-like PCBs in certain foodstuffs

EU Commission Regulation (EC) No 836/2011 amending (EC) No 333/2007 laying down the methods of sampling and analysis for the official control of the levels of lead, cadmium, mercury, inorganic tin, 3-MCPD and benzo(a)pyrene in foodstuffs

EU Commission Regulation (EC) No 1881/2006, setting maximum levels for certain contaminants in seafood (Annex II)

ICES/OSPAR (2018). CEMP Guidelines for Monitoring Contaminants in Biota. Technical Annexes: 1) organic contaminants; 2) metals; 3) parent and alkylated PAHs; 8) chlorobiphenyls

JRC (2010). Marine Strategy Framework Directive. Technical Report of Task Group 9: Contaminants in fish and other seafood

UNEP/FAO/IOC/IAEA (1987). Reference methods No 6 (Rev. 1): Guidelines for monitoring chemical contaminants in marine organisms.

UNEP/FAO/IOC/IAEA (1988). Reference methods No 7 (Rev. 2): Sampling of selected marine organisms and sample preparation for trace metal analysis

UNEP/MAP (2019a). UNEP/MED WG.467/5. IMAP Guidance Factsheets: Update for Common Indicators 13, 14, 17, 18, 20 and 21: New proposal for candidate indicators 26 and 27;

UNEP (2019b). UNEP/MED WG.463/6. Monitoring Protocols for IMAP Common Indicators related to pollution;

UNEP (2019b) UNEP/MED WG.467/8. Data Standards and Data Dictionaries for Common Indicators related to pollution and marine litter.

US EPA (2000). Guidance for Assessing Chemical Contaminant Data for Use in Fish Advisories Volume 1 Fish Sampling and Analysis. Third Edition (Annex VIII)

Appendix 26

**Monitoring Guidelines/Protocols for Sample Preparation and Analysis of Sea Food for IMAP
Common Indicator 20: Heavy and Trace Elements and Organic Contaminants**

1. Introduction

2. Maximum permissible levels for certain contaminants in foodstuffs (including seafood) have been set by FAO/WHO (Codex Alimentarius⁴⁶⁷) and European Commission Regulations (EU Commission Regulations (EC) No 1881/2006⁴⁶⁸ (Annex I), (EC) No 835/2011⁴⁶⁹ (Annex II) and EC No 1259/2011⁴⁷⁰ (Annex IV). According to these regulations, maximum permissible concentrations in seafood are set for Cadmium (Cd), Lead (Pb), Mercury (Hg), four PAHs (benzo(a)pyrene, benz(a)anthracene, benzo(b)fluoranthene and chrysene), dioxins (including furans), dioxin-like PCBs and non-dioxin-like PCBs.

3. According to IMAP Guidance Fact Sheets (UNEP/MAP 2019⁴⁷¹) the list of contaminants recommended for monitoring under IMAP Common Indicator 20 (CI20) includes Cd, Pb, Hg, the four PAHs and non-dioxin-like PCBs, while dioxins and dioxin-like PCBs are not yet included in the IMAP list of mandatory contaminants.

4. Regarding heavy metals, the regulated metals for seafood monitoring in the framework of CI20 (Cd, Pb and Hg) are the same as the mandatory metals for marine biota monitoring in the framework of CI17. Therefore, the analytical methods for the determination of metals in seafood tissues (fish muscle, bivalves' whole body, crustaceans flesh and cephalopods flesh) are identical with the relevant analytical Protocols presented in the CI17.

5. Regarding regulated organic contaminants, PAHs (Benzo(a)pyrene, benz(a)anthracene, benzo(b)fluoranthene and chrysene), and non-dioxin-like PCBs (PCB 28, PCB 52, PCB 101, PCB 138, PCB 153 and PCB 180) are included in the lists of both regulated contaminants for CI20 and mandatory contaminant for CI17 (biota). Therefore, the analytical methods for their determination in seafood are identical with the relevant analytical Protocols presented in the CI17.

6. The other EC regulated contaminants (dioxins and dioxin-like PCBs) are not included in the CI17 mandatory contaminants and they require specialized accredited laboratories with appropriate analytical equipment (such as GC-HRMS). Methods for the analysis of dioxins and dioxin-like PCBs are presented here-below in the Protocol for the analysis of dioxins and dioxin-like PCBs using GC-HRMS. The Contracting Parties to the Barcelona Convention may decide to include the analysis of additional, non-regulated heavy metals and organic contaminants in their national monitoring programmes for CI20, although no maximum permissible levels for consumption have been defined yet. Due to the lack of relevant maximum permissible values for the non-regulated contaminants, no adequate Reporting can be provided for these additional contaminants.

7. The Protocols prepared in the framework of Monitoring Guidance for Sample Preparation and Analysis of Sea Food for IMAP Common Indicator 20, as provided here-below, describe appropriate methodologies for the analysis of seafood samples for the determination of heavy metals and organic contaminants, in order to ensure quality assured data. They are not intended to be analytical training manuals, but guidelines for Mediterranean laboratories, which should be tested and modified in order to validate their final results.

⁴⁶⁷ Codex Alimentarius (FAO/WHO) : <http://www.fao.org/fao-who-codexalimentarius>

⁴⁶⁸ EU Commission Regulation (EC) No 1881/2006, setting maximum levels for certain contaminants in seafood (Annex I)

⁴⁶⁹ Commission Regulation (EU) No 835/2011 amending Regulation (EC) No 1881/2006 as regards maximum levels for polycyclic aromatic hydrocarbons in foodstuffs.

⁴⁷⁰ EU Commission Regulation (EC) No 1259/2011, amending Regulation (EC) No 1881/2006 as regards maximum levels for dioxins, dioxin-like PCBs and non-dioxin-like PCBs in foodstuffs (Annex IV);

⁴⁷¹ UNEP (2019). UNEP/MED WG.467/5. IMAP Guidance Factsheets: Update for Common Indicators 13, 14, 17, 18, 20 and 21: New proposal for candidate indicators 26 and 27;

8. These Protocols aim at streamlining sample preparation and analysis of marine biota samples in view of assuring comparable quality assurance of the data, as well as comparability between sampling areas and different national monitoring programmes, by providing a step-by-step guidance on the methods to be applied in the Mediterranean.

9. In order to avoid unnecessary repetitions, reference is also made to the protocols already published and publicly accessible, which can also be used by the Contracting Parties' competent laboratories participating in IMAP implementation. Regarding the analysis of heavy metals, here-below elaborated IMAP Protocols build on relevant guidelines developed by UNEP/IAEA (Annex VI: IAEA (2011a). Recommended method on microwave digestion of marine samples for the determination of trace element content; Annex VII: Recommended method for the determination of selected trace element in samples of marine origin by flame atomic absorption spectrometry; Annex VIII: Recommended method for the determination of selected trace element in samples of marine origin by atomic absorption spectrometry using graphite furnace; Annex XI: Recommended method on the determination of Total Mercury in marine samples by thermal decomposition, amalgamation and Atomic Absorption Spectrophotometry; and Annex XII: Recommended method on the determination of Total Hg in samples of marine origin by Cold Vapour Atomic Absorption Spectrometry), HELCOM (COMBINE programme) (Annex IX: Technical note on the determination of trace metallic elements in biota; Annex XIII: Technical note on the determination of Total Mercury in marine biota by Cold Vapour Atomic Absorption Spectroscopy) and the US EPA (Annex X: US-EPA Method 200.8: Determination of trace elements in waters and wastes by inductively coupled plasma-mass spectrometry). For organic contaminants analysis, here-below elaborated IMAP Protocols build on relevant guidelines developed by UNEP/IAEA (Annex XIV: Reference Methods for Marine Pollution Studies No 71 for the analysis of selected chlorinated hydrocarbons in the marine environment;); HELCOM (Annex XV: COMBINE programme, Technical note on the determination of chlorinated biphenyls and organochlorine pesticides in biota; Annex XVI: COMBINE programme, Technical Note on the determination of Polycyclic Aromatic Hydrocarbons in Biota); ICES/OSPAR (Annex XVII: CEMP Guidelines for monitoring contaminants in biota and sediments) and the US EPA (Annex XVIII: US EPA Method 1613, Tetra- through octachlorinated dioxins and furans by isotope dilution HRGC/HRMS; Annex XIX: US EPA Method 1668, Chlorinated biphenyl congeners in water, soil, sediment, and tissue by HRGC/HRMS). Given the suitability of any of these Guidelines in the context of IMAP, they could be further used by interested IMAP competent Mediterranean laboratories for developing their laboratory specific sampling and sample processing methodologies. The Contracting Parties' laboratories should accommodate and always test and modify each step of the procedures to validate their results.

10. The below flow diagram informs on the category of this Monitoring Guideline related to sample preparation and analysis of seafood for IMAP Common Indicator 20 within the structure of all Monitoring Guidelines prepared for IMAP Common Indicators 13, 14, 17, 18 and 20.

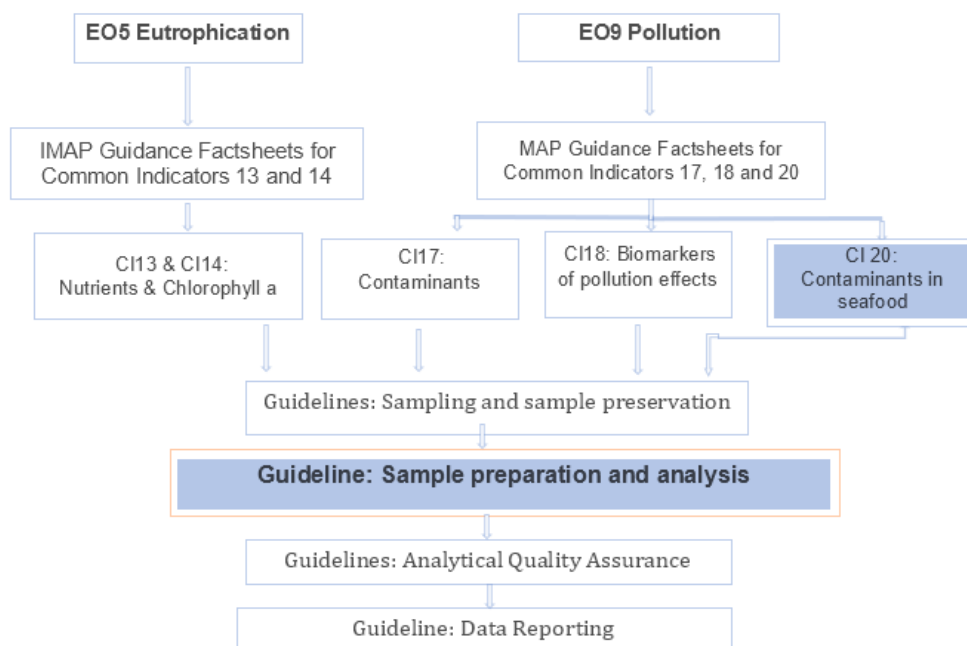

Flow Diagram: Monitoring Guidelines for IMAP Ecological Objectives 5 and 9

2. Technical Note for the analysis of seafood tissue samples for heavy metals

11. Regulated metals for seafood monitoring in the framework of CI20 are Cd, Pb and Hg. National laboratories may decide to use any validated analytical method they consider appropriate, which meets specific performance criteria (LOD, LOQ, precision, recovery and specificity – EU Regulation (EC) No 836/2011⁴⁷² (Annex III), amending Regulation (EC) 333/2007⁴⁷³). Details on specific requirements for analytical methods, regarding the use of the performance criteria and the “fitness for purpose” approach are also provide in the Regulations.

Performance criteria for methods of analysis for Pb, Cd and Hg as set in (EC) No 836/2011

Parameter	Criterion
Applicability	Foods specified in Regulation (EC) No 1881/2006
Specificity	Free from matrix or spectral interferences
Repeatability (RSD _r)	HORRAT _r less than 2*
Reproducibility (RSD _R)	HORRAT _R less than 2 *
Recovery	The provisions of point D.1.2. apply **

⁴⁷² EU Commission Regulation (EC) 836/2011 amending Commission Regulation (EC) No 333/2007, laying down the methods of sampling and analysis for the official control of the levels of lead, cadmium, mercury, inorganic tin, 3-MCPD and benzo(a)pyrene in foodstuffs

⁴⁷³ EU Commission Regulation (EC) No 333/2007, laying down the methods of sampling and analysis for the official control of the levels of lead, cadmium, mercury, inorganic tin, 3-MCPD and benzo(a)pyrene in foodstuffs

	Maximum Level is < 0.100 mg kg ⁻¹	Maximum Level is ≥ 0.100 mg kg ⁻¹
LOD	≤ one fifth of the ML	≤ one tenth of the ML
LOQ	≤ two fifths of the ML	≤ one fifth of the ML

* 'HORRAT_r' = the observed RSD_r divided by the RSD_r value estimated from the Horwitz equation using the assumption $r = 0,66R$. (M. Thompson, Analyst, 2000, 125, 385-386.)

'HORRAT_R' = the observed RSD_R value divided by the RSD_R value calculated from the Horwitz equation.

** D.1.2. Recovery calculations: The result may be reported uncorrected (for metals) if evidence is provided by ideally making use of suitable certified reference material that the certified concentration allowing for the measurement uncertainty is achieved (i.e. high accuracy of the measurement). In case the result is reported uncorrected this shall be mentioned.

12. In order to assist analytical laboratories of the Contracting Parties, IMAP Protocols have been prepared within this document in order to be used as guidelines for the analysis of heavy metals (Cd, Hg and Pb) in seafood samples. The IMAP Protocols are those proposed for marine biota analysis in the framework of CI17. Analytical laboratories should accommodate, test and modify each step of the procedures presented in the Protocols in order to validate their final results. The list of methods and analytical equipment is not exhaustive and laboratories are encouraged to use their own equipment/methods that consider adequate for the required analyses.

13. The analysis of heavy metals in marine biota samples developed for monitoring of CI17, that are also recommended for heavy metals in seafood sample for monitoring of CI 20, include: i) digestion of tissues and ii) analysis of the digested sample for heavy metals using different equipment. They are provided in the following IMAP Protocols:

- Protocol for seafood tissues digestion using nitric acid (microwave assisted digestion in closed systems and digestion on hot plate);
- Protocol for the analysis of heavy metals with Flame Atomic Absorption Spectroscopy (FAAS);
- Protocol for the analysis of heavy metals with Graphite Furnace Atomic Absorption Spectroscopy (GF-AAS);
- Protocol for the analysis of heavy metals with Inductive Coupled Plasma – Mass Spectroscopy (ICP-MS);
- Protocol for the analysis of Total Hg with thermal decomposition, amalgamation and AAS;
- Protocol for the analysis of Total Hg with Cold Vapour Atomic Absorption Spectrometry (CV-AAS).

14. These Protocols are based on Analytical Methods developed by IAEA (Annexes VI, VII, VIII, XI, XII), HELCOM (Annexes IX and XIII) and US EPA (Annex X).

15. Regardless of the analytical method used, heavy metal analyzes follow some procedures common to all analytical methodologies, such as the calibration of the analytical equipment and the cleaning and handling procedures to avoid the contamination of the samples from the laboratory's environment and the tools and containers used in the analysis.

a) Calibration

16. Calibration standards prepared from single standard stock solutions or multielement standards, by dilution of the stock solution using dilute acid, as required. All standard solutions have to be stored

in polyethylene, borosilicate or quartz volumetric flasks, depending on the best suitability for the respective analytes. Standard solutions with lower concentrations, if prepared correctly and controlled in a QA system (checking of old versus new, and checking with standards from a different source), can be kept for a period no longer than one month

17. The calibration procedure has to meet some basic criteria in order to give the best estimate of the true element concentration of the sample analyzed (HELCOM, 2012a⁴⁷⁴):

- i) The concentrations of standards for the preparation of the calibration curve should cover the range of anticipated concentrations;
- ii) The required analytical precision should be known and achievable throughout the entire range of concentrations;
- iii) The measured value at the lower end of the range has to be significantly different from the procedural analytical blank;
- iv) The chemical and physical properties of the calibration standards must closely resemble those of the sample under investigation;
- v) The analytical instruments should be recalibrated regularly (every 10-20 samples) to correct for instrumental drift and analytical efficiency.

b) Avoiding contamination

18. To avoid metal contamination in the laboratory all glassware and plastic vessels used should be carefully cleaned. The general cleaning guidelines include:

- i) The vessels are allowed to soak overnight in a plastic container in an alkaline surfactant solution (2% in tap or even better distilled water);
- ii) Vessels are rinsed thoroughly first with tap or even better distilled water then with ultrapure deionised water (18 MΩ cm, e.g. Milli-Q).
- iii) Vessels are left to stand in 10% (v/v) concentrated HNO₃ solution (analytical grade) at room temperature for at least 6 days
- iv) Vessels are rinsed thoroughly with ultrapure deionised water (e.g. Milli-Q) (at least 4 times).
- v) Vessels are allowed to dry under a laminar flow hood.
- vi) Vessels are stored in closed plastic polyethylene bags (e.g. zip-lock variety) to prevent the risk of contamination prior to use.

19. This procedure should be used for all plastic ware use in the laboratory as tips, cup for autosampler, plastic containers. Leave the vessels to stand in 10% (v/v) concentrated HNO₃ solution (analytical grade) at room temperature for at least 6 days

2.1 Protocol for biota tissues digestion using nitric acid

20. Biota tissues samples have to be digested (wet ashing) prior to analysis. The rate of digestion and the efficiency of acid decomposition increase substantially with elevated temperatures and pressure, therefore microwave digestion in closed vessels is the preferred method. However, in case no such equipment is available, sample digestion in open vessels over a hot plate is an alternative method. Biota samples can be digested in wet or dried condition, however regardless of the method applied, it is of paramount importance to secure the complete destruction of all organic material of the sample, as well as to avoid metals losses and the contamination of the sample (HELCOM, 2012a).

⁴⁷⁴ HELCOM (2012a). Manual for marine monitoring in the COMBINE programme. Annex B-12, Appendix 4: Technical note on the determination of trace metallic elements in biota

21. The existence of residual dissolved organic carbon compounds in the digested sample would change the viscosity of the solution and therefore may lead to erroneous results when calibration of the AAS instrument is made using aquatic calibration standard solutions. Also, in the GF-AAS, residual organic carbon may undergo secondary reactions with the analyte prior to or during the atomization process causing matrix interferences (Harms, 1985⁴⁷⁵).

a) Microwave acid digestion in closed systems (for heavy metals analysis with AAS, GFAAS and ICP-MS analysis)

22. Biota tissue digestion can be performed in Teflon, or equal quality vessels of pure material, which are metal free and resistant to strong acids, therefore loss of elements through volatilisation and contamination by desorption of impurities from the vessel surface are significantly reduced. Also, since only small quantities of high-purity nitric acid are used, extremely low analytical blanks can be obtained. Microwave systems enable a very fast energy transfer to the sample and a very rapid build-up of high internal vessel temperature and pressure, with the advantage of an enormous reduction in digestion time occurs (HELCOM, 2012a).

Digestion reagents for the analysis of Cd, Pb and other trace elements analysis

- i) HNO₃ (65%, Suprapur, Merck).
- ii) H₂O₂ (analytical grade) to be kept in the fridge after opening.
- iii) Milli-Q deionised water (> 18MΩ cm, Millipore).

According to the IAEA (2011a⁴⁷⁶) recommended method on microwave digestion of marine samples for the determination of trace element content (Annex VI) dried biota tissue samples (approximately 0.2. g) are weighted in the microwave vessel and placed in a laminar hood compatible with acid fume. Approximately 5 ml of nitric acid (HNO₃) are added and each vessel and let to react for at least 1 hour (or more if possible). After the room temperature pre-digestion, 2ml of hydrogen peroxide (H₂O₂) are added carefully, the vessels are closed and placed in the microwave apparatus and digestion steps are followed. *Digestion reagents for Mercury analysis*

- i) HNO₃ (65%, analytical grade, low in mercury).
- ii) Milli-Q deionised water (> 18MΩ cm).
- iii) 10% K₂Cr₂O₇ (w/v) solution (e.g. 10 g K₂C₂O₇ analytical grade diluted into 100 ml with Milli-Q water).

23. Dried biota tissue samples (approximately 0.2. to 1.5.g depending of the expected concentration) are weighted in the microwave vessel and placed in a laminar hood compatible with acid fume. If processing high weight of bivalve (> 1g), add 40 mg of V₂O₅ to each tube (including blanks). Add 5 ml of concentrated Nitric acid (HNO₃) and left to react for at least 1 hour. If large amount of sample is used more acid has to be added until the mixture becomes liquid. To control the performance of the digestion procedure, at least 2 blanks should be prepared in a similar manner as the samples for each batch of analysis. Also at least one Certified Reference Material should be used and prepared in duplicate for each digestion batch. These digestions are prepared in a similar manner as the samples. A reference material of similar composition and concentration range should be used. After digestion, the vessels are removed from the microwave apparatus and placed in a ventilated fume hood

⁴⁷⁵ Harms, U. 1985. Possibilities of improving the determination of extremely low lead concentrations in marine fish by graphite furnace atomic absorption spectrometry. Fresenius Journal of Analytical Chemistry, 322: 53-56.

⁴⁷⁶ IAEA (2011a). Recommended method on microwave digestion of marine samples for the determination of trace element content (IAEA/Marine Environmental Studies Laboratory in co-operation with UNEP/MAP MED POL)

to cool. When the pressure is adequate, the vessels are opened 1 ml of $K_2Cr_2O_7$ solution is added (final concentration should be 2% v/v) and their content is transferred to a volumetric flask, preferably of Teflon, but glass is also good, and made to a known volume. All reagents should be of analytical grade.

b) Acid digestion in open systems

24. In case no microwave digestion system is available, it is possible to perform a digestion over a programmable heating plate placed inside a specially designed fume hood, allowing acid treatment. However, for the complete destruction of the organic matter, large quantities of reagents and voluminous apparatus with large surfaces are usually needed and the method is subject to contamination problems (too high blank values) if insufficiently purified acids are used. Also the rate of reaction and efficiency of acid decomposition in open vessels is lower than in closed vessels under pressure. Therefore, digestion over a hot plate is not a recommended method and should be avoided if possible.

25. Dried biota tissue samples (approximately 0.2. g) are weighted in the microwave vessel and placed in a laminar flow hood compatible with acid fume. Approximately 5 ml of concentrated Nitric acid (HNO_3) are added to each vessel and left to react at room temperature for at least 1 hour. The tubes are closed and placed in an aluminum block on a hot plate at 90 °C for 3hrs. The samples are allowed to cool to room temperature, then the tubes are opened carefully and the samples are transferred in the labeled 50 ml polypropylene graduated tubes or volumetric flask. All reagents are of analytical grade.

26. A method for biota tissues digestion in open systems, using aqua regia, HNO_3 / $HClO_4$ can be found in Black et al, (2013⁴⁷⁷).

2.2 Protocol for the analysis of heavy metals with Flame AAS

27. Flame Atomic Absorption Spectroscopy (AAS) has adequate sensitivity for the determination of a wide range of metals in marine biota tissues. The sample solution is aspirated into a flame and atomized. In case of flame-AAS, a light beam is directed through the flame, into a monochromator, and onto a detector that measures the amount of light absorbed by the element in the flame. Each metal has its own characteristic wavelength so a source hollow cathode lamp composed of that element is used. The amount of energy absorbed at the characteristic wavelength is proportional to the concentration of the element in the sample.

28. A detailed analytical protocol for the analysis of heavy metals in biota tissue samples by flame atomic absorption spectrometry prepared by IAEA (2011b⁴⁷⁸) is presented in the Annex VII: Recommended method for the determination of selected trace element in samples of marine origin by flame atomic absorption spectrometry

2.3 Protocol for the analysis of heavy metals with GF-AAS

29. In marine biota tissues Cd, Pb, as well as other heavy metals, can be determined by Graphite Furnace Atomic Absorption Spectroscopy (GF-AAS), which has adequate sensitivity for these determinations. For GF-AAS analysis, after the digestion of the biota sample, an aliquot of sample solution (10-50 μ l) is introduced into a graphite tube of the GF-AAS and atomized by rapid heating at

⁴⁷⁷ Black, K., Kalantzi, I., Karakassis, I., Papageorgiou, N., Pergantis, S., Shimmield, T. (2013). Heavy metals, trace elements and sediment geochemistry at four Mediterranean fish farms, *Science of the Total Environment*. 444, 128–137.

⁴⁷⁸ IAEA (2011b⁴⁷⁸) Recommended method for the determination of selected trace element in samples of marine origin by flame atomic absorption spectrometry

high temperature. A light beam is directed through the graphite tube, into a monochromator, and onto a detector that measures the amount of light absorbed by the atomized element in the tube. Each metal has its own characteristic wavelength, so a source hollow cathode lamp composed of that element is used. The amount of energy absorbed at the characteristic wavelength is proportional to the concentration of the element in the sample.

30. The AAS software generally gives typical electrothermal programs for each element for 10 μl of sample in diluted HNO_3 (0.1%) and indications concerning maximum ashing and atomization temperatures. More specific information may also be found in the literature, such as recommendations regarding matrix modifiers and the use of partition tubes or tubes with platform. When a program is optimized for the determination of an element in a specific matrix, all information should be reported in the logbook of methods of the laboratory.

31. For some elements and some matrices, the results obtained are still not satisfactory (e.g. maximum ashing temperature is not sufficient to eliminate the background), this procedure should be redone with the addition of a matrix modifier. Different matrix modifiers could be tried before finding the best solution.

32. A detailed analytical protocol for the analysis of heavy metals in sediments by GF AAS prepared by IAEA (2011c⁴⁷⁹) is presented in the Annex VIII (Recommended method for the determination of selected trace element in samples of marine origin by atomic absorption spectrometry using graphite furnace).

33.

2.4 Protocol for the analysis of heavy metals with ICP-MS

34. Inductive Coupled Plasma – Mass Spectroscopy (ICP-MS) is currently state-of-the-art instrumentation for metal analysis, with the possibility to determine at sub- $\mu\text{g L}^{-1}$ concentrations of a large number of elements in acid digested biota tissue samples. ICP-MS allows a rapid simultaneous analysis of a wide range of heavy metals. Most routine instruments utilize a quadrupole mass spectrometer, so mass resolution is not high enough to avoid overlap of double charged elements or multi-element ions (mainly hydrides, oxides and hydroxides) formed in the plasma. The main concern is for the Ar interferences as the plasma is usually an argon plasma, overlapping with As. Some elements are prone to memory effects (particularly Hg) and needs extra precautions to avoid carry over effects. Modern ICP-MS instruments software includes all the tuning and correction formulas needed and described above to perform the analysis (HELCOM 2012a).

35. A multi-elemental determination of heavy metals by ICP-MS in water and solid samples after acid digestion, is described in the US EPA Method 200.8 (1994⁴⁸⁰). The method was initially intended for inorganic solid samples (soils and sediments) but can also be directly applied to organic samples. According to Enamorado-Baez et al. (2015⁴⁸¹), for biota tissues the digestion step could use only nitric acid (similar to the US-EPA 3051 method established for sediments, sludge, soils, and oils) but increasing the sample mass to acid volume ratio.

⁴⁷⁹ IAEA (2011c) Recommended method for the determination of selected trace element in samples of marine origin by atomic absorption spectrometry using graphite furnace

⁴⁸⁰ US EPA (1994) US-EPA Method 200.8: Determination of trace elements in waters and wastes by inductively coupled plasma-mass spectrometry

⁴⁸¹ Enamorado-Báez, S.M., Abril, JM and Gómez-Guzmán, JM (2013) Determination of 25 Trace Element Concentrations in Biological Reference Materials by ICP-MS following Different Microwave-Assisted Acid Digestion Methods Based on Scaling Masses of Digested Samples. Hindawi Publishing Corporation, ISRN Analytical Chemistry, Volume 2013, Article ID 851713, 14 pages. <http://dx.doi.org/10.1155/2013/851713>

36. Metal species originating in a liquid are nebulized and the resulting aerosol is transported by argon gas into the plasma torch. The ions produced by high temperatures are entrained in the plasma gas and introduced, by means of an interface, into a mass spectrometer. The ions produced in the plasma are sorted according to their mass-to-charge ratios and quantified with a channel electron multiplier. Interferences must be assessed and valid corrections applied. Interference correction must include compensation for background ions contributed by the plasma gas, reagents, and constituents of the sample matrix. The US EPA Method 200.8 is presented in Annex X.

2.5 Protocol for the analysis of Total Mercury in marine biota with by thermal decomposition, amalgamation and Atomic Absorption Spectrophotometry

37. Total mercury in the marine biota can be analysed by solid Hg analyser, which has adequate sensitivity for this determination. A detailed method describing the protocol for the determination of total mercury (inorganic and organic) in sediment prepared by IAEA (2012a⁴⁸²) (“Recommended method on the determination of Total Mercury in marine samples by thermal decomposition, amalgamation and Atomic Absorption Spectrophotometry” Annex VI). With this method, Total Hg is determined without any chemical pre-treatment of the sample, minimising possible contamination and/or additional errors due to sample handling. The method is based on the US EPA 7473 method (US EPA, 2007⁴⁸³).

38. The sample is dried and then chemically decomposed under oxygen in the decomposition furnace. The decomposition products are carried out to the catalytic section of the furnace, where oxidation is completed (halogens and nitrogen/sulfur oxides are trapped). The mercury present in the remaining decomposition products is selectively trapped on an amalgamator. After flushing the system with oxygen, the mercury vapour is released by rapid heating of the amalgamator, and carried through the absorbance cell in the light path of a single wavelength atomic absorption spectrophotometer. The absorbance is measured at 253.7 nm as a function of mercury quantity (ng). The typical working range is 0.1–500 ng. The mercury vapour is carried through a long (first) and a short path length absorbance cell. The same quantity of mercury is measured twice with different sensitivity resulting in a dynamic range that spans four orders of magnitude. The typical detection limit is 0.01 ng of mercury

2.6 Protocol for the analysis of Total Hg in samples of marine origin by CV-AAS

39. The method is widely used for the determination of total mercury in biological tissues and it is simple, rapid and applicable to a large number of environmental samples. The typical working range is 0.25–100 ng ml⁻¹ for direct injection of cold vapour, using “batch” system (IAEA, 2012b). Cold Vapor Atomic Absorption Spectrometry (CV-AAS) analysis can be performed manually using batch CV-AAS or automatically using flow injection (FIAS) techniques. FIAS is a very efficient approach for introducing and processing liquid samples in atomic absorption spectrometry, reduces sample and reagent consumption, and has a higher tolerance of interferences, lower determination limits and improved precision compared with conventional cold vapour techniques (HELCOM, 2012b⁴⁸⁴).

⁴⁸² IAEA (2012a) Recommended method on the determination of Total Hg in marine samples by Thermal Decomposition Amalgamation and Atomic Absorption Spectrometry

⁴⁸³ US EPA (2007). U.S. Environmental Protection Agency, EPA method 7473, Mercury in solids and solutions by thermal decomposition, amalgamation and atomic absorption spectrophotometry Rev 0.

<http://www.epa.gov/osw/hazard/testmethods/sw846/pdfs/7473.pdf>

⁴⁸⁴ HELCOM (2012b). COMBINE Annex B-12, Appendix 4, Attachment 1. Technical note on the determination of Total Mercury in marine biota by Cold Vapour Atomic Absorption Spectroscopy

40. The biota tissue samples are digested with strong acids and the inorganic mercury is reduced to its elemental form with stannous chloride. The cold mercury vapour is then passed through the quartz absorption cell of an atomic absorption spectrometer (AAS), where its concentration is measured.

41. In the CV-AAS method, the inorganic mercury is reduced to its elemental form with stannous chloride. The cold mercury vapor is then passed through the quartz absorption cell of an AAS instrument where its concentration is measured. The light beam of Hg hollow cathode lamp is directed through the quartz cell, into a monochromator and onto a detector that measures the amount of light absorbed by the atomized vapor in the cell. The amount of energy absorbed at the characteristic wavelength is proportional to the concentration of the element in the sample.

42. A recommended method describing the protocol for the determination of total mercury in biota prepared by IAEA (2012b⁴⁸⁵) is presented in Annex XII (Recommended method on the determination of Total Hg in samples of marine origin by Cold Vapour Atomic Absorption Spectrometry). A method for the determination of Total Hg in marine biota using CV-AAS is also suggested by HELCOM (2012b) (Annex VIII) and US EPA (2007b)⁴⁸⁶.

3. Technical note for the analysis of seafood tissue samples for organic contaminants

43. Regulated organic contaminants include PAHs (Bezo(a)pyrene, benz(a)anthracene, benzo(b)fluoranthene and chrysene) (Regulation (EC) No 835/2011, Annex II), dioxins, dioxin-like PCBs (Regulation (EC) No 1881/2006) (Annex I.) and non-dioxin like PCBs (PCB 28, PCB 52, PCB 101, PCB 138, PCB 153 and PCB 180) (EU Regulation (EC) No 1259/2011 (Annex V). Analysis of the four PAHs and the 6 non dioxin-like PCBs can be done following the relevant IMAP Protocols developed for the analysis of PAHs and PCBs in marine biota, in the framework of CII7. However, the Regulation (EC) No 835/2011, which amended Regulation (EC) No 333/2007, doesn't set any maximum level for PAHs in fresh fish, crustaceans or cephalopods, and sets maximum level for benzo(a)pyrene and the sum of four regulated PAHs (Bezo(a)pyrene, benz(a)anthracene, benzo(b)fluoranthene and chrysene) only for bivalves (fresh, chilled or frozen).

44. Analysis of dioxins and dioxin like PCBs, can only be done in a laboratory accredited for such analysis using appropriate methods such as High-Resolution Gas Chromatography/High Resolution Mass Spectrometry (HRGC/HRMS). Sampling and sample preparation for such analysis should follow the requirements presented in EU Regulation (EC) 644/2017 (Annex IV).

45. Analytical methods for non-dioxin like PCBs include Gas Chromatography - Electron Capture Detection (GC-ECD), Gas Chromatography - Low Resolution Mass Spectroscopy (GC-LRMS), Gas Chromatography – Tandem Mass Spectroscopy (GC-MS/MS), Gas Chromatography - High Resolution Mass Spectroscopy (GC-HRMS) or equivalent methods.

46. National laboratories may decide to use any validated analytical method they consider appropriate, which meets specific performance criteria (LOD, LOQ, precision, recovery and specificity – EU Regulation (EC) No 836/2011) (Annex III) and EU Regulation (EC) 644/2017 (Annex IV).

Performance criteria for methods of analysis for the four regulated PAHs, (EC) No 836/2011

Parameter	Criterion
Applicability	Foods specified in Regulation (EC) No 1881/2006

⁴⁸⁵ IAEA (2012b). Recommended method on the determination of Total Hg in samples of marine origin by Cold Vapour Atomic Absorption Spectrometry

⁴⁸⁶ US EPA (2007b). U.S. Environmental Protection Agency, EPA method 7473, Mercury in solids and solutions by thermal decomposition, amalgamation and atomic absorption spectrophotometry Rev 0.
<http://www.epa.gov/osw/hazard/testmethods/sw846/pdfs/7473.pdf>

Specificity	Free from matrix or spectral interferences, verification of positive detection
Repeatability (RSD _r)	HORRAT _r less than 2 *
Reproducibility (RSD _R)	HORRAT _R less than 2 *
Recovery	50 to 120 %
LOD	≤ 0.30 µg kg ⁻¹ for each of the four substances
LOQ	≤ 0.90 µg kg ⁻¹ for each of the four substances

* 'HORRAT_r' = The observed RSD_r divided by the RSD_r value estimated from the Horwitz equation using the assumption $r = 0,66R$. (M. Thompson, Analyst, 2000⁴⁸⁷, 125, 385-386.)

'HORRAT_R' = The observed RSD_R value divided by the RSD_R value calculated from the Horwitz equation.

Performance criteria to be met in the range of the maximum level for the TEQ value respectively the BEQ value, whether determined as total TEQ (Toxic Equivalents) or total BEQ (as sum of PCDD/F and dioxin-like PCBs) or separately for PCDD/Fs and dioxin-like PCBs, (EC) No 644/2017

	Screening with bioanalytical or physico-chemical methods	Confirmatory methods
False-compliant rate(*)	< 5 %	
Trueness		20 % to + 20 %
Repeatability (RSD _r)	< 20 %	
Intermediate precision (RSD _R)	< 25 % < 15	< 25 % < 15

(*) With respect to the maximum levels

Performance criteria for the sum of non-dioxin like PCBs, (EC) No 644/2017

	Isotope dilution mass spectrometry(*)	Other techniques
Trueness	- 20 to + 20 %	- 30 to + 30 %
Intermediate precision (RSD _R)	≤ 15 %	≤ 20 %
Difference between upper and lower bound calculation	≤ 20 %	≤ 20 %

(*) Use of all six ¹³C-labelled analogues as internal standards required

47. The laboratory used for organic trace analysis must be a dedicated facility, isolated from other projects that could be sources of contamination. It must be properly constructed with fume hoods and benches with electric sockets that are safe for use with flammable solvents. The laboratory must have extractors and rotary evaporators cooling water to run the stills. In tropical regions and in dry climates,

⁴⁸⁷ Thomson, M. (2000). Recent trends in inter-laboratory precision at ppb and sub-ppb concentrations in relation to fitness for purpose criteria in proficiency testing. Analyst 125, 385-386

a refrigerated re-circulating system should be used to reduce temperatures to the required levels and/or to conserve water. Stainless steel or ceramic tiles make good non-contaminating surfaces. If necessary, benches can be coated with a hard epoxy resin and walls can be painted with epoxy paint. A sheet of aluminium foil on the workbench provides a surface which can be cleaned with solvent. A vented storage facility for solvents is essential. Benches must be fitted with frames to hold stills, extractors, etc. The emergency cut-off switch should be accessible from both inside and outside the laboratory. Firefighting equipment should be mounted in obvious places and laboratory personnel trained in their use.

48. In order to assist analytical laboratories of the Contracting Parties to the Barcelona Convention, IMAP Protocols are proposed for the analysis of the four regulated PAHs (Benzo(a)pyrene, benz(a)anthracene, benzo(b)fluoranthene and chrysene), dioxins, dioxin-like PCBs and non dioxin-like PCBs in seafood samples. Analytical laboratories should accommodate, test and modify each step of the procedures presented in the Protocols in order to validate their final results. The list of methods and analytical equipment is not exhaustive and laboratories are encouraged to use their own equipment/methods that consider adequate for the required analyses.

49. Under this Technical note, this Guidelines related to sample preparation and analysis of sea food includes the following IMAP Protocols for the analysis of organic compounds in marine biota samples:

- Protocol for the analysis of dioxins and dioxin-like PCBs using Gas Chromatography - High Resolution Mass Spectrometry (GC-HRMS);
- Protocol for the analysis of non-dioxin like PCBs in marine biota using Gas Chromatography-Electron Capture Detector (GC-ECD);
- Protocol for the analysis of non-dioxin like PCBs in marine biota using Gas Chromatography - Mass Spectroscopy (GC-MS);
- Protocol for the analysis of PAHs in marine biota using High Performance Liquid Chromatography – Fluorescence (HPLC-UVF);
- Protocol for the analysis of PAHs in marine biota using Gas Chromatography – Mass Spectrometry (GC-MS).

50. These protocols are based on analytical methods developed by UNEP/IAEA (Annex XIV: Reference Methods for Marine Pollution Studies No 71 for the analysis of selected chlorinated hydrocarbons in the marine environment), HELCOM COMBINE programme (Annex XV: Technical note on the determination of chlorinated biphenyls and organochlorine pesticides in biota; Annex XVI: Technical Note on the determination of Polycyclic Aromatic Hydrocarbons in Biota), ICES/OSPAR (Annex XVII: CEMP Guidelines for monitoring contaminants in biota and sediments: Determination of parent and alkylated PAHs in biological materials) and the US EPA (Annex XVIII: US EPA Method 1613, Tetra- through octachlorinated dioxins and furans by isotope dilution HRGC/HRMS; Annex XIX: US EPA Method 1668, Chlorinated biphenyl congeners in water, soil, sediment, and tissue by HRGC/HRMS).

3.1 Protocol for the analysis of dioxins and dioxin-like PCBs using GC-HRMS

51. Chlorinated dibenzo-*p*-dioxins (dioxins) and chlorinated dibenzofurans (furans), have similar chemical properties and toxic effects, and are generally determined as a single group. The dioxin-like PCBs are also showing high toxicity and are included in the list of compounds to be determined in seafood for the protection of consumers' health. The most toxic dioxin is the 2,3,7,8-tetrachlorodibenzo-*p*-dioxin (2,3,7,8-TCDD), while other congeners have different degrees of toxicity (A list with the WHO-toxic equivalent factors for human risk assessment is presented in the EU (EC)

Regulation No 1881/2006, Annex I.). Dioxins and dioxin-like PCBs are found in very low concentrations in seafood, therefore analytical methods require LODs as parts-per-trillion (ppt: 10^{-12} g 2,3,7,8-TCDD per g of sample) or parts-per-quadrillion (ppq: 10^{-15} g 2,3,7,8-TCDD per g of sample). Therefore, it is very important to efficiently separate these compounds from other organic contaminants, with similar physical and chemical properties before determination.

52. The analysis of dioxins and dioxin-like PCBs in seafood samples involves extraction from the matrix with organic solvents, followed by clean-up and gas chromatographic separation and detection with GC-HRMS (Reiner et al, 2006⁴⁸⁸): Extraction techniques include Soxhlet, liquid/liquid extraction (US EPA 1994), solid-phase extraction (SPE) (Taylor et al, 1995⁴⁸⁹), or pressurized fluid extraction (Richter et al 1994⁴⁹⁰). Once the extract has been transferred to a suitable solvent, follows a three-stage (silica, alumina and carbon) open-column clean-up. PCB interferences can be eliminated by analyzing extracts on multiple columns (US EPA 2008⁴⁹¹ Method 1668). A number of analyte-specific columns can be used to reduce both dioxin and PCB interferences and reduce the need for multicolumn analysis.

53. Dioxins and dioxin-like PCBs are usually analyzed using High Resolution Gas Chromatography - High Resolution Mass Spectrometry (HRGC-HRMS) employing isotope dilution (Petrovic et al 2002⁴⁹², Focant et al, 2005⁴⁹³). Methods for the analysis of dioxins and dioxin-like PCBs are developed by US EPA (1994, 2008), ISO Method 18073 (2004⁴⁹⁴), ISO Method 17585 (2006⁴⁹⁵) and the European Committee for Standardization European Standard EN 1948 (CEN, 1997⁴⁹⁶). An overview of the methodology for sample extraction, cleanup and CG-MS analysis, as well as data quality control and data reporting is presented in the article of Reiner et al (2006): “Advances in analytical techniques for polychlorinated dibenzo-p-dioxins, polychlorinated dibenzofurans and dioxin-like PCBs”. Other detection methods for dioxins and furans include Tandem Mass Spectrometry as hybrid/MS (Charles et al 1989⁴⁹⁷) and triple quadrupole MS/MS (Reiner et al, 1990⁴⁹⁸, 1991⁴⁹⁹).

⁴⁸⁸Reiner, E.J, Clement, R.E, Okey, A.B., Marvin, C.H. (2006). Advances in analytical techniques for polychlorinated dibenzo-p-dioxins, polychlorinated dibenzofurans and dioxin-like PCBs. *Anal Bioanal Chem* (2006) 386: 791–806.

⁴⁸⁹ Taylor KZ, Waddell DS, Reiner EJ, MacPherson KA (1995). Direct Elution of Solid Phase Extraction Disks for the Determination of Polychlorinated Dibenzo-p-dioxins and Polychlorinated Dibenzofurans in Effluent Samples. *Analytical Chemistry*, 67:1186–1190

⁴⁹⁰ Richter B.E, Jones B.A, Ezzell J.L, Porter N.L, Avdalovic N, Pohl C (1996). Accelerated Solvent Extraction: A Technique for Sample Preparation. *Analytical Chemistry*, 68:1033–1039

⁴⁹¹ US EPA (2008) Method 1668, Revision B: Chlorinated biphenyl congeners in water, soil, sediment, and tissue by HRGC/HRMS, EPA-821-R-08-020. Office of Water, US Environmental Protection Agency, Washington, DC (Annex XVI)

⁴⁹² Petrovic M., Eljarrat E., Lopezde Alda M.J, Barcelo D. (2002). Recent advances in the mass spectrometric analysis related to endocrine disrupting compounds in aquatic environmental samples. *J. Chromatography A* 974:23–51.

⁴⁹³ Focant J.F, Pirard C, Eppe G, DePauw E. (2005). Recent advances in mass spectrometric measurement of dioxins J. *Chromatography A*. 1067:265–275

⁴⁹⁴ ISO (2004) ISO 18073: Water quality—Determination of tetratocta-chlorinated dioxins and furans—Method using isotope dilution HRGC/HRMS. International Organization for Standardization (ISO), Geneva, Switzerland

⁴⁹⁵ ISO (2006) ISO 17585: Water quality—Determination of dioxin-like polychlorinatedbiphenyls—method using gas chromatography and mass spectrometry. International Organization for Standardization (ISO), Geneva, Switzerland

⁴⁹⁶ CEN (1997) European Standard EN 1948: Stationary source emissions, determination of the mass concentration of PCDDs/PCDFs. CEN, Brussels, Belgium

⁴⁹⁷ Charles M.J, Green B., Tondeur J.R, Hass R. (1989). Optimisation of a hybrid-mass spectrometer method for the analysis of polychlorinated dibenzo-p-dioxins and polychlorinated dibenzofurans. *Chemosphere* 19, 51–57

⁴⁹⁸ Reiner E.J, Schellenberg D.H Taguchi V.Y, Mercer R.S, Townsend J.A, Thompson T.S, Clement R.E (1990). Application of tandem quadrupole mass spectrometry for ultra-trace determination of polychlorinated dibenzo-p-dioxins and dibenzofurans. *Chemosphere* 20, 1385-1392.

⁴⁹⁹ Reiner E.J, Schellenberg D.H, Taguchi V.Y (1991). Environmental applications for the analysis of chlorinated dibenzo-p-dioxins and dibenzofurans using mass-spectrometry. *Environ Sci Technol* 25:110–117

54. Detailed guidelines for the analysis of dioxins and dioxin-like PCBs with HRGC-HRMS are proposed by US EPA Method 1613b (1994) (Annex XVIII) and US EPA Method 1668 (2008) (Annex XIX).

3.2 Protocol for the analysis of non-dioxin like PCBs in seafood using GC-ECD

55. The analysis of non-dioxin like PCBs in seafood samples involves extraction from the matrix with organic solvents, followed by clean-up and gas chromatographic separation with electron capture (GC-ECD) or mass spectrometric (GC-MS) detection. To minimize systematic errors due to insufficiently optimized gas chromatographic conditions, determinant losses (evaporation, unsatisfactory extraction yield), and/or contamination from laboratory ware, reagents and the laboratory environment, it is essential that the sources of systematic errors are identified and eliminated as far as possible (HELCOM, 2012c⁵⁰⁰).

56. For analysis, the samples are prepared for solvent extraction. To achieve a satisfactory recovery of the chlorinated hydrocarbons, samples are dried by either desiccation with anhydrous sodium sulphate or by freeze-drying. Lipids are then Soxhlet extracted from biota using hexane or petroleum ether. Following initial clean-up treatments (treatment of biota extracts with concentrated sulphuric acid to destroy some interfering lipids), extracts are fractionated using column chromatography.

57. All reagents, including the distilled water should be of analytical quality. Commercially available solvents like acetone, acetonitrile, dichloromethane, hexane and pentane are invariably contaminated with ECD-active substances; their concentrations vary from batch to batch and with supplier. Reagent quality should be checked by injection of 2 µl of a 100 ml batch of solvent, after concentration to 50 µl in a rotary evaporator.

58. Quantitative analysis with Electron Capture Detector (ECD) is performed by comparing the detector signal produced by the sample with that of defined standards. Due to incomplete separation, several co-eluting compounds can be present under a single detector signal, therefore, the shape and size of the signal have to be critically examined. The relative retention time and the signal size should be confirmed on columns with different polarity of their stationary phases, or by the use of multi-dimensional GC techniques. The GC should be calibrated before each batch of measurements. Since the ECD has a non-linear response curve, a multilevel calibration is strongly advised. For the purpose of determining recovery rates, an appropriate internal standard should be added to each sample at the beginning of the analytical procedure. (HELCOM, 2012c).

59. A step-by-step method for the determination of polychlorinated biphenyls in biological samples by GC ECD is prepared by UNEP/IAEA (2011d⁵⁰¹) (Annex XIV.), including the list of reagents, the solvents, standards and examples for the preparation of the stock, intermediate and working solutions. A method for the analysis of PCBs in biota tissues by GC ECD is also proposed by HELCOM (2012c) (Annex XV.).

3.3 Protocol for the analysis of non-dioxin like PCBs in seafood using GC-MS

60. The analysis of non-dioxin like PCBs in seafood samples involves extraction from the matrix with organic solvents, followed by clean-up (as presented in the Protocol 3.2.), and gas chromatographic separation with mass spectrometric (GC-MS) detection.

⁵⁰⁰ HELCOM (2012c). Manual for marine monitoring in the COMBINE programme. Annex B-12, Appendix 3. Technical note on the determination of chlorinated biphenyls and organochlorine pesticides in biota.

⁵⁰¹ UNEP/IAEA (2011d). Sample work-up for the analysis of selected chlorinated hydrocarbons in the marine environment. Reference Methods for Marine Pollution Studies No 71.

61. Quantitative analysis is performed by comparing the detector signal produced by the sample with that of defined standards, using a mass spectrometer (MS). Often, due to incomplete separation, several co-eluting compounds can be present under a single detector signal. Therefore, the shape and size of the signal have to be critically examined. With a MS detector, either the molecular mass or characteristic mass fragments should be recorded for that purpose. The GC should be calibrated before each batch of measurements. Since the MS has a non-linear response curve, a multilevel calibration is advised. For the purpose of determining recovery rates, an appropriate internal standard should be added to each sample at the beginning of the analytical procedure. The ideal internal standard is a PCB which is not present in the sample and which does not interfere with other PCBs. All 2,4,6-substituted PCB congeners are, in principle, suitable. (HELCOM, 2012c).

62. A method for extraction, concentration, cleanup and fractionation for the determination of PCBs in biological samples is prepared by UNEP/IAEA (2011d) (Annex XIV). The analysis of PCBs can be done by GC-ECD followed by confirmation using GC-MS. A method for the analysis of PCBs in biota tissues using GC-MS is also proposed by HELCOM (2012c) (Annex XV.).

3.4 Protocol for the analysis of PAHs in seafood using HPLC – UVF

63. PAHs emitted from combustion processes are predominantly parent (un-substituted) compounds, while PAHs from petroleum and its by-products contain a range of alkylated compounds in addition to the parent PAHs. High Performance Liquid Chromatography – Fluorescence (HPLC - UVF) has the capacity to determine parent PAHs but has not the required selectivity to be used for alkylated PAHs' determination. However, this is not a limitation for the analysis of the four regulated PAHs, which are parent compounds.

64. PAHs are lipophilic and so are concentrated in the lipids of an organism, therefore they have to be extracted with Soxhlet extraction, or alkaline digestion followed by liquid-liquid extraction with an organic solvent. For Soxhlet extraction, wet tissues should be dried by mixing with a chemical agent (e.g., anhydrous sodium sulphate). Non-polar solvents alone will not effectively extract all the PAHs from tissues when using Soxhlet extraction, and mixtures such as hexane/dichloromethane may be effective. Tissue extracts will always contain many compounds other than PAHs, and a clean-up is necessary to remove those compounds which may interfere with the subsequent analysis. In order to reduce the sample volume to 2 cm³ solvents are evaporated using a rotary-film evaporator at low temperature (water bath temperature of 30 °C or lower) and under controlled pressure conditions. Evaporation to dryness should be avoided. When reducing the sample to final volume, solvents can be removed by a stream of clean nitrogen gas. Solvents and adsorptive materials must all be checked for the presence of PAHs and other interfering compounds. If such compound are found, then the solvents, reagents, and adsorptive materials must be purified or cleaned using appropriate methods (HELCOM, 2012d⁵⁰², Annex XVI).

65. If Soxhlet extraction was used residual lipids have to be removed before the analytical determination, with an additional clean-up stage, using column chromatography with silica and alumina

66. Guidelines for the determination of PAHs in biological samples using HPLC – UVF are prepared by HELCOM (2012d) (Annex XVI.) and ICES/OSPAR (2018⁵⁰³) (Annex XVI).

3.5 Protocol for the analysis of PAHs in seafood using GC-MS

⁵⁰² HELCOM (2012d). Manual for marine monitoring in the COMBINE programme. Annex B-12, Appendix 2. Technical Note on the determination of Polycyclic Aromatic Hydrocarbons in Biota

⁵⁰³ ICES/OSPAR (2018). CEMP Guidelines for monitoring contaminants in biota and sediments. Technical Annex 3: Determination of parent and alkylated PAHs in biological materials

67. GC-MS analytical method has the sufficient selectivity to determine the full range of PAHs including the four regulated contaminants (parent PAH compounds).

68. The extraction procedure is similar to the procedure described for HPLC-UVF methodology, including Soxhlet extraction, or alkaline digestion, followed by liquid-liquid extraction with an organic solvent. Alternatively extraction of wet or dry samples of biota may be carried out by pressurized liquid extraction (PLE). Tissue extracts will always contain many compounds other than PAHs, and a clean-up is necessary to remove those compounds which may interfere with the subsequent analysis. The most commonly used clean-up methods involve the use of deactivated alumina or silica adsorption chromatography. When applying fractionation, the elution pattern has to be checked frequently. This should be carried out in the presence of sample matrix, as that can partially deactivate the clean-up column, resulting in earlier elution of the PAHs than in a standard solution (ICES/OSPAR, 2018).

69. Following cleanup, solvents are evaporated using a rotary-film evaporator at low temperature (water bath temperature of 30 °C or lower) and under controlled pressure conditions, and the sample volume is reduced to approximately 2 cm³. Evaporation to dryness should be avoided. When reducing the sample to final volume, solvents can be removed by a stream of clean nitrogen gas. Solvents and adsorptive materials must all be checked for the presence of PAHs and other interfering compounds. If such compounds are found, then the solvents, reagents, and adsorptive materials must be purified or cleaned using appropriate methods.

70. Quantification is done by GC-MS. The two injection modes commonly used are splitless and on-column injection. Automatic sample injection should be used wherever possible to improve the reproducibility of injection and the precision of the overall method. If splitless injection is used, the liner should be of sufficient capacity to contain the injected solvent volume after evaporation. For PAH analysis, the cleanliness of the liner is also very important if adsorption effects and discrimination are to be avoided, and the analytical column should not contain active sites to which PAHs can be adsorbed. Helium is the preferred carrier gas, and only capillary columns should be used (HELCOM, 2012d, ICES/OSPAR 2018).

71. Detailed methods for the determination of PAHs in biological samples using GC-MS are proposed by HELCOM (2012d) (Annex XVI) and ICES/OSPAR (2018) (Annex XVII).

Appendix 26
Official Journal of the European Union
COMMISSION REGULATION (EC) No 1881/2006
of 19 December 2006
setting maximum levels for certain contaminants in
foodstuffs

COMMISSION REGULATION (EC) No 1881/2006
of 19 December 2006
setting maximum levels for certain contaminants in foodstuffs
 (Text with EEA relevance)

THE COMMISSION OF THE EUROPEAN COMMUNITIES,

Having regard to the Treaty establishing the European Community,

Having regard to Council Regulation (EEC) No 315/93 of 8 February 1993 laying down Community procedures for contaminants in food ⁽¹⁾, and in particular Article 2(3) thereof,

Whereas:

- (1) Commission Regulation (EC) No 466/2001 of 8 March 2001 setting maximum levels for certain contaminants in foodstuffs ⁽²⁾ has been amended substantially many times. It is necessary to amend again maximum levels for certain contaminants to take into account new information and developments in Codex Alimentarius. At the same time, the text should, where appropriate, be clarified. Regulation (EC) No 466/2001 should therefore be replaced.
- (2) It is essential, in order to protect public health, to keep contaminants at levels which are toxicologically acceptable.
- (3) In view of disparities between the laws of Member States and the consequent risk of distortion of competition, for some contaminants Community measures are necessary in order to ensure market unity while abiding by the principle of proportionality.
- (4) Maximum levels should be set at a strict level which is reasonably achievable by following good agricultural, fishery and manufacturing practices and taking into account the risk related to the consumption of the food. In the case of contaminants which are considered to be genotoxic carcinogens or in cases where current exposure of the population or of vulnerable groups in the population is close to or exceeds the tolerable intake, maximum levels should be set at a level which is as low as reasonably achievable (ALARA). Such approaches ensure that food business operators apply measures to prevent and reduce the contamination as far as possible in order to protect public health. It is furthermore appropriate for the health protection of infants and young children, a vulnerable group, to establish the lowest maximum levels, which are achievable through a strict selection of the raw materials used for the manufacturing of foods for infants and young children. This strict selection of the raw materials is also appropriate for the production of some specific foodstuffs such as bran for direct human consumption.
- (5) To allow maximum levels to be applied to dried, diluted, processed and compound foodstuffs, where no specific Community maximum levels have been established, food business operators should provide the specific concentration and dilution factors accompanied by the appropriate experimental data justifying the factor proposed.
- (6) To ensure an efficient protection of public health, products containing contaminants exceeding the maximum levels should not be placed on the market either as such, after mixture with other foodstuffs or used as an ingredient in other foods.
- (7) It is recognised that sorting or other physical treatments make it possible to reduce the aflatoxin content of consignments of groundnuts, nuts, dried fruit and maize. In order to minimise the effects on trade, it is appropriate to allow higher aflatoxin contents for those products which are not intended for direct human consumption or as an ingredient in foodstuffs. In these cases, the maximum levels for aflatoxins should be fixed taking into consideration the effectiveness of the above-mentioned treatments to reduce the aflatoxin content in groundnuts, nuts, dried fruit and maize to levels below the maximum limits fixed for those products intended for direct human consumption or use as an ingredient in foodstuffs.
- (8) To enable effective enforcement of the maximum levels for certain contaminants in certain foodstuffs, it is appropriate to provide for suitable labelling provisions for these cases.

⁽¹⁾ OJ L 37, 13.2.1993, p. 1. Regulation as amended by Regulation (EC) No 1882/2003 of the European Parliament and of the Council (OJ L 284, 31.10.2003, p. 1).

⁽²⁾ OJ L 77, 16.3.2001, p. 1. Regulation as last amended by Regulation (EC) No 199/2006 (OJ L 32, 4.2.2006, p. 32).

- (9) Because of the climatic conditions in some Member States, it is difficult to ensure that the maximum levels are not exceeded for fresh lettuce and fresh spinach. These Member States should be allowed for a temporary period to continue to authorise the marketing of fresh lettuce and fresh spinach grown and intended for consumption in their territory with nitrate contents exceeding the maximum levels. Lettuce and spinach producers established in the Member States which have given the aforementioned authorisations should progressively modify their farming methods by applying the good agricultural practices recommended at national level.
- (10) Certain fish species originating from the Baltic region may contain high levels of dioxins and dioxin-like PCBs. A significant proportion of these fish species from the Baltic region will not comply with the maximum levels and would therefore be excluded from the diet. There are indications that the exclusion of fish from the diet may have a negative health impact in the Baltic region.
- (11) Sweden and Finland have a system in place which has the capacity to ensure that consumers are fully informed of the dietary recommendations concerning restrictions on consumption of fish from the Baltic region by identified vulnerable groups of the population in order to avoid potential health risks. Therefore, it is appropriate to grant a derogation to Finland and Sweden to place on the market for a temporary period certain fish species originating in the Baltic region and intended for consumption in their territory with levels of dioxins and dioxin-like PCBs higher than those set in this Regulation. The necessary measures must be implemented to ensure that fish and fish products not complying with the maximum levels are not marketed in other Member States. Finland and Sweden report every year to the Commission the results of their monitoring of the levels of dioxins and dioxin-like PCBs in fish from the Baltic region and the measures to reduce human exposure to dioxins and dioxin-like PCBs from the Baltic region.
- (12) To ensure that the maximum levels are enforced in a uniform way, the same sampling criteria and the same analysis performance criteria should be applied by the competent authorities throughout the Community. It is furthermore important that analytical results are reported and interpreted in a uniform way. The measures as regards sampling and analysis specified in this Regulation provide for uniform rules on reporting and interpretation.
- (13) For certain contaminants, Member States and interested parties should monitor and report levels, as well report on the progress with regard to application of preventative measures, to allow the Commission to assess the need to modify existing measures or to adopt additional measures.
- (14) Any maximum level adopted at Community level can be subject to a review to take account of the advance of scientific and technical knowledge and improvements in good agricultural, fishery and manufacturing practices.
- (15) Bran and germ can be marketed for direct human consumption and it is therefore appropriate to establish a maximum level for deoxynivalenol and zearalenone in these commodities.
- (16) Codex Alimentarius has recently set a maximum level for lead in fish which the Community accepted. It is therefore appropriate to modify the current provision for lead in fish accordingly.
- (17) Regulation (EC) No 853/2004 of the European Parliament and Council of 29 April 2004 laying down specific hygiene rules for food of animal origin ⁽³⁾ defines foodstuffs of animal origin, and consequently the entries as regards foodstuffs of animal origin should be amended in some cases according to the terminology used in that Regulation.
- (18) It is necessary to provide that the maximum levels for contaminants do not apply to the foodstuffs which have been lawfully placed on the Community market before the date of application of these maximum levels.
- (19) As regards nitrate, vegetables are the major source for the human intake of nitrate. The Scientific Committee on Food (SCF) stated in its opinion of 22 September 1995 ⁽⁴⁾ that the total intake of nitrate is normally well below the acceptable daily intake (ADI) of 3,65 mg/kg body weight (bw). It recommended, however, continuation of efforts to reduce exposure to nitrate via food and water.
- (20) Since climatic conditions have a major influence on the levels of nitrate in certain vegetables such as lettuce and spinach, different maximum nitrate levels should therefore be fixed depending on the season.
- (13) For certain contaminants, Member States and interested parties should monitor and report levels, as well report on the progress with regard to application of pre-

⁽³⁾ OJ L 139, 30.4.2004, p. 55, as corrected by OJ L 226, 25.6.2004, p. 22. Regulation as last amended by Regulation (EC) No 1662/2006 (OJ L 320, 18.11.2006, p. 1).

⁽⁴⁾ Reports of the Scientific Committee for Food, 38th series, Opinion of the Scientific Committee for Food on nitrates and nitrite, p. 1, http://ec.europa.eu/food/fs/sc/scf/reports/scf_reports_38.pdf

- (21) As regards aflatoxins, the SCF expressed in its opinion of 23 September 1994 that aflatoxins are genotoxic carcinogens⁽⁵⁾. Based on that opinion, it is appropriate to limit the total aflatoxin content of food (sum of aflatoxins B₁, B₂, G₁ and G₂) as well as the aflatoxin B₁ content alone, aflatoxin B₁ being by far the most toxic compound. For aflatoxin M₁ in foods for infants and young children, a possible reduction of the current maximum level should be considered in the light of developments in analytical procedures.
- (22) As regards ochratoxin A (OTA), the SCF adopted a scientific opinion on 17 September 1998⁽⁶⁾. An assessment of the dietary intake of OTA by the population of the Community has been performed⁽⁷⁾ in the framework of Council Directive 93/5/EEC of 25 February 1993 on assistance to the Commission and cooperation by the Member States in the scientific examination of questions relating to food⁽⁸⁾ (SCOOP). The European Food Safety Authority (EFSA) has, on a request from the Commission, adopted an updated scientific opinion relating to ochratoxin A in food on 4 April 2006⁽⁹⁾, taking into account new scientific information and derived a tolerable weekly intake (TWI) of 120 ng/kg bw.
- (23) Based on these opinions, it is appropriate to set maximum levels for cereals, cereal products, dried vine fruit, roasted coffee, wine, grape juice and foods for infants and young children, all of which contribute significantly to general human exposure to OTA or to the exposure of vulnerable groups of consumers such as children.
- (24) The appropriateness of setting a maximum level for OTA in foodstuffs such as dried fruit other than dried vine fruit, cocoa and cocoa products, spices, meat products, green coffee, beer and liquorice, as well as a review of the existing maximum levels, in particular for OTA in dried vine fruit and grape juice, will be considered in the light of the recent EFSA scientific opinion.
- (25) As regards patulin, the SCF endorsed in its meeting on 8 March 2000 the provisional maximum tolerable daily intake (PMTDI) of 0,4 µg/kg bw for patulin⁽¹⁰⁾.
- (26) In 2001, a SCOOP-task 'Assessment of the dietary intake of patulin by the population of EU Member States' in the framework of Directive 93/5/EEC was performed⁽¹¹⁾.
- (27) Based on that assessment and taking into account the PMTDI, maximum levels should be set for patulin in certain foodstuffs to protect consumers from unacceptable contamination. These maximum levels should be reviewed and, if necessary, reduced taking into account the progress in scientific and technological knowledge and the implementation of Commission Recommendation 2003/598/EC of 11 August 2003 on the prevention and reduction of patulin contamination in apple juice and apple juice ingredients in other beverages⁽¹²⁾.
- (28) As regards Fusarium toxins, the SCF has adopted several opinions evaluating deoxynivalenol in December 1999⁽¹³⁾ establishing a tolerable daily intake (TDI) of 1 µg/kg bw, zearalenone in June 2000⁽¹⁴⁾ establishing a temporary TDI of 0,2 µg/kg bw, fumonisins in October 2000⁽¹⁵⁾ (updated in April 2003)⁽¹⁶⁾ establishing a TDI of 2 µg/kg bw, nivalenol in October 2000⁽¹⁷⁾ establishing a temporary TDI of 0,7 µg/kg bw, T-2 and HT-2 toxin in May 2001⁽¹⁸⁾ establishing a combined temporary TDI of 0,06 µg/kg bw and the trichothecenes as group in February 2002⁽¹⁹⁾.
-
- ⁽⁵⁾ Minutes of the 120th Meeting of the Scientific Committee on Food held on 8 and 9 March 2000 in Brussels, Minute statement on patulin. http://ec.europa.eu/food/fs/sc/scf/out55_en.pdf
- ⁽⁶⁾ Reports on tasks for scientific cooperation, Task 3.2.8, 'Assessment of dietary intake of Patulin by the population of EU Member States'. http://ec.europa.eu/food/food/chemicalsafety/contaminants/3.2.8_en.pdf
- ⁽⁷⁾ OJ L 203, 12.8.2003, p. 34.
- ⁽⁸⁾ Opinion of the Scientific Committee on Food on Fusarium-toxins Part 1: Deoxynivalenol (DON), (expressed on 2 December 1999) http://ec.europa.eu/food/fs/sc/scf/out44_en.pdf
- ⁽⁹⁾ Opinion of the Scientific Committee on Food on Fusarium-toxins Part 2: Zearalenone (ZEA), (expressed on 22 June 2000) http://ec.europa.eu/food/fs/sc/scf/out65_en.pdf
- ⁽¹⁰⁾ Opinion of the Scientific Committee on Food on Fusarium-toxins Part 3: Fumonisin B₁ (FB₁) (expressed on 17 October 2000) http://ec.europa.eu/food/fs/sc/scf/out73_en.pdf
- ⁽¹¹⁾ Updated opinion of the Scientific Committee on Food on Fusonisin B₁, B₂ and B₃ (expressed on 4 April 2003) http://ec.europa.eu/food/fs/sc/scf/out185_en.pdf
- ⁽¹²⁾ Opinion of the Scientific Committee on Food on Fusarium-toxins Part 4: Nivalenol (expressed on 19 October 2000) http://ec.europa.eu/food/fs/sc/scf/out74_en.pdf
- ⁽¹³⁾ Opinion of the Scientific Committee on Food on Fusarium-toxins Part 5: T-2 toxin and HT-2 toxin (adopted on 30 May 2001) http://ec.europa.eu/food/fs/sc/scf/out88_en.pdf
- ⁽¹⁴⁾ Opinion of the Scientific Committee on Food on Fusarium-toxins Part 6: Group evaluation of T-2 toxin, HT-2toxin, nivalenol and deoxynivalenol. (adopted on 26 February 2002) http://ec.europa.eu/food/fs/sc/scf/out123_en.pdf
- ⁽¹⁵⁾ Reports of the Scientific Committee for Food, 35th series, Opinion of the Scientific Committee for Food on aflatoxins, ochratoxin A and patulin, p. 45. http://ec.europa.eu/food/fs/sc/scf/reports/scf_reports_35.pdf
- ⁽¹⁶⁾ Opinion of the Scientific Committee on Food on Ochratoxin A (expressed on 17 September 1998) http://ec.europa.eu/food/fs/sc/scf/out14_en.html
- ⁽¹⁷⁾ Reports on tasks for scientific cooperation, Task 3.2.7 'Assessment of dietary intake of Ochratoxin A by the population of EU Member States'. http://ec.europa.eu/food/food/chemicalsafety/contaminants/task_3-2-7_en.pdf
- ⁽¹⁸⁾ OJ L 52, 4.3.1993, p. 18.
- ⁽¹⁹⁾ Opinion of the Scientific Panel on contaminants in the Food Chain of the EFSA on a request from the Commission related to ochratoxin A in food. http://www.efsa.europa.eu/etc/medialib/efsa/science/contam/contam_opinions/1521.Par.0001.File.dat/contam_op_ej365_ochratoxin_a_food_en1.pdf

- (29) In the framework of Directive 93/5/EEC the SCOOP-task 'Collection of occurrence data on Fusarium toxins in food and assessment of dietary intake by the population of EU Member States' was performed and finalised in September 2003 ⁽²⁰⁾.
- (30) Based on the scientific opinions and the assessment of the dietary intake, it is appropriate to set maximum levels for deoxynivalenol, zearalenone and fumonisins. As regards fumonisins, monitoring control results of the recent harvests indicate that maize and maize products can be very highly contaminated by fumonisins and it is appropriate that measures are taken to avoid such unacceptably highly contaminated maize and maize products can enter the food chain.
- (31) Intake estimates indicate that the presence of T-2 and HT-2 toxin can be of concern for public health. Therefore, the development of a reliable and sensitive method, collection of more occurrence data and more investigations/research in the factors involved in the presence of T-2 and HT-2 toxin in cereals and cereal products, in particular in oats and oat products, is necessary and of high priority.
- (32) It is not necessary due to co-occurrence to consider specific measures for 3-acetyl deoxynivalenol, 15-acetyl deoxynivalenol and fumonisin B₃, as measures with regard to in particular deoxynivalenol and fumonisin B₁ and B₂ would also protect the human population from an unacceptable exposure from 3-acetyl deoxynivalenol, 15-acetyl deoxynivalenol and fumonisin B₃. The same applies to nivalenol for which to a certain degree co-occurrence with deoxynivalenol can be observed. Furthermore, human exposure to nivalenol is estimated to be significantly below the t-TDI. As regards other trichothecenes considered in the abovementioned SCOOP-task, such as 3-acetyldeoxynivalenol, 15-acetyldeoxynivalenol, fusarenon-X, T2-triol, diacetoxyscirpenol, neosolaniol, monoacetoxyscirpenol and verrucol, the limited information available indicates that they do not occur widely and the levels found are generally low.
- (33) Climatic conditions during the growth, in particular at flowering, have a major influence on the Fusarium toxin content. However, good agricultural practices, whereby the risk factors are reduced to a minimum, can prevent to a certain degree the contamination by *Fusarium* fungi. Commission Recommendation 2006/583/EC of 17 August 2006 on the prevention and reduction of Fusarium toxins in cereals and cereal products ⁽²¹⁾ contains general principles for the prevention and reduction of Fusarium toxin contamination (zearalenone, fumonisins and trichothecenes) in cereals to be implemented by the development of national codes of practice based on these principles.
- (34) Maximum levels of Fusarium toxins should be set for unprocessed cereals placed on the market for first-stage processing. Cleaning, sorting and drying procedures are not considered as first-stage processing insofar as no physical action is exerted on the grain kernel itself. Scouring is to be considered as first-stage processing.
- (35) Since the degree to which Fusarium toxins in unprocessed cereals are removed by cleaning and processing may vary, it is appropriate to set maximum levels for final consumer cereal products as well as for major food ingredients derived from cereals to have enforceable legislation in the interest of ensuring public health protection.
- (36) For maize, not all factors involved in the formation of Fusarium toxins, in particular zearalenone and fumonisins B₁ and B₂, are yet precisely known. Therefore, a time period is granted to enable food business operators in the cereal chain to perform investigations on the sources of the formation of these mycotoxins and on the identification of the management measures to be taken to prevent their presence as far as reasonably possible. Maximum levels based on currently available occurrence data are proposed to apply from 2007 in case no specific maximum levels based on new information on occurrence and formation are set before that time.
- (37) Given the low contamination levels of Fusarium toxins found in rice, no maximum levels are proposed for rice or rice products.
- (38) A review of the maximum levels for deoxynivalenol, zearalenone, fumonisin B₁ and B₂ as well as the appropriateness of setting a maximum level for T-2 and HT-2 toxin in cereals and cereal products should be considered by 1 July 2008, taking into account the progress in scientific and technological knowledge on these toxins in food.
- (39) As regards lead, the SCF adopted an opinion on 19 June 1992 ⁽²²⁾ endorsing the provisional tolerable weekly intake (PTWI) of 25 µg/kg bw proposed by the WHO in 1986. The SCF concluded in its opinion that the mean level in foodstuffs does not seem to be a cause of immediate concern.

⁽²⁰⁾ Reports on tasks for scientific cooperation, Task 3.2.10 'Collection of occurrence data of Fusarium toxins in food and assessment of dietary intake by the population of EU Member States'. <http://ec.europa.eu/food/fs/scoop/task3210.pdf>

⁽²¹⁾ OJ L 234, 29.8.2006, p. 35.

⁽²²⁾ Reports of the Scientific Committee for Food, 32nd series, Opinion of the Scientific Committee for Food on 'The potential risk to health presented by lead in food and drink', p. 7, http://ec.europa.eu/food/fs/sc/scf/reports/scf_reports_32.pdf

- (40) In the framework of Directive 93/5/EEC 2004 the SCOOP-task 3.2.11 'Assessment of the dietary exposure to arsenic, cadmium, lead and mercury of the population of the EU Member States' was performed in 2004⁽²³⁾. In view of this assessment and the opinion delivered by the SCF, it is appropriate to take measures to reduce the presence of lead in food as much as possible
- (41) As regards cadmium, the SCF endorsed in its opinion of 2 June 1995⁽²⁴⁾ the PTWI of 7 µg/kg bw and recommended greater efforts to reduce dietary exposure to cadmium since foodstuffs are the main source of human intake of cadmium. A dietary exposure assessment was performed in the SCOOP-task 3.2.11. In view of this assessment and the opinion delivered by the SCF, it is appropriate to take measures to reduce the presence of cadmium in food as much as possible.
- (42) As regards mercury EFSA adopted on 24 February 2004 an opinion related to mercury and methylmercury in food⁽²⁵⁾ and endorsed the provisional tolerable weekly intake of 1,6 µg/kg bw. Methylmercury is the chemical form of most concern and can make up more than 90 % of the total mercury in fish and seafood. Taking into account the outcome of the SCOOP-task 3.2.11, EFSA concluded that the levels of mercury found in foods, other than fish and seafood, were of lower concern. The forms of mercury present in these other foods are mainly not methylmercury and they are therefore considered to be of lower risk.
- (43) In addition to the setting of maximum levels, targeted consumer advice is an appropriate approach in the case of methylmercury for protecting vulnerable groups of the population. An information note on methylmercury in fish and fishery products responding to this need has therefore been made available on the website of the Health and Consumer Protection Directorate-General of the European Commission⁽²⁶⁾. Several Member States have also issued advice on this issue that is relevant to their population.
- (44) As regards inorganic tin, the SCF concluded in its opinion of 12 December 2001⁽²⁷⁾ that levels of inorganic tin of 150 mg/kg in canned beverages and 250 mg/kg in other canned foods may cause gastric irritation in some individuals.
- (45) To protect public health from this health risk it is necessary to set maximum levels for inorganic tin in canned foods and canned beverages. Until data becomes available on the sensitivity of infants and young children to inorganic tin in foods, it is necessary on a precautionary basis to protect the health of this vulnerable population group and to establish lower maximum levels.
- (46) As regards 3-monochloropropane-1,2-diol (3-MCPD) the SCF adopted on 30 May 2001 a scientific opinion as regards 3-MCPD in food⁽²⁸⁾, updating its opinion of 16 December 1994⁽²⁹⁾ on the basis of new scientific information and established a tolerable daily intake (TDI) of 2 µg/kg bw for 3-MCPD.
- (47) In the framework of Directive 93/5/EEC the SCOOP-task 'Collection and collation of data on levels of 3-MCPD and related substances in foodstuffs' was performed and finalised in June 2004⁽³⁰⁾. The main contributors of 3-MCPD to dietary intake were soy sauce and soy-sauce based products. Some other foods eaten in large quantities, such as bread and noodles, also contributed significantly to intake in some countries because of high consumption rather than high levels of 3-MCPD present in these foods.
- (48) Accordingly maximum levels should be set for 3-MCPD in hydrolysed vegetable protein (HVP) and soy sauce taking into account the risk related to the consumption of these foods. Member States are requested to examine other foodstuffs for the occurrence of 3-MCPD in order to consider the need to set maximum levels for additional foodstuffs.

⁽²³⁾ Reports on tasks for scientific co-operation, Task 3.2.11 'Assessment of dietary exposure to arsenic, cadmium, lead and mercury of the population of the EU Member States'. http://ec.europa.eu/food/food/chemicalsafety/contaminants/scoop_3-2-11_heavy_metals_report_en.pdf

⁽²⁴⁾ Reports of the Scientific Committee for Food, 36th series, Opinion of the Scientific Committee for Food on cadmium, p. 67, http://ec.europa.eu/food/fs/sc/scf/reports/scf_reports_36.pdf

⁽²⁵⁾ Opinion of the Scientific Panel on contaminants in the Food Chain of the European Food Safety Authority (EFSA) on a request from the Commission related to mercury and methylmercury in food (adopted on 24 February 2004) http://www.efsa.eu.int/science/contam/contam_opinions/259/opinion_contam_01_en1.pdf

⁽²⁶⁾ http://ec.europa.eu/food/food/chemicalsafety/contaminants/information_note_mercury-fish_12-05-04.pdf

⁽²⁷⁾ Opinion of the Scientific Committee on Food on acute risks posed by tin in canned foods (adopted on 12 December 2001) http://ec.europa.eu/food/fs/sc/scf/out110_en.pdf

⁽²⁸⁾ Opinion of the Scientific Committee on Food on 3-monochloropropane-1,2-diol (3-MCPD) updating the SCF opinion of 1994 (adopted on 30 May 2001) http://ec.europa.eu/food/fs/sc/scf/out91_en.pdf

⁽²⁹⁾ Reports of the Scientific Committee for Food, 36th series, Opinion of the Scientific Committee for Food on 3-monochloropropane-1,2-diol 3-MCPD, p. 31, http://ec.europa.eu/food/fs/sc/scf/reports/scf_reports_36.pdf

⁽³⁰⁾ Reports on tasks for scientific cooperation, Task 3.2.9 'Collection and collation of data on levels of 3-monochloropropanediol (3-MCPD) and related substances in foodstuffs'. http://ec.europa.eu/food/food/chemicalsafety/contaminants/scoop_3-2-9_final_report_chloropropanols_en.pdf

- (49) As regards dioxins and PCBs, the SCF adopted on 30 May 2001 an opinion on dioxins and dioxin-like PCBs in food ⁽³¹⁾, updating its opinion of 22 November 2000 ⁽³²⁾ fixing a tolerable weekly intake (TWI) of 14 pg World Health Organisation toxic equivalent (WHO-TEQ)/kg bw for dioxins and dioxin-like PCBs.
- (50) Dioxins as referred to in this Regulation cover a group of 75 polychlorinated dibenzo-p-dioxin (PCDD) congeners and 135 polychlorinated dibenzofuran (PCDF) congeners, of which 17 are of toxicological concern. Polychlorinated biphenyls (PCBs) are a group of 209 different congeners which can be divided into two groups according to their toxicological properties: 12 congeners exhibit toxicological properties similar to dioxins and are therefore often termed dioxin-like PCBs. The other PCBs do not exhibit dioxin-like toxicity but have a different toxicological profile.
- (51) Each congener of dioxins or dioxin-like PCBs exhibits a different level of toxicity. In order to be able to sum up the toxicity of these different congeners, the concept of toxic equivalency factors (TEFs) has been introduced to facilitate risk assessment and regulatory control. This means that the analytical results relating to all the individual dioxin and dioxin-like PCB congeners of toxicological concern are expressed in terms of a quantifiable unit, namely the TCDD toxic equivalent (TEQ).
- (52) Exposure estimates taking into account the SCOOP-task 'Assessment of dietary intake of dioxins and related PCBs by the population of EU Member States' finalised in June 2000 ⁽³³⁾ indicate that a considerable proportion of the Community population has a dietary intake in excess of the TWI.
- (53) From a toxicological point of view, any level set should apply to both dioxins and dioxin-like PCBs, but in 2001 maximum levels were set on Community level only for dioxins and not for dioxin-like PCBs, given the very limited data available at that time on the prevalence of dioxin-like PCBs. Since 2001, however, more data on the presence of dioxin-like PCBs have become available, therefore, maximum levels for the sum of dioxins and dioxin-like PCBs have been set in 2006 as this is the most appropriate approach from a toxicological point of view. In order to ensure a smooth transition, the levels for dioxins should continue to apply for a transitional period in addition to the levels for the sum of dioxins and dioxin-like PCBs. Foodstuffs must comply during that transitional period with the maximum levels for dioxins and with the maximum levels for the sum of dioxins and dioxin-like PCBs. Consideration will be given by 31 December 2008 to dispensing with the separate maximum levels for dioxins.
- (54) In order to encourage a proactive approach to reducing the dioxins and dioxin-like PCBs present in food and feed, action levels were set by Commission Recommendation 2006/88/EC of 6 February 2006 on the reduction of the presence of dioxins, furans and PCBs in feeding-stuffs and foodstuffs ⁽³⁴⁾. These action levels are a tool for competent authorities and operators to highlight those cases where it is appropriate to identify a source of contamination and to take measures to reduce or eliminate it. Since the sources of dioxins and dioxin-like PCBs are different, separate action levels are determined for dioxins on the one hand and for dioxin-like PCBs on the other hand. This proactive approach to actively reduce the dioxins and dioxin-like PCBs in feed and food and consequently, the maximum levels applicable should be reviewed within a defined period of time with the objective to set lower levels. Therefore, consideration will be given by 31 December 2008 to significantly reducing the maximum levels for the sum of dioxins and dioxin-like PCBs.
- (55) Operators need to make efforts to step up their capacity to remove dioxins, furans and dioxin-like PCBs from marine oil. The significant lower level, to which consideration shall be given by 31 December 2008, shall be based on the technical possibilities of the most effective decontamination procedure.
- (56) As regards the establishment of maximum levels for other foodstuffs by 31 December 2008, particular attention shall be paid to the need to set specific lower maximum levels for dioxins and dioxin-like PCBs in foods for infants and young children in the light of the monitoring data obtained through the 2005, 2006 and 2007 programmes for monitoring dioxins and dioxin-like PCBs in foods for infants and young children.

⁽³¹⁾ Opinion of the Scientific Committee on Food on the risk assessment of dioxins and dioxin-like PCBs in food. Update based on new scientific information available since the adoption of the SCF opinion of 22nd November 2000 (adopted on 30 May 2001) http://ec.europa.eu/food/fs/sc/scf/out90_en.pdf

⁽³²⁾ Opinion of the Scientific Committee on Food on the risk assessment of dioxins and dioxin-like PCBs in food. (adopted on 22 November 2000) http://ec.europa.eu/food/fs/sc/scf/out78_en.pdf

⁽³³⁾ Reports on tasks for scientific cooperation, Task 3.2.5 'Assessment of dietary intake of dioxins and related PCBs by the population of EU Member States'. http://ec.europa.eu/dgs/health_consumer/library/pub/pub08_en.pdf

⁽³⁴⁾ OJ L 42, 14.2.2006, p. 26.

- (57) As regards polycyclic aromatic hydrocarbons, the SCF concluded in its opinion of 4 December 2002⁽³⁵⁾ that a number of polycyclic aromatic hydrocarbons (PAH) are genotoxic carcinogens. The Joint FAO/WHO Expert Committee on Food Additives (JECFA) performed in 2005 a risk assessment on PAHs and estimated margins of exposure (MOE) for PAH as a basis for advice on compounds that are both genotoxic and carcinogenic⁽³⁶⁾.
- (58) According to the SCF, benzo(a)pyrene can be used as a marker for the occurrence and effect of carcinogenic PAH in food, including also benz(a)anthracene, benzo(b)fluoranthene, benzo(j)fluoranthene, benzo(k)fluoranthene, benzo(g,h,i)perylene, chrysene, cyclopenta(c,d)pyrene, dibenz(a,h)anthracene, dibenzo(a,e)pyrene, dibenzo(a,h)pyrene, dibenzo(a,i)pyrene, dibenzo(a,l)pyrene, indeno(1,2,3-cd)pyrene and 5-methylchrysene. Further analyses of the relative proportions of these PAH in foods would be necessary to inform a future review of the suitability of maintaining benzo(a)pyrene as a marker. In addition benzo(c)fluorene should be analysed, following a recommendation of JECFA.
- (59) PAH can contaminate foods during smoking processes and heating and drying processes that allow combustion products to come into direct contact with food. In addition, environmental pollution may cause contamination with PAH, in particular in fish and fishery products.
- (60) In the framework of Directive 93/5/EEC, a specific SCOOP-task 'Collection of occurrence data on PAH in food' has been performed in 2004⁽³⁷⁾. High levels were found in dried fruits, olive pomace oil, smoked fish, grape seed oil, smoked meat products, fresh molluscs, spices/sauces and condiments.
- (61) In order to protect public health, maximum levels are necessary for benzo(a)pyrene in certain foods containing fats and oils and in foods where smoking or drying processes might cause high levels of contamination. Maximum levels are also necessary in foods where environmental pollution may cause high levels of contamination, in particular in fish and fishery products, for example resulting from oil spills caused by shipping.
- (62) In some foods, such as dried fruit and food supplements, benzo(a)pyrene has been found, but available data are inconclusive on what levels are reasonably achievable. Further investigation is needed to clarify the levels that are reasonably achievable in these foods. In the meantime, maximum levels for benzo(a)pyrene in relevant ingredients should apply, such as in oils and fats used in food supplements.
- (63) The maximum levels for PAH and the appropriateness of setting a maximum level for PAH in cocoa butter should be reviewed by 1 April 2007, taking into account the progress in scientific and technological knowledge on the occurrence of benzo(a)pyrene and other carcinogenic PAH in food.
- (64) The measures provided for in this Regulation are in accordance with the opinion of the Standing Committee on the Food Chain and Animal Health,

HAS ADOPTED THIS REGULATION:

Article 1

General rules

1. The foodstuffs listed in the Annex shall not be placed on the market where they contain a contaminant listed in the Annex at a level exceeding the maximum level set out in the Annex.
2. The maximum levels specified in the Annex shall apply to the edible part of the foodstuffs concerned, unless otherwise specified in the Annex.

Article 2

Dried, diluted, processed and compound foodstuffs

1. When applying the maximum levels set out in the Annex to foodstuffs which are dried, diluted, processed or composed of more than one ingredient, the following shall be taken into account:
 - (a) changes of the concentration of the contaminant caused by drying or dilution processes;
 - (b) changes of the concentration of the contaminant caused by processing;
 - (c) the relative proportions of the ingredients in the product;
 - (d) the analytical limit of quantification.

⁽³⁵⁾ Opinion of the Scientific Committee on Food on the risks to human health of Polycyclic Aromatic Hydrocarbons in food (expressed on 4 December 2002)

http://ec.europa.eu/food/fs/sc/scf/out153_en.pdf

⁽³⁶⁾ Evaluation of certain food contaminants — Report of the Joint FAO/WHO Expert Committee on Food Additives, 64th meeting, Rome, 8 to 17 February 2005, p. 1 and p. 61.

WHO Technical Report Series, No. 930, 2006 — http://whqlibdoc.who.int/trs/WHO_TRS_930_eng.pdf

⁽³⁷⁾ Reports on tasks for scientific co-operation, Task 3.2.12 'Collection of occurrence data on polycyclic aromatic hydrocarbons in food'. http://ec.europa.eu/food/food/chemicalsafety/contaminants/scoop_3-2-12_final_report_pah_en.pdf

2. The specific concentration or dilution factors for the drying, dilution, processing and/or mixing operations concerned or for the dried, diluted, processed and/or compound foodstuffs concerned shall be provided and justified by the food business operator, when the competent authority carries out an official control.

If the food business operator does not provide the necessary concentration or dilution factor or if the competent authority deems that factor inappropriate in view of the justification given, the authority shall itself define that factor, based on the available information and with the objective of maximum protection of human health.

3. Paragraphs 1 and 2 shall apply in so far as no specific Community maximum levels are fixed for these dried, diluted, processed or compound foodstuffs.

4. As far as Community legislation does not provide for specific maximum levels for foods for infants and young children, Member States may provide for stricter levels.

Article 3

Prohibitions on use, mixing and detoxification

1. Foodstuffs not complying with the maximum levels set out in the Annex shall not be used as food ingredients.

2. Foodstuffs complying with the maximum levels set out in the Annex shall not be mixed with foodstuffs which exceed these maximum levels.

3. Foodstuffs to be subjected to sorting or other physical treatment to reduce contamination levels shall not be mixed with foodstuffs intended for direct human consumption or with foodstuffs intended for use as a food ingredient.

4. Foodstuffs containing contaminants listed in section 2 of the Annex (Mycotoxins) shall not be deliberately detoxified by chemical treatments.

Article 4

Specific provisions for groundnuts, nuts, dried fruit and maize

Groundnuts, nuts, dried fruit and maize not complying with the appropriate maximum levels of aflatoxins laid down in points 2.1.3, 2.1.5 and 2.1.6 of the Annex can be placed on the market provided that these foodstuffs:

- (a) are not intended for direct human consumption or use as an ingredient in foodstuffs;
- (b) comply with the appropriate maximum levels laid down in points 2.1.1, 2.1.2, 2.1.4 and 2.1.7 of the Annex;
- (c) are subjected to a treatment involving sorting or other physical treatment and that after this treatment the maximum levels laid down in points 2.1.3, 2.1.5 and 2.1.6 of the Annex are not exceeded, and this treatment does not result in other harmful residues;
- (d) are labelled clearly showing their use, and bearing the indication 'product shall be subjected to sorting or other physical treatment to reduce aflatoxin contamination before human consumption or use as an ingredient in foodstuffs'. The indication shall be included on the label of each individual bag, box etc. or on the original accompanying document. The consignment/batch identification code shall be indelibly marked on each individual bag, box etc. of the consignment and on the original accompanying document.

Article 5

Specific provisions for groundnuts, derived products thereof and cereals

A clear indication of the intended use must appear on the label of each individual bag, box, etc. or on the original accompanying document. This accompanying document must have a clear link with the consignment by means of mentioning the consignment identification code, which is on each individual bag, box, etc. of the consignment. In addition the business activity of the consignee of the consignment given on the accompanying document must be compatible with the intended use.

In the absence of a clear indication that their intended use is not for human consumption, the maximum levels laid down in points 2.1.3 and 2.1.6 of the Annex shall apply to all groundnuts, derived products thereof and cereals placed on the market.

Article 6

Specific provisions for lettuce

Unless lettuce grown under cover (protected lettuce) is labelled as such, maximum levels set in the Annex for lettuce grown in the open air (open-grown lettuce) shall apply.

*Article 7***Temporary derogations**

1. By way of derogation from Article 1, Belgium, Ireland, the Netherlands and the United Kingdom may authorise until 31 December 2008 the placing on the market of fresh spinach grown and intended for consumption in their territory with nitrate levels higher than the maximum levels set out in point 1.1 of the Annex.

2. By way of derogation from Article 1, Ireland and the United Kingdom may authorise until 31 December 2008 the placing on the market of fresh lettuce grown and intended for consumption in their territory and harvested throughout the year with nitrate levels higher than the maximum levels set out in point 1.3 of the Annex.

3. By way of derogation from Article 1, France may authorise until 31 December 2008 the placing on the market of fresh lettuce grown and intended for consumption in its territory and harvested from 1 October to 31 March with nitrate levels higher than the maximum levels set out in point 1.3 of the Annex.

4. By way of derogation from Article 1, Finland and Sweden may authorise until 31 December 2011 the placing on their market of salmon (*Salmo salar*), herring (*Clupea harengus*), river lamprey (*Lampetra fluviatilis*), trout (*Salmo trutta*), char (*Salvelinus* spp.) and roe of vendace (*Coregonus albula*) originating in the Baltic region and intended for consumption in their territory with levels of dioxins and/or levels of the sum of dioxins and dioxin-like PCBs higher than those set out in point 5.3 of the Annex, provided that a system is in place to ensure that consumers are fully informed of the dietary recommendations with regard to the restrictions on the consumption of these fish species from the Baltic region by identified vulnerable sections of the population in order to avoid potential health risks. By 31 March each year, Finland and Sweden shall communicate to the Commission the results of their monitoring of the levels of dioxins and dioxin-like PCBs in fish from the Baltic region obtained in the preceding year and shall report on the measures taken to reduce human exposure to dioxins and dioxin-like PCBs from fish from the Baltic region.

Finland and Sweden shall continue to apply the necessary measures to ensure that fish and fish products not complying with point 5.3 of the Annex are not marketed in other Member States.

*Article 8***Sampling and analysis**

The sampling and the analysis for the official control of the maximum levels specified in the Annex shall be performed in accordance with Commission Regulations (EC) No

1882/2006⁽³⁸⁾, No 401/2006⁽³⁹⁾, No 1883/2006⁽⁴⁰⁾ and Commission Directives 2001/22/EC⁽⁴¹⁾, 2004/16/EC⁽⁴²⁾ and 2005/10/EC⁽⁴³⁾.

*Article 9***Monitoring and reporting**

1. Member States shall monitor nitrate levels in vegetables which may contain significant levels, in particular green leaf vegetables, and communicate the results to the Commission by 30 June each year. The Commission will make these results available to the Member States.

2. Member States and interested parties shall communicate each year to the Commission the results of investigations undertaken including occurrence data and the progress with regard to the application of prevention measures to avoid contamination by ochratoxin A, deoxynivalenol, zearalenone, fumonisin B₁ and B₂, T-2 and HT-2 toxin. The Commission will make these results available to the Member States.

3. Member States should report to the Commission findings on aflatoxins, dioxins, dioxin-like PCBs, non-dioxin-like PCBs and polycyclic aromatic hydrocarbons as specified in Commission Decision 2006/504/EC⁽⁴⁴⁾, Commission Recommendation 2006/794/EC⁽⁴⁵⁾ and Commission Recommendation 2005/108/EC⁽⁴⁶⁾.

*Article 10***Repeal**

Regulation (EC) No 466/2001 is repealed.

References to the repealed Regulation shall be construed as references to this Regulation.

*Article 11***Transitional measures**

This Regulation shall not apply to products that were placed on the market before the dates referred to in points (a) to (d) in conformity with the provisions applicable at the respective date:

- (a) 1 July 2006 as regards the maximum levels for deoxynivalenol and zearalenone laid down in points 2.4.1, 2.4.2, 2.4.4, 2.4.5, 2.4.6, 2.4.7, 2.5.1, 2.5.3, 2.5.5 and 2.5.7 of the Annex;

⁽³⁸⁾ See page 25 of this Official Journal.

⁽³⁹⁾ OJ L 70, 9.3.2006, p. 12.

⁽⁴⁰⁾ See page 32 of this Official Journal.

⁽⁴¹⁾ OJ L 77, 16.3.2001, p. 14. Directive as amended by Directive 2005/4/EC (OJ L 19, 21.1.2005, p. 50).

⁽⁴²⁾ OJ L 42, 13.2.2004, p. 16.

⁽⁴³⁾ OJ L 34, 8.2.2005, p. 15.

⁽⁴⁴⁾ OJ L 199, 21.7.2006, p. 21.

⁽⁴⁵⁾ OJ L 322, 22.11.2006, p. 24.

⁽⁴⁶⁾ OJ L 34, 8.2.2005, p. 43.

(b) 1 July 2007 as regards the maximum levels for deoxyvalenol and zearalenone laid down in points 2.4.3, 2.5.2, 2.5.4, 2.5.6 and 2.5.8 of the Annex;

(c) 1 October 2007 as regards the maximum levels for fumonisins B₁ and B₂ laid down in point 2.6 of the Annex;

(d) 4 November 2006 as regards the maximum levels for the sum of dioxins and dioxin-like PCBs laid down in section 5 of the Annex.

The burden of proving when the products were placed on the market shall be borne by the food business operator.

Article 12

Entry into force and application

This Regulation shall enter into force on the 20th day following its publication in the *Official Journal of the European Union*.

It shall apply from 1 March 2007.

This Regulation shall be binding in its entirety and directly applicable in all Member States.

Done at Brussels, 19 December 2006.

For the Commission
Markos KYPRIANOU
Member of the Commission

ANNEX

Maximum levels for certain contaminants in foodstuffs ⁽¹⁾

Section 1: Nitrate

Foodstuffs ⁽¹⁾		Maximum levels (mg NO ₃ /kg)	
1.1	Fresh spinach (<i>Spinacia oleracea</i>) ⁽²⁾	Harvested 1 October to 31 March	3 000
		Harvested 1 April to 30 September	2 500
1.2	Preserved, deep-frozen or frozen spinach		2 000
1.3	Fresh Lettuce (<i>Lactuca sativa</i> L.) (protected and open-grown lettuce) excluding lettuce listed in point 1.4	Harvested 1 October to 31 March: lettuce grown under cover	4 500
		lettuce grown in the open air	4 000
		Harvested 1 April to 30 September: lettuce grown under cover	3 500
		lettuce grown in the open air	2 500
1.4	Iceberg-type lettuce	Lettuce grown under cover	2 500
		Lettuce grown in the open air	2 000
1.5	Processed cereal-based foods and baby foods for infants and young children ⁽³⁾ ⁽⁴⁾		200

Section 2: Mycotoxins

Foodstuffs ⁽¹⁾		Maximum levels (µg/kg)		
2.1	Aflatoxins	B ₁	Sum of B ₁ , B ₂ , G ₁ and G ₂	M ₁
2.1.1	Groundnuts to be subjected to sorting, or other physical treatment, before human consumption or use as an ingredient in foodstuffs	8,0 ⁽⁵⁾	15,0 ⁽⁵⁾	—
2.1.2	Nuts to be subjected to sorting, or other physical treatment, before human consumption or use as an ingredient in foodstuffs	5,0 ⁽⁵⁾	10,0 ⁽⁵⁾	—
2.1.3	Groundnuts and nuts and processed products thereof, intended for direct human consumption or use as an ingredient in foodstuffs	2,0 ⁽⁵⁾	4,0 ⁽⁵⁾	—
2.1.4	Dried fruit to be subjected to sorting, or other physical treatment, before human consumption or use as an ingredient in foodstuffs	5,0	10,0	—
2.1.5	Dried fruit and processed products thereof, intended for direct human consumption or use as an ingredient in foodstuffs	2,0	4,0	—
2.1.6	All cereals and all products derived from cereals, including processed cereal products, with the exception of foodstuffs listed in 2.1.7, 2.1.10 and 2.1.12	2,0	4,0	—
2.1.7	Maize to be subjected to sorting or other physical treatment before human consumption or use as an ingredient in foodstuffs	5,0	10,0	—
2.1.8	Raw milk ⁽⁶⁾ , heat-treated milk and milk for the manufacture of milk-based products	—	—	0,050

Foodstuffs ⁽¹⁾		Maximum levels (µg/kg)		
2.1.9	Following species of spices: <i>Capsicum</i> spp. (dried fruits thereof, whole or ground, including chillies, chilli powder, cayenne and paprika) <i>Piper</i> spp. (fruits thereof, including white and black pepper) <i>Myristica fragrans</i> (nutmeg) <i>Zingiber officinale</i> (ginger) <i>Curcuma longa</i> (turmeric)	5,0	10,0	—
2.1.10	Processed cereal-based foods and baby foods for infants and young children ⁽³⁾ ⁽⁷⁾	0,10	—	—
2.1.11	Infant formulae and follow-on formulae, including infant milk and follow-on milk ⁽⁴⁾ ⁽⁸⁾	—	—	0,025
2.1.12	Dietary foods for special medical purposes ⁽⁹⁾ ⁽¹⁰⁾ intended specifically for infants	0,10	—	0,025
2.2	Ochratoxin A			
2.2.1	Unprocessed cereals	5,0		
2.2.2	All products derived from unprocessed cereals, including processed cereal products and cereals intended for direct human consumption with the exception of foodstuffs listed in 2.2.9 and 2.2.10	3,0		
2.2.3	Dried vine fruit (currants, raisins and sultanas)	10,0		
2.2.4	Roasted coffee beans and ground roasted coffee, excluding soluble coffee	5,0		
2.2.5	Soluble coffee (instant coffee)	10,0		
2.2.6	Wine (including sparkling wine, excluding liqueur wine and wine with an alcoholic strength of not less than 15 % vol) and fruit wine ⁽¹¹⁾	2,0 ⁽¹²⁾		
2.2.7	Aromatised wine, aromatised wine-based drinks and aromatised wine-product cocktails ⁽¹³⁾	2,0 ⁽¹²⁾		
2.2.8	Grape juice, concentrated grape juice as reconstituted, grape nectar, grape must and concentrated grape must as reconstituted, intended for direct human consumption ⁽¹⁴⁾	2,0 ⁽¹²⁾		
2.2.9	Processed cereal-based foods and baby foods for infants and young children ⁽³⁾ ⁽⁷⁾	0,50		
2.2.10	Dietary foods for special medical purposes ⁽⁹⁾ ⁽¹⁰⁾ intended specifically for infants	0,50		
2.2.11	Green coffee, dried fruit other than dried vine fruit, beer, cocoa and cocoa products, liqueur wines, meat products, spices and liquorice	—		
2.3	Patulin			
2.3.1	Fruit juices, concentrated fruit juices as reconstituted and fruit nectars ⁽¹⁴⁾	50		

	Foodstuffs ⁽¹⁾	Maximum levels (µg/kg)
2.3.2	Spirit drinks ⁽¹⁵⁾ , cider and other fermented drinks derived from apples or containing apple juice	50
2.3.3	Solid apple products, including apple compote, apple puree intended for direct consumption with the exception of foodstuffs listed in 2.3.4 and 2.3.5	25
2.3.4	Apple juice and solid apple products, including apple compote and apple puree, for infants and young children ⁽¹⁶⁾ and labelled and sold as such ⁽⁴⁾	10,0
2.3.5	Baby foods other than processed cereal-based foods for infants and young children ⁽³⁾ ⁽⁴⁾	10,0
2.4	Deoxynivalenol ⁽¹⁷⁾	
2.4.1	Unprocessed cereals ⁽¹⁸⁾ ⁽¹⁹⁾ other than durum wheat, oats and maize	1 250
2.4.2	Unprocessed durum wheat and oats ⁽¹⁸⁾ ⁽¹⁹⁾	1 750
2.4.3	Unprocessed maize ⁽¹⁸⁾	1 750 ⁽²⁰⁾
2.4.4	Cereals intended for direct human consumption, cereal flour (including maize flour, maize meal and maize grits ⁽²¹⁾), bran as end product marketed for direct human consumption and germ, with the exception of foodstuffs listed in 2.4.7	750
2.4.5	Pasta (dry) ⁽²²⁾	750
2.4.6	Bread (including small bakery wares), pastries, biscuits, cereal snacks and breakfast cereals	500
2.4.7	Processed cereal-based foods and baby foods for infants and young children ⁽³⁾ ⁽⁷⁾	200
2.5	Zearalenone ⁽¹⁷⁾	
2.5.1	Unprocessed cereals ⁽¹⁸⁾ ⁽¹⁹⁾ other than maize	100
2.5.2	Unprocessed maize ⁽¹⁸⁾	200 ⁽²⁰⁾
2.5.3	Cereals intended for direct human consumption, cereal flour, bran as end product marketed for direct human consumption and germ, with the exception of foodstuffs listed in 2.5.4, 2.5.7 and 2.5.8	75
2.5.4	Maize intended for direct human consumption, maize flour, maize meal, maize grits, maize germ and refined maize oil ⁽²¹⁾	200 ⁽²⁰⁾
2.5.5	Bread (including small bakery wares), pastries, biscuits, cereal snacks and breakfast cereals, excluding maize snacks and maize based breakfast cereals	50
2.5.6	Maize snacks and maize based breakfast cereals	50 ⁽²⁰⁾

Foodstuffs ⁽¹⁾		Maximum levels (µg/kg)
2.5.7	Processed cereal-based foods (excluding processed maize-based foods) and baby foods for infants and young children ⁽³⁾ ⁽⁷⁾	20
2.5.8	Processed maize-based foods for infants and young children ⁽³⁾ ⁽⁷⁾	20 ⁽²⁰⁾
2.6	Fumonisin	Sum of B ₁ and B ₂
2.6.1	Unprocessed maize ⁽¹⁸⁾	2 000 ⁽²³⁾
2.6.2	Maize flour, maize meal, maize grits, maize germ and refined maize oil ⁽²¹⁾	1 000 ⁽²³⁾
2.6.3	Maize based foods for direct human consumption, excluding foods listed in 2.6.2 and 2.6.4	400 ⁽²³⁾
2.6.4	Processed maize-based foods and baby foods for infants and young children ⁽³⁾ ⁽⁷⁾	200 ⁽²³⁾
2.7	T-2 and HT-2 toxin ⁽¹⁷⁾	Sum of T-2 and HT-2 toxin
2.7.1	Unprocessed cereals ⁽¹⁸⁾ and cereal products	

Section 3: Metals

Foodstuffs ⁽¹⁾		Maximum levels (mg/kg wet weight)
3.1	Lead	
3.1.1	Raw milk ⁽⁶⁾ , heat-treated milk and milk for the manufacture of milk-based products	0,020
3.1.2	Infant formulae and follow-on formulae ⁽⁴⁾ ⁽⁸⁾	0,020
3.1.3	Meat (excluding offal) of bovine animals, sheep, pig and poultry ⁽⁶⁾	0,10
3.1.4	Offal of bovine animals, sheep, pig and poultry ⁽⁶⁾	0,50
3.1.5	Muscle meat of fish ⁽²⁴⁾ ⁽²⁵⁾	0,30
3.1.6	Crustaceans, excluding brown meat of crab and excluding head and thorax meat of lobster and similar large crustaceans (<i>Nephropidae</i> and <i>Palinuridae</i>) ⁽²⁶⁾	0,50
3.1.7	Bivalve molluscs ⁽²⁶⁾	1,5
3.1.8	Cephalopods (without viscera) ⁽²⁶⁾	1,0
3.1.9	Cereals, legumes and pulses	0,20
3.1.10	Vegetables, excluding brassica vegetables, leaf vegetables, fresh herbs and fungi ⁽²⁷⁾ . For potatoes the maximum level applies to peeled potatoes	0,10

	Foodstuffs ⁽¹⁾	Maximum levels (mg/kg wet weight)
3.1.11	Brassica vegetables, leaf vegetables and cultivated fungi ⁽²⁷⁾	0,30
3.1.12	Fruit, excluding berries and small fruit ⁽²⁷⁾	0,10
3.1.13	Berries and small fruit ⁽²⁷⁾	0,20
3.1.14	Fats and oils, including milk fat	0,10
3.1.15	Fruit juices, concentrated fruit juices as reconstituted and fruit nectars ⁽¹⁴⁾	0,050
3.1.16	Wine (including sparkling wine, excluding liqueur wine), cider, perry and fruit wine ⁽¹¹⁾	0,20 ⁽²⁸⁾
3.1.17	Aromatized wine, aromatized wine-based drinks and aromatized wine-product cocktails ⁽¹³⁾	0,20 ⁽²⁸⁾
3.2	Cadmium	
3.2.1	Meat (excluding offal) of bovine animals, sheep, pig and poultry ⁽⁶⁾	0,050
3.2.2	Horsemeat, excluding offal ⁽⁶⁾	0,20
3.2.3	Liver of bovine animals, sheep, pig, poultry and horse ⁽⁶⁾	0,50
3.2.4	Kidney of bovine animals, sheep, pig, poultry and horse ⁽⁶⁾	1,0
3.2.5	Muscle meat of fish ⁽²⁴⁾ ⁽²⁵⁾ , excluding species listed in 3.2.6 and 3.2.7	0,050
3.2.6	Muscle meat of the following fish ⁽²⁴⁾ ⁽²⁵⁾ : anchovy (<i>Engraulis species</i>) bonito (<i>Sarda sarda</i>) common two-banded seabream (<i>Diplodus vulgaris</i>) eel (<i>Anguilla anguilla</i>) grey mullet (<i>Mugil labrosus labrosus</i>) horse mackerel or scad (<i>Trachurus species</i>) louvar or luvar (<i>Luvarus imperialis</i>) sardine (<i>Sardina pilchardus</i>) sardinops (<i>Sardinops species</i>) tuna (<i>Thunnus species</i> , <i>Euthynnus species</i> , <i>Katsuwonus pelamis</i>) wedge sole (<i>Dicologlossa cuneata</i>)	0,10
3.2.7	Muscle meat of swordfish (<i>Xiphias gladius</i>) ⁽²⁴⁾ ⁽²⁵⁾	0,30
3.2.8	Crustaceans, excluding brown meat of crab and excluding head and thorax meat of lobster and similar large crustaceans (<i>Nephropidae</i> and <i>Palinuridae</i>) ⁽²⁶⁾	0,50
3.2.9	Bivalve molluscs ⁽²⁶⁾	1,0
3.2.10	Cephalopods (without viscera) ⁽²⁶⁾	1,0

Foodstuffs ⁽¹⁾		Maximum levels (mg/kg wet weight)
3.2.11	Cereals excluding bran, germ, wheat and rice	0,10
3.2.12	Bran, germ, wheat and rice	0,20
3.2.13	Soybeans	0,20
3.2.14	Vegetables and fruit, excluding leaf vegetables, fresh herbs, fungi, stem vegetables, pine nuts, root vegetables and potatoes ⁽²⁷⁾	0,050
3.2.15	Leaf vegetables, fresh herbs, cultivated fungi and celeriac ⁽²⁷⁾	0,20
3.2.16	Stem vegetables, root vegetables and potatoes, excluding celeriac ⁽²⁷⁾ . For potatoes the maximum level applies to peeled potatoes	0,10
3.3	Mercury	
3.3.1	Fishery products ⁽²⁶⁾ and muscle meat of fish ⁽²⁴⁾ ⁽²⁵⁾ , excluding species listed in 3.3.2. The maximum level applies to crustaceans, excluding the brown meat of crab and excluding head and thorax meat of lobster and similar large crustaceans (<i>Nephropidae</i> and <i>Palinuridae</i>)	0,50
3.3.2	Muscle meat of the following fish ⁽²⁴⁾ ⁽²⁵⁾ : anglerfish (<i>Lophius species</i>) atlantic catfish (<i>Anarhichas lupus</i>) bonito (<i>Sarda sarda</i>) eel (<i>Anguilla species</i>) emperor, orange roughy, rosy soldierfish (<i>Hoplostethus species</i>) grenadier (<i>Coryphaenoides rupestris</i>) halibut (<i>Hippoglossus hippoglossus</i>) marlin (<i>Makaira species</i>) megrin (<i>Lepidorhombus species</i>) mullet (<i>Mullus species</i>) pike (<i>Esox lucius</i>) plain bonito (<i>Orcynopsis unicolor</i>) poor cod (<i>Tricopterus minutes</i>) portuguese dogfish (<i>Centroscyrnus coelolepis</i>) rays (<i>Raja species</i>) redfish (<i>Sebastes marinus</i> , <i>S. mentella</i> , <i>S. viviparus</i>) sail fish (<i>Istiophorus platypterus</i>) scabbard fish (<i>Lepidopus caudatus</i> , <i>Aphanopus carbo</i>) seabream, pandora (<i>Pagellus species</i>) shark (all species) snake mackerel or butterfish (<i>Lepidocybium flavobrunneum</i> , <i>Ruvettus pretiosus</i> , <i>Gempylus serpens</i>) sturgeon (<i>Acipenser species</i>) swordfish (<i>Xiphias gladius</i>) tuna (<i>Thunnus species</i> , <i>Euthynnus species</i> , <i>Katsuwonus pelamis</i>)	1,0
3.4	Tin (inorganic)	
3.4.1	Canned foods other than beverages	200
3.4.2	Canned beverages, including fruit juices and vegetable juices	100

Foodstuffs ⁽¹⁾		Maximum levels (mg/kg wet weight)
3.4.3	Canned baby foods and processed cereal-based foods for infants and young children, excluding dried and powdered products ⁽³⁾ ⁽²⁹⁾	50
3.4.4	Canned infant formulae and follow-on formulae (including infant milk and follow-on milk), excluding dried and powdered products ⁽⁸⁾ ⁽²⁹⁾	50
3.4.5	Canned dietary foods for special medical purposes ⁽⁹⁾ ⁽²⁹⁾ intended specifically for infants, excluding dried and powdered products	50

Section 4: 3-monochloropropane-1,2-diol (3-MCPD)

Foodstuffs ⁽¹⁾		Maximum levels (µg/kg)
4.1	Hydrolysed vegetable protein ⁽³⁰⁾	20
4.2	Soy sauce ⁽³⁰⁾	20

Section 5: Dioxins and PCBs ⁽³¹⁾

Foodstuffs		Maximum levels	
		Sum of dioxins (WHO-PCDD/F-TEQ) ⁽³²⁾	Sum of dioxins and dioxin-like PCBs (WHO-PCDD/F-PCB-TEQ) ⁽³²⁾
5.1	Meat and meat products (excluding edible offal) of the following animals ⁽⁶⁾		
	— bovine animals and sheep	3,0 pg/g fat ⁽³³⁾	4,5 pg/g fat ⁽³³⁾
	— poultry	2,0 pg/g fat ⁽³³⁾	4,0 pg/g fat ⁽³³⁾
	— pigs	1,0 pg/g fat ⁽³³⁾	1,5 pg/g fat ⁽³³⁾
5.2	Liver of terrestrial animals referred to in 5.1 ⁽⁶⁾ , and derived products thereof	6,0 pg/g fat ⁽³³⁾	12,0 pg/g fat ⁽³³⁾
5.3	Muscle meat of fish and fishery products and products thereof, excluding eel ⁽²⁵⁾ ⁽³⁴⁾ . The maximum level applies to crustaceans, excluding the brown meat of crab and excluding head and thorax meat of lobster and similar large crustaceans (<i>Nephropidae</i> and <i>Palinuridae</i>)	4,0 pg/g wet weight	8,0 pg/g wet weight
5.4	Muscle meat of eel (<i>Anguilla anguilla</i>) and products thereof	4,0 pg/g wet weight	12,0 pg/g wet weight
5.5	Raw milk ⁽⁶⁾ and dairy products ⁽⁶⁾ , including butterfat	3,0 pg/g fat ⁽³³⁾	6,0 pg/g fat ⁽³³⁾

Foodstuffs		Maximum levels	
		Sum of dioxins (WHO-PCDD/F-TEQ) ⁽³²⁾	Sum of dioxins and dioxin-like PCBs (WHO-PCDD/F-PCB-TEQ) ⁽³²⁾
5.6	Hen eggs and egg products ⁽⁶⁾	3,0 pg/g fat ⁽³³⁾	6,0 pg/g fat ⁽³³⁾
5.7	Fat of the following animals:		
	— bovine animals and sheep	3,0 pg/g fat	4,5 pg/g fat
	— poultry	2,0 pg/g fat	4,0 pg/g fat
	— pigs	1,0 pg/g fat	1,5 pg/g fat
5.8	Mixed animal fats	2,0 pg/g fat	3,0 pg/g fat
5.9	Vegetable oils and fats	0,75 pg/g fat	1,5 pg/g fat
5.10	Marine oils (fish body oil, fish liver oil and oils of other marine organisms intended for human consumption)	2,0 pg/g fat	10,0 pg/g fat

Section 6: Polycyclic aromatic hydrocarbons

Foodstuffs		Maximum levels (µg/kg wet weight)
6.1	Benzo(a)pyrene ⁽³⁵⁾	
6.1.1	Oils and fats (excluding cocoa butter) intended for direct human consumption or use as an ingredient in foods	2,0
6.1.2	Smoked meats and smoked meat products	5,0
6.1.3	Muscle meat of smoked fish and smoked fishery products ⁽²⁵⁾ ⁽³⁶⁾ , excluding bivalve molluscs. The maximum level applies to smoked crustaceans, excluding the brown meat of crab and excluding head and thorax meat of lobster and similar large crustaceans (<i>Nephropidae</i> and <i>Palinuridae</i>)	5,0
6.1.4	Muscle meat of fish ⁽²⁴⁾ ⁽²⁵⁾ , other than smoked fish	2,0
6.1.5	Crustaceans, cephalopods, other than smoked ⁽²⁶⁾ . The maximum level applies to crustaceans, excluding the brown meat of crab and excluding head and thorax meat of lobster and similar large crustaceans (<i>Nephropidae</i> and <i>Palinuridae</i>)	5,0
6.1.6	Bivalve molluscs ⁽²⁶⁾	10,0
6.1.7	Processed cereal-based foods and baby foods for infants and young children ⁽³⁾ ⁽²⁹⁾	1,0
6.1.8	Infant formulae and follow-on formulae, including infant milk and follow-on milk ⁽⁸⁾ ⁽²⁹⁾	1,0
6.1.9	Dietary foods for special medical purposes ⁽⁹⁾ ⁽²⁹⁾ intended specifically for infants	1,0

- (¹) As regards fruits, vegetables and cereals, reference is made to the foodstuffs listed in the relevant category as defined in Regulation (EC) No 396/2005 of the European Parliament and of the Council of 23 February 2005 on maximum residue levels of pesticides in or on food and feed of plant and animal origin and amending Council Directive 91/414/EEC (OJ L 70, 16.3.2005, p. 1) as last amended by Regulation (EC) No 178/2006 (OJ L 29, 2.2.2006, p. 3). This means, *inter alia*, that buckwheat (*Fagopyrum* sp) is included in 'cereals' and buckwheat products are included in 'cereal products'.
- (²) The maximum levels do not apply for fresh spinach to be subjected to processing and which is directly transported in bulk from field to processing plant.
- (³) Foodstuffs listed in this category as defined in Commission Directive 96/5/EC of 16 February 1996 on processed cereal-based foods and baby foods for infants and young children (OJ L 49, 28.2.1996, p. 17) as last amended by Directive 2003/13/EC (OJ L 41, 14.2.2003, p. 33).
- (⁴) The maximum level refers to the products ready to use (marketed as such or after reconstitution as instructed by the manufacturer).
- (⁵) The maximum levels refer to the edible part of groundnuts and nuts. If groundnuts and nuts 'in shell' are analysed, it is assumed when calculating the aflatoxin content all the contamination is on the edible part.
- (⁶) Foodstuffs listed in this category as defined in Regulation (EC) No 853/2004 of the European Parliament and of the Council of 29 April 2004 laying down specific hygiene rules for food of animal origin (OJ L 226, 25.6.2004, p. 22).
- (⁷) The maximum level refers to the dry matter. The dry matter is determined in accordance with Regulation (EC) No 401/2006.
- (⁸) Foodstuffs listed in this category as defined in Commission Directive 91/321/EEC of 14 May 1991 on infant formulae and follow-on formulae (OJ L 175, 4.7.1991, p. 35) as last amended by Directive 2003/14/EC (OJ L 41, 14.2.2003, p. 37).
- (⁹) Foodstuffs listed in this category as defined in Commission Directive 1999/21/EC of 25 March 1999 on dietary foods for special medical purposes (OJ L 91, 7.4.1999, p. 29).
- (¹⁰) The maximum level refers in the case of milk and milk products, to the products ready for use (marketed as such or reconstituted as instructed by the manufacturer) and in the case of products other than milk and milk products, to the dry matter. The dry matter is determined in accordance with Regulation (EC) No 401/2006.
- (¹¹) Foodstuffs listed in this category as defined in Council Regulation (EC) No 1493/1999 of 17 May 1999 on the common organisation of the market in wine (OJ L 179, 14.7.1999, p. 1) as last amended by the Protocol concerning the conditions and arrangements for admission of the Republic of Bulgaria and Romania to the European Union (OJ L 157, 21.6.2005, p. 29).
- (¹²) The maximum level applies to products produced from the 2005 harvest onwards.
- (¹³) Foodstuffs listed in this category as defined in Council Regulation (EEC) No 1601/91 of 10 June 1991 laying down general rules on the definition, description and presentation of aromatised wines, aromatised wine-based drinks and aromatised wine-product cocktails (OJ L 149, 14.6.1991, p. 1) as last amended by the Protocol concerning the conditions and arrangements for admission of the Republic of Bulgaria and Romania to the European Union. The maximum level for OTA applicable to these beverages is function of the proportion of wine and/or grape must present in the finished product.
- (¹⁴) Foodstuffs listed in this category as defined in Council Directive 2001/112/EC of 20 December 2001 relating to fruit juices and certain similar products intended for human consumption (OJ L 10, 12.1.2002, p. 58).
- (¹⁵) Foodstuffs listed in this category as defined in Council Regulation (EEC) No 1576/89 of 29 May 1989 laying down general rules on the definition, description and presentation of spirit drinks (OJ L 160, 12.6.1989, p. 1), as last amended by the Protocol concerning the conditions and arrangements for admission of the Republic of Bulgaria and Romania to the European Union.
- (¹⁶) Infants and young children as defined in Directive 91/321/EEC and Directive 96/5/EC.
- (¹⁷) For the purpose of the application of maximum levels for deoxynivalenol, zearalenone, T-2 and HT-2 toxin established in points 2.4, 2.5 and 2.7 rice is not included in 'cereals' and rice products are not included in 'cereal products'.
- (¹⁸) The maximum level applies to unprocessed cereals placed on the market for first-stage processing. 'First-stage processing' shall mean any physical or thermal treatment, other than drying, of or on the grain. Cleaning, sorting and drying procedures are not considered to be 'first-stage processing' insofar no physical action is exerted on the grain kernel itself and the whole grain remains intact after cleaning and sorting. In integrated production and processing systems, the maximum level applies to the unprocessed cereals in case they are intended for first-stage processing.
- (¹⁹) The maximum level applies to cereals harvested and taken over, as from the 2005/06 marketing year, in accordance with Commission Regulation (EC) No 824/2000 of 19 April 2000 establishing procedures for the taking-over of cereals by intervention agencies and laying down methods of analysis for determining the quality of cereals (OJ L 100, 20.4.2000, p. 31), as last amended by Regulation (EC) No 1068/2005 (OJ L 174, 7.7.2005, p. 65).
- (²⁰) Maximum level shall apply from 1 July 2007.
- (²¹) This category includes also similar products otherwise denominated such as semolina.
- (²²) Pasta (dry) means pasta with a water content of approximately 12 %.

- (23) Maximum level shall apply from 1 October 2007.
- (24) Fish listed in this category as defined in category (a), with the exclusion of fish liver falling under code CN 0302 70 00, of the list in Article 1 of Council Regulation (EC) No 104/2000 (OJ L 17, 21.1.2000, p. 22) as last amended by the Act concerning the conditions of accession of the Czech Republic, the Republic of Estonia, the Republic of Cyprus, the Republic of Latvia, the Republic of Lithuania, the Republic of Hungary, the Republic of Malta, the Republic of Poland, the Republic of Slovenia and the Slovak Republic and the adjustments to the Treaties on which the European Union is founded (OJ L 236, 23.9.2003, p. 33). In case of dried, diluted, processed and/or compound foodstuffs Article 2(1) and 2(2) apply.
- (25) Where fish are intended to be eaten whole, the maximum level shall apply to the whole fish.
- (26) Foodstuffs falling within category (c) and (f) of the list in Article 1 of Regulation (EC) No 104/2000, as appropriate (species as listed in the relevant entry). In case of dried, diluted, processed and/or compound foodstuffs Article 2(1) and 2(2) apply.
- (27) The maximum level applies after washing of the fruit or vegetables and separating the edible part.
- (28) The maximum level applies to products produced from the 2001 fruit harvest onwards.
- (29) The maximum level refers to the product as sold.
- (30) The maximum level is given for the liquid product containing 40 % dry matter, corresponding to a maximum level of 50 µg/kg in the dry matter. The level needs to be adjusted proportionally according to the dry matter content of the products.
- (31) Dioxins (sum of polychlorinated dibenzo-para-dioxins (PCDDs) and polychlorinated dibenzofurans (PCDFs), expressed as World Health Organisation (WHO) toxic equivalent using the WHO-toxic equivalency factors (WHO-TEFs)) and sum of dioxins and dioxin-like PCBs (sum of PCDDs, PCDFs and polychlorinated biphenyls (PCBs), expressed as WHO toxic equivalent using the WHO-TEFs). WHO-TEFs for human risk assessment based on the conclusions of the WHO meeting in Stockholm, Sweden, 15 to 18 June 1997 (Van den Berg et al., (1998) Toxic Equivalency Factors (TEFs) for PCBs, PCDDs, PCDFs for Humans and for Wildlife. Environmental Health Perspectives, 106 (12), 775).

Congener	TEF value	Congener	TEF value
Dibenzo-p-dioxins (PCDDs)		Dioxin-like PCBs: Non-ortho PCBs + Mono-ortho PCBs	
2,3,7,8-TCDD	1	<i>Non-ortho PCBs</i>	
1,2,3,7,8-PeCDD	1	PCB 77	0,0001
1,2,3,4,7,8-HxCDD	0,1	PCB 81	0,0001
1,2,3,6,7,8-HxCDD	0,1	PCB 126	0,1
1,2,3,7,8,9-HxCDD	0,1	PCB 169	0,01
1,2,3,4,6,7,8-HpCDD	0,01		
OCDD	0,0001	<i>Mono-ortho PCBs</i>	
Dibenzofurans (PCDFs)		PCB 105	0,0001
2,3,7,8-TCDF	0,1	PCB 114	0,0005
1,2,3,7,8-PeCDF	0,05	PCB 118	0,0001
2,3,4,7,8-PeCDF	0,5	PCB 123	0,0001
1,2,3,4,7,8-HxCDF	0,1	PCB 156	0,0005
1,2,3,6,7,8-HxCDF	0,1	PCB 157	0,0005
1,2,3,7,8,9-HxCDF	0,1	PCB 167	0,00001
2,3,4,6,7,8-HxCDF	0,1	PCB 189	0,0001
1,2,3,4,6,7,8-HpCDF	0,01		
1,2,3,4,7,8,9-HpCDF	0,01		
OCDF	0,0001		

Abbreviations used: 'T' = tetra; 'Pe' = penta; 'Hx' = hexa; 'Hp' = hepta; 'O' = octa; 'CDD' = chlorodibenzodioxin; 'CDF' = chlorodibenzofuran; 'CB' = chlorobiphenyl.

- (32) Upperbound concentrations: Upperbound concentrations are calculated on the assumption that all the values of the different congeners below the limit of quantification are equal to the limit of quantification.
- (33) The maximum level is not applicable for foods containing < 1 % fat.
- (34) Foodstuffs listed in this category as defined in categories (a), (b), (c), (e) and (f) of the list in Article 1 of Regulation (EC) No 104/2000 with the exclusion of fish liver falling under code CN 0302 70 00.
- (35) Benzo(a)pyrene, for which maximum levels are listed, is used as a marker for the occurrence and effect of carcinogenic polycyclic aromatic hydrocarbons. These measures therefore provide full harmonisation on polycyclic aromatic hydrocarbons in the listed foods across the Member States.
- (36) Foodstuffs listed in this category as defined in categories (b), (c), and (f) of the list in Article 1 of Regulation (EC) No 104/2000.

Annex II:

Official Journal of the European Union

**COMMISSION REGULATION (EU) No 835/2011
of 19 August 2011**

**amending Regulation (EC) No 1881/2006 as regards maximum levels for polycyclic aromatic
hydrocarbons in foodstuffs**

COMMISSION REGULATION (EU) No 835/2011

of 19 August 2011

amending Regulation (EC) No 1881/2006 as regards maximum levels for polycyclic aromatic hydrocarbons in foodstuffs

(Text with EEA relevance)

THE EUROPEAN COMMISSION,

Having regard to the Treaty on the Functioning of the European Union,

Having regard to Council Regulation (EEC) No 315/93 of 8 February 1993 laying down Community procedures for contaminants in food ⁽¹⁾, and in particular Article 2(3) thereof,

Whereas:

- (1) Commission Regulation (EC) No 1881/2006 setting maximum levels for certain contaminants in foodstuffs ⁽²⁾ sets maximum levels for benzo(a)pyrene in a range of foodstuffs.
- (2) Benzo(a)pyrene belongs to the group of polycyclic aromatic hydrocarbons (PAH) and is used as a marker for the occurrence and effect of carcinogenic PAH in food based on a scientific opinion of the former Scientific Committee on Food (SCF) ⁽³⁾. In its opinion of December 2002, the SCF recommended that further analyses of the relative proportions of these PAH in foods would be necessary for a future review of the suitability of maintaining benzo(a)pyrene as a marker.
- (3) New data on occurrence of carcinogenic PAH in foodstuffs have been collected by the Member States in the framework of Commission Recommendation 2005/108/EC ⁽⁴⁾. The Commission asked the European Food Safety Authority (EFSA) to review the SCF opinion taking into account the new occurrence data, other relevant new scientific information as well as the Margin of Exposure (MOE) approach. Within this review, EFSA was asked to re-assess the suitability of maintaining benzo(a)pyrene as a marker.
- (4) The Scientific Panel on Contaminants in the Food Chain (CONTAM Panel) of EFSA adopted an opinion on Poly-

cyclic Aromatic Hydrocarbons in Food on 9 June 2008 ⁽⁵⁾. In this opinion EFSA concluded that benzo(a)pyrene is not a suitable marker for the occurrence of polycyclic aromatic hydrocarbons in food and that a system of four specific substances (PAH4 ⁽⁶⁾) or eight specific substances (PAH8 ⁽⁷⁾) would be the most suitable indicators of PAH in food. EFSA also concluded that a system of eight substances (PAH8) would not provide much added value compared to a system of four substances (PAH4).

- (5) Furthermore, the CONTAM Panel concluded, using the Margin of Exposure (MOE) approach, that there is low concern for consumer health at the average estimated dietary exposures. However, for high level consumers the MOEs were close to or less than 10 000, which indicates a potential concern for consumer health.
- (6) Based on the conclusions of EFSA, the current system of using benzo(a)pyrene as the only marker for the group of polycyclic aromatic hydrocarbons, can not be maintained. An amendment of Regulation (EC) No 1881/2006 is therefore necessary.
- (7) New maximum levels for the sum of four substances (PAH4) (benzo(a)pyrene, benz(a)anthracene, benzo(b)fluoranthene and chrysene) should be introduced, whilst maintaining a separate maximum level for benzo(a)pyrene.
- (8) Such system would ensure that PAH levels in food are kept at levels that do not cause health concern and that the amount of PAH can also be controlled in those samples in which benzo(a)pyrene is not detectable, but where other PAH are present.
- (9) The separate maximum level for benzo(a)pyrene is maintained to ensure comparability of previous and future data. After a certain time of implementation of this amendment and on basis of new data that will be generated in future, the need for retaining a separate maximum level for benzo(a) pyrene should be re-assessed.

⁽¹⁾ OJ L 37, 13.2.1993, p. 1.

⁽²⁾ OJ L 364, 20.12.2006, p. 5.

⁽³⁾ Opinion of the Scientific Committee on Food on the risks to human health of Polycyclic Aromatic Hydrocarbons in food (expressed on 4 December 2002).

http://ec.europa.eu/food/fs/sc/scf/out153_en.pdf

⁽⁴⁾ OJ L 34, 8.2.2005, p. 43.

⁽⁵⁾ *The EFSA Journal* (2008) 724, 1-114.

⁽⁶⁾ Benzo(a)pyrene, Chrysene, Benz(a)anthracene, benzo(b)fluoranthene.

⁽⁷⁾ Benzo(a)pyrene, Chrysene, Benz(a)anthracene, benzo(b)fluoranthene, benzo(k)fluoranthene, benzo(g,h,i)perylene, dibenz(a,h)anthracene and indeno(1,2,3-c,d)pyrene.

- (10) As regards the sum of the four substances (PAH4), lower bound concentrations should be used as the basis for compliance decisions.
- (11) Maximum levels for polycyclic aromatic hydrocarbons must be safe and as low as reasonably achievable (ALARA) based upon good manufacturing and agricultural/fishery practices. The new PAH occurrence data show that background levels of PAH are lower than previously thought in some food commodities. Benzo(a)pyrene maximum levels have therefore been adapted to reflect more realistic lower background levels in fresh and smoked bivalve molluscs.
- (12) Data for smoked fish and smoked meat have also shown that lower maximum levels are achievable. Nevertheless, adaptations of current smoking technology may be necessary in some cases. Therefore, a two step procedure should be established for smoked meat and smoked fish which grants a transition of two years from the date of application of this Regulation before lower maximum levels become applicable.
- (13) Smoked sprats and canned smoked sprats have been found to contain higher levels of PAH than other smoked fish. Specific maximum levels should be established for smoked sprats and canned smoked sprats in order to reflect what is achievable in these foodstuffs.
- (14) Previously a maximum level for benzo(a)pyrene in "muscle meat of fish other than smoked fish" was established as an indicator for potential environmental pollution. Nevertheless, it has been shown that PAH are quickly metabolised in fresh fish and do not accumulate in the muscle meat. Therefore, maintaining a maximum level for PAH in fresh fish is no longer appropriate.
- (15) High levels of PAH have been found in some types of heat treated meat and heat treated meat products sold to the final consumer. These levels are avoidable if appropriate processing conditions and equipment are used. It is therefore appropriate to establish maximum levels for PAH in meat and meat products that have undergone a heat treatment process known to potentially result in formation of PAH, i.e. only grilling and barbecuing.
- (16) Cocoa butter was temporarily exempted from the existing maximum level for benzo(a)pyrene in oils and fats under Regulation (EC) No 1881/2006 and a review of the appropriateness of setting a maximum level for PAH in cocoa butter was foreseen by 1 April 2007. The review was then postponed pending the result of the then ongoing scientific re-assessment of PAH by EFSA.
- (17) Cocoa butter contains higher levels of PAH than other oils and fats. This is mainly due to inappropriate drying practices of the cocoa beans and the fact that cocoa butter can not be refined as other vegetable oils and fats. Cocoa butter is a main constituent of cocoa raw products (e.g. cocoa beans, cocoa mass, cocoa nibs or cocoa liquor) and is present in chocolate and other cocoa products often consumed by children. It thereby contributes to human exposure, in particular to exposure of children. It is therefore necessary to establish maximum levels for PAH in cocoa beans and derived products, thereby also including cocoa butter.
- (18) Maximum levels for PAH in cocoa beans should be established at levels as low as reasonably achievable and taking into account the current technological possibilities of producing countries. They should be established on a fat basis since PAH concentrate in the fat fraction, the cocoa butter. To allow producing countries to make technological improvements in order to adapt to these maximum levels, the date of application of the maximum levels for cocoa beans and derived products should be deferred. Furthermore, initially a higher maximum level for the sum of the four substances should apply to these products. After a transition period of two years a lower maximum level should apply. The levels of PAH in cocoa beans and derived products should be regularly monitored with a view to assessing the possibility for further decreasing the maximum levels in future.
- (19) Data have shown that coconut oil can contain higher amounts of PAH4 than other vegetable oils and fats. This is due to the proportionally higher presence of benz(a)anthracene and chrysene which can not be easily removed during refinement of coconut oil. Specific maximum levels for coconut oil should therefore be set at levels as low as reasonably achievable and taking into account the current technological possibilities of producing countries. As technological improvements in producing countries are expected, the levels of PAH in coconut oil should be regularly monitored with a view to assessing the possibility for setting lower levels in future.
- (20) Current occurrence data on PAH in cereals and vegetables are limited. The available data indicate that cereals and vegetables contain rather low levels of PAH. The low levels seen in the currently available occurrence data do not justify the immediate setting of maximum levels. Nevertheless, EFSA identified cereals and vegetables as being important contributors to human exposure due to their high consumption. Therefore, PAH levels in these two product groups should be further monitored. On the basis of further data, the need for setting maximum levels will be evaluated.

- (21) High levels of PAH have been found in some food supplements. Nevertheless, the levels are variable and depend on the specific type of food supplements. Further data on food supplements are needed and should be collected. Once these data become available, the need for setting maximum levels for PAH in food supplements will be evaluated.
- (22) Member States and food business operators should be allowed time to adapt to the maximum levels established by this Regulation. The date of application of this Regulation should therefore be deferred. A transitional period should be provided for the products already placed on the market before the date of application of the amendments introduced by this Regulation.
- (23) The measures provided for in this Regulation are in accordance with the opinion of the Standing Committee on the Food Chain and Animal Health and neither the European Parliament nor the Council have opposed them,

HAS ADOPTED THIS REGULATION:

Article 1

The Annex to Regulation (EC) No 1881/2006 is amended in accordance with the Annex to this Regulation.

Article 2

1. Foodstuffs not complying with the maximum levels applicable from 1 September 2012 pursuant to Section 6 "Polycyclic aromatic hydrocarbons" of the Annex to Regulation (EC) No 1881/2006, as amended by this Regulation, which are

lawfully placed on the market prior to 1 September 2012, may continue to be marketed after that date until their date of minimum durability or use-by-date.

2. Foodstuffs not complying with the maximum levels applicable from 1 September 2014 pursuant to points 6.1.4 and 6.1.5 of the Annex to Regulation (EC) No 1881/2006, as amended by this Regulation, which are lawfully placed on the market prior to 1 September 2014, may continue to be marketed after that date until their date of minimum durability or use-by-date.

3. Foodstuffs not complying with the maximum levels applicable from 1 April 2013 pursuant to point 6.1.2 of the Annex to Regulation (EC) No 1881/2006, as amended by this Regulation, which are lawfully placed on the market prior to 1 April 2013, may continue to be marketed after that date until their date of minimum durability or use-by-date.

4. Foodstuffs not complying with the maximum level applicable from 1 April 2015 pursuant to point 6.1.2 of the Annex to Regulation (EC) No 1881/2006, as amended by this Regulation, which are lawfully placed on the market prior to 1 April 2015, may continue to be marketed after that date until their date of minimum durability or use-by-date.

Article 3

This Regulation shall enter into force on the twentieth day following that of its publication in the *Official Journal of the European Union*.

It shall apply from 1 September 2012.

This Regulation shall be binding in its entirety and directly applicable in all Member States.

Done at Brussels, 19 August 2011.

For the Commission

The President

José Manuel BARROSO

ANNEX

The Annex to Regulation (EC) No 1881/2006 is amended as follows:

(1) Section 6: *Polycyclic aromatic hydrocarbons* is replaced by the following:

"Section 6: *Polycyclic aromatic hydrocarbons*

Foodstuffs		Maximum levels (µg/kg)	
6.1	Benzo(a)pyrene, benz(a)anthracene, benzo(b)fluoranthene and chrysene	Benzo(a)pyrene	Sum of benzo(a)pyrene, benz(a)anthracene, benzo(b)fluoranthene and chrysene ⁽⁴⁵⁾
6.1.1	Oils and fats (excluding cocoa butter and coconut oil) intended for direct human consumption or use as an ingredient in food	2,0	10,0
6.1.2	Cocoa beans and derived products	5,0 µg/kg fat as from 1.4.2013	35,0 µg/kg fat as from 1.4.2013 until 31.3.2015 30,0 µg/kg fat as from 1.4.2015
6.1.3	Coconut oil intended for direct human consumption or use as an ingredient in food	2,0	20,0
6.1.4	Smoked meat and smoked meat products	5,0 until 31.8.2014 2,0 as from 1.9.2014	30,0 as from 1.9.2012 until 31.8.2014 12,0 as from 1.9.2014
6.1.5	Muscle meat of smoked fish and smoked fishery products ⁽²⁵⁾⁽³⁶⁾ , excluding fishery products listed in points 6.1.6 and 6.1.7. The maximum level for smoked crustaceans applies to muscle meat from appendages and abdomen ⁽⁴⁴⁾ . In case of smoked crabs and crab-like crustaceans (<i>Brachyura</i> and <i>Anomura</i>) it applies to muscle meat from appendages.	5,0 until 31.8.2014 2,0 as from 1.9.2014	30,0 as from 1.9.2012 until 31.8.2014 12,0 as from 1.9.2014
6.1.6	Smoked sprats and canned smoked sprats ⁽²⁵⁾⁽⁴⁷⁾ (<i>sprattus sprattus</i>); bivalve molluscs (fresh, chilled or frozen) ⁽²⁶⁾ ; heat treated meat and heat treated meat products ⁽⁴⁶⁾ sold to the final consumer	5,0	30,0
6.1.7	Bivalve molluscs ⁽³⁶⁾ (smoked)	6,0	35,0
6.1.8	Processed cereal-based foods and baby foods for infants and young children ⁽³⁾⁽²⁹⁾	1,0	1,0
6.1.9	Infant formulae and follow-on formulae, including infant milk and follow-on milk ⁽⁸⁾⁽²⁹⁾	1,0	1,0

Foodstuffs		Maximum levels ($\mu\text{g}/\text{kg}$)	
6.1.10	Dietary foods for special medical purposes (⁹)(²⁹) intended specifically for infants	1,0	1,0

(⁴⁵) Lower bound concentrations are calculated on the assumption that all the values of the four substances below the limit of quantification are zero.

(⁴⁶) Meat and meat products that have undergone a heat treatment potentially resulting in formation of PAH, i.e. only grilling and barbecuing.

(⁴⁷) For the canned product the analysis shall be carried out on the whole content of the can. As regards the maximum level for the whole composite product Art. 2(1)(c) and 2(2) shall apply."

(2) Endnote (³⁵) is deleted.

Annex III:

Official Journal of the European Union

**COMMISSION REGULATION (EU) No 836/2011
of 19 August 2011**

**amending Regulation (EC) No 333/2007 laying down the methods of sampling and analysis for
the official control of the levels of lead, cadmium, mercury, inorganic tin, 3-MCPD and
benzo(a)pyrene in foodstuffs**

COMMISSION REGULATION (EU) No 836/2011

of 19 August 2011

amending Regulation (EC) No 333/2007 laying down the methods of sampling and analysis for the official control of the levels of lead, cadmium, mercury, inorganic tin, 3-MCPD and benzo(a)pyrene in foodstuffs

(Text with EEA relevance)

THE EUROPEAN COMMISSION,

Having regard to the Treaty on the Functioning of the European Union,

Having regard to Regulation (EC) No 882/2004 of the European Parliament and of the Council of 29 April 2004 on official controls performed to ensure the verification of compliance with feed and food law, animal health and animal welfare rules ⁽¹⁾, in particular Article 11(4) thereof,

Whereas:

- (1) Commission Regulation (EC) No 1881/2006 of 19 December 2006 setting maximum levels for certain contaminants in foodstuffs ⁽²⁾ established, inter alia, maximum levels for the contaminant benzo(a)pyrene.
- (2) The Scientific Panel on Contaminants in the Food Chain of the European Food Safety Authority (EFSA) adopted an opinion on Polycyclic Aromatic Hydrocarbons in Food on 9 June 2008 ⁽³⁾. The EFSA concluded that benzo(a)pyrene is not a suitable marker for the occurrence of polycyclic aromatic hydrocarbons (PAH) in food and that a system of four specific substances or eight specific substances would be the most suitable markers of PAH in food. The EFSA also concluded that a system of eight substances would not provide much added value compared to a system of four substances.
- (3) As a consequence Commission Regulation (EU) No 835/2011 ⁽⁴⁾ amended Regulation (EC) No 1881/2006 in order to set maximum levels for the sum of four polycyclic aromatic hydrocarbons (benzo(a)pyrene, benz(a)anthracene, benzo(b)fluoranthene and chrysene).
- (4) Commission Regulation (EC) No 333/2007 ⁽⁵⁾ lays down analytical performance criteria only for benzo(a)pyrene. It is therefore necessary to lay down analytical performance criteria for the other three substances for which maximum levels are now set out in Regulation (EC) No 1881/2006.
- (5) The European Union Reference Laboratory for Polycyclic Aromatic Hydrocarbons (EU-RL PAH) in collaboration with the national reference laboratories carried out a survey among official control laboratories to assess which analytical performance criteria would be achievable for benzo(a)pyrene, benz(a)anthracene, benzo(b)fluoranthene and chrysene in relevant food matrices. The outcome of this survey was summarised by the EU-RL PAH in the Report on 'Performance characteristics of analysis methods for the determination of 4 polycyclic aromatic hydrocarbons in food' ⁽⁶⁾. The results of the survey show that the analytical performance criteria currently applicable to benzo(a)pyrene are also suitable for the other three substances.
- (6) Experience acquired while implementing Regulation (EC) No 333/2007 revealed that in some cases the current sampling provisions may be impracticable or may lead to unacceptable economic damage to the sampled lot. For such cases, departure from the sampling procedures should be allowed, provided that sampling remains sufficiently representative of the sampled lot or subplot and that the procedure used is fully documented. For sampling at the retail stage, flexibility to depart from the sampling procedures existed already. The provisions for sampling at retail stage should be aligned with the general sampling procedures.
- (7) More detailed provisions are needed as regards the material of sampling containers when samples are taken for PAH analysis. Plastic containers are widely used by enforcement authorities, but they are not suitable when sampling is carried out for PAH analysis, as the PAH content of the sample can be altered by these materials.
- (8) Clarification is needed for some aspects of the specific requirements for analytical methods, in particular the requirements regarding the use of the performance criteria and the 'fitness-for-purpose' approach. Furthermore, the presentation of the tables with the performance criteria should be modified to appear more uniform across all analytes.
- (9) Regulation (EC) No 333/2007 should therefore be amended accordingly. Since Regulation (EU) No 835/2011 and this Regulation are inter-linked, both Regulations should become applicable on the same date.

⁽¹⁾ OJ L 165, 30.4.2004, p. 1.⁽²⁾ OJ L 364, 20.12.2006, p. 5.⁽³⁾ The EFSA Journal (2008) 724, p. 1.⁽⁴⁾ See page 4 of this Official Journal.⁽⁵⁾ OJ L 88, 29.3.2007, p. 29.⁽⁶⁾ JRC Report 59046, 2010.

(10) The measures provided for in this Regulation are in accordance with the opinion of the Standing Committee on the Food Chain and Animal Health and neither the European Parliament nor the Council have opposed them,

HAS ADOPTED THIS REGULATION:

Article 1

Regulation (EC) No 333/2007 is amended as follows:

(1) the title is replaced by the following:

'Commission Regulation (EC) No 333/2007 of 28 March 2007 laying down the methods of sampling and analysis for the official control of the levels of lead, cadmium, mercury, inorganic tin, 3-MCPD and polycyclic aromatic hydrocarbons in foodstuffs';

(2) in Article 1, paragraph 1 is replaced by the following:

'1. Sampling and analysis for the official control of the levels of lead, cadmium, mercury, inorganic tin, 3-MCPD and polycyclic aromatic hydrocarbons ("PAH") listed in Sections 3, 4 and 6 of the Annex to Regulation (EC) No 1881/2006 shall be carried out in accordance with the Annex to this Regulation.';

(3) the Annex is amended in accordance with the Annex to this Regulation.

Article 2

This Regulation shall enter into force on the 20th day following its publication in the *Official Journal of the European Union*.

It shall apply from 1 September 2012.

This Regulation shall be binding in its entirety and directly applicable in all Member States.

Done at Brussels, 19 August 2011.

For the Commission

The President

José Manuel BARROSO

ANNEX

The Annex to Regulation (EC) No 333/2007 is amended as follows:

- (1) in point B.1.7 'Packaging and transmission of samples', the following second paragraph is added:

'In case of sampling for PAH analysis plastic containers shall be avoided if possible as they could alter the PAH content of the sample. Inert, PAH-free glass containers, adequately protecting the sample from light, shall be used wherever possible. Where this is practically impossible, at least direct contact of the sample with plastics shall be avoided, e.g. in case of solid samples by wrapping the sample in aluminium foil before placing it in the sampling container.';

- (2) points B.2 and B.3 are replaced by the following:

B.2. SAMPLING PLANS

B.2.1. Division of lots into sublots

Large lots shall be divided into sublots on condition that the subplot may be separated physically. For products traded in bulk consignments (e.g. cereals) Table 1 shall apply. For other products Table 2 shall apply. Taking into account that the weight of the lot is not always an exact multiple of the weight of the sublots, the weight of the subplot may exceed the mentioned weight by a maximum of 20 %.

B.2.2. Number of incremental samples

The aggregate sample shall be at least 1 kg or 1 litre except where it is not possible, e.g. when the sample consists of 1 package or unit.

The minimum number of incremental samples to be taken from the lot or subplot shall be as given in Table 3.

In the case of bulk liquid products the lot or subplot shall be thoroughly mixed in so far as possible and in so far it does not affect the quality of the product, by either manual or mechanical means immediately prior to sampling. In this case, a homogeneous distribution of contaminants is assumed within a given lot or subplot. It is therefore sufficient to take three incremental samples from a lot or subplot to form the aggregate sample.

The incremental samples shall be of similar weight/volume. The weight/volume of an incremental sample shall be at least 100 grams or 100 millilitres, resulting in an aggregate sample of at least about 1 kg or 1 litre. Departure from this method shall be recorded in the record provided for under point B.1.8 of this Annex.

Table 1

Subdivision of lots into sublots for products traded in bulk consignments

Lot weight (ton)	Weight or number of sublots
≥ 1 500	500 tonnes
> 300 and < 1 500	3 sublots
≥ 100 and ≤ 300	100 tonnes
< 100	—

Table 2

Subdivision of lots into sublots for other products

Lot weight (ton)	Weight or number of sublots
≥ 15	15-30 tonnes
< 15	—

Table 3

Minimum number of incremental samples to be taken from the lot or subplot

Weight or volume of lot/sublot (in kg or litre)	Minimum number of incremental samples to be taken
< 50	3
≥ 50 and ≤ 500	5
> 500	10

If the lot or subplot consists of individual packages or units, then the number of packages or units which shall be taken to form the aggregate sample is given in Table 4.

Table 4

Number of packages or units (incremental samples) which shall be taken to form the aggregate sample if the lot or subplot consists of individual packages or units

Number of packages or units in the lot/sublot	Number of packages or units to be taken
≤ 25	at least 1 package or unit
26-100	about 5 %, at least 2 packages or units
> 100	about 5 %, at maximum 10 packages or units

The maximum levels for inorganic tin apply to the contents of each can, but for practical reasons it is necessary to use an aggregate sampling approach. If the result of the test for an aggregate sample of cans is less than but close to the maximum level of inorganic tin and if it is suspected that individual cans might exceed the maximum level, then it might be necessary to conduct further investigations.

Where it is not possible to carry out the method of sampling set out in this chapter because of the unacceptable commercial consequences (e.g. because of packaging forms, damage to the lot, etc.) or where it is practically impossible to apply the abovementioned method of sampling, an alternative method of sampling may be applied provided that it is sufficiently representative for the sampled lot or subplot and is fully documented.

B.2.3. Specific provisions for the sampling of large fish arriving in large lots

In case the lot or subplot to be sampled contains large fishes (individual fishes weighing more than about 1 kg) and the lot or subplot weighs more than 500 kg, the incremental sample shall consist of the middle part of the fish. Each incremental sample shall weigh at least 100 g.

B.3. SAMPLING AT RETAIL STAGE

Sampling of foodstuffs at retail stage shall be done where possible in accordance with the sampling provisions set out in point B.2.2 of this Annex.

Where it is not possible to carry out the method of sampling set out in point B.2.2 because of the unacceptable commercial consequences (e.g. because of packaging forms, damage to the lot, etc.) or where it is practically impossible to apply the abovementioned method of sampling, an alternative method of sampling may be applied provided that it is sufficiently representative for the sampled lot or subplot and is fully documented.;

- (3) in the first paragraph of point C.1 'Laboratory Quality Standards', footnote 1 is deleted;
- (4) in point C.2.2.1 'Specific procedures for lead, cadmium, mercury and inorganic tin', the second paragraph is replaced by the following:

There are many satisfactory specific sample preparation procedures which may be used for the products under consideration. For those aspects not specifically covered by this Regulation, the CEN Standard "Foodstuffs - Determination of trace elements – Performance criteria, general considerations and sample preparation"⁽¹⁾ has been found to be satisfactory but other sample preparation methods may be equally valid.;

- (5) point C.2.2.2 is replaced by the following:

'C.2.2.2. Specific procedures for polycyclic aromatic hydrocarbons

The analyst shall ensure that samples do not become contaminated during sample preparation. Containers shall be rinsed with high purity acetone or hexane before use to minimise the risk of contamination. Wherever possible, apparatus and equipment coming into contact with the sample shall be made of inert materials such as aluminium, glass or polished stainless steel. Plastics such as polypropylene or PTFE shall be avoided because the analytes can adsorb onto these materials.;

(6) point C.3.1 'Definitions' is amended as follows:

(a) the definition for 'HORRAT_r' is replaced by the following:

'HORRAT (*)_r = The observed RSD_r divided by the RSD_r value estimated from the (modified) Horwitz equation (**) (cf. point C.3.3.1 ("Notes to the performance criteria")) using the assumption $r = 0,66 R$.

(*) Horwitz W. and Albert, R., 2006, The Horwitz Ratio (HorRat): A useful Index of Method Performance with respect to Precision, Journal of AOAC International, Vol. 89, 1095-1109.

(**) M. Thompson, Analyst, 2000, p. 125 and 385-386.'

(b) the definition for 'HORRAT_R' is replaced by the following:

'HORRAT (*)_R = The observed RSD_R divided by the RSD_R value estimated from the (modified) Horwitz equation (**) (cf. point C.3.3.1 ("Notes to the performance criteria")).

(*) Horwitz W. and Albert, R., 2006, The Horwitz Ratio (HorRat): A useful Index of Method Performance with respect to Precision, Journal of AOAC International, Vol. 89, 1095-1109.

(**) M. Thompson, Analyst, 2000, p. 125 and 385-386.'

(c) the definition for 'u' is replaced by the following:

'u = Combined standard measurement uncertainty obtained using the individual standard measurement uncertainties associated with the input quantities in a measurement model (*)

(*) International vocabulary of metrology – Basic and general concepts and associated terms (VIM), JCGM 200:2008.;

(7) point C.3.2 is replaced by the following:

'C.3.2 General requirements

Methods of analysis used for food control purposes shall comply with the provisions of Annex III to Regulation (EC) No 882/2004.

Methods for analysis for total tin are appropriate for official control on inorganic tin levels.

For the analysis of lead in wine, the methods and rules established by the OIV (*) apply in accordance with Article 31 of Council Regulation (EC) No 479/2008 (**).

(*) Organisation internationale de la vigne et du vin.

(**) Council Regulation (EC) No 479/2008 of 29 April 2008 on the common organisation of the market in wine amending Regulations (EC) No 1493/1999, (EC) No 1782/2003, (EC) No 1290/2005, (EC) No 3/2008 and repealing Regulations (EEC) No 2392/86 and (EC) No 1493/1999 (OJ L 148, 6.6.2008, p. 1).;

(8) point C.3.3.1 is replaced by the following:

'C.3.3.1. Performance criteria

Where no specific methods for the determination of contaminants in foodstuffs are prescribed at European Union level, laboratories may select any validated method of analysis for the respective matrix provided that the selected method meets the specific performance criteria set out in Tables 5, 6 and 7.

It is recommended that fully validated methods (i.e. methods validated by collaborative trial for the respective matrix) are used where appropriate and available. Other suitable validated methods (e.g. in-house validated methods for the respective matrix) may also be used provided that they fulfil the performance criteria set out in Tables 5, 6 and 7.

Where possible, the validation of in-house validated methods shall include a certified reference material.

- (a) Performance criteria for methods of analysis for lead, cadmium, mercury and inorganic tin:

Table 5

Parameter	Criterion		
Applicability	Foods specified in Regulation (EC) No 1881/2006		
Specificity	Free from matrix or spectral interferences		
Repeatability (RSD _r)	HORRAT _r less than 2		
Reproducibility (RSD _R)	HORRAT _R less than 2		
Recovery	The provisions of point D.1.2 apply		
	Inorganic tin	Lead, cadmium, mercury	
		ML is < 0,100 mg/kg	ML is ≥ 0,100 mg/kg
LOD	≤ 5 mg/kg	≤ one fifth of the ML	≤ one tenth of the ML
LOQ	≤ 10 mg/kg	≤ two fifths of the ML	≤ one fifth of the ML

- (b) Performance criteria for methods of analysis for 3-MCPD:

Table 6

Parameter	Criterion
Applicability	Foods specified in Regulation (EC) No 1881/2006
Specificity	Free from matrix or spectral interferences
Field blanks	Less than LOD
Repeatability (RSD _r)	0,66 times RSD _R as derived from (modified) Horwitz equation
Reproducibility (RSD _R)	as derived from (modified) Horwitz equation
Recovery	75-110 %
LOD	≤ 5 µg/kg (on dry matter basis)
LOQ	≤ 10 µg/kg (on dry matter basis)

- (c) Performance criteria for methods of analysis for polycyclic aromatic hydrocarbons:

The four polycyclic aromatic hydrocarbons to which these criteria apply are benzo(a)pyrene, benz(a)anthracene, benzo(b)fluoranthene and chrysene.

Table 7

Parameter	Criterion
Applicability	Foods specified in Regulation (EC) No 1881/2006
Specificity	Free from matrix or spectral interferences, verification of positive detection
Repeatability (RSD _r)	HORRAT _r less than 2
Reproducibility (RSD _R)	HORRAT _R less than 2

Parameter	Criterion
Recovery	50-120 %
LOD	≤ 0,30 µg/kg for each of the four substances
LOQ	≤ 0,90 µg/kg for each of the four substances

(d) Notes to the performance criteria:

The Horwitz equation (*) (for concentrations $1,2 \times 10^{-7} \leq C \leq 0,138$) and the modified Horwitz equation (**) (for concentrations $C < 1,2 \times 10^{-7}$) are generalised precision equations which are independent of analyte and matrix but solely dependent on concentration for most routine methods of analysis.

Modified Horwitz equation for concentrations $C < 1,2 \times 10^{-7}$:

$$RSD_R = 22 \%$$

where:

- RSD_R is the relative standard deviation calculated from results generated under reproducibility conditions $[(s_R / \bar{x}) \times 100]$
- C is the concentration ratio (i.e. 1 = 100 g/100 g, 0,001 = 1 000 mg/kg). The modified Horwitz equation applies to concentrations $C < 1,2 \times 10^{-7}$.

Horwitz equation for concentrations $1,2 \times 10^{-7} \leq C \leq 0,138$:

$$RSD_R = 2C^{(-0,15)}$$

where:

- RSD_R is the relative standard deviation calculated from results generated under reproducibility conditions $[(s_R / \bar{x}) \times 100]$
- C is the concentration ratio (i.e. 1 = 100 g/100 g, 0,001 = 1 000 mg/kg). The Horwitz equation applies to concentrations $1,2 \times 10^{-7} \leq C \leq 0,138$.

(*) W. Horwitz, L.R. Kamps, K.W. Boyer, J.Assoc.Off.Analy.Chem.,1980, 63, 1344.

(**) M. Thompson, Analyst, 2000, p. 125 and 385-386.;

(9) point C.3.3.2 is replaced by the following:

'C.3.3.2. "Fitness-for-purpose" approach

For in-house validated methods, as an alternative a "fitness-for-purpose" approach (*) may be used to assess their suitability for official control. Methods suitable for official control must produce results with a combined standard measurement uncertainty (u) less than the maximum standard measurement uncertainty calculated using the formula below:

$$U_f = \sqrt{(LOD/2)^2 + (\alpha C)^2}$$

where:

- U_f is the maximum standard measurement uncertainty (µg/kg).
- LOD is the limit of detection of the method (µg/kg). The LOD must meet the performance criteria set in point C.3.3.1 for the concentration of interest.
- C is the concentration of interest (µg/kg);
- α is a numeric factor to be used depending on the value of C . The values to be used are given in Table 8.

Table 8

Numeric values to be used for α as constant in formula set out in this point, depending on the concentration of interest

C (µg/kg)	α
≤ 50	0,2
51-500	0,18

C (µg/kg)	α
501-1 000	0,15
1 001-10 000	0,12
> 10 000	0,1

The analyst shall note the "Report on the relationship between analytical results, measurement uncertainty, recovery factors and the provisions of EU food and feed legislation" (**).

(*) M. Thompson and R. Wood, *Accred. Qual. Assur.*, 2006, p. 10 and 471-478.

(**) http://ec.europa.eu/food/food/chemicalsafety/contaminants/report-sampling_analysis_2004_en.pdf;

(10) in point D.1.2 'Recovery calculations', the second paragraph is replaced by the following:

'In case no extraction step is applied in the analytical method (e.g. in case of metals), the result may be reported uncorrected for recovery if evidence is provided by ideally making use of suitable certified reference material that the certified concentration allowing for the measurement uncertainty is achieved (i.e. high accuracy of the measurement), and thus that the method is not biased. In case the result is reported uncorrected for recovery this shall be mentioned.';

(11) in point D.1.3 'Measurement uncertainty', the second paragraph is replaced by the following:

'The analyst shall note the "Report on the relationship between analytical results, measurement uncertainty, recovery factors and the provisions of EU food and feed legislation" (*).

(*) http://ec.europa.eu/food/food/chemicalsafety/contaminants/report-sampling_analysis_2004_en.pdf.

Annex IV:

Official Journal of the European Union

COMMISSION REGULATION (EU) No 2017/644

of 5 April 2017

laying down methods of sampling and analysis for the control of levels of dioxins, dioxin-like PCBs and non-dioxin-like PCBs in certain foodstuffs and repealing Regulation (EU)

No 589/2014

COMMISSION REGULATION (EU) 2017/644

of 5 April 2017

laying down methods of sampling and analysis for the control of levels of dioxins, dioxin-like PCBs and non-dioxin-like PCBs in certain foodstuffs and repealing Regulation (EU) No 589/2014

(Text with EEA relevance)

THE EUROPEAN COMMISSION,

Having regard to the Treaty on the Functioning of the European Union,

Having regard to Regulation (EC) No 882/2004 of the European Parliament and of the Council of 29 April 2004 on official controls performed to ensure the verification of compliance with feed and food law, animal health and animal welfare rules ⁽¹⁾, and in particular Article 11(4) thereof,

Whereas:

- (1) Commission Regulation (EC) No 1881/2006 ⁽²⁾ sets out the maximum levels for non-dioxin-like polychlorinated biphenyls (PCBs) dioxins and furans and for the sum of dioxins, furans and dioxin-like PCBs in certain foodstuffs.
- (2) Commission Recommendation 2013/711/EU ⁽³⁾ sets out action levels in order to stimulate a proactive approach to reduce the presence of polychlorinated dibenzo-para-dioxins and polychlorinated dibenzofurans (PCDD/Fs) and dioxin-like PCBs in food. Those action levels are a tool used by competent authorities and operators to highlight those cases where it is appropriate to identify a source of contamination and to take the necessary measures in order to reduce or eliminate it.
- (3) Commission Regulation (EC) No 589/2014 ⁽⁴⁾ establishes specific provisions concerning the sampling procedure and the methods of analysis to be applied for the official control of levels of dioxins, dioxin-like PCBs and non-dioxin-like PCBs.
- (4) The provisions laid down in this Regulation relate only to the sampling and analysis of dioxins, dioxin-like PCBs and non-dioxin-like PCBs for the implementation of Regulation (EC) No 1881/2006 and Recommendation 2013/711/EU. They do not affect the sampling strategy, sampling levels and frequency as set out in Annexes III and IV to Council Directive 96/23/EC ⁽⁵⁾. They do not affect the targeting criteria for sampling as laid down in Commission Decision 98/179/EC ⁽⁶⁾.
- (5) It is appropriate to ensure that food business operators applying the controls performed within the framework of Article 4 of Regulation (EC) No 852/2004 of the European Parliament and of the Council ⁽⁷⁾ apply sampling procedures equivalent to the sampling procedures provided for by this Regulation in order to ensure that samples taken for those controls are representative samples. Furthermore, the European Union Reference Laboratory for Dioxins and PCBs has provided evidence that analytical results in certain cases are not reliable when the performance criteria as provided in this Regulation are not applied by laboratories performing the analysis of samples taken by food business operators within the framework of Article 4 of Regulation (EC) No 852/2004. It is therefore appropriate to make the application of the performance criteria also obligatory for the analysis of those samples.

⁽¹⁾ OJ L 165, 30.4.2004, p. 1.

⁽²⁾ Commission Regulation (EC) No 1881/2006 of 19 December 2006 setting maximum levels for certain contaminants in foodstuffs (OJ L 364, 20.12.2006, p. 5).

⁽³⁾ Commission Recommendation 2013/711/EU of 3 December 2013 on the reduction of the presence of dioxins, furans and PCBs in feed and food (OJ L 323, 4.12.2013, p. 37).

⁽⁴⁾ Commission Regulation (EU) No 589/2014 of 2 June 2014 laying down methods of sampling and analysis for the official control of levels of dioxins, dioxin-like PCBs and non-dioxin-like PCBs in certain foodstuffs and repealing Regulation (EU) No 252/2012 (OJ L 164, 3.6.2014, p. 18).

⁽⁵⁾ Council Directive 96/23/EC of 29 April 1996 on measures to monitor certain substances and residues thereof in live animals and animal products and repealing Directives 85/358/EEC and 86/469/EEC and Decisions 89/187/EEC and 91/664/EEC (OJ L 125, 23.5.1996, p. 10).

⁽⁶⁾ Commission Decision 98/179/EC of 23 February 1998 laying down detailed rules on official sampling for the monitoring of certain substances and residues thereof in live animals and animal products (OJ L 65, 5.3.1998, p. 31).

⁽⁷⁾ Regulation (EC) No 852/2004 of the European Parliament and of the Council of 29 April 2004 on the hygiene of foodstuffs (OJ L 139, 30.4.2004, p. 1).

- (6) Given that the approach of the use of a decision limit to ensure that an analytical result is above the maximum level with a certain probability, as provided for in Commission Decision 2002/657/EC ⁽¹⁾, is no longer applied for the analysis of dioxins and PCBs in food, it is appropriate to delete this approach and to keep only the approach of the expanded uncertainty using the coverage factor of 2, giving a level confidence of approximately 95 %.
- (7) In line with the reporting requirements for bioanalytical screening methods, it is appropriate to also provide for physico-chemical methods used for screening specific reporting requirements.
- (8) Given that the analysis of dioxins, dioxin-like PCBs and non-dioxin-like PCBs are in most cases determined together it is appropriate to align the performance criteria for the non-dioxin-like PCBs to the performance criteria for dioxins and dioxin-like PCBs. This is a simplification, without substantial changes in practice as in the case of non-dioxin-like PCBs the relative intensity of qualifier ions compared to target ions is > 50 %.
- (9) Furthermore there are several other minor modifications proposed to the current provisions, requiring the repeal of Regulation (EU) No 589/2014 and its replacing by a new Regulation to maintain the readability of the text.
- (10) The measures provided for in this Regulation are in accordance with the opinion of the Standing Committee on Plants, Animals, Food and Feed,

HAS ADOPTED THIS REGULATION:

Article 1

For the purposes of this Regulation, the definitions and abbreviations set out in Annex I shall apply.

Article 2

Sampling for the official control of the levels of dioxins, furans, dioxin-like PCBs and non-dioxin-like PCBs in foodstuffs listed in Section 5 of the Annex to Regulation (EC) No 1881/2006 shall be carried out in accordance with the methods set out in Annex II to this Regulation.

Article 3

Sample preparation and analyses for the control of the levels of dioxins, furans and dioxin-like PCBs in foodstuffs listed in Section 5 of the Annex to Regulation (EC) No 1881/2006 shall be carried out in accordance with the methods set out in Annex III to this Regulation.

Article 4

Analyses for the control of the levels of non-dioxin-like PCBs in foodstuffs listed in Section 5 of the Annex to Regulation (EC) No 1881/2006 shall be carried out in accordance with the requirements for analytical procedures set out in Annex IV to this Regulation.

Article 5

Regulation (EU) No 589/2014 is repealed.

References to the repealed Regulation shall be construed as references to this Regulation.

⁽¹⁾ Commission Decision 2002/657/EC of 14 August 2002 implementing Council Directive 96/23/EC concerning the performance of analytical methods and the interpretation of results (OJ L 221, 17.8.2002, p. 8).

Article 6

This Regulation shall enter into force on the twentieth day following that of its publication in the *Official Journal of the European Union*.

This Regulation shall be binding in its entirety and directly applicable in all Member States.

Done at Brussels, 5 April 2017.

For the Commission
The President
Jean-Claude JUNCKER

ANNEX I

DEFINITIONS AND ABBREVIATIONS

I. DEFINITIONS

For the purposes of this Regulation the definitions laid down in Annex I to Decision 2002/657/EC shall apply.

Further to those definitions, the following definitions shall apply for the purposes of this Regulation:

- 1.1. 'Action level' means the level of a given substance, as laid down in the Annex to Recommendation 2013/711/EU, which triggers investigations to identify the source of that substance in cases where increased levels of the substance are detected.
- 1.2. 'Screening methods' means methods used for the selection of those samples with levels of PCDD/Fs and dioxin-like PCBs that exceed the maximum levels or the action levels. They shall allow for a cost-effective high sample-throughput, thus increasing the chance of discovering new cases where high exposure may lead to health risks for consumers. Screening methods shall be based on bioanalytical or GC-MS methods. Results from samples exceeding the cut-off value established to check compliance with the maximum level shall be verified by a full re-analysis from the original sample using a confirmatory method.
- 1.3. 'Confirmatory methods' means methods that provide full or complementary information enabling the PCDD/Fs and dioxin-like PCBs to be identified and quantified unequivocally at the maximum or, in case of need, at the action level. Such methods utilise gas chromatography/high resolution mass spectrometry (GC-HRMS) or gas chromatography/tandem mass spectrometry (GC-MS/MS).
- 1.4. 'Bioanalytical methods' means methods based on the use of biological principles such as cell-based assays, receptor-assays or immunoassays. They do not give results at the congener level but merely an indication ⁽¹⁾ of the TEQ level, expressed in Bioanalytical Equivalents (BEQ) to acknowledge the fact that not all compounds present in a sample extract that produce a response in the test may meet all requirements of the TEQ-principle.
- 1.5. 'Bioassay apparent recovery' means the BEQ level calculated from the TCDD or PCB 126 calibration curve corrected for the blank and then divided by the TEQ level determined by the confirmatory method. It attempts to correct factors like the loss of PCDD/Fs and dioxin-like compounds during the extraction and clean-up steps, co-extracted compounds increasing or decreasing the response (agonistic and antagonistic effects), the quality of the curve fit, or differences between the TEF and the REP values. The bioassay apparent recovery is calculated from suitable reference samples with representative congener patterns around the maximum or action level.
- 1.6. 'Duplicate analysis' means separate analysis of the analytes of interest using a second aliquot of the same homogenised sample.
- 1.7. 'Accepted specific limit of quantification ⁽²⁾ of an individual congener in a sample' means the lowest content of the analyte that can be measured with reasonable statistical certainty, fulfilling the identification criteria as described in internationally recognised standards, for example, in standard EN 16215:2012 ('Animal feed — Determination of dioxins and dioxin-like PCBs by GC/HRMS and of indicator PCBs by GC/HRMS') and/or in EPA methods 1613 and 1668 as revised.

The limit of quantification of an individual congener may be identified as

- (a) the concentration of an analyte in the extract of a sample which produces an instrumental response at two different ions to be monitored with a S/N (signal/noise) ratio of 3:1 for the less intensive raw data signal;

⁽¹⁾ Bioanalytical methods are not specific to those congeners included in the TEF-scheme. Other structurally related AhR-active compounds may be present in the sample extract which contribute to the overall response. Therefore, bioanalytical results cannot be an estimate but rather an indication of the TEQ level in the sample.

⁽²⁾ The principles as described in the 'Guidance Document on the Estimation of LOD and LOQ for Measurements in the Field of Contaminants in Feed and Food' [[link to website](#)] shall be followed when applicable.

or, if for technical reasons the signal-to-noise calculation does not provide reliable results,

(b) the lowest concentration point on a calibration curve that gives an acceptable ($\leq 30\%$) and consistent (measured at least at the start and at the end of an analytical series of samples) deviation to the average relative response factor calculated for all points on the calibration curve in each series of samples⁽¹⁾.

- 1.8. 'Upper-bound' means the concept which requires using the limit of quantification for the contribution of each non-quantified congener.
- 1.9. 'Lower-bound' means the concept which requires using zero for the contribution of each non-quantified congener.
- 1.10. 'Medium-bound' means the concept which requires using half of the limit of quantification calculating the contribution of each non-quantified congener.
- 1.11. 'Lot' means an identifiable quantity of food delivered at one time and determined by the official to have common characteristics, such as origin, variety, type of packing, packer, consignor or markings. In the case of fish and fishery products, also the size of fish shall be comparable. In case the size and/or weight of the fish is not comparable within a consignment, the consignment may still be considered as a lot but a specific sampling procedure has to be applied.
- 1.12. 'Sublot' means designated part of a large lot in order to apply the sampling method on that designated part. Each sublot must be physically separated and identifiable.
- 1.13. 'Incremental sample' means a quantity of material taken from a single place in the lot or sublot.
- 1.14. 'Aggregate sample' means the combined total of all the incremental samples taken from the lot or sublot.
- 1.15. 'Laboratory sample' means a representative part/quantity of the aggregate sample intended for the laboratory.

II. ABBREVIATIONS USED

BEQ	Bioanalytical Equivalents
GC	Gas chromatography
HRMS	High resolution mass spectrometry
LRMS	Low resolution mass spectrometry
MS/MS	Tandem mass spectrometry
PCB	Polychlorinated biphenyl
Non-dioxin-like PCBs	PCB 28, PCB 52, PCB 101, PCB 138, PCB 153 and PCB 180
PCDD	Polychlorinated dibenzo-p-dioxins
PCDF	Polychlorinated dibenzofurans
QC	Quality control
REP	Relative potency
TEF	Toxic Equivalency Factor
TEQ	Toxic Equivalents
TCDD	2,3,7,8-Tetrachlorodibenzo-p-dioxin
U	Expanded measurement uncertainty

⁽¹⁾ The LOQ is calculated from the lowest concentration point taking into account the recovery of internal standards and sample intake.

ANNEX II

METHODS OF SAMPLING FOR OFFICIAL CONTROL OF LEVELS OF DIOXINS (PCDD/PCDF), DIOXIN-LIKE PCBs AND NON-DIOXIN-LIKE PCBs IN CERTAIN FOODSTUFFS**I. SCOPE**

Samples intended for the official control of the levels of dioxins (PCDD/Fs), dioxin-like PCBs and non-dioxin-like PCBs in foodstuffs shall be taken according to the methods described in this Annex. Aggregate samples thus obtained shall be considered as representative of the lots or sublots from which they are taken. Compliance with maximum levels laid down in Regulation (EC) No 1881/2006 shall be established on the basis of the levels determined in the laboratory samples.

To ensure compliance with the provisions in Article 4 of Regulation (EC) No 852/2004, food business operator shall, when samples are taken to control the levels of dioxins (PCDD/Fs), dioxin-like PCBs and non-dioxin-like PCBs, take the samples according to the methods described in Chapter III of this Annex or apply an equivalent sampling procedure which is demonstrated to have a same level of representation as the sampling procedure described in Chapter III of this Annex.

II. GENERAL PROVISIONS**1. Personnel**

Official sampling shall be performed by an authorised person as designated by the Member State.

2. Material to be sampled

Each lot or subplot which is to be examined shall be sampled separately.

3. Precautions to be taken

In the course of sampling and the preparation of the samples, precautions shall be taken to avoid any changes which would affect the content of dioxins and PCBs, adversely affect the analytical determination or make the aggregate samples unrepresentative.

4. Incremental samples

As far as possible, incremental samples shall be taken at various places distributed throughout the lot or subplot. Departure from such a procedure shall be recorded in the record provided for under point II.8.

5. Preparation of the aggregate sample

The aggregate sample shall be made up by combining the incremental samples. It shall be at least 1 kg unless not practical, e.g. when a single package has been sampled or when the product has a very high commercial value.

6. Replicate samples

The replicate samples for enforcement, defence and reference purposes shall be taken from the homogenised aggregate sample, unless such procedure conflicts with a Member State's rules as regard the rights of the food business operator. The size of the laboratory samples for enforcement shall be sufficient to allow at least for duplicate analyses.

7. Packaging and transmission of samples

Each sample shall be placed in a clean, inert container offering adequate protection from contamination, from loss of analytes by adsorption to the internal wall of the container and against damage in transit. All necessary precautions shall be taken to avoid any change in composition of the sample which might arise during transportation or storage.

8. Sealing and labelling of samples

Each sample taken for official use shall be sealed at the place of sampling and identified in accordance with the rules of the Member States.

A record shall be kept of each sampling, permitting each lot to be identified unambiguously and giving the date and place of sampling together with any additional information likely to be of assistance to the analyst.

III. SAMPLING PLAN

The sampling method applied shall ensure that the aggregate sample is representative of the (sub)lot that is to be controlled.

1. Division of lots into sublots

Large lots shall be divided into sublots on condition that the subplot can be separated physically. For products traded in large bulk consignments (e.g. vegetable oils) Table 1 shall apply. For other products Table 2 shall apply. Taking into account that the weight of the lot is not always an exact multiple of the weight of the sublots, the weight of the subplot may exceed the mentioned weight by a maximum of 20 %.

Table 1

Subdivision of lots into sublots for products traded in bulk consignments

Lot weight (ton)	Weight or number of sublots
≥ 1 500	500 tonnes
> 300 and < 1 500	3 sublots
≥ 50 and ≤ 300	100 tonnes
< 50	—

Table 2

Subdivision of lots into sublots for other products

Lot weight (ton)	Weight or number of sublots
≥ 15	15-30 tonnes
< 15	—

2. Number of incremental samples

The aggregate sample uniting all incremental samples shall be at least 1 kg (see point II.5).

The minimum number of incremental samples to be taken from the lot or subplot shall be as given in Tables 3 and 4.

In the case of bulk liquid products, the lot or subplot shall be thoroughly mixed insofar as possible and insofar as it does not affect the quality of the product by either manual or mechanical means immediately prior to sampling. In that case, a homogeneous distribution of contaminants is assumed within a given lot or subplot. It is therefore sufficient to take three incremental samples from a lot or subplot to form the aggregate sample.

The incremental samples shall be of similar weight. The weight of an incremental sample shall be at least 100 grams.

Departure from this procedure must be recorded in the record provided for under point II.8 of this Annex. In accordance with the provisions of Commission Decision 97/747/EC⁽¹⁾, the aggregate sample size for hens' eggs is at least 12 eggs (for bulk lots as well as for lots consisting of individual packages, Tables 3 and 4 shall apply).

Table 3

Minimum number of incremental samples to be taken from the lot or subplot

Weight or volume of lot/sublot (in kg or litre)	Minimum number of incremental samples to be taken
< 50	3
50 to 500	5
> 500	10

If the lot or subplot consists of individual packages or units, then the number of packages or units which shall be taken to form the aggregate sample is given in Table 4.

Table 4

Number of packages or units (incremental samples) which shall be taken to form the aggregate sample if the lot or subplot consists of individual packages or units

Number of packages or units in the lot/sublot	Number of packages or units to be taken
1 to 25	at least 1 package or unit
26 to 100	about 5 %, at least 2 packages or units
> 100	about 5 %, at maximum 10 packages or units

3. Specific provisions for the sampling of lots containing whole fishes of comparable size and weight

Fishes are considered to be of comparable size and weight where the difference in size and weight does not exceed about 50 %.

The number of incremental samples to be taken from the lot are defined in Table 3. The aggregate sample uniting all incremental samples shall be at least 1 kg (see point II.5).

— Where the lot to be sampled contains small fishes (individual fishes weighing < about 1 kg), the whole fish is taken as incremental sample to form the aggregate sample. Where the resulting aggregate sample weighs more than 3 kg, the incremental samples may consist of the middle part, weighing each at least 100 grams, of the fishes forming the aggregate sample. The whole part to which the maximum level is applicable is used for homogenisation of the sample.

The middle part of the fish is where the centre of gravity is. This is located in most cases at the dorsal fin (in case the fish has a dorsal fin) or halfway between the gill opening and the anus.

— Where the lot to be sampled contains larger fishes (individual fishes weighing more than about 1 kg), the incremental sample consists of the middle part of the fish. Each incremental sample weighs at least 100 grams.

For fishes of intermediate size (about 1-6 kg) the incremental sample is taken as a slice of the fish from backbone to belly in the middle part of the fish.

⁽¹⁾ Commission Decision 97/747/EC of 27 October 1997 fixing the levels and frequencies of sampling provided for by Council Directive 96/23/EC for the monitoring of certain substances and residues thereof in certain animal products (OJ L 303, 6.11.1997, p. 12).

For very large fishes (e.g. > about 6 kg), the incremental part is taken from the right side (frontal view) dorso-lateral muscle meat in the middle part of the fish. Where the taking of such a piece of the middle part of the fish would result in significant economic damage, the taking of three incremental samples of at least 350 grams each may be considered as being sufficient independent of the size of the lot or alternatively an equal part of the muscled meat close to the tail part and the muscle meat close to the head part of one fish may be taken to form the incremental sample being representative for the level of dioxins in the whole fish.

4. Sampling of lots of fish containing whole fishes of different size and/or weight

- The provisions of point III.3 as regards sample constitution shall apply.
- Where a size or weight class/category is predominant (about 80 % or more of the lot), the sample is taken from fishes with the predominant size or weight. This sample is to be considered as being representative for the whole lot.
- Where no particular size or weight class/category predominates, then it must be ensured that the fishes selected for the sample are representative for the lot. Specific guidance for such cases is provided in 'Guidance document on sampling of whole fishes of different size and/or weight' ⁽²⁾.

5. Sampling at retail stage

Sampling of foodstuffs at the retail stage shall be done where possible in accordance with the sampling provisions set out in point III.2.

Where this is not possible, an alternative method of sampling at retail stage may be used provided that it ensures sufficient representativeness for the sampled lot or subplot.

IV. COMPLIANCE OF THE LOT WITH SPECIFICATION

1. As regards non-dioxin-like PCBs

The lot is compliant if the analytical result for the sum of non-dioxin-like PCBs does not exceed the respective maximum level, as laid down in Regulation (EC) No 1881/2006 taking into account the expanded measurement uncertainty ⁽³⁾.

The lot is non-compliant with the maximum level as laid down in Regulation (EC) No 1881/2006 if the mean of two upperbound analytical results obtained from duplicate analysis ⁽⁴⁾, taking into account the expanded measurement uncertainty, exceeds the maximum level beyond reasonable doubt.

The expanded measurement uncertainty is calculated using a coverage factor of 2 which gives a level of confidence of approximately 95 %. A lot is non-compliant if the mean of the measured values minus the expanded uncertainty of the mean is above the established maximum level.

The rules, mentioned in the paragraphs above under this point, shall apply for the analytical result obtained on the sample for official control. In case of analysis for defence or reference purposes, the national rules apply.

2. As regards dioxins (PCDD/Fs) and dioxin-like PCBs

The lot is compliant if the result of a single analysis

- performed by a screening method with a false-compliant rate below 5 % indicates that the level does not exceed the respective maximum level of PCDD/Fs and the sum of PCDD/Fs and dioxin-like PCBs as laid down in Regulation (EC) No 1881/2006,

⁽²⁾ https://ec.europa.eu/food/sites/food/files/safety/docs/cs_contaminants_catalogue_dioxins_guidance-sampling_exemples-dec2006_en.pdf

⁽³⁾ The principles as described in the 'Guidance Document on Measurement Uncertainty for Laboratories performing PCDD/F and PCB Analysis using Isotope Dilution Mass Spectrometry' [link to website] shall be followed when applicable.

⁽⁴⁾ The duplicate analysis is necessary if the result of the first determination is non-compliant. The duplicate analysis is necessary to exclude the possibility of internal cross-contamination or an accidental mix-up of samples. In case the analysis is performed in the course of a contamination incident, confirmation by duplicate analysis might be omitted in case the samples selected for analysis are through traceability linked to the contamination incident and the level found is significantly above the maximum level.

- performed by a confirmatory method does not exceed the respective maximum level of PCDD/Fs and the sum of PCDD/Fs and dioxin-like PCBs as laid down in Regulation (EC) No 1881/2006 taking into account the expanded measurement uncertainty ⁽⁷⁾.

For screening assays a cut-off value shall be established for the decision on the compliance with the respective maximum levels set for either PCDD/Fs or for the sum of PCDD/Fs and dioxin-like PCBs.

The lot is non-compliant with the maximum level as laid down in Regulation (EC) No 1881/2006 if the mean of two upperbound analytical results (duplicate analysis ⁽⁶⁾) obtained using a confirmatory method, taking into account the expanded measurement uncertainty, exceeds the maximum level beyond reasonable doubt.

The expanded measurement uncertainty is calculated using a coverage factor of 2 which gives a level of confidence of approximately 95 %. A lot is non-compliant if the mean of the measured values minus the expanded uncertainty of the mean is above the established maximum level.

The sum of the estimated expanded uncertainties of the separate analytical results of PCDD/Fs and dioxin-like PCBs has to be used for the estimated expanded uncertainty of the sum of PCDD/Fs and dioxin-like PCBs,

The rules, mentioned in the paragraphs above under this point, shall apply for the analytical result obtained on the sample for official control. In case of analysis for defence or reference purposes, the national rules apply.

V. EXCEEDANCE OF ACTION LEVELS

Action levels serve as a tool for the selection of samples in those cases where it is appropriate to identify a source of contamination and to take measures for its reduction or elimination. Screening methods shall establish the appropriate cut-off values for selection of those samples. Where significant efforts are necessary to identify a source and to reduce or eliminate the contamination, it might be appropriate to confirm exceedance of the action level by duplicate analysis using a confirmatory method and taking into account the expanded measurement uncertainty ⁽⁷⁾.

⁽⁷⁾ Guidance Document on Measurement Uncertainty for Laboratories performing PCDD/F and PCB Analysis using Isotope Dilution Mass Spectrometry [[link to website](#)], Guidance Document on the Estimation of LOD and LOQ for Measurements in the Field of Contaminants in Feed and Food [[link to website](#)].

⁽⁶⁾ The duplicate analysis is necessary if the result of the first determination applying confirmatory methods with the use of ¹³C-labelled internal standard for the relevant analytes is non-compliant. The duplicate analysis is necessary to exclude the possibility of internal cross-contamination or an accidental mix-up of samples. In case the analysis is performed in the course of a contamination incident, confirmation by duplicate analysis might be omitted in case the samples selected for analysis are through traceability linked to the contamination incident and the level found is significantly above the maximum level.

⁽⁷⁾ Identical explanation and requirements for duplicate analysis for control of action levels as in footnote 6 for maximum levels.

ANNEX III

SAMPLE PREPARATION AND REQUIREMENTS FOR METHODS OF ANALYSIS USED IN CONTROL OF THE LEVELS OF DIOXINS (PCDD/Fs) AND DIOXIN-LIKE PCBs IN CERTAIN FOODSTUFFS**1. FIELD OF APPLICATION**

The requirements set out in this Annex shall be applied where foodstuffs are analysed for the official control of the levels of 2,3,7,8-substituted polychlorinated dibenzo-p-dioxins and polychlorinated dibenzofurans (PCDD/Fs) and dioxin-like polychlorinated biphenyls (dioxin-like PCBs) and as regards sample preparation and analytical requirements for other regulatory purposes, including the controls performed by the food business operator to ensure compliance with provisions in Article 4 of Regulation (EC) No 852/2004.

Monitoring for the presence of PCDD/Fs and dioxin-like PCBs in foodstuffs may be performed with two different types of analytical methods:

(a) Screening methods

The goal of screening methods is to select those samples with levels of PCDD/Fs and dioxin-like PCBs that exceed the maximum levels or the action levels. Screening methods shall ensure cost-effective high sample-throughput, thus increasing the chance to discover new incidents where high exposure may lead to health risks for consumers. Their application shall aim to avoid false-compliant results. They may comprise bioanalytical and GC/MS methods.

Screening methods compare the analytical result with a cut-off value, providing a yes/no-decision over the possible exceedance of the maximum or action level. The concentration of PCDD/Fs and the sum of PCDD/Fs and dioxin-like PCBs in samples suspected to be non-compliant with the maximum level must be determined or confirmed by a confirmatory method.

In addition, screening methods may give an indication of the levels of PCDD/Fs and dioxin-like-PCBs present in the sample. In case of application of bioanalytical screening methods the result is expressed as Bioanalytical Equivalents (BEQ), whereas in case of application of physico-chemical GC-MS methods it is expressed as Toxic Equivalents (TEQ). The numerically indicated results of screening methods are suitable for demonstrating compliance or suspected non-compliance or exceedance of action levels and give an indication of the range of levels in case of follow-up by confirmatory methods. They are not suitable for purposes such as evaluation of background levels, estimation of intake, following of time trends in levels or re-evaluation of action and maximum levels.

(b) Confirmatory methods

Confirmatory methods allow the unequivocal identification and quantification of PCDD/Fs and dioxin-like PCBs present in a sample and provide full information on congener basis. Therefore, those methods allow the control of maximum and action levels, including the confirmation of results obtained by screening methods. Furthermore, results may be used for other purposes such as determination of low background levels in food monitoring, following of time trends, exposure assessment of the population and building of a database for possible re-evaluation of action and maximum levels. They are also important for establishing congener patterns in order to identify the source of a possible contamination. Such methods utilise GC-HRMS. For confirming compliance or non-compliance with the maximum level, also GC-MS/MS can be used.

2. BACKGROUND

For calculation of TEQ concentrations, the concentrations of the individual substances in a given sample shall be multiplied by their respective TEF, as established by the World Health Organisation and listed in the Appendix to this Annex, and subsequently summed to give the total concentration of dioxin-like compounds expressed as TEQs.

Screening and confirmatory methods may only be applied for control of a certain matrix if the methods are sensitive enough to detect levels reliably at the maximum or action level.

3. QUALITY ASSURANCE REQUIREMENTS

- Measures must be taken to avoid cross-contamination at each stage of the sampling and analysis procedure.
- The samples must be stored and transported in glass, aluminum, polypropylene or polyethylene containers suitable for storage without any influence on the levels of PCDD/Fs and dioxin-like PCBs in the samples. Traces of paper dust must be removed from the sample container.
- The sample storage and transportation has to be performed in a way that maintains the integrity of the foodstuff sample.
- Insofar as relevant, finely grind and mix thoroughly each laboratory sample using a process that has been demonstrated to achieve complete homogenisation (e.g. ground to pass a 1 mm sieve); samples have to be dried before grinding if moisture content is too high.
- Control of reagents, glassware and equipment for possible influence of TEQ- or BEQ-based results is of general importance.
- A blank analysis shall be performed by carrying out the entire analytical procedure omitting only the sample.
- For bioanalytical methods, it is of great importance that all glassware and solvents used in analysis shall be tested to be free of compounds that interfere with the detection of target compounds in the working range. Glassware shall be rinsed with solvents or/and heated at temperatures suitable to remove traces of PCDD/Fs, dioxin-like compounds and interfering compounds from its surface.
- Sample quantity used for the extraction must be sufficient to fulfill the requirements with respect to a sufficiently low working range including the concentrations of maximum or action levels.
- The specific sample preparation procedures used for the products under consideration shall follow internationally accepted guidelines.
- In the case of fish, the skin has to be removed as the maximum level applies to muscle meat without skin. However it is necessary that all remaining muscle meat and fat tissue on the inner side of the skin are carefully and completely scraped off from the skin and added to the sample to be analysed.

4. REQUIREMENTS FOR LABORATORIES

- In accordance with the provisions of Regulation (EC) No 882/2004, laboratories shall be accredited by a recognised body operating in accordance with ISO Guide 58 to ensure that they are applying analytical quality assurance. Laboratories shall be accredited following the EN ISO/IEC 17025 standard. The principles as described in the Technical Guidelines for the estimation of measurement uncertainty and limits of quantification for PCDD/F and PCB analysis shall be followed when applicable ⁽¹⁾.
- Laboratory proficiency shall be proven by the continuous successful participation in interlaboratory studies for the determination of PCDD/Fs and dioxin-like PCBs in relevant food matrices and concentration ranges.
- Laboratories applying screening methods for routine control of samples shall establish a close cooperation with laboratories applying the confirmatory method, both for quality control and confirmation of the analytical result of suspected samples.

5. BASIC REQUIREMENTS TO BE MET BY ANALYTICAL PROCEDURE FOR DIOXINS (PCDD/Fs) AND DIOXIN-LIKE PCBs

5.1. Low working range and limits of quantification

- For PCDD/Fs, detectable quantities have to be in the upper femtogram (10^{-15} g) range because of extreme toxicity of some of these compounds. For most PCB congeners limit of quantification in the nanogram (10^{-9} g) range is already sufficient. However, for the measurement of the more toxic dioxin-like PCB congeners (in particular non-ortho-substituted congeners) the lower end of the working range must reach the low picogram (10^{-12} g) levels.

⁽¹⁾ Guidance Document on Measurement Uncertainty for Laboratories performing PCDD/F and PCB Analysis using Isotope Dilution Mass Spectrometry [link to website], Guidance Document on the Estimation of LOD and LOQ for Measurements in the Field of Contaminants in Feed and Food [link to website].

5.2. High selectivity (specificity)

- A distinction is required between PCDD/Fs and dioxin-like PCBs and a multitude of other, coextracted and possibly interfering compounds present at concentrations up to several orders of magnitude higher than those of the analytes of interest. For gas chromatography/mass spectrometry (GC-MS) methods, a differentiation among various congeners is necessary, such as between toxic (e.g. the seventeen 2,3,7,8-substituted PCDD/Fs, and twelve dioxin-like PCBs) and other congeners.
- Bioanalytical methods shall be able to detect the target compounds as the sum of PCDD/Fs, and/or dioxin-like PCBs. Sample clean-up shall aim at removing compounds causing false non-compliant results or compounds that may decrease the response, causing false-compliant results.

5.3. High accuracy (trueness and precision, bioassay apparent recovery)

- For GC-MS methods, the determination shall provide a valid estimate of the true concentration in a sample. High accuracy (accuracy of the measurement: the closeness of the agreement between the result of a measurement with the true or assigned value of the measurand) is necessary to avoid the rejection of a sample analysis result on the basis of poor reliability of the determined TEQ level. Accuracy is expressed as trueness (difference between the mean value measured for an analyte in a certified material and its certified value, expressed as percentage of this value) and precision (RSD_R relative standard deviation calculated from results generated under reproducibility conditions).
- For bioanalytical methods, the bioassay apparent recovery shall be determined.

5.4. Validation in the range of maximum level and general quality control measures

- Laboratories shall demonstrate the performance of a method in the range of the maximum level, e.g. 0,5×, 1× and 2× the maximum level with an acceptable coefficient of variation for repeated analysis, during the validation procedure and/or during routine analysis.
- Regular blank controls and spiking experiments or analysis of control samples (preferably, if available, certified reference material) shall be performed as internal quality control measures. Quality control (QC) charts for blank controls, spiking experiments or analysis of control samples shall be recorded and checked to make sure the analytical performance is in accordance with the requirements.

5.5. Limit of quantification

- For a bioanalytical screening method, establishment of the LOQ is not an indispensable requirement but the method shall prove that it can differentiate between the blank and the cut-off value. When providing a BEQ-level, a reporting level shall be established to deal with samples showing a response below this level. The reporting level shall be demonstrated to be different from procedure blank samples at least by a factor of three, with a response below the working range. It shall therefore be calculated from samples containing the target compounds around the required minimum level, and not from a S/N ratio or an assay blank.
- Limit of quantification (LOQ) for a confirmatory method shall be about one fifth of the maximum level.

5.6. Analytical criteria

- For reliable results from confirmatory or screening methods, the following criteria must be met in the range of the maximum level for the TEQ value respectively the BEQ value, whether determined as total TEQ or total BEQ (as sum of PCDD/F and dioxin-like PCBs) or separately for PCDD/Fs and dioxin-like PCBs.

	Screening with bioanalytical or physico-chemical methods	Confirmatory methods
False-compliant rate (*)	< 5 %	
Trueness		- 20 % to + 20 %

	Screening with bioanalytical or physico-chemical methods	Confirmatory methods
Repeatability (RSD _r)	< 20 %	
Intermediate precision (RSD _R)	< 25 %	< 15 %

(*) With respect to the maximum levels

5.7. Specific requirements for screening methods

- Both GC-MS and bioanalytical methods may be used for screening. For GC-MS methods the requirements as laid down in point 6 are to be used. For cell-based bioanalytical methods specific requirements are laid down in point 7.
- Laboratories applying screening methods for routine control of samples shall establish a close cooperation with laboratories applying the confirmatory method.
- Performance verification of the screening method is required during routine analysis, by analytical quality control and ongoing method validation. There must be a continuous programme for control of compliant results.
- Check on possible suppression of the cell response and cytotoxicity.

20 % of the sample extracts shall be measured in routine screening without and with TCDD added corresponding to the maximum or action level, to check if the response is possibly suppressed by interfering substances present in the sample extract. The measured concentration of the spiked sample is compared to the sum of the concentration of the unspiked extract plus the spiking concentration. If this measured concentration is more than 25 % lower than the calculated (sum) concentration, this is an indication of a potential signal suppression and the respective sample must be submitted to confirmatory analysis. Results shall be monitored in quality control charts.

- Quality control on compliant samples

Approximately 2 % to 10 % of the compliant samples, depending on sample matrix and laboratory experience, shall be confirmed.

- Determination of false-compliant rates from QC data

The rate of false-compliant results from screening of samples below and above the maximum level or the action level shall be determined. Actual false-compliant rates shall be below 5 %.

After a minimum of 20 confirmed results per matrix/matrix group is available from the quality control of compliant samples, conclusions on the false-compliant rate shall be drawn from this database. The results from samples analysed in ring trials or during contamination incidents, covering a concentration range up to, e.g. 2× the maximum level (ML), may also be included in the minimum of 20 results for evaluation of the false-compliant rate. The samples shall cover most frequent congener patterns, representing various sources.

Although screening assays shall preferentially aim to detect samples exceeding the action level, the criterion for determining false-compliant rates is the maximum level, taking into account the expanded measurement uncertainty of the confirmatory method.

- Potential non-compliant results from screening shall always be verified by a full re-analysis of the original sample by a confirmatory method. These samples may also be used to evaluate the rate of false non-compliant results. For screening methods, the rate of false non-compliant results is the fraction of results confirmed to be compliant from confirmatory analysis, while in previous screening the sample had been declared to be suspected to be non-compliant. However, evaluation of the advantageousness of the screening method shall be based on comparison of false non-compliant samples with the total number of samples checked. This rate shall be low enough to make the use of a screening tool advantageous.

- At least under validation conditions, bioanalytical methods shall provide a valid indication of the TEQ level, calculated and expressed as BEQ.
 - Also for bioanalytical methods carried out under repeatability conditions, the intra-laboratory RSD_r would typically be smaller than the reproducibility RSD_R.
6. SPECIFIC REQUIREMENTS FOR GC-MS METHODS TO BE COMPLIED WITH FOR SCREENING OR CONFIRMATORY PURPOSES
- 6.1. **Acceptable differences between upperbound and lowerbound WHO-TEQ levels**
- The difference between upperbound level and lowerbound level shall not exceed 20 % for confirmation of the exceedance of maximum or in case of need of action levels.
- 6.2. **Control of recoveries**
- Addition of ¹³C-labelled 2,3,7,8-chlorine-substituted internal PCDD/F standards and of ¹³C-labelled internal dioxin-like PCB standards must be carried out at the very beginning of the analytical method, e.g. prior to extraction, in order to validate the analytical procedure. At least one congener for each of the tetra- to octa-chlorinated homologous groups for PCDD/Fs and at least one congener for each of the homologous groups for dioxin-like PCBs must be added (alternatively, at least one congener for each mass spectrometric selected ion recording function used for monitoring PCDD/Fs and dioxin-like PCBs). In case of confirmatory methods, all seventeen ¹³C-labelled 2,3,7,8-substituted internal PCDD/F standards and all twelve ¹³C-labelled internal dioxin-like PCB standards shall be used.
 - Relative response factors shall also be determined for those congeners for which no ¹³C-labelled analogue is added by using appropriate calibration solutions.
 - For foodstuffs of plant origin and foodstuffs of animal origin containing less than 10 % fat, the addition of the internal standards is mandatory prior to extraction. For foodstuffs of animal origin containing more than 10 % fat, the internal standards may be added either before or after fat extraction. An appropriate validation of the extraction efficiency shall be carried out, depending on the stage at which internal standards are introduced and on whether results are reported on product or fat basis.
 - Prior to GC-MS analysis, one or two recovery (surrogate) standard(s) must be added.
 - Control of recovery is necessary. For confirmatory methods, the recoveries of the individual internal standards shall be in the range of 60 to 120 %. Lower or higher recoveries for individual congeners, in particular for some hepta- and octa- chlorinated dibenzo-p-dioxins and dibenzofurans, are acceptable on the condition that their contribution to the TEQ value does not exceed 10 % of the total TEQ value (based on sum of PCDD/F and dioxin-like PCBs). For GC-MS screening methods, the recoveries shall be in the range of 30 to 140 %.
- 6.3. **Removal of interfering substances**
- Separation of PCDD/Fs from interfering chlorinated compounds such as non-dioxin-like PCBs and chlorinated diphenyl ethers shall be carried out by suitable chromatographic techniques (preferably with a florisil, alumina and/or carbon column).
 - Gas-chromatographic separation of isomers shall be sufficient (< 25 % peak to peak between 1,2,3,4,7,8-HxCDF and 1,2,3,6,7,8-HxCDF).
- 6.4. **Calibration with standard curve**
- The range of the calibration curve shall cover the relevant range of maximum or action levels.
- 6.5. **Specific criteria for confirmatory methods**
- For GC-HRMS:

In HRMS, the resolution shall typically be greater than or equal to 10 000 for the entire mass range at 10 % valley.

Fulfilment of further identification and confirmation criteria as described in internationally recognised standards, for example, in standard EN 16215:2012 (Animal feed — Determination of dioxins and dioxin-like PCBs by GC/HRMS and of indicator PCBs by GC/HRMS) and/or in EPA methods 1613 and 1668 as revised.

— For GC-MS/MS:

Monitoring of at least two specific precursor ions, each with one specific corresponding transition product ion for all labelled and unlabelled analytes in the scope of analysis.

Maximum permitted tolerance of relative ion intensities of $\pm 15\%$ for selected transition product ions in comparison to calculated or measured values (average from calibration standards), applying identical MS/MS conditions, in particular collision energy and collision gas pressure, for each transition of an analyte.

Resolution for each quadrupole to be set equal to or better than unit mass resolution (unit mass resolution: sufficient resolution to separate two peaks one mass unit apart) in order to minimise possible interferences on the analytes of interest.

Fulfilment of the further criteria as described in internationally recognised standards, for example, in standard EN 16215:2012 (Animal feed — Determination of dioxins and dioxin-like PCBs by GC/HRMS and of indicator PCBs by GC/HRMS) and/or in EPA methods 1613 and 1668 as revised, except the obligation to use GC-HRMS.

7. SPECIFIC REQUIREMENTS FOR BIOANALYTICAL METHODS

Bioanalytical methods are methods based on the use of biological principles like cell-based assays, receptor-assays or immunoassays. This point establishes requirements for bioanalytical methods in general.

A screening method in principle classifies a sample as compliant or suspected to be non-compliant. For this, the calculated BEQ level is compared to the cut-off value (see point 7.3). Samples below the cut-off value are declared compliant, samples equal or above the cut-off value as suspected to be non-compliant, requiring analysis by a confirmatory method. In practice, a BEQ level corresponding to two-thirds of the maximum level may serve as cut-off value provided that a false-compliant rate below 5 % and an acceptable rate for false non-compliant results are ensured. With separate maximum levels for PCDD/Fs and for the sum of PCDD/Fs and dioxin-like PCBs, checking compliance of samples without fractionation requires appropriate bioassay cut-off values for PCDD/Fs. For checking of samples exceeding the action levels, an appropriate percentage of the respective action level would suit as cut-off value.

If an indicative level is expressed in BEQs, the results from the the sample must be given in the working range and exceeding the reporting limit (see points 7.1.1 and 7.1.6).

7.1. Evaluation of the test response

7.1.1. General requirements

— When calculating the concentrations from a TCDD calibration curve, values at the higher end of the curve will show a high variation (high coefficient of variation (CV)). The working range is the area where this CV is smaller than 15 %. The lower end of the working range (reporting limit) must further be set significantly (at least by a factor of three) above the procedure blanks. The upper end of the working range is usually represented by the EC_{70} value (70 % of maximal effective concentration), but lower if the CV is higher than 15 % in this range. The working range shall be established during validation. Cut-off values (see point 7.3) must be within the working range.

— Standard solutions and sample extracts shall be tested in triplicate or at least in duplicate. When using duplicates, a standard solution or a control extract tested in four to six wells divided over the plate shall produce a response or concentration (only possible in the working range) based on a $CV < 15\%$.

7.1.2. Calibration

7.1.2.1. Calibration with standard curve

- Levels in samples may be estimated by comparison of the test response with a calibration curve of TCDD (or PCB 126 or a PCDD/F/dioxin-like PCB standard mixture) to calculate the BEQ level in the extract and subsequently in the sample.
- Calibration curves shall contain 8 to 12 concentrations (at least in duplicates), with enough concentrations in the lower part of the curve (working range). Special attention shall be paid to the quality of the curve-fit in the working range. As such, the R^2 value is of little or no value in estimating the goodness of fit in nonlinear regression. A better fit will be achieved by minimising the difference between calculated and observed levels in the working range of the curve (e.g. by minimising the sum of squared residuals).
- The estimated level in the sample extract is subsequently corrected for the BEQ level calculated for a matrix or solvent blank sample (to account for impurities from solvents and chemicals used), and the apparent recovery (calculated from the BEQ level of suitable reference samples with representative congener patterns around the maximum or action level). For performing a recovery correction, the apparent recovery must always be within the required range (see point 7.1.4). Reference samples used for recovery correction must comply with requirements as given in point 7.2.

7.1.2.2. Calibration with reference samples

Alternatively, a calibration curve prepared from at least four reference samples (see point 7.2: one matrix blank, plus three reference samples at 0,5×, 1,0× and 2,0× the maximum or action level may be used, eliminating the need to correct for blank and recovery if matrix properties of the reference samples match those of the unknown samples. In this case, the test response corresponding to two-thirds of the maximum level (see point 7.3) may be calculated directly from these samples and used as cut-off value. For checking of samples exceeding the action levels, an appropriate percentage of these action levels would suit as cut-off value.

7.1.3. Separate determination of PCDD/Fs and dioxin-like PCBs

Extracts may be split into fractions containing PCDD/Fs and dioxin-like PCBs, allowing a separate indication of PCDD/Fs and dioxin-like PCB TEQ levels (in BEQs). A PCB 126 standard calibration curve shall preferentially be used to evaluate results for the fraction containing dioxin-like PCBs.

7.1.4. Bioassay apparent recoveries

The 'bioassay apparent recovery' shall be calculated from suitable reference samples with representative congener patterns around the maximum or action level and expressed as percentage of the BEQ level in comparison to the TEQ level. Depending on the type of assay and TEFs⁽¹⁾ used, the differences between TEF and REP factors for dioxin-like PCBs may cause low apparent recoveries for dioxin-like PCBs in comparison to PCDD/Fs. Therefore, if a separate determination of PCDD/Fs and dioxin-like PCBs is performed, bioassay apparent recoveries shall be: for dioxin-like PCBs 20 % to 60 %, for PCDD/Fs 50 % to 130 % (ranges apply for TCDD calibration curve). As the contribution of dioxin-like PCBs to the sum of PCDD/Fs and dioxin-like PCBs may vary between different matrices and samples, bioassay apparent recoveries for the sum parameter reflect these ranges and shall be between 30 % to 130 %.

7.1.5. Control of recoveries for clean-up

The loss of compounds during the clean-up shall be checked during validation. A blank sample spiked with a mixture of the different congeners shall be submitted to clean-up (at least $n = 3$) and the recovery and variability checked by a confirmatory method. The recovery shall be within 60 to 120 % especially for congeners contributing more than 10 % to the TEQ-level in various mixtures.

(1) Current requirements are based on the TEFs published in: M. Van den Berg et al, Toxicol Sci 93 (2), 223-241 (2006).

7.1.6. Reporting Limit

When reporting BEQ levels, a reporting limit shall be determined from relevant matrix samples involving typical congener patterns, but not from the calibration curve of the standards due to low precision in the lower range of the curve. Effects from extraction and clean-up must be taken into account. The reporting limit must be set significantly (at least by a factor of three) above the procedure blanks.

7.2. Use of reference samples

- Reference samples shall represent sample matrix, congener patterns and concentration ranges for PCDD/Fs and dioxin-like PCBs around the maximum or action level.
- A procedure blank, or preferably a matrix blank, and a reference sample at the maximum or action level have to be included in each test series. These samples must be extracted and tested at the same time under identical conditions. The reference sample must show a clearly elevated response in comparison to the blank sample, thus ensuring the suitability of the test. Those samples may be used for blank and recovery corrections.
- Reference samples chosen for performing a recovery correction shall be representative for the test samples, meaning that congener patterns shall not lead to an underestimation of levels.
- Extra reference samples at, e.g. 0,5× and 2× the maximum or action level may be included to demonstrate the proper performance of the test in the range of interest for the control of the maximum or action level. Combined, these samples may be used for calculating the BEQ-levels in test samples (see point 7.1.2.2).

7.3. Determination of cut-off values

The relationship between bioanalytical results in BEQ and results from confirmatory methods in TEQ shall be established (e.g. by matrix-matched calibration experiments, involving reference samples spiked at 0, 0,5×, 1× and 2× the maximum level (ML), with six repetitions on each level (n = 24)). Correction factors (blank and recovery) may be estimated from this relationship but shall be checked in each test series by including procedure/matrix blanks and recovery samples (see point 7.2).

Cut-off values shall be established for decision over sample compliance with maximum levels or for control of action levels, if of interest, with the respective maximum or action levels set for either PCDD/Fs and dioxin-like PCBs alone, or for the sum of PCDD/Fs and dioxin-like PCBs. They are represented by the lower endpoint of the distribution of bioanalytical results (corrected for blank and recovery) corresponding to the decision limit of the confirmatory method based on a 95 % level of confidence, implying a false-compliant rate < 5 %, and on a $RSD_R < 25$ %. The decision limit of the confirmatory method is the maximum level, taking into account the expanded measurement uncertainty.

In practice, the cut-off value (in BEQ) may be calculated from the following approaches (see Figure 1):

7.3.1. Use of the lower band of the 95 % prediction interval at the decision limit of the confirmatory method

$$\text{Cut-off value} = \text{BEQ}_{\text{DL}} - s_{y,x} \times t_{\alpha, f = m - 2} \sqrt{1/n + 1/m + (x_i - \bar{x})^2 / Q_{xx}}$$

with:

BEQ_{DL}	BEQ corresponding to the decision limit of the confirmatory method, being the ML taking into account the expanded measurement uncertainty
$s_{y,x}$	residual standard deviation
$t_{\alpha, f = m - 2}$	student factor ($\alpha = 5$ %, $f =$ degrees of freedom, single-sided)
m	total number of calibration points (index j)
n	number of repetitions on each level

x_i sample concentration (in TEQ) of calibration point i determined by a confirmatory method

\bar{x} mean of the concentrations (in TEQ) of all calibration samples

$$Q_{xx} = \sum_{j=1}^m (x_j - \bar{x})^2 \text{ square sum parameter}$$

i = index for calibration point i

7.3.2. Calculation from bioanalytical results (corrected for blank and recovery) of multiple analyses of samples ($n \geq 6$) contaminated at the decision limit of the confirmatory method, as the lower endpoint of the data distribution at the corresponding mean BEQ value:

$$\text{Cut-off value} = \text{BEQ}_{\text{DL}} - 1,64 \times \text{SD}_R$$

with

SD_R standard deviation of bioassay results at BEQ_{DL} , measured under within-laboratory reproducibility conditions

7.3.3. Calculation as mean value of bioanalytical results (in BEQ, corrected for blank and recovery) from multiple analysis of samples ($n \geq 6$) contaminated at two-thirds of the maximum or action level. This is based on the observation that this level will be around the cut-off determined under point 7.3.1 or 7.3.2.

Calculation of cut-off values based on a 95 % level of confidence implying a false-compliant rate $< 5 \%$, and a $\text{RSD}_R < 25 \%$:

1. from the lower band of the 95 % prediction interval at the decision limit of the confirmatory method,
2. from multiple analysis of samples ($n \geq 6$) contaminated at the decision limit of the confirmatory method as the lower endpoint of the data distribution (represented in the figure by a bell-shaped curve) at the corresponding mean BEQ value.

Figure 1

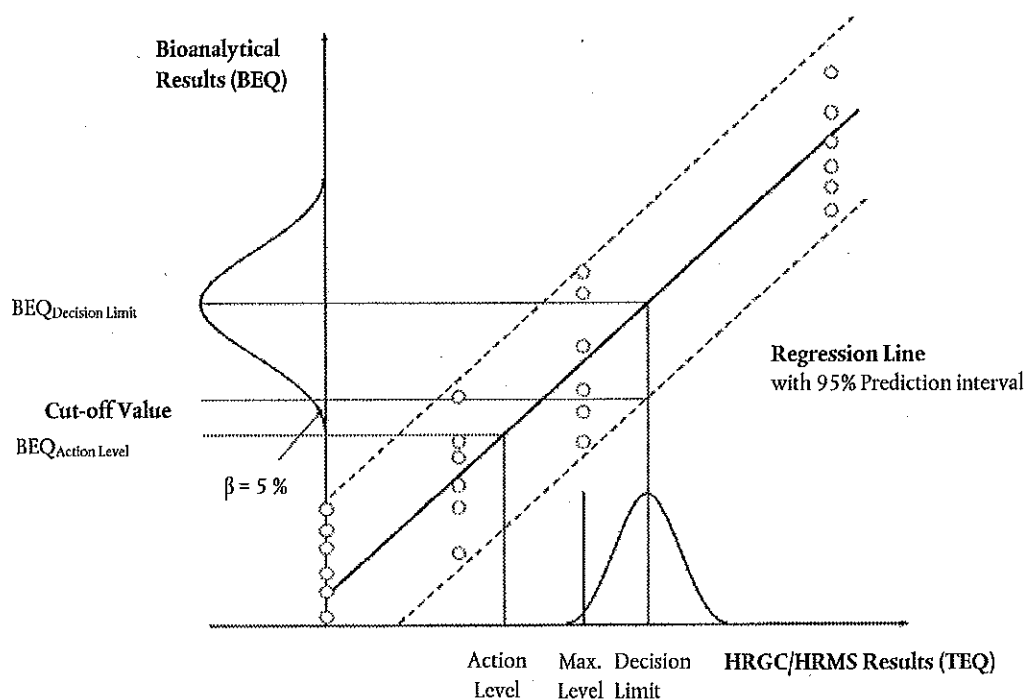

7.3.4. Restrictions to cut-off values

BEQ-based cut-off values calculated from the RSD_r achieved during validation using a limited number of samples with different matrix/congener patterns may be higher than the TEQ-based maximum or action levels due to a better precision than attainable in routine when an unknown spectrum of possible congener patterns has to be controlled. In such cases, cut-off values shall be calculated from an $RSD_r = 25\%$, or two-thirds of the maximum or action level shall be preferred.

7.4. Performance characteristics

- Since no internal standards can be used in bioanalytical methods, tests on repeatability shall be carried out to obtain information on the standard deviation within and between test series. Repeatability shall be below 20 % and intra-laboratory reproducibility shall be below 25 %. This shall be based on the calculated levels in BEQs after blank and recovery correction.
- As part of the validation process, the test must be shown to discriminate between a blank sample and a level at the cut-off value, allowing the identification of samples above the corresponding cut-off value (see point 7.1.2).
- Target compounds, possible interferences and maximum tolerable blank levels shall be defined.
- The per cent standard deviation in the response or concentration calculated from the response (only possible in working range) of a triplicate determination of a sample extract shall not be above 15 %.
- The uncorrected results of the reference sample(s) expressed in BEQs (blank and at the maximum or action level) shall be used for evaluation of the performance of the bioanalytical method over a constant time period.
- QCcharts for procedure blanks and each type of reference sample shall be recorded and checked to make sure the analytical performance is in accordance with the requirements, in particular for the procedure blanks with regard to the requested minimum difference to the lower end of the working range and for the reference samples with regard to within-laboratory reproducibility. Procedure blanks must be well controlled in order to avoid false-compliant results when subtracted.
- The results from the confirmatory methods of suspected samples and 2 to 10 % of the compliant samples (minimum of 20 samples per matrix) shall be collected and used to evaluate the performance of the screening method and the relationship between BEQs and TEQs. This database might be used for re-evaluation of cut-off values applicable to routine samples for the validated matrices.
- Successful method performance may also be demonstrated by participation in ring trials. The results from samples analysed in ring trials, covering a concentration range up to, e.g. $2 \times ML$, may also be included in the evaluation of the false-compliant rate, if a laboratory is able to demonstrate its successful performance. The samples shall cover most frequent congener patterns, representing various sources.
- During incidents, the cut-off values may be re-evaluated, reflecting the specific matrix and congener patterns of this single incident.

8. REPORTING OF THE RESULT

Confirmatory methods

- The analytical results shall contain the levels of the individual PCDD/F and dioxin-like PCB congeners and TEQ-values shall be reported as lower-bound, upper-bound and medium-bound in order to include a maximum of information in the reporting of the results and thereby enabling the interpretation of the results according to specific requirements.
- The report shall also include the method used for extraction of PCDD/Fs, dioxin-like PCBs and lipids. The lipid content of the sample shall be determined and reported for food matrices with maximum levels expressed on fat basis and with an expected fat concentration in the range of 0-2 % (in correspondence to existing legislation). For other samples, the determination of the lipid content is optional.

- The recoveries of the individual internal standards must be made available in case the recoveries are outside the range mentioned in point 6.2 where the maximum level is exceeded (in this case, the recoveries for one of the two duplicate analysis) and in other cases upon request.
- As the expanded measurement uncertainty is to be taken into account when deciding about the compliance of a sample, this parameter shall also be made available. Thus, analytical results shall be reported as $x \pm U$ whereby x is the analytical result and U is the expanded measurement uncertainty using a coverage factor of 2 which gives a level of confidence of approximately 95 %. In case of a separate determination of PCDD/Fs and dioxin-like-PCBs the sum of the estimated expanded uncertainty of the separate analytical results of PCDD/Fs and dioxin-like PCBs has to be used for the sum of PCDD/Fs and dioxin-like PCBs.
- The results shall be expressed in the same units and with the same number of significant figures as the maximum levels laid down in Regulation (EC) No 1881/2006.

Bioanalytical screening methods

- The result of the screening shall be expressed as compliant or suspected to be non-compliant ('suspected').
- In addition, an indicative result for PCDD/F and/or dioxin-like PCBs expressed in BEQ (not TEQ) may be given (see point 1). Samples with a response below the reporting limit shall be expressed as lower than the reporting limit. Samples with a response above the working range shall be reported as exceeding the working range and the level corresponding to the upper end of the working range shall be given in BEQ.
- For each type of sample matrix, the report shall mention the maximum or action level on which the evaluation is based.
- The report shall mention the type of test applied, the basic test principle and kind of calibration.
- The report shall also include the method used for extraction of PCDD/Fs, dioxin-like PCBs and lipids. The lipid content of the sample shall be determined and reported for food matrices with maximum levels expressed on fat basis and with an expected fat concentration in the range of 0-2 % (in correspondence to existing legislation). For other samples, the determination of the lipid content is optional.
- In the case of samples suspected to be non-compliant, the report needs to include a note on the action to be taken. The concentration of PCDD/Fs and the sum of PCDD/Fs and dioxin-like PCBs in those samples with elevated levels has to be determined/confirmed by a confirmatory method.
- Non-compliant results shall only be reported from confirmatory analysis.

Physico-chemical screening methods

- The result of the screening shall be expressed as compliant or suspected to be non-compliant ('suspected').
- For each type of sample matrix, the report shall mention the maximum or action level on which the evaluation is based.
- In addition, levels for individual PCDD/F and/or dioxin-like PCB congeners and TEQ-values reported as lower-bound, upper-bound and medium-bound may be given. The results shall be expressed in the same units and with (at least) the same number of significant figures as the maximum levels laid down in Regulation (EC) No 1881/2006.
- The recoveries of the individual internal standards must be made available in case the recoveries are outside the range mentioned in point 6.2 and in other cases upon request.
- The report shall mention the GC-MS method applied.
- The report shall also include the method used for extraction of PCDD/Fs, dioxin-like PCBs and lipids. The lipid content of the sample shall be determined and reported for food matrices with maximum levels expressed on fat basis and with an expected fat concentration in the range of 0-2 % (in correspondence to existing legislation). For other samples, the determination of the lipid content is optional.

-
- In case of samples suspected to be non-compliant, the report needs to include a note on the action to be taken. The concentration of PCDD/Fs and the sum of PCDD/Fs and dioxin-like PCBs in those samples with elevated levels has to be determined/confirmed by a confirmatory method.
 - Non-compliance can only be decided after confirmatory analysis.

Appendix

WHO-TEFs for human risk assessment based on the conclusions of the World Health Organisation (WHO) 0151 International Programme on Chemical Safety (IPCS) expert meeting which was held in Geneva in June 2005 ⁽¹⁾

Congener	TEF value	Congener	TEF value
Dibenzo-p-dioxins ('PCDDs')		'Dioxin-like' PCBs	
		Non-ortho PCBs + Mono-ortho PCBs	
2,3,7,8-TCDD	1		
1,2,3,7,8-PeCDD	1	Non-ortho PCBs	
1,2,3,4,7,8-HxCDD	0,1	PCB 77	0,0001
1,2,3,6,7,8-HxCDD	0,1	PCB 81	0,0003
1,2,3,7,8,9-HxCDD	0,1	PCB 126	0,1
1,2,3,4,6,7,8-HpCDD	0,01	PCB 169	0,03
OCDD	0,0003		
Dibenzofurans ('PCDFs')		Mono-ortho PCBs	
2,3,7,8-TCDF	0,1	PCB 105	0,00003
1,2,3,7,8-PeCDF	0,03	PCB 114	0,00003
2,3,4,7,8-PeCDF	0,3	PCB 118	0,00003
1,2,3,4,7,8-HxCDF	0,1	PCB 123	0,00003
1,2,3,6,7,8-HxCDF	0,1	PCB 156	0,00003
1,2,3,7,8,9-HxCDF	0,1	PCB 157	0,00003
2,3,4,6,7,8-HxCDF	0,1	PCB 167	0,00003
1,2,3,4,6,7,8-HpCDF	0,01	PCB 189	0,00003
1,2,3,4,7,8,9-HpCDF	0,01		
OCDF	0,0003		

Abbreviations used: 'T' = tetra; 'Pe' = penta; 'Hx' = hexa; 'Hp' = hepta; 'O' = octa; 'CDD' = chlorodibenzodioxin; 'CDF' = chlorodibenzofuran; 'CB' = chlorobiphenyl.

⁽¹⁾ Martin van den Berg et al., The 2005 World Health Organisation Re-evaluation of Human and Mammalian Toxic Equivalency Factors for Dioxins and Dioxin-like Compounds. Toxicological Sciences 93(2), 223-241 (2006).

ANNEX IV

SAMPLE PREPARATION AND REQUIREMENTS FOR METHODS OF ANALYSIS USED IN CONTROL OF THE LEVELS OF NON-DIOXIN-LIKE PCBs IN CERTAIN FOODSTUFFS

The requirements set out in this Annex shall be applied where foodstuffs are analysed for the official control of the levels of non-dioxin-like PCBs and as regards sample preparation and analytical requirements for other regulatory purposes, including the controls performed by the food business operator to ensure compliance with the provisions in Article 4 of Regulation (EC) No 852/2004.

The provisions on sample preparation provided for in point 3 of Annex III of this Regulation shall also be applicable for the control of the levels of non-dioxin-like PCBs in food.

1. Applicable detection methods

Gas Chromatography/Electron Capture Detection (GC-ECD), GC-LRMS, GC-MS/MS, GC-HRMS or equivalent methods.

2. Identification and confirmation of analytes of interest:

- Relative retention time in relation to internal standards or reference standards (acceptable deviation of $\pm 0,25$ %).
- Gas chromatographic separation of the non-dioxin-like PCBs (from interfering substances, especially co-eluting PCBs, in particular if levels of samples are in the range of legal limits and non-compliance is to be confirmed ⁽¹⁾).
- For GC-MS techniques:
 - Monitoring of at least the following number of molecular ions or characteristic ions from the molecular cluster:
 - two specific ions for HRMS,
 - three specific ions for LRMS,
 - two specific precursor ions, each with one specific corresponding transition product ion for MS-MS.
 - Maximum permitted tolerances for abundance ratios for selected mass fragments:

Relative deviation of abundance ratio of selected mass fragments from theoretical abundance or calibration standard for target ion (most abundant ion monitored) and qualifier ion(s): ± 15 %.
- For GC-ECD:

Confirmation of results exceeding the maximum level with two GC columns with stationary phases of different polarity.

3. Demonstration of performance of method:

Validation in the range of the maximum level (0,5 to 2 times the maximum level) with an acceptable coefficient of variation for repeated analysis (see requirements for intermediate precision in point 8).

4. Limit of quantification:

The sum of the LOQs ⁽²⁾ of non-dioxin-like PCBs shall not be higher than one-third of the maximum level ⁽³⁾.

5. Quality control:

Regular blank controls, analysis of spiked samples, quality control samples, participation in interlaboratory studies on relevant matrices.

⁽¹⁾ Congeners often found to co-elute are, e.g. PCB 28/31, PCB 52/69 and PCB 138/163/164. For GC-MS also possible interferences from fragments of higher chlorinated congeners have to be considered.

⁽²⁾ The principles as described in the 'Guidance Document on the Estimation of LOD and LOQ for Measurements in the Field of Contaminants in Feed and Food' [link to website] shall be followed when applicable.

⁽³⁾ It is highly recommendable to have a lower contribution of the reagent blank level to the level of a contaminant in a sample. It is in the responsibility of the laboratory to control the variation of blank levels, in particular, if the blank levels are subtracted.

6. Control of recoveries:

- Use of suitable internal standards with physico-chemical properties comparable to analytes of interest.
- Addition of internal standards:
 - Addition to products (before extraction and clean-up process),
 - Addition also possible to extracted fat (before clean-up process), if maximum level is expressed on fat basis.
- Requirements for methods using all six isotope-labelled non-dioxin-like PCB congeners:
 - Correction of results for recoveries of internal standards,
 - Generally acceptable recoveries of isotope-labelled internal standards are between 60 and 120 %,
 - Lower or higher recoveries for individual congeners with a contribution to the sum of non-dioxin-like PCBs below 10 % are acceptable.
- Requirements for methods using not all six isotope-labelled internal standards or other internal standards:
 - Control of recovery of internal standard(s) for every sample,
 - Acceptable recoveries of internal standard(s) between 60 and 120 %,
 - Correction of results for recoveries of internal standards.
- The recoveries of unlabelled congeners shall be checked by spiked samples or quality control samples with concentrations in the range of the maximum level. Acceptable recoveries for these congeners are between 60 and 120 %.

7. Requirements for laboratories

In accordance with the provisions of Regulation (EC) No 882/2004, laboratories shall be accredited by a recognised body operating in accordance with ISO Guide 58 to ensure that they are applying analytical quality assurance. Laboratories shall be accredited following the EN ISO/IEC 17025 standard. In addition, the principles as described in Technical Guidelines for the estimation of measurement uncertainty and limits of quantification for PCB analysis shall be followed when applicable ⁽¹⁾.

8. Performance characteristics: Criteria for the sum of non-dioxin-like PCBs at the maximum level

	Isotope dilution mass spectrometry ^(*)	Other techniques
Trueness	- 20 to + 20 %	- 30 to + 30 %
Intermediate precision (RSD _R)	≤ 15 %	≤ 20 %
Difference between upper and lower bound calculation	≤ 20 %	≤ 20 %

^(*) Use of all six ¹³C-labelled analogues as internal standards required

9. Reporting of results

- The analytical results shall contain the levels of the individual non-dioxin-like PCB congeners and the sum of non-dioxin-like PCBs, reported as lower-bound, upper-bound and medium-bound, in order to include a maximum of information in the reporting of the results and thereby enabling the interpretation of the results according to specific requirements.

⁽¹⁾ 'Guidance Document on Measurement Uncertainty for Laboratories performing PCDD/F and PCB Analysis using Isotope Dilution Mass Spectrometry' [link to website], 'Guidance Document on the Estimation of LOD and LOQ for Measurements in the Field of Contaminants in Feed and Food' [link to website].

-
- The report shall also include the method used for the extraction of PCBs and lipids. The lipid content of the sample shall be determined and reported for food matrices with maximum levels expressed on fat basis and with an expected fat concentration in the range of 0-2 % (in correspondence to existing legislation). For other samples, the determination of the lipid content is optional.
 - The recoveries of the individual internal standards must be made available in case the recoveries are outside the range mentioned in point 6, in case the maximum level is exceeded and in other cases upon request.
 - As the expanded measurement uncertainty is to be taken into account when deciding about the compliance of a sample, that parameter shall also be made available. Thus, analytical results shall be reported as $x \pm U$ whereby x is the analytical result and U is the expanded measurement uncertainty using a coverage factor of 2 which gives a level of confidence of approximately 95 %.
 - The results shall be expressed in the same units and with the same number of significant figures as the maximum levels laid down in Regulation (EC) No 1881/2006.

Annex V:

Official Journal of the European Union

**COMMISSION REGULATION (EU) No 1259/2011
of 2 December 2011**

**amending Regulation (EC) No 1881/2006 as regards maximum levels for dioxins, dioxin-like
PCBs and non dioxin-like PCBs in foodstuffs**

COMMISSION REGULATION (EU) No 1259/2011

of 2 December 2011

amending Regulation (EC) No 1881/2006 as regards maximum levels for dioxins, dioxin-like PCBs and non dioxin-like PCBs in foodstuffs

(Text with EEA relevance)

THE EUROPEAN COMMISSION,

Having regard to the Treaty on the Functioning of the European Union,

Having regard to Council Regulation (EEC) No 315/93 of 8 February 1993 laying down Community procedures for contaminants in food ⁽¹⁾, and in particular Article 2(3) thereof,

Whereas:

- (1) Commission Regulation (EC) No 1881/2006 of 19 December 2006 setting maximum levels for certain contaminants in foodstuffs ⁽²⁾ sets maximum levels for dioxins and dioxin-like PCBs in a range of foodstuffs.
- (2) Dioxins belong to a group of 75 polychlorinated dibenzo-p-dioxin (PCDD) congeners and 135 polychlorinated dibenzofuran (PCDF) congeners, of which 17 are of toxicological concern. Polychlorinated biphenyls (PCBs) are a group of 209 different congeners which can be divided into two groups according to their toxicological properties: 12 congeners exhibit toxicological properties similar to dioxins and are therefore often referred to as 'dioxin-like PCBs' (DL-PCB). The other PCBs do not exhibit dioxin-like toxicity but have a different toxicological profile and are referred to as 'non dioxin-like PCB' (NDL-PCB).
- (3) Each congener of dioxins or DL-PCBs exhibits a different level of toxicity. In order to be able to sum up the toxicity of these different congeners, the concept of toxic equivalency factors (TEFs) was introduced to facilitate risk assessment and regulatory control. As a result the analytical results relating to all the individual dioxin and dioxin-like PCB congeners of toxicological concern are expressed in terms of a quantifiable unit, namely the TCDD toxic equivalent (TEQ).
- (4) The World Health Organisation (WHO) held an expert workshop on 28 to 30 June 2005 concerning the TEF values, agreed by WHO in 1998. A number of TEF values were changed, notably for PCBs, octachlorinated congeners and pentachlorinated furans. The data on the effect of the new TEF values and the recent occurrence are compiled in the European Food Safety Authority's

(EFSA) scientific report 'Results of the monitoring of dioxin levels in food and feed' ⁽³⁾. Therefore, it is appropriate to review the maximum levels of PCBs taking into account these new data.

- (5) The Scientific Panel on Contaminants in the Food Chain of the EFSA on a request from the Commission has adopted an opinion on the presence of NDL-PCBs in feed and food ⁽⁴⁾.
- (6) The sum of the six marker or indicator PCBs (PCB 28, 52, 101, 138, 153 and 180) comprises about half of the amount of total NDL-PCB present in feed and food. That sum is considered as an appropriate marker for occurrence and human exposure to NDL-PCB and therefore should be set as a maximum level.
- (7) Maximum levels have been established taking into account recent occurrence data compiled in the EFSA scientific report 'Results of the monitoring of non dioxin-like PCBs in food and feed' ⁽⁵⁾. Although it is possible to achieve lower limits of quantification (LOQ), it can be observed that a considerable number of laboratories apply an LOQ of 1 µg/kg fat or even 2 µg/kg fat. Expressing the analytical result as an upperbound level would result in some cases in a level close to the maximum level if very strict maximum levels would be established, even if no PCBs have been quantified. It was also acknowledged that for certain food categories the data were not very extensive. Therefore, it would be appropriate to review the maximum levels in 3 years time, based upon a more extensive database obtained with a method of analysis with sufficient sensitivity for quantifying low levels.
- (8) Derogations have been granted to Finland and Sweden to place on the market fish originating in the Baltic region and intended for consumption in their territory with dioxin levels higher than the maximum levels established for dioxins and the sum of dioxins and DL-PCBs in fish. Those Member States have fulfilled the conditions as regards the provision of information to consumers on dietary recommendations. Every year they communicate to the Commission the results of their monitoring of the levels of dioxins in fish from the Baltic region and the measures to reduce human exposure to dioxins from the Baltic region.

⁽¹⁾ OJ L 37, 13.2.1993, p. 1.

⁽²⁾ OJ L 364, 20.12.2006, p. 5.

⁽³⁾ *EFSA Journal* 2010; 8(3):1385, <http://www.efsa.europa.eu/en/efsajournal/doc/1385.pdf>

⁽⁴⁾ *EFSA Journal* (2005) 284, p. 1, <http://www.efsa.europa.eu/en/efsajournal/doc/284.pdf>

⁽⁵⁾ *EFSA Journal* 2010; 8(7):1701, <http://www.efsa.europa.eu/en/efsajournal/doc/1701.pdf>

- (9) On the basis of the results of monitoring of levels of dioxins and DL-PCBs carried out by Finland and Sweden, the derogation granted could be limited to certain fish species. Given the persistent presence of dioxins and PCBs in the environment and consequently in fish it is appropriate to grant this derogation without a time limit.
- (10) As regards wild caught salmon, Latvia has requested a similar derogation as that granted to Finland and Sweden. To that end, Latvia has demonstrated that human exposure to dioxins and DL-PCBs in its territory is not higher than the highest average level in any of the Member States and that it has a system in place to ensure that consumers are fully informed of dietary recommendations with regard to restrictions on the consumption of fish from the Baltic region by identified vulnerable sections of the population in order to avoid potential health risks. Furthermore, monitoring of the levels of dioxins and DL-PCBs in fish from the Baltic region should be carried out and the results and measures that have been taken to reduce human exposure to dioxins and DL-PCBs from fish from the Baltic region should be reported to the Commission. The necessary measures have been put in place ensuring that fish and fish products not complying with EU maximum levels for PCBs are not marketed in other Member States.
- (11) Given that the contamination pattern of NDL-PCBs in fish from the Baltic region show similarities with the contamination of dioxins and DL-PCBs and given that also NDL-PCBs are very persistent in the environment, it is appropriate to grant a similar derogation as regards the presence of NDL-PCBs as for dioxins and DL-PCBs in fish from the Baltic region.
- (12) EFSA has been requested to provide scientific opinion as regards the presence of dioxins and dioxin-like PCBs in sheep and deer liver and the appropriateness to establish maximum levels for dioxins and PCBs in liver and derived products on product basis rather than on a fat basis, as is currently the case. Therefore, the provisions on liver and derived products should be reviewed in particular the provisions as regards sheep and deer liver once the EFSA opinion is available. In the meantime it is appropriate to set the maximum level for dioxins and PCBs on a fat basis.
- (13) Foods with less than 1 % fat were until now excluded from the maximum level for dioxins and DL-PCBs, given that those foods are generally minor contributors to the human exposure. However, there have been cases with food containing less than 1 % fat but with very high levels of dioxins and DL-PCBs in the fat. Therefore, it is appropriate to apply the maximum level to such foods, but on a product basis. Taking into account that a maximum level is established on product basis for certain low fat containing foods, it is appropriate to apply a maximum level on product basis for foods containing less than 2 % fat.
- (14) In the light of the monitoring data for dioxins and DL-PCBs in foods for infants and young children it is appropriate to set specific lower maximum levels for dioxins and DL-PCBs in foods for infants and young children. The Federal Institute for Risk Assessment from Germany has addressed to EFSA a specific request to assess the risk for infants and young children of the presence of dioxins and dioxin-like PCBs in foods for infants and young children. Therefore, the provisions on foods for infants and young children should be reviewed once the EFSA opinion is available.
- (15) The measures provided for in this Regulation are in accordance with the opinion of the Standing Committee on the Food Chain and Animal Health and neither the European Parliament nor the Council have opposed them,

HAS ADOPTED THIS REGULATION:

Article 1

Regulation (EC) No 1881/2006 is amended as follows:

(1) Article 7 is amended as follows:

- (a) The title '**Temporary derogations**' is replaced by '**Derogations**';
- (b) paragraph 4 is replaced by the following:

'4. By way of derogation from Article 1, Finland, Sweden and Latvia may authorise the placing on their market of wild caught salmon (*Salmo salar*) and products thereof originating in the Baltic region and intended for consumption in their territory with levels of dioxins and/or dioxin-like PCBs and/or non-dioxin-like PCBs higher than those set out in point 5.3 of the Annex, provided that a system is in place to ensure that consumers are fully informed of the dietary recommendations with regard to the restrictions on the consumption of wild caught salmon from the Baltic region and products thereof by identified vulnerable sections of the population in order to avoid potential health risks.

Finland, Sweden and Latvia shall continue to apply the necessary measures to ensure that wild caught salmon and products thereof not complying with point 5.3 of the Annex are not marketed in other Member States.

Finland, Sweden and Latvia will report yearly to the Commission the measures they have taken to effectively inform the identified vulnerable sections of the population of the dietary recommendations and to ensure that wild caught salmon and products thereof not compliant with the maximum levels is not marketed in other Member States. They shall furthermore provide evidence of the effectiveness of these measures.;

(c) the following paragraph 5 is added:

‘5. By way of derogation from Article 1, Finland and Sweden may authorise the placing on their market of wild caught herring larger than 17 cm (*Clupea harengus*), wild caught char (*Salvelinus* spp.), wild caught river lamprey (*Lampetra fluviatilis*) and wild caught trout (*Salmo trutta*) and products thereof originating in the Baltic region and intended for consumption in their territory with levels of dioxins and/or dioxin-like PCBs and/or non dioxin-like PCBs higher than those set out in point 5.3 of the Annex, provided that a system is in place to ensure that consumers are fully informed of the dietary recommendations with regard to the restrictions on the consumption of wild caught herring larger than 17 cm, wild caught char, wild caught river lamprey and wild caught trout from the Baltic region and products thereof by identified vulnerable sections of the population in order to avoid potential health risks.

Finland and Sweden shall continue to apply the necessary measures to ensure that wild caught herring larger than 17 cm, wild caught char, wild caught river

lamprey and wild caught trout and products thereof not complying with point 5.3 of the Annex are not marketed in other Member States.

Finland and Sweden will report yearly to the Commission the measures they have taken to effectively inform the identified vulnerable sections of the population of the dietary recommendations and to ensure that fish and products thereof not compliant with the maximum levels is not marketed in other Member States. They shall furthermore provide evidence of the effectiveness of these measures.’;

(2) the Annex is amended in accordance with the Annex to this Regulation.

Article 2

This Regulation shall enter into force on the 20th day following its publication in the *Official Journal of the European Union*.

It shall apply from 1 January 2012.

This Regulation shall be binding in its entirety and directly applicable in all Member States.

Done at Brussels, 2 December 2011.

For the Commission

The President

José Manuel BARROSO

ANNEX

Section 5: Dioxins and PCBs of the Annex to Regulation (EC) No 1881/2006 is amended as follows:

(a) Section 5: Dioxins and PCBs is replaced by the following:

'Section 5: Dioxins and PCBs ⁽³¹⁾

Foodstuffs		Maximum levels		
		Sum of dioxins (WHO-PCDD/F-TEQ) ⁽³²⁾	Sum of dioxins and dioxin-like PCBs (WHO-PCDD/F-PCB-TEQ) ⁽³²⁾	Sum of PCB28, PCB52, PCB101, PCB138, PCB153 and PCB180 (ICES - 6) ⁽³²⁾
5.1	Meat and meat products (excluding edible offal) of the following animals ⁽⁶⁾ :			
	— bovine animals and sheep	2,5 pg/g fat ⁽³³⁾	4,0 pg/g fat ⁽³³⁾	40 ng/g fat ⁽³³⁾
	— poultry	1,75 pg/g fat ⁽³³⁾	3,0 pg/g fat ⁽³³⁾	40 ng/g fat ⁽³³⁾
	— pigs	1,0 pg/g fat ⁽³³⁾	1,25 pg/g fat ⁽³³⁾	40 ng/g fat ⁽³³⁾
5.2	Liver of terrestrial animals referred to in 5.1 ⁽⁶⁾ , and derived products thereof,	4,5 pg/g fat ⁽³³⁾	10,0 pg/g fat ⁽³³⁾	40 ng/g fat ⁽³³⁾
5.3	Muscle meat of fish and fishery products and products thereof ⁽²⁵⁾ ⁽³⁴⁾ , with the exemption of: <ul style="list-style-type: none"> — wild caught eel — wild caught fresh water fish, with the exception of diadromous fish species caught in fresh water — fish liver and derived products — marine oils <p>The maximum level for crustaceans applies to muscle meat from appendages and abdomen ⁽⁴⁴⁾. In case of crabs and crab-like crustaceans (<i>Brachyura</i> and <i>Anomura</i>) it applies to muscle meat from appendages.</p>	3,5 pg/g wet weight	6,5 pg/g wet weight	75 ng/g wet weight
5.4	Muscle meat of wild caught fresh water fish, with the exception of diadromous fish species caught in fresh water, and products thereof ⁽²⁵⁾	3,5 pg/g wet weight	6,5 pg/g wet weight	125 ng/g wet weight
5.5	Muscle meat of wild caught eel (<i>Anguilla anguilla</i>) and products thereof	3,5 pg/g wet weight	10,0 pg/g wet weight	300 ng/g wet weight
5.6	Fish liver and derived products thereof with the exception of marine oils referred to in point 5.7	—	20,0 pg/g wet weight ⁽³⁸⁾	200 ng/g wet weight ⁽³⁸⁾
5.7	Marine oils (fish body oil, fish liver oil and oils of other marine organisms intended for human consumption)	1,75 pg/g fat	6,0 pg/g fat	200 ng/g fat
5.8	Raw milk ⁽⁶⁾ and dairy products ⁽⁶⁾ , including butter fat	2,5 pg/g fat ⁽³³⁾	5,5 pg/g fat ⁽³³⁾	40 ng/g fat ⁽³³⁾

Foodstuffs		Maximum levels		
		Sum of dioxins (WHO-PCDD/F-TEQ) ⁽³²⁾	Sum of dioxins and dioxin-like PCBs (WHO-PCDD/F-PCB-TEQ) ⁽³²⁾	Sum of PCB28, PCB52, PCB101, PCB138, PCB153 and PCB180 (ICES – 6) ⁽³²⁾
5.9	Hen eggs and egg products ⁽⁶⁾	2,5 pg/g fat ⁽³³⁾	5,0 pg/g fat ⁽³³⁾	40 ng/g fat ⁽³³⁾
5.10	Fat of the following animals:			
	— bovine animals and sheep	2,5 pg/g fat	4,0 pg/g fat	40 ng/g fat
	— poultry	1,75 pg/g fat	3,0 pg/g fat	40 ng/g fat
	— pigs	1,0 pg/g fat	1,25 pg/g fat	40 ng/g fat
5.11	Mixed animal fats	1,5 pg/g fat	2,50 pg/g fat	40 ng/g fat
5.12	Vegetable oils and fats	0,75 pg/g fat	1,25 pg/g fat	40 ng/g fat
5.13	Foods for infants and young children ⁽⁴⁾	0,1 pg/g wet weight	0,2 pg/g wet weight	1,0 ng/g wet weight'

(b) footnote 31 is replaced by the following:

⁽³¹⁾ Dioxins (sum of polychlorinated dibenzo-para-dioxins (PCDDs) and polychlorinated dibenzofurans (PCDFs), expressed as World Health Organisation (WHO) toxic equivalent using the WHO-toxic equivalency factors (WHO-TEFs)) and sum of dioxins and dioxin-like PCBs (sum of PCDDs, PCDFs and polychlorinated biphenyls (PCBs), expressed as WHO toxic equivalent using the WHO-TEFs). WHO-TEFs for human risk assessment based on the conclusions of the World Health Organization (WHO) – International Programme on Chemical Safety (IPCS) expert meeting which was held in Geneva in June 2005 (Martin van den Berg et al., The 2005 World Health Organization Re-evaluation of Human and Mammalian Toxic Equivalency Factors for Dioxins and Dioxin-like Compounds. Toxicological Sciences 93(2), 223–241 (2006))

Congener	TEF value	Congener	TEF value
Dibenzo-p-dioxins ('PCDDs')		"Dioxin-like" PCBs Non-ortho PCBs + Mono-ortho PCBs	
2,3,7,8-TCDD	1		
1,2,3,7,8-PeCDD	1	<i>Non-ortho PCBs</i>	
1,2,3,4,7,8-HxCDD	0,1	PCB 77	0,0001
1,2,3,6,7,8-HxCDD	0,1	PCB 81	0,0003
1,2,3,7,8,9-HxCDD	0,1	PCB 126	0,1
1,2,3,4,6,7,8-HpCDD	0,01	PCB 169	0,03
OCDD	0,0003		
Dibenzofurans ('PCDFs')		<i>Mono-ortho PCBs</i>	
2,3,7,8-TCDF	0,1	PCB 105	0,00003
1,2,3,7,8-PeCDF	0,03	PCB 114	0,00003
2,3,4,7,8-PeCDF	0,3	PCB 118	0,00003
1,2,3,4,7,8-HxCDF	0,1	PCB 123	0,00003
1,2,3,6,7,8-HxCDF	0,1	PCB 156	0,00003
1,2,3,7,8,9-HxCDF	0,1	PCB 157	0,00003
2,3,4,6,7,8-HxCDF	0,1	PCB 167	0,00003
1,2,3,4,6,7,8-HpCDF	0,01	PCB 189	0,00003
1,2,3,4,7,8,9-HpCDF	0,01		
OCDF	0,0003		

Abbreviations used: "T" = tetra; "Pe" = penta; "Hx" = hexa; "Hp" = hepta; "O" = octa; "CDD" = chlorodibenzodioxin; "CDF" = chlorodibenzofuran; "CB" = chlorobiphenyl.

(c) footnote 33 is replaced by the following:

⁽³³⁾ The maximum level expressed on fat is not applicable for foods containing < 2 % fat. For foods containing less than 2 % fat, the maximum level applicable is the level on product basis corresponding to the level on product basis for the food containing 2 % fat, calculated from the maximum level established on fat basis, making use of following formula:

Maximum level expressed on product basis for foods containing less than 2 % fat = maximum level expressed on fat for that food x 0,02.

Annex VI:

**Recommended Method on
MICROWAVE DIGESTION OF MARINE SAMPLES
FOR THE DETERMINATION
OF TRACE ELEMENT CONTENT**



REPORT

Recommended Method on MICROWAVE DIGESTION OF MARINE SAMPLES FOR THE DETERMINATION OF TRACE ELEMENT CONTENT

IAEA/NAEL

**Marine Environmental Studies Laboratory in co-operation with
UNEP/MAP MED POL**

November 2011

For further information on this method, please contact:

IAEA-Environment Laboratories
Marine Environmental Studies Laboratory
4a Quai Antoine 1er
MC-98000 Principality of Monaco

Tel. (377) 979 772 72 Fax. (377) 979 772 73

E-mail: NAEL-MESL.Contact-Point@iaea.org

Recommended Method on
MICROWAVE DIGESTION OF MARINE SAMPLES
FOR THE DETERMINATION OF TRACE ELEMENT CONTENT

DISCLAIMER

This is not an official IAEA publication. The views expressed do not necessarily reflect those of the International Atomic Energy Agency or its Member States.

The material has not undergone an official review by the IAEA. This document should not be quoted or listed as a reference.

The use of particular designations of countries or territories does not imply any judgment by the IAEA, as to the legal status of such countries or territories, of their authorities and institutions or of the delimitation of their boundaries.

The mention of names of specific companies or products (whether or not indicated as registered) does not imply any intention to infringe proprietary rights, nor should it be construed as an endorsement or recommendation on the part of the IAEA.

Limited Distribution

Reproduced by the IAEA

TABLE OF CONTENTS

1. SCOPE	1
2. PRINCIPLE	1
3. SAMPLE PRE-TREATMENT	1
4. REAGENTS	1
5. MATERIAL	2
6. PROCEDURE	2
7. QUALITY CONTROL	5
8. REFERENCES	5

NOTE: This method is not intended to be an analytical training manual. Therefore, the method is written with the assumption that it will be performed by formally trained analytical chemist. Several stages of this procedure are potentially hazardous, especially stages with HF; users should be familiar with the necessary safety precautions.

In addition, the IAEA's recommended methods are intended to be guidance methods that can be used by laboratories as a starting point for generating their own standard operating procedure. If performance data are included in the method, they shall not be used as absolute QC acceptance criteria.

1. SCOPE

The method here below describes the protocol for dissolution of samples from marine origin. Digests are suitable for analyses of total content of trace element in sediment and biological material.

The goal of this method is the total sample decomposition with the judicious choice of acid combinations this is achievable for most matrices. The selection of reagents which give the highest recoveries for the target analytes is considered the optimum method condition.

The recommended protocol is mainly based on the EPA 3052 method; users are encouraged to consult this document (EPA, 1996).

2. PRINCIPLE

The grinded and dried samples are solubilized in an acid mixture using microwave oven apparatus.

The use of hydrofluoric acid allows the decomposition of silicates by reaction of F with Si to form the volatile SiF₄. The excess of hydrofluoric acid is either neutralized by boric acid, or digests are evaporated to dryness depending on the method used to analyze samples.

3. SAMPLE PRE-TREATMENT

Sediment samples are prepared following the recommendations of UNEP (2005).

Marine organisms are prepared following the recommendations of UNEP (1984, 1994).

4. REAGENTS

The reagents used shall meet the purity requirement of the subsequent analyses

- 4.1. ULTRAPUR WATER (type MilliQ).
- 4.2. NITRIC ACID 65%.
- 4.3. HYDROFLUORIC ACID.
- 4.4. HYDROCHLORIC ACID.
- 4.5. BORIC ACID.
- 4.6. HYDROGEN PEROXIDE.

5. MATERIAL

5.1. MICROWAVE APPARATUS

The microwave decomposition system should be temperature controlled. The temperature sensor should be accurate at $\pm 2.5^{\circ}\text{C}$. The calibration of the temperature sensor should be done at least once a year, preferably by the maintenance service of the manufacturer.

The microwave unit should be corrosion resistant.

The unit cavity should be well ventilated and connected to fume cleaner or special neutralizing system.

The method requires microwave transparent and acid resistant material (i.e. PFA, TFM) to be used as reactor. The minimal volume of the vessels should be 45 ml and it should be able to work under the pressure of 800PSI. the reactor system should be equipped with a pressure relief system.

- 5.2. ANALYTICAL BALANCE with 0.001 g precision at least.
- 5.3. FUME HOOD.
- 5.4. LAMINAR FLOW HOOD.
- 5.5. VOLUMETRIC CONTAINERS of 50 ml or 100 ml in polypropylene.
- 5.6. WEIGHING CUP in polyethylene.
- 5.7. PLASTIC SPATULAS.

6. PROCEDURE

- 6.1. All PLASTIC MATERIAL (i.e. volumetric, weighing cup...) should be acid cleaned by soaking in laboratory soap (or 10% alcohol) for at least 24h, followed by 24h of soaking in 10% nitric acid. Stronger acid cleaning protocol could be applied depending on the requirement of the subsequent analyses.
- 6.2. MICROWAVE VESSELS should be at least cleaned after each use by running the same microwave program used for samples with 5 ml of HNO_3 . If the risk of cross contamination is high (i.e. running sandy sediment after organic rich sediment) and/or in the case of long storage, the vessels should be cleaned twice. If available, an acid cleaner

(using acid vapors) can be used as a final cleaning stage. After cleaning, the vessels should be carefully rinsed with water and dried under a laminar flow hood. If a laminar flow hood is not available, vessels should be kept locked in double plastic bag; date of storage should be mentioned on the second bag.

6.3. Accurately weigh 0.1 to 0.5 g of well mixed sample in the microwave vessel.

6.4. In a fume hood, add 5 ml of nitric acid and 2 ml of hydrofluoric acid, close vessels with caps, then it is recommended to let samples react for at least 1 hour (or more if possible). Protect vessels by covering them with plastic bags or place them in a laminar flow hood compatible with acid fume. The quantity of hydrofluoric acid depends on the expected content of silicon dioxide, samples with low concentrations of silicon dioxide (< 10% like plant material to 0% like biological sample) may require less hydrofluoric acid (0.5 ml to 0 ml). Examples of acid quantities for different matrix are listed in table below.

	HF (ml)	HNO ₃ (ml)	HCl (ml)	H ₂ O ₂ (ml)	Boric (g)
Sediment	2	5	2 or 0	2	0.8
Fish	0	5	2 or 0	2	0
Sea plant	0.5	5	2 or 0	2	0

6.5. After room temperature pre-digestion, add 2 ml of hydrogen peroxide and close the reactors as recommended by the microwave manufacturer.

NOTE: The quantity and ratio of reagent can be adapted on a performance based judgment (i.e. visual total digestion, certified reference material results).

- In case of a sample containing high calcium carbonate, the hydrofluoric acid content can be set to 0 to avoid precipitation of insoluble CaF.
- A two stage digestion, using half of the hydrofluoric acid at the first stage and half at the second, could increase recovery and help achieving total decomposition.
- Additional reagent can be added depending on the sample composition to achieve complete dissolution. For example, 2±2 ml of HCl can be added to help the stabilization of As, Sb, Hg, Fe and Al at high level; however HCl might increase analytical difficulties for some techniques (i.e. ICP-MS) (Kingston 1997)
- Only one acid mixture or quantity should be used in a single batch, in the microwave, to insure consistent reaction conditions between all vessels and monitored conditions. This limitation is due to the current practice of monitoring a representative vessel, and applying a uniform microwave field to reproduce these reaction conditions within a group of vessels being simultaneously heated.

6.6. Place the closed reactor in the microwave apparatus, connect temperature and pressure control as specified by the manufacturer. The samples should be heated at 180°C

(minimum) in about 6 minutes and the temperature maintained for at least 10 minutes. The total decomposition is primarily controlled by maintaining samples at 180°C for 10 minutes. The ramping profile can be adapted, especially for safety purpose when very reactive samples are decomposed (i.e. biological material). In that case, it is recommended to increase the ramping time to 10 or 15 minutes. If possible, record temperature and pressure profile. In most samples matrices, pressure should peak between 5 and 15 minutes; profiles can be used to optimize temperature program.

- 6.7. At the end of the temperature profile, let the sample cool until the inside temperature goes down to 60°C, then remove the reactors from the microwave and place them in a ventilated fume hood. The pressure is carefully released following the manufacturer's instruction and reactors are opened.
- 6.8. In the case of removal of hydrofluoric acid excess with boric acid, 0.8 g of boric acid and 15 ml of water are added in the vessel. The quantity of boric acid is proportional to the quantity of hydrofluoric acid (usually 0.4 g for 1 ml should be sufficient). The vessels are closed again and run in the microwave with a program that heat samples at 170°C in 10 minutes and maintain this temperature for 10 minutes.
- 6.9. At the end of the temperature profile, let the sample cool until inside the temperature goes down to 60°C, then remove the reactors from the microwave and place them in a ventilated fume hood. The pressure is carefully released following the manufacturer's instruction and reactors are opened. Transfer the samples in a volumetric container and dilute them to a known volume (or a known weight, this requires to record the tare of each container before).

NOTE: An excess of boric acid will produce cloudy solutions, this might cause problem with sample introduction system of ICP. The use of boric acid will prevent measurement of boron, and possible bias introduced should be carefully investigated.

- If the use of boric acid is not possible, or if it is necessary to reduce the concentration of acid in final solutions, digest can be evaporated to incipient dryness on a hot plate at about 140°C. This stage should be performed in a controlled environment to avoid contamination and acid vapour should be treated. Some microwave oven apparatus can perform evaporation. The residue is then diluted to a known volume in nitric or hydrochloric diluted solution (usually 2% v/v) depending on the subsequent analytical method used.
- In case of insoluble precipitate or residue some extra steps can be performed like the addition of 2 ml of perchloric acid to the solution before evaporation, but this requires doing the evaporation under a specific hood for safety reason. Another option is the addition of 2 ml of concentrated hydrochloric acid, evaporation to near dryness, addition of concentrated nitric acid, evaporation to near dryness and dilution in known volume in 2% nitric acid solution.

Most samples will be totally dissolved by this method with the judicious choice of the acid combinations. A few refractory sample matrix compounds, such as TiO₂, alumina, and other oxides may not be totally dissolved, and in some cases may sequester target analyte elements.

7. QUALITY CONTROL

- 7.1. Each microwave batch should contain at the minimum one certified reference material of representative matrix.
- 7.2. A duplicate or triplicate sample should be processed on a routine basis. A duplicate sample should be processed with each analytical batch or every 10 samples. A duplicate sample should be prepared for each matrix type (i.e. sediment, sea plant, etc.).
- 7.3. A spiked sample should also be included whenever a new sample matrix is being analyzed, especially if no certified reference material is available for that matrix.
- 7.4. Blank samples should be prepared using the same reagents and quantities used in sample preparation, placed in vessels of the same type, and processed with the samples. Each microwave batch should contain at least two blank samples.

8. REFERENCES

EPA (1996) U.S. Environmental Protection Agency, EPA method 3052, Microwave assisted acid digestion of siliceous and organically based matrices Rev 0, December 2007, (<http://www.epa.gov/osw/hazard/testmethods/sw846/pdfs/3052.pdf>).

Kingston, H. M., Haswell, S (1997), Microwave Enhanced Chemistry, ACS Professional Reference.

Book Series; American Chemical Society: Washington, DC, 1997.

UNEP (2005), UNEP (DEC)/MED WG.282/inf.5/Rev1, Method for sediment sampling and analysis, February 2005, UNEP.

UNEP/IOC/IAEA (1984) reference method 7 rev2: Sampling of selected marine organisms and sample preparation for trace metal.

UNEP/IOC/IAEA (1994) reference method 57: Quality assurance and good laboratory practice, UNEP, 1994.

Annex VII:

Recommended method for the determination of selected trace element in samples of marine origin by flame atomic absorption spectrometry



Recommended method for the determination of selected trace element in samples of marine origin by flame atomic absorption spectrometry

Marine Environmental Studies Laboratory in co-operation with MED POL

November 2011

Table of Content

1. SCOPE:.....	3
2. PRINCIPLE:	4
3. SAMPLE PRE-TREATMENT:.....	4
4. REAGENT:.....	4
5. MATERIAL:.....	5
6. INTERFERENCES:.....	5
7. PROCEDURE:.....	7
8. CALCULATION OF RESULTS:	10
9. EXPRESSION OF RESULTS:.....	10
10. References:.....	11

***NOTE:** This recommended method is not intended to be an analytical training manual. Therefore the method is written with the assumption that it will be performed by formally trained analytical chemists.*

In addition the IAEA recommended methods are intended to be guidance methods that can be used by laboratories as a starting point for generating their own standard operating procedure. If performance data are included in the method they must not be used as absolute QC acceptance criteria,

The recommended protocol is mainly based on EPA 7000B method and ISO 11047 users are encouraged to consult this documents (US EPA, 2007; ISO 1998).

1. **SCOPE:**

This recommended method describes a protocol for measurement of Al, Ca, Co, Cr, Cu, Fe, Mg, Mn, Ni, Sr and Zn by flame (direct aspiration) atomic absorption spectrometry. The method is simple, rapid and applicable to a large number of environmental samples. This method is applicable when the element content in the digested solution is above the method limit. This limit will vary with the matrices and instrument model, indicative quantification limits are reported in table 1.

Table 1: Example of lower quantification limit for analyte in reagent water

Element	Lower quantification limit (mg l ⁻¹)
Al	0.5
Ca	0.02
Co	0.06
Cr	0.1
Cu	0.04
Fe	0.05
Mg	0.003
Mn	0.03
Ni	0.07
Sr	0.06
Zn	0.01

2. **PRINCIPLE:**

The method is based on the atomic absorption spectrometric measurement of the element in the mineralised solutions. In direct-aspiration atomic absorption spectrophotometry, the solution is aspirated and atomized in a flame. A light beam from a hollow cathode lamp or an electrodeless discharge lamp is directed through the flame into a monochromator, and onto a detector that measures the amount of absorbed light. Absorption depends upon the presence of free unexcited ground-state atoms in the flame. Because the wavelength of the light beam is characteristic of only the metal being determined, the light energy absorbed by the flame is a measure of the concentration of that metal in the sample. This principle is the basis of atomic absorption spectrophotometry.

3. **SAMPLE PRE-TREATMENT:**

Samples are prepared following the recommended method for microwave digestion of marine samples for determination of trace element content. (IAEA recommended method, 2011).

4. **REAGENT:**

All reagent used should be free of contamination of analyte of interest

4.1. Water: Reagent water (referenced also as water in the text) should be free of contamination

4.2. Caesium chloride solution, 4g l⁻¹: Dissolve 4g of CsCl of at least 99.999% purity in reagent water to 1 liter.

4.3. Caesium-Lanthanum solution: weigh 5.865g of La₂O₃ and 12.67g of CsCl in 100ml container, add 50ml of reagent water and 25ml of HCl and dilute to 100ml. Commercial solution specially produced for AAS may be used.

4.4. Commercial standard solution 1000µg ml⁻¹: Use a certified reference material solution; this solution should be accompanied by a certificate that should include at the minimum the traceability of the certified concentration as well as the expiration date. The density of the solution or the certified content in mg kg⁻¹ should also be defined to allow preparation of the calibration solution by weighing.

5. MATERIAL:

This section does not list common laboratory glassware

5.1. Atomic absorption spectrophotometer: This shall be equipped with: a hollow cathode lamp or an electrode-less discharge lamp appropriate to the element of interest (operated at the current recommended for the lamp by the instrument manufacturer), a background correction system, a burner suitable for an air/acetylene or nitrous oxide/acetylene flame (operated following the manufacturer's instructions). Deuterium background correction is the minimum technical specification acceptable for background correction for the measurement wavelengths below 350 nm.

5.2. Glassware: All glassware, polypropylene, or fluorocarbon (PFA or TFM) containers, including sample bottles, flasks and pipets tips, should be washed in the following sequence -- 24h soaking in laboratory soap (or 10% alcohol) followed by 24h soaking in 10% nitric acid, followed by 10% soaking in water, final rinse in water, drying under laminar flow hood. Cleaned items should be kept in double sealed plastic bags.

If it can be documented through an active analytical quality control program using spiked samples and method blanks that certain steps in the cleaning procedure are not needed for routine samples, those steps may be eliminated from the procedure (i.e. For the levels measured by flame AAS some sterile plastic containers are sufficiently free of contamination in certain analytes.)

5.3. Pipettes: microliter pipettes size ranging from 50 to 10000 μ l as needed. The accuracy and precision of the pipettes used should be checked as a routine every 6 months and obtained results should be compared with the individual certificates.

5.4. Volumetric containers preferably in polypropylene of a suitable precision and accuracy

6. INTERFERENCES:

6.1. The most troublesome type of interference in atomic absorption spectrometry is usually termed "chemical" and is caused by lack of absorption of atoms bound in molecular combination in the flame. This phenomenon can occur when the flame is not sufficiently hot to dissociate the molecule. The addition of chemical buffer (i.e. Lanthanum or calcium) or the use of nitrous oxide/acetylene gas mixture will help to prevent this interference.

6.2. The presence of high dissolved solids in the sample may result in interference from non-atomic absorbance such as light scattering. In the absence of background correction, this can result in false positive, signal contribution from uncorrected background which cannot be compensated by the method of standard addition.

6.3. Ionisation interference occurs when the flame temperature is sufficiently high to generate the removal of an electron from a neutral atom, giving a positively charged ion. This type of interference can generally be controlled by the addition of a large excess (~1mg l⁻¹) of an easily ionized element such as K or Cs.

6.4. Spectral interference can occur when an absorbing wavelength of an element present in the sample, but not being determined, falls within the width of the absorption line of the element of interest. This type of interference may sometimes be reduced by narrowing the slit width.

Specific conditions applied to individual analytes in case of known interferences are displayed in table 2.

Table 2: Instrument parameter

Element	Wavelength (nm)	Flame type	Chemical buffer*	Background	Typical calibration range (mg l ⁻¹)
Al	324.7	acetylene/NO ₂	Caesium chloride	Deuterium	1.5-40
Ca	422.7	acetylene/NO ₂	Caesium Lanthanum		0.02-1.2
Co	240.7	acetylene/air		Deuterium	0.06-4
Cr	357.9	acetylene/NO ₂			0.3-6
Cr	357.9	acetylene/air	Caesium chloride		0.1-6
Cu	324.7	acetylene/air		Deuterium	0.04-3
Fe	248.3	acetylene/air	Caesium chloride	Deuterium	0.05-3
Mg	285.2	acetylene/air	Caesium Lanthanum	Deuterium	0.003-0.3
Mn	279.5	acetylene/air	Caesium Lanthanum	Deuterium	0.03-3
Ni	232.0	acetylene/air		Deuterium	0.07-4
Sr		acetylene/NO ₂	Caesium chloride		0.06-5
Zn	213.9	acetylene/air		Deuterium	0.01-1.5

* see 4.2, 4.3 and 7.4 for use of chemical buffer

7. **PROCEDURE:**

7.1. Sample solution: Use sample prepared following the recommended method for digestion of marine samples for the determination of trace metal (IAEA, 2011)

7.2. Blank solution: Prepare at least two blank solutions with each batch of sample using same procedure than for samples

7.3. Preparation of calibration solutions:

7.3.1. Before each batch of determination prepare by appropriate dilution of $1000\mu\text{g ml}^{-1}$ stock standard solution (4.4) at least 4 standard solutions and one calibration blank solution covering the appropriate range of the linear part of the curve. The calibration standards and calibration blank should be prepared using the same type of acid or combination of acids and at the same concentration as will result in the test portion.

7.3.2. Calibration solutions should be prepared fresh each day.

7.3.3. If necessary intermediate stock standard solutions can be prepared in 10% nitric acid, these solutions should be prepared monthly.

7.3.4. All volumetric material (pipettes and containers) should be of appropriate precision and accuracy, if not available standard solution can be prepared by weighing.

7.3.5. Example of calibration curve are given in table 2.

7.4. Special case: Use of chemical buffer. If a chemical buffer is added, it should be at the same concentration as in the sample solution (7.1), the blank (7.2), calibration blank and standard solutions (7.3) following the recommendation of table 2.

For CsCl add 5ml of 4g l^{-1} for 50 ml of solution (4.2)

For CsLa solution add 0.5ml for 50ml of solution (4.3)

The chemical buffer will be added to a separate portion of sample and blank solutions that will need to be diluted to a known volume.

7.5. Calibration

7.5.1. Set up the atomic absorption spectrometer according to the manufacturer's instructions at the appropriate wavelength using appropriate conditions (see table 2), and with the suitable background correction system in operation.

7.5.2. Aspirate a calibration solution (7.3) and optimize the aspiration conditions, burner height and flame conditions to get the maximum signal.

7.5.3. Adjust the response of the instrument to zero absorbance whilst aspirating water

7.5.4. Aspirate the set of calibration solutions in ascending order and, as a zero member, the blank calibration solution (7.3).

NOTE: Care should be taken to ensure that, when using the more concentrated standards, the absorbance is < 1 , and preferably not more than 0,6.

The calibration curve is automatically plot from instrument software. The obtained curve should be linear with $r < 0.995$.

To correct for the instrumental drift the calibration should be performed every 20 samples or if the calibration verification has failed (7.8.1).

7.6. Aspirate blank (7.2) and sample solutions (7.1) and record their concentrations calculated by software using the calibration curve.

7.7. If the concentration of the test portion exceeds the calibration range dilute the test portion with the blank solution accordingly.

As an option to avoid too big dilution factors and/or to avoid a diluting large number of solutions, if all solutions are exceeding the calibration range, the burner can be turned from 0 to 90° to decrease the instrument's sensitivity. New calibration standard solutions should be prepared to match the sample range and the procedure should be repeated from (7.3).

7.8. Quality control solutions: Quality control solutions as describe below should be measured during the run.

7.8.1. Initial Calibration Verification ICV:

After initial calibration, the calibration curve must be verified by the use of initial calibration verification (ICV) standard.

The ICV standard is a standard solution made from an independent (second source) material at or near midrange. This solution as a calibration standard is prepared using the same type of acid or combination of acids and at the same concentration as will result in the test portion. If a chemical buffer is necessary it should be added in the ICV.

The acceptance criteria for the ICV standard must be $\pm 10\%$ of its true value

If the calibration curve cannot be verified within the specified limits, the cause must be determined and the instrument recalibrated before samples are analyzed. The analysis data for the ICV must be kept on file with the sample analysis

The calibration curve must also be verified at the end of each analysis batch and/or after every 10 samples. If the calibration cannot be verified within the specified limits, the sample analysis must be discontinued, the cause determined and the instrument recalibrated. All samples following the last acceptable test must be reanalyzed.

7.8.2. Blank solution (7.2): Maximum allowed blank concentration should be well documented and if blank solution exceeds this value all samples prepared along the contaminated blank should be prepared again and reanalysed.

7.8.3. Post digestion spike

Each unknown type of sample should be spike to check for potential matrix effect.

This spike is consider as a single point standard addition, and should be performed with a minimum dilution factor. The recovery of spike calculated as equation 1 should be 85-115%. If this test fails it is recommended to run analyses with standard addition method.

Spike solution: mix a fixe volume (V1) of sample solution, and a known volume (V2) of a standard solution of a known concentration (Cstandard)

Unspike solution: mix same fixe volume (V1) of sample solution, and same volume (V2) of reagent water

Measure concentration C (mg l^{-1}) in both solutions on the calibration curve (7.6), and calculate recovery as:

$$\text{Equation 1} \quad C_{\text{spike}} = \frac{C_{\text{standard}} \times V_2}{(V_1 + V_2)}$$

$$\text{Equation 2} \quad R = \frac{C_{\text{Spike Solution}} - C_{\text{Unspike solution}}}{C_{\text{spike}}} \times 100$$

To be valid concentrations of spike and unspike solutions should be in the linearity range of the calibration curve and the Spike concentration (equation 1) should be in the range of 50-150% of the concentration of unspike solution.

7.8.4. Dilution test:

If the analyte concentration is sufficiently high (minimally, a factor of 10 above the lower limit of quantitation after dilution), an analysis of a 1:5

dilution should agree within $\pm 10\%$ of the original determination. If not, then a chemical or physical interference effect should be suspected, and method of standard addition is recommended.

7.8.5. Certified Reference Material:

At least one certified reference material of a representative matrix should be prepared with each batch of sample, the calculated result should fall in the value of the certificate within the coverage uncertainty. (Linsinger, 2010), to show evidence of unbiased result.

Results of CRM should be recorded for quality control purpose and plot in control chart (UNEP/IOC/IAEA 1994).

An example of sequence order with recommended criteria and actions is given in table 3.

8. CALCULATION OF RESULTS:

Results are calculated with equation 3

$$\text{Equation 3: } w(m) = \frac{(\rho_1 - \rho_0)}{m} \times f \times V \times R$$

$w(m)$ mass fraction of element m in the sample in mg kg^{-1}

ρ_1 : concentration of element m in milligrams per liter as measured in the sample solution

ρ_0 : concentration of element m in milligrams per liter as measured in the blank solution

f : is the dilution factor calculated as

$$f = \frac{\text{final volume}}{\text{initial volume}}$$

or equal to 1 if ρ_1 is determined in undiluted solution

R : recovery calculated using CRM (see 7.8.5) or pre digestion spike

9. EXPRESSION OF RESULTS:

The rounding of values will depend of the uncertainty reported with the result; in general for this method no more than two significant figures will be reported.

Uncertainty component should be reported with all results. (ISO 2005, Nordtest 2004)

Example : $w(\text{Zn}) = 8.5 \pm 1.2 \text{ mg kg}^{-1}$

Table 3: Example of an analytical sequence:

Solutions Description	Performance	Action
Calibration blank	< maximum allowed calibration blank value	Stop until resolve
Standard solution 1 -4	$r > 0.995$	recalibrate in the linearity range
ICV	$\pm 10\%$ of true value	Stop until resolve
Sample blank	< maximum allowed blank value	
CRM	Fall in certificate value within coverage uncertainty, or fall within acceptable criteria of the QC chart	Stop until resolve, check Matrix spike and run again with standard addition method if necessary
Matrix Spike	recovery $100\% \pm 15\%$	switch to standard addition, keep record for future analyses of the same matrix
Dilution Test	sample 1 = 5x sample 1 diluted 5x within 10%	switch to standard addition, keep record for future analyses of the same matrix
Unknown Sample 1-10	should \geq standard 1 and \leq standard 4	report as <minimum quantification limit or dilute
ICV	$\pm 10\%$ of true value	Stop until resolve
Unknown Sample 11-20	should \geq standard 1 and \leq standard 4	report as <minimum quantification limit or dilute
Calibration blank	< maximum allowed calibration blank value	Stop until resolve
Standard solution 1 -4	$r > 0.995$	recalibrate in the linearity range
ICV	$\pm 10\%$ of true value	Stop until resolve
Ect....		

10. REFERENCES:

EPA (2007) U.S. Environmental Protection Agency, EPA method 7000B: Flame Atomic Absorption Spectrophotometry, Rev 2, Febuary 2007, (<http://www.epa.gov/osw/hazard/testmethods/sw846/pdfs/7000b.pdf>)

IAEA (2011) IAEA Recommended method for microwave digestion of marines samples for the determination of trace element content, 2011, *in preparation*, available upon request

ISO (1995) Guide to the expression of uncertainty of measurements International Organisation for Standardization: Geneva

ISO (1998) International Standard Organisation 11047:1998 Soil quality- determination of Cadmium, chromium, copper, lead, manganese, nickel and zinc in aqua regia extracts of soil- flame and electrothermal atomic absorption spectrometric methods, ISO geneva

Linsinger, T. (2010), European Commission - Joint Research Centre, Institute for Reference Materials and Measurements (http://www.erm-crm.org/ERM_products/application_notes/application_note_1/Documents/erm_application_note_1_english_rev3.pdf)

Nordtest (2004) Handbook For Calculation Of Measurement Uncertainty In Environmental Laboratories Edition 2 <http://www.nordicinnovation.net/nordtestfiler/tec537.pdf>)

UNEP/IOC/IAEA (1994) reference method 57: Quality assurance and good laboratory practice, UNEP, 1994

Annex VIII:

Recommended method for the determination of selected trace element in samples of marine origin by atomic absorption spectrometry using graphite furnace



Recommended method for the determination of selected trace element in samples of marine origin by atomic absorption spectrometry using graphite furnace

Marine Environmental Studies Laboratory in co-operation with MED POL

November 2011

Table of content

1. SCOPE:.....	3
2. PRINCIPLE:.....	3
3. SAMPLE PRE-TREATMENT:	4
4. REAGENTS:	4
5. MATERIALS:	6
6. INTERFERENCES:	6
7. CHEMICAL MODIFICATION:.....	7
8. PROCEDURE	8
9. CALCULATION OF RESULTS:	14
10. EXPRESSION OF RESULTS:	14
11. REFERENCES:.....	14
Table 1 Approximate characteristic masses and typical working range	3
Table 2 Recommended chemical modifiers	8
Table 3 Example of temperature program	9
Table 4 Example of analytical sequence:	12

***NOTE:** This recommended method is not intended to be an analytical training manual. Therefore the method is written with the assumption that it will be performed by formally trained analytical chemist.*

In addition, the IAEA recommended methods are intended to be guidance methods that can be used by laboratories as a starting point for generating their own standard operating procedure. If performance data are included in the method they must not be used as absolute QC acceptance criteria.

The recommended protocol is mainly based on EPA 7010 method and ISO 15586 users are encouraged to consult this documents (US EPA, 2007; ISO 2003)

1. **SCOPE:**

This International Standard includes principles and procedures for the determination of trace levels of: As, Cd, Co, Cr, Cu, Ni, Pb, and V in samples from marine origin, using atomic absorption spectrometry with electro thermal atomization in a graphite furnace. The method is applicable to the determination of low concentrations of elements. The detection limit of the method for each element depends on the sample matrix as well as the instrument, the type of atomizer and the use of chemical modifiers. Table 1 gives approximate working range and characteristic masses.

Table 1 Approximate characteristic masses and typical working range using 20µl sample volume

Element	Characteristic mass M_0^* pg	Working range ng ml ⁻¹
As	15	5-50
Cd	0.8	0.2-2
Co	10	3-30
Cr	3	2-20
Cu	10	3-30
Ni	13	5-50
Pb	15	5-50
V	35	10-100

**The characteristic mass (m_0) of an element is the mass in pg corresponding to a signal of 0.00044 unity using peak area as integration*

2. **PRINCIPLE:**

An aliquot of sample solution (5-50 μL) is introduced into a graphite tube of the GF AAS and atomized by rapid heating at high temperature. A light beam is directed through the graphite tube, into a monochromator, and onto a detector that measures the amount of light absorbed by the atomized element in the tube. Each metal has its own characteristic wavelength therefore a source hollow cathode lamp composed of that element is used. The amount of energy absorbed at the characteristic wavelength is proportional to the concentration of the element in the sample.

3. **SAMPLE PRE-TREATMENT:**

Samples are prepared following the recommended method for microwave digestion of marine samples for determination of trace element content. (IAEA recommended method, 2011)

4. **REAGENTS:**

4.1. Water: Reagent water (referenced also as water in the text) should be free of contamination

4.2. Concentrated acid solution as used for sample preparation (section 3)

4.3. Commercial standard solution $1000\mu\text{g ml}^{-1}$: Use certified reference material solution; this solution should be accompanied by a certificate that should include at least the traceability of the certified concentration as well as the expiration date. The density of the solution or the certified content in mg kg^{-1} should also be defined to allow preparation of calibration solution by weighing.

4.4. Calibration solutions: Prepare calibration solutions from the standard solutions (4.3) by appropriate dilution. Intermediate standard solutions should be prepared in 2% (v/v) nitric acid. For calibration solution use the same amount of acid as that of the samples solutions.

Calibration solutions below 1 mg/l should not be used for more than one month, and those below 100 $\mu\text{g/l}$ should not be used for more than one day.

4.5. Blank calibration solution: Prepare a blank calibration solution in the same way as the calibration solution but without adding standard. The final amount of acid will be the same as that of the sample solutions.

4.6. Palladium nitrate/magnesium nitrate modifier

Pd(NO₃)₂ solution is commercially available (10 g/l). Dissolve 0,259 g of Mg(NO₃)₂·6H₂O in 100 ml of water. Mix the palladium nitrate solution with twice as much magnesium nitrate solution. 10 µl of the mixed solution is equal to 15 µg Pd and 10 µg Mg(NO₃)₂. The mixture is also commercially available.

Prepare a fresh solution monthly.

4.7. Magnesium nitrate modifier

Dissolve 0,865 g of Mg(NO₃)₂·6H₂O in 100 ml of water. 10 µl of this solution is equal to 50 µg Mg(NO₃)₂.

4.8. Ammonium dihydrogen phosphate modifier

Dissolve 2,0 g of NH₄H₂PO₄ in 100 ml of water. 10 µl of this solution is equal to 200 µg NH₄H₂PO₄.

4.9. Ammonium dihydrogen phosphate/magnesium nitrate modifier

Dissolve 2,0 g of NH₄H₂PO₄ and 0,173 g of Mg(NO₃)₂·6H₂O in 100 ml of water. 10 µl of this solution is equal to 200 µg NH₄H₂PO₄ and 10 µg Mg(NO₃)₂.

4.10. Palladium/Ammonium dihydrogen phosphate/magnesium nitrate modifier

Mix 2ml of Pd(NO₃)₂ solution is commercially available (10 g/l), 2ml of Mg(NO₃)₂ solution prepared as (4.7), 0.5ml of NH₄H₂PO₄ prepared as (4.8) and dilute with water to 10ml. 4µl of this solution is equal to 8µg of Pd, 4µg of Mg(NO₃)₂ and 4µg of NH₄H₂PO₄.

4.11. Nickel modifier

Dissolve 0,200 g of nickel powder in 1 ml concentrated nitric acid and dilute to 100 ml with water. 10 µl of this solution is equal to 20 µg Ni. Solutions of Ni(NO₃)₂ are also commercially available.

4.12. Iridium solution 1000µg ml⁻¹

Use commercial solution (standard)

4.13. Argon

5. MATERIALS:

5.1. Glassware: All glassware, polypropylene, or fluorocarbon (PFA or TFM) containers, including sample bottles, flasks and pipettes tips, should be washed in the following sequence -- 24h soaking in laboratory soap (or 10% alcohol) followed by 24h soaking in 10% nitric acid, followed by 10% soaking in water, final rinsing in water, drying under laminar flow hood. Cleaned items should be kept in double sealed plastic bags

5.2. Pipettes: microliter pipettes size ranging from 50 to 10000 μ l as needed. The accuracy and precision of the pipettes used should be checked as a routine every 6 months and the obtained results should be compared with the individual certificates.

5.3. Volumetric containers preferably in polypropylene of suitable precision and accuracy

5.4. Atomic Absorption Spectrometer equipped with graphite furnace, background correction system and necessary hollow cathode lamp.

5.5. Auto sampler

5.6. Polypropylene cups for automatic sampler cleaned as explained in (5.1)

5.7. Graphite tubes: pyrolytically-coated with platforms, preferably for highly and medium volatile elements, whereas elements of low volatility should be atomized from the wall. Provided satisfactory results are achieved, manufacturer's recommendations regarding the use of graphite tubes and platforms should be followed.

6. INTERFERENCES:

Some sample solutions, may contain large amounts of substances that may affect the results. High concentrations of chloride may cause low results, because the volatility of many elements is increased and analyte loss may occur during the pyrolysis step. Matrix effects may be overcome, partially or completely, by the optimization of the temperature program, the use of pyrolytically-coated tubes and platforms, the use of chemical modifiers, the standard addition technique and the use of background correction.

7. CHEMICAL MODIFICATION:

Chemical modifiers are used to overcome spectral and/or non-spectral interferences in a sample (matrix effects). In general, the aim of chemical modification is to allow a pyrolysis temperature that is high enough to remove the bulk of concomitants before the atomization step. In order to ascertain that the modification works, the spike procedures is performed with and without the addition of a chosen chemical modifier and recovery are compared

Spike experiment:

Spike solution: mix a fixe volume (V1) of sample solution, and a known volume (V2) of a standard solution of a known concentration (C_{standard})

Unspike solution: mix same fixe volume (V1) of sample solution, and same volume (V2) of reagent water

Measure concentration C (mg l⁻¹) in both solutions on the calibration curve, and calculate recovery as:

$$\text{Equation 1} \quad C_{\text{spike}} = \frac{C_{\text{standard}} \times V_2}{(V_1 + V_2)}$$

$$\text{Equation 2} \quad R = \frac{C_{\text{Spike Solution}} - C_{\text{Unspike solution}}}{C_{\text{spike}}} \times 100$$

To be valid concentrations of spike and unspike solutions should be in the linearity range of the calibration curve and Spike concentration (equation 1) should be in the range of 50-150% of the concentration of unspike solution. The recovery should be 100 ± 15%

In Table 2 some recommendations of chemical modifiers are given.

Other chemical modifiers may be used if they show consistent results. Graphite tube can also be pretreated with Iridium (Vasileva 2001) as following:

Inject 50µl of the solution and run the temperature program below

Step	Temperature (°C)	Ramp Time (s)	Hold Time (s)
1	100	5	30
2	1200	20	5
3	100	5	2
4	2500	2	10

Repeat this 3 times, the coating is stable for about 200 injections and can be repeated

If chemical modifiers are used, add them to test samples, sample blank solutions, calibration solutions, and blank calibration solutions. Preferably inject the modifier solution with the auto sampler directly into the atomizer after the sample is delivered.

Table 2 Recommended chemical modifiers

Element	Chemical modifier	Amount* µg
As	Pd + Mg(NO ₃) ₂ or NH ₄ H ₂ PO ₄	15+10 200
Cd	Pd + Mg(NO ₃) ₂ +NH ₄ H ₂ PO ₄ or Ir coating	8+4+4
Co	Pd + Mg(NO ₃) ₂	15+10
Cr	Mg(NO ₃) ₂	50
Cu	None	
Ni	Mg(NO ₃) ₂	50
Pb	Pd + Mg(NO ₃) ₂ +NH ₄ H ₂ PO ₄ or Ir coating	8+4+4
V	None	

*These amounts are only recommendation, significantly lower amounts may be required in some atomizers, see also recommendations from instrument manufacturers.

8. PROCEDURE

8.1. Switch on the instrument and perform the optimization according to the manufacturer's instructions. Install an appropriate graphite tube, and set up the auto sampler.

8.2. Program the graphite furnace and the auto sampler. Examples of temperature program are given in table 3.

Note: Method for specific element and matrix should be developed and all necessary information should be stored with at least:

- *Temperature program*
- *Matrix modifier*
- *Type of graphite tube*
- *Matrix effect*
- *Type of calibration curve*
- *Typical m_0 obtained with the program*
- *Linearity*

Table 3 Example of temperature program

Element	Cu	Cu	Cd	Cd	Pb	Pb	As	As	Cr	Cr
Sample type	Sediment	Biota	Sediment	Biota	Sediment	Biota	Sediment	Biota	Sediment	Biota
Wavelength(nm)	327.4	327.4	228.8	228.8	283.3	283.3	193.7	193.7	357.9	357.9
Graphite tube	Partition Tube	Partition Tube	platform	platform	platform	platform	platform	platform	Partition Tube	Partition Tube
Matrix Modifier	none	none	none	Pd,Mg, Amonium Phosphate	none	Pd,Mg ,Amonium Phosphate	Pd,Mg	Pd,Mg	none	none
Peak Measurement	area	area	area	area	area	area	area	area	area	area
M0(pg/0.0044 UA) on standard	13	13	1	1	16	16	15	15	2.5	2.5
Ashing T° (C°)	700	700	300	700	400	925	1400	1400	1100	1100
Atomisation T° (C°)	2300	2300	1800	1900	2100	2200	2600	2600	2600	2600
Remark							Number of Fire is critical	Standard Addition often required. Number of fire is critical	Use peak Height for lower concentration (peak shape)	Standard Addition often required. Use peak Height for lower concentration (peak shape)

8.3. Generality for measurements:

All measurements should be performed with at least duplicate injections of solutions; the relative standard deviation should be less than 5% for a signal above 0.01 unit of absorbance.

It is recommended to work in peak area.

Check the number of firing and change the graphite tube when appropriate, if graphite tube is changed during a run, the instrument needs to be recalibrated.

8.4. Run the calibration:

8.4.1. **Standard calibration technique:** Perform the calibration with a blank calibration solution (4.5) and 3 to 5 equidistant calibration solutions (4.4) for an appropriate concentration range.

To correct for the instrumental drift calibration should be performed every 10 samples (if possible the option of reslope using the middle standard point should be applied every 5 samples)

Calibration solutions can be prepared by the auto sampler from the highest standard solution, the minimum volume uptake should not be less than 4 μ l.

The blank calibration solution should be free of analyte, or below a well-documented maximum allowed calibration blank value (i.e. validation, control charts..).

It should be stressed that the linearity of the calibration curve is often limited. The calibration curve is automatically plot by instrument software, if linear regression is set checked that $r \leq 0.995$ or switch to second order equation.

8.4.2. **Standard addition method:** This technique involves preparing same aliquots of sample solution with increasing amount of analyte. As describe in section 7 for the spike experiment using an increasing concentration of standard (V1 and V2 should stay the same). The auto sampler can be prograded to perform standard addition. Determine the analyte concentration in the reagent blank solution the same way. Example of standard addition is given in figure 1. The concentration is obtained by dividing the absorbance of zero addition by the slope.

The standard addition should be performed for each type of matrix (i.e. a sediment sample solution cannot be measured with a standard addition curve done on a fish sample solution). For similar sample matrices (i.e. same fish species) the slope obtained with one sample can be used for other measurements respecting recalibration every 10 samples.

For standard addition to be valid the following limitation should be taken into consideration:

- The resulting calibration should be linear ($r \leq 0.995$), software calibration equation is a linear regression
- The additions should represent ideally 50, 100, 150 and 200% of the sample concentration
- The standard addition technic cannot be used to correct for spectral interferences, such as unspecific background absorption, and should not be used if interferences change the signal by a factor of more than three.

Figure 1 Standard addition example

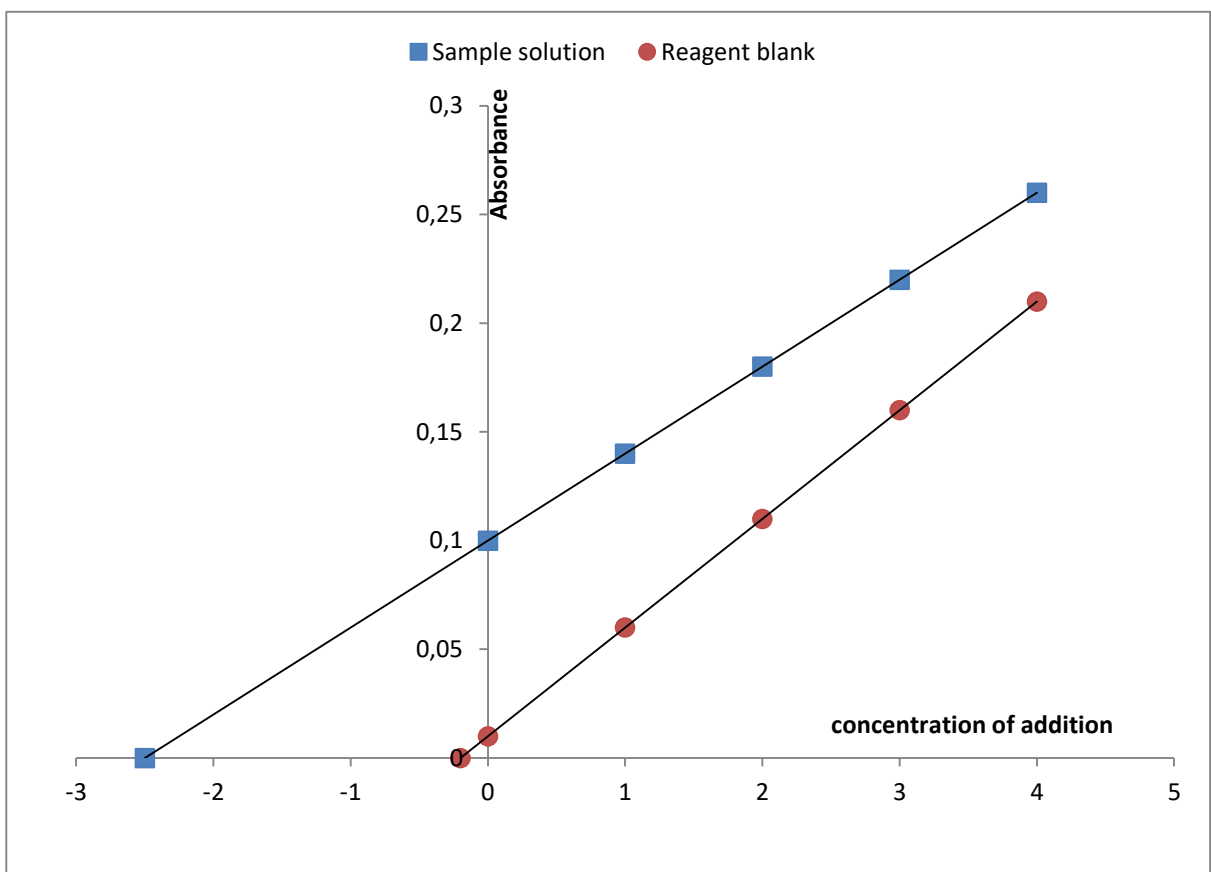

8.5. Measure sample blank and sample solutions (prepared following section 3) record the concentration as calculated by the software and calculate results following equation 3 (section 9), if samples exceed the highest point of calibration dilute appropriately. As an option a smaller volume of solution can be injected to stay under linear range of the instrument.

8.6. Quality control solutions: Quality control solutions as described below should be measured during the run. An example of a sequence order with recommended criteria and action is given in table 4.

Table 4 Example of analytical sequence:

Solutions Description	Performance	Action
Calibration blank	< maximum allowed calibration blank value	Stop until resolve
Standard solution 1 -4	$r > 0.995$	recalibrate in the linearity range
ICV	$\pm 10\%$ of true value	Stop until resolve
Sample blank	< maximum allowed blank value	
CRM	Fall in certificate value within coverage uncertainty, or fall within acceptable criteria of the QC chart	Stop until resolve, check Matrix spike and run again with standard addition method if necessary
Matrix Spike	recovery $100\% \pm 15\%$	switch to standard addition, keep record for future analyses of the same matrix
Dilution Test	sample 1 = 5x sample 1 diluted 5x within 10%	switch to standard addition, keep record for future analyses of the same matrix
Unknown Sample 1-10	should \geq standard 1 and \leq standard 4	report as <minimum quantification limit or dilute

ETC...(restart sequence from calibration blank)

8.6.1. Initial Calibration Verification ICV:

After the initial calibration, the calibration curve must be verified using the initial calibration verification (ICV) standard.

The ICV standard is a standard solution made from an independent (second source) material at or near midrange. This solution as calibration standard is prepared using the same type of acid or combination of acids and at the same concentration as will result in the test portion.

The acceptance criteria for the ICV standard must be $\pm 10\%$ of its true value

If the calibration curve cannot be verified within the specified limits, the cause must be determined and the instrument recalibrated before samples are analyzed.

The analysis data for the ICV must be kept on file with the sample analysis

The calibration curve must also be verified at the end of each analysis batch and/or after every 10 samples. If the calibration cannot be verified within the specified limits, the sample analysis must be discontinued, the cause determined and the instrument recalibrated. All samples following the last acceptable test must be reanalyzed.

8.6.2. **Blank solution (4.5):** Maximum allowed blank concentration should be well documented and if blank solution exceeds this value all samples prepared along the contaminated blank should be prepared again and re analyzed.

8.6.3. **Post digestion spike**

Each unknown type of sample should be spike to check for potential matrix effect.

This spike is consider as a single point standard addition, and should be performed with a minimum dilution factor. Recovery of spike calculated as equation 1 should be 85-115%. If this test failed it is recommended to run analyses with standard addition method. (see section 7 for detail)

8.6.4. **Dilution test:**

If the analyte concentration is sufficiently high (minimally, a factor of 10 above the lower limit of quantitation after dilution), an analysis of a 1:5 dilution should agree within $\pm 10\%$ of the original determination. If not, then a chemical or physical interference effect should be suspected, and method of standard addition is recommended.

8.6.5. **Certified reference material:**

At least one certified reference material of a representative matrix will be prepared with each batch of sample, the calculated result should be comparable with the value of the certificate within the coverage uncertainty.(Linsinger, 2010), to show evidence of unbiased result.

Results of CRM should be record for quality control purpose and plot in control chart (UNEP/IOC/IAEA 1994)

9. CALCULATION OF RESULTS:

Results are calculated with equation 3

$$\text{Equation 3: } w(m) = \frac{(\rho_1 - \rho_0)}{m} \times f \times V \times R$$

w(m) mass fraction of element m in the sample in mg kg⁻¹

ρ1: concentration of element m in milligrams per liter as measured in the sample solution

ρ0: concentration of element m in milligrams per liter as measured in the blank solution

f: is the dilution factor calculated as

$$f = \frac{\text{final volume}}{\text{initial volume}}$$

or equal to 1 if ρ1 is determined in undiluted solution

R: recovery calculated using CRM (see 8.6.5) or pre digestion spike

10. EXPRESSION OF RESULTS:

The rounding of values will depend of the uncertainty reported with the result. Uncertainty component should be reported with all results. (ISO 1995, Nordtest 2004)

Example : w(Pb) = 8.5 ± 1.2 mg kg⁻¹

11. REFERENCES:

EPA (2007) U.S. Environmental Protection Agency, EPA method 7010: Graphite furnace Atomic Absorption Spectrophotometry, Rev 0, February 2007, (<http://www.epa.gov/osw/hazard/testmethods/sw846/pdfs/7010.pdf>)

IAEA (2011) IAEA Recommended method for microwave digestion of marines samples for the determination of trace element content, 2011, *in preparation*, available upon request

ISO (1995) Guide to the expression of uncertainty of measurements International Organisation for Standardization: Geneva

ISO (1998) International Standard Organisation 11047:1998 Soil quality- determination of Cadmium, chromium, copper, lead, manganese, nickel and zinc in aqua regia extracts of soil-flame and electrothermal atomic absorption spectrometric methods, ISO geneva

Linsinger, T. (2010), European Commission - Joint Research Centre, Institute for Reference Materials and Measurements (http://www.erm-crm.org/ERM_products/application_notes/application_note_1/Documents/erm_application_note_1_english_rev3.pdf)

Nordtest (2004) Handbook For Calculation Of Measurement Uncertainty In Environmental Laboratories Edition 2 <http://www.nordicinnovation.net/nordtestfiler/tec537.pdf>)

UNEP/IOC/IAEA (1994) reference method 57: Quality assurance and good laboratory practice, UNEP, 1994

Vasileva. E, Baeten. H, Hoenig. M (2001), Advantages of the iridium permanent modifier in fast programs applied to trace-element analysis of plant samples by electrothermal atomic absorption spectrometry, *Fresenius J Anal Chem* (2001) 369 :491–495

Annex IX:

HELCOM

**Manual for marine monitoring in the COMBINE programme
ANNEX B-12, APPENDIX 4: TECHNICAL NOTE ON THE DETERMINATION OF TRACE
METALLIC ELEMENTS IN BIOTA**

HELCOM Manual for marine monitoring in the COMBINE programme

ANNEX B-12, APPENDIX 4: TECHNICAL NOTE ON THE DETERMINATION OF TRACE METALLIC ELEMENTS IN BIOTA

1. INTRODUCTION

Metallic elements appear in different marine biological matrices in trace concentrations, ranging from the mg/kg through the $\mu\text{g}/\text{kg}$ to the ng/kg level. Stoeppler (1991) provided a comprehensive review of the most frequently used techniques for quantitative analysis of metallic trace elements, such as optical atomic absorption, fluorescence or emission spectrometry, anodic, cathodic or adsorptive stripping voltammetry, isotope dilution mass spectrometry and total reflection X-ray fluorescence, respectively. In spite of the powerful instrumental techniques presently in use, various analytical error sources have to be taken into consideration that may significantly influence the accuracy of the analytical data.

2. WORKING CONDITIONS

For each step of the analytical procedure, contamination of the sample may occur from the environment (laboratory air dust particles and the analyst), from sample containers or packing materials, from instruments used during sample pre-treatment and sample preparation, and from the chemical reagents used for analysis. The predominant purpose of the analytical clean laboratory is to eliminate contamination, which may be airborne or laboratory-induced, as far as possible and to control the total analytical blank.

Contamination by particles from the laboratory air may be controlled by a high-efficiency particulate filter. (A clean room is designed to maintain air with 100 particles per ft^3 or 3.6.103 per m^3 of 0.5 μm particles (class 100 of U.S. Federal Standards 209), or better, preferably with a minimum of activity in the room.) U.S. Federal Standards 209 describes designs for complete laminar flow rooms, clean benches, and fume hoods, and contains information on design, testing, and maintenance of clean rooms, and should be considered an essential reference for those interested in a clean laboratory.

To control the analytical blank for analysis of metallic trace elements, one must not only maintain good laboratory air quality, but also select the appropriate composition and type of construction materials used to build the laboratory. Principally, contaminants must be effectively removed at the source to minimize their uncontrolled distribution in the analytical clean laboratory. Accordingly, the laboratory's walls should be cleaned easily and therefore painted with special metal-free wipe-resistant paints. Surfaces of working areas should be protected with, for example, disposable plastic (polyethylene, PTFE) foils. The floors should, for example, be covered with adhesive plastic mats. Details of the design that are essential for obtaining a working laboratory with low trace element blanks are described by Moody (1982), Mitchell (1982a), Boutron (1990), and Schmidt and Gerwinski (1994).

3. PRETREATMENT OF LABORATORY WARE AND REAGENTS, CONTAMINATION CONTROL

Chemically resistant materials, used in the production of high-quality laboratory ware appropriate for metallic trace element analysis, include low- and high-density polyethylene (LDPE and HDPE), polypropylene (PP), polytetrafluorethylene (PTFE), perfluoralkoxy (PFA), ethylenetetrafluorethylene (ETFE), tetrafluorethylenepolypropylene (FEP), borosilicate and quartz glass, respectively. With appropriate pretreatment and handling, these materials meet the requirements of purity necessary for the required analytical investigations.

Cleaning procedures for plastic and glass laboratory ware were comprehensively dealt with by Moody and Lindstrom (1977), Tschopel et al. (1980), Kosta (1982) and Boutron (1990). Generally, immersion in diluted (10-25 % v/v) high-purity nitric acid at room temperature for a period of one to three days, followed by repeated rinsing with high-purity water, is recommended. Steaming in high-purity acids (predominantly nitric acid) is also very effective to remove impurities from container surfaces and condition them for subsequent analysis.

The materials mentioned above for the production of laboratory ware exhibit some adsorptive or exchange properties. Boundary-surface interactions can be important, particularly when very dilute analytical solutions are being handled, since uncontrollable losses through sorption of element ions can occur (Tschopel et al., 1980; Harms, 1985). Based on this information, it is imperative that volumetric flasks, reagent vessels, pipette tips, etc., for handling samples, sample solutions and low-level reference or analyte solutions must never be used for transferring or processing stock calibration solutions, analyte solutions or concentrated reagents. Considerable quantities of analytes may be adsorbed from such solutions by the respective container surfaces, residuals of which may be leached later when dilute sample or analyte solutions are handled.

The availability of high-purity reagents is a key condition for reliable investigations of metallic trace element concentrations. For many analytical problems, the level of a specific contaminant can adequately be controlled only by applying specific purification methods. The first order of priority in regard to high-purity reagents is a sufficient supply of high-purity water. Ion-exchange units are universally accepted as an effective means of removing dissolved ionic species from water. Since high-purity water is frequently used in metallic trace element analysis, equipment for sustainable production of high-purity water by high-purity mixed-bed ion exchange resins should be available. The next most important group of reagents are mineral acids. Contamination of the sample by residual concentrations of metallic trace elements in the acids used for dissolution or decomposition represents a major problem. Purification of the acids is essential to ensure acceptable blanks.

Isothermal (isopiestic) distillation can produce volatile acids (and ammonia) of medium concentration in high-purity form. For example, pure hydrochloric acid (and ammonia) can be generated by placing an open container of concentrated reagent-grade acid adjacent to a

container of high-purity water, within a closed system (such as a desiccator) at room temperature. Acid vapours are continuously transferred into the water until equilibrium is obtained. Purification by sub-boiling distillation is based on motionless evaporation of the liquid by infrared heating at the surface to prevent violent boiling. Different purification systems are described in detail by Matthinson (1972), Kuehner et al. (1972), Dabeka et al. (1976), Tschopel et al. (1980), Mitchell (1982b), Moody and Beary (1982), Moody et al. (1989), and Paulsen et al. (1989). Acids of extremely high purity are produced by multiple batchwise distillation of reagent-grade acids in a silica apparatus, which is placed in a laminar-flow hood.

4. SAMPLE PRETREATMENT

If the determinands are heterogeneously distributed in the sample material, it may be preferable to homogenize prior to taking subsamples for analysis. However, this procedural step is problematic, since uncontrollable contamination through the homogenizing tool may occur. Cryogenic homogenization at liquid nitrogen temperature and application of high-purity material such as quartz, PTFE, titanium or stainless steel for the construction of homogenizing devices may help to minimize contamination (Iyengar, 1976; Iyengar and Kasperek, 1977; Klusmann et al., 1985).

5. SAMPLE DECOMPOSITION

For accurate direct measurements of metallic trace element contents in biological matrices, appropriate calibration (reference) standards are lacking in most instances. Therefore, multi-stage, easy to calibrate methods are still necessary, which include decomposition procedures and transformation of biological material into solution.

As a general rule wet sample is to be subject to decomposition procedures to avoid contamination or loss of determinands. A general sample decomposition procedure cannot be recommended due to the diverse composition of materials to be analysed, as well as to the different elements to be determined, and also because of the variety of possible analytical methods applied. However, the following minimum requirements should be met:

- complete destruction of all organic material of the sample,
- avoidance of determinand losses,
- avoidance of contamination.

Complete decomposition of the organic matrix is a prerequisite for a variety of the subsequently used instrumental determination techniques. Residual dissolved organic carbon from biological materials incompletely disintegrated after decomposition with nitric acid causes problems particularly in voltammetric and polarographic determinations. Both are sensitive to interference from chelating and electroactive organic components coexisting in incompletely decomposed samples during analysis (Pratt et al., 1988; Wurfels

et al., 1987, 1989). Residual dissolved organic carbon compounds even of low molecular weight can change the equilibria in the spray chambers for sample introduction in atomic emission spectrometry (AES), optical emission spectrometry (OES), and atomic absorption spectrophotometry (AAS) by changing the viscosity of the sample solution. In such cases, comparison with pure aquatic calibration standard solutions can lead to erroneous results. In graphite furnace atomic absorption spectrophotometry (GFAAS), residual organic carbon may undergo complicated secondary reactions with the analyte prior to or during the atomization process. Such 'matrix interferences' alter the rate at which atoms enter the optical path relative to that obtained for an undisturbed element standard (Harms, 1985; and other references cited there).

The comparatively simple dry ashing method using a muffle furnace is problematic, since both uncontrollable losses of the determinands and contamination through contact with the furnace material may occur.

Both, application of a carefully developed and controlled temperature programme and modifying the matrix prior to the ashing procedure (addition of ashing aids agents) may be suitable to prevent losses of volatile elements (special analytical problems concerning mercury determination are described in Attachment 1). The use of special materials (quartz, titanium, stainless steel) for the construction of sample containers may be helpful to minimise contamination.

In the widely applied wet ashing procedure in open systems, the sample is treated with acids, mainly nitric, sulphuric and perchloric acids, in different ratios and under different conditions. Usually large quantities of reagents and voluminous apparatus with large surfaces are needed for complete destruction of the organic material. Serious contamination problems (too high blank values) may arise, if insufficiently purified acids are used.

The rate of reaction and efficiency of acid decomposition increase substantially with elevated temperatures. Accordingly, closed-vessel techniques, using conventional heating or microwave energy, have an advantage over open systems. As a result of the closed systems with vessels manufactured of dense and very pure material (PTFE, PFA, quartz), loss of elements through volatilisation and contamination by desorption of impurities from the vessel surface are significantly reduced. In addition, since only small quantities of high-purity acid (usually nitric acid) need to be used, extremely low analytical blanks can be obtained. Kingston and Jassie (1986, 1988) comprehensively considered the fundamental parameters governing closed vessel acid decomposition at elevated temperatures using a microwave radiation field. Microwave systems enable a very fast energy transfer to the sample and a very rapid build up of high internal vessel temperature and pressure, with the advantage of an enormous reduction in digestion time occurs. Furthermore, a reduction of acid volume

(McCarthy and Ellis, 1991) and contamination reduction during the decomposition process were found (Dunemann, 1994; Sheppard et al., 1994).

The application of microwave energy must be carefully controlled to avoid explosions; a pressure-relief system is recommended for safe operation (Gilman and Grooms, 1988). At this stage of development, it can be concluded that advances in pressure and temperature feedback control features have contributed to the acceptance of microwave sample decomposition in analytical chemistry.

6. CALIBRATION

For calibration purposes, single element standard stock solutions at a concentration of 1000 mg/l, purchased from a qualified manufacturer, should be available. The actual concentration of the named element should be stated on the label together with the date of the preparation of the standard solution.

Fresh stock standard solutions should be compared with the old standard solutions. Traceability can be ensured by the use of CRM(s) or participation in intercomparison exercises (EURACHEM, 2003).

Single or mixed element working standard solutions for calibration purposes are prepared by dilution of the standard stock solutions using dilute acid, as required. Both stock standard and working standard solutions are stored in polyethylene, borosilicate or quartz volumetric flasks. Working standard solutions at concentrations less than 100 µg/l should be freshly prepared for every batch of samples and kept no longer than two weeks. The calibration procedure must meet some basic criteria in order to give the best estimate of the true (but unknown) element concentration of the sample analysed. These criteria are as follows:

- The amounts or concentrations of standards for the establishment of the calibration function must cover the range as related to practical conditions. The mean of the range should be roughly equal to the expected analyte concentration in the sample.
- The required analytical precision must be achievable and known throughout the entire range.
- The measured value (response) at the lower end of the range must be significantly different from the procedural analytical blank.
- The chemical and physical properties of the calibration standards must closely resemble those of the sample under investigation.
- The calibration standards must be processed through the entire analytical procedure in the same manner as the sample.

- The standard addition technique should be used only under very special circumstances (Cardone, 1986a, 1986b).

7. DETERMINATION

In an analytical series, especially with the number of samples >10, the control of calibration settings should be carried out with 2-3 calibration solution between environmental 10 samples. The analytical series should contain also a control sample of LRM or CRM.

8. REFERENCES

- Baxter, D., and Frech, W. 1990. Critical comparison of two standard digestion procedures for the determination of total mercury in natural water samples by cold vapour atomic absorption spectrometry. *Analytica Chimica Acta*, 236: 377-384.
- EURACHEM 2003. EURACHEM/CITAC Guide "Traceability in Chemical Measurement" – A guide to achieving comparable results in chemical measurement. S.L.R. Ellison, B. King, M. Rösslein, M. Salit, A. Williams (Eds.), 43 pp.
- Feldman, C. 1974. Preservation of dilute mercury solutions. *Analytical Chemistry*, 46: 99-102.
- Guo, T., and Baasner, J. 1993. Determination of mercury in urine by flow-injection cold vapour atomic absorption spectrometry. *Analytica Chimica Acta*, 278: 189-196.
- Hanna, C., and McIntosh, S. 1995. Determination of total Hg in environmental samples with on-line microwave digestion coupled to a flow injection mercury system (FIMS). *Atomic Spectroscopy*, 16: 106-114.
- Harms, U. 1988: Analytical procedures for mercury, cadmium and lead in biological material. *Baltic Sea Environment Proceedings*, No. 27C, Part CI, pp. 36-62. Helsinki Commission.
- Hatch, W., and Ott, W. 1968. Determination of sub-microgram quantities of mercury by atomic absorption spectrometry. *Analytical Chemistry*, 40: 2085-2087.
- Kaiser, G., Götz, D., Tölg, G., Knapp, G., Maichin, B., and Spitzzy, H. 1978. Untersuchung von systematischen Fehlern bei der Bestimmung von Hg-Gesamtgehalten im Bereich 10 -5 % in anorganischen und organischen Matrices mit zwei unabhängigen Verbundverfahren. *Fresenius Z. Analytical Chemistry*, 291: 278-291.
- Kingston, K., and McIntosh, S. 1995. Determination of mercury in geological samples by flow injection AAS. *Atomic Spectroscopy*, 16: 115-117.
- Landi, S., Fagioli, F., Locatelli, C., and Vecchiotti, R. 1990. Digestion method for the determination of mercury in vegetable matrices by cold vapour atomic absorption spectrometry. *Analyst*, 115: 173-177.
- Lippo, H., Jauhiainen, T., and Perämäki, P. 1997. Comparison of digestion methods for the determination of total mercury in environmental samples by flow injection CV-AAS. *Atomic Spectroscopy*, 18: 102-108.

- Navarro, M., Lopez, M., Lopez, H., and Sanchez, M. 1992. Microwave dissolution for the determination of mercury in fish by cold vapour atomic absorption spectrometry. *Analytica Chimica Acta*, 257: 155-158.
- Ping, L., and Dasgupta, P. 1989. Determination of total mercury in water and urine by gold film sensor following Fenton's Reagent digestion. *Analytical Chemistry*, 61: 1230-1235. Rokkjaer, J., Hoyer, B., and Jensen, N. 1993. Interference by volatile nitrogen oxides in the determination of mercury by flow injection cold vapour atomic absorption spectrometry. *Talanta*, 40: 729-735.
- Toffaletti, J., and Savory, J. 1975. Use of sodium borohydride for determination of total mercury in urine by atomic absorption spectrometry. *Analytical Chemistry*, 47: 2091-2095.
- Toribara, T., Shields, C., and Koval, L. 1970. Behaviour of dilute solutions of mercury. *Talanta*, 17: 1025-1028. Tsalev, D., Sperling, M., and Welz, B. 1992a: On-line microwave sample pre-treatment for hydride generation and cold vapour atomic absorption spectrometry. Part 1. The manifold. *Analyst*, 117: 1729-1733.
- Tsalev, D., Sperling, M., and Welz, B. 1992b. On-line microwave sample pre-treatment for hydride generation and cold vapour atomic absorption spectrometry. Part 2. Chemistry and application. *Analyst*, 117: 1735-1739.
- Vermeir, G., Vandecasteele, C., and Dams, R. 1989. Microwave dissolution for the determination of mercury in biological samples. *Analytica Chimica Acta*, 220: 257-261.
- Welz, B., and Melcher, M. 1984. Picotrace determination of mercury using the amalgamation technique. *Atomic Spectroscopy*, 5: 37-42.
- Welz, B., Tsalev, D., and Sperling, M. 1992. On-Line microwave sample pre-treatment for the determination of mercury in water and urine by flow-injection cold-vapour atomic absorption spectrometry. *Analytica Chimica Acta*, 261: 91-103.

Annex X:

METHOD 200.8

**DETERMINATION OF TRACE ELEMENTS IN WATERS AND WASTES
BY INDUCTIVELY COUPLED PLASMA - MASS SPECTROMETRY**

**Revision 5.4
EMMC Version**

METHOD 200.8

**DETERMINATION OF TRACE ELEMENTS IN WATERS AND WASTES
BY INDUCTIVELY COUPLED PLASMA - MASS SPECTROMETRY**

**Revision 5.4
EMMC Version**

S.E. Long (Technology Applications Inc.), T.D. Martin, and E.R. Martin - Method 200.8,
Revisions 4.2 and 4.3 (1990)

S.E. Long (Technology Applications Inc.) and T.D. Martin - Method 200.8, Revision 4.4 (1991)

J.T. Creed, C.A. Brockhoff, and T.D. Martin - Method 200.8, Revision 5.4 (1994)

**ENVIRONMENTAL MONITORING SYSTEMS LABORATORY
OFFICE OF RESEARCH AND DEVELOPMENT
U.S. ENVIRONMENTAL PROTECTION AGENCY
CINCINNATI, OHIO 45268
METHOD 200.8**

**DETERMINATION OF TRACE ELEMENTS IN WATERS AND WASTES
BY INDUCTIVELY COUPLED PLASMA - MASS SPECTROMETRY**

1.0 SCOPE AND APPLICATION

- 1.1 This method provides procedures for determination of dissolved elements in ground waters, surface waters and drinking water. It may also be used for determination of total recoverable element concentrations in these waters as well as wastewaters, sludges and soils samples. This method is applicable to the following elements:

Analyte	Chemical Abstract Services Registry Number (CASRN)	
Aluminum	(Al)	7429-90-5
Antimony	(Sb)	7440-36-0
Arsenic	(As)	7440-38-2
Barium	(Ba)	7440-39-3
Beryllium	(Be)	7440-41-7
Cadmium	(Cd)	7440-43-9
Chromium	(Cr)	7440-47-3
Cobalt	(Co)	7440-48-4
Copper	(Cu)	7440-50-8
Lead	(Pb)	7439-92-1
Manganese	(Mn)	7439-96-5
Mercury	(Hg)	7439-97-6
Molybdenum	(Mo)	7439-98-7
Nickel	(Ni)	7440-02-0
Selenium	(Se)	7782-49-2
Silver	(Ag)	7440-22-4
Thallium	(Tl)	7440-28-0
Thorium	(Th)	7440-29-1
Uranium	(U)	7440-61-1
Vanadium	(V)	7440-62-2
Zinc	(Zn)	7440-66-6

Estimated instrument detection limits (IDLs) for these elements are listed in Table 1. These are intended as a guide to instrumental limits typical of a system optimized for multielement determinations and employing commercial instrumentation and pneumatic nebulization sample introduction. However, actual method detection limits (MDLs) and linear working ranges will be dependent on the sample matrix, instrumentation and selected operating conditions. Given in Table 7 are typical MDLs for both total recoverable determinations by "direct analysis" and where sample digestion is employed.

- 1.2 For reference where this method is approved for use in compliance monitoring programs [e.g., Clean Water Act (NPDES) or Safe Drinking Water Act (SDWA)] consult both the appropriate sections of the Code of Federal Regulation (40 CFR Part 136 Table 1B for NPDES, and Part 141 § 141.23 for drinking water), and the latest Federal Register announcements.
- 1.3 Dissolved elements are determined after suitable filtration and acid preservation. In order to reduce potential interferences, dissolved solids should not exceed 0.2% (w/v) (Section 4.1.4).
- 1.4 With the exception of silver, where this method is approved for the determination of certain metal and metalloid contaminants in drinking water, samples may be analyzed directly by pneumatic nebulization without acid digestion if the samples have been properly preserved with acid and have turbidity of <1 NTU at the time of analysis. This total recoverable determination procedure is referred to as "direct analysis".
- 1.5 For the determination of total recoverable analytes in aqueous and solid samples a digestion/extraction is required prior to analysis when the elements are not in solution (e.g., soils, sludges, sediments and aqueous samples that may contain particulate and suspended solids). Aqueous samples containing suspended or particulate material $\geq 1\%$ (w/v) should be extracted as a solid type sample (Section 11.2.2).
- 1.6 The total recoverable sample digestion procedure given in this method is not suitable for the determination of volatile organo-mercury compounds. However, for "direct analysis" of drinking water (turbidity <1 NTU), the combined concentrations of inorganic and organo-mercury in solution can be determined by "direct analysis" pneumatic nebulization provided gold is added to both samples and standards alike to eliminate memory interference effects.
- 1.7 Silver is only slightly soluble in the presence of chloride unless there is a sufficient chloride concentration to form the soluble chloride complex. Therefore, low recoveries of silver may occur in samples, fortified sample matrices and even fortified blanks if determined as a dissolved analyte or by "direct analysis" where the sample has not been processed using the total recoverable mixed acid digestion. For this reason it is recommended that samples be digested prior to the determination of silver. The total recoverable sample digestion procedure given in this method is suitable for the determination of silver in aqueous samples containing concentrations up to 0.1 mg/L. For the analysis of wastewater samples containing higher concentrations of silver, succeeding smaller volume, well mixed sample aliquots must be prepared until the analysis solution contains <0.1 mg/L silver. The extraction of solid samples containing concentrations of silver >50 mg/kg should be treated in a similar manner.
- 1.8 The total recoverable sample digestion procedure given in this method will solubilize and hold in solution only minimal concentrations of barium in the presence of free sulfate. For the analysis of barium in samples having varying

and unknown concentrations of sulfate, analysis should be completed as soon as possible after sample preparation.

- 1.9 This method should be used by analysts experienced in the use of inductively coupled plasma mass spectrometry (ICP-MS), the interpretation of spectral and matrix interferences and procedures for their correction. A minimum of six months experience with commercial instrumentation is recommended.
- 1.10 Users of the method data should state the data-quality objectives prior to analysis. Users of the method must document and have on file the required initial demonstration performance data described in Section 9.2 prior to using the method for analysis.

2.0 SUMMARY OF METHOD

- 2.1 An aliquot of a well mixed, homogeneous aqueous or solid sample is accurately weighed or measured for sample processing. For total recoverable analysis of a solid or an aqueous sample containing undissolved material, analytes are first solubilized by gentle refluxing with nitric and hydrochloric acids. After cooling, the sample is made up to volume, is mixed and centrifuged or allowed to settle overnight prior to analysis. For the determination of dissolved analytes in a filtered aqueous sample aliquot, or for the "direct analysis" total recoverable determination of analytes in drinking water where sample turbidity is <1 NTU, the sample is made ready for analysis by the appropriate addition of nitric acid, and then diluted to a predetermined volume and mixed before analysis.
- 2.2 The method describes the multi-element determination of trace elements by ICP-MS.¹⁻³ Sample material in solution is introduced by pneumatic nebulization into a radiofrequency plasma where energy transfer processes cause desolvation, atomization and ionization. The ions are extracted from the plasma through a differentially pumped vacuum interface and separated on the basis of their mass-to-charge ratio by a quadrupole mass spectrometer having a minimum resolution capability of 1 amu peak width at 5% peak height. The ions transmitted through the quadrupole are detected by an electron multiplier or Faraday detector and the ion information processed by a data handling system. Interferences relating to the technique (Section 4.0) must be recognized and corrected for. Such corrections must include compensation for isobaric elemental interferences and interferences from polyatomic ions derived from the plasma gas, reagents or sample matrix. Instrumental drift as well as suppressions or enhancements of instrument response caused by the sample matrix must be corrected for by the use of internal standards.

3.0 DEFINITIONS

- 3.1 **Calibration Blank** - A volume of reagent water acidified with the same acid matrix as in the calibration standards. The calibration blank is a zero standard and is used to calibrate the ICP instrument (Section 7.6.1).

- 3.2 **Calibration Standard (CAL)** - A solution prepared from the dilution of stock standard solutions. The CAL solutions are used to calibrate the instrument response with respect to analyte concentration (Section 7.4).
- 3.3 **Dissolved Analyte** - The concentration of analyte in an aqueous sample that will pass through a 0.45 µm membrane filter assembly prior to sample acidification (Section 11.1).
- 3.4 **Field Reagent Blank (FRB)** - An aliquot of reagent water or other blank matrix that is placed in a sample container in the laboratory and treated as a sample in all respects, including shipment to the sampling site, exposure to the sampling site conditions, storage, preservation, and all analytical procedures. The purpose of the FRB is to determine if method analytes or other interferences are present in the field environment (Section 8.5).
- 3.5 **Instrument Detection Limit (IDL)** - The concentration equivalent to the analyte signal which is equal to three times the standard deviation of a series of 10 replicate measurements of the calibration blank signal at the selected analytical mass(es). (Table 1).
- 3.6 **Internal Standard** - Pure analyte(s) added to a sample, extract, or standard solution in known amount(s) and used to measure the relative responses of other method analytes that are components of the same sample or solution. The internal standard must be an analyte that is not a sample component (Sections 7.5 and 9.4.5).
- 3.7 **Laboratory Duplicates (LD1 and LD2)** - Two aliquots of the same sample taken in the laboratory and analyzed separately with identical procedures. Analyses of LD1 and LD2 indicates precision associated with laboratory procedures, but not with sample collection, preservation, or storage procedures.
- 3.8 **Laboratory Fortified Blank (LFB)** - An aliquot of LRB to which known quantities of the method analytes are added in the laboratory. The LFB is analyzed exactly like a sample, and its purpose is to determine whether the methodology is in control and whether the laboratory is capable of making accurate and precise measurements (Sections 7.9 and 9.3.2).
- 3.9 **Laboratory Fortified Sample Matrix (LFM)** - An aliquot of an environmental sample to which known quantities of the method analytes are added in the laboratory. The LFM is analyzed exactly like a sample, and its purpose is to determine whether the sample matrix contributes bias to the analytical results. The background concentrations of the analytes in the sample matrix must be determined in a separate aliquot and the measured values in the LFM corrected for background concentrations (Section 9.4).
- 3.10 **Laboratory Reagent Blank (LRB)** - An aliquot of reagent water or other blank matrices that are treated exactly as a sample including exposure to all glassware, equipment, solvents, reagents, and internal standards that are used with other samples. The LRB is used to determine if method analytes or other interferences

are present in the laboratory environment, reagents, or apparatus (Sections 7.6.2 and 9.3.1).

- 3.11 **Linear Dynamic Range (LDR)** - The concentration range over which the instrument response to an analyte is linear (Section 9.2.2).
- 3.12 **Method Detection Limit (MDL)** - The minimum concentration of an analyte that can be identified, measured, and reported with 99% confidence that the analyte concentration is greater than zero (Section 9.2.4 and Table 7).
- 3.13 **Quality Control Sample (QCS)** - A solution of method analytes of known concentrations which is used to fortify an aliquot of LRB or sample matrix. The QCS is obtained from a source external to the laboratory and different from the source of calibration standards. It is used to check either laboratory or instrument performance (Sections 7.8 and 9.2.3).
- 3.14 **Solid Sample** - For the purpose of this method, a sample taken from material classified as either soil, sediment or sludge.
- 3.15 **Stock Standard Solution** - A concentrated solution containing one or more method analytes prepared in the laboratory using assayed reference materials or purchased from a reputable commercial source (Section 7.3).
- 3.16 **Total Recoverable Analyte** - The concentration of analyte determined either by "direct analysis" of an unfiltered acid preserved drinking water sample with turbidity of <1 NTU (Section 11.2.1), or by analysis of the solution extract of a solid sample or an unfiltered aqueous sample following digestion by refluxing with hot dilute mineral acid(s) as specified in the method (Sections 11.2 and 11.3).
- 3.17 **Tuning Solution** - A solution which is used to determine acceptable instrument performance prior to calibration and sample analyses (Section 7.7).
- 3.18 **Water Sample** - For the purpose of this method, a sample taken from one of the following sources: drinking, surface, ground, storm runoff, industrial or domestic wastewater.

4.0 INTERFERENCES

- 4.1 Several interference sources may cause inaccuracies in the determination of trace elements by ICP-MS. These are:
 - 4.1.1 Isobaric elemental interferences - Are caused by isotopes of different elements which form singly or doubly charged ions of the same nominal mass-to-charge ratio and which cannot be resolved by the mass spectrometer in use. All elements determined by this method have, at a minimum, one isotope free of isobaric elemental interference. Of the analytical isotopes recommended for use with this method (Table 4), only molybdenum-98 (ruthenium) and selenium-82 (krypton) have isobaric elemental interferences. If alternative analytical isotopes having higher

natural abundance are selected in order to achieve greater sensitivity, an isobaric interference may occur. All data obtained under such conditions must be corrected by measuring the signal from another isotope of the interfering element and subtracting the appropriate signal ratio from the isotope of interest. A record of this correction process should be included with the report of the data. It should be noted that such corrections will only be as accurate as the accuracy of the isotope ratio used in the elemental equation for data calculations. Relevant isotope ratios should be established prior to the application of any corrections.

- 4.1.2 Abundance sensitivity - Is a property defining the degree to which the wings of a mass peak contribute to adjacent masses. The abundance sensitivity is affected by ion energy and quadrupole operating pressure. Wing overlap interferences may result when a small ion peak is being measured adjacent to a large one. The potential for these interferences should be recognized and the spectrometer resolution adjusted to minimize them.
- 4.1.3 Isobaric polyatomic ion interferences - Are caused by ions consisting of more than one atom which have the same nominal mass-to-charge ratio as the isotope of interest, and which cannot be resolved by the mass spectrometer in use. These ions are commonly formed in the plasma or interface system from support gases or sample components. Most of the common interferences have been identified³, and these are listed in Table 2 together with the method elements affected. Such interferences must be recognized, and when they cannot be avoided by the selection of alternative analytical isotopes, appropriate corrections must be made to the data. Equations for the correction of data should be established at the time of the analytical run sequence as the polyatomic ion interferences will be highly dependent on the sample matrix and chosen instrument conditions. In particular, the common ⁸²Kr interference that affects the determination of both arsenic and selenium, can be greatly reduced with the use of high purity krypton free argon.
- 4.1.4 Physical interferences - Are associated with the physical processes which govern the transport of sample into the plasma, sample conversion processes in the plasma, and the transmission of ions through the plasma-mass spectrometer interface. These interferences may result in differences between instrument responses for the sample and the calibration standards. Physical interferences may occur in the transfer of solution to the nebulizer (e.g., viscosity effects), at the point of aerosol formation and transport to the plasma (e.g., surface tension), or during excitation and ionization processes within the plasma itself. High levels of dissolved solids in the sample may contribute deposits of material on the extraction and/or skimmer cones reducing the effective diameter of the orifices and therefore ion transmission. Dissolved solids levels not exceeding 0.2% (w/v) have been recommended³ to reduce such effects. Internal standardization may be effectively used to compensate for many physical interference effects.⁴ Internal standards ideally should have similar

analytical behavior to the elements being determined.

- 4.1.5 Memory interferences - Result when isotopes of elements in a previous sample contribute to the signals measured in a new sample. Memory effects can result from sample deposition on the sampler and skimmer cones, and from the buildup of sample material in the plasma torch and spray chamber. The site where these effects occur is dependent on the element and can be minimized by flushing the system with a rinse blank between samples (Section 7.6.3). The possibility of memory interferences should be recognized within an analytical run and suitable rinse times should be used to reduce them. The rinse times necessary for a particular element should be estimated prior to analysis. This may be achieved by aspirating a standard containing elements corresponding to 10 times the upper end of the linear range for a normal sample analysis period, followed by analysis of the rinse blank at designated intervals. The length of time required to reduce analyte signals to within a factor of 10 of the method detection limit, should be noted. Memory interferences may also be assessed within an analytical run by using a minimum of three replicate integrations for data acquisition. If the integrated signal values drop consecutively, the analyst should be alerted to the possibility of a memory effect, and should examine the analyte concentration in the previous sample to identify if this was high. If a memory interference is suspected, the sample should be reanalyzed after a long rinse period. In the determination of mercury, which suffers from severe memory effects, the addition of 100 µg/L gold will effectively rinse 5 µg/L mercury in approximately two minutes. Higher concentrations will require a longer rinse time.

5.0 SAFETY

- 5.1 The toxicity or carcinogenicity of reagents used in this method have not been fully established. Each chemical should be regarded as a potential health hazard and exposure to these compounds should be as low as reasonably achievable. Each laboratory is responsible for maintaining a current awareness file of OSHA regulations regarding the safe handling of the chemicals specified in this method.^{5,8} A reference file of material data handling sheets should also be available to all personnel involved in the chemical analysis. Specifically, concentrated nitric and hydrochloric acids present various hazards and are moderately toxic and extremely irritating to skin and mucus membranes. Use these reagents in a fume hood whenever possible and if eye or skin contact occurs, flush with large volumes of water. Always wear safety glasses or a shield for eye protection, protective clothing and observe proper mixing when working with these reagents.
- 5.2 The acidification of samples containing reactive materials may result in the release of toxic gases, such as cyanides or sulfides. Acidification of samples should be done in a fume hood.
- 5.3 All personnel handling environmental samples known to contain or to have been

in contact with human waste should be immunized against known disease causative agents.

- 5.4 Analytical plasma sources emit radiofrequency radiation in addition to intense UV radiation. Suitable precautions should be taken to protect personnel from such hazards. The inductively coupled plasma should only be viewed with proper eye protection from UV emissions.
- 5.5 It is the responsibility of the user of this method to comply with relevant disposal and waste regulations. For guidance see Sections 14.0 and 15.0.

6.0 EQUIPMENT AND SUPPLIES

6.1 Inductively coupled plasma mass spectrometer:

- 6.1.1 Instrument capable of scanning the mass range 5-250 amu with a minimum resolution capability of 1 amu peak width at 5% peak height. Instrument may be fitted with a conventional or extended dynamic range detection system.

Note: If an electron multiplier detector is being used, precautions should be taken, where necessary, to prevent exposure to high ion flux. Otherwise changes in instrument response or damage to the multiplier may result.

- 6.1.2 Radio-frequency generator compliant with FCC regulations.
 - 6.1.3 Argon gas supply - High purity grade (99.99%). When analyses are conducted frequently, liquid argon is more economical and requires less frequent replacement of tanks than compressed argon in conventional cylinders (Section 4.1.3).
 - 6.1.4 A variable-speed peristaltic pump is required for solution delivery to the nebulizer.
 - 6.1.5 A mass-flow controller on the nebulizer gas supply is required. A water-cooled spray chamber may be of benefit in reducing some types of interferences (e.g., from polyatomic oxide species).
 - 6.1.6 If an electron multiplier detector is being used, precautions should be taken, where necessary, to prevent exposure to high ion flux. Otherwise changes in instrument response or damage to the multiplier may result. Samples having high concentrations of elements beyond the linear range of the instrument and with isotopes falling within scanning windows should be diluted prior to analysis.
- 6.2 Analytical balance, with capability to measure to 0.1 mg, for use in weighing solids, for preparing standards, and for determining dissolved solids in digests or extracts.

- 6.3 A temperature adjustable hot plate capable of maintaining a temperature of 95°C.
- 6.4 (Optional) A temperature adjustable block digester capable of maintaining a temperature of 95°C and equipped with 250 mL constricted digestion tubes.
- 6.5 (Optional) A steel cabinet centrifuge with guard bowl, electric timer and brake.
- 6.6 A gravity convection drying oven with thermostatic control capable of maintaining 105°C ± 5°C.
- 6.7 (Optional) An air displacement pipetter capable of delivering volumes ranging from 0.1-2500 µL with an assortment of high quality disposable pipet tips.
- 6.8 Mortar and pestle, ceramic or nonmetallic material.
- 6.9 Polypropylene sieve, 5-mesh (4 mm opening).
- 6.10 Labware - For determination of trace levels of elements, contamination and loss are of prime consideration. Potential contamination sources include improperly cleaned laboratory apparatus and general contamination within the laboratory environment from dust, etc. A clean laboratory work area designated for trace element sample handling must be used. Sample containers can introduce positive and negative errors in the determination of trace elements by (1) contributing contaminants through surface desorption or leaching, (2) depleting element concentrations through adsorption processes. All reusable labware (glass, quartz, polyethylene, PTFE, FEP, etc.) should be sufficiently clean for the task objectives. Several procedures found to provide clean labware include soaking overnight and thoroughly washing with laboratory-grade detergent and water, rinsing with tap water, and soaking for four hours or more in 20% (V/V) nitric acid or a mixture of dilute nitric and hydrochloric acid (1+2+9), followed by rinsing with reagent grade water and storing clean.

Note: Chromic acid must not be used for cleaning glassware.

- 6.10.1 Glassware - Volumetric flasks, graduated cylinders, funnels and centrifuge tubes (glass and/or metal free plastic).
- 6.10.2 Assorted calibrated pipettes.
- 6.10.3 Conical Phillips beakers (Corning 1080-250 or equivalent), 250 mL with 50 mm watch glasses.
- 6.10.4 Griffin beakers, 250 mL with 75 mm watch glasses and (optional) 75 mm ribbed watch glasses.
- 6.10.5 (Optional) PTFE and/or quartz beakers, 250 mL with PTFE covers.
- 6.10.6 Evaporating dishes or high-form crucibles, porcelain, 100 mL capacity.

6.10.7 Narrow-mouth storage bottles, FEP (fluorinated ethylene propylene) with ETFE (ethylene tetrafluorethylene) screw closure, 125-250 mL capacities.

6.10.8 One-piece stem FEP wash bottle with screw closure, 125 mL capacity.

7.0 REAGENTS AND STANDARDS

7.1 Reagents may contain elemental impurities that might affect the integrity of analytical data. Owing to the high sensitivity of ICP-MS, high-purity reagents should be used whenever possible. All acids used for this method must be of ultra high-purity grade. Suitable acids are available from a number of manufacturers or may be prepared by sub-boiling distillation. Nitric acid is preferred for ICP-MS in order to minimize polyatomic ion interferences. Several polyatomic ion interferences result when hydrochloric acid is used (Table 2), however, it should be noted that hydrochloric acid is required to maintain stability in solutions containing antimony and silver. When hydrochloric acid is used, corrections for the chloride polyatomic ion interferences must be applied to all data.

7.1.1 Nitric acid, concentrated (sp.gr. 1.41).

7.1.2 Nitric acid (1+1) - Add 500 mL conc. nitric acid to 400 mL of reagent grade water and dilute to 1 L.

7.1.3 Nitric acid (1+9) - Add 100 mL conc. nitric acid to 400 mL of reagent grade water and dilute to 1 L.

7.1.4 Hydrochloric acid, concentrated (sp.gr. 1.19).

7.1.5 Hydrochloric acid (1+1) - Add 500 mL conc. hydrochloric acid to 400 mL of reagent grade water and dilute to 1 L.

7.1.6 Hydrochloric acid (1+4) - Add 200 mL conc. hydrochloric acid to 400 mL of reagent grade water and dilute to 1 L.

7.1.7 Ammonium hydroxide, concentrated (sp.gr. 0.902).

7.1.8 Tartaric acid (CASRN 87-69-4).

7.2 Reagent water - All references to reagent grade water in this method refer to ASTM Type I water (ASTM D1193).⁹ Suitable water may be prepared by passing distilled water through a mixed bed of anion and cation exchange resins.

7.3 Standard Stock Solutions - Stock standards may be purchased from a reputable commercial source or prepared from ultra high-purity grade chemicals or metals (99.99-99.999% pure). All salts should be dried for one hour at 105°C, unless otherwise specified. Stock solutions should be stored in FEP bottles. Replace stock standards when succeeding dilutions for preparation of the multielement stock standards can not be verified.

CAUTION: Many metal salts are extremely toxic if inhaled or swallowed. Wash hands thoroughly after handling.

The following procedures may be used for preparing standard stock solutions:

Note: Some metals, particularly those which form surface oxides require cleaning prior to being weighed. This may be achieved by pickling the surface of the metal in acid. An amount in excess of the desired weight should be pickled repeatedly, rinsed with water, dried and weighed until the desired weight is achieved.

- 7.3.1 Aluminum solution, stock 1 mL = 1000 µg Al: Pickle aluminum metal in warm (1+1) HCl to an exact weight of 0.100 g. Dissolve in 10 mL conc. HCl and 2 mL conc. nitric acid, heating to effect solution. Continue heating until volume is reduced to 4 mL. Cool and add 4 mL reagent grade water. Heat until the volume is reduced to 2 mL. Cool and dilute to 100 mL with reagent grade water.
- 7.3.2 Antimony solution, stock 1 mL = 1000 µg Sb: Dissolve 0.100 g antimony powder in 2 mL (1+1) nitric acid and 0.5 mL conc. hydrochloric acid, heating to effect solution. Cool, add 20 mL reagent grade water and 0.15 g tartaric acid. Warm the solution to dissolve the white precipitate. Cool and dilute to 100 mL with reagent grade water.
- 7.3.3 Arsenic solution, stock 1 mL = 1000 µg As: Dissolve 0.1320 g As₂O₃ in a mixture of 50 mL reagent grade water and 1 mL conc. ammonium hydroxide. Heat gently to dissolve. Cool and acidify the solution with 2 mL conc. nitric acid. Dilute to 100 mL with reagent grade water.
- 7.3.4 Barium solution, stock 1 mL = 1000 µg Ba: Dissolve 0.1437 g BaCO₃ in a solution mixture of 10 mL reagent grade water and 2 mL conc. nitric acid. Heat and stir to effect solution and degassing. Dilute to 100 mL with reagent grade water.
- 7.3.5 Beryllium solution, stock 1 mL = 1000 µg Be: Dissolve 1.965 g BeSO₄•4H₂O (DO NOT DRY) in 50 mL reagent grade water. Add 1 mL conc. nitric acid. Dilute to 100 mL with reagent grade water.
- 7.3.6 Bismuth solution, stock 1 mL = 1000 µg Bi: Dissolve 0.1115 g Bi₂O₃ in 5 mL conc. nitric acid. Heat to effect solution. Cool and dilute to 100 mL with reagent grade water.
- 7.3.7 Cadmium solution, stock 1 mL = 1000 µg Cd: Pickle cadmium metal in (1+9) nitric acid to an exact weight of 0.100 g. Dissolve in 5 mL (1+1) nitric acid, heating to effect solution. Cool and dilute to 100 mL with reagent grade water.
- 7.3.8 Chromium solution, stock 1 mL = 1000 µg Cr: Dissolve 0.1923 g CrO₃ in a solution mixture of 10 mL reagent grade water and 1 mL conc. nitric

acid. Dilute to 100 mL with reagent grade water.

- 7.3.9 Cobalt solution, stock 1 mL = 1000 µg Co: Pickle cobalt metal in (1+9) nitric acid to an exact weight of 0.100 g. Dissolve in 5 mL (1+1) nitric acid, heating to effect solution. Cool and dilute to 100 mL with reagent grade water.
- 7.3.10 Copper solution, stock 1 mL = 1000 µg Cu: Pickle copper metal in (1+9) nitric acid to an exact weight of 0.100 g. Dissolve in 5 mL (1+1) nitric acid, heating to effect solution. Cool and dilute to 100 mL with reagent grade water.
- 7.3.11 Gold solution, stock 1 mL = 1000 µg Au: Dissolve 0.100 g high purity (99.9999%) Au shot in 10 mL of hot conc. nitric acid by dropwise addition of 5 mL conc. HCl and then reflux to expel oxides of nitrogen and chlorine. Cool and dilute to 100 mL with reagent grade water.
- 7.3.12 Indium solution, stock 1 mL = 1000 µg In: Pickle indium metal in (1+1) nitric acid to an exact weight of 0.100 g. Dissolve in 10 mL (1+1) nitric acid, heating to effect solution. Cool and dilute to 100 mL with reagent grade water.
- 7.3.13 Lead solution, stock 1 mL = 1000 µg Pb: Dissolve 0.1599 g PbNO₃ in 5 mL (1+1) nitric acid. Dilute to 100 mL with reagent grade water.
- 7.3.14 Magnesium solution, stock 1 mL = 1000 µg Mg: Dissolve 0.1658 g MgO in 10 mL (1+1) nitric acid, heating to effect solution. Cool and dilute to 100 mL with reagent grade water.
- 7.3.15 Manganese solution, stock 1 mL = 1000 µg Mn: Pickle manganese flake in (1+9) nitric acid to an exact weight of 0.100 g. Dissolve in 5 mL (1+1) nitric acid, heating to effect solution. Cool and dilute to 100 mL with reagent grade water.
- 7.3.16 Mercury solution, stock, 1 mL = 1000 µg Hg: **DO NOT DRY**. **CAUTION:** highly toxic element. Dissolve 0.1354 g HgCl₂ in reagent water. Add 5.0 mL concentrated HNO₃ and dilute to 100 mL with reagent water.
- 7.3.17 Molybdenum solution, stock 1 mL = 1000 µg Mo: Dissolve 0.1500 g MoO₃ in a solution mixture of 10 mL reagent grade water and 1 mL conc. ammonium hydroxide., heating to effect solution. Cool and dilute to 100 mL with reagent grade water.
- 7.3.18 Nickel solution, stock 1 mL = 1000 µg Ni: Dissolve 0.100 g nickel powder in 5 mL conc. nitric acid, heating to effect solution. Cool and dilute to 100 mL with reagent grade water.
- 7.3.19 Scandium solution, stock 1 mL = 1000 µg Sc: Dissolve 0.1534 g Sc₂O₃ in 5 mL (1+1) nitric acid, heating to effect solution. Cool and dilute to

100 mL with reagent grade water.

- 7.3.20 Selenium solution, stock 1 mL = 1000 µg Se: Dissolve 0.1405 g SeO_2 in 20 mL ASTM Type I water. Dilute to 100 mL with reagent grade water.
- 7.3.21 Silver solution, stock 1 mL = 1000 µg Ag: Dissolve 0.100 g silver metal in 5 mL (1+1) nitric acid, heating to effect solution. Cool and dilute to 100 mL with reagent grade water. Store in dark container.
- 7.3.22 Terbium solution, stock 1 mL = 1000 µg Tb: Dissolve 0.1176 g Tb_4O_7 in 5 mL conc. nitric acid, heating to effect solution. Cool and dilute to 100 mL with reagent grade water.
- 7.3.23 Thallium solution, stock 1 mL = 1000 µg Tl: Dissolve 0.1303 g TlNO_3 in a solution mixture of 10 mL reagent grade water and 1 mL conc. nitric acid. Dilute to 100 mL with reagent grade water.
- 7.3.24 Thorium solution, stock 1 mL = 1000 µg Th: Dissolve 0.2380 g $\text{Th}(\text{NO}_3)_4 \cdot 4\text{H}_2\text{O}$ (DO NOT DRY) in 20 mL reagent grade water. Dilute to 100 mL with reagent grade water.
- 7.3.25 Uranium solution, stock 1 mL = 1000 µg U: Dissolve 0.2110 g $\text{UO}_2(\text{NO}_3)_2 \cdot 6\text{H}_2\text{O}$ (DO NOT DRY) in 20 mL reagent grade water and dilute to 100 mL with reagent grade water.
- 7.3.26 Vanadium solution, stock 1 mL = 1000 µg V: Pickle vanadium metal in (1+9) nitric acid to an exact weight of 0.100 g. Dissolve in 5 mL (1+1) nitric acid, heating to effect solution. Cool and dilute to 100 mL with reagent grade water.
- 7.3.27 Yttrium solution, stock 1 mL = 1000 µg Y: Dissolve 0.1270 g Y_2O_3 in 5 mL (1+1) nitric acid, heating to effect solution. Cool and dilute to 100 mL with reagent grade water.
- 7.3.28 Zinc solution, stock 1 mL = 1000 µg Zn: Pickle zinc metal in (1+9) nitric acid to an exact weight of 0.100 g. Dissolve in 5 mL (1+1) nitric acid, heating to effect solution. Cool and dilute to 100 mL with reagent grade water.
- 7.4 Multielement Stock Standard Solutions - Care must be taken in the preparation of multielement stock standards that the elements are compatible and stable. Originating element stocks should be checked for the presence of impurities which might influence the accuracy of the standard. Freshly prepared standards should be transferred to acid cleaned, not previously used FEP fluorocarbon bottles for storage and monitored periodically for stability. The following combinations of elements are suggested:

Standard Solution A		Standard Solution B
Aluminum	Mercury	Barium
Antimony	Molybdenum	Silver
Arsenic	Nickel	
Beryllium	Selenium	
Cadmium	Thallium	
Chromium	Thorium	
Cobalt	Uranium	
Copper	Vanadium	
Lead	Zinc	
Manganese		

Except for selenium and mercury, multielement stock standard solutions A and B (1 mL = 10 µg) may be prepared by diluting 1.0 mL of each single element stock standard in the combination list to 100 mL with reagent water containing 1% (v/v) nitric acid. For mercury and selenium in solution A, aliquots of 0.05 mL and 5.0 mL of the respective stock standards should be diluted to the specified 100 mL (1 mL = 0.5 µg Hg and 50 µg Se). Replace the multielement stock standards when succeeding dilutions for preparation of the calibration standards cannot be verified with the quality control sample.

7.4.1 Preparation of calibration standards - fresh multielement calibration standards should be prepared every two weeks or as needed. Dilute each of the stock multielement standard solutions A and B to levels appropriate to the operating range of the instrument using reagent water containing 1% (v/v) nitric acid. The element concentrations in the standards should be sufficiently high to produce good measurement precision and to accurately define the slope of the response curve. Depending on the sensitivity of the instrument, concentrations ranging from 10-200 µg/L are suggested, except mercury, which should be limited to ≤5 µg/L. It should be noted the selenium concentration is always a factor of 5 greater than the other analytes. If the direct addition procedure is being used (Method A, Section 10.3), add internal standards (Section 7.5) to the calibration standards and store in FEP bottles. Calibration standards should be verified initially using a quality control sample (Section 7.8).

7.5 Internal Standards Stock Solution - 1 mL = 100 µg. Dilute 10 mL of scandium, yttrium, indium, terbium and bismuth stock standards (Section 7.3) to 100 mL with reagent water, and store in a FEP bottle. Use this solution concentrate for addition to blanks, calibration standards and samples, or dilute by an appropriate amount using 1% (v/v) nitric acid, if the internal standards are being added by peristaltic pump (Method B, Section 10.3).

Note: If mercury is to be determined by the "direct analysis" procedure, add an aliquot of the gold stock standard (Section 7.3.11) to the internal standard solution sufficient to provide a concentration of 100 µg/L in final the dilution of all blanks, calibration standards, and samples.

- 7.6 Blanks - Three types of blanks are required for this method. A calibration blank is used to establish the analytical calibration curve, the laboratory reagent blank is used to assess possible contamination from the sample preparation procedure and to assess spectral background and the rinse blank is used to flush the instrument between samples in order to reduce memory interferences.
- 7.6.1 Calibration blank - Consists of 1% (v/v) nitric acid in reagent grade water. If the direct addition procedure (Method A, Section 10.3) is being used, add internal standards.
- 7.6.2 Laboratory reagent blank (LRB) - Must contain all the reagents in the same volumes as used in processing the samples. The LRB must be carried through the same entire preparation scheme as the samples including digestion, when applicable. If the direct addition procedure (Method A, Section 10.3) is being used, add internal standards to the solution after preparation is complete.
- 7.6.3 Rinse blank - Consists of 2% (v/v) nitric acid in reagent grade water.
- Note:** If mercury is to be determined by the "direct analysis" procedure, add gold (Section 7.3.11) to the rinse blank to a concentration of 100 µg/L.
- 7.7 Tuning Solution - This solution is used for instrument tuning and mass calibration prior to analysis. The solution is prepared by mixing beryllium, magnesium, cobalt, indium and lead stock solutions (Section 7.3) in 1% (v/v) nitric acid to produce a concentration of 100 µg/L of each element. Internal standards are not added to this solution. (Depending on the sensitivity of the instrument, this solution may need to be diluted 10-fold.)
- 7.8 Quality Control Sample (QCS) - The QCS should be obtained from a source outside the laboratory. The concentration of the QCS solution analyzed will depend on the sensitivity of the instrument. To prepare the QCS dilute an appropriate aliquot of analytes to a concentration ≤ 100 µg/L in 1% (v/v) nitric acid. Because of lower sensitivity, selenium may be diluted to a concentration of < 500 µg/L, however, in all cases, mercury should be limited to a concentration of ≤ 5 µg/L. If the direct addition procedure (Method A, Section 10.3) is being used, add internal standards after dilution, mix and store in a FEP bottle. The QCS should be analyzed as needed to meet data-quality needs and a fresh solution should be prepared quarterly or more frequently as needed.
- 7.9 Laboratory Fortified Blank (LFB) - To an aliquot of LRB, add aliquots from multielement stock standards A and B (Section 7.4) to prepared the LFB. Depending on the sensitivity of the instrument, the fortified concentration used should range from 40-100 µg/L for each analyte, except selenium and mercury. For selenium the concentration should range from 200-500 µg/L, while the concentration range mercury should be limited to 2-5 µg/L. The LFB must be carried through the same entire preparation scheme as the samples including sample digestion, when applicable. If the direct addition procedure (Method A, Section 10.3) is being used, add internal standards to this solution after

preparation has been completed.

8.0 SAMPLE COLLECTION, PRESERVATION, AND STORAGE

- 8.1 Prior to the collection of an aqueous sample, consideration should be given to the type of data required, (i.e., dissolved or total recoverable), so that appropriate preservation and pretreatment steps can be taken. The pH of all aqueous samples **must** be tested immediately prior to aliquoting for processing or "direct analysis" to ensure the sample has been properly preserved. If properly acid preserved, the sample can be held up to 6 months before analysis.
- 8.2 For the determination of dissolved elements, the sample must be filtered through a 0.45 µm pore diameter membrane filter at the time of collection or as soon thereafter as practically possible. Use a portion of the sample to rinse the filter flask, discard this portion and collect the required volume of filtrate. Acidify the filtrate with (1+1) nitric acid immediately following filtration to pH <2.
- 8.3 For the determination of total recoverable elements in aqueous samples, samples are **not** filtered, but acidified with (1+1) nitric acid to pH <2 (normally, 3 mL of (1+1) acid per liter of sample is sufficient for most ambient and drinking water samples). Preservation may be done at the time of collection, however, to avoid the hazards of strong acids in the field, transport restrictions, and possible contamination it is recommended that the samples be returned to the laboratory within two weeks of collection and acid preserved upon receipt in the laboratory. Following acidification, the sample should be mixed, held for 16 hours, and then verified to be pH <2 just prior withdrawing an aliquot for processing or "direct analysis". If for some reason such as high alkalinity the sample pH is verified to be >2, more acid must be added and the sample held for 16 hours until verified to be pH <2. See Section 8.1.
- Note:** When the nature of the sample is either unknown or known to be hazardous, acidification should be done in a fume hood. See Section 5.2.
- 8.4 Solid samples require no preservation prior to analysis other than storage at 4°C. There is no established holding time limitation for solid samples.
- 8.5 For aqueous samples, a field blank should be prepared and analyzed as required by the data user. Use the same container and acid as used in sample collection.

9.0 QUALITY CONTROL

- 9.1 Each laboratory using this method is required to operate a formal quality control (QC) program. The minimum requirements of this program consist of an initial demonstration of laboratory capability, and the periodic analysis of laboratory reagent blanks, fortified blanks and calibration solutions as a continuing check on performance. The laboratory is required to maintain performance records that define the quality of the data thus generated.
- 9.2 Initial Demonstration of Performance (mandatory)

- 9.2.1 The initial demonstration of performance is used to characterize instrument performance (determination of linear calibration ranges and analysis of quality control samples) and laboratory performance (determination of method detection limits) prior to analyses conducted by this method.
- 9.2.2 Linear calibration ranges - Linear calibration ranges are primarily detector limited. The upper limit of the linear calibration range should be established for each analyte by determining the signal responses from a minimum of three different concentration standards, one of which is close to the upper limit of the linear range. Care should be taken to avoid potential damage to the detector during this process. The linear calibration range which may be used for the analysis of samples should be judged by the analyst from the resulting data. The upper LDR limit should be an observed signal no more than 10% below the level extrapolated from lower standards. Determined sample analyte concentrations that are greater than 90% of the determined upper LDR limit must be diluted and reanalyzed. The LDRs should be verified whenever, in the judgement of the analyst, a change in analytical performance caused by either a change in instrument hardware or operating conditions would dictate they be redetermined.
- 9.2.3 Quality control sample (QCS) - When beginning the use of this method, on a quarterly basis or as required to meet data-quality needs, verify the calibration standards and acceptable instrument performance with the preparation and analyses of a QCS (Section 7.8). To verify the calibration standards the determined mean concentration from three analyses of the QCS must be within $\pm 10\%$ of the stated QCS value. If the QCS is used for determining acceptable on-going instrument performance, analysis of the QCS prepared to a concentration of 100 $\mu\text{g}/\text{L}$ must be within $\pm 10\%$ of the stated value or within the acceptance limits listed in Table 8, whichever is the greater. (If the QCS is not within the required limits, an immediate second analysis of the QCS is recommended to confirm unacceptable performance.) If the calibration standards and/or acceptable instrument performance cannot be verified, the source of the problem must be identified and corrected before either proceeding on with the initial determination of method detection limits or continuing with on-going analyses.
- 9.2.4 Method detection limits (MDL) should be established for all analytes, using reagent water (blank) fortified at a concentration of two to five times the estimated detection limit.⁷ To determine MDL values, take seven replicate aliquots of the fortified reagent water and process through the entire analytical method. Perform all calculations defined in the method and report the concentration values in the appropriate units. Calculate the MDL as follows:

$$\text{MDL} = (t) \times (S)$$

where:

t = Student's t value for a 99% confidence level and a standard deviation estimate with n-1 degrees of freedom [t = 3.14 for seven replicates]

S = standard deviation of the replicate analyses

Note: If additional confirmation is desired, reanalyze the seven replicate aliquots on two more nonconsecutive days and again calculate the MDL values for each day. An average of the three MDL values for each analyte may provide for a more appropriate MDL estimate. If the relative standard deviation (RSD) from the analyses of the seven aliquots is <10%, the concentration used to determine the analyte MDL may have been inappropriately high for the determination. If so, this could result in the calculation of an unrealistically low MDL. Concurrently, determination of MDL in reagent water represents a best case situation and does not reflect possible matrix effects of real world samples. However, successful analyses of LFMs (Section 9.4) can give confidence to the MDL value determined in reagent water. Typical single laboratory MDL values using this method are given in Table 7.

The MDLs must be sufficient to detect analytes at the required levels according to compliance monitoring regulation (Section 1.2). MDLs should be determined annually, when a new operator begins work or whenever, in the judgement of the analyst, a change in analytical performance caused by either a change in instrument hardware or operating conditions would dictate they be redetermined.

9.3 Assessing Laboratory Performance (mandatory)

9.3.1 Laboratory reagent blank (LRB) - The laboratory must analyze at least one LRB (Section 7.6.2) with each batch of 20 or fewer of samples of the same matrix. LRB data are used to assess contamination from the laboratory environment and to characterize spectral background from the reagents used in sample processing. LRB values that exceed the MDL indicate laboratory or reagent contamination should be suspected. When LRB values constitute 10% or more of the analyte level determined for a sample or is 2.2 times the analyte MDL whichever is greater, fresh aliquots of the samples must be prepared and analyzed again for the affected analytes after the source of contamination has been corrected and acceptable LRB values have been obtained.

9.3.2 Laboratory fortified blank (LFB) - The laboratory must analyze at least one LFB (Section 7.9) with each batch of samples. Calculate accuracy as percent recovery using the following equation:

$$R = \frac{\text{LFB} - \text{LRB}}{s} \times 100$$

where:

- R = percent recovery
- LFB = laboratory fortified blank
- LRB = laboratory reagent blank
- s = concentration equivalent of analyte added to fortify the LBR solution

If the recovery of any analyte falls outside the required control limits of 85-115%, that analyte is judged out of control, and the source of the problem should be identified and resolved before continuing analyses.

- 9.3.3 The laboratory must use LFB analyses data to assess laboratory performance against the required control limits of 85-115% (Section 9.3.2). When sufficient internal performance data become available (usually a minimum of 20-30 analyses), optional control limits can be developed from the mean percent recovery (\bar{x}) and the standard deviation (S) of the mean percent recovery. These data can be used to establish the upper and lower control limits as follows:

$$\text{UPPER CONTROL LIMIT} = \bar{x} + 3S$$

$$\text{LOWER CONTROL LIMIT} = \bar{x} - 3S$$

The optional control limits must be equal to or better than the required control limits of 85-115%. After each five to ten new recovery measurements, new control limits can be calculated using only the most recent 20-30 data points. Also, the standard deviation (S) data should be used to establish an on-going precision statement for the level of concentrations included in the LFB. These data must be kept on file and be available for review.

- 9.3.4 Instrument performance - For all determinations the laboratory must check instrument performance and verify that the instrument is properly calibrated on a continuing basis. To verify calibration run the calibration blank and calibration standards as surrogate samples immediately following each calibration routine, after every ten analyses and at the end of the sample run. The results of the analyses of the standards will indicate whether the calibration remains valid. The analysis of all analytes within the standard solutions must be within $\pm 10\%$ of calibration. If the calibration cannot be verified within the specified limits, the instrument must be recalibrated. (The instrument responses from the calibration check may be used for recalibration purposes, however, it must be verified before continuing sample analysis.) If the continuing calibration check is not confirmed within $\pm 15\%$, the previous 10 samples must be reanalyzed after recalibration. If the sample matrix is responsible for the calibration drift, it is recommended that the previous 10 samples are reanalyzed in groups of five between calibration checks to prevent a similar drift situation from occurring.

9.4 Assessing Analyte Recovery and Data Quality

- 9.4.1 Sample homogeneity and the chemical nature of the sample matrix can affect analyte recovery and the quality of the data. Taking separate aliquots from the sample for replicate and fortified analyses can in some cases assess the effect. Unless otherwise specified by the data user, laboratory or program, the following laboratory fortified matrix (LFM) procedure (Section 9.4.2) is required.
- 9.4.2 The laboratory must add a known amount of analyte to a minimum of 10% of the routine samples. In each case the LFM aliquot must be a duplicate of the aliquot used for sample analysis and for total recoverable determinations added prior to sample preparation. For water samples, the added analyte concentration must be the same as that used in the laboratory fortified blank (Section 7.9). For solid samples, the concentration added should be 100 mg/kg equivalent (200 µg/L in the analysis solution) except silver which should be limited to 50 mg/kg (Section 1.8). Over time, samples from all routine sample sources should be fortified.
- 9.4.3 Calculate the percent recovery for each analyte, corrected for background concentrations measured in the unfortified sample, and compare these values to the designated LFM recovery range of 70-130%. Recovery calculations are not required if the concentration of the analyte added is less than 30% of the sample background concentration. Percent recovery may be calculated in units appropriate to the matrix, using the following equation:

$$R = \frac{C_s - C}{s} \times 100$$

where:

R = percent recovery

C_s = fortified sample concentration

C = sample background concentration

s = concentration equivalent of analyte added to fortify the sample

- 9.4.4 If recovery of any analyte falls outside the designated range and laboratory performance for that analyte is shown to be in control (Section 9.3), the recovery problem encountered with the fortified sample is judged to be matrix related, not system related. The data user should be informed that the result for that analyte in the unfortified sample is suspect due to either the heterogeneous nature of the sample or an uncorrected matrix effect.
- 9.4.5 Internal standards responses - The analyst is expected to monitor the responses from the internal standards throughout the sample set being

analyzed. Ratios of the internal standards responses against each other should also be monitored routinely. This information may be used to detect potential problems caused by mass dependent drift, errors incurred in adding the internal standards or increases in the concentrations of individual internal standards caused by background contributions from the sample. The absolute response of any one internal standard must not deviate more than 60-125% of the original response in the calibration blank. If deviations greater than these are observed, flush the instrument with the rinse blank and monitor the responses in the calibration blank. If the responses of the internal standards are now within the limit, take a fresh aliquot of the sample, dilute by a further factor of two, add the internal standards and reanalyze. If after flushing the response of the internal standards in the calibration blank are out of limits, terminate the analysis and determine the cause of the drift. Possible causes of drift may be a partially blocked sampling cone or a change in the tuning condition of the instrument.

10.0 CALIBRATION AND STANDARDIZATION

- 10.1 Operating conditions - Because of the diversity of instrument hardware, no detailed instrument operating conditions are provided. The analyst is advised to follow the recommended operating conditions provided by the manufacturer. It is the responsibility of the analyst to verify that the instrument configuration and operating conditions satisfy the analytical requirements and to maintain quality control data verifying instrument performance and analytical results. Instrument operating conditions which were used to generate precision and recovery data for this method (Section 13.0) are included in Table 6.
- 10.2 Precalibration routine - The following precalibration routine must be completed prior to calibrating the instrument until such time it can be documented with periodic performance data that the instrument meets the criteria listed below without daily tuning.
- 10.2.1 Initiate proper operating configuration of instrument and data system. Allow a period of not less than 30 minutes for the instrument to warm up. During this process conduct mass calibration and resolution checks using the tuning solution. Resolution at low mass is indicated by magnesium isotopes 24, 25, and 26. Resolution at high mass is indicated by lead isotopes 206, 207, and 208. For good performance adjust spectrometer resolution to produce a peak width of approximately 0.75 amu at 5% peak height. Adjust mass calibration if it has shifted by more than 0.1 amu from unit mass.
- 10.2.2 Instrument stability must be demonstrated by running the tuning solution (Section 7.7) a minimum of five times with resulting relative standard deviations of absolute signals for all analytes of less than 5%.
- 10.3 Internal Standardization - Internal standardization must be used in all analyses to correct for instrument drift and physical interferences. A list of acceptable

internal standards is provided in Table 3. For full mass range scans, a minimum of three internal standards must be used. Procedures described in this method for general application, detail the use of five internal standards; scandium, yttrium, indium, terbium and bismuth. These were used to generate the precision and recovery data attached to this method. Internal standards must be present in all samples, standards and blanks at identical levels. This may be achieved by directly adding an aliquot of the internal standards to the CAL standard, blank or sample solution (Method A, Section 10.3), or alternatively by mixing with the solution prior to nebulization using a second channel of the peristaltic pump and a mixing coil (Method B, Section 10.3). The concentration of the internal standard should be sufficiently high that good precision is obtained in the measurement of the isotope used for data correction and to minimize the possibility of correction errors if the internal standard is naturally present in the sample. Depending on the sensitivity of the instrument, a concentration range of 20-200 µg/L of each internal standard is recommended. Internal standards should be added to blanks, samples and standards in a like manner, so that dilution effects resulting from the addition may be disregarded.

- 10.4 Calibration - Prior to initial calibration, set up proper instrument software routines for quantitative analysis. The instrument must be calibrated using one of the internal standard routines (Method A or B) described in Section 10.3. The instrument must be calibrated for the analytes to be determined using the calibration blank (Section 7.6.1) and calibration standards A and B (Section 7.4.1) prepared at one or more concentration levels. A minimum of three replicate integrations are required for data acquisition. Use the average of the integrations for instrument calibration and data reporting.
- 10.5 The rinse blank should be used to flush the system between solution changes for blanks, standards and samples. Allow sufficient rinse time to remove traces of the previous sample (Section 4.1.5). Solutions should be aspirated for 30 seconds prior to the acquisition of data to allow equilibrium to be established.

11.0 **PROCEDURE**

11.1 Aqueous Sample Preparation - Dissolved Analytes

11.1.1 For the determination of dissolved analytes in ground and surface waters, pipet an aliquot (≥ 20 mL) of the filtered, acid preserved sample into a 50 mL polypropylene centrifuge tube. Add an appropriate volume of (1+1) nitric acid to adjust the acid concentration of the aliquot to approximate a 1% (v/v) nitric acid solution (e.g., add 0.4 mL (1+1) HNO₃ to a 20 mL aliquot of sample). If the direct addition procedure (Method A, Section 10.3) is being used, add internal standards, cap the tube and mix. The sample is now ready for analysis (Section 1.2). Allowance for sample dilution should be made in the calculations.

Note: If a precipitate is formed during acidification, transport, or storage, the sample aliquot must be treated using the procedure in Section 11.2 prior to analysis.

11.2 Aqueous Sample Preparation - Total Recoverable Analytes

11.2.1 For the "direct analysis" of total recoverable analytes in drinking water samples containing turbidity <1 NTU, treat an unfiltered acid preserved sample aliquot using the sample preparation procedure described in Section 11.1.1 while making allowance for sample dilution in the data calculation. For the determination of total recoverable analytes in all other aqueous samples or for preconcentrating drinking water samples prior to analysis follow the procedure given in Sections 11.2.2 through 11.2.8.

11.2.2 For the determination of total recoverable analytes in aqueous samples (other than drinking water with <1 NTU turbidity), transfer a 100 mL (± 1 mL) aliquot from a well mixed, acid preserved sample to a 250 mL Griffin beaker (Sections 1.2, 1.3, 1.7, and 1.8). (When necessary, smaller sample aliquot volumes may be used.)

Note: If the sample contains undissolved solids >1%, a well mixed, acid preserved aliquot containing no more than 1 g particulate material should be cautiously evaporated to near 10 mL and extracted using the acid-mixture procedure described in Sections 11.3.3 through 11.3.7.

11.2.3 Add 2 mL (1+1) nitric acid and 1.0 mL of (1+1) hydrochloric acid to the beaker containing the measured volume of sample. Place the beaker on the hot plate for solution evaporation. The hot plate should be located in a fume hood and previously adjusted to provide evaporation at a temperature of approximately but no higher than 85°C. (See the following note.) The beaker should be covered with an elevated watch glass or other necessary steps should be taken to prevent sample contamination from the fume hood environment.

Note: For proper heating adjust the temperature control of the hot plate such that an uncovered Griffin beaker containing 50 mL of water placed in the center of the hot plate can be maintained at a temperature approximately but no higher than 85°C. (Once the beaker is covered with a watch glass the temperature of the water will rise to approximately 95°C.)

11.2.4 Reduce the volume of the sample aliquot to about 20 mL by gentle heating at 85°C. DO NOT BOIL. This step takes about two hours for a 100 mL aliquot with the rate of evaporation rapidly increasing as the sample volume approaches 20 mL. (A spare beaker containing 20 mL of water can be used as a gauge.)

11.2.5 Cover the lip of the beaker with a watch glass to reduce additional evaporation and gently reflux the sample for 30 minutes. (Slight boiling may occur, but vigorous boiling must be avoided to prevent loss of the HCl-H₂O azeotrope.)

11.2.6 Allow the beaker to cool. Quantitatively transfer the sample solution to

a 50 mL volumetric flask or 50 mL class A stoppered graduated cylinder, make to volume with reagent water, stopper and mix.

- 11.2.7 Allow any undissolved material to settle overnight, or centrifuge a portion of the prepared sample until clear. (If after centrifuging or standing overnight the sample contains suspended solids that would clog the nebulizer, a portion of the sample may be filtered for their removal prior to analysis. However, care should be exercised to avoid potential contamination from filtration.)
- 11.2.8 Prior to analysis, adjust the chloride concentration by pipetting 20 mL of the prepared solution into a 50 mL volumetric flask, dilute to volume with reagent water and mix. (If the dissolved solids in this solution are >0.2%, additional dilution may be required to prevent clogging of the extraction and/or skimmer cones. If the direct addition procedure (Method A, Section 10.3) is being used, add internal standards and mix. The sample is now ready for analysis. Because the effects of various matrices on the stability of diluted samples cannot be characterized, all analyses should be performed as soon as possible after the completed preparation.

11.3 Solid Sample Preparation - Total Recoverable Analytes

- 11.3.1 For the determination of total recoverable analytes in solid samples, mix the sample thoroughly and transfer a portion (>20 g) to tared weighing dish, weigh the sample and record the wet weight (WW). (For samples with <35% moisture a 20 g portion is sufficient. For samples with moisture >35% a larger aliquot 50-100 g is required.) Dry the sample to a constant weight at 60°C and record the dry weight (DW) for calculation of percent solids (Section 12.6). (The sample is dried at 60°C to prevent the loss of mercury and other possible volatile metallic compounds, to facilitate sieving, and to ready the sample for grinding.)
- 11.3.2 To achieve homogeneity, sieve the dried sample using a 5-mesh polypropylene sieve and grind in a mortar and pestle. (The sieve, mortar and pestle should be cleaned between samples.) From the dried, ground material weigh accurately a representative 1.0 ± 0.01 g aliquot (W) of the sample and transfer to a 250 mL Phillips beaker for acid extraction.
- 11.3.3 To the beaker add 4 mL of (1+1) HNO₃ and 10 mL of (1+4) HCl. Cover the lip of the beaker with a watch glass. Place the beaker on a hot plate for reflux extraction of the analytes. The hot plate should be located in a fume hood and previously adjusted to provide a reflux temperature of approximately 95°C. (See the following note.)

Note: For proper heating adjust the temperature control of the hot plate such that an uncovered Griffin beaker containing 50 mL of water placed in the center of the hot plate can be maintained at a temperature approximately but no higher than 85°C. (Once the beaker is covered with a watch glass the temperature of the water will rise to approximately

95°C.) Also, a block digester capable of maintaining a temperature of 95°C and equipped with 250 mL constricted volumetric digestion tubes may be substituted for the hot plate and conical beakers in the extraction step.

- 11.3.4 Heat the sample and gently reflux for 30 minutes. Very slight boiling may occur, however vigorous boiling must be avoided to prevent loss of the HCl-H₂O azeotrope. Some solution evaporation will occur (3-4 mL).
- 11.3.5 Allow the sample to cool and quantitatively transfer the extract to a 100 mL volumetric flask. Dilute to volume with reagent water, stopper and mix.
- 11.3.6 Allow the sample extract solution to stand overnight to separate insoluble material or centrifuge a portion of the sample solution until clear. (If after centrifuging or standing overnight the extract solution contains suspended solids that would clog the nebulizer, a portion of the extract solution may be filtered for their removal prior to analysis. However, care should be exercised to avoid potential contamination from filtration.)
- 11.3.7 Prior to analysis, adjust the chloride concentration by pipetting 20 mL of the prepared solution into a 100 mL volumetric flask, dilute to volume with reagent water and mix. (If the dissolved solids in this solution are >0.2%, additional dilution may be required to prevent clogging of the extraction and/or skimmer cones. If the direct addition procedure (Method A, Section 10.3) is being used, add internal standards and mix. The sample extract is now ready for analysis. Because the effects of various matrices on the stability of diluted samples cannot be characterized, all analyses should be performed as soon as possible after the completed preparation.

Note: Determine the percent solids in the sample for use in calculations and for reporting data on a dry weight basis.

11.4 Sample Analysis

- 11.4.1 For every new or unusual matrix, it is highly recommended that a semi-quantitative analysis be carried out to screen the sample for elements at high concentration. Information gained from this may be used to prevent potential damage to the detector during sample analysis and to identify elements which may be higher than the linear range. Matrix screening may be carried out by using intelligent software, if available, or by diluting the sample by a factor of 500 and analyzing in a semi-quantitative mode. The sample should also be screened for background levels of all elements chosen for use as internal standards in order to prevent bias in the calculation of the analytical data.
- 11.4.2 Initiate instrument operating configuration. Tune and calibrate the instrument for the analytes of interest (Section 10.0).

- 11.4.3 Establish instrument software run procedures for quantitative analysis. For all sample analyses, a minimum of three replicate integrations are required for data acquisition. Use the average of the integrations for data reporting.
- 11.4.4 All masses which might affect data quality must be monitored during the analytical run. As a minimum, those masses prescribed in Table 4 must be monitored in the same scan as is used for the collection of the data. This information should be used to correct the data for identified interferences.
- 11.4.5 During the analysis of samples, the laboratory must comply with the required quality control described in Sections 9.3 and 9.4. Only for the determination of dissolved analytes or the "direct analysis" of drinking water with turbidity of <1 NTU is the sample digestion step of the LRB, LFB, and LFM not required.
- 11.4.6 The rinse blank should be used to flush the system between samples. Allow sufficient time to remove traces of the previous sample or a minimum of one minute (Section 4.1.5). Samples should be aspirated for 30 seconds prior to the collection of data.
- 11.4.7 Samples having concentrations higher than the established linear dynamic range should be diluted into range and reanalyzed. The sample should first be analyzed for the trace elements in the sample, protecting the detector from the high concentration elements, if necessary, by the selection of appropriate scanning windows. The sample should then be diluted for the determination of the remaining elements. Alternatively, the dynamic range may be adjusted by selecting an alternative isotope of lower natural abundance, provided quality control data for that isotope have been established. The dynamic range must not be adjusted by altering instrument conditions to an uncharacterized state.

12.0 DATA ANALYSIS AND CALCULATIONS

- 12.1 Elemental equations recommended for sample data calculations are listed in Table 5. Sample data should be reported in units of $\mu\text{g/L}$ for aqueous samples or mg/kg dry weight for solid samples. Do not report element concentrations below the determined MDL.
- 12.2 For data values less than 10, two significant figures should be used for reporting element concentrations. For data values greater than or equal to 10, three significant figures should be used.
- 12.3 For aqueous samples prepared by total recoverable procedure (Section 11.2), multiply solution concentrations by the dilution factor 1.25. If additional dilutions were made to any samples or an aqueous sample was prepared using the acid-mixture procedure described in Section 11.3, the appropriate factor should be applied to the calculated sample concentrations.

- 12.4 For total recoverable analytes in solid samples (Section 11.3), round the solution analyte concentrations ($\mu\text{g/L}$ in the analysis solution) as instructed in Section 12.2. Multiply the $\mu\text{g/L}$ concentrations in the analysis solution by the factor 0.005 to calculate the mg/L analyte concentration in the 100 mL extract solution. (If additional dilutions were made to any samples, the appropriate factor should be applied to calculate analyte concentrations in the extract solution.) Report the data up to three significant figures as mg/kg dry-weight basis unless specified otherwise by the program or data user. Calculate the concentration using the equation below:

$$\text{Sample Conc. (mg/kg)}_{\text{dry-weight basis}} = \frac{C \times V}{W}$$

where:

C = Concentration in the extract (mg/L)

V = Volume of extract (L, 100 mL = 0.1L)

W = Weight of sample aliquot extracted ($\text{g} \times 0.001 = \text{kg}$)

Do not report analyte data below the estimated solids MDL or an adjusted MDL because of additional dilutions required to complete the analysis.

- 12.5 To report percent solids in solid samples (Sect. 11.3) calculate as follows:

$$\% \text{ solids (S)} = \frac{DW}{WW} \times 100$$

where:

DW = Sample weight (g) dried at 60°C

WW = Sample weight (g) before drying

Note: If the data user, program or laboratory requires that the reported percent solids be determined by drying at 105°C , repeat the procedure given in Section 11.3 using a separate portion ($>20 \text{ g}$) of the sample and dry to constant weight at $103\text{-}105^\circ\text{C}$.

- 12.6 Data values should be corrected for instrument drift or sample matrix induced interferences by the application of internal standardization. Corrections for characterized spectral interferences should be applied to the data. Chloride interference corrections should be made on all samples, regardless of the addition of hydrochloric acid, as the chloride ion is a common constituent of environmental samples.
- 12.7 If an element has more than one monitored isotope, examination of the concentration calculated for each isotope, or the isotope ratios, will provide useful information for the analyst in detecting a possible spectral interference.

Consideration should therefore be given to both primary and secondary isotopes in the evaluation of the element concentration. In some cases, secondary isotopes may be less sensitive or more prone to interferences than the primary recommended isotopes, therefore differences between the results do not necessarily indicate a problem with data calculated for the primary isotopes.

- 12.8 The QC data obtained during the analyses provide an indication of the quality of the sample data and should be provided with the sample results.

13.0 METHOD PERFORMANCE

- 13.1 Instrument operating conditions used for single laboratory testing of the method are summarized in Table 6. Total recoverable digestion and "direct analysis" MDLs determined using the procedure described in Section 9.2.4, are listed in Table 7.
- 13.2 Data obtained from single laboratory testing of the method are summarized in Table 9 for five water samples representing drinking water, surface water, ground water and waste effluent. Samples were prepared using the procedure described in Section 11.2. For each matrix, five replicates were analyzed and the average of the replicates used for determining the sample background concentration for each element. Two further pairs of duplicates were fortified at different concentration levels. For each method element, the sample background concentration, mean percent recovery, the standard deviation of the percent recovery and the relative percent difference between the duplicate fortified samples are listed in Table 8.
- 13.3 Data obtained from single laboratory testing of the method are summarized in Table 10 for three solid samples consisting of SRM 1645 River Sediment, EPA Hazardous Soil and EPA Electroplating Sludge. Samples were prepared using the procedure described in Section 11.3. For each method element, the sample background concentration, mean percent recovery, the standard deviation of the percent recovery and the relative percent difference between the duplicate fortified samples were determined as for Section 13.2.
- 13.4 Data obtained from single laboratory testing of the method for drinking water analysis using the "direct analysis" procedure (Section 11.2.1) are given in Table 11. Three drinking water samples of varying hardness collected from Regions 4, 6, and 10 were fortified to contain 1 µg/L of all metal primary contaminants, except selenium, which was added to a concentration of 20 µg/L. For each matrix, four replicate aliquots were analyzed to determine the sample background concentration of each analyte and four fortified aliquots were analyzed to determine mean percent recovery in each matrix. Listed in the Table 11 are the average mean percent recovery of each analyte in the three matrices and the standard deviation of the mean percent recoveries.
- 13.5 Listed in Table 12 are the regression equations for precision and bias developed from the joint USEPA/Association of Official Analytical Chemists (AOAC) multilaboratory validation study conducted on this method. These equations

were developed from data received from 13 laboratories on reagent water, drinking water and ground water. Listed in Tables 13 and 14, respectively, are the precision and recovery data from a wastewater digestate supplied to all laboratories and from a wastewater of the participant's choice. For a complete review of the study see Reference 11, Section 16.0 of this method.

14.0 POLLUTION PREVENTION

- 14.1 Pollution prevention encompasses any technique that reduces or eliminates the quantity or toxicity of waste at the point of generation. Numerous opportunities for pollution prevention exist in laboratory operation. The EPA has established a preferred hierarchy of environmental management techniques that places pollution prevention as the management option of first choice. Whenever feasible, laboratory personnel should use pollution prevention techniques to address their waste generation. When wastes cannot be feasibly reduced at the source, the Agency recommends recycling as the next best option.
- 14.2 For information about pollution prevention that may be applicable to laboratories and research institutions, consult "Less is Better: Laboratory Chemical Management for Waste Reduction", available from the American Chemical Society's Department of Government Relations and Science Policy, 1155 16th Street N.W., Washington D.C. 20036, (202)872-4477.

15.0 WASTE MANAGEMENT

- 15.1 The Environmental Protection Agency requires that laboratory waste management practices be conducted consistent with all applicable rules and regulations. The Agency urges laboratories to protect the air, water, and land by minimizing and controlling all releases from hoods and bench operations, complying with the letter and spirit of any sewer discharge permits and regulations, and by complying with all solid and hazardous waste regulations, particularly the hazardous waste identification rules and land disposal restrictions. For further information on waste management consult "The Waste Management Manual for Laboratory Personnel", available from the American Chemical Society at the address listed in the Section 14.2.

16.0 REFERENCES

1. Gray, A.L. and A. R. Date. Inductively Coupled Plasma Source Mass Spectrometry Using Continuum Flow Ion Extraction. *Analyst* 108 1033-1050, 1983.
2. Houk, R.S. et al. Inductively Coupled Argon Plasma as an Ion Source for Mass Spectrometric Determination of Trace Elements. *Anal Chem.* 52 2283-2289, 1980.
3. Houk, R.S. Mass Spectrometry of Inductively Coupled Plasmas. *Anal. Chem.* 58 97A-105A, 1986.
4. Thompson, J.J. and R. S. Houk. A Study of Internal Standardization in Inductively Coupled Plasma-Mass Spectrometry. *Appl. Spec.* 41 801-806, 1987.

5. Carcinogens - Working With Carcinogens, Department of Health, Education, and Welfare, Public Health Service, Center for Disease Control, National Institute for Occupational Safety and Health, Publication No. 77-206, Aug. 1977. Available from the National Technical Information Service (NTIS) as PB-277256.
6. OSHA Safety and Health Standards, General Industry, (29 CFR 1910), Occupational Safety and Health Administration, OSHA 2206, (Revised, January 1976).
7. Safety in Academic Chemistry Laboratories, American Chemical Society Publication, Committee on Chemical Safety, 3rd Edition, 1979.
8. Proposed OSHA Safety and Health Standards, Laboratories, Occupational Safety and Health Administration, Federal Register, July 24, 1986.
9. American Society for Testing and Materials. Standard Specification for Reagent Water, D1193-77. Annual Book of ASTM Standards, Vol. 11.01. Philadelphia, PA, 1991.
10. Code of Federal Regulations 40, Ch. 1, Pt. 136 Appendix B.
11. Longbottom, J.E. et. al. Determination of Trace Elements in Water by Inductively Coupled Plasma-Mass Spectrometry: Collaborative Study, Journal of AOAC International 77 1004-1023, 1994.
12. Hinnners, T.A. Interferences in ICP-MS by Bromine Species. Winter Conference on Plasma Spectrochemistry, San Diego, CA, January, 10-15, 1994.

17.0 TABLES, DIAGRAMS, FLOWCHARTS, AND VALIDATION DATA**TABLE 1: ESTIMATED INSTRUMENT DETECTION LIMITS**

Element	Recommended Analytical Mass	Scanning Mode¹	Selection Ion Monitoring Mode^{2,3}
Aluminum	27	0.05	0.02
Antimony	123	0.08	0.008
Arsenic ⁽³⁾	75	0.9	0.02
Barium	137	0.5	0.03
Beryllium	9	0.1	0.02
Cadmium	111	0.1	0.02
Chromium	52	0.07	0.04
Cobalt	59	0.03	0.002
Copper	63	0.03	0.004
Lead	206, 207, 208	0.08	0.015
Manganese	55	0.1	0.007
Mercury	202	n.a	0.2
Molybdenum	98	0.1	0.005
Nickel	60	0.2	0.07
Selenium ⁽³⁾	82	5	1.3
Silver	107	0.05	0.004
Thallium	205	0.09	0.014
Thorium	232	0.03	0.005
Uranium	238	0.02	0.005
Vanadium	51	0.02	0.006
Zinc	66	0.2	0.07

Instrument detection limits (3σ) estimated from seven replicate integrations of the blank (1% v/v nitric acid) following calibration of the instrument with three replicate integrations of a multi-element standard.

¹Instrument operating conditions and data acquisition mode are given in Table 6.

²IDLs determined using state-of-the-art instrumentation (1994). Data for ⁷⁵As, ⁷⁷Se, and ⁸²Se were acquired using a dwell time of 4.096 seconds with 1500 area count per sec ⁸³Kr present in argon supply. All other data were acquired using a dwell time of 1.024 seconds per AMU monitored.

TABLE 2: COMMON MOLECULAR ION INTERFERENCES IN ICP-MS

BACKGROUND MOLECULAR IONS

Molecular Ion	Mass	Element Interference ^a
NH ⁺	15	
OH ⁺	17	
OH ₂ ⁺	18	
C ₂ ⁺	24	
CN ⁺	26	
CO ⁺	28	
N ₂ ⁺	28	
N ₂ H ⁺	29	
NO ⁺	30	
NOH ⁺	31	
O ₂ ⁺	32	
O ₂ H ⁺	33	
³⁶ ArH ⁺	37	
³⁸ ArH ⁺	39	
⁴⁰ ArH ⁺	41	
CO ₂ ⁺	44	
CO ₂ H ⁺	45	Sc
ArC ⁺ , ArO ⁺	52	Cr
ArN ⁺	54	Cr
ArNH ⁺	55	Mn
ArO ⁺	56	
ArOH ⁺	57	
⁴⁰ Ar ³⁶ Ar ⁺	76	Se
⁴⁰ Ar ³⁸ Ar ⁺	78	Se
⁴⁰ Ar ⁺	80	Se

^amethod elements or internal standards affected by the molecular ions.

TABLE 2: COMMON MOLECULAR ION INTERFERENCES IN ICP-MS (Cont'd)

MATRIX MOLECULAR IONS		
Molecular Ion	Mass	Element Interference^a
Bromide¹²		
$^{81}\text{BrH}^+$	82	Se
$^{79}\text{BrO}^+$	95	Mo
$^{81}\text{BrO}^+$	97	Mo
$^{81}\text{BrOH}^+$	98	Mo
$\text{Ar}^{81}\text{Br}^+$	121	Sb
Chloride		
$^{35}\text{ClO}^+$	51	V
$^{35}\text{ClOH}^+$	52	Cr
$^{37}\text{ClO}^+$	53	Cr
$^{37}\text{ClOH}^+$	54	Cr
$\text{Ar}^{35}\text{Cl}^+$	75	As
$\text{Ar}^{37}\text{Cl}^+$	77	Se
Sulphate		
$^{32}\text{SO}^+$	48	
$^{32}\text{SOH}^+$	49	
$^{34}\text{SO}^+$	50	V, Cr
$^{34}\text{SOH}^+$	51	V
$\text{SO}_2^+, \text{S}_2^+$	64	Zn
Ar^{32}S^+	72	
Ar^{34}S^+	74	
Phosphate		
PO^+	47	
POH^+	48	
PO_2^+	63	Cu
ArP^+	71	
Group I, II Metals		
ArNa^+	63	Cu
ArK^+	79	
ArCa^+	80	

TABLE 2: COMMON MOLECULAR ION INTERFERENCES IN ICP-MS (Cont'd)**MATRIX MOLECULAR IONS**

Molecular Ion	Mass	Element Interference^a
Matrix Oxides [*]		
TiO	62-66	Ni, Cu, Zn
ZrO	106-112	Ag, Cd
MoO	108-116	Cd

^{*}Oxide interferences will normally be very small and will only impact the method elements when present at relatively high concentrations. Some examples of matrix oxides are listed of which the analyst should be aware. It is recommended that Ti and Zr isotopes are monitored in solid waste samples, which are likely to contain high levels of these elements. Mo is monitored as a method analyte.

TABLE 3: INTERNAL STANDARDS AND LIMITATIONS OF USE

Internal Standard	Mass	Possible Limitation
⁶ Lithium	6	a
Scandium	45	polyatomic ion interference
Yttrium	89	a,b
Rhodium	103	
Indium	115	isobaric interference by Sn
Terbium	159	
Holmium	165	
Lutetium	175	
Bismuth	209	a

a May be present in environmental samples.

b In some instruments Yttrium may form measurable amounts of YO⁺ (105 amu) and YOH⁺ (106 amu). If this is the case, care should be taken in the use of the cadmium elemental correction equation.

Internal standards recommended for use with this method are shown in bold face. Preparation procedures for these are included in Section 7.3.

TABLE 4: RECOMMENDED ANALYTICAL ISOTOPES AND ADDITIONAL MASSES WHICH MUST BE MONITORED

Isotope	Element of Interest
<u>27</u>	Aluminum
121, <u>123</u>	Antimony
<u>75</u>	Arsenic
135, <u>137</u>	Barium
<u>9</u>	Beryllium
106, 108, <u>111</u> , 114	Cadmium
<u>52</u> , 53	Chromium
<u>59</u>	Cobalt
<u>63</u> , 65	Copper
<u>206</u> , <u>207</u> , <u>208</u>	Lead
<u>55</u>	Manganese
95, 97, <u>98</u>	Molybdenum
<u>60</u> , 62	Nickel
77, <u>82</u>	Selenium
<u>107</u> , 109	Silver
<u>203</u> , <u>205</u>	Thallium
<u>232</u>	Thorium
<u>238</u>	Uranium
<u>51</u>	Vanadium
<u>66</u> , 67, 68	Zinc
83	Krypton
99	Ruthenium
105	Palladium
118	Tin

NOTE: Isotopes recommended for analytical determination are underlined.

TABLE 5: RECOMMENDED ELEMENTAL EQUATIONS FOR DATA CALCULATIONS

Element	Elemental Equation	Note
Al	(1.000) (²⁷ C)	
Sb	(1.000) (¹²³ C)	
As	(1.000) (⁷⁵ C)-(3.127) [(⁷⁷ C)-(0.815) (⁸² C)]	(1)
Ba	(1.000) (¹³⁷ C)	
Be	(1.000) (⁹ C)	
Cd	(1.000) (¹¹¹ C)-(1.073) [(¹⁰⁸ C)-(0.712) (¹⁰⁶ C)]	(2)
Cr	(1.000) (⁵² C)	(3)
Co	(1.000) (⁵⁹ C)	
Cu	(1.000) (⁶³ C)	
Pb	(1.000) (²⁰⁶ C)+(1.000) [(²⁰⁷ C)+(1.000) (²⁰⁸ C)]	(4)
Mn	(1.000) (⁵⁵ C)	
Mo	(1.000) (⁹⁸ C)-(0.146) (⁹⁹ C)	(5)
Ni	(1.000) (⁶⁰ C)	
Se	(1.000) (⁸² C)	(6)
Ag	(1.000) (¹⁰⁷ C)	
Tl	(1.000) (²⁰⁵ C)	
Th	(1.000) (²³² C)	
U	(1.000) (²³⁸ C)	
V	(1.000) (⁵¹ C)-(3.127) [(⁵³ C)-(0.113) (⁶² C)]	(7)
Zn	(1.000) (⁶⁶ C)	

TABLE 5: RECOMMENDED ELEMENTAL EQUATIONS FOR DATA CALCULATIONS

Element	Elemental Equation	Note
Bi	(1.000) (²⁰⁹ C)	
In	(1.000) (²⁰⁹ C)-(0.016) (¹¹⁸ C)	(8)
Sc	(1.000) (⁴⁵ C)	
Tb	(1.000) (¹⁵⁹ C)	
Y	(1.000) (⁸⁹ C)	

C - Calibration blank subtracted counts at specified mass.

(1) - Correction for chloride interference with adjustment for ⁷⁷Se. ArCl 75/77 ratio may be determined from the reagent blank. Isobaric mass 82 must be from Se only and not BrH⁺.

(2) - Correction for MoO interference. Isobaric mass 106 must be from Cd only not ZrO⁺. An additional isobaric elemental correction should be made if palladium is present.

(3) - In 0.4% v/v HCl, the background from ClOH will normally be small. However the contribution may be estimated from the reagent blank. Isobaric mass must be from Cr only not ArC⁺.

(4) - Allowance for isotopic variability of lead isotopes.

(5) - Isobaric elemental correction for ruthenium.

(6) - Some argon supplies contain krypton as an impurity. Selenium is corrected for ⁸²Kr by background subtraction.

(7) - Correction for chloride interference with adjustment for ⁵³Cr. ClO 51/53 ratio may be determined from the reagent blank. Isobaric mass 52 must be from Cr only not ArC⁺.

(8) - Isobaric elemental correction for tin.

**TABLE 6: INSTRUMENT OPERATING CONDITIONS FOR PRECISION
AND RECOVERY DATA¹**

Instrument	VG PlasmaQuad Type I
Plasma forward power	1.35 kW
Coolant flow rate	13.5 L/min.
Auxillary flow rate	0.6 L/min.
Nebulizer flow rate	0.78 L/min.
Solution uptake rate	0.6 mL/min.
Spray chamber temperature	15°C
Data Acquisition	
Detector mode	Pulse counting
Replicate integrations	3
Mass range	8-240 amu
Dwell time	320 µs
Number of MCA channels	2048
Number of scan sweeps	85
Total acquisition time	3 minutes per sample

¹The described instrument and operating conditions were used to determine the scanning mode MDL data listed in Table 7 and the precision and recovery data given in Tables 9 and 10.

TABLE 7: METHOD DETECTION LIMITS

AMU	Element	Scanning Mode ¹		Selection Ion Monitoring Mode ²	
		Total Recoverable		Total Recoverable	Direct Analysis ³
		Aqueous µg/L	Solids mg/kg	Aqueous µg/L	Aqueous µg/L
27	Al	1.0	0.4	1.7	0.04
123	Sb	0.4	0.2	0.04	0.02
75	As	1.4	0.6	0.4	0.1
137	Ba	0.8	0.4	0.04	0.04
9	Be	0.3	0.1	0.02	0.03
111	Cd	0.5	0.2	0.03	0.03
52	Cr	0.9	0.4	0.08	0.08
59	Co	0.09	0.04	0.004	0.003
63	Cu	0.5	0.2	0.02	0.01
206,207,208	Pb	0.6	0.3	0.05	0.02
55	Mn	0.1	0.05	0.02	0.04
202	Hg	n.a.	n.a.	n.a.	0.2
98	Mo	0.3	0.1	0.01	0.01
60	Ni	0.5	0.2	0.06	0.03
82	Se	7.9	3.2	2.1	0.5
107	Ag	0.1	0.05	0.005	0.005
205	Tl	0.3	0.1	0.02	0.01
232	Th	0.1	0.05	0.02	0.01
238	U	0.1	0.05	0.01	0.01
51	V	2.5	1.0	0.9	0.05
66	Zn	1.8	0.7	0.1	0.2

¹Data acquisition mode given in Table 6. Total recoverable MDL concentrations are computed for original matrix with allowance for sample dilution during preparation. Listed MDLs for solids calculated from determined aqueous MDLs.

²MDLs determined using state-of-the-art instrumentation (1994). Data for ⁷⁵As, ⁷⁷Se, and ⁸²Se were acquired using a dwell time of 4.096 seconds with 1500 area count per seconds ⁸³Kr present in argon supply. All other data were acquired using a dwell time of 1.024 seconds per AMU monitored.

³MDLs were determined from analysis of seven undigested aqueous sample aliquots.

n.a. - Not applicable. Total recoverable digestion not suitable for organo-mercury compounds.

TABLE 8: ACCEPTANCE LIMITS FOR QC CHECK SAMPLE

METHOD PERFORMANCE (µg/L)¹

Element	QC Check Sample Conc.	Average Recovery	Standard Deviation ² (S _r)	Acceptance Limits ³ µg/L
Aluminum	100	100.4	5.49	84-117
Antimony	100	99.9	2.40	93-107
Arsenic	100	101.6	3.66	91-113
Barium	100	99.7	2.64	92-108
Beryllium	100	105.9	4.13	88-112 ⁴
Cadmium	100	100.8	2.32	94-108
Chromium	100	102.3	3.91	91-114
Cobalt	100	97.7	2.66	90-106
Copper	100	100.3	2.11	94-107
Lead	100	104.0	3.42	94-114
Manganese	100	98.3	2.71	90-106
Molybdenum	100	101.0	2.21	94-108
Nickel	100	100.1	2.10	94-106
Selenium	100	103.5	5.67	86-121
Silver	100	101.1	3.29	91-111 ⁵
Thallium	100	98.5	2.79	90-107
Thorium	100	101.4	2.60	94-109
Uranium	100	102.6	2.82	94-111
Vanadium	100	100.3	3.26	90-110
Zinc	100	105.1	4.57	91-119

¹Method performance characteristics calculated using regression equations from collaborative study, Reference 11.

²Single-analyst standard deviation, S_r.

³Acceptance limits calculated as average recovery ± three standard deviations.

⁴Acceptance limits centered at 100% recovery.

⁵Statistics estimated from summary statistics at 48 and 64 µg/L.

TABLE 9: PRECISION AND RECOVERY DATA IN AQUEOUS MATRICES

DRINKING WATER									
Element	Sample	Low	Average			High	Average		
	Conc.	Spike	Recovery	S (R)	RPD	Spike	Recovery	S (R)	RPD
	µg/L	µg/L	R (%)			µg/L	R (%)		
Al	175	50	115.8	5.9	0.4	200	102.7	1.6	1.1
Sb	<0.4	10	99.1	0.7	2.0	100	100.8	0.7	2.0
As	<1.4	50	99.7	0.8	2.2	200	102.5	1.1	2.9
Ba	43.8	50	94.8	3.9	5.8	200	95.6	0.8	1.7
Be	<0.3	10	113.5	0.4	0.9	100	111.0	0.7	1.8
Cd	<0.5	10	97.0	2.8	8.3	100	101.5	0.4	1.0
Cr	<0.9	10	111.0	3.5	9.0	100	99.5	0.1	0.2
Co	0.11	10	94.4	0.4	1.1	100	93.6	0.5	1.4
Cu	3.6	10	101.8	8.8	17.4	100	91.6	0.3	0.3
Pb	0.87	10	97.8	2.0	2.8	100	99.0	0.8	2.2
Mn	0.96	10	96.9	1.8	4.7	100	95.8	0.6	1.8
Mo	1.9	10	99.4	1.6	3.4	100	98.6	0.4	1.0
Ni	1.9	10	100.2	5.7	13.5	100	95.2	0.5	1.3
Se	<7.9	50	99.0	1.8	5.3	200	93.5	3.5	10.7
Ag	<0.1	50	100.7	1.5	4.2	200	99.0	0.4	1.0
Tl	<0.3	10	97.5	0.4	1.0	100	98.5	1.7	4.9
Th	<0.1	10	109.0	0.7	1.8	100	106.0	1.4	3.8
U	0.23	10	110.7	1.4	3.5	100	107.8	0.7	1.9
V	<2.5	50	101.4	0.1	0.4	200	97.5	0.7	2.1
Zn	5.2	50	103.4	3.3	7.7	200	96.4	0.5	1.0

S (R) Standard deviation of percent recovery.

RPD Relative percent difference between duplicate spike determinations.

< Sample concentration below established method detection limit.

TABLE 9: PRECISION AND RECOVERY DATA IN AQUEOUS MATRICES (Cont'd)

<u>WELL WATER</u>									
Element	Sample	Low	Average			High	Average		
	Conc.	Spike	Recovery	S (R)	RPD	Spike	Recovery	S (R)	RPD
	µg/L	µg/L	R (%)			µg/L	R (%)		
Al	34.3	50	100.1	3.9	0.8	200	102.6	1.1	1.3
Sb	0.46	10	98.4	0.9	1.9	100	102.5	0.7	1.9
As	<1.4	50	110.0	6.4	16.4	200	101.3	0.2	0.5
Ba	106	50	95.4	3.9	3.3	200	104.9	1.0	1.6
Be	<0.3	10	104.5	0.4	1.0	100	101.4	1.2	3.3
Cd	106	10	88.6	1.7	3.8	100	98.6	0.6	1.6
Cr	<0.9	10	111.0	0.0	0.0	100	103.5	0.4	1.0
Co	2.4	10	100.6	1.0	1.6	100	104.1	0.4	0.9
Cu	37.4	10	104.3	5.1	1.5	100	100.6	0.8	1.5
Pb	3.5	10	95.2	2.5	1.5	100	99.5	1.4	3.9
Mn	2770	10	*	*	1.8	100	*	*	0.7
Mo	2.1	10	103.8	1.1	1.6	100	102.9	0.7	1.9
Ni	11.4	10	116.5	6.3	6.5	100	99.6	0.3	0.0
Se	<7.9	50	127.3	8.4	18.7	200	101.3	0.2	0.5
Ag	<0.1	50	99.2	0.4	1.0	200	101.5	1.4	3.9
Tl	<0.3	10	93.9	0.1	0.0	100	100.4	1.8	5.0
Th	<0.1	10	103.0	0.7	1.9	100	104.5	1.8	4.8
U	1.8	10	106.0	1.1	1.6	100	109.7	2.5	6.3
V	<2.5	50	105.3	0.8	2.1	200	105.8	0.2	0.5
Zn	554	50	*	*	1.2	200	102.1	5.5	3.2

S (R) Standard deviation of percent recovery.

RPD Relative percent difference between duplicate spike determinations.

< Sample concentration below established method detection limit.

* Spike concentration <10% of sample background concentration.

TABLE 9: PRECISION AND RECOVERY DATA IN AQUEOUS MATRICES (Cont'd)

POND WATER									
Element	Sample	Low	Average			High	Average		
	Conc.	Spike	Recovery	S (R)	RPD	Spike	Recovery	S (R)	RPD
	µg/L	µg/L	R (%)			µg/L	R (%)		
Al	610	50	*	*	1.7	200	78.2	9.2	5.5
Sb	<0.4	10	101.1	1.1	2.9	100	101.5	3.0	8.4
As	<1.4	50	100.8	2.0	5.6	200	96.8	0.9	2.6
Ba	28.7	50	102.1	1.8	2.4	200	102.9	3.7	9.0
Be	<0.3	10	109.1	0.4	0.9	100	114.4	3.9	9.6
Cd	<0.5	10	106.6	3.2	8.3	100	105.8	2.8	7.6
Cr	2.0	10	107.0	1.0	1.6	100	100.0	1.4	3.9
Co	0.79	10	101.6	1.1	2.7	100	101.7	1.8	4.9
Cu	5.4	10	107.5	1.4	1.9	100	98.1	2.5	6.8
Pb	1.9	10	108.4	1.5	3.2	100	106.1	0.0	0.0
Mn	617	10	*	*	1.1	100	139.0	11.1	4.0
Mo	0.98	10	104.2	1.4	3.5	100	104.0	2.1	5.7
Ni	2.5	10	102.0	2.3	4.7	100	102.5	2.1	5.7
Se	<7.9	50	102.7	5.6	15.4	200	105.5	1.4	3.8
Ag	0.12	50	102.5	0.8	2.1	200	105.2	2.7	7.1
Tl	<0.3	10	108.5	3.2	8.3	100	105.0	2.8	7.6
Th	0.19	10	93.1	3.5	10.5	100	93.9	1.6	4.8
U	0.30	10	107.0	2.8	7.3	100	107.2	1.8	4.7
V	3.5	50	96.1	5.2	14.2	200	101.5	0.2	0.5
Zn	6.8	50	99.8	1.7	3.7	200	100.1	2.8	7.7

S (R) Standard deviation of percent recovery.

RPD Relative percent difference between duplicate spike determinations.

< Sample concentration below established method detection limit.

* Spike concentration <10% of sample background concentration.

**TABLE 9: PRECISION AND RECOVERY DATA IN AQUEOUS
MATRICES (Cont'd)**

SEWAGE TREATMENT PRIMARY EFFLUENT

Element	Sample	Low	Average			High	Average		
	Conc. µg/L	Spike µg/L	Recovery R (%)	S (R)	RPD	Spike µg/L	Recovery R (%)	S (R)	RPD
Al	1150	50	*	*	3.5	200	100.0	13.8	1.5
Sb	1.5	10	95.7	0.4	0.9	100	104.5	0.7	1.9
As	<1.4	50	104.2	4.5	12.3	200	101.5	0.7	2.0
Ba	202	50	79.2	9.9	2.5	200	108.6	4.6	5.5
Be	<0.3	10	110.5	1.8	4.5	100	106.4	0.4	0.9
Cd	9.2	10	101.2	1.3	0.0	100	102.3	0.4	0.9
Cr	128	10	*	*	1.5	100	102.1	1.7	0.4
Co	13.4	10	95.1	2.7	2.2	100	99.1	1.1	2.7
Cu	171	10	*	*	2.4	100	105.2	7.1	0.7
Pb	17.8	10	95.7	3.8	1.1	100	102.7	1.1	2.5
Mn	199	10	*	*	1.5	100	103.4	2.1	0.7
Mo	136	10	*	*	1.4	100	105.7	2.4	2.1
Ni	84.0	10	88.4	16.3	4.1	100	98.0	0.9	0.0
Se	<7.9	50	112.0	10.9	27.5	200	108.8	3.0	7.8
Ag	10.9	50	97.1	0.7	1.5	200	102.6	1.4	3.7
Tl	<0.3	10	97.5	0.4	1.0	100	102.0	0.0	0.0
Th	0.11	10	15.4	1.8	30.3	100	29.3	0.8	8.2
U	0.71	10	109.4	1.8	4.3	100	109.3	0.7	1.8
V	<2.5	50	90.9	0.9	0.6	200	99.4	2.1	6.0
Zn	163	50	85.8	3.3	0.5	200	102.0	1.5	1.9

S (R) Standard deviation of percent recovery.

RPD Relative percent difference between duplicate spike determinations.

< Sample concentration below established method detection limit.

* Spike concentration <10% of sample background concentration.

**TABLE 9: PRECISION AND RECOVERY DATA IN AQUEOUS
MATRICES (Cont'd)**

INDUSTRIAL EFFLUENT									
Element	Sample	Low	Average			High	Average		
	Conc.	Spike	Recovery	S (R)	RPD	Spike	Recovery	S (R)	RPD
	µg/L	µg/L	R (%)			µg/L	R (%)		
Al	44.7	50	98.8	8.7	5.7	200	90.4	2.1	2.2
Sb	2990	10	*	*	0.3	100	*	*	0.0
As	<1.4	50	75.1	1.8	6.7	200	75.0	0.0	0.0
Ba	100	50	96.7	5.5	3.4	200	102.9	1.1	0.7
Be	<0.3	10	103.5	1.8	4.8	100	100.0	0.0	0.0
Cd	10.1	10	106.5	4.4	2.4	100	97.4	1.1	2.8
Cr	171	10	*	*	0.0	100	127.7	2.4	1.7
Co	1.3	10	90.5	3.2	8.7	100	90.5	0.4	1.3
Cu	101	10	*	*	0.9	100	92.5	2.0	1.6
Pb	294	10	*	*	2.6	100	108.4	2.1	0.0
Mn	154	10	*	*	2.8	100	103.6	3.7	1.6
Mo	1370	10	*	*	1.4	100	*	*	0.7
Ni	17.3	10	107.4	7.4	5.0	100	88.2	0.7	1.0
Se	15.0	50	129.5	9.3	15.1	200	118.3	1.9	3.6
Ag	<0.1	50	91.8	0.6	1.7	200	87.0	4.9	16.1
Tl	<0.3	10	90.5	1.8	5.5	100	98.3	1.0	2.8
Th	0.29	10	109.6	1.2	2.7	100	108.7	0.0	0.0
U	0.17	10	104.8	2.5	6.6	100	109.3	0.4	0.9
V	<2.5	50	74.9	0.1	0.3	200	72.0	0.0	0.0
Zn	43.4	50	85.0	4.0	0.6	200	97.6	1.0	0.4

S (R) Standard deviation of percent recovery.

RPD Relative percent difference between duplicate spike determinations.

< Sample concentration below established method detection limit.

* Spike concentration <10% of sample background concentration.

TABLE 10: PRECISION AND RECOVERY DATA IN SOLID MATRICES

EPA HAZARDOUS SOIL #884

Element	Sample Conc. (mg/kg)	Low ⁺ Spike (mg/kg)	Average Recovery			High ⁺ Spike (mg/kg)	Average Recovery		
			R (%)	S (R)	RPD		R (%)	S (R)	RPD
Al	5170	20	*	*	–	100	*	*	–
Sb	5.4	20	69.8	2.5	4.7	100	70.4	1.8	6.5
As	8.8	20	104.7	5.4	9.1	100	102.2	2.2	5.4
Ba	113	20	54.9	63.6	18.6	100	91.0	9.8	0.5
Be	0.6	20	100.1	0.6	1.5	100	102.9	0.4	1.0
Cd	1.8	20	97.3	1.0	1.4	100	101.7	0.4	1.0
Cr	83.5	20	86.7	16.1	8.3	100	105.5	1.3	0.0
Co	7.1	20	98.8	1.2	1.9	100	102.9	0.7	1.8
Cu	115	20	86.3	13.8	3.4	100	151.7	4.2	4.6
Pb	152	20	85.0	45.0	13.9	100	85.2	25.7	23.7
Mn	370	20	*	*	12.7	100	95.2	10.4	2.2
Mo	4.8	20	95.4	1.5	2.9	100	102.3	0.7	2.0
Ni	19.2	20	101.7	3.8	1.0	100	100.7	0.8	0.8
Se	<3.2	20	79.5	7.4	26.4	100	94.8	9.4	26.5
Ag	1.1	20	96.1	0.6	0.5	100	97.9	0.8	2.3
Tl	0.24	20	94.3	1.1	3.1	100	76.0	1.0	2.9
Th	1.0	20	69.8	0.6	1.3	100	102.9	2.2	7.9
U	1.1	20	100.1	0.2	0.0	100	106.7	0.0	0.0
V	17.8	20	109.2	4.2	2.3	100	113.4	1.3	2.4
Zn	128	20	87.0	27.7	5.5	100		12.9	14.1

S (R) Standard deviation of percent recovery.

RPD Relative percent difference between duplicate spike determinations.

< Sample concentration below established method detection limit.

* Spike concentration <10% of sample background concentration.

– Not determined.

⁺ Equivalent.

TABLE 10: PRECISION AND RECOVERY DATA IN SOLID MATRICES

NBS 1645 RIVER SEDIMENT

Element	Sample Conc. (mg/kg)	Low ⁺ Spike (mg/kg)	Average Recovery			High ⁺ Spike (mg/kg)	Average Recovery		
			R (%)	S (R)	RPD		R (%)	S (R)	RPD
Al	5060	20	*	*	–	100	*	*	–
Sb	21.8	20	73.9	6.5	9.3	100	81.2	1.5	3.9
As	67.2	20	104.3	13.0	7.6	100	107.3	2.1	2.9
Ba	54.4	20	105.6	4.9	2.8	100	98.6	2.2	3.9
Be	0.59	20	88.8	0.2	0.5	100	87.9	0.1	0.2
Cd	8.3	20	92.9	0.4	0.0	100	95.7	1.4	3.9
Cr	29100	20	*	*	–	100	*	*	–
Co	7.9	20	97.6	1.3	2.6	100	103.1	0.0	0.0
Cu	112	20	121.0	9.1	1.5	100	105.2	2.2	1.8
Pb	742	20	*	*	–	100	–	–	–
Mn	717	20	*	*	–	100	–	–	–
Mo	17.1	20	89.8	8.1	12.0	100	98.4	0.7	0.9
Ni	41.8	20	103.7	6.5	4.8	100	102.2	0.8	0.0
Se	<3.2	20	108.3	14.3	37.4	100	93.9	5.0	15.1
Ag	1.8	20	94.8	1.6	4.3	100	96.2	0.7	1.9
Tl	1.2	20	91.2	1.3	3.6	100	94.4	0.4	1.3
Th	0.90	20	91.3	0.9	2.6	100	92.3	0.9	2.8
U	0.79	20	95.6	1.8	5.0	100	98.5	1.2	3.5
V	21.8	20	91.8	4.6	5.7	100	100.7	0.6	0.8
Zn	1780	20	*	*	–	100	*	*	–

S (R) Standard deviation of percent recovery.

RPD Relative percent difference between duplicate spike determinations.

< Sample concentration below established method detection limit.

* Spike concentration <10% of sample background concentration.

– Not determined.

⁺ Equivalent.

TABLE 10: PRECISION AND RECOVERY DATA IN SOLID MATRICES

EPA ELECTROPLATING SLUDGE #286									
Element	Sample Conc. (mg/kg)	Low ⁺ Spike (mg/kg)	Average Recovery			High ⁺ Spike (mg/kg)	Average Recovery		
			R (%)	S (R)	RPD		R (%)	S (R)	RPD
Al	5110	20	*	*	-	100	*	*	-
Sb	8.4	20	55.4	1.5	4.1	100	61.0	0.2	0.9
As	41.8	20	91.0	2.3	1.7	100	94.2	0.8	1.5
Ba	27.3	20	1.8	7.1	8.3	100	0	1.5	10.0
Be	0.25	20	92.0	0.9	2.7	100	93.4	0.3	0.9
Cd	112	20	85.0	5.2	1.6	100	88.5	0.8	0.5
Cr	7980	20	*	*	-	100	*	*	-
Co	4.1	20	89.2	1.8	4.6	100	88.7	1.5	4.6
Cu	740	20	*	*	6.0	100	61.7	20.4	5.4
Pb	1480	20	*	*	-	100	*	*	-
Mn	295	20	*	*	-	100	-	-	-
Mo	13.3	20	82.9	1.2	1.3	100	89.2	0.4	1.0
Ni	450	20	*	*	6.8	100	83.0	10.0	4.5
Se	3.5	20	89.7	3.7	4.2	100	91.0	6.0	18.0
Ag	5.9	20	89.8	2.1	4.6	100	85.1	0.4	1.1
Tl	1.9	20	96.9	0.9	2.4	100	98.9	0.9	2.4
Th	3.6	20	91.5	1.3	3.2	100	97.4	0.7	2.0
U	2.4	20	107.7	2.0	4.6	100	109.6	0.7	1.8
V	21.1	20	105.6	1.8	2.1	100	97.4	1.1	2.5
Zn	13300	20	*	*	-	100	*	*	-

S (R) Standard deviation of percent recovery.

RPD Relative percent difference between duplicate spike determinations.

< Sample concentration below established method detection limit.

* Spike concentration <10% of sample background concentration.

- Not determined.

⁺ Equivalent.

**TABLE 11: PRIMARY DRINKING WATER CONTAMINANTS
PRECISION AND RECOVERY DATA**

Analyte	Regional Sample Background Concentration, µg/L			Average Mean ¹ % Recovery	S (R)
	(IV)	(VI)	(X)		
Antimony	0.16	0.07	0.03	114%	1.9
Arsenic	< MDL	2.4	1.0	93	8.5
Barium	4.6	280	14.3	(*)	–
Beryllium	< MDL	< MDL	< MDL	100%	8.2
Cadmium	0.05	0.05	0.03	81	4.0
Chromium	0.71	5.1	0.10	94	2.5
Copper	208	130	14.3	(*)	–
Lead	1.2	1.2	2.5	91	2.6
Mercury	< MDL	0.23	< MDL	86	11.4
Nickel	1.7	3.6	0.52	101%	11.5
Selenium	< MDL	4.3	< MDL	98	8.4
Thallium	< MDL	0.01	< MDL	100	1.4

¹The three regional waters were fortified with 1.0 µg/L of all analytes listed, except selenium, which was fortified to 20 µg/L.

(*) Recovery of barium and copper was not calculated because the analyte addition was <20% the sample background concentration in all waters. (Recovery calculations are not required if the concentration of the analyte added is less than 30% of the sample background concentration. Section 9.4.3).

S (R) Standard deviation of the mean percent recoveries.

TABLE 12: SUMMARY STATISTICS AND DESCRIPTIVE EQUATIONS FOR THE 20 ANALYTES TESTED IN THE COLLABORATIVE STUDY

Analyte	Reagent Water					Finished Drinking Water					Ground Water				
	C ^a	\bar{X}^b	S _R	S _T	Regr. Equations	\bar{X}	S _R	S _T	Regr. Equations	\bar{X}	S _R	S _T	Regr. Equations		
Aluminum	8.00	10.01	2.33	1.74	$\bar{X} = 0.992C + 1.19$	11.18	9.02	6.34	$\bar{X} = 0.954C + 2.38$	9.86	7.10	2.70	$\bar{X} = 0.946C + 2.20$		
	12.00	10.98	5.16		$S_R = 0.056\bar{X} + 2.59^c$	11.02	3.02		$S_R = 7.70^d$	13.40	10.27		$S_R = 0.169\bar{X} + 6.22^e$		
	56.00	59.13	5.55	4.19	$S_T = 0.042X + 1.27$	56.97	7.14	6.18	$S_T = 0.013X + 6.17$	51.75	10.78	16.92	$S_T = 0.172X + 0.75^f$		
	80.00	82.59	4.92			82.73	8.01			82.83	33.37				
	160.00	158.95	11.82	8.90		159.89	11.94	10.59		155.40	15.39	19.27			
	200.00	200.89	8.61			189.98	12.97			189.64	31.46				
Antimony	2.80	2.75	0.27	0.27	$\bar{X} = 0.999C + 0.04$	2.73	0.29	0.17	$\bar{X} = 0.983C + 0.03$	2.82	0.19	0.22	$\bar{X} = 1.003C + 0.01$		
	4.00	4.22	0.46		$S_R = 0.013\bar{X} + 0.61^a$	4.10	0.47		$S_R = 0.049\bar{X} + 0.19$	4.02	0.35		$S_R = 0.059\bar{X} + 0.04$		
	20.00	19.76	1.09	0.85	$S_T = 0.022X + 0.20$	19.17	1.37	0.66	$S_T = 0.026X + 0.08$	20.12	0.82	0.97	$S_T = 0.058X + 0.02$		
	28.00	27.48	1.38			26.48	1.72			27.77	1.38				
	80.00	82.52	2.24	1.76		83.43	2.05	2.46		80.34	9.14	6.80			
	100.00	98.06	1.34			97.19	5.31			101.09	2.89				
Arsenic	8.00	8.64	3.01	3.02	$\bar{X} = 1.013C + 0.50$	9.00	3.13	1.96	$\bar{X} = 0.993C + 0.57$	10.40	5.17	4.90	$\bar{X} = 0.949C + 0.91$		
	12.00	12.58	3.18		$S_R = 0.031\bar{X} + 2.74$	11.37	1.77		$S_R = 0.018\bar{X} + 2.55$	7.85	4.62		$S_R = 0.048\bar{X} + 4.52$		
	56.00	55.44	4.64	3.51	$S_T = 0.007X + 2.95$	53.77	4.12	4.07	$S_T = 0.031X + 1.65$	53.25	3.49	7.88	$S_T = 0.059X + 4.29$		
	80.00	85.15	2.54			87.72	4.14			83.60	12.46				
	160.00	161.80	11.15	3.96		157.56	4.83	6.30		159.86	11.67	14.94			
	200.00	201.52	10.81			197.99	10.66			194.41	18.24				
Barium	8.01	7.58	0.50	0.48	$\bar{X} = 1.001C - 0.36$	8.21	1.21	1.11	$\bar{X} = 0.995C + 0.37$	8.04	2.60	2.24	$\bar{X} = 1.055C - 0.21$		
	12.00	11.81	1.05		$S_R = 0.039\bar{X} + 0.31$	12.56	1.79		$S_R = 0.045\bar{X} + 0.97^c$	12.85	1.45		$S_R = 0.020\bar{X} + 2.05$		
	48.00	47.32	1.60	1.82	$S_T = 0.024X + 0.25$	49.13	3.72	3.77	$S_T = 0.040X + 0.72^c$	50.12	2.98	2.19	$S_T = 0.014X + 2.08$		
	64.00	65.52	2.90			65.30	4.16			69.53	2.66				
	160.00	157.09	6.53	4.07		155.25	7.82	5.67		164.44	8.81	6.61			
	200.00	198.53	8.28			196.52	5.70			208.32	9.22				
Beryllium	2.80	3.31	0.81	0.26	$\bar{X} = 1.056C + 0.32$	3.15	0.47	0.31	$\bar{X} = 1.055C + 0.20$	3.02	0.46	0.22	$\bar{X} = 1.049C + 0.08$		
	4.00	4.45	0.73		$S_R = 0.067\bar{X} + 0.55$	4.45	0.51		$S_R = 0.057\bar{X} + 0.28$	4.27	0.44		$S_R = 0.084\bar{X} + 0.16$		
	20.00	22.38	2.76	1.00	$S_T = 0.038X + 0.11$	21.27	1.23	0.63	$S_T = 0.016X + 0.25$	21.55	1.72	1.10	$S_T = 0.043X + 0.06$		
	28.00	30.02	2.86			29.57	1.67			29.24	2.09				
	80.00	84.18	4.79	4.02		87.59	6.89	1.88		84.23	9.05	4.32			
	100.00	102.88	5.90			102.64	6.27			103.39	10.17				
Cadmium	4.00	4.01	0.34	0.20	$\bar{X} = 1.007C + 0.07$	4.11	0.88	0.71	$\bar{X} = 0.985C + 0.10$	3.98	0.48	0.14	$\bar{X} = 0.944C + 0.11$		
	6.00	6.32	0.49		$S_R = 0.041\bar{X} + 0.19$	5.87	0.58		$S_R = 0.031\bar{X} + 0.65$	5.62	0.73		$S_R = 0.017\bar{X} + 1.09^a$		
	20.00	19.81	1.12	0.86	$S_T = 0.022X + 0.10^c$	19.57	1.45	1.26	$S_T = 0.021X + 0.61$	18.15	1.73	0.88	$S_T = 0.029X + 0.01$		
	28.00	28.33	0.94			27.68	1.27			26.86	2.59				
	80.00	81.28	4.91	1.33		80.62	4.45	2.02		77.83	3.05	1.88			
	100.00	100.11	3.24			98.15	3.60			95.31	2.04				

TABLE 12: SUMMARY STATISTICS AND DESCRIPTIVE EQUATIONS FOR THE 20 ANALYTES TESTED IN THE COLLABORATIVE STUDY

Analyte	Reagent Water					Finished Drinking Water					Ground Water				
	C	\bar{X}^b	S_R	S_T	Regr. Equations	\bar{X}	S_R	S_T	Regr. Equations	\bar{X}	S_R	S_T	Regr. Equations		
Chromium	8.00	8.27	0.32	1.54	$\bar{X} = 1.017C + 0.62$	9.46	2.34	2.08	$\bar{X} = 0.990C + 1.45$	8.98	1.47	0.37	$\bar{X} = 1.026C + 0.89$		
	12.00	13.88	3.10		$S_R = 0.066\bar{X} + 0.48$	13.10	2.39		$S_R = 0.015\bar{X} + 2.19$	13.42	1.13		$S_R = 0.067\bar{X} + 0.68$		
	56.00	57.86	4.03	2.68	$S_T = 0.026\bar{X} + 1.25$	56.04	2.24	1.29	$S_T = 2.18^d$	59.35	5.99	5.42	$S_T = 0.068\bar{X} - 0.37$		
	80.00	84.73	2.65			84.38	3.18			83.90	5.70				
	160.00	157.66	13.62	6.97		158.24	5.12	3.16		164.58	14.11	9.80			
	200.00	197.43	9.47			196.72	7.47			199.88	11.19				
Cobalt	0.80	0.88	0.10	0.05	$\bar{X} = 0.977C + 0.01$	0.92	0.45	0.31	$\bar{X} = 0.964C + 0.06$	0.85	0.13	0.09	$\bar{X} = 0.989C - 0.01$		
	1.21	0.98	0.04		$S_R = 0.028\bar{X} + 0.06$	1.02	0.10		$S_R = 0.019\bar{X} + 0.32$	1.04	0.18		$S_R = 0.057\bar{X} + 0.09$		
	20.10	20.77	0.74	0.67	$S_T = 0.027\bar{X} + 0.02$	20.45	0.91	0.53	$S_T = 0.014\bar{X} + 0.30$	20.81	1.11	1.12	$S_T = 0.012\bar{X} + 0.40^e$		
	28.20	27.75	0.96			27.29	1.22			28.07	2.16				
	80.50	78.59	2.29	2.31		78.04	3.72	1.84		79.26	4.66	1.34			
	101.00	98.79	2.94			97.62	4.62			99.41	4.22				
Copper	4.00	3.88	0.73	0.59	$\bar{X} = 1.003C - 0.05$	3.33	0.85	0.99	$\bar{X} = 0.976C - 0.38$	3.86	1.40	0.71	$\bar{X} = 0.977C - 0.01$		
	6.00	6.14	1.00		$S_R = 0.037\bar{X} + 0.64$	5.95	1.78		$S_R = 0.063\bar{X} + 0.86$	5.96	0.95		$S_R = 0.073\bar{X} + 0.92$		
	20.00	20.07	1.08	0.92	$S_T = 0.016\bar{X} + 0.51$	18.90	1.64	1.51	$S_T = 0.029\bar{X} + 0.86$	18.97	1.68	2.32	$S_T = 0.077\bar{X} + 0.35$		
	28.00	27.97	1.94			27.21	2.76			27.44	2.58				
	80.00	79.80	3.22	1.91		76.64	5.30	3.42		79.30	9.05	6.54			
	100.00	99.57	4.42			96.17	5.64			97.54	11.16				
Lead	4.00	4.00	1.57	1.62	$\bar{X} = 1.043C - 0.31$	3.44	1.15	1.18	$\bar{X} = 1.032C - 0.30$	4.20	1.13	1.76	$\bar{X} = 1.012C + 0.15$		
	6.00	5.56	2.00		$S_R = 0.064\bar{X} + 1.43^c$	6.84	1.10		$S_R = 0.015\bar{X} + 1.06$	6.27	2.38		$S_R = 0.048\bar{X} + 1.27$		
	20.00	20.54	2.91	4.36	$S_T = 3.42^d$	20.18	1.20	1.44	$S_T = 0.011\bar{X} + 1.13$	19.57	2.72	0.88	$S_T = 1.78^d$		
	28.00	30.90	4.58			28.08	1.57			28.55	1.73				
	80.00	80.57	3.13	4.29		80.92	2.30	2.07		82.47	4.38	2.69			
	100.00	102.93	6.62			101.60	3.23			102.47	3.58				
Manganese	0.80	0.86	0.15	0.09	$\bar{X} = 0.983C + 0.02$	0.96	0.32	0.42	$\bar{X} = 0.989C + 0.10$	0.64	0.22	0.17	$\bar{X} = 0.954C - 0.16$		
	1.20	1.09	0.12		$S_R = 0.026\bar{X} + 0.11$	1.13	0.38		$S_R = 0.047\bar{X} + 0.29$	0.90	0.21		$S_R = 0.103\bar{X} + 0.14$		
	20.00	20.43	0.89	0.72	$S_T = 0.027\bar{X} + 0.06$	21.06	1.32	0.96	$S_T = 0.021\bar{X} + 0.40$	19.61	2.60	2.62	$S_T = 0.025\bar{X} + 0.09^e$		
	28.00	27.53	0.41			27.60	1.47			25.65	4.10				
	80.00	79.00	3.16	2.38		79.57	4.18	2.01		77.38	6.13	2.90			
	100.00	97.60	2.51			97.97	4.10			95.86	6.74				

TABLE 12: SUMMARY STATISTICS AND DESCRIPTIVE EQUATIONS FOR THE 20 ANALYTES TESTED IN THE COLLABORATIVE STUDY

Analyte	Reagent Water				Finished Drinking Water				Ground Water				
	C ^a	\bar{X}^b	S _R	S _T	Regr. Equations	\bar{X}	S _R	S _T	Regr. Equations	\bar{X}	S _R	S _T	Regr. Equations
Molybdenum	2.80	2.63	0.32	0.16	$\bar{X} = 1.012C - 0.20$	2.80	0.20	0.32	$\bar{X} = 1.013C - 0.07$	3.00	0.47	0.42	$\bar{X} = 1.032C - 0.09$
	4.00	3.85	0.31		$S_R = 0.032X + 0.22$	3.95	0.47		$S_R = 0.037X + 0.17$	3.60	0.90		$S_R = 0.55X + 0.43$
	20.00	19.75	0.64	0.64	$S_T = 0.021X + 0.09$	19.78	0.60	1.16	$S_T = 0.035X + 0.20$	20.69	1.37	1.11	$S_T = 0.042X + 0.27$
	28.00	27.87	1.07			27.87	1.51			28.80	2.01		
	80.00	83.07	3.07	1.78		85.65	3.50	3.07		84.26	4.13	4.81	
100.00	100.08	4.32			99.06	2.89			103.57	6.10			
Nickel	4.00	4.02	0.41	0.50	$\bar{X} = 1.000C + 0.12$	3.66	0.53	1.03	$\bar{X} = 0.953C - 0.19$	4.81	2.06	2.82	$\bar{X} = 1.022C + 0.66$
	6.00	6.36	0.91		$S_R = 0.051X + 0.31$	5.44	1.32		$S_R = 0.046X + 0.56$	6.67	3.66		$S_R = 0.091X + 2.03$
	20.00	19.93	1.30	0.63	$S_T = 0.017X + 0.40$	18.42	0.87	1.11	$S_T = 0.023X + 0.91$	20.58	3.71	2.37	$S_T = 0.008X + 2.75^c$
	28.00	28.02	1.25			27.09	1.68			30.73	3.75		
	80.00	79.29	2.95	2.55		75.84	4.40	3.94		82.71	9.49	5.42	
100.00	100.87	7.20			95.83	4.41			101.00	9.89			
Selenium	32.00	33.54	4.63	1.57	$\bar{X} = 1.036C - 0.06$	32.57	4.37	3.65	$\bar{X} = 1.022C + 0.14$	32.46	4.95	3.24	$\bar{X} = 1.045C - 0.83$
	40.00	41.03	6.04		$S_R = 0.051X + 3.24$	42.18	3.71		$S_R = 0.056X + 2.10$	41.46	3.30		$S_R = 0.037X + 2.97$
	80.00	81.40	5.86	5.44	$S_T = 0.061X - 0.64$	79.97	6.66	5.28	$S_T = 0.040X + 2.15$	81.63	6.94	5.65	$S_T = 0.058X + 1.02$
	96.10	98.34	8.57			94.94	7.90			98.92	4.39		
	160.00	163.58	15.69	9.86		163.48	9.17	10.06		167.54	8.69	12.98	
200.00	214.30	10.57			212.19	16.49			209.21	14.65			
Silver	0.80	0.93	0.09	0.14	$\bar{X} = 0.917C + 0.26$	0.70	0.34	0.34	$\bar{X} = 0.888C + 0.09$	0.70	0.26	0.10	$\bar{X} = 0.858C - 0.00$
	1.20	1.51	0.23		$S_R = 0.196X - 0.09$	1.37	0.33		$S_R = 0.186X + 0.17$	0.98	0.28		$S_R = 0.169X + 0.14$
	48.00	49.39	3.25	1.81	$S_T = 0.053X + 0.08$	45.43	6.78	5.15	$S_T = 0.164X + 0.18$	45.59	4.27	2.70	$S_T = 0.120X - 0.01$
	64.00	63.54	2.75			60.35	2.22			59.71	6.58		
	160.00	136.42	48.31	12.19		119.06	55.28	36.34		121.43	42.55	28.19	
200.00	153.74	57.34			172.15	31.92			160.69	27.15			
Thallium	2.80	2.89	0.23	0.22	$\bar{X} = 0.984X + 0.08$	2.88	0.40	0.16	$\bar{X} = 1.010C + 0.01$	2.88	0.14	0.12	$\bar{X} = 1.023C - 0.06$
	4.00	3.92	0.15		$S_R = 0.035X + 0.09$	3.96	0.21		$S_R = 0.040X + 0.21$	3.88	0.37		$S_R = 0.056X + 0.04$
	20.00	19.27	0.99	0.67	$S_T = 0.027X + 0.13$	19.77	1.13	0.83	$S_T = 0.039X + 0.02$	20.22	1.05	0.65	$S_T = 0.049X - 0.06$
	28.00	28.08	0.83			27.61	1.24			28.65	1.50		
	80.00	81.29	3.65	2.86		85.32	4.08	4.05		83.97	6.10	6.05	
100.00	96.69	2.86			100.07	4.33			101.09	4.15			
Thorium	0.80	0.93	0.16	0.09	$\bar{X} = 1.013C + 0.08$	0.78	0.13	0.07	$\bar{X} = 1.019C - 0.06$	0.87	0.17	0.07	$\bar{X} = 1.069C - 0.03$
	1.20	1.22	0.19		$S_R = 0.036X + 0.13$	1.09	0.19		$S_R = 0.035X + 0.12$	1.15	0.17		$S_R = 0.041X + 0.13$
	20.00	20.88	0.90	0.71	$S_T = 0.025X + 0.07$	21.66	0.94	0.54	$S_T = 0.024X + 0.05$	21.78	0.90	0.94	$S_T = 0.027X + 0.04$
	28.00	27.97	1.11			28.09	0.83			29.86	1.65		
	80.10	81.14	2.99	2.14		79.99	2.03	2.60		86.00	3.43	1.95	
100.00	102.64	3.39			100.50	4.56			107.35	4.72			

TABLE 12: SUMMARY STATISTICS AND DESCRIPTIVE EQUATIONS FOR THE 20 ANALYTES TESTED IN THE COLLABORATIVE STUDY

Analyte	Reagent Water				Finished Drinking Water				Ground Water				
	C ^a	\bar{X}^b	S _R	S _T	Regr. Equations	\bar{X}	S _R	S _T	Regr. Equations	\bar{X}	S _R	S _T	Regr. Equations
Uranium	0.80	0.86	0.05	0.08	$\bar{X} = 1.026C - 0.02$	0.85	0.15	0.09	$\bar{X} = 1.026C - 0.04$	0.84	0.23	0.19	$\bar{X} = 1.058C - 0.06$
	1.20	1.10	0.11		$S_R = 0.048\bar{X} + 0.02$	1.05	0.13		$S_R = 0.044\bar{X} + 0.11$	1.10	0.14		$S_R = 0.039\bar{X} + 0.17$
	20.10	21.38	0.99	0.82	$S_T = 0.027\bar{X} + 0.05$	22.30	1.40	0.46	$S_T = 0.022\bar{X} + 0.07$	21.56	1.11	1.08	$S_T = 0.028\bar{X} + 0.16$
	28.10	28.36	1.10			28.89	1.47			29.86	1.83		
	80.30	82.47	4.03	2.16		80.31	2.00	2.71		85.01	3.76	2.00	
	100.00	103.49	5.24			100.70	5.30			106.47	3.74		
Vanadium	32.00	31.02	2.68	2.19	$\bar{X} = 1.025C - 2.21$	33.15	2.51	2.28	$\bar{X} = 1.022C - 0.30$	33.25	3.83	1.87	$\bar{X} = 1.076C - 1.87$
	40.00	38.54	2.94		$S_R = 3.79^d$	40.20	1.88		$S_R = 0.023\bar{X} + 1.45$	40.34	3.08		$S_R = 0.033\bar{X} + 2.25$
	80.00	79.14	4.94	4.29	$S_T = 3.26^d$	77.83	4.18	2.75	$S_T = 0.023\bar{X} + 1.38$	84.42	3.97	2.93	$S_T = 0.049\bar{X} - 0.09$
	96.00	93.47	3.85			96.32	1.34			98.70	5.03		
	160.00	162.43	5.67	3.30		161.89	7.63	6.56		170.94	9.09	11.55	
	200.00	208.20	2.65			214.91	5.89			217.90	11.36		
Zinc	8.00	8.33	2.56	1.78	$\bar{X} = 1.042C + 0.87$	11.60	6.18	5.72	$\bar{X} = 0.943C + 2.54$	7.29	1.12	2.20	$\bar{X} = 0.962C + 0.07$
	12.00	15.49	4.18		$S_R = 0.041\bar{X} + 2.60$	10.21	4.96		$S_R = 0.048\bar{X} + 5.27$	12.66	3.24		$S_R = 0.093\bar{X} + 0.92$
	56.00	56.07	2.91	2.47	$S_T = 0.030\bar{X} + 1.42$	56.83	7.66	4.56	$S_T = 0.004\bar{X} + 5.66^e$	54.86	5.12	7.24	$S_T = 0.069\bar{X} + 1.55$
	80.00	85.53	5.81			82.88	8.34			78.62	8.56		
	160.00	165.17	7.78	9.87		156.69	17.01	9.48		150.12	12.52	10.84	
	200.00	207.27	14.61			191.59	17.21			184.37	16.59		

^a True Value for the concentration added (µg/L)

^b Mean Recovery (µg/L)

^c COD_r < 0.5 - Use of regression equation outside study concentration range not recommended.

^d COD_r < 0 - Mean precision is reported.

^e COD_r < 0 - Unweighted linear regression equation presented.

TABLE 13: BACKGROUND AND SPIKE MEASUREMENTS IN WASTEWATER DIGESTATE^a

	Background		Concentrate 1					Concentrate 2					
	Conc. µg/L	Std Dev µg/L	Spike µg/L	Found µg/L	Std Dev µg/L	% Rec %	RSD %	Spike µg/L	Found µg/L	Std Dev µg/L	% Rec %	RSD %	RSD_r %
Be	0.0	0.0	100	94.5	11.8	94.5	12.5	125	118.1	14.7	94.5	12.4	3.5
Al	78.2	12.4	200	260.9	41.2	91.4	15.8	250	309.1	48.5	92.4	15.7	2.7
Cr	19.5	8.1	200	222.2	23.3	101.4	10.5	250	274.3	26.6	101.9	9.7	2.0
V	1.9	2.8	250	271.8	36.5	108.0	13.4	200	219.3	30.1	108.7	13.7	2.6
Mn	296.6	24.7	125	419.0	35.7	97.9	8.5	100	397.4	34.8	100.8	8.8	1.0
Co	2.5	0.4	125	124.7	12.3	97.8	9.9	101	100.7	9.4	97.2	9.3	2.8
Ni	47.3	5.0	125	161.7	4.9	91.5	3.0	100	142.7	5.6	95.4	3.9	2.1
cu	77.4	13.2	125	194.5	29.5	93.7	15.2	100	172.3	26.6	94.9	15.4	2.2
Zn	77.4	4.9	200	257.4	16.3	90.0	6.3	250	302.5	21.1	90.0	7.0	1.8
As	0.8	1.1	200	194.9	8.0	97.1	4.1	250	244.7	12.8	97.6	5.2	3.4
Se	4.5	6.2	250	236.8	14.2	92.9	6.0	200	194.3	9.3	94.9	4.8	3.8
Mo	166.1	9.4	100	269.8	19.0	103.7	7.0	125	302.0	18.0	108.7	6.0	1.5
Ag	0.6	0.7	200	176.0	14.6	87.7	8.3	250	214.6	17.8	85.6	8.3	2.3
Cd	2.7	1.1	125	117.0	4.8	91.4	4.1	100	96.6	3.2	93.9	3.3	2.9
Sb	3.3	0.2	100	100.2	4.8	96.9	4.8	125	125.9	4.3	98.1	3.4	1.8
Ba	68.6	3.3	250	321.0	19.4	101.0	6.0	200	279.3	17.2	105.4	6.2	2.5
Tl	0.1	0.1	100	103.3	8.0	103.2	7.7	125	129.2	8.9	103.3	6.9	2.1
Pb	6.9	0.5	125	135.1	7.8	102.6	5.8	100	110.3	6.3	103.4	5.7	1.8
Th	0.1	0.1	125	140.2	19.5	112.1	13.9	100	113.3	15.4	113.2	13.6	2.7
U	0.4	0.2	125	141.2	19.3	112.6	13.7	100	113.6	16.0	113.2	14.1	2.5

^aResults from 10 participating laboratories. Wastewater digestate supplied with the study materials. Mean background concentrations determined by the participants.

TABLE 14: SPIKE MEASUREMENTS IN PARTICIPANTS WASTEWATER^a

	Concentrate 1					Concentrate 2					
	Spike µg/L	Found µg/L	Std Dev µg/L	% Rec %	RSD %	Spike µg/L	Found µg/L	Std Dev µg/L	% Rec %	RSD %	RSD _r %
Be	101	103.4	12.0	103.4	11.6	125	128.2	13.6	102.6	10.6	2.4
Al	200	198.7	23.9	99.4	12.0	250	252.4	15.5	101.0	6.1	2.9
Cr	200	205.4	12.3	102.7	6.0	250	253.4	15.4	101.4	6.1	1.1
V	250	246.5	4.4	98.6	1.8	200	196.8	2.8	98.4	1.4	2.0
Mn	125	119.0	5.4	95.2	4.5	100	95.5	4.3	95.5	4.5	0.8
Co	125	125.8	7.0	100.6	5.6	101	99.5	5.3	98.5	5.3	1.8
Ni	125	127.4	9.7	101.9	7.6	100	101.0	7.5	101.0	7.4	1.7
cu	125	126.8	5.3	101.4	4.2	100	105.3	3.6	105.3	3.4	2.8
Zn	200	201.4	36.7	100.7	18.2	250	246.4	29.7	98.6	12.1	2.6
As	200	207.3	11.9	103.7	5.7	250	263.0	2.6	105.2	1.0	3.2
Se	250	256.8	26.4	102.7	10.3	200	214.0	18.7	107.3	8.7	3.6
Mo	100	98.6	4.6	98.6	4.7	125	123.2	6.7	98.6	5.4	2.2
Ag	200	200.7	48.9	100.4	24.4	250	231.2	63.5	92.5	27.5	8.2
Cd	125	123.2	11.5	98.6	9.3	100	95.8	2.9	95.8	3.0	5.8
Sb	100	92.2	4.4	92.2	4.8	125	119.0	1.0	95.2	0.8	2.8
Ba	250	245.2	12.8	98.1	5.2	200	204.7	12.1	102.4	5.9	2.1
Tl	100	100.0	0.9	100.0	0.9	125	128.0	6.0	102.4	4.7	3.5
Pb	125	125.8	5.1	100.6	4.1	100	100.8	2.7	100.8	2.7	2.2
Th	125	124.2	7.6	99.4	6.1	100	99.8	5.7	99.8	5.7	3.2
U	125	130.4	10.3	104.3	7.9	100	106.4	6.8	106.4	6.4	2.3

^aResults from five participating laboratories. Mean concentrations before spiking are not listed because they varied considerably among the different wastewaters.

Annex XI:

**Recommended Method for the
DETERMINATION OF TOTAL MERCURY IN
MARINE SAMPLES BY THERMAL
DECOMPOSITION AMALGAMATION AND
ATOMIC ABSORPTION SPECTROPHOTOMETRY**



REPORT

Recommended Method for the DETERMINATION OF TOTAL MERCURY IN MARINE SAMPLES BY THERMAL DECOMPOSITION AMALGAMATION AND ATOMIC ABSORPTION SPECTROPHOTOMETRY

IAEA/NAEL

Marine Environmental Studies Laboratory in co-operation with

UNEP/MAP MED POL

December 2012

For further information on this method, please contact:

IAEA-Environment Laboratories
Marine Environmental Studies Laboratory
4a Quai Antoine 1er
MC-98000 Principality of Monaco

Tel. (377) 979 772 72; Fax. (377) 979 772 73

E-mail: NAEL-MESL.Contact-Point@iaea.org

Recommended Method for the
DETERMINATION OF TOTAL MERCURY IN MARINE SAMPLES BY
THERMAL DECOMPOSITION AMALGAMATION
AND ATOMIC ABSORPTION SPECTROPHOTOMETRY

DISCLAIMER

This is not an official IAEA publication. The views expressed do not necessarily reflect those of the International Atomic Energy Agency or its Member States.

The material has not undergone an official review by the IAEA. This document should not be quoted or listed as a reference.

The use of particular designations of countries or territories does not imply any judgment by the IAEA, as to the legal status of such countries or territories, of their authorities and institutions or of the delimitation of their boundaries.

The mention of names of specific companies or products (whether or not indicated as registered) does not imply any intention to infringe proprietary rights, nor should it be construed as an endorsement or recommendation on the part of the IAEA.

Limited Distribution

Reproduced by the IAEA

TABLE OF CONTENTS

1. SCOPE	1
2. PRINCIPLE.....	1
3. SAMPLE PRE-TREATMENT	1
4. REAGENTS	2
5. MATERIAL	2
6. CALIBRATION	3
7. PROCEDURE	4
8. QUALITY CONTROL.....	6
9. CALCULATION OF RESULTS	7
10. EXPRESSION OF RESULTS	8
11. REFERENCES	8

NOTE: This method is not intended to be an analytical training manual. Therefore, this method is written with the assumption that it will be performed by formally trained analytical chemist.

In addition, the IAEA recommended methods are intended to be guidance methods that can be used by laboratories as a starting point for generating their own standard operating procedure. If performance data are included in the method, they shall not be used as absolute QC acceptance criteria.

1. SCOPE

The method hereinafter describes the protocol for the determination of total mercury (inorganic and organic) in sediment and biological material.

By using this method, the total mercury in solid samples can be determined without sample chemical pre-treatment.

The recommended protocol is mainly based on the EPA 7473 method; users are encouraged to consult this document (EPA, 2007).

2. PRINCIPLE

The sample is dried and then chemically decomposed under oxygen in the decomposition furnace. The decomposition products are carried out to the catalytic section of the furnace, where oxidation is completed (halogens and nitrogen/sulfur oxides are trapped). The mercury present in the remaining decomposition products is selectively trapped on an amalgamator. After flushing the system with oxygen, the mercury vapour is released by rapid heating of the amalgamator, and carried through the absorbance cell in the light path of a single wavelength atomic absorption spectrophotometer. The absorbance is measured at 253.7 nm as a function of mercury quantity (ng).

The typical working range is 0.1–500 ng. The mercury vapour is carried through a long (first) and a short path length absorbance cell. The same quantity of mercury is measured twice with different sensitivity resulting in a dynamic range that spans four orders of magnitude.

The typical detection limit is 0.01 ng of mercury.

3. SAMPLE PRE-TREATMENT

The sediment samples are prepared following the recommendations of UNEP (2005);

The marine organisms are prepared following the recommendations of UNEP (1984, 1994).

4. REAGENTS

The reagents used shall meet the purity requirement of the subsequent analysis

4.1. ULTRAPUR WATER (type MilliQ)

4.2. NITRIC ACID 65%

4.3. POTASSIUM DICHROMATE OXIDIZING SOLUTION (10% w/v)

Weight 25 g of $K_2Cr_2O_7$ in 250 ml glass bottle, fill it up to 250 ml with water, and shake until total dissolution of solids. Keep the bottle tightly closed in a double plastic bag, and in an Hg free environment (i.e. laminar flow hood). This solution is stable indefinitely and rarely becomes contaminated.

4.4. COMMERCIAL STANDARD SOLUTION 1000 $\mu\text{g ml}^{-1}$ MERCURY

Use a certified reference material solution; this solution should be accompanied by a certificate stipulating at minimum the traceability of the certified concentration, as well as the expiry date. The density of the solution, or the certified content in mg kg^{-1} should also be defined, to allow for the preparation of the calibration solution by weighing. Stock solutions should be kept at 5°C.

5. MATERIAL

5.1. SOLID MERCURY ANALYZER

Optionally equipped with an auto-sampler.

5.2. ANALYTICAL BALANCE

With a 0.001 g precision at least.

5.3. VOLUMETRIC CONTAINERS

Preferably in Teflon or glass.

5.4. PIPETTES

Some microliter pipettes sized ranging from 50 to 10000 μl are needed. The accuracy and precision of the pipettes used should be checked as a routine every 6 months, and the results obtained should be compared with the individual certificates.

5.5. METAL SPATULA (inox).

5.6. SAMPLE BOAT

Metal or metal alloy. Before measurement, sample boats are cleaned by heating over a flame until constant "red" to remove mercury.

5.7. OXYGEN

It should be of high purity and free of mercury. If there is a possible mercury contamination from oxygen, install a gold mesh filter between the cylinder and the instrument to prevent any mercury from entering the instrument.

6. CALIBRATION

- 6.1. PRIMARY CALIBRATION. This is the calibration of the instrument working range. This calibration is performed initially (usually done by the manufacturer and stored in the instrument), and/or when any significant instrumental parameters are changed (i.e. after maintenance).
- 6.2. PREPARE STANDARD SOLUTIONS of appropriate concentration by dilution of a commercial standard (see 4.4). It is recommended to prepare standard solution in Teflon or glass container, in 1 or 0.5% HNO₃ (see 4.2) and 0.1% (v/v) potassium dichromate (see 4.3). Fresh mercury standard should be prepared daily. Prepare a zero calibration solution using the same quantity of acid and potassium dichromate.
- 6.3. START THE INSTRUMENT according to the manufacturer recommendations.
- 6.4. CLEAN THE SYSTEM. Inject 100 µl of water and start the measurement with the recommended parameters (see 7.1). Repeat the cleaning until the absorbance is below 0.001ABS.
- 6.5. SET THE INSTRUMENT PARAMETERS (see 7.1) for selected volume (usually 100 µl) and inject the zero calibration, at least three measurements should be done. The zero solution serves to correct the amount of mercury in water and reagent used for preparing the calibration curve, hence the important of keeping the injected volume equal at all points of the calibration curve. If the amount of mercury in the zero calibration is high (i.e. more than 0.01 ng), it is recommended to check for contamination sources and to prepare new standard solution with clean acid.
- 6.6. STANDARDS ARE MEASURED from the lowest to the highest at least twice. The maximum relative standard deviation between readings should be 3% (except for zero calibration); if higher it is recommended to carry out more measurements.
- 6.7. EXAMPLE OF AMOUNTS used for recalibration (primary):

First Range:

Standard (ng ml ⁻¹)	1	3	10	30	100	300
Volume injected (µl)	100	100	100	100	100	100
Quantity of Hg (ng)	0.1	0.3	1	3	10	30

Second Range:

Standard ($\mu\text{g ml}^{-1}$)	1	2	3	4	5	6
Volume injected (μl)	100	100	100	100	100	100
Quantity of Hg (ng)	100	200	300	400	500	600

Note: The calibration of the second range might induce problems for subsequent analysis, due to the relatively high quantity of mercury introduced (especially with memory effect). It should be performed only if there is a probability of using it (i.e. measuring samples with high mercury level $> 1\mu\text{g g}^{-1}$). After the reading of the last calibration point, clean the system (see 6.4).

- 6.8. ALTERNATIVE CALIBRATION CURVE can be performed using a solid certified reference material. In this case, weigh accurately a CRM onto a tare sample boat, set up the instrument according to the sample type (see 7.1) and measure the absorbance. The matrix of the CRM should be as similar as possible to the sample of interest. Repeat this procedure with different weights of the CRM and/or with different CRM, to get results in the desired working range.
- 6.9. CONSTRUCT A CALIBRATION CURVE by plotting the absorbance against Nano grams of mercury (this could be done automatically by the software). The type of equation will depend on the levels, as the response is not linear over the entire working range.
- 6.10. DAILY CALIBRATION: calibration performed every day with a minimum number of standards to ensure that the primary calibration is valid. It can be performed by using either liquid standard (see 6.2) or solid certified reference material (CRM) see 6.8. It should be performed in the range of interest, with at least two standards (or matrix CRM) and the results should agree within the acceptance criteria. The acceptance criteria should be set through the use of historical data, but the maximum deviation should not exceed 10%.

7. PROCEDURE

7.1. GENERAL ANALYTICAL PARAMETERS

The analytical parameters will depend on the sample size and matrix, and are instrument specific. It is important to follow the guidelines from the instrument manufacturer. There are three time to set: drying, decomposition and waiting.

Some typical recommended conditions below:

Drying time:

Sample type	Dry (s)	Comments
Liquid	0.7 x injected Volume (μ l)	
Dry inorganic	10	
Organic liquid	50–300	To be optimized ¹
Dry organic (i.e. fat)	50–200	To be optimized ¹
Wet (i.e. fresh)	0.7 x weight x % moisture	Example: 100 mg with 45% moisture $0.7 \times 100 \times 0.45 = 31.5\text{s}$ (35)

¹ In the case of organic, there is a risk of explosion especially with organic liquid; to optimize set the instrument at: 300s dry/ 150s decomposition/ 45s wait, do the measurement and check for possible small explosion, note the time of the phenomenon and add to the drying time 10s more.

Decomposition time:

Sample type	Decomposition (s)	Comments
Liquid	150–400	To be optimized ¹
Solid inorganic	120 + 0.4 x sample (mg)	To be optimized ¹
Solid organic	120	

¹ Set the instrument to XX (see above) dry/ 400s decomposition/ 45s wait, run a sample and observe the results. Decrease the decomposition time by 30s and repeat measurement. Continue until you observe a significant decrease, note that time and add to the decomposition time 30s more.

Waiting time:

It is recommended to use 40–45s, except for long decomposition time (over 200s) when it is beneficial to add 10s of waiting for every 100s of decomposition.

Note: These indications above are recommended by ALTECH (AMA 254).

7.2. ANALYSIS OF A SOLID SAMPLE

Weight a sample accurately onto a tare boat, insert the boat into the instrument, set the appropriate parameters (see 7.1) and start the measurements. The results can be records on absorbance, quantity or concentration depending on the instrument software. See 9: Calculation of results.

7.3. ANALYSIS OF BLANK FOR SOLID MEASUREMENT

Analyse an empty sample boat using the same instrument settings than for the sample.

7.4. ANALYSIS OF A LIQUID SAMPLE

Dose a known volume of the sample onto a sample boat, set the appropriate parameters (see 7.1) and start the measurements. The results can be records on absorbance, quantity or concentration depending on the instrument software. See the calculation section (see 9).

7.5. ANALYSIS OF BLANK FOR LIQUID

Repeat 7.4 with the same volume of blank solution (solution that contain the same reagent and chemical than the sample).

8. QUALITY CONTROL

8.1. For every day of analysis, the CALIBRATION SHOULD BE VALIDATED by doing a daily calibration (see 6.10) before starting the measurements. The results of the daily calibration should be recorded for quality control purposes.

8.2. CERTIFIED REFERENCE MATERIAL

At least one certified reference material of a representative matrix should be measured with each batch of the sample, the calculated results should fall in the value of the certificate and within the coverage uncertainty (Linsinger, 2010), to show evidence of unbiased results. The results for the CRM should be recorded for quality control purpose and plotted in a control chart (UNEP/IOC/IAEA 1994).

8.3. A DUPLICATE OR TRIPLICATE SAMPLE should be processed on a routine basis.

A duplicate sample should be processed with each analytical batch or for every 10 samples.

8.4. A SPIKED SAMPLE should also be included, whenever a new sample matrix is being analysed, especially if no certified reference material is available for that matrix. Measure a spiked sample by adding a known volume of standard solution (prepared as in paragraph 6.2) to the sample in the boat. Keep the spike volume small enough not to overspill. The recovery of spike calculated with the equation 2 should be 85–115% (this limits should be reset after collection of historical data). If the test fails, it is recommended to check the calibration (see 6.10) and/or to revise the instrument parameters (see 7.1).

$$\text{Spike (ng)} = \text{Concentration of standard (ng/ml)} \times \text{Volume of spike (ml)} \quad \text{Equation 1}$$

$$\text{Recovery (\%)} = \frac{\text{Spiked sample (ng)} - \text{Unspiked sample (ng)}}{\text{Spike (ng)}} \times 100 \quad \text{Equation 2}$$

To be valid the quantity of Spike (equation 1) should be in the range of 50–150% the quantity of unspiked sample.

9. CALCULATION OF RESULTS

9.1. SOLID SAMPLE RESULTS are calculated using equation 3

$$w(Hg) = \frac{(\rho_1 - \rho_0)}{m} \times R \quad \text{Equation 3}$$

Where:

w(Hg) is the mass fraction of element m in the sample, expressed in mg kg⁻¹;

ρ₁ is the quantity of mercury, expressed in ng as measured in the sample;

ρ₀ is the quantity of mercury expressed in ng as measured in the blank (see 7.3);

R is the recovery calculated using the CRM (see 8.2) or spike (see 8.4);

m is the amount of sample in mg.

Note: ρ₁ and ρ₀ are calculated using calibration curve equation (usually done by software).

9.2. LIQUID SAMPLE RESULTS are calculated using equation 4

$$w(Hg) = \frac{(\rho_1 - \rho_0) \times V}{V_i \times m} \times f \times R \quad \text{Equation 4}$$

Where:

w(Hg) is the mass fraction of mercury in the sample, expressed in mg kg⁻¹;

ρ₁ is the quantity of mercury, expressed in ng as measured in the sample solution;

ρ₀ is the quantity of mercury expressed in ng as measured in the blank solution (see 7.4);

R is the recovery calculated using the CRM (see 8.2) or spike (see 8.4);

V_i is the injected volume (should be the same in sample and blank solution) in ml;

m is the amount of sample in mg;

V is the volume of solution in ml;

f is the dilution factor.

Note: ρ₁ and ρ₀ are calculated using calibration curve equation (usually done by software).

10. EXPRESSION OF RESULTS

The rounding of values will depend on the uncertainty reported with the results; in general for this method two or three significant figures should be reported.

The uncertainty component should be reported with all results. (ISO 2005, Nordtest 2004)

Example: $w(\text{Hg}) = 0.512 \pm 0.065 \text{ mg kg}^{-1}$.

11. REFERENCES

- EPA (2007). U.S. Environmental Protection Agency, EPA method 7473, Mercury in solids and solutions by thermal decomposition, amalgamation and atomic absorption spectrophotometry Rev 0, February 2007:

<http://www.epa.gov/osw/hazard/testmethods/sw846/pdfs/7473.pdf>

- ISO (1995). Guide to the expression of uncertainty of measurements International Organisation for Standardization: Geneva

- Linsinger, T. (2010). European Commission - Joint Research Centre, Institute for Reference Materials and Measurements http://www.erm-crm.org/ERM_products/application_notes/application_note_1/Documents/erm_application_note_1_english_rev3.pdf

- Nordtest (2004). Handbook For Calculation Of Measurement Uncertainty In Environmental Laboratories Edition 2 <http://www.nordicinnovation.net/nordtestfiler/tec537.pdf>

- UNEP (2005). UNEP (DEC)/MED WG.282/inf.5/Rev1, Method for sediment sampling and analysis, February 2005, UNEP.

- UNEP/IOC/IAEA (1984). Reference method 7 rev2: Sampling of selected marine organisms and sample preparation for trace metal.

- UNEP/IOC/IAEA (1994). Reference method 57: Quality assurance and good laboratory practice, UNEP, 1994.

Annex XII:

**RECOMMENDED METHOD FOR THE DETERMINATION OF TOTAL MERCURY IN
SAMPLES OF MARINE ORIGIN BY COLD VAPOUR ATOMIC ABSORPTION
SPECTROMETRY**



REPORT

RECOMMENDED METHOD FOR THE DETERMINATION OF TOTAL MERCURY IN SAMPLES OF MARINE ORIGIN BY COLD VAPOUR ATOMIC ABSORPTION SPECTROMETRY

**IAEA/NAEL Marine Environmental Studies Laboratory in co-operation with
UNEP/MAP MED POL**

December 2012

For further information on this method, please contact:

IAEA-Environment Laboratories
Marine Environmental Studies Laboratory
4a Quai Antoine 1er
MC-98000 Principality of Monaco

Tel. (377) 979 772 72; Fax. (377) 979 772 76

E-mail: NAEL-MESL.Contact-Point@iaea.org

RECOMMENDED METHOD ON THE DETERMINATION OF TOTAL MERCURY
IN SAMPLES OF MARINE ORIGIN BY COLD VAPOUR ATOMIC ABSORPTION
SPECTROMETRY

DISCLAIMER

This is not an official IAEA publication. The views expressed do not necessarily reflect those of the International Atomic Energy Agency or its Member States.

The material has not undergone an official review by the IAEA. This document should not be quoted or listed as a reference.

The use of particular designations of countries or territories does not imply any judgment by the IAEA, as to the legal status of such countries or territories, of their authorities and institutions or of the delimitation of their boundaries.

The mention of names of specific companies or products (whether or not indicated as registered) does not imply any intention to infringe proprietary rights, nor should it be construed as an endorsement or recommendation on the part of the IAEA.

Limited Distribution

Reproduced by the IAEA

TABLE OF CONTENT

1. SCOPE.....	1
2. PRINCIPLE	1
3. REAGENT	2
4. MATERIAL	3
5. INTERFERENCES	4
6. SAMPLE PREPARATION.....	5
7. PROCEDURE	6
8. CALCULATION OF RESULTS	10
9. EXPRESSION OF RESULTS	10
10. REFERENCES	10

NOTE: This method is not intended to be an analytical training manual. Therefore, the method is written with the assumption that it will be used by formally trained analytical chemists.

In addition, the IAEA recommended methods are intended to be guidance methods that can be used by laboratories as a starting point for generating their own standard operating procedure. If performance data are included in the method they must not be used as absolute QC acceptance criteria.

1. SCOPE

This method describes a protocol for measurement of total mercury by cold vapour atomic absorption spectrometry (CV-AAS). The method is simple, rapid and applicable to a large number of environmental samples. This method is applicable when the element content in the digested solution is above the method limit (~ 0.15 ng ml⁻¹ depending on instrument). The typical working range is 0.25–100 ng ml⁻¹ for direct injection of cold vapour, using “batch system”; FIAS or amalgamation accessory will give better sensitivity.

2. PRINCIPLE

The sediment or biological samples are mineralized with strong acids. The inorganic mercury is reduced to its elemental form with stannous chloride. The cold mercury vapour is then passed through the quartz absorption cell of an atomic absorption spectrometer (AAS), where its concentration is measured. The light beam of Hg hollow cathode lamp is directed through the quartz cell, into a monochromator and onto a detector that measures the amount of light absorbed by the atomized vapour in the cell. The amount of energy absorbed at the characteristic wavelength is proportional to the concentration of the element in the sample.

3. REAGENT

The reagents used shall meet the purity requirement of the subsequent analysis:

3.1. WATER

Reagent water (referenced also as water in the text) should be free of contamination.

3.2. NITRIC ACID 65%

3.3. HYDROCHLORIC ACID (37%)

3.4. HYDROGEN PEROXIDE

3.5. VANADIUM PENTOXIDE (V_2O_5)

3.6. SILICON ANTI-FOAMING

3.7. HYDROXYLAMINE HYDROCHLORIDE ($NH_2OH.HCl$)

Dissolve 12.0 g of $NH_2OH.HCl$ in 100 ml reagent water. This solution may be purified by the addition of 0.1 ml of $SnCl_2$ solution and purging 1 hour with Hg-free argon.

3.8. POTASSIUM DICHROMATE OXIDIZING SOLUTION (10% w/v)

Weight 25 g of $K_2Cr_2O_7$ in a 250 ml glass bottle, fill it up to 250 ml with water, and shake until total dissolution of the solid. Keep the bottle tightly closed in a double plastic bag, and in an Hg free environment (i.e. laminar flow hood). This solution is stable indefinitely and rarely becomes contaminated.

3.9. $BrCl$ OXIDIZING SOLUTION

Weigh accurately 11 g of $KBrO_3$ and 15 g of KBr into a clean 1 liter glass bottle. Add 200 ml of Milli-Q water; add carefully 800 ml of concentrated HCl . The dilution has to be carried out in a well-ventilated fume hood to prevent exposure to toxic fumes released during dissolution of $KBrO_3$. Keep the bottle wrapped in aluminium foil, tightly closed in a double plastic bag, and in an Hg free environment (i.e. laminar flow hood). This solution is stable indefinitely but can become contaminated.

3.10. STANNOUS CHLORINE SOLUTION 20% (w/v) in 20% (w/v) HCl

Weigh 20 g of $SnCl_2$ in a 100 ml volumetric flask; add 20 ml of concentrated HCl ; dissolve the $SnCl_2$ (if needed heat at $60^\circ C$ for a few minutes on a hot plate); complete to 100 ml with water. This solution might be purified by bubbling with Hg-free argon for 15 minutes. The obtained solution should be clear and transparent, cloudy or yellow solution indicates a bad quality $SnCl_2$. This solution should be prepared fresh every day preferably, if not it should be kept in the fridge.

Note: The concentration of this solution is dependent on the type of accessory use for vapour generation, and can vary between 5 and 30%, the recommendation of the manufacturer

should be followed (i.e. the solution above is recommended for a VGA-70 from Varian). The validity of the solution (i.e. shelf-life) should be defined during method validation.

3.11. COMMERCIAL STANDARD SOLUTION 1000 $\mu\text{g ml}^{-1}$

Use a certified reference material solution; this solution should be accompanied by a certificate stipulating at minimum the traceability of the certified concentration, as well as the expiry date. The density of the solution, or the certified content in mg kg^{-1} should also be defined, to allow for the preparation of the calibration solution by weighing. Stock solutions should be kept at 5°C.

3.12. ARGON

Use of a gas purifier cartridge for removing mercury, oxygen and organic compounds is recommended.

4. MATERIAL

This section does not list the common laboratory glassware.

4.1. ATOMIC ABSORPTION SPECTROPHOTOMETER

Instrument equipped with an appropriate cold vapour generation system and a quartz or glass tube atomizer. Use a hollow cathode lamp or, preferably, an electrodeless discharge lamp (which gives a greater and more stable light intensity), operated at a current recommended for the lamp and by the instrument manufacturer. An AAS system with background correction device is recommended.

4.2. GLASSWARE

All the glassware, polypropylene, or fluorocarbon (PFA or TFM) containers, including the sample bottles, flasks and pipettes tips, should be washed in the following sequence:

- 24 hrs soaking in a laboratory soap (or 10% alcohol);
- followed by 24 hrs soaking in 10% nitric acid;
- followed by 10% soaking in water;
- final rinse in water; and
- drying under a laminar flow hood.

The cleaned items should be kept in a double sealed plastic bag. It is better to avoid storage of low level ($< 5 \text{ ng ml}^{-1}$) solution in plastic, and for this purpose glass or Teflon is recommended.

If it can be documented, through an active analytical quality control program, using spiked samples and method blanks, then certain steps in the cleaning procedure would not be needed for routine samples, those steps may be eliminated from the procedure (i.e. for the levels

measured by flame AAS, some sterile plastic containers are sufficiently free of contamination for certain analytes).

4.3. PIPETTES

Some microliter pipettes size ranging from 50 to 10000 µl are needed. The accuracy and precision of the pipettes used should be checked as a routine every 6 months, and the results obtained should be compared with the individual certificates.

4.4. VOLUMETRIC CONTAINERS of suitable precision and accuracy.

5. INTERFERENCES

- 5.1. IODIDE, GOLD AND SILVER are known interferences for mercury determination by cold vapour. In samples from marine origin (biota or sediment), the levels of those elements are low, and consequently, do not interfere in the measurement process.
- 5.2. WATER VAPOUR (moisture) should be avoided in the measurement cell, always follow the manufacturer's protocol (e.g. use of membrane drying tube, correct position of gas separator...) and check for absence of moisture in the measurement cell.
- 5.3. When using GOLD AMALGAMATION, and with certain batch systems, the excess of oxidant can cause interference or damage the gold amalgamator, it is then recommended to pre-reduce the samples with hydroxylamine ammonium (see 3.7). This is important when using large amount of digested solution in "batch system".
- 5.4. Some samples (i.e. plants or large amount of mussels) might produce FOAM during the reduction reaction. If the amount of foam is important, it can interfere with gas liquid separation, and/or leak in the measurement cell, this phenomenon can be overcome by using silicon anti-foaming inside the gas liquid separator and/or in the "batch" system. Another option is to use vanadium pentoxide during digestion (see 6.4).
- 5.5. REDUCTION of inorganic mercury will induce loss, so it is important to stabilise all the solutions by using a strong oxidant as dichromate or BrCl (see 3.8 or 3.9).

6. SAMPLE PREPARATION

- 6.1. The sample should be prepared according to the recommended method for digestion of marine samples for the determination of trace metal (IAEA, 2011), but before diluting to the final volume (or weight) with water, add an adequate volume of potassium dichromate or BrCl to get the final concentration of 2% or 1% respectively. All the samples from marine origin (sediment or biota) can be prepared using the acid mixture recommended for fish, as Hg is not attached to silicates. For microwave digestion of sample size above 0.8 g, it is strongly recommended to do cold digestion for at least 5 hours and to use a long ramping time (i.e. 25 minutes) to avoid strong reactions in the microwave vessels.
- 6.2. If other trace elements have to be determined in the digested solution prepared according to the recommended method for digestion of marine samples for the determination of trace metal (IAEA, 2011), following the dilution to the final volume or weight, transfer a quantitatively sufficient amount of digested solution (i.e. at least 10 ml) into a separate container (preferably glass or Teflon), and add an oxidising solution 1% (v/v) of BrCl (see 3.9) or 2% (v/v) of potassium dichromate (see 3.8). Record the amount of oxidising solution added in order to calculate the dilution factor (i.e. dilution factor = 1.01 for 0.1 ml of dichromate in 10 ml).
- 6.3. Alternatively, the samples can be digested using a mixture of 5 ml of HNO₃ and 2 ml of H₂O₂ at 90°C for 4 hours on a hot plate. It is recommended to leave the samples in acid at room temperature, for at least 1 hour before heating. The digestion can be performed either in a Teflon or glass closed containers. After cooling, add an adequate volume of potassium dichromate or BrCl to get the final concentration of 2% or 1% respectively, and dilute to the final volume with water (i.e. for 50 ml final volume, add 1 ml of potassium dichromate or 0.5 ml of BrCl solution). This procedure can be used with bigger sample size if needed (i.e. 2 g); in this case, the volume of nitric acid should be increased to obtain a liquid mixture.
- 6.4. In the case that the digested solution produces foam during the reduction process (see 5.4), 45 mg of vanadium pentoxide should be added in the digestion vessels before addition of the acid mixture, then follow either paragraph 6.1 or 6.3.

7. PROCEDURE

7.1. SAMPLE SOLUTION

Use the sample prepared with one option as described in section 6.

7.2. BLANK SOLUTION

Prepare at least two blank solutions with each batch of sample, using the same procedure than for the samples.

7.3. PREPARATION OF CALIBRATION SOLUTIONS

7.3.1. Before each batch of determination, prepare by the appropriate dilution of 1000 $\mu\text{g ml}^{-1}$ stock standard solution (see 3.11), at least 4 standard solutions and one calibration blank solution, covering the appropriate range of the linear part of the curve. The calibration standards and calibration blank should be prepared using the same type of acid and oxidising solution than in the test portion (the final concentration should be similar).

7.3.2. Calibration solutions should be prepared fresh each day.

7.3.3. If the necessary intermediate stock standard solutions can be prepared in 5% nitric acid and 1% BrCl or 2% $\text{K}_2\text{Cr}_2\text{O}_7$, these solutions should be prepared monthly.

7.3.4. All volumetric material (pipettes and containers) should be of appropriate precision and accuracy, if not available standard solution can be prepared by weighing.

7.4. INSTALLATION OF VAPOUR GENERATOR ACCESSORY

7.4.1. Install the accessory according to the manufacturer's instructions. Certain systems (i.e. VGA from Varian) are designed to be used for hydride generation as well, and require in the instructions to aspirate an extra HCl solution, in the case of stannous chlorine reduction this solution is to be replaced by water. It is recommended to separate the systems used for hydride and for SnCl_2 (i.e. use a spare gas liquid separator and Teflon tubing).

7.4.2. Switch on the argon. For on-line system: start the pump, check the aspiration, and verify the gas liquid separator. If needed replace the pump tubing, clean the gas liquid separator by sonication in diluted detergent.

7.4.3. Clean the system by aspirating reagent and 10% nitric acid as a sample for about 10 minutes. For batch system, perform two cycles with 10% nitric acid.

7.4.4. Set up the atomic absorption spectrometer according to the manufacturer's instructions, at the appropriate wavelength, using the appropriate conditions, and with the suitable background correction system in operation.

7.4.5. Optimise the position of the measurement cell to get the maximum signal.

7.4.6. Connect the vapour generation system to the measurement cell.

7.5. CALIBRATION

7.5.1. Adjust the response of the instrument to zero absorbance whilst aspirating water.

NOTE: if the instrument zero reading is more than 0.002 ABS, the system should be clean again and reagent should be checked.

7.5.2. Aspirate the set of calibration solutions in ascending order, and as a zero member, the blank calibration solution. After the last standard, aspirate 10% nitric acid for 1 minute to rinse the system.

NOTE: The calibration curve is automatically plotted by the instrument software. The obtained curve should be linear with $r > 0.995$.

To correct for the instrumental drift, the calibration should be performed every 20 samples or if the calibration verification has failed (see 7.8.1).

7.6. ASPIRATE SAMPLE BLANK (see 7.2) AND SAMPLE SOLUTIONS (see 7.1)

Record their concentrations as calculated by the software using the calibration curve. Rinse the system by aspirating 10% nitric acid for at least 30 s between samples.

7.7. IF THE CONCENTRATION OF THE TEST PORTION EXCEEDS THE CALIBRATION RANGE, dilute the test portion with the blank solution accordingly.

NOTE: After the measurement of high level (or over calibration) sample, measure a sample blank or water to check the absence of memory effect. If necessary, clean the system for 1 minute with 10% nitric acid.

7.8. QUALITY CONTROL SOLUTIONS

The quality control solutions as described below should be measured during the run.

7.8.1. Calibration Verification CV

After the initial calibration, the calibration curve must be verified by the use of initial calibration verification (CV) standard.

The CV standard is a standard solution made from an independent (second source) material, at/or near midrange. This solution as a calibration standard should be prepared using the same type of acid and oxidising solution than in the test portion (the final concentration should be similar).

The acceptance criteria for the CV standard must be $\pm 10\%$ of its true value.

If the calibration curve cannot be verified within the specified limits, the causes must be determined and the instrument recalibrated before the samples are analysed. The analysis data for the CV must be kept on file with the sample analysis.

The calibration curve must also be verified at the end of each analysis batch and/or after every 10 samples. If the calibration cannot be verified within the specified limits, the sample analysis must be discontinued, the causes must be determined and the instrument recalibrated. All samples following the last acceptable test must be reanalysed.

7.8.2. Blank solution (see 7.2)

The maximum allowed blank concentration should be well documented, and if the blank solution exceeds this value all samples prepared along the contaminated blank should be prepared again and reanalysed.

7.8.3. Post digestion spike

Each unknown type of sample should be spiked to check for potential matrix effect.

This spike is considered as a single point standard addition, and should be performed with a minimum dilution factor. The recovery of spike calculated with equation 1 should be 85-115%. If this test fails, it is recommended to run analysis with standard addition method.

Spike solution: mix a fix volume (V1) of the sample solution, and a known volume (V2) of a standard solution with known concentrations (Cstandard).

Unspike solution: mix the same fix volume (V1) of sample solution, and the same volume (V2) of reagent water.

Measure the concentration C (mg l⁻¹) in both solutions on the calibration curve (see 7.6), and calculate recovery as:

$$C_{spike} = \frac{C_{standard} \times V_2}{(V_1 + V_2)} \quad \text{Equation 1}$$

$$R = \frac{C_{Spike\ Solution} - C_{Unspike\ solution}}{C_{spike}} \times 100 \quad \text{Equation 2}$$

To be valid, the concentrations of spiked and unspiked solutions should be in the linearity range of the calibration curve, and the spiked concentration (equation 1) should be in the range of 50-150% of the concentration of the unspiked solution.

7.8.4. Dilution test

If the analyte concentration is sufficiently high (minimally, a factor of 10 above the lower limit of the quantitation following dilution), an analysis of a 1:5 dilution should agree within

$\pm 10\%$ of the original determination. If not, then a chemical or physical interference effect should be suspected, and method of standard addition is recommended.

7.8.5. Certified Reference Material

At least one certified reference material of a representative matrix should be prepared with each batch of sample, the calculated result should fall in the value of the certificate and within the coverage uncertainty (Linsinger, 2010), to show evidence of an unbiased result.

The results for the CRM should be recorded for quality control purpose and plotted on a control chart (UNEP/IOC/IAEA 1994).

An example of sequence order with recommended criteria and actions is given in table 1.

TABLE 1. EXAMPLE OF AN ANALYTICAL SEQUENCE:

Solutions Description	Performance	Action
Calibration blank	< maximum allowed calibration blank value	Stop until resolve
Standard solution 1–4	$r > 0.995$	recalibrate in the linearity range
CV	$\pm 10\%$ of the true value	Stop until resolve
Sample blank	< maximum allowed blank value	
CRM	Fall in the certificate value within coverage uncertainty, or fall within acceptable criteria of the QC chart	Stop until resolve, check Matrix spike and run again with standard addition method if necessary
Matrix Spike	recovery $100\% \pm 15\%$	switch to standard addition, keep records for future analysis of the same matrix
Dilution Test	sample 1 = 5x sample 1 diluted 5x within 10%	switch to standard addition, keep records for future analysis of the same matrix
Unknown Sample 1–10	should \geq standard 1 and \leq standard 4	report as <minimum quantification limit or dilute
CV	$\pm 10\%$ of the true value	Stop until resolve
Unknown Sample 11–20	should \geq standard 1 and \leq standard 4	report as <minimum quantification limit or dilute
Calibration blank	< maximum allowed calibration blank value	Stop until resolve
Standard solution 1–4	$r > 0.995$	recalibrate in the linearity range
CV	$\pm 10\%$ of the true value	Stop until resolve
Etc....		

8. CALCULATION OF RESULTS

Results are calculated using equation 3

$$w(m) = \frac{(\rho_1 - \rho_0)}{m} \times f \times V \times R \quad \text{Equation 3}$$

Where:

w(m) is the mass fraction of element m in the sample, expressed in mg kg⁻¹;

ρ1 is the concentration of element m, expressed in mg/l as measured in the sample solution;

ρ0 is the concentration of element m expressed in mg/l as measured in the blank solution;

F is the dilution factor calculated as follow:

$$f = \frac{\text{final volume}}{\text{initial volume}}$$

or equal to 1 if ρ1 is determined in undiluted solution;

R is the recovery calculated using the CRM (see 7.8.5) or the post digestion spike.

m is the mass of sample in g

V is the volume of solution in ml

9. EXPRESSION OF RESULTS

The rounding of values will depend on the uncertainty reported with the result; in general for this method two or three significant figures should be reported.

Uncertainty component should be reported with all results. (ISO 2005, Nordtest 2004)

Example: w(Hg) = 0.512 ± 0.065 mg kg⁻¹.

10. REFERENCES

- IAEA (2011). IAEA Recommended method on the microwave digestion of marines samples for the determination of trace element content, 2011, *in preparation*, available upon request
- ISO (1995). Guide to the expression of uncertainty of measurements International Organisation for Standardization: Geneva
- Linsinger T. (2010). European Commission - Joint Research Centre, Institute for Reference Materials and Measurements (http://www.erm-crm.org/ERM_products/application_notes/application_note_1/Documents/erm_application_note_1_english_rev3.pdf)

- Nordtest (2004). Handbook For Calculation Of Measurement Uncertainty In Environmental Laboratories Edition 2 <http://www.nordicinnovation.net/nordtestfiler/tec537.pdf>
- UNEP/IOC/IAEA (1994) reference method 57: Quality assurance and good laboratory practice, UNEP, 1994.

Annex XIII:

HELCOM

Manual for marine monitoring in the COMBINE programme
ATTACHMENT 1. TECHNICAL NOTE ON THE DETERMINATION OF TOTAL
MERCURY IN MARINE BIOTA BY COLD VAPOUR ATOMIC ABSORPTION
SPECTROSCOPY

HELCOM Manual for marine monitoring in the COMBINE programme

ATTACHMENT 1. TECHNICAL NOTE ON THE DETERMINATION OF TOTAL MERCURY IN MARINE BIOTA BY COLD VAPOUR ATOMIC ABSORPTION SPECTROSCOPY

1. POSSIBILITIES OF USING COLD VAPOUR ATOMIC ABSORPTION SPECTROMETRY IN TOTAL MERCURY ANALYSIS

The most widely used method for the determination of total mercury in biological tissues is cold vapour atomic absorption spectrometry (CV-AAS), based on a technique elaborated in detail by Hatch and Ott (1968). In this method, (divalent) ionic mercury is reduced to its metallic form (Hg⁰) in acidic solution using a powerful reducing agent. Subsequently, the elemental mercury is volatilized (purged) by a carrier gas and transported into an absorption cell, where the 253.65 nm wavelength absorbance of mercury atoms is measured.

CV-AAS analysis can be performed manually using batch CV-AAS or automatically using flow injection (FI) techniques. FI is a very efficient approach for introducing and processing liquid samples in atomic absorption spectrometry. The FI technique, combined with a built-in atomic absorption spectrometer optimised for mercury determination, reduces sample and reagent consumption, has a higher tolerance of interferences, lower determination limits and improved precision compared with conventional cold vapour techniques.

The efficiency of various flow injection mercury systems has been reported by several groups (Tsalev *et al.*, 1992a, 1992b; Welz *et al.*, 1992; Guo and Baasner, 1993; Hanna and McIntosh, 1995; Kingston and McIntosh, 1995; Lippo *et al.*, 1997). Better sensitivities of both conventional CV-AAS and FI-CV-AAS can be obtained by collecting mercury vapour released from the sample solution on a gold adsorber (Welz and Melcher, 1984). This so-called amalgamation technique eliminates kinetic interferences due to a different vaporization rate or a different distribution function of the elemental mercury between the liquid and the gaseous phases. The amalgamation ability of the gold adsorber must be carefully and regularly checked. Volatile compounds (in particular sulfur-containing compounds) evaporating together with the elemental mercury from the sample solution may deactivate the adsorber surface. This means an increased risk of underestimation, as unknown quantities of mercury are not collected by the adsorber.

2. SAMPLE PRETREATMENT

It is generally agreed that oxidative conversion of all forms of mercury in the sample to ionic Hg(II) is necessary prior to reduction to elemental Hg and its subsequent measurement by CV-AAS. Therefore, the initial procedural step in mercury analysis is a sample pretreatment, which is aimed at liberating the analyte element from its chemical bonding to the organic matrix and thus transforming all of the analyte species into a well-defined oxidation state. For this purpose, a wide variety of combinations of strong acids (HCl, H₂SO₄, HNO₃) and oxidants (H₂O₂, KMnO₄, K₂Cr₂O₇, K₂S₂O₈) have been tested and recommended (Kaiser *et al.*, 1978; Harms, 1988; Vermeiret *et al.*, 1989; Ping and Dasgupta, 1989; Baxter and Frech, 1990; Landi *et al.*, 1990; Navarro *et al.*, 1992; Lippo *et al.*, 1997).

A suitable sample pretreatment, which implies the complete transformation of all organomercury species into inorganic mercury ions, requires the following:

- oxidation mixtures with a high oxidation potential;
- rapid oxidation (usually promoted by high reaction temperatures), preferably in closed systems;

- compatibility with CV-AAS techniques;
- stability of sample solutions during storage (at least short term);
- no formation of solid reaction products.

On-line sample pretreatment is of particular interest in total mercury determinations because it allows reduction of the well-known problems associated with the inherent risk of contamination, and volatilization and adsorption losses. At present, suitable procedures for on-line pretreatment of solid biological samples are lacking. However, several authors (Tsalev *et al.*, 1992a 1992b; Welz *et al.*, 1992; Guo and Baasner, 1993) have demonstrated that microwave digestion coupled with FI-CV-AAS can successfully be applied to the analysis of liquid samples.

3. CONTROL OF CONTAMINATION AND ANALYTE LOSSES

Major difficulties arise due to the mobility and reactivity of mercury and its compounds, respectively, during sample preparation, sample pretreatment, and analysis. Therefore, the stability of samples and standard solutions is of prime importance, and it is advisable to test the stability of typical standard and sample solutions under typical laboratory conditions.

Mercury can disappear from solution due to several mechanisms, including volatilization of mercury compounds, reduction of such compounds followed by volatilization of elemental (metallic) mercury, adsorption on container walls, adsorption onto colloids or particles, incorporation into stable chemical complexes, or incorporation, upon reduction, into stable amalgams.

Thermodynamic considerations of Toribara *et al.* (1970) showed that loss of mercury from a solution containing the element in the monovalent form may occur readily through disproportion and subsequent loss of metallic mercury. Because of the high oxidation potential of the mercury(II)-mercury(I) system, almost any reducing substance could convert some divalent mercury ions into monovalent mercury ions, which then spontaneously disproportionate into mercury(II) and mercury(0). The latter escape as metallic vapour from the solution into the gas phase. Because of the almost impossibility of preventing the introduction of small amounts of reducing substances by reagents or solvents, the more dilute mercury(II) solutions would be less stable and lose mercury more readily. The only practical method for stabilizing such solutions is to add a small excess of an oxidising substance (such as permanganate), which has a higher oxidation potential than the mercury(II)-mercury(I) system.

Similarly, Feldman (1974) concluded from his experiments that solutions with 0.1 µg divalent Hg dm⁻³ in distilled water could be stored in glass vials for as long as five months without deteriorating if the solutions contained 5 % (v/v) HNO₃ and 0.01 % Cr₂O₇²⁻. Storage of such solutions was safe in polyethylene vials for at least 10 days if the solutions contained 5 % (v/v) HNO₃ and 0.05 % Cr₂O₇²⁻. The efficiency of this mixture was probably due to its ability to prevent the hydrolysis of dissolved mercury and prevent its reduction to valencies lower than +2.

4. REDUCING REAGENTS

Tin(II) chloride and sodium tetrahydroborate are predominantly used as reducing reagents for the determination of total mercury by CV-AAS. Sodium tetrahydroborate has been found advantageous for several applications owing to its higher reducing power and faster reaction (Toffaletti and Savory, 1975). In addition, this reductant has been successfully used even in the presence of interfering agents such as iodide and selenium (Kaiser *et al.*, 1978). However, potential interferences can occur from metal ions (e.g., Ag(I), Cu(II), Ni(II)), which are themselves reduced to the metallic state and so may occlude mercury through amalgamation.

Welz and Melcher (1984) showed that sodium tetrahydroborate could more readily attack those organic mercury compounds which were not reduced to metallic mercury by tin(II) chloride.

However, they stated that sodium tetrahydroborate could not be recommended as the reducing reagent for the amalgamation technique. They found that, due to the rather violent reaction with sodium tetrahydroborate, fine droplets of the sample solution were carried by the gas stream and contaminated or deactivated the adsorber surface. Further, they considered even more important the fact that not only mercury but all gaseous hydride-forming elements (e.g., arsenic, antimony, selenium) were volatilized when sodium tetrahydroborate was used as reductant. These hydrides reacted with the adsorber material and deactivated its surface, thus no longer permitting a sensitive and reproducible determination of mercury.

5. INTERFERENCES

Interferences by volatile nitrogen oxides in the determination of mercury by FI-CV-AAS were studied by Rokkjaer et al. (1993). The main symptom of the interference effects was a suppression, broadening or even splitting of the mercury signal. The authors postulated that volatile nitrogen oxides formed as reaction products of nitric acid during sample decomposition scavenged the reducing agent and concomitantly inhibited the reduction of mercury(II). The rate of the reaction of nitrogen oxides with the reducing agent was considered to be so fast that it was consumed before the reduction of mercury was complete. Rokkjaer et al. (1993) demonstrated that the interference could easily be remedied by purging the sample solution with an inert gas prior to the introduction of the reducing agent. Lippo et al. (1997) concluded from their experiments that nitrogen mono- and dioxide, having molecular absorption bands at 253.63 nm and 253.85 nm, respectively, might cause unspecific absorption at the specific mercury wavelength of 253.65 nm, leading to enhanced and broadened mercury signals if not properly compensated for by adequate instrumental background correction.

6. INTERNAL (ROUTINE) QUALITY CONTROL

In order to demonstrate that the analytical method applied is fit for the purpose of the investigations to be carried out, control materials should be regularly analysed alongside the test materials (cf. Chapter B.5 of the Manual).

The control materials - preferably certified reference materials (CRM) - should be typical of the test materials under investigation in terms of chemical composition, physical properties and analyte concentration. Fitness for purpose is achieved if the results obtained from the analysis of the control materials are within the defined limits of permissible tolerances in analytical error (see Chapters B.3.5, B.4.2.5 and B.4.2.5.2b of the Manual).

7. REFERENCES

- Baxter, D., and Frech, W. 1990. Critical comparison of two standard digestion procedures for the determination of total mercury in natural water samples by cold vapour atomic absorption spectrometry. *Analytica Chimica Acta*, 236: 377-384.
- EURACHEM 2003. EURACHEM/CITAC Guide "Traceability in Chemical Measurement" – A guide to achieving comparable results in chemical measurement. S.L.R. Ellison, B. King, M. Rösslein, M. Salit, A. Williams (Eds.), 43 pp.
- Feldman, C. 1974. Preservation of dilute mercury solutions. *Analytical Chemistry*, 46: 99-102.
- Guo, T., and Baasner, J. 1993. Determination of mercury in urine by flow-injection cold vapour atomic absorption spectrometry. *Analytica Chimica Acta*, 278: 189-196.
- Hanna, C., and McIntosh, S. 1995. Determination of total Hg in environmental samples with on-line microwave digestion coupled to a flow injection mercury system (FIMS). *Atomic Spectroscopy*, 16: 106-114.

- Harms, U. 1988: Analytical procedures for mercury, cadmium and lead in biological material. Baltic Sea Environment Proceedings, No. 27C, Part CI, pp. 36-62. Helsinki Commission.
- Hatch, W., and Ott, W. 1968. Determination of sub-microgram quantities of mercury by atomic absorption spectrometry. *Analytical Chemistry*, 40: 2085-2087.
- Kaiser, G., Götz, D., Tölg, G., Knapp, G., Maichin, B., and Spitzzy, H. 1978. Untersuchung von systematischen Fehlern bei der Bestimmung von Hg-Gesamtgehalten im Bereich 10 -5 % in anorganischen und organischen Matrices mit zwei unabhängigen Verbundverfahren. *Fresenius Z. Analytical Chemistry*, 291: 278-291.
- Kingston, K., and McIntosh, S. 1995. Determination of mercury in geological samples by flow injection AAS. *Atomic Spectroscopy*, 16: 115-117.
- Landi, S., Fagioli, F., Locatelli, C., and Vecchietti, R. 1990. Digestion method for the determination of mercury in vegetable matrices by cold vapour atomic absorption spectrometry. *Analyst*, 115: 173-177.
- Lippo, H., Jauhiainen, T., and Perämäki, P. 1997. Comparison of digestion methods for the determination of total mercury in environmental samples by flow injection CV-AAS. *Atomic Spectroscopy*, 18: 102-108.
- Navarro, M., Lopez, M., Lopez, H., and Sanchez, M. 1992. Microwave dissolution for the determination of mercury in fish by cold vapour atomic absorption spectrometry. *Analytica Chimica Acta*, 257: 155-158.
- Ping, L., and Dasgupta, P. 1989. Determination of total mercury in water and urine by gold film sensor following Fenton's Reagent digestion. *Analytical Chemistry*, 61: 1230-1235. Rokkjaer, J., Hoyer, B., and Jensen, N. 1993. Interference by volatile nitrogen oxides in the determination of mercury by flow injection cold vapour atomic absorption spectrometry. *Talanta*, 40: 729-735.
- Toffaletti, J., and Savory, J. 1975. Use of sodium borohydride for determination of total mercury in urine by atomic absorption spectrometry. *Analytical Chemistry*, 47: 2091-2095.
- Toribara, T., Shields, C., and Koval, L. 1970. Behaviour of dilute solutions of mercury. *Talanta*, 17: 1025-1028. Tsalev, D., Sperling, M., and Welz, B. 1992a: On-line microwave sample pre-treatment for hydride generation and cold vapour atomic absorption spectrometry. Part 1. The manifold. *Analyst*, 117: 1729-1733.
- Tsalev, D., Sperling, M., and Welz, B. 1992b. On-line microwave sample pre-treatment for hydride generation and cold vapour atomic absorption spectrometry. Part 2. Chemistry and application. *Analyst*, 117: 1735-1739.
- Vermeir, G., Vandecasteele, C., and Dams, R. 1989. Microwave dissolution for the determination of mercury in biological samples. *Analytica Chimica Acta*, 220: 257-261.
- Welz, B., and Melcher, M. 1984. Picotrace determination of mercury using the amalgamation technique. *Atomic Spectroscopy*, 5: 37-42.
- Welz, B., Tsalev, D., and Sperling, M. 1992. On-Line microwave sample pre-treatment for the determination of mercury in water and urine by flow-injection cold-vapour atomic absorption spectrometry. *Analytica Chimica Acta*, 261: 91-103.

Annex XIV:

**Sample work-up for the analysis of selected chlorinated
hydrocarbons in the marine environment**



UNITED NATIONS ENVIRONMENT PROGRAMME

November 2011

Sample work-up for the analysis of selected chlorinated hydrocarbons in the marine environment

Recommended Methods For Marine Pollution Studies 71

Prepared in co-operation with



NOTE: This recommended method is not intended to be an analytical training manual. Therefore, the method is written with the assumption that it will be used by formally trained analytical chemists. Several stages of this procedure are potentially hazardous; users should be familiar with the necessary safety precautions.

For bibliographic purposes this document may be cited as:

UNEP/IAEA: Sample work-up for the analysis of selected chlorinated hydrocarbons in the marine environment. Reference Methods for Marine Pollution Studies No 71, UNEP, 2011.

PREFACE

The Regional Seas Programme was initiated by UNEP in 1974. Since then, the Governing Council of UNEP has repeatedly endorsed a regional approach to the control of marine pollution and the management of marine and coastal resources and has requested the development of regional action plans. The Regional Seas Programme at present includes thirteen regions and has over 140 coastal States participating in it (1).

One of the basic components of the action plans sponsored by UNEP in the framework of the Regional Seas Programme is the assessment of the state of the marine environment, its resources and the sources and trends of the pollution and its impact on human health, marine ecosystems and amenities. In order to assist those participating in this activity and to ensure that the data obtained through this assessment can be compared on a world-wide basis and thus contribute to the Global Environment Monitoring System (GEMS) of UNEP, a set of Reference Methods and Guidelines for marine pollution studies are being developed as part of a programme of comprehensive technical support which includes the provision of expert advice, reference methods and materials, training and data quality assurance (2). The Methods recommended for adoption by Governments participating in the Regional Seas Programme.

The methods and guidelines are prepared in co-operation with the relevant specialised bodies of the United Nations system as well as other organisations and are tested by a number of experts competent in the field relevant to the methods described.

In the description of the methods and guidelines, the style used by the International Organisation for Standardisation (ISO) has been followed as closely as possible.

The methods and guidelines published in UNEP's series of Reference Methods for Marine Pollution Studies are not considered as definitive. They are planned to be periodically revised taking into account the new developments in analytical instrumentation, our understanding of the problems and the actual need of the users. In order to facilitate these revisions, the users are invited to convey their comments and suggestions to:

Marine Environmental Studies Laboratory
IAEA Environment Laboratories
4, Quai Antoine 1^{er}
MC 98000 MONACO

which is responsible for the technical co-ordination of the development, testing and inter-calibration of Reference Methods.

References:

(1) www.unep.org/regionalseas (2011)

(2) UNEP/IAEA/IOC: Reference Methods and Materials: A Programme of comprehensive support for regional and global marine pollution assessment. UNEP, 1990.

CONTENTS

	Page
1. Scope and field of application	1
2. Principles	1
3. Reagents, solvents, standards	1
3.1. Reagents	1
3.1.1. List of reagents	1
3.1.2. Cleaning of solvents	3
3.1.3. Cleaning of reagents and adsorbents	3
3.1.3.1. Cleaning of reagents	3
3.1.3.2. Cleaning of adsorbents	4
3.2. Apparatus and equipment	4
3.2.1. List of materials	4
3.2.2. Cleaning of glassware	5
4. Sediments	7
4.1. Sampling	7
4.2. Cleaning of extraction thimbles	7
4.3. Extraction of sediment	7
4.3.1. Extraction of freeze-dried samples	7
4.3.2. Extraction of wet samples	7
4.3.3. Example of determination of percent moisture	8
4.4. Concentration of the extract	8
4.5. Extractable organic matter	9
4.6. Clean-up procedure and fractionation	10
4.6.1. Sulphur and sulphur compounds removal	10
4.6.2. Fractionation	11
4.6.2.1. Florisil	11
4.6.2.2. Gel permeation chromatography	13
4.6.2.3. Alumina and HPLC (silica column)	13
4.6.2.4. High pressure chromatography	13
5. Biota	14
5.1. Sampling	14
5.2. Cleaning of extraction thimbles	14
5.3. Extraction of tissues	16
5.3.1. Extraction procedure for freeze-dried samples	16
5.3.2. Extraction procedure without freeze-drying	16
5.4. Concentration of the extract	16
5.5. Extractable organic matter (EOM)	16
5.6. Clean-up procedure and fractionation	16
5.6.1. Removal of lipids by concentrated sulphuric acid	16
5.6.2. Fractionation	16
6. Capillary Gas chromatographic determinations	17
6.1. Gas chromatography conditions	17
6.2. Column preparation	17
6.3. Column test	18
6.4. Electron capture detector	19
6.5. Quantification	19
7. Computerized gas chromatography/Mass spectrometry (GC/MS)	20
7.1. Operating conditions	20
7.2. Example of a selected ion monitoring programme useful for quantitative analysis of chlorinated compounds	25
8. Notes on water analysis	25
9. Alternative procedures	25
9.1. Combining sample preparation and extraction for chlorinated and petroleum hydrocarbons	25
9.2. Supercritical fluid extraction (SFE) of marine samples	26
9.3. Microwave assisted extraction for marine samples	28
9.3.1. Sediment	28
9.3.2. Biota	28

10. Data interpretation	29
10.1. DDT	29
10.2. PCBs congeners	29
10.3. Typical profiles of commercial mixtures	30
11. Quality assurance / quality control	31
11.1. Precision	31
11.2. Accuracy	31
11.3. Blanks	31
11.4. Recovery	31
11.5. Archiving and reporting of results	31
12. References	34
Annex:	
Explanations sent to all laboratories with sets of standard provided by IAEA-EL/MESL.	36

1. SCOPE AND FIELD OF APPLICATION

This reference method is intended for use in monitoring programmes and pilot research studies. The document describes procedures for the isolation of purified fractions amenable for the determination of DDTs and PCBs in marine sediments and marine organisms by capillary GC/ECD. It is assumed that most of the participants in the UNEP Regional Seas Programmes are equipped with advanced high resolution capillary gas chromatographs and will be able to implement most, if not all, of the procedures described in Reference Method No 40, "Determination of DDTs and PCBs by capillary gas chromatography and electron capture detection" (UNEP 1988). Assuming consistent results are routinely being obtained with these methods by the analytical laboratory, the determination of specific compounds (as opposed to generic mixture of PCBs) opens up the possibility not only of identifying environmental "hot spots", but also for characterising sources, elucidating transport pathways and developing data of greater toxicological relevance. The organisation and content of this document, however, deserves further comment. Under the sections devoted to SEDIMENTS and ORGANISMS, subsections are provided relating to procedures for: 1) Sampling, 2) Extraction and 3) Clean-up and fractionation. In each subsection, several alternative procedures are described. These various procedures have been previously tested and are provided to accommodate the range of capabilities in participating laboratories. For example, laboratories which have access to an HPLC may consider the benefits of using HPLC fractionation procedures in lieu of more conventional low pressure column chromatographic method. Participants are generally encouraged to implement the most effective procedures within the constraints of their individual laboratories.

Several other halogenated pesticides and other electron capturing organic compounds may be present in environmental samples and many of these compounds could also be isolated by the methods described here. However, not all residues will be stable to the clean-up procedures applied for the determination of PCBs and DDTs. Consequently, every analyst must test for analyte recovery and analytical reproducibility prior to applying these methods for other analytes on a routine basis. Primary emphasis should be placed on obtaining the cleanest possible purified fraction for capillary GC/ECD analysis so that interferences and misidentification are minimised, if not eliminated.

2. PRINCIPLES

Following collection of sediment or biota samples using appropriate techniques, samples are stored in trace organic free vessels at -20°C until analysis. For analysis, the samples are prepared for solvent extraction. To achieve a satisfactory recovery of the chlorinated hydrocarbons, samples are dried by either desiccation with anhydrous sodium sulphate or by freeze-drying. Lipids are then Soxhlet extracted from sediments using hexane and dichloromethane, and from biota using hexane or petroleum ether. Following initial clean-up treatments (removal of sulphur from sediment extracts and treatment of biota extracts with concentrated sulphuric acid to destroy some interfering lipids), extracts are fractionated using column chromatography. Detailed protocols for absorption chromatographic fractionation are described for both low and high pressure systems, using Florisil and silica gel respectively. (Additional information concerning alternative techniques including gel permeation chromatography is provided).

3. REAGENTS, SOLVENTS, STANDARDS

3.1. Reagents

3.1.1. List of reagents

- Demineralized distilled water produced by distillation over potassium permanganate (0.1 g/l KMnO₄) or equivalent quality, demonstrated to be free from interfering substances.
- Detergent.
- Potassium dichromate.
- HCl. 32%.
- Concentrated H₂SO₄ (d 20°C: 1.84 g/ml).
- Sulfochromic cleaning solution made from concentrated sulphuric acid and potassium

- dichromate.
- KOH.
 - Anhydrous sodium sulphate.
 - Copper fine powder (particle size 63µm).
 - Carborundum boiling chips.
 - Hg.
 - Glass wool
 - Alumina (200-240).
 - Silica gel (60-100).
 - Florisil PR (60-100).
 - Bio-Beads SX-3 (200-400).
 - Sephadex LX-20.

Solvents:

- Hexane, Dichloromethane, Methanol, Pentane, Cyclohexane, Toluene and Ethyl Acetate, all "distilled in glass" quality.

Standards:

- PCB congeners: 29, 30, 121, 198.
- ε HCH.
- Endosulfan Id₄.
- n-C₁₄ d₃₀, n-C₁₉ d₄₀, n-C₃₂ d₆₆.
- Naphthalene d₈.
- Hexamethylbenzene.
- Cadalene: 1, 6-dimethyl-4-(1-methylethyl)naphthalene.
- DDT reference solutions - Prepare a stock solution of the DDT series (pp' DDT, op DDT, pp' DDD, op DDD, pp' DDE, op DDE) by dissolving 50 mg of each compound in 100 ml of hexane. Store stock solution in sealed glass ampoules.
- Other reference solutions - should be prepared if other residues are to be quantified in these procedures.

NOTES:

Working solutions obtained from the stock reference solutions should be prepared on a regular basis depending on their use and stored in clean glass volumetric flasks tightly capped with non-contaminating materials such as Teflon or glass. Extreme care must be taken to ensure that the concentrations of the standards have not altered due to solvent evaporation.

In order to achieve acceptable accuracy for the standard solutions, at least 50 mg of pure individual compound should be weighed and dissolved into 100 ml of hexane. This will give stock solutions of 500ng/µl.

Example of preparation of stock solutions:

Preparation of a stock solution of pp' DDE at approximately 500ng/µl:

The pp' DDE stock solution is prepared by dissolving approximately (but weighed accurately) 50 mg of pp' DDE in hexane in a 100 ml volumetric flask and bringing the volume to exactly 100 ml with hexane. If the actual weight of pp' DDE is 52 mg, then

$$\frac{52 \text{ mg DDE}}{100 \text{ ml solvent}} \times \frac{1000 \mu\text{g}}{\text{mg}} \times \frac{\text{ml}}{1000 \mu\text{l}} = \frac{52 \text{ mg DDE}}{100 \text{ ml of solution}}$$

$$52 \text{ mg}/100 \text{ ml} \Rightarrow 0.52 \text{ mg/ml} \Rightarrow 520 \mu\text{g/ml} \Rightarrow 520 \text{ ng}/\mu\text{l}$$

The concentration of the stock solution will be: 520ng/µl

Preparation of an intermediate solution:

Use the stock solution to prepare the intermediate solution. The concentration of pp' DDE intermediate solution should be approximately 5ng/μl. To prepare the 5ng/μl intermediate solution, transfer 1 ml of the pp' DDE stock solution into a 100 ml volumetric flask and dilute with hexane to 100 ml.

$$\frac{1 \text{ ml DDE stock solution}}{100 \text{ ml final volume}} \times \frac{520 \text{ ng DDE}}{\mu\text{l}} = \frac{5.2 \text{ ng}}{\mu\text{l intermediate solution}}$$

The concentration of the intermediate solution will be: 5.2 ng/μl

Preparation of the working solution:

Use the intermediate solution to prepare the working solution. The concentration of pp' DDE in the working solution could be approximately 50pg/μl.

To prepare the 50 pg/μl working solution, transfer 1 ml of the pp' DDE intermediate solution into a 100 ml volumetric flask and dilute with hexane to 100 ml.

$$\frac{1 \text{ ml DDE intermediate solution}}{100 \text{ ml final volume}} \times \frac{5.2 \text{ ng}}{\mu\text{l}} \times \frac{1000 \text{ pg}}{\text{ng}} = \frac{52 \text{ pg}}{\mu\text{l working solution}}$$

The concentration of the working solution will be: 52 pg/μl

3.1.2. Cleaning of solvents

All reagents, including the distilled water should be of analytical quality. Commercially available solvents like acetone, acetonitrile, dichloromethane, hexane and pentane are invariably contaminated with ECD-active substances; their concentrations vary from batch to batch and with supplier. Reagent quality should be checked by injection of 2 μl of a 100 ml batch of solvent, after concentration to 50 μl in a rotary evaporator. No peak in the GC-ECD chromatogram (90 - 250 °C) should be larger than that for 1pg of lindane. Otherwise, the solvent must be distilled. The following procedure has been found to be both efficient and cost effective, as it allows the use of technical grade solvents as the basic material (reducing the cost by one order of magnitude). 130 - 150 cm height columns are required; the packing material must be glass (to allow subsequent cleaning with an oxidising acid). The entire equipment is cleaned prior to use by 2 consecutive distillation procedures with 500 ml water in each case. It is essential that a current of nitrogen gas (15 ml/min) flows from the distillation flask during distillation of the organic solvents: the condenser serves as exhaust. Ambient air is not in contact with the solvent in this way. Problems are associated with other methods of excluding room air (e.g., active carbon or molecular sieves), the most important one being discontinuity. The condensate is distilled into a 1 litre flask at a 1:20 ratio. This large volume allows for direct transfer into the appropriate solvent containers which should be made of glass and of a sufficient size to provide solvent for not more than 6 analyses. A bottle with sufficient solvent for 10 - 15 analysis has to be opened and closed many times and even when kept closed, when not in use, contamination from the surrounding atmosphere takes place. For more detailed information, consult the Reference Method No 65: UNEP/IOC/IAEA: Reagent and laboratory ware clean-up procedures for low-level contaminant monitoring.

3.1.3. Cleaning of reagents and adsorbents**3.1.3.1. Cleaning of reagents**

Powdered or crystalline reagents, such as anhydrous sodium sulfate (Na₂SO₄)*, potassium hydroxide (KOH), glass wool * and carbon or carborundum boiling chips *, must be thoroughly cleaned before use. They should be extracted with hexane in a Soxhlet apparatus for 8 hours and then with methanol or dichloromethane for another 8 hours. For those items indicated by an *, this will require pre-combustion in a muffle furnace at approximately 400°C.

3.1.3.2. Cleaning of adsorbents

Silica gel, alumina and Florisil have to be solvent extracted. Each reagent is first refluxed with methanol or dichloromethane in a Soxhlet apparatus for 8 hours, then with n-hexane for the same period. The solvent is removed by a rotary evaporator operating at low speed, until the sorbent starts falling down as fine particles. Reagents are dried in a drying oven at 0.01 mbar. If this is not available, they are dried in a normal oven at 120°C for 4 hours. This serves to activate silica and alumina. Florisil has to be activated at 130°C for 12 hours. The sorbent is allowed to cool in the oven (if possible under vacuum to avoid uptake of contaminants from the atmosphere) or alternatively, in a dessicator. As active sorbents attract water and contaminants from the atmosphere, controlled deactivation should be carried out by adding water to the fully active sorbent (5% by weight to silica, 2% by weight to alumina, and 0.5% by weight to Florisil). The deactivation procedure should be carried out by adding the water to the sorbent and mixing by gentle shaking for a few minutes. The equilibration takes one day. The activity can be maintained for longer periods of time by sealing the required amount of sorbent in glass ampoules. Otherwise, the activation/deactivation has to be done the day before use.

3.2. Apparatus and equipment

The laboratory used for organic trace analysis must be a dedicated facility, isolated from other projects that could be sources of contamination. It must be properly constructed with fume hoods and benches with electric sockets that are safe for use with flammable solvents. The laboratory must have extractors and rotary evaporators cooling water to run the stills. In tropical regions and in dry climates, a refrigerated re-circulating system should be used to reduce temperatures to the required levels and/or to conserve water. Stainless steel or ceramic tiles make good non-contaminating surfaces. If necessary, benches can be coated with a hard epoxy resin and walls can be painted with epoxy paint. A sheet of aluminium foil on the workbench provides a surface which can be cleaned with solvent. A vented storage facility for solvents is essential. Benches must be fitted with frames to hold stills, extractors, etc. The emergency cut-off switch should be accessible from both inside and outside the laboratory. Fire fighting equipment should be mounted in obvious places and laboratory personnel trained in their use.

3.2.1. List of materials

- A coring device with liners and plunger or a grab sampler (thoroughly cleaned with detergents and solvents before use).
- Glass jars and aluminium foil, stainless steel knives, scoops, forceps, labels, marking pens, logbook.
- Insulated plastic boxes for transporting samples. Ice or dry ice.
- Deep freezer (-18 to -20°C) for sample preservation (frost free type freezers heat to above zero during frost removal cycles and they cannot be used for long term storage).
- Rotary evaporator.
- Kuderna-Danish (or similar) concentrator and heater.
- Soxhlet extraction apparatus and heaters.
- Glassware including boiling flasks, ground glass stoppers, beakers, Erlenmeyer flasks, separatory funnels, centrifuge tubes, weighing bottles, pipettes, tissue grinders.
- Drying oven (temperature range up to at least 300°C) for determining sample dry weights, baking of contaminant residues from glassware and reagents.

Note: A muffle furnace is better for baking materials at greater than 300°C, if required.

- Centrifuge and tubes.
- Freeze-dryer and porcelain pestle and mortar.
- Analytical balance with an accuracy of 0.1 mg and an electro-balance with an accuracy of at least 1 µg.
- Stainless steel tweezers and spatulas.

- Dessicator - completely free of organic contamination and with no grease applied to sealing edges.
- Supply of clean, dry nitrogen.
- Columns for silica gel, alumina and Florisil chromatography.
- Mechanical blender (food mixer).
- Vacuum pump (water-jet air pump).

3.2.2. Cleaning of glassware

Scrub all glassware vigorously with brushes in hot water and detergent. Rinse five times with tap water and twice with distilled water. Rinse with acetone or methanol followed by hexane or petroleum ether. Bake overnight in an oven at 300 °C. All glassware should be stored in dust free cabinets and tightly sealed with pre-cleaned aluminium foil when not in use. Ideally glassware should be cleaned just before use.

For more detailed information, consult Reference Method No 65: UNEP/IOC/IAEA: Reagent and laboratory ware clean-up procedures for low level contaminant monitoring.

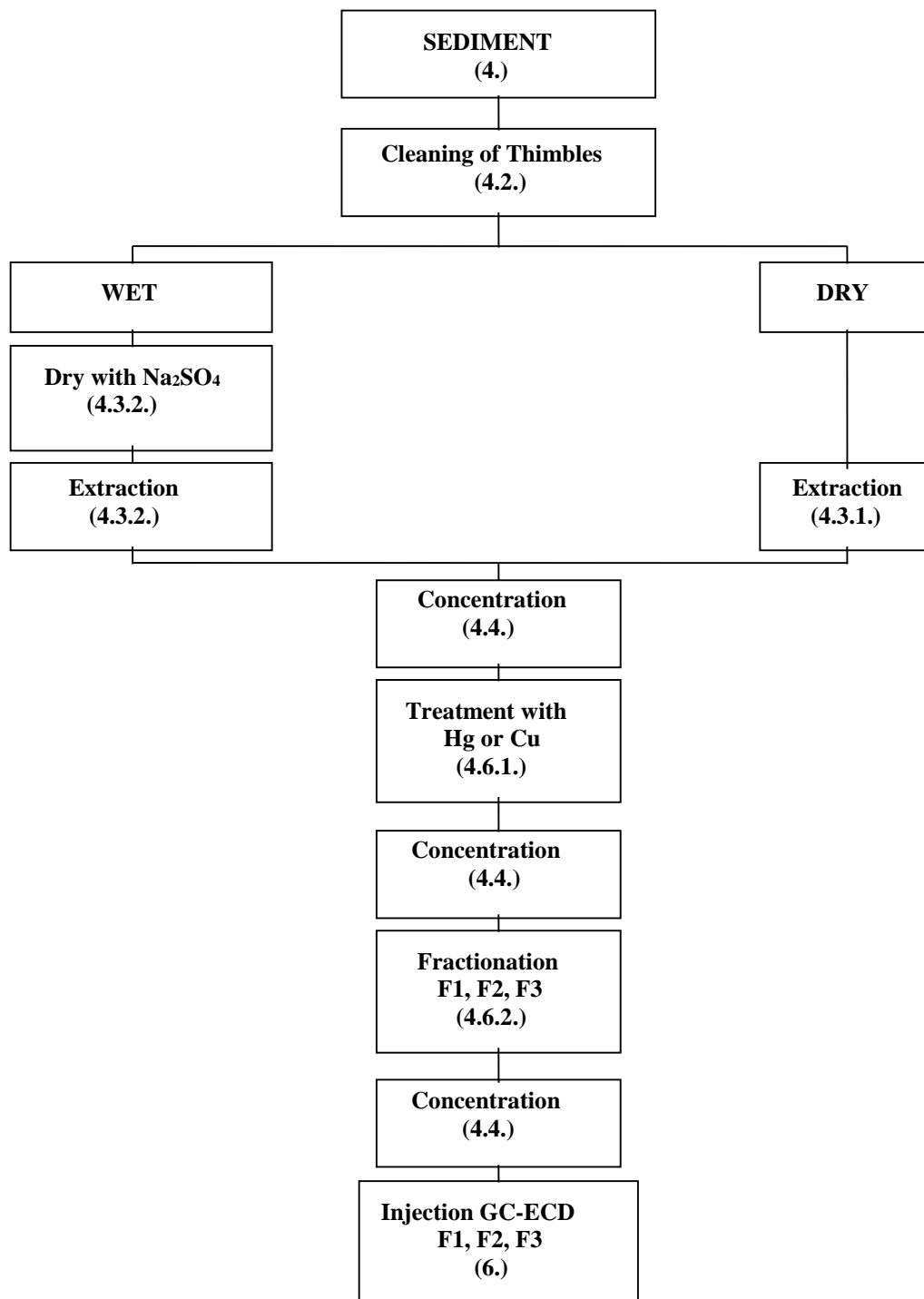

Diagram of the extraction procedure for sediment samples.

4. SEDIMENTS

4.1. Sampling

For the preparation of the samples (including selection of sites, collection of samples and storage) the reader should refer to the Reference Method N° 58: Guidelines for the use of sediments for the marine pollution monitoring programmes, to the Reference Method N° 20: UNEP/IOC/IAEA: Monitoring of petroleum hydrocarbons in sediments and to UNEP(DEC)/MEDW.C282/Inf.5/Rev1: Methods for sediment sampling and analysis (2006).

4.2. Cleaning of extraction thimbles

Paper extraction thimbles should be cleaned prior to sample extraction. For use in the extraction of sediment samples, the extraction can be performed in the Soxhlet apparatus with 250 ml of a mixture hexane / dichloromethane (50:50) for 8 hours cycling the solvent through at a rate of 4 to 5 cycles per hour. Add into the solvent a few carborundum boiling chips to get a regular ebullition.

The use of disposable paper thimbles for the extraction procedure rather than re-usable glass fibre thimbles is recommended due to the difficulties encountered in cleaning the latter.

4.3. Extraction of sediments

4.3.1. Extraction of freeze-dried samples

Select a 50-100 g sub-sample of the sediment, weigh this sub-sample and freeze-dry it. When dried, re-weigh it and calculate the dry to wet ratio. Then pulverise the sample using a pestle and mortar and sieve it using a 250 µm stainless steel sieve. Accurately weigh about 20 g of ground sample and place it in the pre-cleaned extraction thimble. Add 1 ml of a solution of 25 pg/µl of 2,4,5 trichlorobiphenyl (PCB N° 29), 20.9 pg/µl of 2,2',3,3',4,5,5',6 octachlorobiphenyl (PCB N° 198), 20 pg/µl of ε HCH and 21 pg/µl of Endosulfan Id₄ as internal standards and extract for 8 hours in a Soxhlet apparatus with 250 ml of a mixture hexane / dichloromethane (50:50), cycling the solvent through at a rate of 4 to 5 cycles per hour, add into the solvent a few carborundum boiling chips to get a regular ebullition. Alternatively (or in addition), PCB congeners No 30, 121, or octachloronaphthalene and PCB congeners can be used as internal standards. Prepare a procedural blank by extracting an empty thimble using the same procedure as for the samples.

4.3.2. Extraction of wet samples

The sediment is thawed, sieved at 250 µm and homogenised manually with a stainless steel spatula or clean glass rod. A sub-sample of 1-2 g is weighed into a flask and placed in a drying oven at 105 °C for 24 hours, then allowed to cool to room temperature and re-weighed. Calculate the dry to wet ratio and discard the dry sediment (unless it is being used for other analysis e.g. TOC, total organic carbon).

Place a 30-40 g sub-sample of thawed, homogenised sediment into a blender. Slowly, add 100g of anhydrous sodium sulphate (desiccant) and blend the mixture at high speed for 10 minutes. Transfer the dried sample quantitatively to the pre-cleaned extraction thimble in the Soxhlet apparatus, add the internal standard solution (see above) and apply the same extraction procedure as above. Extract the same amount of sodium sulphate as a procedural blank, making sure to add an appropriate amount of internal standard solution.

4.3.3. Example of determination of percent moisture

Many environmental measurements require the results to be reported on a dry weight basis. The percent moisture or water content in the sample is determined by weighing an aliquot, not used for analysis, of the sample before and after drying. The drying can be done by heating a few grams (1-2 g) of the sample in an oven to constant weight.

Weigh an empty glass beaker that will be used to hold the sample while it is dried.

Empty beaker weight = 10.4417 g

Add the wet sample to the beaker and reweigh. Calculate the wet weight of the sample.

Empty beaker weight + wet sample = 12.2972 g

Wet sample weight = 12.2972 g - 10.4417 g = 1.8555 g

Dry the sample to constant weight: dry the sample for 24 hours, weigh it, dry again for 12 hours, re-weigh it, when the difference in weight is less than 5%, it means that the sample is dried.

Empty beaker weight + dry sample weight = 10.9396 g

Dry sample weight = 10.9396 g - Empty beaker weight

Dry sample weight = 10.9396 g - 10.4417 g = 0.4979 g

Calculate the percent dry sample weight.

$$\begin{aligned} \% \text{ Sample weight} &= \frac{\text{Sample dry weight}}{\text{Sample wet weight}} \times 100 \\ &= \frac{0.4979}{1.8555} \times 100 = 26.8 \% \end{aligned}$$

Calculate the percent moisture.

$$\begin{aligned} \text{Water content} &= \text{wet weight} - \text{dry weight} \\ &= 1.855 \text{ g} - 0.4979 \text{ g} = 1.3576 \text{ g} \end{aligned}$$

$$\% \text{ Moisture} = \frac{\text{Sample water weight}}{\text{Sample wet weight}} \times 100$$

$$\% \text{ moisture} = \frac{1.3576}{1.8555} \times 100 = 73.2 \%$$

4.4. Concentration of the extract

For both extraction procedures, the extracts are concentrated in a rotary evaporator to about 15 ml. Under good vacuum conditions the temperature of the water bath must not exceed 30 °C. Dry the extract with anhydrous sodium sulphate (when the sodium sulphate moves freely in the flask it means that the extract is dried). Collect the dried extract in the graduated tube of a Kuderna-Danish concentrator. Concentrate the extract to approximately 5 ml with the Kuderna-Danish concentrator and adjust the volume to exactly 1 ml by evaporating excess solvent under a gentle stream of clean dry nitrogen. The sample extract will be analysed gravimetrically for extractable organic matter (EOM) content at the 1 ml volume as a starting point. If measurements of the EOM are outside the calibration range of the balance, the total volume of the extract is adjusted accordingly using either dilution with hexane or evaporating under a stream of nitrogen gas.

4.5. Extractable organic matter

Before carrying out the clean-up procedure, it is advisable to determine the extractable organic matter.

The EOM is determined in the following manner. On the weighing pan of an electro-balance, evaporate a known volume of the sediment or biota extract (up to 100 µl) and weigh the residue with a precision of about ± 1 µg. If the residue is less than 2 µg, pre-concentration of the original extract is required. The quantity of EOM is:

$$\text{EOM } (\mu\text{g/g}) = \frac{\text{Weight of residue } (\mu\text{g}) \times \text{volume of the extract (ml)} \times 1000}{\text{Volume evaporated } (\mu\text{l}) \times \text{quantity of sample extracted (g)}}$$

Note that extreme care must be taken to ensure balance and pans are clean, dry and stable to obtain accurate readings at the ± 1 µg level. A small hot plate is used to warm pans and forceps and thus keep these instruments dry after solvent cleaning. If no electro-balance is available, a known volume of the extract can be transferred into a clean pre-weighed beaker. The solvent is evaporated with dry and clean nitrogen until a constant weight of about 1 mg is reached. Calculate the amount of “lipids” in the sample taking into account the volume of the lipid extract which was dried.

Example of calculation of E.O.M.

The extractable organic matter content of a sample is operationally defined as the weight of material extracted with the solvent employed (H.E.O.M. in case hexane is used as solvent). An aliquot of the sample extract is taken (few µl), the solvent is evaporated and the residue is weighed to determine the quantity of lipids extracted in the aliquot and from it to the total sample. The results are normally reported in mg lipids per gram dry weight extracted.

A 1 µl aliquot is removed from a 2.5 ml sample extract for determination of E.O.M. The 1 µl aliquot is evaporated on the pan of an electro-balance and the residue is weighed. Three determinations are made and the average taken.

Measurements:

Sample dry weight extracted: 4.443 g

Total volume of the extract: 2.5 ml

Sample aliquot removed: 1 µl

(1) Weight of a 1 µl aliquot after solvent evaporation: 32.2 µg

(2) Weight of a 1 µl aliquot after solvent evaporation: 32.1 µg

(3) Weight of a 1 µl aliquot after solvent evaporation: 32.3 µg

Average weight of a 1 µl aliquot : 32.2 µg

Total volume of the extract: 2.5 ml

Total quantity of lipids in the sample:

$$32.2 \mu\text{g}/\mu\text{l} \times 2.5 \text{ ml} \times \frac{1000 \mu\text{l}}{\text{ml}} = 80500 \mu\text{g} \text{ or: } 80.5 \text{ mg}$$

With 4.443 g of sample extracted:

$$80.5 \text{ mg} / 4.443 \text{ g} = 18.1 \text{ mg lipids/g}$$

4.6. Clean-up procedure and fractionation

Purposes of the clean-up: removal of lipids, whenever present at a significant amount; removal of elementary sulphur and sulphur compounds. Both these compound classes can interfere with the gas-chromatographic separation.

4.6.1. Sulphur and sulphur compounds removal

Elementary sulphur and sulphur compounds such as mercaptans should be removed from the extract. This could be done by using either mercury or activated copper.

a) Mercury method.

Add one drop (a few ml) of mercury to the sediment extract and shake vigorously for one minute. Centrifuge and carefully recover and transfer the extract in another tube with a Pasteur pipette. If the mercury is still tarnished, repeat the treatment with another drop of mercury, shake, transfer the hexane into another tube. Repeat this treatment until the mercury stays brilliant in the extract. Rinse the mercury with 5 ml of hexane and combine the extracts. Then, concentrate the resulting solution to ca. 1 ml with a gentle stream of nitrogen.

Cleaning of mercury:

Caution: When removing mercury from the sample, always use a plastic tray to keep the glassware in and work under a fume hood.

Fit a folded filter paper in a 10 cm diameter conical glass funnel and fix the funnel over a 250 ml glass beaker. Using a needle, make a small hole in the bottom of the filter paper. Carefully put the mercury onto the funnel. The mercury flows through the small hole in the filter paper leaving the solid impurities on its surface. The mercury collected is washed three times by shaking it carefully with dichloromethane and by removing dichloromethane layer with the help of a clean glass syringe. Allow the rest of dichloromethane evaporate and store the clean mercury in a thick walled glass bottle with a ground glass stopper. In order to avoid escape of mercury vapour, store the mercury under methanol.

Another way of cleaning the mercury involves sucking the dirty mercury through a capillary tube, such as a Pasteur pipette, connected to a guard-flask and then to a vacuum pump. The mercury will pass through the Pasteur pipette and will be collected and cleaned in the guard-flask. Then it should be transferred into a thick wall glass bottle with a ground glass stopper. The mercury is covered with a layer of methanol to protect it from oxidation.

b) Activated copper method.

Transfer about 20 grams of the copper powder in an Erlenmeyer. Add enough concentrated HCl to cover the copper powder, agitate. Sonicate for 10 min., agitate, put again in ultrasonic bath and sonicate for 10 min. Throw the used HCl, add some fresh HCl, transfer in ultrasonic bath and sonicate for 20 min. repeat that procedure four times in total. Wash with distilled water, agitate, discard, add water again, transfer in ultrasonic bath and sonicate for 15 min., discard the used water, repeat that procedure again, up to pH neutral. Wash with acetone, agitate, transfer in ultrasonic bath and sonicate for 15 min. repeat that procedure four times in total. Then use the same procedure with hexane as a solvent.

Keep in hexane (use it immediately, avoids Cu to be in contact with air).

Transfer 3 to 4 Pasteur pipettes per sample in the flasks containing the hexane extracts. Let the copper react all night. The presence of sulphur compounds in the sample will be detected by the tarnishing of the copper powder. Then, concentrate the resulting solution to ca. 1 ml with a gentle stream of pure nitrogen.

4.6.2. Fractionation

An adsorption chromatography step is used to remove interfering lipids and to fractionate the extract into classes of compounds. Many variations of adsorption chromatography clean-up procedures have been published to date. Four procedures are reported here in order of increasing complexity.

Preparation of the columns: Glass burettes (1 cm diameter) with Teflon stopcocks make convenient adsorption columns. The column is plugged with pre-cleaned cotton or glass wool. Prepare separate columns for each sample and blank determination. The column is partially filled with hexane. The appropriate amount of sorbent is mixed with hexane in a small beaker to form a slurry. A glass funnel and a glass rod are used to pour the adsorbent into the column. Several rinses with hexane are necessary to fill the column to the desired height. Tap with a pencil or a hard silicone tube against the column in order to settle the adsorbent into an even bed. Flush the material adhering to the wall of the column down to the bed with solvent. Prepare each column freshly immediately before use. Never let the column get dry.

4.6.2.1. Florisil

A Florisil column is used for this fractionation, which is prepared in the following way. The Florisil should be pre-extracted in the Soxhlet apparatus to remove any contaminants, using methanol or dichloromethane for 8 hours, followed by hexane for another 8 hours. It is then dried in an oven. Activation is achieved by heating the dried Florisil at 130°C for 12 hours. It is then partially deactivated with 0.5% water by weight and stored in a tightly sealed glass jar with ground glass stopper. The water should be well mixed into the Florisil and the mixture should be allowed to equilibrate for one day before use. The activation/deactivation procedure should be carried out one day before use. A 1 cm burette with Teflon stopcock is plugged with pre-cleaned glass wool. A column with a sintered glass disk could also be used. 17 grams of Florisil are weighed out in a beaker and covered with hexane. A slurry is made by agitation and poured into the glass column. The Florisil is allowed to settle into an even bed and any Florisil adhering to the column is rinsed down with hexane. The solvent is drained to just above the Florisil bed. It should be rinsed with a further 5 ml of hexane; one gram of anhydrous sodium sulphate is added to the top of the column in order to protect the surface of the Florisil from any disturbance. The column should never run dry. Individual columns should be prepared immediately before use and a new column of Florisil used for each sample.

The extract, reduced to 1 ml, is put onto the Florisil column. It is carefully eluted with 65 ml of hexane and the first fraction collected. Then the column is eluted with 45 ml of a mixture containing 70 % of hexane and 30 % of dichloromethane and the second fraction collected. The third fraction will be eluted with 60 ml of pure dichloromethane.

Fraction one will contain the PCBs, pp' and op DDE and some other pesticides such as HCB, aldrin, heptachlor, DDMU.

Fraction two will contain the DDTs, DDDs, most of the toxaphene, and some pesticides such as the HCH isomers and chlordane components.

Fraction three will contain mainly dieldrin, endrin, heptachlor epoxide and endosulfan components. Typical chromatograms obtained are shown below.

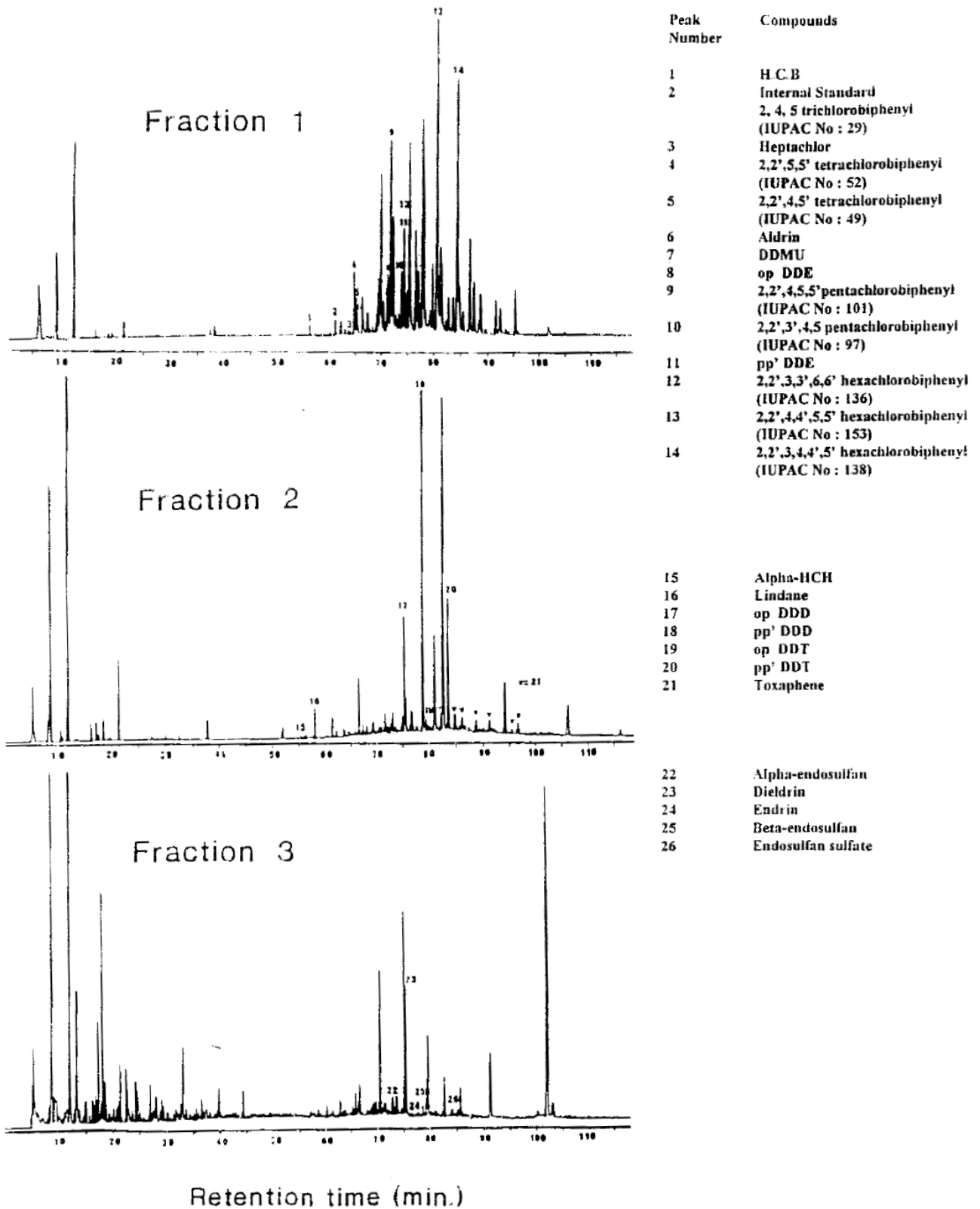

Figure 2: GC-ECD organohalogen analyses

4.6.2.2. Gel permeation chromatography

Low pressure GPC can be used as an alternative clean-up technique to remove high molecular weight co-extractable lipidic material from polycyclic aromatic compounds and halogenated aromatics. Concurrently, elemental sulphur could be also removed from the whole organic extract.

The main feature of the semi-preparative-GPC as a clean-up technique relies on the compatibility of this analytical procedure with labile components of the extract (i.e. DDTs, chlorinated cyclohexadiene derivatives), which are not stable in other types of extract clean-up procedures. Further, GPC as a clean-up technique has already been automated, enabling a high sample throughput, taking into account the short analysis time involved.

The GPC retention mechanism may involve adsorption, partition and size exclusion mechanisms. The predominance of one mechanism over the others is largely determined by the choice of the mobile phase and the pore size of the packing. In the case of GPC packings with large pore size (1000-2000 daltons) size exclusion and adsorption mechanisms prevail (Bio-Beads SX-3 using cyclohexane, dichloromethane-hexane, dichloromethane-cyclohexane, toluene-ethylacetate and ethylacetate-cyclohexane) (Ericksson *et al.*, 1986). On the other hand, when smaller pore sizes (400 daltons) are used in combination with highly polar solvents, (THF, DMF) size exclusion predominates (Lee *et al.*, 1981). While using the first approach, a chemical class fractionation could be obtained, however, if smaller pore sizes are used it should be combined with another fractionation technique (i.e. adsorption chromatography) to achieve this selectivity. It has yet to be demonstrated that using GPC as a single clean-up step produces a completely clean extract for GC-ECD determination. Nevertheless, taking into account the increasing availability of high-resolution low molecular weight exclusion packings, they could definitively integrate fractionation and clean-up in a single step.

Low resolution packing (Sephadex LH and Bio-Beads SX, 200-400 mesh size) are the most widely used because they are inexpensive and afford relatively high sample loading (500 mg in 10 mm i.d. columns). The implementation of low resolution GPC requires a solvent delivery system and a UV detector and may be useful. For method development, it is advisable to inject a broad range of standard compounds covering the whole range of molecular weights of the analytes to be determined in order to determine the cut-off points to fractionate real samples. Reported recoveries of PCBs and PAHs range from 60 to 80 % for the concentration level (ng) injected. (Fernandez and Bayona, 1992).

4.6.2.3. Alumina and HPLC (silica column)

The first step in this clean-up procedure is an adsorption step using an alumina column to remove most of the lipid material. Prepare an alumina column (4 x 0.5 cm i.d., made from a Pasteur pipette). Apply the concentrated extract to the top of the column and elute with 10 ml hexane. Concentrate the eluate to about 200 µl. It is followed by a second step to more completely remove interfering compounds and at the same time to separate the compounds of interest into different fractions, containing aliphatics, PCBs, PAHs, pesticides and toxaphene. Between 20 and 200 µl of the extract (after alumina clean-up) are eluted on a stainless steel column (200 x 4 mm i.d.), packed with Nucleosil 100-5 with n-pentane, 20 % dichloromethane in n-pentane and finally dichloromethane. The eluate is collected in fractions containing 1) n-hydrocarbons, 2) PCBs, 3) PAHs and toxaphene, 4) pesticides and toxaphene and 5) acids, etc. (polar compounds). The size of the fractions has to be determined with standard solutions containing the compounds of interest, collecting the eluate in 0.5 ml fractions. Each fraction is then analysed by GC-ECD. Full details have been given in the literature (Petrick *et al.*, 1988 and IOC, 1993).

4.6.2.4. High pressure chromatography

High pressure liquid chromatography (HPLC) columns packed with microparticles are available and have the advantages of high reproducibility, low consumption of solvents, high efficiency and high sample loading capacity.

This method can be used to separate fractions containing aliphatic hydrocarbons, PCBs and aromatic hydrocarbons from interfering compounds. These fractions can then be analysed separately for their constituents by GC-FID and/or GC-ECD.

HPLC methods have been developed using synthetic solutions of n-alkanes, PAHs, pesticides, PCBs and toxaphene and have been applied to samples in which interfering substances were present in such high concentrations as to render the analysis of HC and PCBs extremely difficult without this clean-up procedure (e.g. sediments and biological tissues with OCs in the ng/g range). The samples are eluted with n-hexane, subjected to clean-up over alumina, concentrated down to 20-200 µl and treated by HPLC. With the use of n-hexane, n-pentane and 10 %, 20 % and 50 % dichloromethane in n-hexane, respectively, the following five fractions are obtained : 1) n-hydrocarbons and alkenes, 2) PCBs and alkylbenzenes, 3) PAHs and toxaphene, 4) pesticides, 5) acids, etc.(polar compounds). (Petrick *et al.* 1988).

5. BIOTA

5.1. Sampling

Organisms accumulate many contaminants from their environment (i.e., from sea water, suspended particulate matter, sediment and food). Field and laboratory studies have shown that contaminant concentrations in some marine plants and animals reflect concentrations in their environment. Scientists use this process (termed bio-accumulation) to assess marine contamination resulting from human activity (e.g., pipeline discharges, dumping from ships).

There are problems with using biota as bio-accumulators (bio-indicators). For example, tissues from individuals of a species exposed to the same contaminant concentration may contain different levels of contamination after the same exposure time. These deviations reflect individual differences in factors such as age, sex, size, and physiological and nutritional states. Also, various species show different contaminant concentrations following identical exposure; differences in elimination rates may partially account for this. These factors must be considered when planning a monitoring programme in order to control their effects on the precision of the analysis (by reducing the variances). Variance reduction is necessary in order to detect smaller differences in mean contaminant concentrations observed in monitoring programmes.

For proper sampling and sample preparation, refer to Reference Method No 6 “Guidelines for monitoring chemical contaminants in the sea using marine organisms” and Reference Method No 12 Rev.2 “Sampling of selected marine organisms and sample preparation for the analysis of chlorinated hydrocarbons”.

5.2. Cleaning of extraction thimbles

As for extraction of sediment samples, thimbles should be extracted first with the same solvent used for the extraction of the sample. As the extraction of biota sample is achieved with hexane, a pre-extraction of these thimbles is made with 250 ml of hexane for 8 hours in the Soxhlet apparatus, cycling the solvent through at a rate of 4 to 5 cycles per hour. Add into the solvent a few carborundum boiling chips to get a regular ebullition.

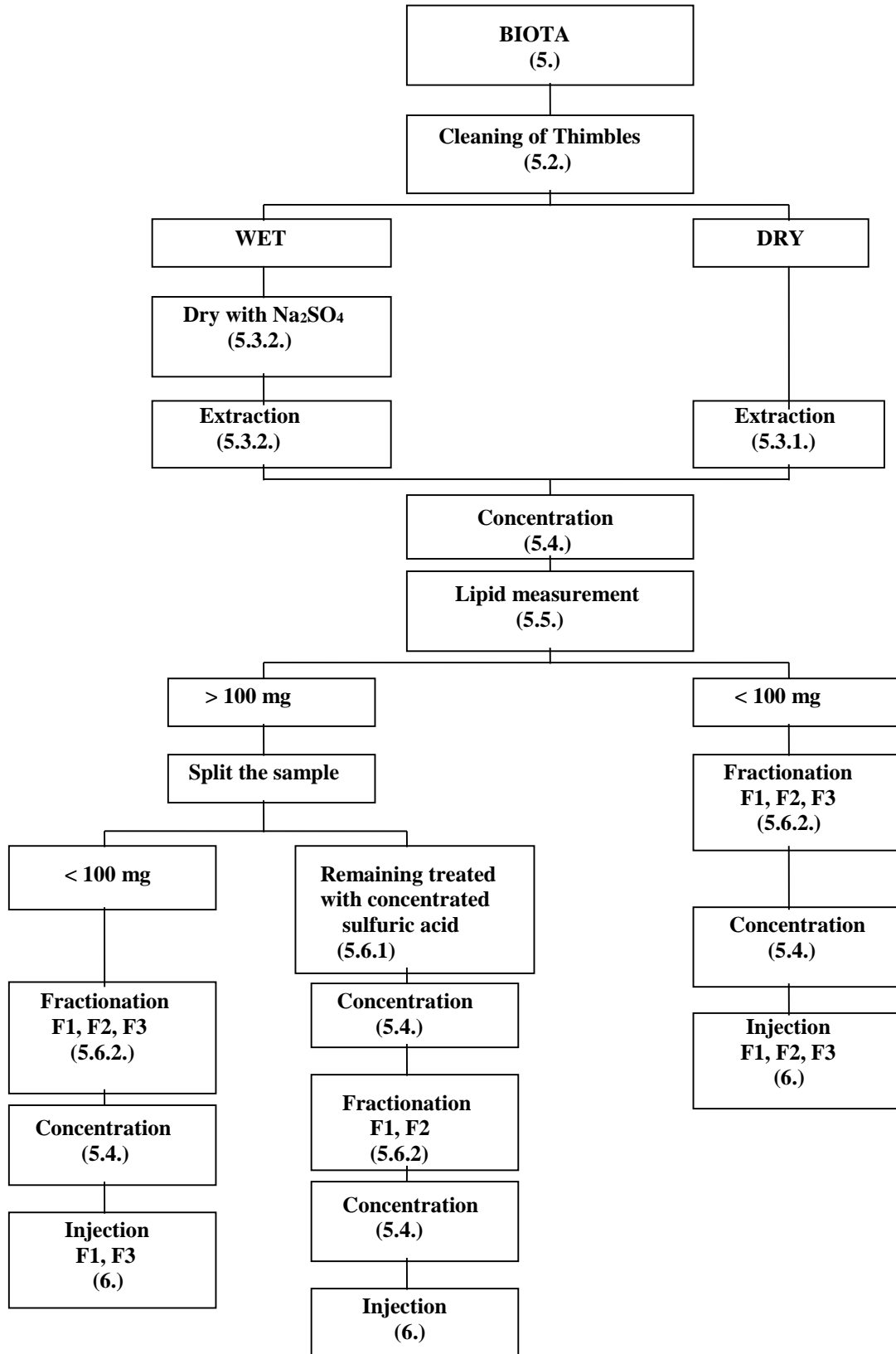

Figure 3: Diagram of the extraction procedure for biota samples.

5.3. Extraction of tissues

5.3.1. Extraction procedure for freeze-dried samples.

Take a 50 to 100 g fresh weight sub-sample from the sample. Weigh this sub-sample and freeze-dry it. When the sub-sample appears to be dry, re-weigh it and freeze-dry it for a further 24 hours and then re-weigh it. If the difference between the two dry weights is greater than 5%, continue the freeze-drying process. Special care must be taken to ensure that the freeze-drier is clean and does not contaminate the samples. The freeze drying procedure should be tested by drying 100 g Na₂SO₄ as a blank and extracting this as a sample. Pulverise the freeze-dried sub-sample carefully using a cleaned pestle and mortar. Accurately weigh about 5 to 10 g of this pulverised material, note the exact weight to be extracted, and place it into a pre-cleaned extraction thimble in a Soxhlet apparatus. The size of the sub-sample should be adjusted so that about 100 mg of extractable organic matter ("lipid") will be obtained. Smaller sub-samples should be used if residue concentrations are expected to be high. Add a known amount of internal standard to the sub-sample in the thimble before Soxhlet extraction. It is important to spike the sample at levels that are near to that of the analyte concentrations in the samples. If, in the end, the analyte and the internal standard concentrations do not fall within the established calibration range of the GC-ECD, the analysis must be repeated. Consequently, it may be advisable to perform range-finding analysis for samples of unknown character beforehand. Candidate internal standards are the same as for sediment samples (see 5.3.). Add about 200 ml of hexane or petroleum ether to the extraction flask with a few carborundum boiling chips, and extract the sample for 8 hours cycling the solvent through at a rate of 4 to 5 cycles per hour. Extract an empty thimble as a procedural blank, making sure to spike it with internal standards in the same fashion as the sample. If unacceptable procedural blanks are found, the source of contamination must be identified and eliminated rather than subtracting high blank values from the analytical results.

5.3.2. Extraction procedure without freeze-drying

Select a 25 to 100 g fresh weight sub-sample and place in a blender. Add anhydrous sodium sulphate to the sample, manually homogenise and determine whether the sample is adequately dried. If not, more sodium sulphate should be added until a dry mixture is obtained. Normally, 3 times by the sample weight used should be enough. Once this has been achieved, blend the mixture at high speed for 1 or 2 minutes until the mixture is well homogenised and the sample appears to be dry. Transfer the mixture to a pre-cleaned extraction thimble, add internal standards as described above and extract the dehydrated tissue with about 200 ml hexane or petroleum ether for 8 hours in a Soxhlet apparatus, cycling 4 to 5 times per hour. Extract the same amount of sodium sulphate as the procedural blank, making sure to add internal standards in the same fashion as the sample.

5.4. Concentration of the extract

Refer to section (4.4.)

5.5. Extractable Organic Matter (EOM)

Refer to section (4.5.)

5.6. Clean-up procedure and fractionation

5.6.1. Removal of lipids by concentrated sulphuric acid

If the lipid content of the extracts is higher than 100-150 mg, a preliminary step for the removal of the lipids is necessary before further sample purification. This can be carried out by using concentrated sulphuric acid. Treatment with sulphuric acid is used when chlorinated hydrocarbons are to be determined. However, sulphuric acid will destroy dieldrin and endrin so that an aliquot of the untreated extract must be set aside for the determination of these compounds.

CAUTION: During all this procedure it is very important to wear safety glasses.

Take an aliquot of the concentrated extract, containing about 200 mg of “lipids”, transfer into a separatory funnel and add to this extract enough hexane in order to dilute the sample (40 to 50 ml should be enough), this will allow recovery of the hexane after acid treatment, because if the sample is too concentrated, the destroyed “lipids” will become almost solid and it will be difficult then to recover the hexane from this solid mass. Add 5 ml concentrated sulphuric acid to the extract and tightly fit the glass stopper and shake vigorously. Invert the funnel and carefully vent the vapours out through the stopcock. Repeat this procedure for several minutes. Place the separatory funnel in a rack and allow the phases to separate. Four or five samples and a spiked blank are convenient to process at one time. The extract should be colourless. Recover the hexane phase into a glass beaker. Dry with sodium sulphate and transfer the hexane into a Kuderna-Danish concentrator. Reduce the volume of the extract by evaporating the solvent with a gentle stream of pure nitrogen to about 1 ml.

5.6.2. Fractionation

Refer to section (4.6.2.)

6. CAPILLARY GAS CHROMATOGRAPHIC DETERMINATIONS

6.1. Gas chromatographic conditions

- Gas chromatograph with a split/splitless injection system, separate regulation system for inlet and column pressures and temperatures; multi-ramp temperature programming facilities (preferably microprocessor controlled), electron capture detector interfaced with the column with electronic control unit and pulsed mode facilities. An integrator with a short response time (0.25 s) is essential.
- Narrow-bore (0.22 mm internal diameter), 25 m long, fused silica open tubular column, coated with SE-54 (0.17 µm film thickness, preferably chemically bonded) with sufficient resolution to separate the relevant peaks in the standards provided for PCB analysis.
- Carrier gas should be high purity H₂. If this is not available or if the GC is not equipped with a special security system for hydrogen leak, He may be used. Gas purification traps should be used with molecular sieves to remove oxygen, moisture and other interfering substances.
- High purity nitrogen gas (99.995 %) as ECD make-up gas can be used (Argon/methane high purity gas is another option).

Conditions:

- H₂ or He carrier gas at inlet pressure of 0.5 to 1 Kg/cm² to achieve a flow rate of 1 to 2 ml/min.
- Make-up gas N₂ or Ar/CH₄ at the flow rate recommended by the manufacturer (between 30 and 60 ml/min.).
- ECD temperature: 300°C

6.2. Column preparation

Fused silica columns are the columns of choice for their inertness and durability (they are extremely flexible). They are made of material that is stable up to 360 °C. The 5 % phenyl methyl silicone gum (SE-54) liquid phase, is present as a thin, (0.17 µm), uniform film which can tolerate temperatures up to 300 °C. SE-54 is relatively resistant to the detrimental effects of solvents, oxygen and water, at least at low temperatures. These columns are even more resistant and durable if the liquid phase is chemically bonded to the support by the manufacturer.

For GC/MS work, it is advised to restrict the film thickness to 0.17 µm because with thicker films some of the phase could be released, resulting in an increase of the noise signal in the GC/MS.

The flexible fused silica columns can be conveniently connected directly to the inlet and outlet systems without the transfer lines used in conventional glass capillary chromatography which often lead to increased dead volume. Low bleed graphite or vespel ferrules provide a good seal.

The presence of extraneous peaks and elevated baseline drift will result in poor detector performance. This can be caused by components which elute from the column, such as residual solvents and low molecular weight liquid phase fractions on new columns and build-up of later eluting compounds on old columns. Conditioning is a necessary step to remove these contaminants. New columns are connected to the inlet (while left unconnected to the detector). Columns are flushed with carrier gas at low temperature for 15 min. to remove the oxygen, then heated at 70-100 °C for 30 min. and finally at 170 °C overnight. The column can be then connected to the detector. Old columns can be heated directly to elevated temperatures overnight. The final temperature is selected as a compromise between time required to develop a stable baseline and expected column life. Thus, it may be necessary for older columns to be heated to the maximum temperature of the liquid phase resulting in shorter column life. The temperature of the ECD, when connected to the column, should always be at least 50 °C higher than the column, in order to avoid condensation of the material onto the detector foil. It is essential that carrier gas flows through the column at all times when at elevated temperatures. Even short exposure of the column to higher temperature without sufficient flow will ruin the column.

CAUTION: if H₂ is used as a carrier gas, position the column end outside of the oven to avoid explosion risk.

6.3. Column test

When the column has been connected to the detector, the carrier gas flow is set to 30 ml per minute for a column with 4 mm internal diameter. The column performance is then measured according to the criteria of the “number of theoretical plates” for a specific compound and can be achieved according to the following procedure.

- Set injector and detector temperatures at 200 and 300°C respectively and the column oven temperature at 180 °C.
- Inject pp’ DDT standard and measure the retention time (Tr). Adjust the column temperature to get a pp’ DDT retention time relative to Aldrin of 3.03.
- Measure the width of the pp’ DDT peak at its half height ($b_{1/2}$), in minutes and the retention time (Tr) also in minutes.
- Calculate the number of theoretical plates using the formula:

$$N = 5.54 \left(\frac{Tr}{b_{1/2}} \right)^2$$

- A parameter which is independent of the column length is the height equivalent to a theoretical plate (HETP):

$$HEPT = \frac{L}{N}$$

Where L is the column length. Adjust the flow rate of the carrier gas to obtain optimum performance. The HETP should be as low as possible (i.e. the number of theoretical plates should be as great as possible).

The column remains in optimum condition as long as the liquid phase exists as a thin, uniform film. The quality of the film at the inlet side may be degraded as a result of repeated splitless

injections. Decreased column quality may be remedied by the removal of the end of the column (10 to 20 cm) at the inlet side. Chemically bonded liquid phases require less maintenance.

6.4. Electron capture detector

High-energy electrons, emitted by a radioactive source within the detector (e.g. a ^{63}Ni foil), are subject to repeated collisions with carrier gas molecules, producing secondary electrons. These electrons, upon returning to their normal state, can be captured by sample molecules, eluting from a GC column. The resulting reduction in cell current is the operating principle of an electron capture detector. The detector current produced is actually a non-linear function of the concentration of electron-capturing material. However, the useful linear range of an ECD may be greatly improved if the instrument is operated at a constant current, but in a pulsed mode, i.e. with short voltage pulses being applied to the cell electrodes. The current in the cell is kept constant by varying the frequency of the pulses.

Contamination of the detector (and thus lower sensitivity) may result from high-boiling organic compounds eluting from the column. Periodic heating to 350°C may overcome this problem. The ^{63}Ni ECD can be used at 320°C under normal operational conditions, in order to limit such contamination.

The optimum flow for an ECD (30 to 60 ml/min.) is much higher than carrier gas flow through the column of one or two ml/min. Thus an additional detector purge flow is necessary (N_2 or Ar/CH_4). Once leaving the outlet of the column, the compounds have to be taken up into an increased gas flow in order to avoid extra-volume band broadening within the detector. Thus, the detector purge flow also serves as the sweep gas.

6.5. Quantification

The most widely used information for identification of a peak is its retention time, or its relative retention time (i.e., the adjusted retention time relative to that of a selected reference compound). Retention behaviour is temperature dependent and comparison of retention times obtained at two or more temperatures may aid in determining a peak's identity. However, retention times are not specific and despite the high resolution offered by capillary columns, two compounds of interest in the same sample may have identical retention times.

One way of using retention indexes could be to inject di-n-alkyl-phthalates such as a mixture containing di-n-methyl-phthalate, di-n-ethyl-phthalate, di-n-propyl-phthalate, di-n-butyl-phthalate, di-n-hexyl-phthalate and di-n-heptyl-phthalate, which will cover the elution range from 70°C to 260°C . An arbitrary index of 100 is given to the di-n-methyl phthalate, 200 to the di-n-ethyl phthalate, and so on up to 700 to the di-n-heptyl phthalate; it is possible to identify all chlorinated pesticides by a proper retention index. This will be used also for unknown compounds which can be found easily on the GC/MS using the same index and so, identified. (Villeneuve J.P. 1986).

PCBs represent a complex mixture of compounds that cannot all be resolved on a packed column. Also there is no simple standard available for their quantification. Each peak in a sample chromatogram might correspond to a mixture of more than one individual compound. These difficulties have led to the recommendation of various quantification procedures. The usual method to quantify PCBs is to compare packed-column chromatograms of commercially available industrial formulations (Aroclors, Clophens, Phenoclor) with the sample chromatogram. Most commonly, it is possible to match one single formulation, such as Aroclor 1254 or Aroclor 1260 with the sample chromatogram. An industrial formulation (or mixture of formulations) should be chosen to be as close a match as possible and in the case of sample extracts from sediment or organisms, Aroclor 1254 and Aroclor 1260 are most frequently chosen.

For the second fraction obtained on Florisil separation, it is possible to quantify DDTs after comparison with the retention times of peaks in the sample chromatogram to those in the corresponding standard, the peak heights (or peak areas) are measured and related to the peak height (or peak area) in the standard according to the formula:

$$[\text{Concentration}] = \frac{h \times C \times V \times 1000}{h' \times V(\text{inj}) \times M \times R} \text{ ng/g (or pg/g)}$$

Where:

- V = total extract volume (ml)
- M = weight of sample extracted (g)
- H = peak height of the compound in the sample
- h' = peak height of the compound in the standard
- C = quantity of standard injected (ng or pg)
- V (inj) = volume of sample injected (µl)
- R = Recovery of the sample

7. COMPUTERIZED GAS CHROMATOGRAPHY/MASS SPECTROMETRY (GC/MS)

7.1. Operating conditions

The chemical ionisation source of a mass spectrometer can be used to produce negative ions by electron capture reactions (CI-NI-MS) using a non-reactive enhancement gas such as methane or argon. CI-NI has the advantage of being highly selective, permitting the detection of specific compounds in complex matrices. Under CI-NI conditions, methane (99.99 %) is used as the reagent gas. Samples are introduced through a SE-54, 30 m x 0.25 mm i.d., fused silica column. The film thickness used is 0.17 µm in order to minimise the bleeding of the phase into the system. Helium is used as carrier gas with an inlet pressure of 13 psi, which gives a carrier flow of 1.5 ml/min. or a gas velocity of 44 cm/sec.

The temperature of the injection port is held at 250°C.

The temperature of the source is set at 240°C, the quadrupole at 100°C and the interface at 285°C.

Injections of 1-3 µl are made in the splitless mode.

The temperature programme of the oven starts at 70°C, for 2 minutes, then it is increased at 3°C/min. to 260°C and kept under isothermal conditions for 40 minutes.

File : C:\HPCHEM\1\DATA\AR1254.D
Operator : jpv
Acquired : 12 Jul 95 8:02 am using AcqMethod OC
Instrument : 5989B
Sample Name: standard ar1254
Misc Info :
Vial Number: 1

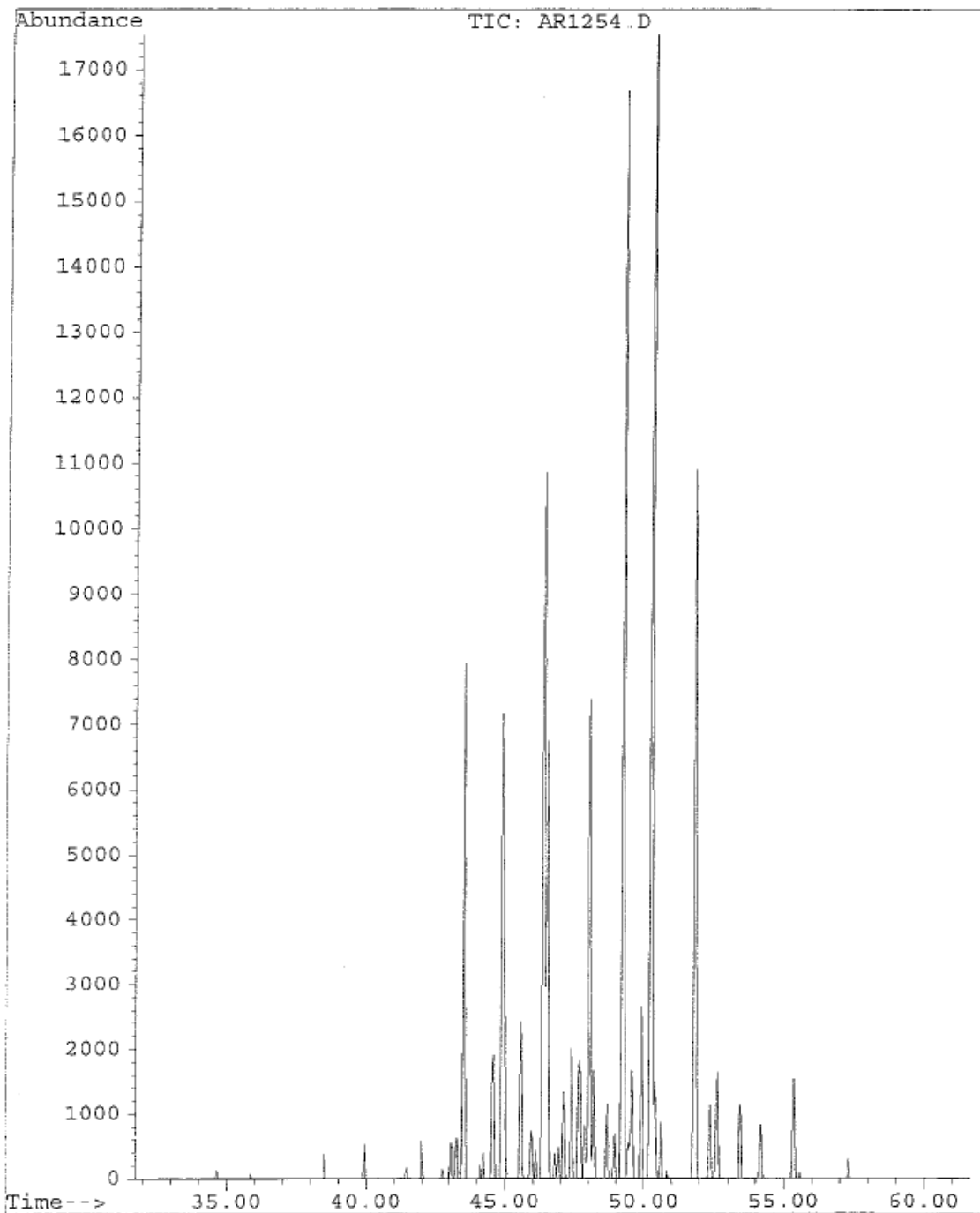

Figure 4: TIC of Aroclor 1254

File : C:\HPCHEM\1\DATA\AR1254.D
Operator : jpv
Acquired : 12 Jul 95 8:02 am using AcqMethod OC
Instrument : 5989B
Sample Name: standard ar1254
Misc Info :
Vial Number: 1

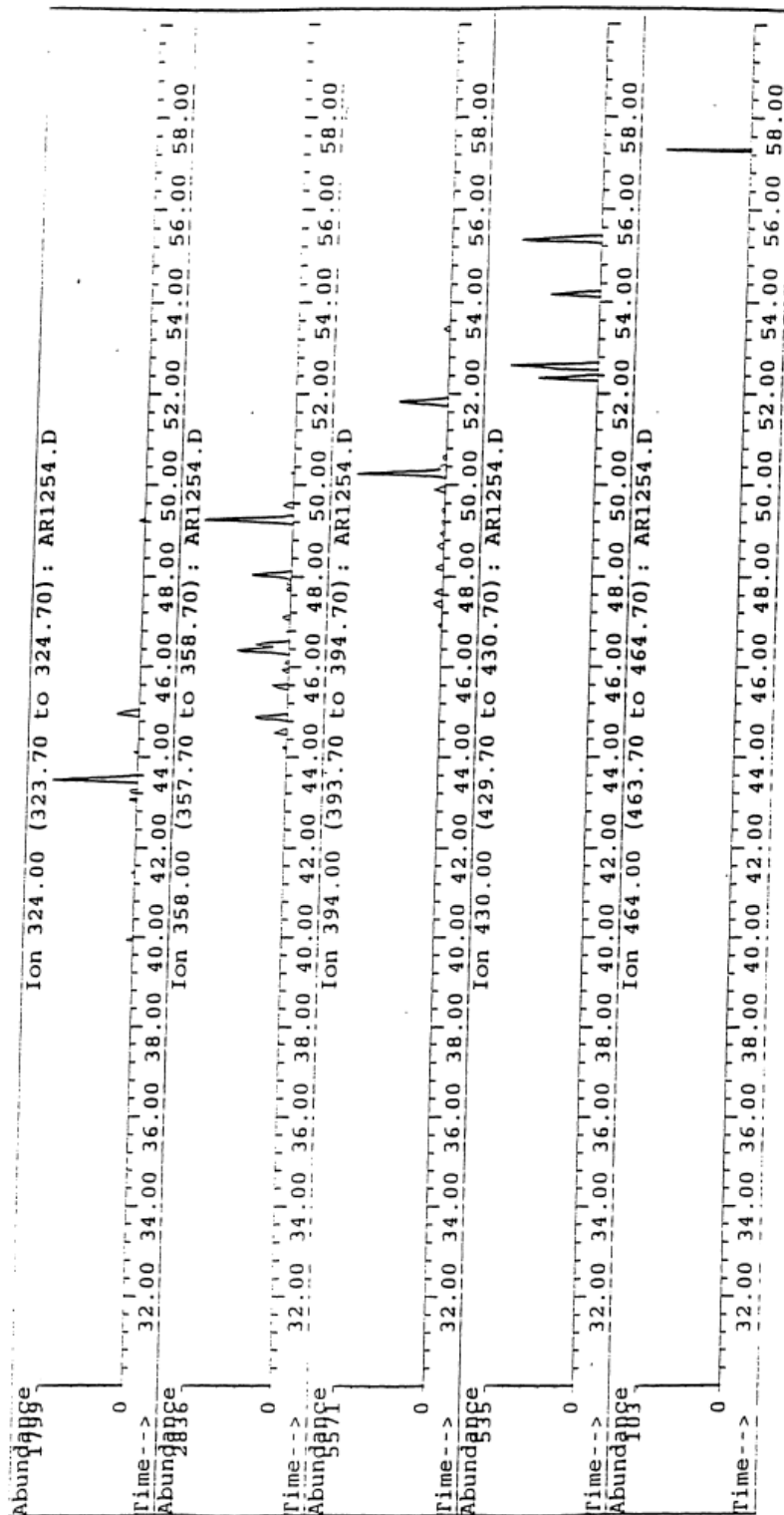

Figure 5: RIC of Aroclor 1254 main compounds

File : C:\HPCHEM\1\DATA\AR1260.D
Operator : jpv
Acquired : 12 Jul 95 9:42 am using AcqMethod OC
Instrument : 5989B
Sample Name: standard ar1260
Misc Info :
Vial Number: 1

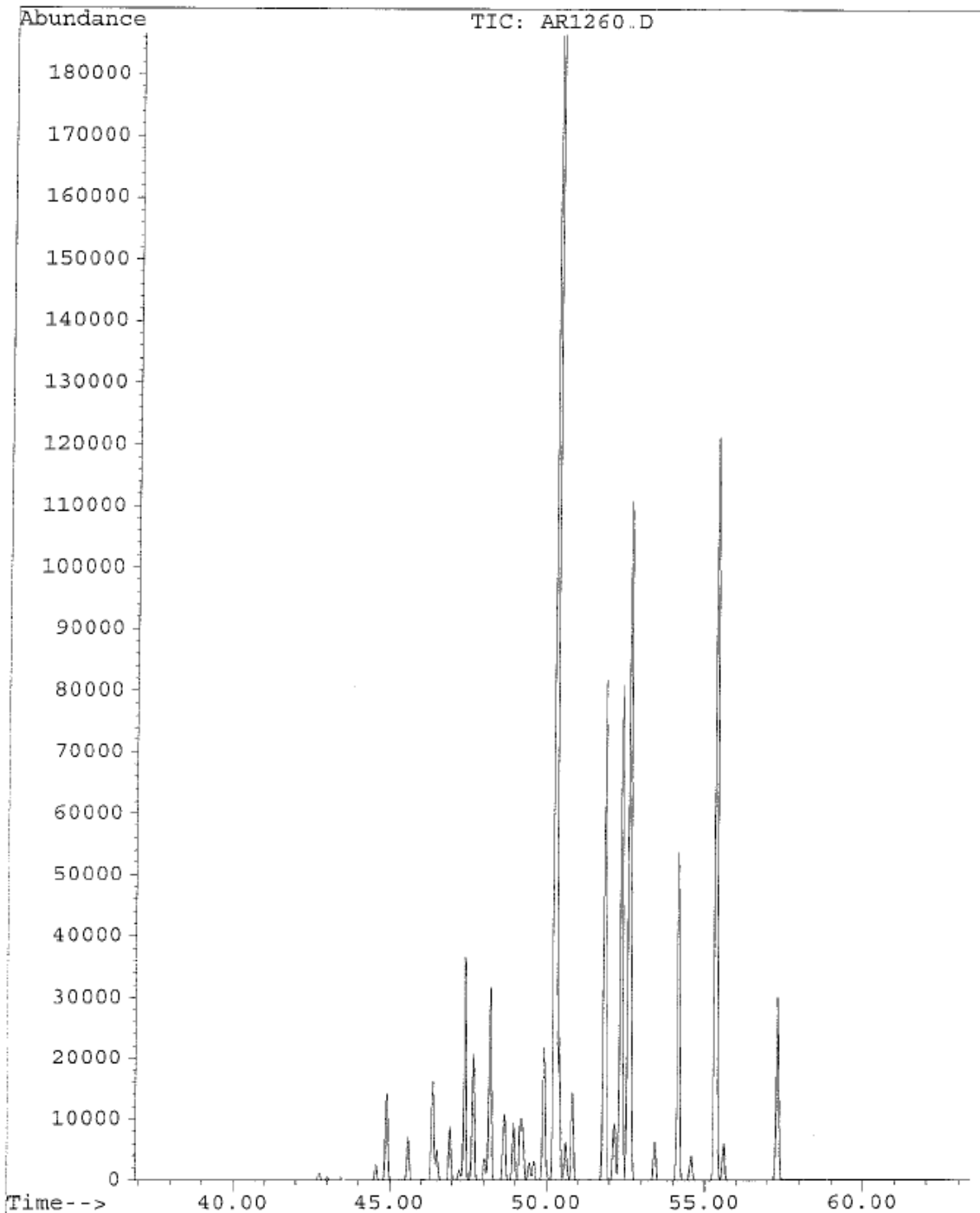

Figure 6: TIC of Aroclor 1260

File : C:\HPCHEM\1\DATA\AR1260.D
 Operator : jpv
 Acquired : 12 Jul 95 9:42 am using AcqMethod OC
 Instrument : 5989B
 Sample Name: standard ar1260
 Misc Info :
 Vial Number: 1

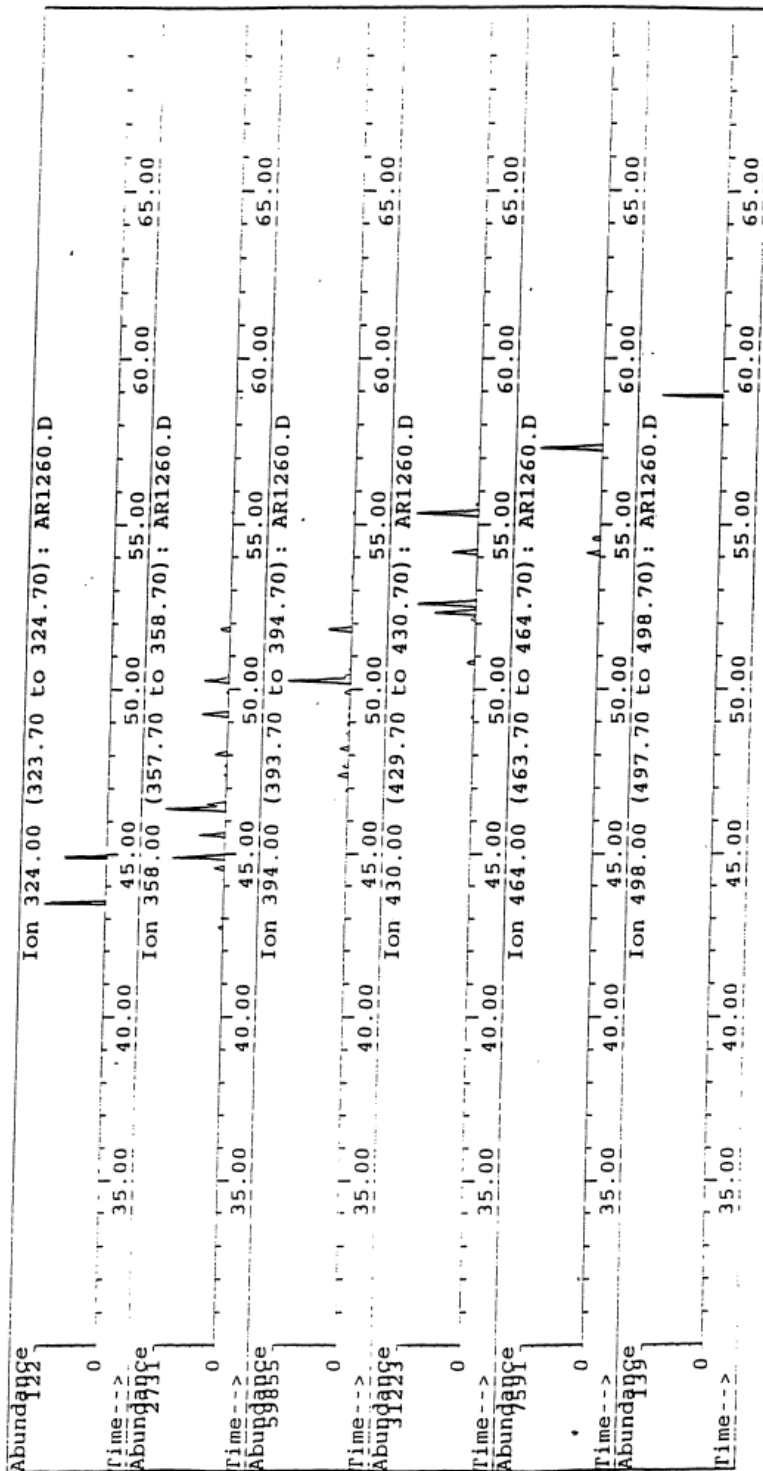

Figure 7: RIC of Aroclor 1260 main compounds

7.2. Example of a selected ion monitoring programme useful for quantitative analysis of chlorinated compounds.

Compounds	Fraction N° on Florisil	Retention Time (min.)	Target Ion (daltons)
HCB	1	37-38	284
Heptachlor	1	44-45	266
Aldrin	1	46-48	237
op DDE	1	51-53	246
Transnonachlor	1	52-54	444
pp' DDE	1	53-55	281
PCBs			
3 Cl	1		258
4 Cl	1		292
5 Cl	1	40-55	324
6 Cl	1	40-55	358
7 Cl	1	45-55	394
8 Cl	1	45-60	430
9 Cl	1	50-60	464
10 Cl	1	58-60	498
α HCH	2	37-39	255
β HCH	2	39-41	255
γ HCH (Lindane)	2	39-41	255
δ HCH	2	41-43	255
γ Chlordane	2	51-53	410
α Chlordane	2	52-54	266
op DDD	2	54-56	248
pp' DDD	2	56-58	248
op DDT	2	56-58	246
pp' DDT	2	58-60	283
Heptachlor epoxide	3	49-51	318
α Endosulfan	3	52-54	406
Dieldrin	3	53-55	346
Endrin	3	55-57	346
β Endosulfan	3	55-57	406
Endosulfan sulfate	3	58-60	386

8. NOTES ON WATER ANALYSIS

The levels of lipophilic compounds in tissues of aquatic organisms and organic fractions of sediments are determined to a large extent by the levels of these compounds in the surrounding water (marine mammals are an obvious exception). Data for CBs and hydrocarbons in sea water is therefore extremely useful for an understanding of the levels in organisms. However, the levels in sea water are extremely low and consequently, their determination needs considerable experience. Large volumes of water are required and extreme care has to be taken in order to avoid contamination during sampling, extraction and clean-up of the samples. Details are described in Manual and guide No 27 of IOC, 1993 and Villeneuve J.P. (1986).

9. ALTERNATIVE PROCEDURES

9.1. Combining sample preparation and extraction for chlorinated and petroleum hydrocarbons in sediment samples.

In the event that analyses for petroleum hydrocarbons and chlorinated compounds (and/or sterols) are of interest, the following extraction procedure can be used. To the freeze-dried sample introduce internal standards for each compound class. The following are suggested: 1) aliphatic hydrocarbons: - n-C₁₄ d₃₀, n-C₁₉ d₄₀, n-C₃₂ d₆₆, 2) polycyclic aromatic hydrocarbons: Naphthalene d₈,

Hexamethylbenzene, Cadalene (deuterated PAHs are also useful), 3) organochlorine compounds: PCB congeners 29, 30, 121 or 198, ϵ HCH and Endosulfan Id₄, 4) sterols: 5 α (H)-androstan-3 β -ol. These standards are used for quantifying the recovery of the total procedure. Samples are Soxhlet extracted for 8 hours with 250 ml of a mixture hexane / dichloromethane (50:50), cycling the solvent through at a rate of 4 to 5 cycles per hour. The solvent extract is concentrated by rotary evaporation down to 15 ml and transferred to a Kuderna-Danish tube. It is then further concentrated down to 5-6 ml under nitrogen gas. Following removal of sulphur and water, the extract is separated into aliquots: 1/3 for petroleum hydrocarbons and sterols and 2/3 for chlorinated hydrocarbons.

Note: Mercury method should be used only if chlorinated pesticides and PCBs are analysed. If the combined method is used for petroleum and chlorinated hydrocarbons, then the copper method should be used instead of mercury that will destroy some of the PAHs.

9.2. Supercritical fluid extraction (SFE) of marine samples

Sample preparation is probably the most time-consuming and labor-intensive analytical task performed in a laboratory. Studies shows that 60 % of the overall sample analysis time is spent in sample preparation which is the main source of error and of contamination. In addition, the amount of hazardous chemicals used for sample preparation is a continuous source of concern. Due to safe handling and disposal requirements, the reduction of their use is a priority for laboratories worldwide.

Supercritical fluids are gases (i.e. N₂O and CO₂) at room temperature and pressures above the critical point. The SFE technique allows an efficient extraction of a variety of contaminants with considerable reduction in the analysis cost, sample amount and allows the extraction of the thermal sensitive substances, reducing the amount of environmentally hazardous solvents.

A small change in the pressure of a supercritical fluid results in a big change in its density and the solvent strength of the fluid changes with changing density. As a result, one supercritical fluid easily performs the work of many solvents. If this is not enough, it is possible to add a modifier, such as methanol (a few per cent) to increase the solvating range of the fluid. Therefore, SFE should speed up the sample preparation process, minimising the wastes associated with the analysis.

Until now, the main fields of analytical applications of SFE are related to environmental studies and to the food-processing industry (Hawthorne, 1990, Bayona, 1993). A method using carbon dioxide (80°C-340 atm) for the extraction of total petroleum hydrocarbons has been approved as an EPA standard method. The extraction efficiency of modified CO₂ for the recovery of 41 organochlorine and 47 organophosphorus pesticides spiked on sand at different pressures and temperatures were higher than 80%. Furthermore, by increasing the extraction temperature up to 200°C, PCBs and PAHs can be extracted from naturally occurring samples with neat CO₂. Nam *et al.* (1991), have developed a method for rapid determination of polychlorinated organics in complex matrices. The method is based on direct coupling of supercritical fluid extraction with tandem supercritical fluid chromatography and gas chromatography. The on-line system permits simultaneous extraction and analysis with high reproducibility and accuracy.

**Selection guide for CO₂ extraction of common pollutants
 (from Hewlett-Packard)**

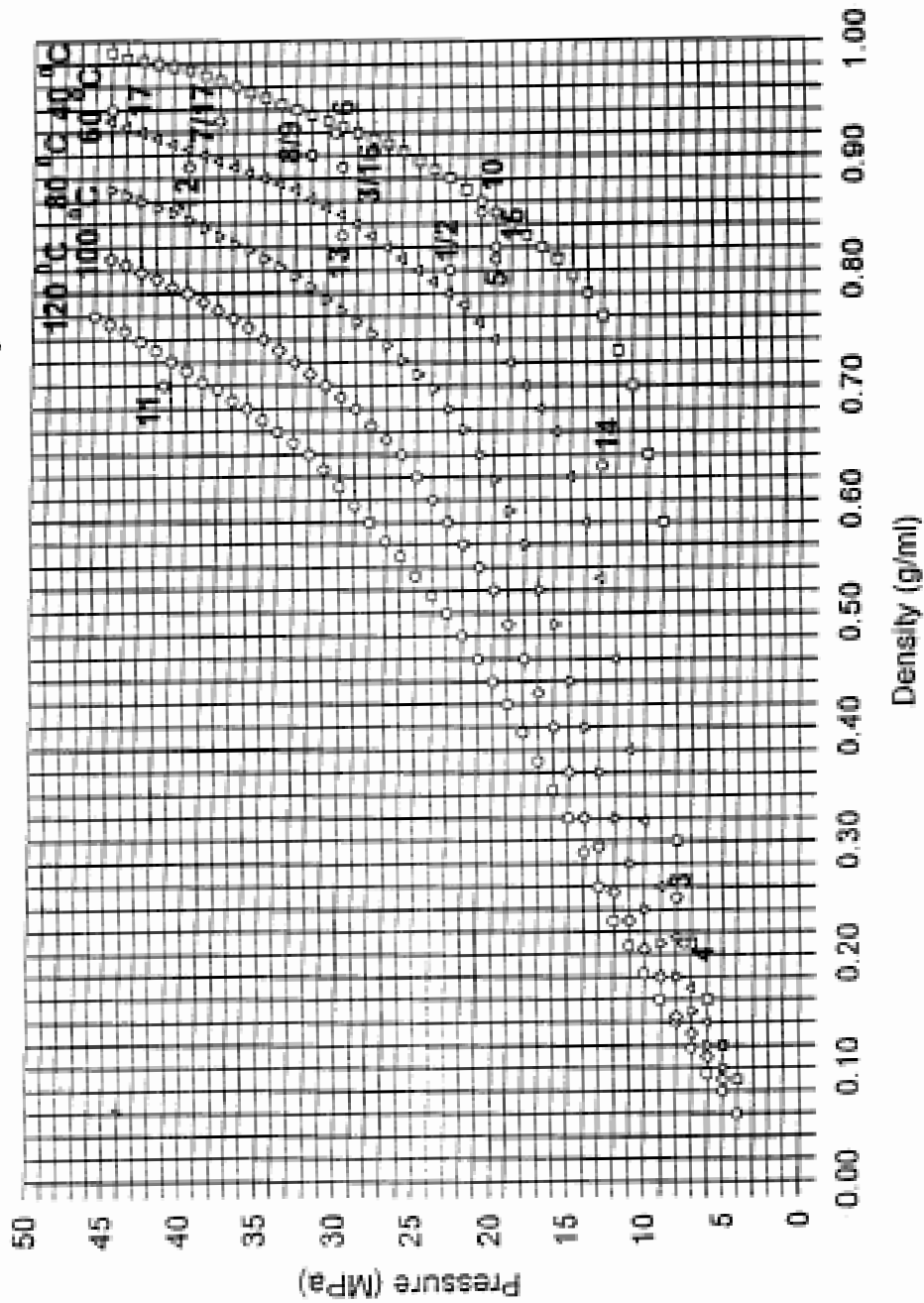

Figure 8: Guide for CO₂ extractions

9.3. Microwave assisted extraction for marine samples

9.3.1 Sediment

Another alternative method for the extraction of chlorinated hydrocarbons in sediment samples (or combined extraction for chlorinated hydrocarbons and petroleum hydrocarbons) is the use of the Microwave oven instead of the Soxhlet extractor. The main advantage of the microwave oven is the fact that, for one sample, only 40 ml of solvent mixture are used instead of 250 ml for clean-up of extraction thimbles and 250 ml for the extraction itself.

10 to 15 grams of freeze-dried sediment sample, ground and sieved at 250 µm, are put in the glass tube of the reactor. Appropriate internal standards (for OCs and/or PHs, see 10.1.) are added to the sample for recovery and samples are extracted with 40 ml of a mixture of hexane / dichloromethane (50:50).

Extraction is realised within the following cycle:

- Power of the microwaves: 1200 watts
- Temperature increase to 115 °C in 10 minutes.
- Extraction maintained at 115 °C for 30 minutes
- Cooling to ambient temperature within one hour.

The carousel containing 14 reactors, 12 samples could be extracted together with one blank and one Reference Material within 1 and half hour and with 10 times less solvent mixture than the standard Soxhlet extraction.

After cooling down to room temperature the solvent mixture is recovered in a 100 ml glass flask. The sediment is poured in a glass funnel containing a plug made of glass wool. The extracted sediment is washed with 10 - 20 ml of hexane. The extract follows then the procedure of clean-up and fractionation.

9.3.2 Biota

3 to 8 grams of freeze-dried biota sample is accurately weighted, the weight to be extracted is noted, and it is placed into the pre-cleaned glass tube of the reactor. A known amount of internal standard is added to the sub-sample in the tube before extraction. Candidate internal standards are the same than for sediment samples refers to section (5.3.1.)

Extraction is realized with 30 ml of a mixture hexane / acetone (90:10) within the following cycle:

- Power of the microwaves: 1200 watts
- Temperature increase to 115 °C in 10 minutes.
- Extraction maintained at 115 °C for 20 minutes
- Cooling to ambient temperature within one hour.

The carousel containing 14 reactors, 12 samples could be extracted with one blank and one Reference Material within 1 and half hour and with 10 times less solvent mixture than the standard Soxhlet extraction.

After cooling down to room temperature the solvent mixture is recovered in a 100 ml glass flask. The powder of biota is poured in a glass funnel containing a plug made of glass wool. The extracted biota is washed with 10 - 20 ml of hexane. The extract is then concentrated with rotary evaporator and ready for E.O.M, clean-up and fractionation procedure.

10. DATA INTERPRETATION

10.1. DDT

The residence time of total DDT in the environment is relatively short ($t_{1/2} = 3-5$ years), so, at least 75-80 % of the current total DDT should be in the form of DDE or DDD if it was introduced into the environment before the 1975 ban. Values of Henry's law constant indicate that these compounds can reach the troposphere as vapour. These vapours are little adsorbed by airborne particulate matter and represent the major component in atmospheric chlorinated hydrocarbon levels. Vapour movements of these pollutants suggest that restrictions and regulations operating in the more technically advanced countries could only be partially effective on a worldwide basis.

The presence of the *op* DDT together with anomalous *pp'* DDT values in environmental samples indicates a recent treatment with this insecticide.

10.2. PCBs congeners

Among the 209 possible PCB congeners, seven of them: 28, 52, 101, 118, 138, 153 and 180, were selected as the most relevant because of their distribution in the chromatogram and in the chlorination range.

Recently, attention has been paid to congeners having 2 para-chlorines and at least 1 meta-chlorine. These congeners are called "coplanar" PCBs. Among the 209 congeners, 20 members attain coplanarity due to non-ortho chlorine substitution in the biphenyl ring. Three of these show the same range of toxicity as the 2,3,7,8 tetrachlorodibenzo-p-dioxin and the 2,3,7,8 tetrachlorodibenzofuran, these are the IUPAC N^o: 77, 126 and 169. These compounds should be identified and quantified in the environmental samples with high priority. They can be separated using fractionation with carbon chromatography (Tanabe *et al.*, 1986).

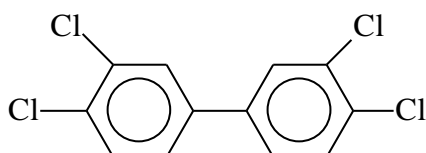

3,3',4,4' tetrachlorobiphenyl
IUPAC N^o: 77

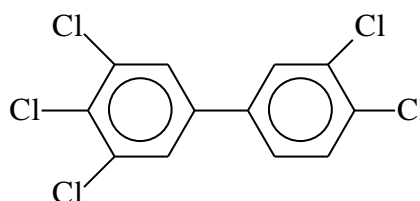

3,3',4,4',5 pentachlorobiphenyl
IUPAC N^o: 126

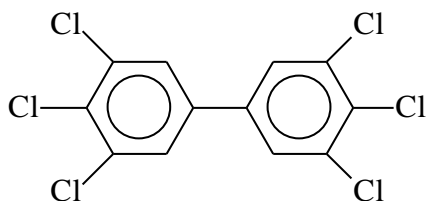

3,3',4,4',5,5' hexachlorobiphenyl
IUPAC N^o: 169

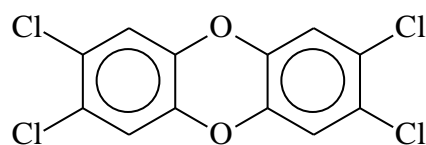

2,3,7,8 tetrachlorodibenzo-p-dioxin

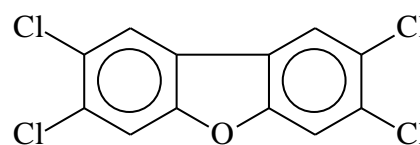

2,3,7,8 tetrachlorodibenzofuran

10.3. Typical profiles of commercial mixtures

Formulations available in different countries are slightly different in their composition (Aroclor in USA, Kanechlor in Japan, Clophen in Germany, Phenoclor in France, Fenclor in Italy or Sovol in Russia). For the same global composition, such as Aroclor 1254, KC-500 or Phenoclor DP-5, the composition of individual congeners differs by 5-10 %. If a sample is collected on the French coast (therefore, contaminated with DP-5), and is quantified with DP-5 and Aroclor 1254, the difference observed in concentration could be in the order of 5-10 %. This shows the importance of choosing one common standard for the quantification of global industrial formulations or the importance of quantifying with individual congeners.

Percent contribution of individual chlorobiphenyls to Clophen A 50 and Aroclor 1254.

PCB N°	Clophen A50	Aroclor 1254	PCB N°	Clophen A50	Aroclor 1254
17	0	0.19	115	0.28	0.3
18	0	0.41	118	10.9	6.39
28	0.05	0.25	119	0.19	0.14
31	0.05	0.22	122	0.19	0.5
33	0.11	0.14	123	0.85	0.81
40	0.28	0.2	126	0.08	0
41	0.83	0.64	128	3.04	2.07
42	0.13	0.23	129	0.83	0.23
44	2.46	2.03	130	0.83	0.63
47	0.18	0.11	131	0.06	0.16
48	0.17	0.14	132	2.57	1.98
49	1.96	1.64	134	0.52	0.49
52	5.53	5.18	135	1.61	1.62
53	0.06	0.09	136	0.91	1.12
56	0.44	0.58	137	0.25	0.25
60	0.34	0.54	138	3.61	3.2
63	0.15	0.05	141	0.98	1.04
64	0.71	0.45	146	0.8	0.83
66	0.5	0.59	149	4.5	2.21
67	0.13	0.09	151	1.22	1.17
70	3.85	3.21	153	4.17	4.26
74	1.35	0.78	156	1.43	1.62
82	1.05	0.95	157	0.31	0
83	0.53	0.45	158	0.98	0.77
84	2.08	1.95	167	0.35	0.21
85	1.85	1.66	170	0.65	0.31
87	4.22	3.78	171	0.5	0.5
90	0.85	0.93	172	0.09	0.05
91	0.92	0.83	173	0.09	0.09
92	1.53	1.58	174	0.37	0.34
95	6	6.02	175	0.11	0.05
96	0.05	0.08	176	0.43	0.32
97	2.8	2.55	177	0.21	0.21
99	4.06	3.6	178	0.19	1.35
100	0.15	0.1	179	0.2	0.21
101	7.72	7.94	180	0.53	0.38
105	1.9	3.83	183	0.21	0.17
107	0.94	0.72	187	0.3	0.32
110	6.27	5.85	190	0.05	0.08
			201	0.6	0.68

11. QUALITY ASSURANCE / QUALITY CONTROL

Guidelines on the QA/QC requirements for analysis of sediments and marine organisms are detailed in Reference Method No 57, "Contaminant monitoring programs using marine organisms: Quality assurance and good laboratory practice". Brief descriptions of issues that must be addressed in the course of understanding the procedures described here are given below.

11.1. Precision

The precision of the method should be established by replicate analysis of samples of the appropriate matrix. Estimate the precision of the entire analytical procedure by extracting five sub-samples from the same sample after homogenisation. Alternatively, perform replicate analysis of an appropriate certified reference material (RM; see below) containing the analytes of interest. The principal advantage of using a RM is that the material permits the simultaneous evaluation of accuracy while offering a well homogenised sample. Precision should be evaluated as a matter of course during the initial implementation procedure just before initiation of sample analysis.

11.2. Accuracy

The accuracy of the methods described here must be confirmed by analysis of a suitable RM (i.e. appropriate matrix, analytes) prior to initiation of sample analysis. Agreement between measured and certified concentrations for any individual analyte should be within 35 % and on average within 25%. It is advisable to introduce RMs on a regular basis (e.g. every 10-20 samples) as a method of checking the procedure. Further description of the preparation of control charts and criteria for data acceptance are discussed in Reference Method N° 57.

11.3. Blanks

Blanks represent an opportunity to evaluate and monitor the potential introduction of contaminants into samples during processing. Contributions to the analyte signal can arise from contaminants in the reagents, those arising from passive contact between the sample and the environment (e.g. the atmosphere) and those introduced during sample handling by hands, implements or glassware. It is essential to establish a consistently low (i.e. with respect to analytes) blank prior to initiating analysis or even the determination of the method detection limit. In addition, it is necessary to perform blank determinations on a regular basis (e.g. every batch of samples).

11.4. Recovery

Recovery reflects the ability of the analyst to fully recover surrogate compounds introduced to the sample matrix or blank at the beginning of the procedure. The primary criteria for selection of compounds to be used for testing recovery are that they: 1) have physical (i.e. chromatographic/partitioning) properties similar to and if necessary spanning those of the analytes of interest, 2) do not suffer from interferences during gas chromatographic analysis, 3) are baseline resolved from the analytes of interest.

Recovery should be tested on all samples and blanks as a routine matter of course. Recoveries below 70% are to be considered unacceptable. Recoveries in excess of 100 % may indicate the presence of interference.

11.5. Archiving and reporting of results

Every sample should have an associated worksheet which follows the samples and the extracts through the various stages of the procedure and upon which the analyst notes all relevant details. An example of such a worksheet is given below. Each laboratory should construct and complete such a worksheet. Relevant chromatograms should be attached to the worksheet. Analyses should be grouped

and composite or summary analysis sheets archived with each group. Final disposal of the data will depend on the reasons for which it was collected but should follow the overall plan model.

All processed samples should be archived at all steps of the procedure:

- deep frozen (in the deep-freezer as it was received).
- freeze-dried (in sealed glass container kept in a dark place).
- extracted (after injection on the GC, sample extracts should be concentrated down to 1 ml and transferred into sealed glass vials, a Pasteur pipette sealed with a butane burner is adequate and cheap).

Sample: IAEA-357 : Marine Sediment

wet wt.

----- =, % water in freeze dried sample determined by drying at 105°C :
dry wt.

.....g freeze-dried wt. extracted with hexane in Soxhlet extractor for 8 hours.

.....pg PCB N°29,pg PCB N°198,pg ϵ HCH and pg Endosulfan Id₄ were added as internal standard.

Theml extract was reduced by rotary evaporator to approximatelyml.

This was treated with sodium sulfate to dry the extract. Then treated with mercury to remove sulphur. This was further reduced toml for lipid determinations. Corrected dry wt. :g.

Lipid determinations:

.....ml total extract;

10 μ l aliquots weighed on micro-balance:mg;mg;mg.

HEOM =mg/g dry weight.

.....mg lipid subjected to column chromatography fractionation on Florisil.

F1:ml hexane

F2:ml hexane/dichloromethane (70:30)

F3:ml dichloromethane

GC determinations:

PCB N°29 :ng recovered in F1 :% Recovery.

PCB N°198 :ng recovered in F1 :% Recovery.

ϵ HCH :ng recovered in F2 :% Recovery.

Endosulfan Id₄:ng recovered in F3 :% Recovery.

Attach tabulation of individual compounds quantified in sample.

Sample worksheet for analysis of chlorinated compounds in marine sediments.

12. REFERENCES

- Bayona, J.M. (1993). The role of supercritical fluid extraction in sample preparation. *Robotics Lab. Autom.* 5, 156-187.
- Eganhouse, R.P. and Kaplan, I.R. (1988). Depositional history of recent sediments from San Pedro shelf, California: Reconstruction using elemental abundance, isotopic composition and molecular markers. *Mar. Chem.*, 24 (2), 163-191.
- Eisenreich, S.J., Capel, P.D., Robbins, J.A. and Bourbonniere, R. (1989). Accumulation and diagenesis of chlorinated hydrocarbons in lacustrine sediments. *Environ. Sci. and Technol.*, 23, 1116-1126.
- Ericksson, M.D. (1986). *Analytical Chemistry of PCBs*, Butterworth, Stonehaus, 149-153.
- Fernandez, P., Porte, C., Barcelo, D., Bayona, J.M. and Albaiges, J. (1988). Selective enrichment procedures for the determination of polychlorinated biphenyls and polycyclic aromatic hydrocarbons in environmental samples by gel permeation chromatography. *J. Chromatogr.* 456, 155-164.
- Fernandez, P. and Bayona, J.M. (1992). Use of off-line gel permeation chromatography - normal phase liquid chromatography for the determination of polycyclic aromatic compounds in environmental samples and standard reference materials (air particulate matter and marine sediment). *J. Chromatogr.*, 625, 141-149.
- Hawthorne, S.B. (1990). Analytical-scale supercritical fluid extraction, *Anal. Chem.*, 62, 633A-642A.
- Hom, W., Risebrough, R.W., Soutar, A. and Young, D.R. (1974). Deposition of DDE and polychlorinated biphenyls in dated sediments of the Santa Barbara basin. *Science*, 184, 1197-1199.
- Langenfeld, J.J., Hawthorne, S.B., Miller, D.J. and Pawliszyn, J. (1993). Effects of temperature and pressure on supercritical fluid extraction efficiencies of polycyclic aromatic hydrocarbons and polychlorinated biphenyls. *Anal. Chem.* 65, 338-344.
- Lee, M.L., Novotny, M.V. and Bartle, K.D. (1981), in *Analytical Chemistry of Polycyclic Aromatic Compounds*, Academic Press, New York, 143-152.
- Lopez-Avila, V., Dohiwala, N.S. and Beckert, W.F. (1990). "Supercritical fluid extraction and its applications to environmental analysis. *J. Chromatogr. Sci.* , 28, 468-79.
- Lopez-Avila, V., Benedicto, J., Dohiwala, N.S., Young, R. and Beckert, W.F. (1992). Development of an off-line SFR-IR method for petroleum hydrocarbons in solids. *J. Chromatogr. Sci.*, 30, 335-343.
- Manuals and Guides No 27. IOC (1993).**
- Nam, K.S., Kapila, S., Yanders, A.F. and Puri, R.K. (1991). A multiple sample extraction and on-line system for the analysis of chlorinated compounds. *Chemosphere*, 23, 1109-1116.
- Petrick, G., Schulz, D.E. and Duinker, J.C. (1988). Clean-up of environmental samples by high-performance liquid chromatography for analysis of organochlorine compounds by gas chromatography with electron-capture detection. *J. Chromatogr.*, 435, 241-248.
- Reference Method No 6, UNEP/FAO/IOC/IAEA: Guidelines for monitoring chemical contaminants in the sea using marine organisms. UNEP, 1993.
- Reference Method No 12 Rev.2, UNEP/FAO/IAEA/IOC: Sampling of selected marine organisms and sample preparation for the analysis of chlorinated hydrocarbons. UNEP, 1991.
- Reference Method No 20, UNEP/IOC/IAEA: Determination of petroleum hydrocarbons in sediments. UNEP, 1992.
- Reference Method No 57, UNEP/IOC/IAEA/FAO: Contaminant monitoring programme using marine organisms: Quality assurance and good laboratory practice. UNEP, 1990.

Reference Method No 58: Guidelines for the use of sediments for marine pollution monitoring programmes. (in preparation).

Reference Method No 65, UNEP/IOC/IAEA: Reagent and laboratory ware clean-up procedures for low-level contaminants monitoring. (in preparation).

Tanabe, S., Kannan, N., Wakimoto, T. and Tatsukawa, R. (1986). Method for the determination of three toxic non-ortho-chlorine substituted co-planar PCBs in environmental samples at part-per-trillion levels. Intern. J. Environ. Anal. Chem. Vol. 29, 199-213.

UNEP (DEC)/MED WG.282/Inf.5/Rev1: Methods for sediment sampling and analysis (2006).

Villeneuve, J.P. (1986). Géochimie des composés organochlorés dans l'environnement marin. Thèse de Doctorat de l'Université Paris VI. 180 pages.

ANNEX

**PREPARATION OF THE SOLUTION OF INTERNAL STANDARDS:
PCB No 29, PCB No 198, ϵ HCH and Endosulfan I d4**

Stock Solution of PCB No 29:

1 ml from the original vial (250ng/ μ l) should be transferred into a 100 ml volumetric flask, and then the volume is adjusted to 100 ml with hexane. This stock solution contains:

2.5 ng/ μ l of PCB No 29

Stock Solution of Endosulfan I d4:

1 ml from the original vial (250ng/ μ l) should be transferred into a 100 ml volumetric flask, and then the volume is adjusted to 100 ml with hexane. This stock solution contains:

2.5 ng/ μ l of Endosulfan I d4

Working solution of internal standards:

0.5 ml from the stock solution of PCB No 29 (2.5 ng/ μ l) should be transferred into a 50 ml volumetric flask, then, 0.5 ml from the stock solution of Endosulfan I d4 (2.5 ng/ μ l) should be transferred into the volumetric flask, then 1 ml from the original vial (1ng/ μ l) of ϵ HCH should be transferred into that volumetric flask, then 0.5 ml from the concentrated solution (2ng/ μ l) of PCB No 198, and the volume adjusted to 50 ml with hexane. This working solution contains:

25 pg/ μ l of PCB No 29

20 pg/ μ l of PCB No 198

20 pg/ μ l of ϵ HCH

25 pg/ μ l of Endosulfan I d4

CAUTION: VIALS SHOULD BE COOLED AT 20°C PRIOR TO OPENING

Preparation of the Aroclor 1254 solution

Preparation of the stock solution:

1 ml from the original vial should be transferred into a 100 ml volumetric flask, then, the volume is adjusted to 100 ml with hexane. This stock solution contains:

6.5 ng/μl of Aroclor 1254

Preparation of the working solution:

1 ml from this stock solution should be transferred into a 50 ml volumetric flask and the volume adjusted to 50 ml with hexane. This working solution contains :

0.13 ng/μl of Aroclor 1254

CAUTION : VIAL SHOULD BE COOLED TO 20 °C PRIOR TO OPENING

Preparation of the Aroclor 1260 solution

Preparation of the stock solution:

1 ml from the original vial should be transferred into a 100 ml volumetric flask, then the volume is adjusted to 100 ml with hexane. This solution contains:

5.44 ng/μl of Aroclor 1260

Preparation of the working solution:

1 ml from the stock solution should be transferred into a 50 ml volumetric flask, then the volume is adjusted to 50 ml with hexane. This working solution contains

0.1088 ng/μl of Aroclor 1260

CAUTION: VIAL SHOULD BE COOLED TO 20 °C PRIOR TO OPENING

Preparation of the pp' DDE, pp' DDD and pp' DDT solution

pp' DDE:

Stock solution: 1 ml from the original vial should be transferred into a 100 ml volumetric flask, then the volume is adjusted to 100 ml with hexane. This stock solution contains:

5 ng/μl of pp' DDE

pp' DDD:

Stock solution: 1 ml from the original vial should be transferred into a 100 ml volumetric flask, then the volume is adjusted to 100 ml with hexane. This solution contains:

5 ng/μl of pp' DDD

pp' DDT:

Stock solution: 1 ml of the original vial should be transferred into a 100 ml volumetric flask, then the volume is adjusted to 100 ml with hexane. This stock solution contains:

5 ng/μl of pp' DDT

Working solution: pp' DDE, pp' DDD and pp' DDT together.

1 ml from the stock solution of pp' DDE, 2 ml of the stock solution of pp' DDD and 3 ml of the stock solution of pp' DDT should be transferred into a 100 ml volumetric flask and the volume adjusted to 100 ml with hexane. This solution contains

- pp' DDE : 50 pg/μl
- pp' DDD : 100 pg/μl
- pp' DDT : 150 pg/μl

NOTE: Further dilution may be necessary depending on the sensitivity of the EC Detector.

CAUTION: VIAL SHOULD BE COOLED TO 20 °C PRIOR TO OPENING

Preparation of Aldrin, Dieldrin and Endrin standard solutions:

Aldrin:

Stock solution: 1 ml from the original vial should be transferred into a 100 ml volumetric flask, then the volume is adjusted to 100 ml with hexane. This solution contains:

5 ng/μl of Aldrin

Dieldrin:

Stock solution: 1 ml from the original vial should be transferred into a 100 ml volumetric flask, then the volume is adjusted to 100 ml with hexane. This solution contains:

5 ng/μl of Dieldrin

Endrin:

Stock solution: 1 ml from the original vial should be transferred into a 100 ml volumetric flask, then the volume is adjusted to 100 ml with hexane. This solution contains:

5 ng/μl of Endrin

Working solution: Aldrin, Dieldrin and Endrin together.

1 ml from the stock solution of Aldrin, 1 ml from the stock solution of Dieldrin and 1 ml from the stock solution of Endrin are transferred into a 100 ml volumetric flask and the volume is adjusted to 100 ml with hexane. This working solution contains:

Aldrin : 50 pg/μl
Dieldrin : 50 pg/μl
Endrin : 50 pg/μl

NOTE: Further dilution may be necessary depending on the sensitivity of the detector.

CAUTION: VIALS SHOULD BE COOLED TO 20 °C PRIOR TO OPENING

Preparation of the HCB and Lindane standard solutions:

HCB:

Stock solution: 1 ml from the original vial should be transferred into a 100 ml volumetric flask, then the volume is adjusted to 100 ml with hexane. This solution contains:

5 ng/μl of HCB

Lindane:

Stock solution: 1 ml from the original vial should be transferred into a 100 ml volumetric flask, then the volume is adjusted to 100 ml with hexane. This solution contains:

5 ng/μl of lindane

Working solution:

1 ml from the stock solution of HCB and 1 ml from the stock solution of Lindane are transferred into a 100 ml volumetric flask, then the volume is adjusted to 100 ml with hexane. This solution contains:

HCB : 50 pg/μl

Lindane : 50 pg/μl

NOTE: further dilution may be necessary depending on the sensitivity of the EC Detector.

CAUTION: VIALS SHOULD BE COOLED TO 20 °C PRIOR TO OPENING

Preparation of the PCB congeners solution

In a 100 ml volumetric flask, transfer 1 ml from the original vial. Adjust to 100 ml with hexane in order to obtain the working solution with the following concentrations:

CB N°:	Compounds:	Concentrations (pg/μl)
8	2,4'	17.50
18	2,2',5	12
31	2,4',5	10.6
28	2,4,4'	4.6
52	2,2',5,5'	8.6
49	2,2',4,5'	12.1
44	2,2',3,5'	10.7
66	2,3',4,4'	5.5
95	2,2',3,5',6	5.7
101	2,2',4,5,5'	9.3
110	2,3,3',4',6	11.1
149	2,2',3,4',5',6	12.1
118	2,3',4,4',5	8.5
153	2,2',4,4',5,5'	8.4
138	2,2',3,4,4',5'	13.8
183	2,2',3,4,4',5',6	10.3
174	2,2',3,3',4',5,6'	9.4
177	2,2',3,3',4',5,6	9.5
180	2,2',3,4,4',5,5'	16.3
170	2,2',3,3',4,4',5	13.4
199	2,2',3,3',4,5,5',6'	9.3
194	2,2',3,3',4,4',5,5'	12.6

Separate into 10 volumetric flasks of 10 ml, seal with Teflon tape and keep in refrigerated place in order not to evaporate them.

CAUTION: VIAL SHOULD BE COOLED TO 20 °C PRIOR TO OPENING

EUNOCI 221-02937-0, E05 SED @ BHIMADZU

14:241	15.223	15.961	17.859	19.88	21.880	21.728	22.598	25.850	27.665	48.812	48.873	44.546	45.661	50.523	8	54.133	18	56.927	31	58.927	28	52.791	52	68.927	49	62.227	44	62.877	66 + 95	68.511	101	68.326	110	71.267	118	72.791	153	74.828	183	76.194	174	78.194	177	80.298	170	82.178	199	84.751	194	86.664
--------	--------	--------	--------	-------	--------	--------	--------	--------	--------	--------	--------	--------	--------	--------	---	--------	----	--------	----	--------	----	--------	----	--------	----	--------	----	--------	---------	--------	-----	--------	-----	--------	-----	--------	-----	--------	-----	--------	-----	--------	-----	--------	-----	--------	-----	--------	-----	--------

Issued and printed by

Oceans and Coastal Areas Programme Activity Centre
United Nations Environment Programme

Additional copies of this and other publications issued by
the Oceans and Coastal Areas Programme Activity Centre
can be obtained from:

Oceans and Coastal Areas Programme Activity Centre
United Nations Environment Programme
P.O. Box 30552
Nairobi
Kenya

Or from:

Marine Environmental Studies Laboratory
International Atomic Energy Agency
Environment Laboratories
4 Quai Antoine 1^{er}
98000 MONACO

Annex XV:

HELCOM

**Manual for marine monitoring in the COMBINE programme
ANNEX B-12, APPENDIX 3. TECHNICAL NOTE ON THE DETERMINATION OF
CHLORINATED BIPHENYLS AND ORGANOCHLORINE PESTICIDES IN BIOTA**

HELCOM Manual for marine monitoring in the COMBINE programme

ANNEX B-12, APPENDIX 3. TECHNICAL NOTE ON THE DETERMINATION OF CHLORINATED BIPHENYLS AND ORGANOCHLORINE PESTICIDES IN BIOTA

1. INTRODUCTION

The analysis of chlorinated biphenyls (CBs) and organochlorine pesticides (OCPs) in fish samples generally involves extraction from the respective matrix with organic solvents, followed by clean-up and gas chromatographic separation with electron capture (GC-ECD) or mass spectrometric (GC-MS) detection.

The analytical procedure is liable to systematic errors due to insufficiently optimized gas chromatographic conditions, determinant losses (evaporation, unsatisfactory extraction yield), and/or contamination from laboratory ware, reagents and the laboratory environment. It is therefore essential that the sources of systematic errors are identified and eliminated as far as possible.

In the following paragraphs, the guidelines drafted by the OSPAR Ad Hoc Working Group on Monitoring (OSPAR, 1996) have been taken into consideration.

2. PRE-TREATMENT OF LABORATORY WARE AND REAGENTS; CONTAMINATION CONTROL

Glassware, reagents, solvents, column adsorption materials and other laboratory equipment that come into contact with the sample material to be analysed should be free of impurities that interfere with the quantitative determination of CBs and OCPs.

For cleaning purposes, the following procedures should be followed:

1. Glassware should be thoroughly washed with detergents, dried with acetone and rinsed with a non-polar solvent such as *n*-pentane, and heated to > 100 °C prior to use.
2. Glass fibre Soxhlet thimbles should be pre-extracted with an organic solvent. The use of paper Soxhlet thimbles should be avoided. Alternatively, glass fibre thimbles or full glass Soxhlet thimbles, with a G1 glass filter at the bottom, are recommended.
3. Solvents should be checked for impurities using GC after concentrating the volume normally used in the procedure to 10 % of the final volume. If necessary, solvents can be purified by controlled re-distillation and rectification over KOH in an all-glass distillation column.
4. Reagents and column adsorption materials should be checked for contamination before use by extraction with an organic solvent (e.g., *n*-pentane) and analysis by GC, using the detector which will also be used for the final determination (ECD or MS).
5. Laboratory air can also be contaminated with CBs, OCPs or compounds interfering with the CB/OCP analysis. A good estimation of the contamination of the air can be found by placing a petri dish with 2 grams of C18-bonded silica for two weeks in the laboratory. After this period, the material is transferred to a glass column and eluted with 10 ml of 10% diethylether in hexane. After concentrating the eluate, the CB concentrations can be measured. Absolute amounts of <1 ng show that the contamination of the air is at an acceptably low level in that laboratory (Smedes and de Boer, 1994).

3. SAMPLE PRETREATMENT

To ensure complete extraction of the lipophilic CBs and OCPs from biological sample matrices, it is essential to dry the material and disrupt the cell walls of the biological matrix to be analysed. This can be achieved by Ultra Turrax mixing or grinding of the sample with a dehydrating reagent, such as Na₂SO₄, followed by multiple solid/liquid extraction with a mixture of polar and non-polar solvents (e.g., acetone/hexane or methanol/dichloromethane). It is essential to allow complete binding of the water present in the sample with the dehydrating reagent (this requires at least several hours) prior to starting the extraction step. The extraction efficiency must be checked for different types and amounts of biological matrices to be investigated (see 'recovery section').

4. CLEAN-UP

The crude extract obtained from sample pretreatment requires a clean-up in order to remove co-extracted lipophilic compounds that interfere with the gas chromatographic determination of CBs and OCPs. Normal-phase solid/liquid chromatography, using deactivated Al₂O₃ or deactivated silica as adsorbents and hexane or iso-octane as solvents, is an appropriate technique for the separation of the determinands from lipids or other interfering compounds. Effective removal of high molecular weight compounds can be achieved by gel permeation chromatography (GPC). However, GPC does not separate CBs from other compounds in the same molecular range, such as organochlorine pesticides (OCPs). Therefore, additional clean-up may be required. Treatment of the OCP fraction with concentrated H₂SO₄ can improve the quality of the subsequent gas chromatogram. However, this treatment is not recommended if determinands of the dieldrin type or heptachloroepoxides, which are easily broken down by H₂SO₄, are to be determined.

5. DETERMINATION BY GAS CHROMATOGRAPHY

Because of the large number of organochlorine compounds to be determined, high resolution gas chromatography (GC) using, preferably narrow bore, fused silica wall-coated open-tubular (capillary) columns is necessary.

Carrier gas

Hydrogen is the preferred carrier gas and is indispensable for columns with very small inner diameters. For safety reasons, hydrogen should not be used without a safety module which is able to check for small hydrogen concentrations inside the GC oven coming from possible leakages. As a compromise to safety aspects, helium is also acceptable.

Columns

In order to achieve sufficient separation, capillary columns should have a length of >60 m, an internal diameter of < 0.25 mm (for diameters below 0.18 mm the elevated pressure of the carrier gas needs special instrumentation) and a film thickness of the stationary phase of < 0.25 µm. For routine work, the SE 54 (Ultra 2, DB 5, RTx 5, CP-Sil 8) phase (94 % dimethyl-, 5 % phenyl-, 1 % vinyl-polysiloxane) or medium polar columns (CP-Sil 19, OV-17, OV 1701, DB 17) have been shown to give satisfactory chromatograms. A second column with a stationary phase different, from that used in the first column, may be used for confirmation of the peak identification.

Injection

Splitless and on-column injection techniques may both be used. Split injection is not recommended because strong discrimination effects may occur. Other techniques such as temperature-programmed or pressure-programmed injection may have additional advantages, but should be thoroughly optimized before use.

In splitless injection, the volume of the liner should be large enough to contain the gas volume of the evaporated injected solvent. If the liner is too small, memory effects can occur due to contamination of the gas tubing attached to the injector. Very large liner volumes, in contrast, can cause a poor transfer of early eluting components.

A 1 µl injection normally requires a ca. 1 ml liner. The occurrence of memory effects should be tested by injection of iso-octane after analysis of a CB or OCP standard. The use of a light packing of silylated glass wool in the liner improves the response and reproducibility of the injection. However, some organochlorine pesticides such as DDT may disintegrate when this technique is used. In splitless injection, discrimination effects can occur.

The splitless injection time should therefore be optimized to avoid discrimination. This can be done by injecting a solution containing an early-eluting and a late-eluting CB, e.g., CB28 and CB180. Starting with a splitless injection time of 0.5 minutes, the peak height of the late-eluting compound will presumably increase relative to that of the first compound. The optimum is found at the time when the increase does not continue any further. The split ratio is normally set at 1:25 and is not really critical. The septum purge, normally approximately 2 ml min⁻¹, should be stopped during injection. This option is not standard in all GCs.

Due to the variety of on-column injectors, a detailed optimization procedure cannot be given. More information on the optimization of on-column parameters may be obtained from Snell *et al.* (1987).

The reproducibility of injection is controlled by the use of an internal standard not present in the sample.

Detector

Quantitative analysis is performed by comparing the detector signal produced by the sample with that of defined standards. The use of an electron capture detector (ECD) sensitive to chlorinated compounds or - more generally applicable - a mass selective detector (MSD) or (even) a mass spectrometer (MS) is essential.

Due to incomplete separation, several co-eluting compounds can be present under a single detector signal. Therefore, the shape and size of the signal have to be critically examined. With a MSD or MS used as detector, either the molecular mass or characteristic mass fragments should be recorded for that purpose. If only an ECD is available, the relative retention time and the signal size should be confirmed on columns with different polarity of their stationary phases, or by the use of multi-dimensional GC techniques (de Boer *et al.*, 1995; de Geus *et al.*, 1996).

Calibration

Stock solutions of individual organohalogen compounds should be prepared using iso-octane as the solvent and weighed solid individual standard compounds of high purity (> 99 %). Stock solutions can be stored in measuring flasks in a refrigerator or in a dessicator with a saturated atmosphere of iso-octane, but losses can easily occur, particularly when storing in refrigerators (Law and de Boer, 1995). Loss of solvents in stock solutions can be controlled by recording the weight and filling up the missing amount before a new aliquot is taken. However, aliquots stored in sealed glass ampoules are much more appropriate and can normally be stored for several years. Fresh stock standard solutions should be prepared in duplicate and compared with the old standard solutions. Working standards should be prepared gravimetrically from stock solutions for each sample series. All manipulations with solvents, including pipetting, diluting and concentrating, should preferably be checked by weighing. Due to day-to-day and season-to-season temperature differences in laboratories and due to the heating of glassware after cleaning, considerable errors can be made when using volumetric glassware as a basis for all calculations.

The GC should be calibrated before each batch of measurements. Since the ECD has a non-linear response curve, a multilevel calibration is strongly advised. Megginson *et al.* (1994) recommend a set of six standard solutions for CB determination or five standard solutions for OCP determination. Standards used for multilevel calibration should be regularly distributed over the sample series, so that matrix and non-matrix containing injections alternate. When concentrations of compounds in the sample fall outside either side of the calibration curve, a new dilution or concentrate should be made and the measurement repeated. Considerable errors can be made when measuring concentrations which fall outside the calibration curve.

For MS detection, a multi-level calibration is also recommended.

Recovery

For the purpose of determining recovery rates, an appropriate internal standard should be added to each sample at the beginning of the analytical procedure. The ideal internal standard is a CB which is not present in the sample and which does not interfere with other CBs. All 2,4,6-substituted CB congeners are, in principle, suitable. Alternatively, 1,2,3,4-tetrachloronaphthalene or the homologues of dichloroalkylbenzylether can be used. For GC with mass selective detection (GC-MSD), ¹³C-labelled CBs must be used as internal standards. With GC/MS, ¹³C-labelled CBs should preferably be used as internal standards.

6. REFERENCES

- de Boer, J., and Dao, Q.T. 1991. Analysis of seven chlorobiphenyl congeners by multidimensional gas chromatography. *Journal of High Resolution Chromatography*, 14: 593-596.
- de Boer, J., Dao, Q.T., Wester, P.G., Bøwadt, S., and Brinkman, U.A.Th. 1995. Determination of mono-*ortho* substituted chlorobiphenyls by multidimensional gas chromatography and their contribution to TCDD equivalents. *Analytica Chimica Acta*, 300: 155-165.
- de Geus, H.-J., de Boer, J., and Brinkman, U.A.Th. 1996. Multidimensionality in gas chromatography. *Trends in Analytical Chemistry*, 15: 398-408.
- Law, R.J., and de Boer, J. 1995. Quality assurance of organic compounds in marine matrices: application to analysis of chlorobiphenyls and polycyclic aromatic hydrocarbons. *In Quality assurance in environmental monitoring*, pp. 129-155. Edited by Ph. Quevauviller. VCH, Weinheim, Germany.
- Megginson, C., McKenzie, C., and Wells, D. 1994. Practical steps to improve the quality control of the chromatography for chlorobiphenyl and organochlorine pesticide analysis. *Marine Pollution Bulletin*, 29: 228-234.
- OSPAR. 1996. Ad Hoc Working Group on Monitoring (MON). Draft JAMP Biota Monitoring Guidelines. Doc. MON 96/9/1, Annex 5. OSPAR Commission, London, UK.
- Smedes, F., and de Boer, J. 1994. Guidelines for the determination of chlorobiphenyls in sediments. *Quimica Analytica*, 13: S100-S108.
- Snell, R.P., Danielson, J.W., and Oxborrow, G.W. 1987. Parameters affecting the quantitative performance of cold on-column and splitless injection systems used in capillary gas chromatography. *Journal of Chromatography Science*, 25: 225-230.

Annex XVI:

HELCOM

**Manual for marine monitoring in the COMBINE programme
ANNEX B-12, APPENDIX 2. TECHNICAL NOTE ON THE DETERMINATION OF
POLYCYCLIC AROMATIC HYDROCARBONS IN BIOTA**

HELCOM Manual for marine monitoring in the COMBINE programme

ANNEX B-12, APPENDIX 2. TECHNICAL NOTE ON THE DETERMINATION OF POLYCYCLIC AROMATIC HYDROCARBONS IN BIOTA

1. INTRODUCTION

Polycyclic aromatic hydrocarbons (PAHs) consist of a variable number of fused aromatic rings. By definition, PAHs contain at least three fused rings, although in practice related compounds with two fused rings (such as naphthalene and its alkylated derivatives) are often determined and will be considered in these guidelines. PAHs arise from incomplete combustion processes and from both natural and anthropogenic sources, although the latter generally predominate. PAHs are also found in oil and oil products, and these include a wide range of alkylated PAHs formed as a result of diagenetic processes, whereas PAHs from combustion sources comprise mainly parent (non-alkylated) PAHs. PAHs are of concern in the marine environment for two main reasons: firstly, low-molecular weight (MW) PAHs can be directly toxic to marine animals; secondly, metabolites of some of the high-MW PAHs are potent animal and human carcinogens, benzo[a]pyrene is the prime example. Carcinogenic activity is closely related to structure, however, and benzo[e]pyrene and four benzofluoranthene isomers (all six compounds have a molecular weight of 252 Da) are much less potent. Some compounds (e.g., heterocyclic compounds containing sulphur, such as benzothiophenes and dibenzo-thiophenes) may also cause taint in commercially exploited fish and shellfish and render them unfit for sale. PAHs are readily taken up by marine animals both across gill surfaces and from their diet, and may bioaccumulate, particularly in shellfish. Filter-feeding organisms such as bivalve molluscs can accumulate high concentrations of PAHs, both from chronic discharges to the sea (e.g., of sewage) and following oil spills. Fish are exposed to PAHs both via uptake across gill surfaces and from their diet, but do not generally accumulate high concentrations of PAHs as they possess an effective mixed-function oxygenase (MFO) system which allows them to metabolize PAHs and to excrete them in bile. An assessment of the exposure of fish to PAHs therefore requires also the determination of PAH-metabolite concentrations in bile samples, as turnover times can be extremely rapid. Thus, the analysis of PAHs in fish muscle tissue should normally only be undertaken for food quality assurance purposes (Law and Biscaya, 1994).

There are marked differences in the behaviour of PAHs in the aquatic environment between the low-MW compounds (such as naphthalene; 128 Da) and the high-MW compounds (such as benzo[ghi]perylene; 276 Da) as a consequence of their differing physico-chemical properties. The low-MW compounds are appreciably water soluble and can be bioaccumulated from the "dissolved" phase by transfer across gill surfaces, whereas the high-MW compounds are relatively insoluble and hydrophobic, and can attach to both organic and inorganic particulates within the water column. PAHs derived from combustion sources may actually be deposited to the sea already adsorbed to atmospheric particulates, such as soot particles. The majority of PAHs in the water column will eventually be either taken up by biota or transported to the sediments, and deep-water depositional areas may generally be regarded as sinks for PAHs, particularly when they are anoxic.

2. APPROPRIATE SPECIES FOR ANALYSIS OF PAHS

2.1 Benthic fish and shellfish

All teleost fish have the capacity for rapid metabolism of PAHs, thereby limiting their usefulness for monitoring temporal or spatial trends of PAHs. Shellfish (particularly molluscs) generally

have a lesser metabolic capacity towards PAHs, and so they are preferred because PAH concentrations are generally higher in their tissues.

For the purposes of temporal trend monitoring, it is essential that long time series with either a single species or a limited number of species are obtained. Care should be taken that the sample is representative of the population and that sampling can be repeated annually. There are advantages in the use of molluscs for this purpose as they are sessile, and so reflect the degree of contamination in the local area to a greater degree than fish which are mobile. The analysis of fish tissues is often undertaken in conjunction with biomarker and disease studies, and associations have been shown between the incidence of some diseases (e.g., liver neoplasia) in flatfish and the concentrations of PAHs in the sediments over which they live and feed (Malins et al., 1988; Vethaak and Rheinallt, 1992). The exposure of fish to PAHs can be assessed by the analysis of PAH-metabolites in bile, and by measuring the induction of mixed-function oxygenase enzymes which affect the formation of these metabolites. At offshore locations, the collection of appropriate shellfish samples may be problematic if populations are absent, sparse or scattered, and the collection of fish samples may be simpler. Generally, the analysis of PAHs in fish muscle tissue should only be considered for the purposes of food quality assurance.

Recent monitoring studies have indicated a seasonal cycle in PAH concentrations (particularly for combustion-derived PAHs) in mussels, with maximum concentrations in the winter prior to spawning and minimum concentrations in the summer. It is particularly important, therefore, that samples selected for trend monitoring and spatial comparisons are collected at the same time of year, and preferably in the first months of the year before spawning.

2.2 Fish

Fish are not recommended for spatial or temporal trend monitoring of PAHs, but can be useful as part of biological effects studies or for food quality assurance purposes. The sampling strategy for biological effects monitoring is described in the OSPAR Joint Assessment and Monitoring Programme (JAMP).

3. TRANSPORTATION

Live mussels should be transported to the laboratory for sample preparation. They should be transported in closed containers at temperatures between 5 °C and 15 °C, preferably below 10 °C. For live animals it is important that the transport time is short and controlled (e.g., maximum of 24 hours).

Fish samples should be kept cool or frozen (at a temperature of -20 °C or lower) as soon as possible after collection. Frozen fish samples should be transported in closed containers at temperatures below -20 °C. If biomarker determinations are to be made, then it will be necessary to store tissue samples at lower temperatures, for example, in liquid nitrogen at -196 °C.

4. PRETREATMENT AND STORAGE

4.1 Contamination

Sample contamination may occur during sampling, sample handling, pretreatment and analysis, due to the environment, the containers or packing materials used, the instruments used during sample preparation, and from the solvents and reagents used during the analytical procedures. Controlled conditions are therefore required for all procedures, including the dissection of fish organs on-board a ship (see ANNEX B-13, Appendix 1). In the case of PAHs, particular care must be taken to avoid contamination at sea. On ships there are multiple sources of PAHs, such as the

oils used for fuel and lubrication, and the exhaust from the ship's engines. It is important that the likely sources of contamination are identified and steps taken to preclude sample handling in areas where contamination can occur. A ship is a working vessel and there can always be procedures occurring as a result of the day-to-day operations (deck cleaning, automatic overboard bilge discharges, etc.) which could affect the sampling process. One way of minimizing the risk is to conduct dissection in a clean area, such as within a laminar-flow hood away from the deck areas of the vessel. It is also advisable to collect samples of the ship's fuel, bilge water, and oils and greases used on winches, etc., which can be used as fingerprinting samples at a later date, if there are suspicions of contamination in particular instances.

4.2 Shellfish

4.2.1 Depuration

Depending upon the situation, it may be desirable to depurate shellfish so as to void the gut contents and any associated contaminants before freezing or sample preparation. This is usually applied close to point sources, where the gut contents may contain significant quantities of PAHs associated with food and sediment particles which are not truly assimilated into the tissues of the mussels. Depuration should be undertaken under controlled conditions and in filtered sea water; depuration over a period of 24 hours is usually sufficient. The aquarium should be aerated and the temperature and salinity of the water should be similar to that from which the animals were removed.

4.2.2 Dissection and storage

When samples are processed, both at sea and onshore, the dissection must be undertaken by trained personnel on a clean bench wearing clean gloves and using clean stainless steel knives and scalpels. Stainless steel tweezers are recommended for holding tissues during dissection. After each sample has been prepared, all tools and equipment (such as homogenizers) should be cleaned.

4.3 Fish

4.3.1 Dissection and storage

The dissection of fish muscle and internal organs should be carried as soon as possible after collection. The details of fish muscle and liver dissection are given in ANNEX B-13, Appendix 1. If possible, the entire right side dorsal lateral fillet should be homogenized and sub samples taken for replicate PAH determinations. If, however, the amount of material to be homogenized would be too large, a specific portion of the dorsal musculature should be chosen. It is recommended that the portion of the muscle lying directly under the first dorsal fin is used in this case.

When dissecting the liver, care should be taken to avoid contamination from the other organs. If bile samples are to be taken for PAH-metabolite determinations, then they should be collected first. If the whole liver is not to be homogenized, a specific portion should be chosen in order to ensure comparability. Freeze-drying of tissue samples cannot be recommended for PAH determination, due to the contamination which may result from back-streaming of oil from the rotary pumps used to generate the vacuum.

If plastic bags or boxes are used, then they should be used as outer containers only, and should not come into contact with tissues. Organ samples (e.g., livers) should be stored in pre-cleaned containers made of glass, stainless steel or aluminium, or should be wrapped in pre-cleaned aluminium foil and shock-frozen quickly in liquid nitrogen or in a blast freezer. In the latter case, care should be taken that the capacity of the freezer is not exceeded (Law and de Boer,

1995). Cold air should be able to circulate between the samples in order that the minimum freezing time can be attained (maximum 12 hours). The individual samples should be clearly and indelibly labelled and stored together in a suitable container at a temperature of -20 °C until analysis. If the samples are to be transported during this period (e.g., from the ship to the laboratory), then arrangements must be made which ensure that the samples do not thaw out during transport. Sub samples for biomarker determinations should be collected immediately after death in order to minimize post-mortem changes in enzymatic and somatic activities, and stored in suitable vials in liquid nitrogen until analysis.

When samples are processed, both at sea and onshore, the dissection must be undertaken by trained personnel on a clean bench wearing clean gloves and using clean stainless steel knives and scalpels. Stainless steel tweezers are recommended for holding tissues during dissection. After each sample has been prepared, all tools and equipment (such as homogenizers) should be cleaned.

When pooling of tissues is necessary, an equivalent quantity of tissue should be taken from each fish, e.g., 10 % from each whole fillet.

5. ANALYSIS

5.1 Preparation of materials

Solvents, reagents, and adsorptive materials must be free of PAHs and other interfering compounds. If not, then they must be purified using appropriate methods. Reagents and absorptive materials should be purified by solvent extraction and/or by heating in a muffle oven, as appropriate. Glass fibre materials (e.g., Soxhlet thimbles) are preferred over filter papers and should be cleaned by solvent extraction. It should be borne in mind that clean materials can be re-contaminated by exposure to laboratory air, particularly in urban locations, and so storage after cleaning is of critical importance. Ideally, materials should be prepared immediately before use, but if they are to be stored, then the conditions should be considered critically. All containers which come into contact with the sample should be made of glass, and should be pre-cleaned before use. Appropriate cleaning methods would include washing with detergents, rinsing with water, and finally solvent-rinsing immediately before use. Heating of glassware in an oven (e.g., at 400°C for 24 hours) can also be useful in removing PAH contamination.

5.2 Lipid determination

Although PAH data are not usually expressed on a lipid basis, the determination of the lipid content of tissues can be of use in characterizing the samples. The lipid content should be determined on a separate subsample of the tissue homogenate, as some of the extraction techniques used routinely for PAH determination (e.g., alkaline saponification) destroy lipid materials. The total fat weight should be determined using the method of Smedes (1999) or an equivalent method.

5.3 Dry weight determination

Generally PAH data are expressed on a wet weight basis, but sometimes it can be desirable to consider them on a dry weight basis. Again, the dry weight determination should be conducted on a separate sub sample of the tissue homogenate, which should be air-dried to constant weight at 105 °C.

5.4 Extraction and clean-up

PAHs are lipophilic and so are concentrated in the lipids of an organism, and a number of methods have been described for PAH extraction (see, e.g., Ehrhardt *et al.*, 1991). The preferred methods generally utilize either Soxhlet extraction, or alkaline digestion followed by liquid-liquid extraction with an organic solvent. Microwave-assisted solvent extraction can be mentioned as one of the modern techniques being applied to PAH analysis (Budzinski *et al.*, 2000; During and Gaath, 2000; Vázquez Blanco *et al.*, 2000; Ramil Criado *et al.*, 2002). In the case of Soxhlet extraction, the wet tissue must be dried by mixing with a chemical agent (e.g., anhydrous sodium sulphate), in which case a time period of several hours is required between mixing and extraction in order to allow complete binding of the water in the sample. Alkaline digestion is conducted on wet tissue samples, so this procedure is unnecessary. In neither case can the freeze-drying of the tissue prior to extraction be recommended, owing to the danger of contamination from oil back-streaming from the rotary pump (which provides the vacuum) into the sample. Non-polar solvents alone will not effectively extract all the PAHs from tissues when using Soxhlet extraction, and mixtures such as hexane/dichloromethane may be effective in place of solvents such as benzene and toluene, used historically for this purpose. Alkaline digestion has been extensively used in the determination of PAHs and hydrocarbons and is well documented. It is usually conducted in alcohol (methanol or ethanol), which should contain at least 10 % water, and combines disruption of the cellular matrix, lipid extraction and saponification within a single procedure, thereby reducing sample handling and treatment. For these reasons, it should be the method of choice. Solvents used for liquid-liquid extraction of the homogenate are usually non-polar, such as pentane or hexane, and they will effectively extract all PAHs.

Tissue extracts will always contain many compounds other than PAHs, and a suitable clean-up is necessary to remove those compounds which may interfere with the subsequent analysis. Different techniques may be used, both singly or in combination, and the choice will be influenced by the selectivity and sensitivity of the final measurement technique and also by the extraction method employed. If Soxhlet extraction was used, then there is a much greater quantity of residual lipid to be removed before the analytical determination can be made than in the case of alkaline digestion. An additional clean-up stage may therefore be necessary. The most commonly used clean-up methods involve the use of alumina or silica adsorption chromatography, but gel permeation chromatography and similar high performance liquid chromatography (HPLC) based methods are also employed (Nondek *et al.*, 1993; Nyman *et al.*, 1993; Perfetti *et al.*, 1992). The major advantages of using HPLC-based clean-up methods are their ease of automation and reproducibility.

5.5 Pre-concentration

The sample volume should be 2 cm³ or greater to avoid errors when transferring solvents during the clean-up stages. Evaporation of solvents using a rotary-film evaporator should be performed at low temperature (water bath temperature of 30 °C or lower) and under controlled pressure conditions, in order to prevent losses of the more volatile PAHs such as naphthalenes. For the same reasons, evaporation to dryness should be avoided. When reducing the sample to final volume, solvents can be removed by a stream of clean nitrogen gas. Suitable solvents for injection into the gas chromatograph (GC) or GC-MS include pentane, hexane, heptane and *iso*-octane, whereas for HPLC analyses acetonitrile and methanol are commonly used.

5.6 Selection of PAHs to be determined

The choice of PAHs to be analysed is not straightforward, both because of differences in the range of PAH compounds resulting from combustion processes and from oil and oil products, and also because the aims of specific monitoring programmes can require the analysis of different representative groups of compounds. PAHs arising from combustion processes are predominantly parent (unsubstituted) compounds, whereas oil and its products contain a much

wider range of alkylated compounds in addition to the parent PAHs. This has implications for the analytical determination, as both HPLC-based and GC-based techniques are adequate for the determination of a limited range of parent PAHs in samples influenced by combustion processes, whereas in areas of significant oil contamination and following oil spills only GC-MS has sufficient selectivity to determine the full range of PAHs present. The availability of pure individual PAHs for the preparation of standards is problematic and limits both the choice of determinands and, to some degree, the quantification procedures which can be used. The availability of reference materials certified for PAHs is also rather limited. A list of target parent and alkylated PAHs suitable for environmental monitoring is given in Table 1. In both cases, the list was concentrated on a subset of parent (predominantly combustion-derived) PAHs due to analytical limitations. This approach completely neglects the determination of alkylated PAHs, which allows the interpretation of PAH accumulation from multiple sources including those due to oil inputs. It will not be necessary for all of these PAH compounds and groups to be analysed in all cases, but an appropriate selection can be made from this list depending on the specific aims of the monitoring programme to be undertaken.

Table 1: Compounds of interest for environmental monitoring for which the guidelines apply			
Compound	MW	Compound	MW
Naphthalene	128	C2-Phenanthrenes/Anthracenes	206
C1-Naphthalenes	142	C3-Phenanthrenes/Anthracenes	220
C2-Naphthalenes	156	Fluoranthene	202
C3-Naphthalenes	170	Pyrene	202
C4-Naphthalenes	184	C1-Fluoranthenes/Pyrenes	216
Acenaphthylene	152	C2-Fluoranthenes/Pyrenes	230
Acenaphthene	154	Benz[a]anthracene	228
Biphenyl	154	Chrysene	228
Fluorene	166	2,3-Benzanthracene	228
C1-Fluorenes	180	Benzo[a]fluoranthene	252
C2-Fluorenes	194	Benzo[b]fluoranthene	252
C3-Fluorenes	208	Benzo[j]fluoranthene	252
Dibenzothiophene	184	Benzo[k]fluoranthene	252
C1-Dibenzothiophenes	198	Benzo[e]pyrene	252
C2-Dibenzothiophenes	212	Benzo[a]pyrene	252
C3-Dibenzothiophenes	226	Perylene	252
Phenanthrene	178	Indeno[1,2,3-cd]pyrene	276
Anthracene	178	Benzo[ghi]perylene	276
C1-Phenanthrenes/ Anthracenes	192	Dibenz[ah]anthracene	278

5.7 Instrumental determination of PAHs

Unlike the situation for chlorobiphenyls (CBs), where GC techniques (particularly GC-ECD) are used exclusively, two major approaches based on GC and HPLC are followed to an equal extent in the analysis of PAHs. The greatest sensitivity and selectivity in routine analyses are achieved by combining HPLC with fluorescence detection (HPLC-UVF) and capillary gas chromatography with mass spectrometry (GC-MS). In terms of flexibility, GC-MS is the most capable technique, as in principle it does not limit the selection of determinands in any way, while HPLC is suited only to the analysis of parent PAHs. In the past, analyses have also been conducted using HPLC with UV-absorption detection and GC with flame-ionization detection, but neither can be recommended because of their relatively poor selectivity.

Intercomparison exercises have demonstrated a serious lack of comparability between specific hydrocarbon concentrations measured in different laboratories and using both analytical approaches described above (Farrington *et al.*, 1986). An interlaboratory performance study has been carried out within the QUASIMEME laboratory testing scheme in order to assess the level of comparability among laboratories conducting PAH analyses and to identify improvements in methodology (Law and Klungsøyr, 1996; Law *et al.*, 1998, QUASIMEME). Limits of determination within the range of 0.2 to 10 µg kg⁻¹ wet weight for individual PAH compounds should be achievable by both GC-MS and HPLC-UVF techniques.

5.8 HPLC

Reversed-phase columns (e.g., octadecylsilane (RP-18)) 15–30 cm in length are used almost exclusively, in conjunction with gradient elution using mixtures of acetonitrile/water or methanol/water. A typical gradient may start as a 50 % mixture, changing to 100 % acetonitrile or methanol in 40 minutes. This flow is maintained for 20 minutes, followed by a return to the original conditions in 5 minutes and 5–10 minutes' equilibration before the next injection. The use of an automatic injector is strongly recommended. Also, the column should be maintained in a column oven heated to 10–30°C. The systems yielding the best sensitivity and selectivity utilize fluorescence detection. As different PAH compounds yield their maximum fluorescence at different wavelengths, for optimum detection of PAHs the wavelengths of the detector should be programmed so that the excitation/emission wavelengths detected are changed at pre-set times during the analytical determination. For closely eluting peaks, it may be necessary to use two detectors in series utilizing different wavelength pairs, or to affect a compromise in the selected wavelengths if a single detector is used. As the fluorescence signals of some PAHs (e.g., pyrene) are quenched by oxygen, the eluents must be degassed thoroughly. This is usually achieved by continuously bubbling a gentle stream of helium through the eluent reservoirs, but a vacuum degasser can also be used. Polytetrafluorethylene (PTFE) tubing must not then be used downstream of the reservoirs as this material is permeable to oxygen; stainless steel or polyether-etherketone (PEEK) tubing is preferred.

5.9 GC-MS

The two injection modes commonly used are splitless and on-column injection. Automatic sample injection should be used wherever possible to improve the reproducibility of injection and the precision of the overall method. If splitless injection is used, the liner should be of sufficient capacity to contain the injected solvent volume after evaporation. For PAH analysis, the cleanliness of the liner is also very important if adsorption effects and discrimination are to be avoided, and the analytical column should not contain active sites to which PAHs can be adsorbed. Helium is the preferred carrier gas, and only capillary columns should be used. Because of the wide boiling range of the PAHs to be determined and the surface-active properties of the higher PAHs, the preferred column length is 25–30 m, with an internal diameter of 0.15 mm to 0.3 mm. Film thicknesses of 0.3 µm to 1 µm are generally used; this choice has little impact on critical resolution, but thicker films are often used when one-ring aromatic compounds are to be determined alongside PAHs, or where a high sample loading is

needed. No stationary phase has been found on which all PAH isomers can be resolved; the most commonly used stationary phase for PAH analysis is 5 % phenyl methylsilicone (DB-5 or equivalent). This will not, however, resolve critical isomers such as benzo[*b*], [*j*] and [*k*]fluoranthenes, or chrysene from triphenylene. These separations can be made on other columns, if necessary. For PAHs there is no sensitivity gain from the use of chemical ionization (either positive or negative ion), so analyses are usually conducted in electron-impact mode at 70 eV. The choice of full-scan or multiple-ion detection is usually made in terms of sensitivity. Some instruments such as ion-trap mass spectrometers exhibit the same sensitivity in both modes, so full-scan spectra are collected, whereas for quadrupole instruments greater sensitivity is obtained if the number of ions scanned is limited. In that case, the masses to be detected are programmed to change during the analysis as different PAHs elute from the capillary column.

6. CALIBRATION AND QUANTIFICATION

6.1 Standards

A range of fully deuterated parent PAHs is available for use as standards in PAH analysis. The availability of pure PAH compounds is limited (Annex B-7). Although most of the parent compounds can be purchased as pure compounds, the range of possible alkyl-substituted PAHs is vast and only a limited selection of them can be obtained. In HPLC, where the resolving power of the columns is limited and the selectivity less than that which can be obtained using MS detection, only a single internal standard is normally used (e.g., phenanthrene-d10), although fluoranthene-d10 and 6-methyl chrysene, among others, have also been used. If GC-MS is used, then a wider range of deuterated PAHs can be utilized, both because of the wide boiling range of PAHs present and because that allows the use of both recovery and quantification standards. Suitable standards could range from naphthalene-d8 to perylene-d10. It is always recommended to use at least two and preferably three internal standards of hydrocarbons of small, medium, and high molecular weight (e.g., naphthalene-d8, phenanthrene-d10, perylene-d12). Crystalline PAHs of known purity should be used for the preparation of calibration standards. If the quality of the standard materials is not guaranteed by the producer or supplier (as for certified reference materials), then it should be checked by GC-MS analysis. Solid standards should be weighed to a precision of 10⁻⁵ grams. Calibration standards should be stored in the dark because some PAHs are photosensitive, and ideally solutions to be stored should be sealed in amber glass ampoules. Otherwise, they can be stored in a refrigerator in stoppered measuring cylinders or flasks that are gas tight to avoid evaporation of the solvent during storage.

6.2 Calibration

Multilevel calibration with at least five calibration levels is preferred to adequately define the calibration curve. In general, GC-MS calibration is linear over a considerable concentration range but exhibits non-linear behaviour when the mass of a compound injected is low due to adsorption. Quantification should be conducted in the linear region of the calibration curve, or the non-linear region must be well characterized during the calibration procedure. For HPLC-UVF, the linear range of the detection system should be large, and quantification should be made within the linear range. External standardization is often used with HPLC due to the relatively limited resolution obtainable with this technique as generally employed.

6.3 Recovery

The recovery of analytes should be checked and reported. Given the wide boiling range of the PAHs to be determined, the recovery may vary with compound group, from the volatile PAHs of low molecular weight to the larger compounds. For GC-MS analysis, deuterated standards can

be added in two groups: those to be used for quantification are added at the start of the analytical procedure, whilst those from which the absolute recovery will be assessed are added prior to GC-MS injection. This ensures that the calculated PAH concentrations are corrected for the recovery obtained in each case. In the case of HPLC, where only a single deuterated PAH standard is used, it is more common to assess recovery periodically by carrying a standard solution through the whole analytical procedure, then assessing recovery by reference to an external standard. This technique does not, however, correct for matrix effects, and so may be used in conjunction with the spiking of real samples.

7. ANALYTICAL QUALITY CONTROL

Planners of monitoring programmes must decide on the accuracy, precision, repeatability, and limits of detection and determination which they consider acceptable. Achievable limits of determination for each individual component are as follows:

- for GC-MS measurements: 0.2 µg kg⁻¹ ww;
- for HPLC measurements: 0.5–10 µg kg⁻¹ ww.

Further information on analytical quality control procedures for PAHs can be found elsewhere (Law and de Boer, 1995). A procedural blank should be measured with each sample batch, and should be prepared simultaneously using the same chemical reagents and solvents as for the samples. Its purpose is to indicate sample contamination by interfering compounds, which will result in errors in quantification. The procedural blank is also very important in the calculation of limits of detection and limits of quantification for the analytical method. In addition, a laboratory reference material (LRM) should be analysed within each sample batch. Test materials from the former runs of QUASIMEME Laboratory Proficiency Testing can be used as Laboratory Reference Material. The LRM must be homogeneous and well characterized for the determinands of interest within the analytical laboratory. Ideally, stability tests should have been undertaken to show that the LRM yields consistent results over time. The LRM should be of the same matrix type (e.g., liver, muscle, mussel tissue) as the samples, and the determinand concentrations should be in the same range as those in the samples. Realistically, and given the wide range of PAH concentrations encountered, particularly in oil spill investigations, this is bound to involve some compromise. The data produced for the LRM in successive sample batches should be used to prepare control charts. It is also useful to analyse the LRM in duplicate from time to time to check within-batch analytical variability. The analysis of an LRM is primarily intended as a check that the analytical method is under control and yields acceptable precision, but a certified reference material (CRM) of a similar matrix should be analysed periodically in order to check the method bias. The availability of biota CRMs certified for PAHs is very limited (Annex B-7; QUASIMEME), and in all cases the number of PAHs for which certified values are provided is small. At regular intervals, the laboratory should participate in an intercomparison or proficiency exercise in order to provide an independent check on the performance.

8. DATA REPORTING

The calculation of results and the reporting of data can represent major sources of error, as has been shown in intercomparison studies for PAHs. Control procedures should be established in order to ensure that data are correct and to obviate transcription errors. Data stored in databases should be checked and validated, and checks are also necessary when data are transferred between databases. Data should be reported in accordance with the latest ICES reporting formats.

9. REFERENCES

- Vázquez Blanco, E., López Mahía, P., Muniategui Lorenzo, S., Prada Rodríguez, D., and Fernández Fernández, E. 2000. Optimization of microwave-assisted extraction of hydrocarbons in marine sediments: comparison with the Soxhlet extraction method. *Fresenius Journal of Analytical Chemistry*, 366: 283–288.
- Budzinski, H. 2000. Combined protocol for analysis of PAHs and PCBs from sediments using focused microwave assisted (FMW) extraction at atmospheric pressure. *Fresenius Journal of Analytical Chemistry*, 367: 165–171.
- During, R.A., and Gaath, S. 2000. Microwave assisted methodology for the determination of organic pollutants in organic municipal wastes and soils: extraction of PCBs using heat transformer discs. *Fres. J. Anal.Chem.*, 368: 684–688.
- Ehrhardt, M., Klungsøyr, J., and Law, R.J. 1991. Hydrocarbons: Review of methods for analysis in sea water, biota, and sediments. *Techniques in Marine Environmental Sciences*, 12: 19–22.
- Farrington, J.W., Davis, A.C., Livramento, J.B., Clifford, C.H., Frew, N.M., and Knap, A. 1986. ICES/IOC Intercomparison Exercises on the Determination of Petroleum Hydrocarbons in Biological Tissues (mussel homogenate) - ICES (2/HC/BT). ICES Cooperative Research Report, 141: 1–75.
- Law, R.J., and Biscaya, J.L. 1994. Polycyclic aromatic hydrocarbons (PAHs)—Problems and progress in sampling, analysis and interpretation. *Marine Pollution Bulletin*, 29: 235–241.
- Law, R.J., and de Boer, J. 1995. Quality assurance of analysis of organic compounds in marine matrices: Application to analysis of chlorobiphenyls and polycyclic aromatic hydrocarbons. *In Quality Assurance in Environmental Monitoring—Sampling and Sample Pretreatment*, pp. 129–156. Ed. by P. Quevauviller. VCH Publishers, Weinheim, Germany.
- Law, R.J., Fileman, T.W., and Portmann, J.E. 1988. Methods of analysis for hydrocarbons in marine samples. *Aquatic Environment Protection: Analytical Methods*. MAFF Directorate of Fisheries Research, Lowestoft, UK. (2). 25 pp.
- Law, R.J., and Klungsøyr, J. 1996. The 1994 QUASIMEME laboratory-performance studies: Polycyclic aromatic hydrocarbons (PAHs) in standard solutions. *Marine Pollution Bulletin*, 32: 667–673.
- Law, R.J., Klungsøyr, J., and Freriks, I.L. 1998. The QUASIMEME interlaboratory testing scheme for polycyclic aromatic hydrocarbons (PAHs): assessment of the first three rounds, 1994–1995. *Marine Pollution Bulletin*, 35: 64–77.
- Law, R.J., and Nicholson, M.D. 1995. Report on the results of the Intercomparison Programme on the Analysis of PAHs in Marine Media—Stage 1. ICES Cooperative Research Report, 207: 52–104.
- Malins, D.C., McCain, B.B., Landahl, J.T., Myers, M.S., Krahn, M.M., Brown, D.W., Chan, S.-L., and Roubal, W.T. 1988. Neoplastic and other diseases in fish in relation to toxic chemicals: an overview. *Aquatic Toxicology*, 11:43–67.
- Nondek, L., Kuziiek, M., and Krupicka, S. 1993. LC clean-up and GC-MS analysis of polycyclic aromatic hydrocarbons in river sediment. *Chromatographia*, 37: 381–391.
- Nyman, P.J., Perfetti, G.A., Joe, F.L. jr., and Diachenko, G.W. 1993. Comparison of two clean-up methodologies for the gas chromatographic-mass spectrometric detection of low nanogram per gram levels of polynuclear aromatic hydrocarbons in seafood. *Food Additives and Contaminants*, 10: 489–501.
- Perfetti, G.A., Nyman, P.J., Fisher, S., Joe, F.L. jr., and Diachenko, G.W. 1992. Determination of polynuclear aromatic hydrocarbons in seafood by liquid chromatography with fluorescence detection. *Journal of the Association of Official Analytical Chemists*, 75: 872–877.
- QUASIMEME. www.quasimeme.marlab.ac.uk
- Ramil Criado M. 2002. Optimization of microwave-assisted extraction method for the analysis of PCBs in ash samples. *Journal of Chromatography A*, 1: 1–9.
- Smedes, F. 1999. Determination of total lipid using non-chlorinated solvents. *The Analyst*, 124: 1711–1718.

- Vethaak, A.D., and Rheinallt, T. 1992. Fish disease as a monitor for marine pollution: the case of the North Sea. *Review of Fish Biology and Fisheries*, 2: 1-32.

Annex XVII:

OSPAR COMMISSION

**CEMP Guidelines for Monitoring Contaminants in Sediments
(OSPAR Agreement 2002-16)**

Technical Annex 3: Determination of parent and alkylated PAHs in biological materials



CEMP Guidelines for Monitoring Contaminants in Sediments
(OSPAR Agreement 2002-16)

Technical Annex 3: Determination of parent and alkylated PAHs in biological materials

1. Introduction

Polycyclic aromatic hydrocarbons (PAHs) consist of a variable number of fused benzene rings. By definition, PAHs contain at least two fused rings. PAHs arise from incomplete combustion processes and from both natural and anthropogenic sources, although the latter generally predominate. PAHs are also found in oil and oil products, and these include a wide range of alkylated PAHs formed as a result of diagenetic processes, whereas PAHs from combustion sources comprise mainly parent (non-alkylated) compounds. PAHs are of concern in the marine environment for two main reasons: firstly, low molecular weight (MW) PAHs can cause tainting of fish and shellfish and render them unfit for sale; secondly, metabolites of some of the high MW PAHs are potent animal and human carcinogens — benzo[*a*]pyrene is the prime example. Carcinogenic activity is closely related to structure. Benzo[*e*]pyrene and the four benzofluoranthene isomers all have a molecular weight of 252 Da; however, they are much less potent than benzo[*a*]pyrene. Less is known about toxicity of alkylated PAHs. However, one study has demonstrated that alkylated PAHs may have increased toxicity compared to the parent compound (Marvanova *et al.*, 2008).

PAHs are readily taken up by marine animals both across gill surfaces (lower MW PAHs) and from their diet. They may bioaccumulate, particularly in shellfish. Filter-feeding organisms such as bivalve molluscs can accumulate high concentrations of PAHs, both from chronic discharges to the sea (e.g., of sewage) and following oil spills. Fish are exposed to PAHs both via uptake across gill surfaces and from their diet, but do not generally accumulate high concentrations of PAHs as they possess an effective mixed-function oxygenase (MFO) system which allows them to metabolise PAHs and to excrete them in bile. Other marine vertebrate and marine mammals also metabolise PAHs efficiently. An assessment of the exposure of fish to PAHs therefore requires the determination of PAH metabolite concentrations in bile, as turnover times can be extremely rapid.

There are marked differences in the behaviour of PAHs in the aquatic environment between the low MW compounds (such as naphthalene; 128 Da) and the high MW compounds (such as benzo[*ghi*]perylene; 276 Da) as a consequence of their differing physico-chemical properties. The low MW compounds are appreciably water soluble (e.g. naphthalene) and can be bioaccumulated from the dissolved phase by transfer across gill surfaces, whereas the high MW compounds are relatively insoluble and hydrophobic, and can attach to both organic and inorganic particulates within the water column. PAHs derived from combustion sources may actually be deposited to the sea already

adsorbed to atmospheric particulates, such as soot particles. The sediment will act as a sink for PAHs in the marine environment.

2. Appropriate species for analysis of parent and alkylated PAHs

2.1 Benthic fish and shellfish

Guidance on the selection of appropriate species for contaminant monitoring is given in the OSPAR Joint Assessment and Monitoring Programme guidelines. All teleost fish have the capacity for rapid metabolism of PAHs, thereby limiting their usefulness for monitoring temporal or spatial trends of PAHs. Shellfish (particularly molluscs) generally have a lesser metabolic capacity towards PAHs, and so they are preferred because PAH concentrations are generally higher in their tissues. The blue mussel (*Mytilus edulis*) occurs in shallow waters along almost all coasts of the Northeast Atlantic. It is therefore suitable for monitoring in near shore waters. No distinction is made between *M. edulis* and *M. galloprovincialis* because the latter species, which may occur along Spanish and Portuguese coasts, fills a similar ecological niche. A sampling size range of 30–70 mm shell length is specified to ensure availability throughout the whole maritime area. In some areas (e.g., the Barents Sea), other species may be considered. Recent monitoring studies have indicated a seasonal cycle in PAH concentrations (particularly for combustion-derived PAHs) in mussels, with maximum concentrations in the winter prior to spawning and minimum concentrations in the summer. It is particularly important, therefore, that samples selected for trend monitoring and spatial comparisons are collected at the same time of year, and preferably in the first months of the year prior to spawning.

For the purposes of temporal trend monitoring, it is essential that long time-series with either a single species or a limited number of species be obtained. Care should be taken that the sample is representative of the population and that it can be sampled annually. There are advantages in the use of molluscs for this purpose as they are sessile, and so reflect the degree of contamination in the local area to a greater degree than fish which are mobile and metabolise PAHs relatively efficiently. The analysis of fish tissues is often undertaken in conjunction with biomarker and disease studies, and associations have been shown between the incidence of some diseases (e.g., liver neoplasia) in flatfish and the concentrations of PAHs in the sediments over which they live and feed (Malins *et al.*, 1988; Vethaak and Rheinallt, 1992). The exposure of fish to PAHs can be assessed by the analysis of PAH metabolites in bile, and by measuring the induction of mixed-function oxygenase enzymes which catalyse the formation of these metabolites.

3. Transportation

Live biota should be transported in closed containers at temperatures between 5°C and 10°C. For live animals it is important that the transport time is short and controlled (e.g., maximum of 24 hours). If biomarker determinations are to be made, then it will be necessary to store tissue samples at lower temperatures, for example, in liquid nitrogen at -196°C.

4. Pre-treatment and storage

4.1 Contamination

Sample contamination may occur during sampling, sample handling, pre-treatment, and analysis, due to the environment, the containers or packing materials used, the instruments used during sample preparation, and from the solvents and reagents used during the analytical procedures. Controlled

conditions are therefore required for all procedures. In the case of PAHs, particular care must be taken to avoid contamination at sea. On ships there are multiple sources of PAHs, such as the oils used for fuel and lubrication, and the exhaust from the ship's engines. It is important that the likely sources of contamination are identified and steps taken to preclude sample handling in areas where contamination can occur. A ship is a working vessel and there can always be procedures occurring as a result of the day-to-day operations (deck cleaning, automatic overboard bilge discharges, etc.) which could affect the sampling process. One way of minimizing the risk is to conduct dissection in a clean area, such as within a laminar-flow hood away from the deck areas of the vessel. It is also advisable to collect samples of the ship's fuel, bilge water, and oils and greases used on winches, etc., which can be used as fingerprinting samples at a later date, if there are suspicions of contamination in particular instances.

Freeze-drying of tissue samples may be a source of contamination due to the back-streaming of oil vapours from the rotary vacuum pumps. Furthermore, drying the samples may result in losses of the lower molecular weight and more volatile PAHs through evaporation (Law and Biscaya, 1994).

4.2 Shellfish

4.2.1 Depuration

Depending upon the situation, it may be desirable to depurate shellfish so as to void the gut contents and any associated contaminants before freezing or sample preparation. This is usually applied close to point sources, where the gut contents may contain significant quantities of PAHs associated with food and sediment particles which are not truly assimilated into the tissues of the mussels. Depuration should be undertaken in controlled conditions and in clean seawater; depuration over a period of 24 hours is usually sufficient. The aquarium should be aerated and the temperature and salinity of the water should be similar to that from which the animals were removed.

4.2.2 Dissection and storage

Mussels should be shucked live and opened with minimal tissue damage by detaching the adductor muscles from the interior of at least one valve. The soft tissues should be removed and homogenised as soon as possible, and frozen in glass jars or aluminium cans at -20°C until analysis. Plastic materials must not be used for sampling and storage owing to possible adsorption of the PAHs onto the container material. As PAHs are sensitive to photo-degradation, exposure to direct sunlight or other strong light must be avoided during storage of the samples as well as during all steps of sample preparation, including extraction and storage of the extracts (Law and Biscaya, 1994). The use of amber glassware is strongly recommended.

When samples are processed, both at sea and onshore, the dissection must be undertaken by trained personnel on a clean bench wearing clean gloves and using PAH-free stainless steel knives and scalpels. Stainless steel tweezers are recommended for holding tissues during dissection. After each sample has been prepared, all tools and equipment (such as homogenisers) should be cleaned by wiping with tissue and rinsing with solvent.

5. Analysis

5.1 Preparation of materials

Solvents and adsorptive materials must all be checked for the presence of PAHs and other interfering compounds. If found then the solvents, reagents, and adsorptive materials must be purified or cleaned using appropriate methods. Adsorptive materials should be cleaned by solvent extraction and/or by heating in a muffle oven as appropriate. Glass fibre materials (e.g. Soxhlet thimbles and filter papers used in pressurised liquid extraction (PLE)) should be cleaned by solvent extraction or pre-baked at 450°C overnight. It should be borne in mind that clean materials can be re-contaminated by exposure to laboratory air, particularly in urban locations, and so the method of storage after cleaning is of critical importance. Ideally, materials should be prepared immediately before use, but if they are to be stored, then the conditions should be considered critically. All containers which come into contact with the sample should be made of glass or aluminium, and should be pre-cleaned before use. Appropriate cleaning methods would include washing with detergents, rinsing with water of known quality, and finally solvent rinsing immediately before use.

5.2 Lipid determination

Although PAH data are not usually expressed on a lipid basis, the determination of the lipid content of tissues can be of use in characterising the samples. This will enable reporting concentrations on a wet weight or lipid weight basis. The lipid content should be determined on a separate subsample of the tissue homogenate, as some of the extraction techniques used routinely for PAHs determination (e.g., PLE with fat retainers, alkaline saponification) destroy or remove lipid materials. The total lipid content of fish or shellfish should be determined using the method of Bligh and Dyer (1959) as modified by Hanson and Olley (1963) or an equivalent method such as Smedes (1999). Extractable lipid may be used, particularly if the sample size is small and lipid content is high. It has been shown that if the lipid content is high (>5%) then extractable lipid will be comparable to the total lipid.

5.3 Extraction

PAHs are lipophilic and so are concentrated in the lipids of an organism, and a number of methods have been described for PAH extraction (Ehrhardt *et al.*, 1991). These methods generally utilise either Soxhlet extraction, or alkaline digestion followed by liquid-liquid extraction with an organic solvent. In the case of Soxhlet extraction, the wet tissue must be dried by mixing with a chemical drying agent (e.g., anhydrous sodium sulphate), in which case a time period of several hours is required between mixing and extraction in order to allow complete binding of the water in the sample. Samples are spiked with recovery standard and should be left overnight to equilibrate. Alkaline digestion is conducted on wet tissue samples, so this procedure is unnecessary.

Apolar solvents alone will not effectively extract all the PAHs from tissues when using Soxhlet extraction, and mixtures such as hexane/dichloromethane may be effective in place of solvents such as benzene and toluene, used historically for this purpose. Alkaline digestion has been extensively used in the determination of PAHs and hydrocarbons and is well documented. It is usually conducted in alcohol (methanol or ethanol), which should contain at least 10% water, and combines disruption of the cellular matrix, lipid extraction and saponification within a single procedure, thereby reducing sample handling and treatment. Solvents used for liquid-liquid extraction of the homogenate are usually apolar, such as pentane or hexane, and they will effectively extract all PAHs.

Alternatively extraction of wet or dry samples of biota may be carried out by pressurised liquid extraction (PLE). This is a more recent method, requiring less solvent and time for the extraction process. The wet biota sample is dried by mixing with sufficient anhydrous sodium sulphate to form a free flowing mixture and is packed into stainless steel extraction cells containing a glass fibre filter and sodium sulphate or glass powder to fill the cell. To ensure a better recovery samples may be extracted twice and extractions are performed at elevated temperatures and pressure.

5.4 Clean-up

Tissue extracts will always contain many compounds other than PAHs, and a suitable clean-up is necessary to remove those compounds which may interfere with the subsequent analysis. Different techniques may be used, either singly or in combination, and the choice will be influenced by the selectivity and sensitivity of the final measurement technique and also by the extraction method employed. If Soxhlet extraction was used, then there is a much greater quantity of residual lipid to be removed before the analytical determination can be made than in the case of alkaline digestion. An additional clean-up stage may therefore be necessary. The most commonly used clean-up methods involve the use of deactivated alumina or silica adsorption chromatography. When applying fractionation, the elution pattern has to be checked frequently. This should be carried out in the presence of sample matrix, as that can partially deactivate the clean-up column, resulting in earlier elution of the PAHs than in a standard solution.

Gel permeation chromatography (GPC) and high performance liquid chromatography (HPLC) based methods are also employed (Nondek *et al.*, 1993; Nyman *et al.*, 1993; Perfetti *et al.*, 1992). The major advantages of using HPLC-based clean-up methods are their ease of automation and reproducibility.

Isocratic HPLC fractionation of the extract can be used to give separate aliphatic and aromatic fractions (Webster *et al.*, 2002). A metal-free silica column is used for the clean-up/fractionation as dibenzothiophene (DBT) can be retained on ordinary silica columns. The split time is determined by injection of a solution containing representative aliphatic and PAH standards. The silica column is regenerated by a cleaning cycle after a set number of samples. If PAHs are to be analysed by HPLC and there are significant amounts of alkylated PAHs present then the removal of the alkylated PAHs may be difficult.

5.5 Pre-concentration

In the methods suggested above, all result in an extract in which non-polar solvents are dominant. The sample volume should be 2 ml or greater to avoid errors when transferring solvents during the clean-up stages. Syncore parallel evaporators can be used with careful optimisation of the evaporation parameters. Evaporation of solvents using a rotary-film evaporator should be performed at low temperature (water bath temperature of 30°C or lower) and under controlled pressure conditions, in order to prevent losses of the more volatile PAHs such as naphthalenes. For the same reasons, evaporation to dryness must be avoided. When reducing the sample to final volume, solvents can be removed by a stream of clean nitrogen gas. Suitable solvents for injection into the GC-MS include pentane, hexane, heptane, *iso*-hexane and *iso*-octane.

5.6 Selection of PAHs to be determined

The choice of PAHs to be analysed is not straightforward, both because of differences in the range of PAH compounds resulting from combustion processes and from oil and oil products, and also because the aims of specific monitoring programmes can require the analysis of different representative

groups of compounds. PAHs arising from combustion processes are predominantly parent (unsubstituted) compounds, whereas oil and its products contain a much wider range of alkylated compounds in addition to the parent PAHs. This has implications for the analytical determination, as both HPLC-based and GC-based techniques are adequate for the determination of a limited range of parent PAHs in samples influenced by combustion processes, whereas in areas of significant oil contamination and following oil spills only GC-MS has sufficient selectivity to determine the full range of PAHs present. The availability of pure individual PAHs for the preparation of standards is problematic and limits both the choice of determinands and, to some degree, the quantification procedures which can be used. The availability of reference materials certified for PAHs is also rather limited. A list of target parent and alkylated PAHs suitable for environmental monitoring is given in Table A1.1. This differs both from the list previously developed within ICES specifically for intercomparison purposes, and the historic list of Borneff. In both cases, the lists were concentrated on a subset of parent (predominantly combustion-derived) PAHs due to analytical limitations. This approach completely neglects the determination of alkylated PAHs, which allows the interpretation of PAH accumulation from multiple sources including those due to oil inputs. It will not be necessary for all of these PAH compounds and groups to be analysed in all cases, but an appropriate selection can be made from this list depending on the specific aims of the monitoring programme to be undertaken.

Table A1.1: Compounds of interest for environmental monitoring for which the guidelines apply. For compounds in italics standards are not available for any isomers in this group.

Compound	MW	Compound	MW
Naphthalene	128	2, 3d-benzonaphthothiophene	234
C ₁ -Naphthalenes	142	C ₁ -234	248
C ₂ -Naphthalenes	156	C ₂ -Fluoranthenes/Pyrenes	230
C ₃ -Naphthalenes	170	Benz[<i>a</i>]anthracene	228
<i>C₄-Naphthalenes</i>	184	Chrysene	228
Acenaphthylene	152	2,3-Benzanthracene	228
Acenaphthene	154	C ₁ - Benz[<i>a</i>]anthracene/ Chrysene	242
Biphenyl	154	C ₂ - Benz[<i>a</i>]anthracene/ Chrysene	256
Fluorene	166	C ₃ - Benz[<i>a</i>]anthracene/ Chrysene	270
C ₁ -Fluorenes	180	Benzo[<i>a</i>]fluoranthene	252
<i>C₂-Fluorenes</i>	194	Benzo[<i>b</i>]fluoranthene	252
<i>C₃-Fluorenes</i>	208	Benzo[<i>j</i>]fluoranthene	252
Dibenzothiophene	184	Benzo[<i>k</i>]fluoranthene	252
C ₁ -Dibenzothiophenes	198	Benzo[<i>e</i>]pyrene	252
<i>C₂-Dibenzothiophenes</i>	212	Benzo[<i>a</i>]pyrene	252
<i>C₃-Dibenzothiophenes</i>	226	Perylene	252
Phenanthrene	178	Indeno[1,2,3- <i>cd</i>]pyrene	276
Anthracene	178	Benzo[<i>ghi</i>]perylene	276
C ₁ -Phenanthrenes/Anthracenes	192	Dibenz[<i>a,h</i>]anthracene	278
C ₂ -Phenanthrenes/Anthracenes	206	Benzo[<i>k</i>]fluoranthene	252
C ₃ -Phenanthrenes/Anthracenes	220	Cyclopenta[<i>cd</i>]pyrene	226
Fluoranthene	202	Naphtho[2,1- <i>a</i>]pyrene	302
Pyrene	202	Dibenz[<i>a,e</i>]pyrene	302

C ₁ -Fluoranthenes/Pyrenes	216	Dibenz[<i>a,i</i>]pyrene	302
2, 1d-benzonaphthothiophene	234	Dibenz[<i>a,l</i>]pyrene	302
1,2d-benzonaphthothiophene	234	Dibenz[<i>a,h</i>]pyrene	302

5.7 Instrumental determination of PAHs

The greatest sensitivity and selectivity in routine analysis for parent PAH is achieved by combining HPLC with fluorescence detection (HPLC-UVF) or capillary gas chromatography with mass spectrometry (GC-MS). However, for the analysis of parent and alkylated PAHs GC-MS is the method of choice. In terms of flexibility, GC-MS is the most capable technique, as in principle it does not limit the selection of determinands in any way, while HPLC is suited only to the analysis of parent PAHs. In the past, analyses have also been conducted using HPLC with UV-absorption detection and GC with flame-ionisation detection, but neither can be recommended for alkylated PAHs because of their relatively poor selectivity. Both in terms of the initial capital cost of the instrumentation, and the cost per sample analysed, HPLC-UVF is cheaper than GC-MS. With the advent of high-sensitivity benchtop GC-MS systems, however, this cost advantage is now not as marked as in the past, and the additional information regarding sources available makes GC-MS the method of choice.

Limits of determination within the range of 0.05 to 0.5 µg kg⁻¹ wet weight for individual PAH compounds should be achievable by GC-MS. However this limit can be lowered in routine analysis.

5.7.1 GC-MS

The three injection modes commonly used are splitless, on-column and PTV (programmed temperature vaporiser). Automatic sample injection should be used wherever possible to improve the reproducibility of injection and the precision of the overall method. If splitless injection is used, the liner should be of sufficient capacity to contain the injected solvent volume after evaporation. For PAH analysis, the cleanliness of the liner is also very important if adsorption effects and discrimination are to be avoided, and the analytical column should not contain active sites to which PAHs can be adsorbed. Helium is the preferred carrier gas, and only capillary columns should be used. Because of the wide boiling range of the PAHs to be determined and the surface-active properties of the higher PAHs, the preferred column length is 25–50 m, with an internal diameter of 0.15 mm to 0.3 mm. Film thicknesses of 0.2 µm to 1 µm are generally used; this choice has little impact on critical resolution, but thicker films are often used when one-ring aromatic compounds are to be determined alongside PAHs, or where a high sample loading is needed. No stationary phase has been found on which all PAH isomers can be resolved; the most commonly used stationary phase for PAH analysis is 5% phenyl methylsilicone (DB-5 or equivalent). This will not, however, resolve critical isomers such as benzo[*b*], [*j*] and [*k*]fluoranthenes, or chrysene from triphenylene. Chrysene and triphenylene can be separated on other columns, if necessary such as a 60 m non polar column such as DB5MS. For PAHs there is no sensitivity gain from the use of chemical ionisation (either positive or negative ion), so analyses are usually conducted in electron-impact mode at 70eV. Quadrupole instruments are used in single ion monitoring to achieve greater sensitivity. The masses to be detected are programmed to change during the analysis as different PAHs elute from the capillary column. In SIM the molecular ion is used for quantification. Qualifier ions can be used to confirm identification but they are limited for PAHs. Triple quadrupole mass spectrometry can also be used and will give greater sensitivity. Some instruments such as ion-trap and time of flight mass spectrometers exhibit the same sensitivity in both modes, so full scan spectra can be used for quantification.

An example of mass spectrometer operating conditions in SIM mode is given in Table A1.2. The ions are grouped and screened within GC time windows of the compounds. In general the number of ions should not be greater than 20. The dwell time is important parameter and should be close for each ion. For GC capillary column analysis a dwell time should not be shorter than 20 ms, while a sum of a dwell in each retention time windows should not be greater than 500 ms. An example of conditions that can be used along with dwell times are shown in Table A1.2.

Table A.1.2: Example of operational conditions for the GC-MS analysis of parent and alkylated PAHs.

Group N°	Retention time (min)	Dwell time (ms)	Ions in group (AMU)					
			128	136	142	170	182	184
1	8.00	100	128	136	142			
2	21.00	100	152	156	160			
3	23.70	100	154	164	168	170		
4	26.80	80	166	176	180	182	184	
5	31.60	80	178	184	188	194	196	198
6	35.30	100	192	198				
7	36.60	100	206	212				
8	39.40	80	202	206	212	216	220	226
9	44.65	100	216	220				
10	45.30	100	226	228	230	234	240	
11	48.58	90	242	248				
12	52.00	100	252	256	264	266		
13	59.00	100	266	276	278	288		

Alkylated homologues of PAHs (C1–C4), mainly associated with petrogenic sources, contain a number of different isomers that can give very complex but distinct distribution profiles when analysed by GC-MS. Integration of each isomer separately is difficult for most alkylated PAHs. 1- and 2-Methyl naphthalene give well resolved peaks that can be quantified separately. C1-Phenanthrene/anthracene gives five distinct peaks corresponding to 3-methyl phenanthrene, 2-methyl phenanthrene, 2-methyl anthracene, 4- and 9-methyl phenanthrene and 1-methyl phenanthrene. These may be integrated as a group or as separate isomers. For all other alkylated PAHs the area for all isomers may be summed and quantified against a single representative isomer. This method will lead, however, to an overestimation of the concentration as may include non-alkylated PAHs. Examples of integrations of both parent and alkylated PAHs are shown in Appendix 1.

6. Calibration and quantification

6.1 Standards

The availability of pure PAH compounds are limited. Although most of the parent compounds can be purchased as pure compounds, the range of possible alkyl-substituted PAHs is vast and only a limited selection of them can be obtained. PAH standards are available for at least one isomer of most alkyl group listed in Table A1.1. A range of deuterated PAHs (normally 5 to 7) should be used as internal standards to cover the range of PAHs being analysed in samples. A range of fully-deuterated parent PAHs is available for use as standards in PAH analysis. Suitable standards could range from d_8 -naphthalene to d_{14} -dibenz[*a,h*]anthracene. Crystalline PAHs of known purity should be used for the preparation of calibration standards. If the quality of the standard materials is not guaranteed by the producer or supplier (as for certified reference materials), then it should be checked by GC-MS analysis. Solid standards should be weighed to a precision of 10^{-5} grams. Calibration standards should

be stored in the dark because some PAHs are photosensitive, and ideally solutions to be stored should be sealed in amber glass ampoules or sealed GC vials. Otherwise, they can be stored in a refrigerator in stoppered measuring cylinders or flasks that are gas tight to avoid evaporation of the solvent during storage.

6.2 Calibration

Multilevel calibration with at least five calibration levels is preferred to adequately define the calibration curve. In general, GC-MS calibration is linear over a considerable concentration range but may exhibit a change of slope at very low concentrations. Quantification should be conducted in the linear region of the calibration curve. A separate calibration curve may be used where sample concentrations are very low. An internal standard method should be employed, using a range of deuterated PAHs as internal standards.

6.3 Recovery

The recovery of analytes should be checked and reported. Given the wide boiling range of the PAHs to be determined, the recovery may vary with compound group, from the volatile PAHs of low molecular weight to the larger compounds. Deuterated standards can be added in two groups: those to be used for quantification are added at the start of the analytical procedure, whilst those from which the absolute recovery will be assessed are added prior to GC-MS injection. This allows the recovery to be calculated.

7. Analytical Quality Control

Planners of monitoring programmes must decide on the accuracy, precision, repeatability, and limits of detection and determination which they consider acceptable. Achievable limits of determination for each individual component are as follows:

- for GC-MS measurements: $0.05 \mu\text{g kg}^{-1} \text{ ww}$;
- Further information on analytical quality control procedures for PAHs can be found elsewhere (Law and de Boer, 1995). A procedural blank should be measured with each sample batch, and should be prepared simultaneously using the same chemical reagents and solvents as for the samples. Its purpose is to indicate sample contamination by interfering compounds, which will result in errors in quantification. The procedural blank is also very important in the calculation of limits of detection and limits of quantification for the analytical method. In addition, a laboratory reference material (LRM) should be analysed within each sample batch. The LRM must be homogeneous and well-characterised for the determinands of interest within the analytical laboratory. Ideally, stability tests should have been undertaken to show that the LRM yields consistent results over time. The LRM should be of the same matrix type (e.g. mussels) as the samples, and the determinand concentrations should be in the same range as those in the samples. Realistically, and given the wide range of PAH concentrations encountered, particularly in oil spill investigations, this is bound to involve some compromise. The data produced for the LRM in successive sample batches should be used to prepare control charts. It is also useful to analyse the LRM in duplicate from time to time to check within-batch analytical variability. The analysis of an LRM is primarily intended as a check that the analytical method is under control and yields acceptable precision, but a certified reference material (CRM) of a similar matrix should be analysed periodically in order to check the method bias. The availability of biota CRMs certified for PAHs is very limited, and in all cases the number of PAHs for which certified values are

provided is small. At present, only NIST 1974a (a frozen wet mussel tissue) and NIST 2974 (a freeze-dried mussel tissue) are available. At regular intervals, the laboratory should participate in an intercomparison or proficiency exercise in which samples are circulated without knowledge of the determinand concentrations, in order to provide an independent check on performance.

8. Data reporting

The calculation of results and the reporting of data can represent major sources of error, as has been shown in intercomparison studies for PAHs. Control procedures should be established in order to ensure that data are correct and to obviate transcription errors. Data stored on databases should be checked and validated, and checks are also necessary when data are transferred between databases. Data should be reported in accordance with the latest ICES reporting formats.

9. References

Bligh, E. G., and Dyer, W. J. 1959. A rapid method of total lipid extraction and purification. *Canadian Journal of Biochemistry and Physiology*. 37: 911–917.

Ehrhardt, M., Klungsøyr, J., and Law, R. J. 1991. Hydrocarbons: Review of methods for analysis in sea water, biota, and sediments. *Techniques in Marine Environmental Sciences*. 12: 19–22.

Farrington, J. W., Davis, A. C., Livramento, J. B., Clifford, C. H., Frew, N. M., and Knap, A. 1986. ICES/IOC Intercomparison Exercises on the Determination of Petroleum Hydrocarbons in Biological Tissues (mussel homogenate) – ICES (2/HC/BT). ICES Cooperative Research Report, 141: 1–75.

Hanson, S. W. F., and Olley, J. 1963. Application of the Bligh and Dyer method of lipid extraction to tissue homogenates. *Biochem. J.*, 89: 101–102.

Law, R. J., and Biscaya, J. L. 1994. Polycyclic aromatic hydrocarbons (PAHs)—Problems and progress in sampling, analysis and interpretation. *Marine Pollution Bulletin*, 29: 235–241.

Law, R. J., and de Boer, J. 1995. Quality assurance of analysis of organic compounds in marine matrices: Application to analysis of chlorobiphenyls and polycyclic aromatic hydrocarbons. *In Quality Assurance in Environmental Monitoring—Sampling and Sample Pretreatment*. 129–156. Ed. by P. Quevauviller. VCH Publishers, Weinheim, Germany.

Law, R. J., Fileman, T. W., and Portmann, J. E. 1988. Methods of analysis for hydrocarbons in marine samples. *Aquatic Environment Protection: Analytical Methods*. MAFF Directorate of Fisheries Research, Lowestoft, UK. (2). 25.

Law, R. J., and Klungsøyr, J. 1996. The 1994 QUASIMEME laboratory-performance studies: Polycyclic aromatic hydrocarbons (PAHs) in standard solutions. *Marine Pollution Bulletin*, 32: 667–673.

Law, R. J., Klungsøyr, J., and Fredriks, I. L. 1998. The QUASIMEME interlaboratory testing scheme for polycyclic aromatic hydrocarbons (PAHs): assessment of the first three rounds, 1994–1995. *Marine Pollution Bulletin*. 35: 64–77.

Law, R. J., and Nicholson, M. D. 1995. Report on the results of the Intercomparison Programme on the Analysis of PAHs in Marine Media—Stage 1. ICES Cooperative Research Report. 207: 52–104.

Malins, D. C., McCain, B. B., Landahl, J. T., Myers, M. S., Krahn, M. M., Brown, D. W., Chan, S-L., and Roubal, W. T. 1988. Neoplastic and other diseases in fish in relation to toxic chemicals: an overview. *Aquatic Toxicology*. 11: 43–67.

Marvanova, S., Vondracek, J., Pencikova, K., Trilecova, L., Krcmar, P., Topinka, J., Novakova, Z., Milcova, A., and Machala, M. 2008. Toxic effects of methylated[a]anthracenes in liver cells. *Chemical Research in Toxicology*. In press.

Nondek, L., Kuzilek, M., and Krupicka, S. 1993. LC clean-up and GC-MS analysis of polycyclic aromatic hydrocarbons in river sediment. *Chromatographia*. 37: 381–391.

Nyman, P. J., Perfetti, G. A., Joe, F. L. jr., and Diachenko, G. W. 1993. Comparison of two clean-up methodologies for the gas chromatographic-mass spectrometric detection of low nanogram per gram levels of polynuclear aromatic hydrocarbons in seafood. *Food Additives and Contaminants*. 10: 489–501.

Perfetti, G. A., Nyman, P. J., Fisher, S., Joe, F. L. jr., and Diachenko, G. W. 1992. Determination of polynuclear aromatic hydrocarbons in seafood by liquid chromatography with fluorescence detection. *Journal of the Association of Official Analytical Chemists*. 75: 872–877.

Revision of the Nordtest Methodology for oil spill identification, <http://www.nordicinnovation.net/nordtestfiler/tec499.pdf>

Smedes, F. 1999. Determination of total lipid using non-chlorinated solvents. *Analyst*, 124: 1711-1718.

Vethaak, A. D., and Rheinallt, T. 1992. Fish disease as a monitor for marine pollution: the case of the North Sea. *Review of Fish Biology and Fisheries*. 2: 1–32.

Webster, L., McIntosh, A. D., Megginson, C., Shepherd, N. J., and Moffat, C. F. 2002. The polycyclic aromatic hydrocarbon composition of mussels (*Mytilus edulis*) from Scottish coastal waters. *Journal of Environmental Monitoring*. 5:150-159.

Annex XVIII:

Method 1613

**Tetra- through Octa-Chlorinated Dioxins and Furans by Isotope
Dilution HRGC/HRMS**

Method 1613

**Tetra- through Octa-Chlorinated Dioxins and Furans by Isotope
Dilution HRGC/HRMS**

October 1994

**U.S. Environmental Protection Agency
Office of Water
Engineering and Analysis Division (4303)
401 M Street S.W.
Washington, D.C. 20460**

Acknowledgments

This method was prepared under the direction of William A. Telliard of the Engineering and Analysis Division within the EPA Office of Water. This document was prepared under EPA Contract No. 68-C3-0337 by DynCorp Environmental Services Division with assistance from its subcontractor Interface, Inc.

Disclaimer

This method has been reviewed by the Engineering and Analysis Division, U.S. Environmental Protection Agency, and approved for publication. Mention of trade names or commercial products does not constitute endorsement or recommendation for use.

Introduction

Method 1613 was developed by the United States Environmental Protection Agency's Office of Science and Technology for isomer-specific determination of the 2,3,7,8-substituted, tetra-through octa-chlorinated, dibenzo-*p*-dioxins and dibenzofurans in aqueous, solid, and tissue matrices by isotope dilution, high resolution capillary column gas chromatography (HRGC)/high resolution mass spectrometry (HRMS).

Questions concerning this method or its application should be addressed to:

W.A. Telliard
US EPA Office of Water
Analytical Methods Staff
Mail Code 4303
401 M Street, SW
Washington, D.C. 20460
202/260-7120

Requests for additional copies should be directed to:

Water Resource Center
Mail Code RC-4100
401 M Street, SW
Washington, D.C. 20460
202/260-7786 or 202/260-2814

Method 1613, Revision B

Tetra- through Octa-Chlorinated Dioxins and Furans by Isotope Dilution HRGC/HRMS

1.0 Scope and Application

- 1.1 This method is for determination of tetra- through octa-chlorinated dibenzo-*p*-dioxins (CDDs) and dibenzofurans (CDFs) in water, soil, sediment, sludge, tissue, and other sample matrices by high resolution gas chromatography/high resolution mass spectrometry (HRGC/HRMS). The method is for use in EPA's data gathering and monitoring programs associated with the Clean Water Act, the Resource Conservation and Recovery Act, the Comprehensive Environmental Response, Compensation and Liability Act, and the Safe Drinking Water Act. The method is based on a compilation of EPA, industry, commercial laboratory, and academic methods (References 1-6).
- 1.2 The seventeen 2,3,7,8-substituted CDDs/CDFs listed in Table 1 may be determined by this method. Specifications are also provided for separate determination of 2,3,7,8-tetrachloro-dibenzo-*p*-dioxin (2,3,7,8-TCDD) and 2,3,7,8-tetrachloro-dibenzofuran (2,3,7,8-TCDF).
- 1.3 The detection limits and quantitation levels in this method are usually dependent on the level of interferences rather than instrumental limitations. The minimum levels (MLs) in Table 2 are the levels at which the CDDs/CDFs can be determined with no interferences present. The Method Detection Limit (MDL) for 2,3,7,8-TCDD has been determined as 4.4 pg/L (parts-per-quadrillion) using this method.
- 1.4 The GC/MS portions of this method are for use only by analysts experienced with HRGC/HRMS or under the close supervision of such qualified persons. Each laboratory that uses this method must demonstrate the ability to generate acceptable results using the procedure in Section 9.2.
- 1.5 This method is "performance-based". The analyst is permitted to modify the method to overcome interferences or lower the cost of measurements, provided that all performance criteria in this method are met. The requirements for establishing method equivalency are given in Section 9.1.2.
- 1.6 Any modification of this method, beyond those expressly permitted, shall be considered a major modification subject to application and approval of alternate test procedures under 40 CFR 136.4 and 136.5.

2.0 Summary of Method

Flow charts that summarize procedures for sample preparation, extraction, and analysis are given in Figure 1 for aqueous and solid samples, Figure 2 for multi-phase samples, and Figure 3 for tissue samples.

2.1 Extraction

- 2.1.1 Aqueous samples (samples containing less than 1% solids)—Stable isotopically labeled analogs of 15 of the 2,3,7,8-substituted CDDs/CDFs are spiked into a 1 L sample, and the sample is extracted by one of three procedures:
- 2.1.1.1 Samples containing no visible particles are extracted with methylene chloride in a separatory funnel or by the solid-phase extraction technique summarized in Section 2.1.1.3. The extract is concentrated for cleanup.
- 2.1.1.2 Samples containing visible particles are vacuum filtered through a glass-fiber filter. The filter is extracted in a Soxhlet/Dean-Stark (SDS) extractor (Reference 7), and the filtrate is extracted with methylene chloride in a separatory funnel. The methylene chloride extract is concentrated and combined with the SDS extract prior to cleanup.
- 2.1.1.3 The sample is vacuum filtered through a glass-fiber filter on top of a solid-phase extraction (SPE) disk. The filter and disk are extracted in an SDS extractor, and the extract is concentrated for cleanup.
- 2.1.2 Solid, semi-solid, and multi-phase samples (but not tissue)—The labeled compounds are spiked into a sample containing 10 g (dry weight) of solids. Samples containing multiple phases are pressure filtered and any aqueous liquid is discarded. Coarse solids are ground or homogenized. Any non-aqueous liquid from multi-phase samples is combined with the solids and extracted in an SDS extractor. The extract is concentrated for cleanup.
- 2.1.3 Fish and other tissue—The sample is extracted by one of two procedures:
- 2.1.3.1 Soxhlet or SDS extraction—A 20 g aliquot of sample is homogenized, and a 10 g aliquot is spiked with the labeled compounds. The sample is mixed with sodium sulfate, allowed to dry for 12-24 hours, and extracted for 18-24 hours using methylene chloride:hexane (1:1) in a Soxhlet extractor. The extract is evaporated to dryness, and the lipid content is determined.
- 2.1.3.2 HCl digestion—A 20 g aliquot is homogenized, and a 10 g aliquot is placed in a bottle and spiked with the labeled compounds. After equilibration, 200 mL of hydrochloric acid and 200 mL of methylene chloride:hexane (1:1) are added, and the bottle is agitated for 12-24 hours. The extract is evaporated to dryness, and the lipid content is determined.
- 2.2 After extraction, $^{37}\text{Cl}_4$ -labeled 2,3,7,8-TCDD is added to each extract to measure the efficiency of the cleanup process. Sample cleanups may include back-extraction with acid and/or base, and gel permeation, alumina, silica gel, Florisil and activated carbon chromatography. High-performance liquid chromatography (HPLC) can be used for further isolation of the 2,3,7,8-isomers or other specific isomers or congeners. Prior to the cleanup procedures cited above, tissue extracts are cleaned up using an anthropogenic isolation column, a batch silica gel adsorption, or sulfuric acid and base back-extraction, depending on the tissue extraction procedure used.

- 2.3 After cleanup, the extract is concentrated to near dryness. Immediately prior to injection, internal standards are added to each extract, and an aliquot of the extract is injected into the gas chromatograph. The analytes are separated by the GC and detected by a high-resolution ($\geq 10,000$) mass spectrometer. Two exact m/z 's are monitored for each analyte.
- 2.4 An individual CDD/CDF is identified by comparing the GC retention time and ion-abundance ratio of two exact m/z 's with the corresponding retention time of an authentic standard and the theoretical or acquired ion-abundance ratio of the two exact m/z 's. The non-2,3,7,8 substituted isomers and congeners are identified when retention times and ion-abundance ratios agree within predefined limits. Isomer specificity for 2,3,7,8-TCDD and 2,3,7,8-TCDF is achieved using GC columns that resolve these isomers from the other tetra-isomers.
- 2.5 Quantitative analysis is performed using selected ion current profile (SICP) areas, in one of three ways:
- 2.5.1 For the 15 2,3,7,8-substituted CDDs/CDFs with labeled analogs (see Table 1), the GC/MS system is calibrated, and the concentration of each compound is determined using the isotope dilution technique.
- 2.5.2 For 1,2,3,7,8,9-HxCDD, OCDF, and the labeled compounds, the GC/MS system is calibrated and the concentration of each compound is determined using the internal standard technique.
- 2.5.3 For non-2,3,7,8-substituted isomers and for all isomers at a given level of chlorination (i.e., total TCDD), concentrations are determined using response factors from calibration of the CDDs/CDFs at the same level of chlorination.
- 2.6 The quality of the analysis is assured through reproducible calibration and testing of the extraction, cleanup, and GC/MS systems.

3.0 Definitions

Definitions are given in the glossary at the end of this method.

4.0 Contamination and Interferences

- 4.1 Solvents, reagents, glassware, and other sample processing hardware may yield artifacts and/or elevated baselines causing misinterpretation of chromatograms (References 8-9). Specific selection of reagents and purification of solvents by distillation in all-glass systems may be required. Where possible, reagents are cleaned by extraction or solvent rinse.
- 4.2 Proper cleaning of glassware is extremely important, because glassware may not only contaminate the samples but may also remove the analytes of interest by adsorption on the glass surface.
- 4.2.1 Glassware should be rinsed with solvent and washed with a detergent solution as soon after use as is practical. Sonication of glassware containing a detergent solution for approximately 30 seconds may aid in cleaning. Glassware with

- removable parts, particularly separatory funnels with fluoropolymer stopcocks, must be disassembled prior to detergent washing.
- 4.2.2 After detergent washing, glassware should be rinsed immediately, first with methanol, then with hot tap water. The tap water rinse is followed by another methanol rinse, then acetone, and then methylene chloride.
- 4.2.3 Do not bake reusable glassware in an oven as a routine part of cleaning. Baking may be warranted after particularly dirty samples are encountered but should be minimized, as repeated baking of glassware may cause active sites on the glass surface that will irreversibly adsorb CDDs/CDFs.
- 4.2.4 Immediately prior to use, the Soxhlet apparatus should be pre-extracted with toluene for approximately three hours (see Sections 12.3.1 through 12.3.3). Separatory funnels should be shaken with methylene chloride/toluene (80/20 mixture) for two minutes, drained, and then shaken with pure methylene chloride for two minutes.
- 4.3 All materials used in the analysis shall be demonstrated to be free from interferences by running reference matrix method blanks initially and with each sample batch (samples started through the extraction process on a given 12-hour shift, to a maximum of 20 samples).
- 4.3.1 The reference matrix must simulate, as closely as possible, the sample matrix under test. Ideally, the reference matrix should not contain the CDDs/CDFs in detectable amounts, but should contain potential interferences in the concentrations expected to be found in the samples to be analyzed. For example, a reference sample of human adipose tissue containing pentachloronaphthalene can be used to exercise the cleanup systems when samples containing pentachloronaphthalene are expected.
- 4.3.2 When a reference matrix that simulates the sample matrix under test is not available, reagent water (Section 7.6.1) can be used to simulate water samples; playground sand (Section 7.6.2) or white quartz sand (Section 7.3.2) can be used to simulate soils; filter paper (Section 7.6.3) can be used to simulate papers and similar materials; and corn oil (Section 7.6.4) can be used to simulate tissues.
- 4.4 Interferences coextracted from samples will vary considerably from source to source, depending on the diversity of the site being sampled. Interfering compounds may be present at concentrations several orders of magnitude higher than the CDDs/CDFs. The most frequently encountered interferences are chlorinated biphenyls, methoxy biphenyls, hydroxydiphenyl ethers, benzylphenyl ethers, polynuclear aromatics, and pesticides. Because very low levels of CDDs/CDFs are measured by this method, the elimination of interferences is essential. The cleanup steps given in Section 13 can be used to reduce or eliminate these interferences and thereby permit reliable determination of the CDDs/CDFs at the levels shown in Table 2.
- 4.5 Each piece of reusable glassware should be numbered to associate that glassware with the processing of a particular sample. This will assist the laboratory in tracking possible sources of contamination for individual samples, identifying glassware associated with

highly contaminated samples that may require extra cleaning, and determining when glassware should be discarded.

- 4.6 Cleanup of tissue—The natural lipid content of tissue can interfere in the analysis of tissue samples for the CDDs/CDFs. The lipid contents of different species and portions of tissue can vary widely. Lipids are soluble to varying degrees in various organic solvents and may be present in sufficient quantity to overwhelm the column chromatographic cleanup procedures used for cleanup of sample extracts. Lipids must be removed by the lipid removal procedures in Section 13.7, followed by alumina (Section 13.4) or Florisil (Section 13.8), and carbon (Section 13.5) as minimum additional cleanup steps. If chlorodiphenyl ethers are detected, as indicated by the presence of peaks at the exact m/z 's monitored for these interferents, alumina and/or Florisil cleanup must be employed to eliminate these interferences.

5.0 Safety

- 5.1 The toxicity or carcinogenicity of each compound or reagent used in this method has not been precisely determined; however, each chemical compound should be treated as a potential health hazard. Exposure to these compounds should be reduced to the lowest possible level.
- 5.1.1 The 2,3,7,8-TCDD isomer has been found to be acnegenic, carcinogenic, and teratogenic in laboratory animal studies. It is soluble in water to approximately 200 ppt and in organic solvents to 0.14%. On the basis of the available toxicological and physical properties of 2,3,7,8-TCDD, all of the CDDs/CDFs should be handled only by highly trained personnel thoroughly familiar with handling and cautionary procedures and the associated risks.
- 5.1.2 It is recommended that the laboratory purchase dilute standard solutions of the analytes in this method. However, if primary solutions are prepared, they shall be prepared in a hood, and a NIOSH/MESA approved toxic gas respirator shall be worn when high concentrations are handled.
- 5.2 The laboratory is responsible for maintaining a current awareness file of OSHA regulations regarding the safe handling of the chemicals specified in this method. A reference file of material safety data sheets (MSDSs) should also be made available to all personnel involved in these analyses. It is also suggested that the laboratory perform personal hygiene monitoring of each analyst who uses this method and that the results of this monitoring be made available to the analyst. Additional information on laboratory safety can be found in References 10-13. The references and bibliography at the end of Reference 13 are particularly comprehensive in dealing with the general subject of laboratory safety.
- 5.3 The CDDs/CDFs and samples suspected to contain these compounds are handled using essentially the same techniques employed in handling radioactive or infectious materials. Well-ventilated, controlled access laboratories are required. Assistance in evaluating the health hazards of particular laboratory conditions may be obtained from certain consulting laboratories and from State Departments of Health or Labor, many of which have an industrial health service. The CDDs/CDFs are extremely toxic to laboratory animals. Each laboratory must develop a strict safety program for handling these compounds. The practices in References 2 and 14 are highly recommended.

- 5.3.1 Facility—When finely divided samples (dusts, soils, dry chemicals) are handled, all operations (including removal of samples from sample containers, weighing, transferring, and mixing) should be performed in a glove box demonstrated to be leak tight or in a fume hood demonstrated to have adequate air flow. Gross losses to the laboratory ventilation system must not be allowed. Handling of the dilute solutions normally used in analytical and animal work presents no inhalation hazards except in the case of an accident.
- 5.3.2 Protective equipment—Disposable plastic gloves, apron or lab coat, safety glasses or mask, and a glove box or fume hood adequate for radioactive work should be used. During analytical operations that may give rise to aerosols or dusts, personnel should wear respirators equipped with activated carbon filters. Eye protection equipment (preferably full face shields) must be worn while working with exposed samples or pure analytical standards. Latex gloves are commonly used to reduce exposure of the hands. When handling samples suspected or known to contain high concentrations of the CDDs/CDFs, an additional set of gloves can also be worn beneath the latex gloves.
- 5.3.3 Training—Workers must be trained in the proper method of removing contaminated gloves and clothing without contacting the exterior surfaces.
- 5.3.4 Personal hygiene—Hands and forearms should be washed thoroughly after each manipulation and before breaks (coffee, lunch, and shift).
- 5.3.5 Confinement—Isolated work areas posted with signs, segregated glassware and tools, and plastic absorbent paper on bench tops will aid in confining contamination.
- 5.3.6 Effluent vapors—The effluents of sample splitters from the gas chromatograph (GC) and from roughing pumps on the mass spectrometer (MS) should pass through either a column of activated charcoal or be bubbled through a trap containing oil or high-boiling alcohols to condense CDD/CDF vapors.
- 5.3.7 Waste Handling—Good technique includes minimizing contaminated waste. Plastic bag liners should be used in waste cans. Janitors and other personnel must be trained in the safe handling of waste.
- 5.3.8 Decontamination
 - 5.3.8.1 Decontamination of personnel—Use any mild soap with plenty of scrubbing action.
 - 5.3.8.2 Glassware, tools, and surfaces—Chlorothene NU Solvent is the least toxic solvent shown to be effective. Satisfactory cleaning may be accomplished by rinsing with Chlorothene, then washing with any detergent and water. If glassware is first rinsed with solvent, then the dish water may be disposed of in the sewer. Given the cost of disposal, it is prudent to minimize solvent wastes.
- 5.3.9 Laundry—Clothing known to be contaminated should be collected in plastic bags. Persons who convey the bags and launder the clothing should be advised of the

hazard and trained in proper handling. The clothing may be put into a washer without contact if the launderer knows of the potential problem. The washer should be run through a cycle before being used again for other clothing.

5.3.10 Wipe tests—A useful method of determining cleanliness of work surfaces and tools is to wipe the surface with a piece of filter paper. Extraction and analysis by GC with an electron capture detector (ECD) can achieve a limit of detection of 0.1 µg per wipe; analysis using this method can achieve an even lower detection limit. Less than 0.1 µg per wipe indicates acceptable cleanliness; anything higher warrants further cleaning. More than 10 µg on a wipe constitutes an acute hazard and requires prompt cleaning before further use of the equipment or work space, and indicates that unacceptable work practices have been employed.

5.3.11 Table or wrist-action shaker—The use of a table or wrist-action shaker for extraction of tissues presents the possibility of breakage of the extraction bottle and spillage of acid and flammable organic solvent. A secondary containment system around the shaker is suggested to prevent the spread of acid and solvents in the event of such a breakage. The speed and intensity of shaking action should also be adjusted to minimize the possibility of breakage.

6.0 Apparatus and Materials

NOTE: Brand names, suppliers, and part numbers are for illustration purposes only and no endorsement is implied. Equivalent performance may be achieved using apparatus and materials other than those specified here. Meeting the performance requirements of this method is the responsibility of the laboratory.

6.1 Sampling Equipment for Discrete or Composite Sampling

6.1.1 Sample bottles and caps

6.1.1.1 Liquid samples (waters, sludges and similar materials containing 5% solids or less)—Sample bottle, amber glass, 1.1 L minimum, with screw cap.

6.1.1.2 Solid samples (soils, sediments, sludges, paper pulps, filter cake, compost, and similar materials that contain more than 5% solids)—Sample bottle, wide mouth, amber glass, 500 mL minimum.

6.1.1.3 If amber bottles are not available, samples shall be protected from light.

6.1.1.4 Bottle caps—Threaded to fit sample bottles. Caps shall be lined with fluoropolymer.

6.1.1.5 Cleaning

6.1.1.5.1 Bottles are detergent water washed, then solvent rinsed before use.

- 6.1.1.5.2 Liners are detergent water washed, rinsed with reagent water (Section 7.6.1) followed by solvent, and baked at approximately 200°C for a minimum of 1 hour prior to use.
- 6.1.2 Compositing equipment—Automatic or manual compositing system incorporating glass containers cleaned per bottle cleaning procedure above. Only glass or fluoropolymer tubing shall be used. If the sampler uses a peristaltic pump, a minimum length of compressible silicone rubber tubing may be used in the pump only. Before use, the tubing shall be thoroughly rinsed with methanol, followed by repeated rinsing with reagent water to minimize sample contamination. An integrating flow meter is used to collect proportional composite samples.
- 6.2 Equipment for Glassware Cleaning—Laboratory sink with overhead fume hood.
- 6.3 Equipment for Sample Preparation
 - 6.3.1 Laboratory fume hood of sufficient size to contain the sample preparation equipment listed below.
 - 6.3.2 Glove box (optional).
 - 6.3.3 Tissue homogenizer—VirTis Model 45 Macro homogenizer (American Scientific Products H-3515, or equivalent) with stainless steel Macro-shaft and Turbo-shear blade.
 - 6.3.4 Meat grinder—Hobart, or equivalent, with 3-5 mm holes in inner plate.
 - 6.3.5 Equipment for determining percent moisture
 - 6.3.5.1 Oven—Capable of maintaining a temperature of 110 ±5°C.
 - 6.3.5.2 Dessicator.
 - 6.3.6 Balances
 - 6.3.6.1 Analytical—Capable of weighing 0.1 mg.
 - 6.3.6.2 Top loading—Capable of weighing 10 mg.
- 6.4 Extraction Apparatus
 - 6.4.1 Water samples
 - 6.4.1.1 pH meter, with combination glass electrode.
 - 6.4.1.2 pH paper, wide range (Hydrion Papers, or equivalent).
 - 6.4.1.3 Graduated cylinder, 1 L capacity.
 - 6.4.1.4 Liquid/liquid extraction—Separatory funnels, 250 mL, 500 mL, and 2000 mL, with fluoropolymer stopcocks.

6.4.1.5 Solid-phase extraction

- 6.4.1.5.1 One liter filtration apparatus, including glass funnel, glass frit support, clamp, adapter, stopper, filtration flask, and vacuum tubing (Figure 4). For wastewater samples, the apparatus should accept 90 or 144 mm disks. For drinking water or other samples containing low solids, smaller disks may be used.
 - 6.4.1.5.2 Vacuum source capable of maintaining 25 in. Hg, equipped with shutoff valve and vacuum gauge.
 - 6.4.1.5.3 Glass-fiber filter—Whatman GMF 150 (or equivalent), 1 micron pore size, to fit filtration apparatus in Section 6.4.1.5.1.
 - 6.4.1.5.4 Solid-phase extraction disk containing octadecyl (C₁₈) bonded silica uniformly enmeshed in an inert matrix—Fisher Scientific 14-378F (or equivalent), to fit filtration apparatus in Section 6.4.1.5.1.
- 6.4.2 Soxhlet/Dean-Stark (SDS) extractor (Figure 5)—For filters and solid/sludge samples.
- 6.4.2.1 Soxhlet—50 mm ID, 200 mL capacity with 500 mL flask (Cal-Glass LG-6900, or equivalent, except substitute 500 mL round-bottom flask for 300 mL flat-bottom flask).
 - 6.4.2.2 Thimble—43 x 123 to fit Soxhlet (Cal-Glass LG-6901-122, or equivalent).
 - 6.4.2.3 Moisture trap—Dean Stark or Barret with fluoropolymer stopcock, to fit Soxhlet.
 - 6.4.2.4 Heating mantle—Hemispherical, to fit 500 mL round-bottom flask (Cal-Glass LG-8801-112, or equivalent).
 - 6.4.2.5 Variable transformer—Powerstat (or equivalent), 110 volt, 10 amp.
- 6.4.3 Apparatus for extraction of tissue.
- 6.4.3.1 Bottle for extraction (if digestion/extraction using HCl is used)—500-600 mL wide-mouth clear glass, with fluoropolymer-lined cap.
 - 6.4.3.2 Bottle for back-extraction—100-200 mL narrow-mouth clear glass with fluoropolymer-lined cap.
 - 6.4.3.3 Mechanical shaker—Wrist-action or platform-type rotary shaker that produces vigorous agitation (Sybron Thermolyne Model LE "Big Bill" rotator/shaker, or equivalent).

6.4.3.4 Rack attached to shaker table to permit agitation of four to nine samples simultaneously.

6.4.4 Beakers—400-500 mL.

6.4.5 Spatulas—Stainless steel.

6.5 Filtration Apparatus

6.5.1 Pyrex glass wool—Solvent-extracted by SDS for three hours minimum.

NOTE: Baking glass wool may cause active sites that will irreversibly adsorb CDDs/CDFs.

6.5.2 Glass funnel—125-250 mL.

6.5.3 Glass-fiber filter paper—Whatman GF/D (or equivalent), to fit glass funnel in Section 6.5.2.

6.5.4 Drying column—15-20 mm ID Pyrex chromatographic column equipped with coarse-glass frit or glass-wool plug.

6.5.5 Buchner funnel—15 cm.

6.5.6 Glass-fiber filter paper—to fit Buchner funnel in Section 6.5.5.

6.5.7 Filtration flasks—1.5-2.0 L, with side arm.

6.5.8 Pressure filtration apparatus—Millipore YT30 142 HW, or equivalent.

6.6 Centrifuge Apparatus

6.6.1 Centrifuge—Capable of rotating 500 mL centrifuge bottles or 15 mL centrifuge tubes at 5,000 rpm minimum.

6.6.2 Centrifuge bottles—500 mL, with screw-caps, to fit centrifuge.

6.6.3 Centrifuge tubes—12-15 mL, with screw-caps, to fit centrifuge.

6.7 Cleanup Apparatus

6.7.1 Automated gel permeation chromatograph (Analytical Biochemical Labs, Inc, Columbia, MO, Model GPC Autoprep 1002, or equivalent).

6.7.1.1 Column—600-700 mm long x 25 mm ID, packed with 70 g of SX-3 Bio-beads (Bio-Rad Laboratories, Richmond, CA, or equivalent).

6.7.1.2 Syringe—10 mL, with Luer fitting.

6.7.1.3 Syringe filter holder—stainless steel, and glass-fiber or fluoropolymer filters (Gelman 4310, or equivalent).

- 6.7.1.4 UV detectors—254 nm, preparative or semi-preparative flow cell (Isco, Inc., Type 6; Schmadzu, 5 mm path length; Beckman-Altex 152W, 8 μ L micro-prep flow cell, 2 mm path; Pharmacia UV-1, 3 mm flow cell; LDC Milton-Roy UV-3, monitor #1203; or equivalent).
- 6.7.2 Reverse-phase high-performance liquid chromatograph.
- 6.7.2.1 Column oven and detector—Perkin-Elmer Model LC-65T (or equivalent) operated at 0.02 AUFS at 235 nm.
- 6.7.2.2 Injector—Rheodyne 7120 (or equivalent) with 50 μ L sample loop.
- 6.7.2.3 Column—Two 6.2 mm x 250 mm Zorbax-ODS columns in series (DuPont Instruments Division, Wilmington, DE, or equivalent), operated at 50°C with 2.0 mL/min methanol isocratic effluent.
- 6.7.2.4 Pump—Altex 110A (or equivalent).
- 6.7.3 Pipets
- 6.7.3.1 Disposable, pasteur—150 mm long x 5-mm ID (Fisher Scientific 13-678-6A, or equivalent).
- 6.7.3.2 Disposable, serological—10 mL (6 mm ID).
- 6.7.4 Glass chromatographic columns
- 6.7.4.1 150 mm long x 8-mm ID, (Kontes K-420155, or equivalent) with coarse-glass frit or glass-wool plug and 250 mL reservoir.
- 6.7.4.2 200 mm long x 15 mm ID, with coarse-glass frit or glass-wool plug and 250 mL reservoir.
- 6.7.4.3 300 mm long x 25 mm ID, with 300 mL reservoir and glass or fluoropolymer stopcock.
- 6.7.5 Stirring apparatus for batch silica cleanup of tissue extracts.
- 6.7.5.1 Mechanical stirrer—Corning Model 320, or equivalent.
- 6.7.5.2 Bottle—500-600 mL wide-mouth clear glass.
- 6.7.6 Oven—For baking and storage of adsorbents, capable of maintaining a constant temperature ($\pm 5^\circ\text{C}$) in the range of 105-250°C.
- 6.8 Concentration Apparatus
- 6.8.1 Rotary evaporator—Buchi/Brinkman-American Scientific No. E5045-10 or equivalent, equipped with a variable temperature water bath.

- 6.8.1.1 Vacuum source for rotary evaporator equipped with shutoff valve at the evaporator and vacuum gauge.
- 6.8.1.2 A recirculating water pump and chiller are recommended, as use of tap water for cooling the evaporator wastes large volumes of water and can lead to inconsistent performance as water temperatures and pressures vary.
- 6.8.1.3 Round-bottom flask—100 mL and 500 mL or larger, with ground-glass fitting compatible with the rotary evaporator.
- 6.8.2 Kuderna-Danish (K-D) Concentrator
 - 6.8.2.1 Concentrator tube—10 mL, graduated (Kontes K-570050-1025, or equivalent) with calibration verified. Ground-glass stopper (size 19/22 joint) is used to prevent evaporation of extracts.
 - 6.8.2.2 Evaporation flask—500 mL (Kontes K-570001-0500, or equivalent), attached to concentrator tube with springs (Kontes K-662750-0012 or equivalent).
 - 6.8.2.3 Snyder column—Three-ball macro (Kontes K-503000-0232, or equivalent).
 - 6.8.2.4 Boiling chips
 - 6.8.2.4.1 Glass or silicon carbide—Approximately 10/40 mesh, extracted with methylene chloride and baked at 450°C for one hour minimum.
 - 6.8.2.4.2 Fluoropolymer (optional)—Extracted with methylene chloride.
 - 6.8.2.5 Water bath—Heated, with concentric ring cover, capable of maintaining a temperature within $\pm 2^\circ\text{C}$, installed in a fume hood.
- 6.8.3 Nitrogen blowdown apparatus—Equipped with water bath controlled in the range of 30-60°C (N-Evap, Organomation Associates, Inc., South Berlin, MA, or equivalent), installed in a fume hood.
- 6.8.4 Sample vials
 - 6.8.4.1 Amber glass—2-5 mL with fluoropolymer-lined screw-cap.
 - 6.8.4.2 Glass—0.3 mL, conical, with fluoropolymer-lined screw or crimp cap.
- 6.9 Gas Chromatograph—Shall have splitless or on-column injection port for capillary column, temperature program with isothermal hold, and shall meet all of the performance specifications in Section 10.
 - 6.9.1 GC column for CDDs/CDFs and for isomer specificity for 2,3,7,8-TCDD—60 \pm 5 m long x 0.32 \pm 0.02 mm ID; 0.25 μm 5% phenyl, 94% methyl, 1% vinyl silicone bonded-phase fused-silica capillary column (J&W DB-5, or equivalent).

- 6.9.2 GC column for isomer specificity for 2,3,7,8-TCDF—30 ±5 m long x 0.32 ±0.02 mm ID; 0.25 µm bonded-phase fused-silica capillary column (J&W DB-225, or equivalent).
- 6.10 Mass Spectrometer—28-40 eV electron impact ionization, shall be capable of repetitively selectively monitoring 12 exact m/z's minimum at high resolution (≥10,000) during a period of approximately one second, and shall meet all of the performance specifications in Section 10.
- 6.11 GC/MS Interface—The mass spectrometer (MS) shall be interfaced to the GC such that the end of the capillary column terminates within 1 cm of the ion source but does not intercept the electron or ion beams.
- 6.12 Data System—Capable of collecting, recording, and storing MS data.

7.0 Reagents and Standards

7.1 pH Adjustment and Back-Extraction

- 7.1.1 Potassium hydroxide—Dissolve 20 g reagent grade KOH in 100 mL reagent water.
- 7.1.2 Sulfuric acid—Reagent grade (specific gravity 1.84).
- 7.1.3 Hydrochloric acid—Reagent grade, 6N.
- 7.1.4 Sodium chloride—Reagent grade, prepare at 5% (w/v) solution in reagent water.

7.2 Solution Drying and Evaporation

- 7.2.1 Solution drying—Sodium sulfate, reagent grade, granular, anhydrous (Baker 3375, or equivalent), rinsed with methylene chloride (20 mL/g), baked at 400°C for one hour minimum, cooled in a dessicator, and stored in a pre-cleaned glass bottle with screw-cap that prevents moisture from entering. If, after heating, the sodium sulfate develops a noticeable grayish cast (due to the presence of carbon in the crystal matrix), that batch of reagent is not suitable for use and should be discarded. Extraction with methylene chloride (as opposed to simple rinsing) and baking at a lower temperature may produce sodium sulfate that is suitable for use.
- 7.2.2 Tissue drying—Sodium sulfate, reagent grade, powdered, treated and stored as above.
- 7.2.3 Prepurified nitrogen.

7.3 Extraction

- 7.3.1 Solvents—Acetone, toluene, cyclohexane, hexane, methanol, methylene chloride, and nonane; distilled in glass, pesticide quality, lot-certified to be free of interferences.

- 7.3.2 White quartz sand, 60/70 mesh—For Soxhlet/Dean-Stark extraction (Aldrich Chemical, Cat. No. 27-437-9, or equivalent). Bake at 450°C for four hours minimum.
- 7.4 GPC Calibration Solution—Prepare a solution containing 300 mg/mL corn oil, 15 mg/mL bis(2-ethylhexyl) phthalate, 1.4 mg/mL pentachlorophenol, 0.1 mg/mL perylene, and 0.5 mg/mL sulfur.
- 7.5 Adsorbents for Sample Cleanup
- 7.5.1 Silica gel
- 7.5.1.1 Activated silica gel—100-200 mesh, Supelco 1-3651 (or equivalent), rinsed with methylene chloride, baked at 180°C for a minimum of one hour, cooled in a dessicator, and stored in a precleaned glass bottle with screw-cap that prevents moisture from entering.
- 7.5.1.2 Acid silica gel (30% w/w)—Thoroughly mix 44.0 g of concentrated sulfuric acid with 100.0 g of activated silica gel in a clean container. Break up aggregates with a stirring rod until a uniform mixture is obtained. Store in a bottle with a fluoropolymer-lined screw-cap.
- 7.5.1.3 Basic silica gel—Thoroughly mix 30 g of 1N sodium hydroxide with 100 g of activated silica gel in a clean container. Break up aggregates with a stirring rod until a uniform mixture is obtained. Store in a bottle with a fluoropolymer-lined screw-cap.
- 7.5.1.4 Potassium silicate
- 7.5.1.4.1 Dissolve 56 g of high purity potassium hydroxide (Aldrich, or equivalent) in 300 mL of methanol in a 750-1000 mL flat-bottom flask.
- 7.5.1.4.2 Add 100 g of silica gel and a stirring bar, and stir on a hot plate at 60-70°C for one to two hours.
- 7.5.1.4.3 Decant the liquid and rinse the potassium silicate twice with 100 mL portions of methanol, followed by a single rinse with 100 mL of methylene chloride.
- 7.5.1.4.4 Spread the potassium silicate on solvent-rinsed aluminum foil and dry for two to four hours in a hood.
- 7.5.1.4.5 Activate overnight at 200-250°C.
- 7.5.2 Alumina—Either one of two types of alumina, acid or basic, may be used in the cleanup of sample extracts, provided that the laboratory can meet the performance specifications for the recovery of labeled compounds described in Section 9.3. The same type of alumina must be used for all samples, including those used to demonstrate initial precision and recovery (Section 9.2) and ongoing precision and recovery (Section 15.5).

- 7.5.2.1 Acid alumina—Supelco 19996-6C (or equivalent). Activate by heating to 130°C for a minimum of 12 hours.
- 7.5.2.2 Basic alumina—Supelco 19944-6C (or equivalent). Activate by heating to 600°C for a minimum of 24 hours. Alternatively, activate by heating in a tube furnace at 650-700°C under an air flow rate of approximately 400 cc/minute. Do not heat over 700°C, as this can lead to reduced capacity for retaining the analytes. Store at 130°C in a covered flask. Use within five days of baking.
- 7.5.3 Carbon
- 7.5.3.1 Carbpak C—(Supelco 1-0258, or equivalent).
- 7.5.3.2 Celite 545—(Supelco 2-0199, or equivalent).
- 7.5.3.3 Thoroughly mix 9.0 g Carbpak C and 41.0 g Celite 545 to produce an 18% w/w mixture. Activate the mixture at 130°C for a minimum of six hours. Store in a dessicator.
- 7.5.4 Anthropogenic isolation column—Pack the column in Section 6.7.4.3 from bottom to top with the following:
- 7.5.4.1 2 g silica gel (Section 7.5.1.1).
- 7.5.4.2 2 g potassium silicate (Section 7.5.1.4).
- 7.5.4.3 2 g granular anhydrous sodium sulfate (Section 7.2.1).
- 7.5.4.4 10 g acid silica gel (Section 7.5.1.2).
- 7.5.4.5 2 g granular anhydrous sodium sulfate.
- 7.5.5 Florisil column
- 7.5.5.1 Florisil—60-100 mesh, Floridin Corp (or equivalent). Soxhlet extract in 500 g portions for 24 hours.
- 7.5.5.2 Insert a glass wool plug into the tapered end of a graduated serological pipet (Section 6.7.3.2). Pack with 1.5 g (approx 2 mL) of Florisil topped with approx 1 mL of sodium sulfate (Section 7.2.1) and a glass wool plug.
- 7.5.5.3 Activate in an oven at 130-150°C for a minimum of 24 hours and cool for 30 minutes. Use within 90 minutes of cooling.
- 7.6 Reference Matrices—Matrices in which the CDDs/CDFs and interfering compounds are not detected by this method.
- 7.6.1 Reagent water—Bottled water purchased locally, or prepared by passage through activated carbon.

- 7.6.2 High-solids reference matrix—Playground sand or similar material. Prepared by extraction with methylene chloride and/or baking at 450°C for a minimum of four hours.
- 7.6.3 Paper reference matrix—Glass-fiber filter, Gelman Type A, or equivalent. Cut paper to simulate the surface area of the paper sample being tested.
- 7.6.4 Tissue reference matrix—Corn or other vegetable oil. May be prepared by extraction with methylene chloride.
- 7.6.5 Other matrices—This method may be verified on any reference matrix by performing the tests given in Section 9.2. Ideally, the matrix should be free of the CDDs/CDFs, but in no case shall the background level of the CDDs/CDFs in the reference matrix exceed three times the minimum levels in Table 2. If low background levels of the CDDs/CDFs are present in the reference matrix, the spike level of the analytes used in Section 9.2 should be increased to provide a spike-to-background ratio in the range of 1:1 to 5:1 (Reference 15).
- 7.7 Standard Solutions—Purchased as solutions or mixtures with certification to their purity, concentration, and authenticity, or prepared from materials of known purity and composition. If the chemical purity is 98% or greater, the weight may be used without correction to compute the concentration of the standard. When not being used, standards are stored in the dark at room temperature in screw-capped vials with fluoropolymer-lined caps. A mark is placed on the vial at the level of the solution so that solvent loss by evaporation can be detected. If solvent loss has occurred, the solution should be replaced.
- 7.8 Stock Solutions
- 7.8.1 Preparation—Prepare in nonane per the steps below or purchase as dilute solutions (Cambridge Isotope Laboratories (CIL), Woburn, MA, or equivalent). Observe the safety precautions in Section 5, and the recommendation in Section 5.1.2.
- 7.8.2 Dissolve an appropriate amount of assayed reference material in solvent. For example, weigh 1-2 mg of 2,3,7,8-TCDD to three significant figures in a 10 mL ground-glass-stoppered volumetric flask and fill to the mark with nonane. After the TCDD is completely dissolved, transfer the solution to a clean 15 mL vial with fluoropolymer-lined cap.
- 7.8.3 Stock standard solutions should be checked for signs of degradation prior to the preparation of calibration or performance test standards. Reference standards that can be used to determine the accuracy of calibration standards are available from CIL and may be available from other vendors.
- 7.9 PAR Stock Solution
- 7.9.1 All CDDs/CDFs—Using the solutions in Section 7.8, prepare the PAR stock solution to contain the CDDs/CDFs at the concentrations shown in Table 3. When diluted, the solution will become the PAR (Section 7.14).

- 7.9.2 If only 2,3,7,8-TCDD and 2,3,7,8-TCDF are to be determined, prepare the PAR stock solution to contain these compounds only.
- 7.10 Labeled-Compound Spiking Solution
- 7.10.1 All CDDs/CDFs—From stock solutions, or from purchased mixtures, prepare this solution to contain the labeled compounds in nonane at the concentrations shown in Table 3. This solution is diluted with acetone prior to use (Section 7.10.3).
- 7.10.2 If only 2,3,7,8-TCDD and 2,3,7,8-TCDF are to be determined, prepare the labeled-compound solution to contain these compounds only. This solution is diluted with acetone prior to use (Section 7.10.3).
- 7.10.3 Dilute a sufficient volume of the labeled compound solution (Section 7.10.1 or 7.10.2) by a factor of 50 with acetone to prepare a diluted spiking solution. Each sample requires 1.0 mL of the diluted solution, but no more solution should be prepared than can be used in one day.
- 7.11 Cleanup Standard—Prepare $^{37}\text{Cl}_4$ -2,3,7,8-TCDD in nonane at the concentration shown in Table 3. The cleanup standard is added to all extracts prior to cleanup to measure the efficiency of the cleanup process.
- 7.12 Internal Standard(s)
- 7.12.1 All CDDs/CDFs—Prepare the internal standard solution to contain $^{13}\text{C}_{12}$ -1,2,3,4-TCDD and $^{13}\text{C}_{12}$ -1,2,3,7,8,9-HxCDD in nonane at the concentration shown in Table 3.
- 7.12.2 If only 2,3,7,8-TCDD and 2,3,7,8-TCDF are to be determined, prepare the internal standard solution to contain $^{13}\text{C}_{12}$ -1,2,3,4-TCDD only.
- 7.13 Calibration Standards (CS1 through CS5)—Combine the solutions in Sections 7.9 through 7.12 to produce the five calibration solutions shown in Table 4 in nonane. These solutions permit the relative response (labeled to native) and response factor to be measured as a function of concentration. The CS3 standard is used for calibration verification (VER). If only 2,3,7,8-TCDD and 2,3,7,8-TCDF are to be determined, combine the solutions appropriate to these compounds.
- 7.14 Precision and Recovery (PAR) Standard—Used for determination of initial (Section 9.2) and ongoing (Section 15.5) precision and recovery. Dilute 10 μL of the precision and recovery standard (Section 7.9.1 or 7.9.2) to 2.0 mL with acetone for each sample matrix for each sample batch. One mL each are required for the blank and OPR with each matrix in each batch.
- 7.15 GC Retention Time Window Defining Solution and Isomer Specificity Test Standard—Used to define the beginning and ending retention times for the dioxin and furan isomers and to demonstrate isomer specificity of the GC columns employed for determination of 2,3,7,8-TCDD and 2,3,7,8-TCDF. The standard must contain the compounds listed in Table 5 (CIL EDF-4006, or equivalent), at a minimum. It is not necessary to monitor the window-defining compounds if only 2,3,7,8-TCDD and 2,3,7,8-TCDF are to be

determined. In this case, an isomer-specificity test standard containing the most closely eluted isomers listed in Table 5 (CIL EDF-4033, or equivalent) may be used.

- 7.16 **QC Check Sample**—A QC Check Sample should be obtained from a source independent of the calibration standards. Ideally, this check sample would be a certified reference material containing the CDDs/CDFs in known concentrations in a sample matrix similar to the matrix under test.
- 7.17 **Stability of Solutions**—Standard solutions used for quantitative purposes (Sections 7.9 through 7.15) should be analyzed periodically, and should be assayed against reference standards (Section 7.8.3) before further use.

8.0 Sample Collection, Preservation, Storage, and Holding Times

- 8.1 Collect samples in amber glass containers following conventional sampling practices (Reference 16). Aqueous samples that flow freely are collected in refrigerated bottles using automatic sampling equipment. Solid samples are collected as grab samples using wide-mouth jars.
- 8.2 Maintain aqueous samples in the dark at 0-4°C from the time of collection until receipt at the laboratory. If residual chlorine is present in aqueous samples, add 80 mg sodium thiosulfate per liter of water. EPA Methods 330.4 and 330.5 may be used to measure residual chlorine (Reference 17). If sample pH is greater than 9, adjust to pH 7-9 with sulfuric acid.

Maintain solid, semi-solid, oily, and mixed-phase samples in the dark at <4°C from the time of collection until receipt at the laboratory.

Store aqueous samples in the dark at 0-4°C. Store solid, semi-solid, oily, mixed-phase, and tissue samples in the dark at <-10°C.

8.3 Fish and Tissue Samples

- 8.3.1 Fish may be cleaned, filleted, or processed in other ways in the field, such that the laboratory may expect to receive whole fish, fish fillets, or other tissues for analysis.
- 8.3.2 Fish collected in the field should be wrapped in aluminum foil, and must be maintained at a temperature less than 4°C from the time of collection until receipt at the laboratory.
- 8.3.3 Samples must be frozen upon receipt at the laboratory and maintained in the dark at <-10°C until prepared. Maintain unused sample in the dark at <-10°C.

8.4 Holding Times

- 8.4.1 There are no demonstrated maximum holding times associated with CDDs/CDFs in aqueous, solid, semi-solid, tissues, or other sample matrices. If stored in the dark at 0-4°C and preserved as given above (if required), aqueous samples may be stored for up to one year. Similarly, if stored in the dark at <-10°C, solid, semi-solid, multi-phase, and tissue samples may be stored for up to one year.

- 8.4.2 Store sample extracts in the dark at $<-10^{\circ}\text{C}$ until analyzed. If stored in the dark at $<-10^{\circ}\text{C}$, sample extracts may be stored for up to one year.

9.0 Quality Assurance/Quality Control

- 9.1 Each laboratory that uses this method is required to operate a formal quality assurance program (Reference 18). The minimum requirements of this program consist of an initial demonstration of laboratory capability, analysis of samples spiked with labeled compounds to evaluate and document data quality, and analysis of standards and blanks as tests of continued performance. Laboratory performance is compared to established performance criteria to determine if the results of analyses meet the performance characteristics of the method.

If the method is to be applied to sample matrix other than water (e.g., soils, filter cake, compost, tissue) the most appropriate alternate matrix (Sections 7.6.2 through 7.6.5) is substituted for the reagent water matrix (Section 7.6.1) in all performance tests.

- 9.1.1 The analyst shall make an initial demonstration of the ability to generate acceptable accuracy and precision with this method. This ability is established as described in Section 9.2.

- 9.1.2 In recognition of advances that are occurring in analytical technology, and to allow the analyst to overcome sample matrix interferences, the analyst is permitted certain options to improve separations or lower the costs of measurements. These options include alternate extraction, concentration, cleanup procedures, and changes in columns and detectors. Alternate determinative techniques, such as the substitution of spectroscopic or immuno-assay techniques, and changes that degrade method performance, are not allowed. If an analytical technique other than the techniques specified in this method is used, that technique must have a specificity equal to or better than the specificity of the techniques in this method for the analytes of interest.

- 9.1.2.1 Each time a modification is made to this method, the analyst is required to repeat the procedure in Section 9.2. If the detection limit of the method will be affected by the change, the laboratory is required to demonstrate that the MDL (40 CFR Part 136, Appendix B) is lower than one-third the regulatory compliance level or one-third the ML in this method, whichever is higher. If calibration will be affected by the change, the analyst must recalibrate the instrument per Section 10.

- 9.1.2.2 The laboratory is required to maintain records of modifications made to this method. These records include the following, at a minimum:

- 9.1.2.2.1 The names, titles, addresses, and telephone numbers of the analyst(s) who performed the analyses and modification, and of the quality control officer who witnessed and will verify the analyses and modifications.
- 9.1.2.2.2 A listing of pollutant(s) measured, by name and CAS Registry number.

- 9.1.2.2.3 A narrative stating reason(s) for the modifications.
- 9.1.2.2.4 Results from all quality control (QC) tests comparing the modified method to this method, including:
- a) Calibration (Section 10.5 through 10.7).
 - b) Calibration verification (Section 15.3).
 - c) Initial precision and recovery (Section 9.2).
 - d) Labeled compound recovery (Section 9.3).
 - e) Analysis of blanks (Section 9.5).
 - f) Accuracy assessment (Section 9.4).
- 9.1.2.2.5 Data that will allow an independent reviewer to validate each determination by tracing the instrument output (peak height, area, or other signal) to the final result. These data are to include:
- a) Sample numbers and other identifiers.
 - b) Extraction dates.
 - c) Analysis dates and times.
 - d) Analysis sequence/run chronology.
 - e) Sample weight or volume (Section 11).
 - f) Extract volume prior to each cleanup step (Section 13).
 - g) Extract volume after each cleanup step (Section 13).
 - h) Final extract volume prior to injection (Section 14).
 - I) Injection volume (Section 14.3).
 - j) Dilution data, differentiating between dilution of a sample or extract (Section 17.5).
 - k) Instrument and operating conditions.
 - l) Column (dimensions, liquid phase, solid support, film thickness, etc).
 - m) Operating conditions (temperatures, temperature program, flow rates).
 - n) Detector (type, operating conditions, etc).
 - o) Chromatograms, printer tapes, and other recordings of raw data.
 - p) Quantitation reports, data system outputs, and other data to link the raw data to the results reported.
- 9.1.3 Analyses of method blanks are required to demonstrate freedom from contamination (Section 4.3). The procedures and criteria for analysis of a method blank are described in Sections 9.5 and 15.6.
- 9.1.4 The laboratory shall spike all samples with labeled compounds to monitor method performance. This test is described in Section 9.3. When results of these spikes indicate atypical method performance for samples, the samples are diluted to bring method performance within acceptable limits. Procedures for dilution are given in Section 17.5.
- 9.1.5 The laboratory shall, on an ongoing basis, demonstrate through calibration verification and the analysis of the ongoing precision and recovery aliquot that

- the analytical system is in control. These procedures are described in Sections 15.1 through 15.5.
- 9.1.6 The laboratory shall maintain records to define the quality of data that is generated. Development of accuracy statements is described in Section 9.4.
- 9.2 Initial Precision and Recovery (IPR)—To establish the ability to generate acceptable precision and recovery, the analyst shall perform the following operations.
- 9.2.1 For low solids (aqueous) samples, extract, concentrate, and analyze four 1 L aliquots of reagent water spiked with the diluted labeled compound spiking solution (Section 7.10.3) and the precision and recovery standard (Section 7.14) according to the procedures in Sections 11 through 18. For an alternative sample matrix, four aliquots of the alternative reference matrix (Section 7.6) are used. All sample processing steps that are to be used for processing samples, including preparation (Section 11), extraction (Section 12), and cleanup (Section 13), shall be included in this test.
- 9.2.2 Using results of the set of four analyses, compute the average concentration (X) of the extracts in ng/mL and the standard deviation of the concentration (s) in ng/mL for each compound, by isotope dilution for CDDs/CDFs with a labeled analog, and by internal standard for 1,2,3,7,8,9-HxCDD, OCDF, and the labeled compounds.
- 9.2.3 For each CDD/CDF and labeled compound, compare s and X with the corresponding limits for initial precision and recovery in Table 6. If only 2,3,7,8-TCDD and 2,3,7,8-TCDF are to be determined, compare s and X with the corresponding limits for initial precision and recovery in Table 6a. If s and X for all compounds meet the acceptance criteria, system performance is acceptable and analysis of blanks and samples may begin. If, however, any individual s exceeds the precision limit or any individual X falls outside the range for accuracy, system performance is unacceptable for that compound. Correct the problem and repeat the test (Section 9.2).
- 9.3 The laboratory shall spike all samples with the diluted labeled compound spiking solution (Section 7.10.3) to assess method performance on the sample matrix.
- 9.3.1 Analyze each sample according to the procedures in Sections 11 through 18.
- 9.3.2 Compute the percent recovery of the labeled compounds and the cleanup standard using the internal standard method (Section 17.2).
- 9.3.3 The recovery of each labeled compound must be within the limits in Table 7 when all 2,3,7,8-substituted CDDs/CDFs are determined, and within the limits in Table 7a when only 2,3,7,8-TCDD and 2,3,7,8-TCDF are determined. If the recovery of any compound falls outside of these limits, method performance is unacceptable for that compound in that sample. To overcome such difficulties, water samples are diluted and smaller amounts of soils, sludges, sediments, and other matrices are reanalyzed per Section 18.4.

- 9.4 Recovery of labeled compounds from samples should be assessed and records should be maintained.
- 9.4.1 After the analysis of five samples of a given matrix type (water, soil, sludge, pulp, etc.) for which the labeled compounds pass the tests in Section 9.3, compute the average percent recovery (R) and the standard deviation of the percent recovery (S_R) for the labeled compounds only. Express the assessment as a percent recovery interval from $R-2S_R$ to $R+2S_R$ for each matrix. For example, if $R = 90\%$ and $S_R = 10\%$ for five analyses of pulp, the recovery interval is expressed as 70-110%.
- 9.4.2 Update the accuracy assessment for each labeled compound in each matrix on a regular basis (e.g., after each 5-10 new measurements).
- 9.5 Method Blanks—Reference matrix method blanks are analyzed to demonstrate freedom from contamination (Section 4.3).
- 9.5.1 Prepare, extract, clean up, and concentrate a method blank with each sample batch (samples of the same matrix started through the extraction process on the same 12-hour shift, to a maximum of 20 samples). The matrix for the method blank shall be similar to sample matrix for the batch, e.g., a 1 L reagent water blank (Section 7.6.1), high-solids reference matrix blank (Section 7.6.2), paper matrix blank (Section 7.6.3); tissue blank (Section 7.6.4) or alternative reference matrix blank (Section 7.6.5). Analyze the blank immediately after analysis of the OPR (Section 15.5) to demonstrate freedom from contamination.
- 9.5.2 If any 2,3,7,8-substituted CDD/CDF (Table 1) is found in the blank at greater than the minimum level (Table 2) or one-third the regulatory compliance level, whichever is greater; or if any potentially interfering compound is found in the blank at the minimum level for each level of chlorination given in Table 2 (assuming a response factor of 1 relative to the $^{13}\text{C}_{12}$ -1,2,3,4-TCDD internal standard for compounds not listed in Table 1), analysis of samples is halted until the blank associated with the sample batch shows no evidence of contamination at this level. All samples must be associated with an uncontaminated method blank before the results for those samples may be reported for regulatory compliance purposes.
- 9.6 QC Check Sample—Analyze the QC Check Sample (Section 7.16) periodically to assure the accuracy of calibration standards and the overall reliability of the analytical process. It is suggested that the QC Check Sample be analyzed at least quarterly.
- 9.7 The specifications contained in this method can be met if the apparatus used is calibrated properly and then maintained in a calibrated state. The standards used for calibration (Section 10), calibration verification (Section 15.3), and for initial (Section 9.2) and ongoing (Section 15.5) precision and recovery should be identical, so that the most precise results will be obtained. A GC/MS instrument will provide the most reproducible results if dedicated to the settings and conditions required for the analyses of CDDs/CDFs by this method.

- 9.8 Depending on specific program requirements, field replicates may be collected to determine the precision of the sampling technique, and spiked samples may be required to determine the accuracy of the analysis when the internal standard method is used.

10.0 Calibration

- 10.1 Establish the operating conditions necessary to meet the minimum retention times for the internal standards in Section 10.2.4 and the relative retention times for the CDDs/CDFs in Table 2.

10.1.1 Suggested GC operating conditions:

Injector temperature:	270°C
Interface temperature:	290°C
Initial temperature:	200°C
Initial time:	Two minutes
Temperature program:	200-220°C, at 5°C/minute
	220°C for 16 minutes
	220-235°C, at 5°C/minute
	235°C for seven minutes
	235-330°C, at 5°C/minute

NOTE: All portions of the column that connect the GC to the ion source shall remain at or above the interface temperature specified above during analysis to preclude condensation of less volatile compounds.

Optimize GC conditions for compound separation and sensitivity. Once optimized, the same GC conditions must be used for the analysis of all standards, blanks, IPR and OPR aliquots, and samples.

- 10.1.2 Mass spectrometer (MS) resolution—Obtain a selected ion current profile (SICP) of each analyte in Table 3 at the two exact m/z 's specified in Table 8 and at $\geq 10,000$ resolving power by injecting an authentic standard of the CDDs/CDFs either singly or as part of a mixture in which there is no interference between closely eluted components.

- 10.1.2.1 The analysis time for CDDs/CDFs may exceed the long-term mass stability of the mass spectrometer. Because the instrument is operated in the high-resolution mode, mass drifts of a few ppm (e.g., 5 ppm in mass) can have serious adverse effects on instrument performance. Therefore, a mass-drift correction is mandatory and a lock-mass m/z from PFK is used for drift correction. The lock-mass m/z is dependent on the exact m/z 's monitored within each descriptor, as shown in Table 8. The level of PFK metered into the HRMS during analyses should be adjusted so that the amplitude of the most intense selected lock-mass m/z signal (regardless of the descriptor number) does not exceed 10% of the full-scale deflection for a given set of detector parameters. Under those conditions, sensitivity changes that might occur during the analysis can be more effectively monitored.

NOTE: *Excessive PFK (or any other reference substance) may cause noise problems and contamination of the ion source necessitating increased frequency of source cleaning.*

- 10.1.2.2 If the HRMS has the capability to monitor resolution during the analysis, it is acceptable to terminate the analysis when the resolution falls below 10,000 to save reanalysis time.
- 10.1.2.3 Using a PFK molecular leak, tune the instrument to meet the minimum required resolving power of 10,000 (10% valley) at m/z 304.9824 (PFK) or any other reference signal close to m/z 304 (from TCDF). For each descriptor (Table 8), monitor and record the resolution and exact m/z 's of three to five reference peaks covering the mass range of the descriptor. The resolution must be greater than or equal to 10,000, and the deviation between the exact m/z and the theoretical m/z (Table 8) for each exact m/z monitored must be less than 5 ppm.
- 10.2 Ion Abundance Ratios, Minimum Levels, Signal-to-Noise Ratios, and Absolute Retention Times—Choose an injection volume of either 1 μL or 2 μL , consistent with the capability of the HRGC/HRMS instrument. Inject a 1 μL or 2 μL aliquot of the CS1 calibration solution (Table 4) using the GC conditions from Section 10.1.1. If only 2,3,7,8-TCDD and 2,3,7,8-TCDF are to be determined, the operating conditions and specifications below apply to analysis of those compounds only.
- 10.2.1 Measure the SICIP areas for each analyte, and compute the ion abundance ratios at the exact m/z 's specified in Table 8. Compare the computed ratio to the theoretical ratio given in Table 9.
- 10.2.1.1 The exact m/z 's to be monitored in each descriptor are shown in Table 8. Each group or descriptor shall be monitored in succession as a function of GC retention time to ensure that all CDDs/CDFs are detected. Additional m/z 's may be monitored in each descriptor, and the m/z 's may be divided among more than the five descriptors listed in Table 8, provided that the laboratory is able to monitor the m/z 's of all the CDDs/CDFs that may elute from the GC in a given retention-time window. If only 2,3,7,8-TCDD and 2,3,7,8-TCDF are to be determined, the descriptors may be modified to include only the exact m/z 's for the tetra- and penta-isomers, the diphenyl ethers, and the lock m/z 's.
- 10.2.1.2 The mass spectrometer shall be operated in a mass-drift correction mode, using perfluorokerosene (PFK) to provide lock m/z 's. The lock-mass for each group of m/z 's is shown in Table 8. Each lock mass shall be monitored and shall not vary by more than $\pm 20\%$ throughout its respective retention time window. Variations of the lock mass by more than 20% indicate the presence of coeluting interferences that may significantly reduce the sensitivity of the mass spectrometer. Reinjection of another aliquot of the sample extract will not resolve the problem. Additional cleanup of the extract may be required to remove the interferences.

- 10.2.2 All CDDs/CDFs and labeled compounds in the CS1 standard shall be within the QC limits in Table 9 for their respective ion abundance ratios; otherwise, the mass spectrometer shall be adjusted and this test repeated until the m/z ratios fall within the limits specified. If the adjustment alters the resolution of the mass spectrometer, resolution shall be verified (Section 10.1.2) prior to repeat of the test.
- 10.2.3 Verify that the HRGC/HRMS instrument meets the minimum levels in Table 2. The peaks representing the CDDs/CDFs and labeled compounds in the CS1 calibration standard must have signal-to-noise ratios (S/N) greater than or equal to 10.0. Otherwise, the mass spectrometer shall be adjusted and this test repeated until the minimum levels in Table 2 are met.
- 10.2.4 The absolute retention time of $^{13}\text{C}_{12}$ -1,2,3,4-TCDD (Section 7.12) shall exceed 25.0 minutes on the DB-5 column, and the retention time of $^{13}\text{C}_{12}$ -1,2,3,4-TCDD shall exceed 15.0 minutes on the DB-225 column; otherwise, the GC temperature program shall be adjusted and this test repeated until the above-stated minimum retention time criteria are met.
- 10.3 Retention-Time Windows—Analyze the window defining mixtures (Section 7.15) using the optimized temperature program in Section 10.1. Table 5 gives the elution order (first/last) of the window-defining compounds. If 2,3,7,8-TCDD and 2,3,7,8-TCDF only are to be analyzed, this test is not required.
- 10.4 Isomer Specificity
- 10.4.1 Analyze the isomer specificity test standards (Section 7.15) using the procedure in Section 14 and the optimized conditions for sample analysis (Section 10.1.1).
- 10.4.2 Compute the percent valley between the GC peaks that elute most closely to the 2,3,7,8-TCDD and TCDF isomers, on their respective columns, per Figures 6 and 7.
- 10.4.3 Verify that the height of the valley between the most closely eluted isomers and the 2,3,7,8-substituted isomers is less than 25% (computed as $100 \times y$ in Figures 6 and 7). If the valley exceeds 25%, adjust the analytical conditions and repeat the test or replace the GC column and recalibrate (Sections 10.1.2 through 10.7).
- 10.5 Calibration by Isotope Dilution—Isotope dilution calibration is used for the 15 2,3,7,8-substituted CDDs/CDFs for which labeled compounds are added to samples prior to extraction. The reference compound for each CDD/CDF compound is shown in Table 2.
- 10.5.1 A calibration curve encompassing the concentration range is prepared for each compound to be determined. The relative response (RR) (labeled to native) vs. concentration in standard solutions is plotted or computed using a linear regression. Relative response is determined according to the procedures described below. Five calibration points are employed.
- 10.5.2 The response of each CDD/CDF relative to its labeled analog is determined using the area responses of both the primary and secondary exact m/z 's specified in Table 8, for each calibration standard, as follows:

$$RR = \frac{(A1_n + A2_n) C_1}{(A1_1 + A2_1) C_n}$$

where,

$A1_n$ and $A2_n$ = The areas of the primary and secondary m/z's for the CDD/CDF.

$A1_1$ and $A2_1$ = The areas of the primary and secondary m/z's for the labeled compound.

C_1 = The concentration of the labeled compound in the calibration standard (Table 4).

C_n = The concentration of the native compound in the calibration standard (Table 4).

10.5.3 To calibrate the analytical system by isotope dilution, inject a volume of calibration standards CS1 through CS5 (Section 7.13 and Table 4) identical to the volume chosen in Section 10.2, using the procedure in Section 14 and the conditions in Section 10.1.1 and Table 2. Compute the relative response (RR) at each concentration.

10.5.4 Linearity—If the relative response for any compound is constant (less than 20% coefficient of variation) over the five-point calibration range, an averaged relative response may be used for that compound; otherwise, the complete calibration curve for that compound shall be used over the five-point calibration range.

10.6 Calibration by Internal Standard—The internal standard method is applied to determination of 1,2,3,7,8,9-HxCDD (Section 17.1.2), OCDF (Section 17.1.1), the non-2,3,7,8-substituted compounds, and to the determination of labeled compounds for intralaboratory statistics (Sections 9.4 and 15.5.4).

10.6.1 Response factors—Calibration requires the determination of response factors (RF) defined by the following equation:

$$RF = \frac{(A1_s + A2_s) C_{is}}{(A1_{is} + A2_{is}) C_s}$$

where,

$A1_s$ and $A2_s$ = The areas of the primary and secondary m/z's for the CDD/CDF.

$A1_{is}$ and $A2_{is}$ = The areas of the primary and secondary m/z's for the internal standard

C_{is} = The concentration of the internal standard (Table 4).

C_s = The concentration of the compound in the calibration standard (Table 4).

NOTE: There is only one m/z for $^{37}Cl_4$ -2,3,7,8-TCDD. See Table 8.

10.6.2 To calibrate the analytical system by internal standard, inject 1.0 μ L or 2.0 μ L of calibration standards CS1 through CS5 (Section 7.13 and Table 4) using the procedure in Section 14 and the conditions in Section 10.1.1 and Table 2. Compute the response factor (RF) at each concentration.

- 10.6.3 Linearity—If the response factor (RF) for any compound is constant (less than 35% coefficient of variation) over the five-point calibration range, an averaged response factor may be used for that compound; otherwise, the complete calibration curve for that compound shall be used over the five-point range.
- 10.7 Combined Calibration—By using calibration solutions (Section 7.13 and Table 4) containing the CDDs/CDFs and labeled compounds and the internal standards, a single set of analyses can be used to produce calibration curves for the isotope dilution and internal standard methods. These curves are verified each shift (Section 15.3) by analyzing the calibration verification standard (VER, Table 4). Recalibration is required if any of the calibration verification criteria (Section 15.3) cannot be met.
- 10.8 Data Storage—MS data shall be collected, recorded, and stored.
- 10.8.1 Data acquisition—The signal at each exact m/z shall be collected repetitively throughout the monitoring period and stored on a mass storage device.
- 10.8.2 Response factors and multipoint calibrations—The data system shall be used to record and maintain lists of response factors (response ratios for isotope dilution) and multipoint calibration curves. Computations of relative standard deviation (coefficient of variation) shall be used to test calibration linearity. Statistics on initial performance (Section 9.2) and ongoing performance (Section 15.5) should be computed and maintained, either on the instrument data system, or on a separate computer system.

11.0 Sample Preparation

- 11.1 Sample preparation involves modifying the physical form of the sample so that the CDDs/CDFs can be extracted efficiently. In general, the samples must be in a liquid form or in the form of finely divided solids in order for efficient extraction to take place. Table 10 lists the phases and suggested quantities for extraction of various sample matrices.

For samples known or expected to contain high levels of the CDDs/CDFs, the smallest sample size representative of the entire sample should be used (see Section 17.5).

For all samples, the blank and IPR/OPR aliquots must be processed through the same steps as the sample to check for contamination and losses in the preparation processes.

- 11.1.1 For samples that contain particles, percent solids and particle size are determined using the procedures in Sections 11.2 and 11.3, respectively.
- 11.1.2 Aqueous samples—Because CDDs/CDFs may be bound to suspended particles, the preparation of aqueous samples is dependent on the solids content of the sample.
- 11.1.2.1 Aqueous samples visibly absent particles are prepared per Section 11.4 and extracted directly using the separatory funnel or SPE techniques in Sections 12.1 or 12.2, respectively.

- 11.1.2.2 Aqueous samples containing visible particles and containing one percent suspended solids or less are prepared using the procedure in Section 11.4. After preparation, the sample is extracted directly using the SPE technique in 12.2 or filtered per Section 11.4.3. After filtration, the particles and filter are extracted using the SDS procedure in Section 12.3 and the filtrate is extracted using the separatory funnel procedure in Section 12.1.
- 11.1.2.3 For aqueous samples containing greater than one percent solids, a sample aliquot sufficient to provide 10 g of dry solids is used, as described in Section 11.5.
- 11.1.3 Solid samples are prepared using the procedure described in Section 11.5 followed by extraction via the SDS procedure in Section 12.3.
- 11.1.4 Multiphase samples—The phase(s) containing the CDDs/CDFs is separated from the non-CDD/CDF phase using pressure filtration and centrifugation, as described in Section 11.6. The CDDs/CDFs will be in the organic phase in a multiphase sample in which an organic phase exists.
- 11.1.5 Procedures for grinding, homogenization, and blending of various sample phases are given in Section 11.7.
- 11.1.6 Tissue samples—Preparation procedures for fish and other tissues are given in Section 11.8.

11.2 Determination of Percent Suspended Solids

NOTE: *This aliquot is used for determining the solids content of the sample, not for determination of CDDs/CDFs.*

- 11.2.1 Aqueous liquids and multi-phase samples consisting of mainly an aqueous phase.
- 11.2.1.1 Dessicate and weigh a GF/D filter (Section 6.5.3) to three significant figures.
- 11.2.1.2 Filter 10.0 ±0.02 mL of well-mixed sample through the filter.
- 11.2.1.3 Dry the filter a minimum of 12 hours at 110 ±5°C and cool in a dessicator.
- 11.2.1.4 Calculate percent solids as follows:

$$\% \text{solids} = \frac{\text{weight of sample aliquot after drying (g)} - \text{weight of filter (g)}}{10 \text{ g}} \times 100$$

- 11.2.2 Non-aqueous liquids, solids, semi-solid samples, and multi-phase samples in which the main phase is not aqueous; but not tissues.
- 11.2.2.1 Weigh 5-10 g of sample to three significant figures in a tared beaker.

11.2.2.2 Dry a minimum of 12 hours at 110 ±5°C, and cool in a dessicator.

11.2.2.3 Calculate percent solids as follows:

$$\% \text{ solids} = \frac{\text{weight of sample aliquot after drying}}{\text{weight of sample aliquot before drying}} \times 100$$

11.3 Determination of Particle Size

11.3.1 Spread the dried sample from Section 11.2.2.2 on a piece of filter paper or aluminum foil in a fume hood or glove box.

11.3.2 Estimate the size of the particles in the sample. If the size of the largest particles is greater than 1 mm, the particle size must be reduced to 1 mm or less prior to extraction using the procedures in Section 11.7.

11.4 Preparation of Aqueous Samples Containing 1% Suspended Solids or Less

11.4.1 Aqueous samples visibly absent particles are prepared per the procedure below and extracted directly using the separatory funnel or SPE techniques in Sections 12.1 or 12.2, respectively. Aqueous samples containing visible particles and one percent suspended solids or less are prepared using the procedure below and extracted using either the SPE technique in Section 12.2 or further prepared using the filtration procedure in Section 11.4.3. The filtration procedure is followed by SDS extraction of the filter and particles (Section 12.3) and separatory funnel extraction of the filtrate (Section 12.1). The SPE procedure is followed by SDS extraction of the filter and disk.

11.4.2 Preparation of sample and QC aliquots

11.4.2.1 Mark the original level of the sample on the sample bottle for reference. Weigh the sample plus bottle to ±1 g.

11.4.2.2 Spike 1.0 mL of the diluted labeled-compound spiking solution (Section 7.10.3) into the sample bottle. Cap the bottle and mix the sample by careful shaking. Allow the sample to equilibrate for one to two hours, with occasional shaking.

11.4.2.3 For each sample or sample batch (to a maximum of 20 samples) to be extracted during the same 12-hour shift, place two 1.0 L aliquots of reagent water in clean sample bottles or flasks.

11.4.2.4 Spike 1.0 mL of the diluted labeled-compound spiking solution (Section 7.10.3) into both reagent water aliquots. One of these aliquots will serve as the method blank.

11.4.2.5 Spike 1.0 mL of the PAR standard (Section 7.14) into the remaining reagent water aliquot. This aliquot will serve as the OPR (Section 15.5).

- 11.4.2.6 If SPE is to be used, add 5 mL of methanol to the sample, cap and shake the sample to mix thoroughly, and proceed to Section 12.2 for extraction. If SPE is not to be used, and the sample is visibly absent particles, proceed to Section 12.1 for extraction. If SPE is not to be used and the sample contains visible particles, proceed to the following section for filtration of particles.

11.4.3 Filtration of particles

- 11.4.3.1 Assemble a Buchner funnel (Section 6.5.5) on top of a clean filtration flask. Apply vacuum to the flask, and pour the entire contents of the sample bottle through a glass-fiber filter (Section 6.5.6) in the Buchner funnel, swirling the sample remaining in the bottle to suspend any particles.
- 11.4.3.2 Rinse the sample bottle twice with approximately 5 mL portions of reagent water to transfer any remaining particles onto the filter.
- 11.4.3.3 Rinse any particles off the sides of the Buchner funnel with small quantities of reagent water.
- 11.4.3.4 Weigh the empty sample bottle to ± 1 g. Determine the weight of the sample by difference. Save the bottle for further use.
- 11.4.3.5 Extract the filtrate using the separatory funnel procedure in Section 12.1.
- 11.4.3.6 Extract the filter containing the particles using the SDS procedure in Section 12.3.

11.5 Preparation of Samples Containing Greater Than 1% Solids

- 11.5.1 Weigh a well-mixed aliquot of each sample (of the same matrix type) sufficient to provide 10 g of dry solids (based on the solids determination in Section 11.2) into a clean beaker or glass jar.
- 11.5.2 Spike 1.0 mL of the diluted labeled compound spiking solution (Section 7.10.3) into the sample.
- 11.5.3 For each sample or sample batch (to a maximum of 20 samples) to be extracted during the same 12-hour shift, weigh two 10 g aliquots of the appropriate reference matrix (Section 7.6) into clean beakers or glass jars.
- 11.5.4 Spike 1.0 mL of the diluted labeled compound spiking solution (Section 7.10.3) into each reference matrix aliquot. One aliquot will serve as the method blank. Spike 1.0 mL of the PAR standard (Section 7.14) into the other reference matrix aliquot. This aliquot will serve as the OPR (Section 15.5).
- 11.5.5 Stir or tumble and equilibrate the aliquots for one to two hours.

- 11.5.6 Decant excess water. If necessary to remove water, filter the sample through a glass-fiber filter and discard the aqueous liquid.
- 11.5.7 If particles >1mm are present in the sample (as determined in Section 11.3.2), spread the sample on clean aluminum foil in a hood. After the sample is dry, grind to reduce the particle size (Section 11.7).
- 11.5.8 Extract the sample and QC aliquots using the SDS procedure in Section 12.3.
- 11.6 Multiphase Samples
- 11.6.1 Using the percent solids determined in Section 11.2.1 or 11.2.2, determine the volume of sample that will provide 10 g of solids, up to 1 L of sample.
- 11.6.2 Pressure filter the amount of sample determined in Section 11.6.1 through Whatman GF/D glass-fiber filter paper (Section 6.5.3). Pressure filter the blank and OPR aliquots through GF/D papers also. If necessary to separate the phases and/or settle the solids, centrifuge these aliquots prior to filtration.
- 11.6.3 Discard any aqueous phase (if present). Remove any non-aqueous liquid present and reserve the maximum amount filtered from the sample (Section 11.6.1) or 10 g, whichever is less, for combination with the solid phase (Section 12.3.5).
- 11.6.4 If particles >1mm are present in the sample (as determined in Section 11.3.2) and the sample is capable of being dried, spread the sample and QC aliquots on clean aluminum foil in a hood. After the aliquots are dry or if the sample cannot be dried, reduce the particle size using the procedures in Section 11.7 and extract the reduced particles using the SDS procedure in Section 12.3. If particles >1mm are not present, extract the particles and filter in the sample and QC aliquots directly using the SDS procedure in Section 12.3.
- 11.7 Sample grinding, homogenization, or blending—Samples with particle sizes greater than 1 mm (as determined in Section 11.3.2) are subjected to grinding, homogenization, or blending. The method of reducing particle size to less than 1 mm is matrix-dependent. In general, hard particles can be reduced by grinding with a mortar and pestle. Softer particles can be reduced by grinding in a Wiley mill or meat grinder, by homogenization, or in a blender.
- 11.7.1 Each size-reducing preparation procedure on each matrix shall be verified by running the tests in Section 9.2 before the procedure is employed routinely.
- 11.7.2 The grinding, homogenization, or blending procedures shall be carried out in a glove box or fume hood to prevent particles from contaminating the work environment.
- 11.7.3 Grinding—Certain papers and pulps, slurries, and amorphous solids can be ground in a Wiley mill or heavy duty meat grinder. In some cases, reducing the temperature of the sample to freezing or to dry ice or liquid nitrogen temperatures can aid in the grinding process. Grind the sample aliquots from Section 11.5.7 or 11.6.4 in a clean grinder. Do not allow the sample temperature

to exceed 50°C. Grind the blank and reference matrix aliquots using a clean grinder.

11.7.4 Homogenization or blending—Particles that are not ground effectively, or particles greater than 1 mm in size after grinding, can often be reduced in size by high speed homogenization or blending. Homogenize and/or blend the particles or filter from Section 11.5.7 or 11.6.4 for the sample, blank, and OPR aliquots.

11.7.5 Extract the aliquots using the SDS procedure in Section 12.3.

11.8 Fish and Other Tissues—Prior to processing tissue samples, the laboratory must determine the exact tissue to be analyzed. Common requests for analysis of fish tissue include whole fish—skin on, whole fish—skin removed, edible fish fillets (filleted in the field or by the laboratory), specific organs, and other portions. Once the appropriate tissue has been determined, the sample must be homogenized.

11.8.1 Homogenization

11.8.1.1 Samples are homogenized while still frozen, where practical. If the laboratory must dissect the whole fish to obtain the appropriate tissue for analysis, the unused tissues may be rapidly refrozen and stored in a clean glass jar for subsequent use.

11.8.1.2 Each analysis requires 10 g of tissue (wet weight). Therefore, the laboratory should homogenize at least 20 g of tissue to allow for re-extraction of a second aliquot of the same homogenized sample, if re-analysis is required. When whole fish analysis is necessary, the entire fish is homogenized.

11.8.1.3 Homogenize the sample in a tissue homogenizer (Section 6.3.3) or grind in a meat grinder (Section 6.3.4). Cut tissue too large to feed into the grinder into smaller pieces. To assure homogeneity, grind three times.

11.8.1.4 Transfer approximately 10 g (wet weight) of homogenized tissue to a clean, tared, 400-500 mL beaker. For the alternate HCl digestion/extraction, transfer the tissue to a clean, tared 500-600 mL wide-mouth bottle. Record the weight to the nearest 10 mg.

11.8.1.5 Transfer the remaining homogenized tissue to a clean jar with a fluoropolymer-lined lid. Seal the jar and store the tissue at <-10°C. Return any tissue that was not homogenized to its original container and store at <-10°C.

11.8.2 QC aliquots

11.8.2.1 Prepare a method blank by adding approximately 10 g of the oily liquid reference matrix (Section 7.6.4) to a 400-500 mL beaker. For the alternate HCl digestion/extraction, add the reference matrix to a 500-600 mL wide-mouth bottle. Record the weight to the nearest 10 mg.

11.8.2.2 Prepare a precision and recovery aliquot by adding approximately 10 g of the oily liquid reference matrix (Section 7.6.4) to a separate 400-500 mL beaker or wide-mouth bottle, depending on the extraction procedure to be used. Record the weight to the nearest 10 mg. If the initial precision and recovery test is to be performed, use four aliquots; if the ongoing precision and recovery test is to be performed, use a single aliquot.

11.8.3 Spiking

11.8.3.1 Spike 1.0 mL of the labeled compound spiking solution (Section 7.10.3) into the sample, blank, and OPR aliquot.

11.8.3.2 Spike 1.0 mL of the PAR standard (Section 7.14) into the OPR aliquot.

11.8.4 Extract the aliquots using the procedures in Section 12.4.

12.0 Extraction and Concentration

Extraction procedures include separatory funnel (Section 12.1) and solid phase (Section 12.2) for aqueous liquids; Soxhlet/Dean-Stark (Section 12.3) for solids, filters, and SPE disks; and Soxhlet extraction (Section 12.4.1) and HCl digestion (Section 12.4.2) for tissues. Acid/base back-extraction (Section 12.5) is used for initial cleanup of extracts.

Macro-concentration procedures include rotary evaporation (Section 12.6.1), heating mantle (Section 12.6.2), and Kuderna-Danish (K-D) evaporation (Section 12.6.3). Micro-concentration uses nitrogen blowdown (Section 12.7).

12.1 Separatory funnel extraction of filtrates and of aqueous samples visibly absent particles.

12.1.1 Pour the spiked sample (Section 11.4.2.2) or filtrate (Section 11.4.3.5) into a 2 L separatory funnel. Rinse the bottle or flask twice with 5 mL of reagent water and add these rinses to the separatory funnel.

12.1.2 Add 60 mL methylene chloride to the empty sample bottle (Section 12.1.1), seal, and shake 60 seconds to rinse the inner surface. Transfer the solvent to the separatory funnel, and extract the sample by shaking the funnel for two minutes with periodic venting. Allow the organic layer to separate from the aqueous phase for a minimum of 10 minutes. If an emulsion forms and is more than one-third the volume of the solvent layer, employ mechanical techniques to complete the phase separation (see note below). Drain the methylene chloride extract through a solvent-rinsed glass funnel approximately one-half full of granular

anhydrous sodium sulfate (Section 7.2.1) supported on clean glass-fiber paper into a solvent-rinsed concentration device (Section 12.6).

NOTE: *If an emulsion forms, the analyst must employ mechanical techniques to complete the phase separation. The optimum technique depends upon the sample, but may include stirring, filtration through glass wool, use of phase separation paper, centrifugation, use of an ultrasonic bath with ice, addition of NaCl, or other physical methods. Alternatively, solid-phase or other extraction techniques may be used to prevent emulsion formation. Any alternative technique is acceptable so long as the requirements in Section 9 are met.*

Experience with aqueous samples high in dissolved organic materials (e.g., paper mill effluents) has shown that acidification of the sample prior to extraction may reduce the formation of emulsions. Paper industry methods suggest that the addition of up to 400 mL of ethanol to a 1 L effluent sample may also reduce emulsion formation. However, studies by EPA suggest that the effect may be a result of sample dilution, and that the addition of reagent water may serve the same function. Mechanical techniques may still be necessary to complete the phase separation. If either acidification or addition of ethanol is utilized, the laboratory must perform the startup tests described in Section 9.2 using the same techniques.

12.1.3 Extract the water sample two more times with 60 mL portions of methylene chloride. Drain each portion through the sodium sulfate into the concentrator. After the third extraction, rinse the separatory funnel with at least 20 mL of methylene chloride, and drain this rinse through the sodium sulfate into the concentrator. Repeat this rinse at least twice. Set aside the funnel with sodium sulfate if the extract is to be combined with the extract from the particles.

12.1.4 Concentrate the extract using one of the macro-concentration procedures in Section 12.6.

12.1.4.1 If the extract is from a sample visibly absent particles (Section 11.1.2.1), adjust the final volume of the concentrated extract to approximately 10 mL with hexane, transfer to a 250 mL separatory funnel, and back-extract using the procedure in Section 12.5.

12.1.4.2 If the extract is from the aqueous filtrate (Section 11.4.3.5), set aside the concentration apparatus for addition of the SDS extract from the particles (Section 12.3.9.1.2).

12.2 SPE of Samples Containing Less Than 1% Solids (References 19-20)

12.2.1 Disk preparation

12.2.1.1 Place an SPE disk on the base of the filter holder (Figure 4) and wet with toluene. While holding a GMF 150 filter above the SPE disk with tweezers, wet the filter with toluene and lay the filter on the SPE disk, making sure that air is not trapped between the filter and disk. Clamp the filter and SPE disk between the 1 L glass reservoir and the vacuum filtration flask.

- 12.2.1.2 Rinse the sides of the filtration flask with approx 15 mL of toluene using a squeeze bottle or syringe. Apply vacuum momentarily until a few drops appear at the drip tip. Release the vacuum and allow the filter/disk to soak for approx one minute. Apply vacuum and draw all of the toluene through the filter/disk. Repeat the wash step with approx 15 mL of acetone and allow the filter/disk to air dry.
- 12.2.1.3 Re-wet the filter/disk with approximately 15 mL of methanol, allowing the filter/disk to soak for approximately one minute. Pull the methanol through the filter/disk using the vacuum, but retain a layer of methanol approximately 1 mm thick on the filter. Do not allow the disk to go dry from this point until the end of the extraction.
- 12.2.1.4 Rinse the filter/disk with two 50-mL portions of reagent water by adding the water to the reservoir and pulling most through, leaving a layer of water on the surface of the filter.

12.2.2 Extraction

- 12.2.2.1 Pour the spiked sample (Section 11.4.2.2), blank (Section 11.4.2.4), or IPR/OPR aliquot (Section 11.4.2.5) into the reservoir and turn on the vacuum to begin the extraction. Adjust the vacuum to complete the extraction in no less than 10 minutes. For samples containing a high concentration of particles (suspended solids), filtration times may be eight hours or longer.
- 12.2.2.2 Before all of the sample has been pulled through the filter/disk, rinse the sample bottle with approximately 50 mL of reagent water to remove any solids, and pour into the reservoir. Pull through the filter/disk. Use additional reagent water rinses until all visible solids are removed.
- 12.2.2.3 Before all of the sample and rinses have been pulled through the filter/disk, rinse the sides of the reservoir with small portions of reagent water.
- 12.2.2.4 Allow the filter/disk to dry, then remove the filter and disk and place in a glass Petri dish. Extract the filter and disk per Section 12.3.

12.3 SDS Extraction of Samples Containing Particles, and of Filters and/or Disks

- 12.3.1 Charge a clean extraction thimble (Section 6.4.2.2) with 5.0 g of 100/200 mesh silica (Section 7.5.1.1) topped with 100 g of quartz sand (Section 7.3.2).

NOTE: Do not disturb the silica layer throughout the extraction process.

- 12.3.2 Place the thimble in a clean extractor. Place 30-40 mL of toluene in the receiver and 200-250 mL of toluene in the flask.

- 12.3.3 Pre-extract the glassware by heating the flask until the toluene is boiling. When properly adjusted, one to two drops of toluene will fall per second from the condenser tip into the receiver. Extract the apparatus for a minimum of three hours.
- 12.3.4 After pre-extraction, cool and disassemble the apparatus. Rinse the thimble with toluene and allow to air dry.
- 12.3.5 Load the wet sample, filter, and/or disk from Section 11.4.3.6, 11.5.8, 11.6.4, 11.7.3, 11.7.4, or 12.2.2.4 and any nonaqueous liquid from Section 11.6.3 into the thimble and manually mix into the sand layer with a clean metal spatula, carefully breaking up any large lumps of sample.
- 12.3.6 Reassemble the pre-extracted SDS apparatus, and add a fresh charge of toluene to the receiver and reflux flask. Apply power to the heating mantle to begin refluxing. Adjust the reflux rate to match the rate of percolation through the sand and silica beds until water removal lessens the restriction to toluene flow. Frequently check the apparatus for foaming during the first two hours of extraction. If foaming occurs, reduce the reflux rate until foaming subsides.
- 12.3.7 Drain the water from the receiver at one to two hours and eight to nine hours, or sooner if the receiver fills with water. Reflux the sample for a total of 16-24 hours. Cool and disassemble the apparatus. Record the total volume of water collected.
- 12.3.8 Remove the distilling flask. Drain the water from the Dean-Stark receiver and add any toluene in the receiver to the extract in the flask.
- 12.3.9 Concentrate the extract using one of the macro-concentration procedures in Section 12.6 per the following:
- 12.3.9.1 Extracts from the particles in an aqueous sample containing less than 1% solids (Section 11.4.3.6).
 - 12.3.9.1.1 Concentrate the extract to approximately 5 mL using the rotary evaporator or heating mantle procedures in Section 12.6.1 or 12.6.2.
 - 12.3.9.1.2 Quantitatively transfer the extract through the sodium sulfate (Section 12.1.3) into the apparatus that was set aside (Section 12.1.4.2) and reconcentrate to the level of the toluene.
 - 12.3.9.1.3 Adjust to approximately 10 mL with hexane, transfer to a 250 mL separatory funnel, and proceed with back-extraction (Section 12.5).
 - 12.3.9.2 Extracts from particles (Sections 11.5 through 11.6) or from the SPE filter and disk (Section 12.2.2.4)—Concentrate to approximately 10 mL using the rotary evaporator or heating mantle (Section 12.6.1

or 12.6.2), transfer to a 250 mL separatory funnel, and proceed with back-extraction (Section 12.5).

12.4 Extraction of Tissue—Two procedures are provided for tissue extraction.

12.4.1 Soxhlet extraction (Reference 21)

- 12.4.1.1 Add 30-40 g of powdered anhydrous sodium sulfate to each of the beakers (Section 11.8.4) and mix thoroughly. Cover the beakers with aluminum foil and allow to equilibrate for 12-24 hours. Remix prior to extraction to prevent clumping.
- 12.4.1.2 Assemble and pre-extract the Soxhlet apparatus per Sections 12.3.1 through 12.3.4, except use the methylene chloride:hexane (1:1) mixture for the pre-extraction and rinsing and omit the quartz sand. The Dean-Stark moisture trap may also be omitted, if desired.
- 12.4.1.3 Reassemble the pre-extracted Soxhlet apparatus and add a fresh charge of methylene chloride:hexane to the reflux flask.
- 12.4.1.4 Transfer the sample/sodium sulfate mixture (Section 12.4.1.1) to the Soxhlet thimble, and install the thimble in the Soxhlet apparatus.
- 12.4.1.5 Rinse the beaker with several portions of solvent mixture and add to the thimble. Fill the thimble/receiver with solvent. Extract for 18-24 hours.
- 12.4.1.6 After extraction, cool and disassemble the apparatus.
- 12.4.1.7 Quantitatively transfer the extract to a macro-concentration device (Section 12.6), and concentrate to near dryness. Set aside the concentration apparatus for re-use.
- 12.4.1.8 Complete the removal of the solvent using the nitrogen blowdown procedure (Section 12.7) and a water bath temperature of 60°C. Weigh the receiver, record the weight, and return the receiver to the blowdown apparatus, concentrating the residue until a constant weight is obtained.
- 12.4.1.9 Percent lipid determination—The lipid content is determined by extraction of tissue with the same solvent system (methylene chloride:hexane) that was used in EPA's National Dioxin Study (Reference 22) so that lipid contents are consistent with that study.
- 12.4.1.9.1 Redissolve the residue in the receiver in hexane and spike 1.0 mL of the cleanup standard (Section 7.11) into the solution.

12.4.1.9.2 Transfer the residue/hexane to the anthropogenic isolation column (Section 13.7.1) or bottle for the acidified silica gel batch cleanup (Section 13.7.2), retaining the boiling chips in the concentration apparatus. Use several rinses to assure that all material is transferred. If necessary, sonicate or heat the receiver slightly to assure that all material is re-dissolved. Allow the receiver to dry. Weigh the receiver and boiling chips.

12.4.1.9.3 Calculate the lipid content to the nearest three significant figures as follows:

$$\text{Percent lipid} = \frac{\text{Weight of residue (g)}}{\text{Weight of tissue (g)}} \times 100$$

12.4.1.9.4 It is not necessary to determine the lipid content of the blank, IPR, or OPR aliquots.

12.4.2 HCl digestion/extraction and concentration (References 23-26)

12.4.2.1 Add 200 mL of 6 N HCl and 200 mL of methylene chloride:hexane (1:1) to the sample and QC aliquots (Section 11.8.4).

12.4.2.2 Cap and shake each bottle one to three times. Loosen the cap in a hood to vent excess pressure. Shake each bottle for 10-30 seconds and vent.

12.4.2.3 Tightly cap and place on shaker. Adjust the shaker action and speed so that the acid, solvent, and tissue are in constant motion. However, take care to avoid such violent action that the bottle may be dislodged from the shaker. Shake for 12-24 hours.

12.4.2.4 After digestion, remove the bottles from the shaker. Allow the bottles to stand so that the solvent and acid layers separate.

12.4.2.5 Decant the solvent through a glass funnel with glass-fiber filter (Sections 6.5.2 through 6.5.3) containing approximately 10 g of granular anhydrous sodium sulfate (Section 7.2.1) into a macro-concentration apparatus (Section 12.6). Rinse the contents of the bottle with two 25 mL portions of hexane and pour through the sodium sulfate into the apparatus.

12.4.2.6 Concentrate the solvent to near dryness using a macro-concentration procedure (Section 12.6).

12.4.2.7 Complete the removal of the solvent using the nitrogen blowdown apparatus (Section 12.7) and a water bath temperature of 60°C. Weigh the receiver, record the weight, and return the receiver to the blowdown apparatus, concentrating the residue until a constant weight is obtained.

- 12.4.2.8 Percent lipid determination—The lipid content is determined in the same solvent system [methylene chloride:hexane (1:1)] that was used in EPA's National Dioxin Study (Reference 22) so that lipid contents are consistent with that study.
- 12.4.2.8.1 Redissolve the residue in the receiver in hexane and spike 1.0 mL of the cleanup standard (Section 7.11) into the solution.
- 12.4.2.8.2 Transfer the residue/hexane to the narrow-mouth 100-200 mL bottle retaining the boiling chips in the receiver. Use several rinses to assure that all material is transferred, to a maximum hexane volume of approximately 70 mL. Allow the receiver to dry. Weigh the receiver and boiling chips.
- 12.4.2.8.3 Calculate the percent lipid per Section 12.4.1.9.3. It is not necessary to determine the lipid content of the blank, IPR, or OPR aliquots.
- 12.4.2.9 Clean up the extract per Section 13.7.3.

12.5 Back-Extraction with Base and Acid

- 12.5.1 Spike 1.0 mL of the cleanup standard (Section 7.11) into the separatory funnels containing the sample and QC extracts from Section 12.1.4.1, 12.3.9.1.3, or 12.3.9.2.
- 12.5.2 Partition the extract against 50 mL of potassium hydroxide solution (Section 7.1.1). Shake for two minutes with periodic venting into a hood. Remove and discard the aqueous layer. Repeat the base washing until no color is visible in the aqueous layer, to a maximum of four washings. Minimize contact time between the extract and the base to prevent degradation of the CDDs/CDFs. Stronger potassium hydroxide solutions may be employed for back-extraction, provided that the laboratory meets the specifications for labeled compound recovery and demonstrates acceptable performance using the procedure in Section 9.2.
- 12.5.3 Partition the extract against 50 mL of sodium chloride solution (Section 7.1.4) in the same way as with base. Discard the aqueous layer.
- 12.5.4 Partition the extract against 50 mL of sulfuric acid (Section 7.1.2) in the same way as with base. Repeat the acid washing until no color is visible in the aqueous layer, to a maximum of four washings.
- 12.5.5 Repeat the partitioning against sodium chloride solution and discard the aqueous layer.
- 12.5.6 Pour each extract through a drying column containing 7-10 cm of granular anhydrous sodium sulfate (Section 7.2.1). Rinse the separatory funnel with 30-50 mL of solvent, and pour through the drying column. Collect each extract in a round-bottom flask. Re-concentrate the sample and QC aliquots per Sections 12.6 through 12.7, and clean up the samples and QC aliquots per Section 13.

12.6 Macro-Concentration—Extracts in toluene are concentrated using a rotary evaporator or a heating mantle; extracts in methylene chloride or hexane are concentrated using a rotary evaporator, heating mantle, or Kuderna-Danish apparatus.

12.6.1 Rotary evaporation—Concentrate the extracts in separate round-bottom flasks.

12.6.1.1 Assemble the rotary evaporator according to manufacturer's instructions, and warm the water bath to 45°C. On a daily basis, preclean the rotary evaporator by concentrating 100 mL of clean extraction solvent through the system. Archive both the concentrated solvent and the solvent in the catch flask for a contamination check if necessary. Between samples, three 2-3 mL aliquots of solvent should be rinsed down the feed tube into a waste beaker.

12.6.1.2 Attach the round-bottom flask containing the sample extract to the rotary evaporator. Slowly apply vacuum to the system, and begin rotating the sample flask.

12.6.1.3 Lower the flask into the water bath, and adjust the speed of rotation and the temperature as required to complete concentration in 15-20 minutes. At the proper rate of concentration, the flow of solvent into the receiving flask will be steady, but no bumping or visible boiling of the extract will occur.

NOTE: If the rate of concentration is too fast, analyte loss may occur.

12.6.1.4 When the liquid in the concentration flask has reached an apparent volume of approximately 2 mL, remove the flask from the water bath and stop the rotation. Slowly and carefully admit air into the system. Be sure not to open the valve so quickly that the sample is blown out of the flask. Rinse the feed tube with approximately 2 mL of solvent.

12.6.1.5 Proceed to Section 12.6.4 for preparation for back-extraction or micro-concentration and solvent exchange.

12.6.2 Heating mantle—Concentrate the extracts in separate round-bottom flasks.

12.6.2.1 Add one or two clean boiling chips to the round-bottom flask, and attach a three-ball macro Snyder column. Prewet the column by adding approximately 1 mL of solvent through the top. Place the round-bottom flask in a heating mantle, and apply heat as required to complete the concentration in 15-20 minutes. At the proper rate of distillation, the balls of the column will actively chatter, but the chambers will not flood.

12.6.2.2 When the liquid has reached an apparent volume of approximately 10 mL, remove the round-bottom flask from the heating mantle and allow the solvent to drain and cool for at least 10 minutes.

- Remove the Snyder column and rinse the glass joint into the receiver with small portions of solvent.
- 12.6.2.3 Proceed to Section 12.6.4 for preparation for back-extraction or micro-concentration and solvent exchange.
- 12.6.3 Kuderna-Danish (K-D)—Concentrate the extracts in separate 500 mL K-D flasks equipped with 10 mL concentrator tubes. The K-D technique is used for solvents such as methylene chloride and hexane. Toluene is difficult to concentrate using the K-D technique unless a water bath fed by a steam generator is used.
- 12.6.3.1 Add one to two clean boiling chips to the receiver. Attach a three-ball macro Snyder column. Prewet the column by adding approximately 1 mL of solvent through the top. Place the K-D apparatus in a hot water bath so that the entire lower rounded surface of the flask is bathed with steam.
- 12.6.3.2 Adjust the vertical position of the apparatus and the water temperature as required to complete the concentration in 15-20 minutes. At the proper rate of distillation, the balls of the column will actively chatter but the chambers will not flood.
- 12.6.3.3 When the liquid has reached an apparent volume of 1 mL, remove the K-D apparatus from the bath and allow the solvent to drain and cool for at least 10 minutes. Remove the Snyder column and rinse the flask and its lower joint into the concentrator tube with 1-2 mL of solvent. A 5 mL syringe is recommended for this operation.
- 12.6.3.4 Remove the three-ball Snyder column, add a fresh boiling chip, and attach a two-ball micro Snyder column to the concentrator tube. Prewet the column by adding approximately 0.5 mL of solvent through the top. Place the apparatus in the hot water bath.
- 12.6.3.5 Adjust the vertical position and the water temperature as required to complete the concentration in 5-10 minutes. At the proper rate of distillation, the balls of the column will actively chatter but the chambers will not flood.
- 12.6.3.6 When the liquid reaches an apparent volume of 0.5 mL, remove the apparatus from the water bath and allow to drain and cool for at least 10 minutes.
- 12.6.3.7 Proceed to 12.6.4 for preparation for back-extraction or micro-concentration and solvent exchange.
- 12.6.4 Preparation for back-extraction or micro-concentration and solvent exchange.
- 12.6.4.1 For back-extraction (Section 12.5), transfer the extract to a 250 mL separatory funnel. Rinse the concentration vessel with small

portions of hexane, adjust the hexane volume in the separatory funnel to 10-20 mL, and proceed to back-extraction (Section 12.5).

- 12.6.4.2 For determination of the weight of residue in the extract, or for clean-up procedures other than back-extraction, transfer the extract to a blowdown vial using two to three rinses of solvent. Proceed with micro-concentration and solvent exchange (Section 12.7).

12.7 Micro-Concentration and Solvent Exchange

12.7.1 Extracts to be subjected to GPC or HPLC cleanup are exchanged into methylene chloride. Extracts to be cleaned up using silica gel, alumina, carbon, and/or Florisil are exchanged into hexane.

12.7.2 Transfer the vial containing the sample extract to a nitrogen blowdown device. Adjust the flow of nitrogen so that the surface of the solvent is just visibly disturbed.

NOTE: *A large vortex in the solvent may cause analyte loss.*

12.7.3 Lower the vial into a 45°C water bath and continue concentrating.

12.7.3.1 If the extract is to be concentrated to dryness for weight determination (Sections 12.4.1.8, 12.4.2.7, and 13.7.1.4), blow dry until a constant weight is obtained.

12.7.3.2 If the extract is to be concentrated for injection into the GC/MS or the solvent is to be exchanged for extract cleanup, proceed as follows:

12.7.4 When the volume of the liquid is approximately 100 µL, add 2-3 mL of the desired solvent (methylene chloride for GPC and HPLC, or hexane for the other cleanups) and continue concentration to approximately 100 µL. Repeat the addition of solvent and concentrate once more.

12.7.5 If the extract is to be cleaned up by GPC, adjust the volume of the extract to 5.0 mL with methylene chloride. If the extract is to be cleaned up by HPLC, further concentrate the extract to 30 µL. Proceed with GPC or HPLC cleanup (Section 13.2 or 13.6, respectively).

12.7.6 If the extract is to be cleaned up by column chromatography (alumina, silica gel, Carbopak/Celite, or Florisil), bring the final volume to 1.0 mL with hexane. Proceed with column cleanups (Sections 13.3 through 13.5 and 13.8).

12.7.7 If the extract is to be concentrated for injection into the GC/MS (Section 14), quantitatively transfer the extract to a 0.3 mL conical vial for final concentration, rinsing the larger vial with hexane and adding the rinse to the conical vial. Reduce the volume to approximately 100 µL. Add 10 µL of nonane to the vial, and evaporate the solvent to the level of the nonane. Seal the vial and label with the sample number. Store in the dark at room temperature until ready for

GC/MS analysis. If GC/MS analysis will not be performed on the same day, store the vial at $<-10^{\circ}\text{C}$.

13.0 Extract Cleanup

13.1 Cleanup may not be necessary for relatively clean samples (e.g., treated effluents, groundwater, drinking water). If particular circumstances require the use of a cleanup procedure, the analyst may use any or all of the procedures below or any other appropriate procedure. Before using a cleanup procedure, the analyst must demonstrate that the requirements of Section 9.2 can be met using the cleanup procedure. If only 2,3,7,8-TCDD and 2,3,7,8-TCDF are to be determined, the cleanup procedures may be optimized for isolation of these two compounds.

13.1.1 Gel permeation chromatography (Section 13.2) removes high molecular weight interferences that cause GC column performance to degrade. It should be used for all soil and sediment extracts and may be used for water extracts that are expected to contain high molecular weight organic compounds (e.g., polymeric materials, humic acids).

13.1.2 Acid, neutral, and basic silica gel (Section 13.3), alumina (Section 13.4), and Florisil (Section 13.8) are used to remove nonpolar and polar interferences. Alumina and Florisil are used to remove chlorodiphenyl ethers.

13.1.3 Caropak/Celite (Section 13.5) is used to remove nonpolar interferences.

13.1.4 HPLC (Section 13.6) is used to provide specificity for the 2,3,7,8-substituted and other CDD and CDF isomers.

13.1.5 The anthropogenic isolation column (Section 13.7.1), acidified silica gel batch adsorption procedure (Section 13.7.2), and sulfuric acid and base back-extraction (Section 13.7.3) are used for removal of lipids from tissue samples.

13.2 Gel Permeation Chromatography (GPC)

13.2.1 Column packing

13.2.1.1 Place 70-75 g of SX-3 Bio-beads (Section 6.7.1.1) in a 400-500 mL beaker.

13.2.1.2 Cover the beads with methylene chloride and allow to swell overnight (a minimum of 12 hours).

13.2.1.3 Transfer the swelled beads to the column (Section 6.7.1.1) and pump solvent through the column, from bottom to top, at 4.5-5.5 mL/minute prior to connecting the column to the detector.

13.2.1.4 After purging the column with solvent for one to two hours, adjust the column head pressure to 7-10 psig and purge for four to five hours to remove air. Maintain a head pressure of 7-10 psig. Connect the column to the detector (Section 6.7.1.4).

13.2.2 Column calibration

- 13.2.2.1 Load 5 mL of the calibration solution (Section 7.4) into the sample loop.
- 13.2.2.2 Inject the calibration solution and record the signal from the detector. The elution pattern will be corn oil, bis(2-ethyl hexyl)phthalate, pentachlorophenol, perylene, and sulfur.
- 13.2.2.3 Set the "dump time" to allow >85% removal of the corn oil and >85% collection of the phthalate.
- 13.2.2.4 Set the "collect time" to the peak minimum between perylene and sulfur.
- 13.2.2.5 Verify the calibration with the calibration solution after every 20 extracts. Calibration is verified if the recovery of the pentachlorophenol is greater than 85%. If calibration is not verified, the system shall be recalibrated using the calibration solution, and the previous 20 samples shall be re-extracted and cleaned up using the calibrated GPC system.

13.2.3 Extract cleanup—GPC requires that the column not be overloaded. The column specified in this method is designed to handle a maximum of 0.5 g of high molecular weight material in a 5 mL extract. If the extract is known or expected to contain more than 0.5 g, the extract is split into aliquots for GPC, and the aliquots are combined after elution from the column. The residue content of the extract may be obtained gravimetrically by evaporating the solvent from a 50 μ L aliquot.

- 13.2.3.1 Filter the extract or load through the filter holder (Section 6.7.1.3) to remove the particles. Load the 5.0 mL extract onto the column.
- 13.2.3.2 Elute the extract using the calibration data determined in Section 13.2.2. Collect the eluate in a clean 400-500 mL beaker.
- 13.2.3.3 Rinse the sample loading tube thoroughly with methylene chloride between extracts to prepare for the next sample.
- 13.2.3.4 If a particularly dirty extract is encountered, a 5.0 mL methylene chloride blank shall be run through the system to check for carry-over.
- 13.2.3.5 Concentrate the eluate per Sections 12.6 and 12.7 for further cleanup or injection into the GC/MS.

13.3 Silica Gel Cleanup

- 13.3.1 Place a glass-wool plug in a 15 mm ID chromatography column (Section 6.7.4.2). Pack the column bottom to top with: 1 g silica gel (Section 7.5.1.1), 4 g basic silica gel (Section 7.5.1.3), 1 g silica gel, 8 g acid silica gel (Section 7.5.1.2), 2 g silica gel,

and 4 g granular anhydrous sodium sulfate (Section 7.2.1). Tap the column to settle the adsorbents.

- 13.3.2 Pre-elute the column with 50-100 mL of hexane. Close the stopcock when the hexane is within 1 mm of the sodium sulfate. Discard the eluate. Check the column for channeling. If channeling is present, discard the column and prepare another.
- 13.3.3 Apply the concentrated extract to the column. Open the stopcock until the extract is within 1 mm of the sodium sulfate.
- 13.3.4 Rinse the receiver twice with 1 mL portions of hexane, and apply separately to the column. Elute the CDDs/CDFs with 100 mL hexane, and collect the eluate.
- 13.3.5 Concentrate the eluate per Sections 12.6 and 12.7 for further cleanup or injection into the HPLC or GC/MS.
- 13.3.6 For extracts of samples known to contain large quantities of other organic compounds (such as paper mill effluents), it may be advisable to increase the capacity of the silica gel column. This may be accomplished by increasing the strengths of the acid and basic silica gels. The acid silica gel (Section 7.5.1.2) may be increased in strength to as much as 44% w/w (7.9 g sulfuric acid added to 10 g silica gel). The basic silica gel (Section 7.5.1.3) may be increased in strength to as much as 33% w/w (50 mL 1N NaOH added to 100 g silica gel), or the potassium silicate (Section 7.5.1.4) may be used.

NOTE: *The use of stronger acid silica gel (44% w/w) may lead to charring of organic compounds in some extracts. The charred material may retain some of the analytes and lead to lower recoveries of CDDs/CDFs. Increasing the strengths of the acid and basic silica gel may also require different volumes of hexane than those specified above to elute the analytes off the column. Therefore, the performance of the method after such modifications must be verified by the procedure in Section 9.2.*

13.4 Alumina Cleanup

- 13.4.1 Place a glass-wool plug in a 15 mm ID chromatography column (Section 6.7.4.2).
- 13.4.2 If using acid alumina, pack the column by adding 6 g acid alumina (Section 7.5.2.1). If using basic alumina, substitute 6 g basic alumina (Section 7.5.2.2). Tap the column to settle the adsorbents.
- 13.4.3 Pre-elute the column with 50-100 mL of hexane. Close the stopcock when the hexane is within 1 mm of the alumina.
- 13.4.4 Discard the eluate. Check the column for channeling. If channeling is present, discard the column and prepare another.
- 13.4.5 Apply the concentrated extract to the column. Open the stopcock until the extract is within 1 mm of the alumina.

- 13.4.6 Rinse the receiver twice with 1 mL portions of hexane and apply separately to the column. Elute the interfering compounds with 100 mL hexane and discard the eluate.
- 13.4.7 The choice of eluting solvents will depend on the choice of alumina (acid or basic) made in Section 13.4.2.
- 13.4.7.1 If using acid alumina, elute the CDDs/CDFs from the column with 20 mL methylene chloride:hexane (20:80 v/v). Collect the eluate.
- 13.4.7.2 If using basic alumina, elute the CDDs/CDFs from the column with 20 mL methylene chloride:hexane (50:50 v/v). Collect the eluate.
- 13.4.8 Concentrate the eluate per Sections 12.6 and 12.7 for further cleanup or injection into the HPLC or GC/MS.
- 13.5 Carbon Column
- 13.5.1 Cut both ends from a 10 mL disposable serological pipet (Section 6.7.3.2) to produce a 10 cm column. Fire-polish both ends and flare both ends if desired. Insert a glass-wool plug at one end, and pack the column with 0.55 g of Carbowax/Celite (Section 7.5.3.3) to form an adsorbent bed approximately 2 cm long. Insert a glass-wool plug on top of the bed to hold the adsorbent in place.
- 13.5.2 Pre-elute the column with 5 mL of toluene followed by 2 mL of methylene chloride:methanol:toluene (15:4:1 v/v), 1 mL of methylene chloride:cyclohexane (1:1 v/v), and 5 mL of hexane. If the flow rate of eluate exceeds 0.5 mL/minute, discard the column.
- 13.5.3 When the solvent is within 1 mm of the column packing, apply the sample extract to the column. Rinse the sample container twice with 1 mL portions of hexane and apply separately to the column. Apply 2 mL of hexane to complete the transfer.
- 13.5.4 Elute the interfering compounds with two 3 mL portions of hexane, 2 mL of methylene chloride:cyclohexane (1:1 v/v), and 2 mL of methylene chloride:methanol:toluene (15:4:1 v/v). Discard the eluate.
- 13.5.5 Invert the column, and elute the CDDs/CDFs with 20 mL of toluene. If carbon particles are present in the eluate, filter through glass-fiber filter paper.
- 13.5.6 Concentrate the eluate per Sections 12.6 and 12.7 for further cleanup or injection into the HPLC or GC/MS.
- 13.6 HPLC (Reference 6)
- 13.6.1 Column calibration

- 13.6.1.1 Prepare a calibration standard containing the 2,3,7,8-substituted isomers and/or other isomers of interest at a concentration of approximately 500 pg/ μ L in methylene chloride.
- 13.6.1.2 Inject 30 μ L of the calibration solution into the HPLC and record the signal from the detector. Collect the eluant for reuse. The elution order will be the tetra- through octa-isomers.
- 13.6.1.3 Establish the collection time for the tetra-isomers and for the other isomers of interest. Following calibration, flush the injection system with copious quantities of methylene chloride, including a minimum of five 50 μ L injections while the detector is monitored, to ensure that residual CDDs/CDFs are removed from the system.
- 13.6.1.4 Verify the calibration with the calibration solution after every 20 extracts. Calibration is verified if the recovery of the CDDs/CDFs from the calibration standard (Section 13.6.1.1) is 75-125% compared to the calibration (Section 13.6.1.2). If calibration is not verified, the system shall be recalibrated using the calibration solution, and the previous 20 samples shall be re-extracted and cleaned up using the calibrated system.
- 13.6.2 Extract cleanup—HPLC requires that the column not be overloaded. The column specified in this method is designed to handle a maximum of 30 μ L of extract. If the extract cannot be concentrated to less than 30 μ L, it is split into fractions and the fractions are combined after elution from the column.
- 13.6.2.1 Rinse the sides of the vial twice with 30 μ L of methylene chloride and reduce to 30 μ L with the evaporation apparatus (Section 12.7).
- 13.6.2.2 Inject the 30 μ L extract into the HPLC.
- 13.6.2.3 Elute the extract using the calibration data determined in Section 13.6.1. Collect the fraction(s) in a clean 20 mL concentrator tube containing 5 mL of hexane:acetone (1:1 v/v).
- 13.6.2.4 If an extract containing greater than 100 ng/mL of total CDD or CDF is encountered, a 30 μ L methylene chloride blank shall be run through the system to check for carry-over.
- 13.6.2.5 Concentrate the eluate per Section 12.7 for injection into the GC/MS.
- 13.7 Cleanup of Tissue Lipids—Lipids are removed from the Soxhlet extract using either the anthropogenic isolation column (Section 13.7.1) or acidified silica gel (Section 13.7.2), or are removed from the HCl digested extract using sulfuric acid and base back-extraction (Section 13.7.3).
- 13.7.1 Anthropogenic isolation column (References 22 and 27)—Used for removal of lipids from the Soxhlet/SDS extraction (Section 12.4.1).

-
- 13.7.1.1 Prepare the column as given in Section 7.5.4.
- 13.7.1.2 Pre-elute the column with 100 mL of hexane. Drain the hexane layer to the top of the column, but do not expose the sodium sulfate.
- 13.7.1.3 Load the sample and rinses (Section 12.4.1.9.2) onto the column by draining each portion to the top of the bed. Elute the CDDs/CDFs from the column into the apparatus used for concentration (Section 12.4.1.7) using 200 mL of hexane.
- 13.7.1.4 Concentrate the cleaned up extract (Sections 12.6 through 12.7) to constant weight per Section 12.7.3.1. If more than 500 mg of material remains, repeat the cleanup using a fresh anthropogenic isolation column.
- 13.7.1.5 Redissolve the extract in a solvent suitable for the additional cleanups to be used (Sections 13.2 through 13.6 and 13.8).
- 13.7.1.6 Spike 1.0 mL of the cleanup standard (Section 7.11) into the residue/solvent.
- 13.7.1.7 Clean up the extract using the procedures in Sections 13.2 through 13.6 and 13.8. Alumina (Section 13.4) or Florisil (Section 13.8) and carbon (Section 13.5) are recommended as minimum additional cleanup steps.
- 13.7.1.8 Following cleanup, concentrate the extract to 10 μ L as described in Section 12.7 and proceed with the analysis in Section 14.
- 13.7.2 Acidified silica gel (Reference 28)—Procedure alternate to the anthropogenic isolation column (Section 13.7.1) that is used for removal of lipids from the Soxhlet/SDS extraction (Section 12.4.1).
- 13.7.2.1 Adjust the volume of hexane in the bottle (Section 12.4.1.9.2) to approximately 200 mL.
- 13.7.2.2 Spike 1.0 mL of the cleanup standard (Section 7.11) into the residue/solvent.
- 13.7.2.3 Drop the stirring bar into the bottle, place the bottle on the stirring plate, and begin stirring.
- 13.7.2.4 Add 30-100 g of acid silica gel (Section 7.5.1.2) to the bottle while stirring, keeping the silica gel in motion. Stir for two to three hours.

NOTE: 30 grams of silica gel should be adequate for most samples and will minimize contamination from this source.

- 13.7.2.5 After stirring, pour the extract through approximately 10 g of granular anhydrous sodium sulfate (Section 7.2.1) contained in a funnel with glass-fiber filter into a macro concentration device (Section 12.6). Rinse the bottle and sodium sulfate with hexane to complete the transfer.
- 13.7.2.6 Concentrate the extract per Sections 12.6 through 12.7 and clean up the extract using the procedures in Sections 13.2 through 13.6 and 13.8. Alumina (Section 13.4) or Florisil (Section 13.8) and carbon (Section 13.5) are recommended as minimum additional cleanup steps.
- 13.7.3 Sulfuric acid and base back-extraction—Used with HCl digested extracts (Section 12.4.2).
- 13.7.3.1 Spike 1.0 mL of the cleanup standard (Section 7.11) into the residue/solvent (Section 12.4.2.8.2).
- 13.7.3.2 Add 10 mL of concentrated sulfuric acid to the bottle. Immediately cap and shake one to three times. Loosen cap in a hood to vent excess pressure. Cap and shake the bottle so that the residue/solvent is exposed to the acid for a total time of approximately 45 seconds.
- 13.7.3.3 Decant the hexane into a 250 mL separatory funnel making sure that no acid is transferred. Complete the quantitative transfer with several hexane rinses.
- 13.7.3.4 Back extract the solvent/residue with 50 mL of potassium hydroxide solution per Section 12.5.2, followed by two reagent water rinses.
- 13.7.3.5 Drain the extract through a filter funnel containing approximately 10 g of granular anhydrous sodium sulfate in a glass-fiber filter into a macro concentration device (Section 12.6).
- 13.7.3.6 Concentrate the cleaned up extract to a volume suitable for the additional cleanups given in Sections 13.2 through 13.6 and 13.8. Gel permeation chromatography (Section 13.2), alumina (Section 13.4) or Florisil (Section 13.8), and Carbopak/Celite (Section 13.5) are recommended as minimum additional cleanup steps.
- 13.7.3.7 Following cleanup, concentrate the extract to 10 μ L as described in Section 12.7 and proceed with analysis per Section 14.
- 13.8 Florisil Cleanup (Reference 29)
- 13.8.1 Pre-elute the activated Florisil column (Section 7.5.3) with 10 mL of methylene chloride followed by 10 mL of hexane:methylene chloride (98:2 v/v) and discard the solvents.

- 13.8.2 When the solvent is within 1 mm of the packing, apply the sample extract (in hexane) to the column. Rinse the sample container twice with 1 mL portions of hexane and apply to the column.
- 13.8.3 Elute the interfering compounds with 20 mL of hexane:methylene chloride (98:2) and discard the eluate.
- 13.8.4 Elute the CDDs/CDFs with 35 mL of methylene chloride and collect the eluate. Concentrate the eluate per Sections 12.6 through 12.7 for further cleanup or for injection into the HPLC or GC/MS.

14.0 HRGC/HRMS Analysis

- 14.1 Establish the operating conditions given in Section 10.1.
- 14.2 Add 10 μL of the appropriate internal standard solution (Section 7.12) to the sample extract immediately prior to injection to minimize the possibility of loss by evaporation, adsorption, or reaction. If an extract is to be reanalyzed and evaporation has occurred, do not add more instrument internal standard solution. Rather, bring the extract back to its previous volume (e.g., 19 μL) with pure nonane only (18 μL if 2 μL injections are used).
- 14.3 Inject 1.0 μL or 2.0 μL of the concentrated extract containing the internal standard solution, using on-column or splitless injection. The volume injected must be identical to the volume used for calibration (Section 10). Start the GC column initial isothermal hold upon injection. Start MS data collection after the solvent peak elutes. Stop data collection after the OCDD and OCDF have eluted. If only 2,3,7,8-TCDD and 2,3,7,8-TCDF are to be determined, stop data collection after elution of these compounds. Return the column to the initial temperature for analysis of the next extract or standard.

15.0 System and Laboratory Performance

- 15.1 At the beginning of each 12-hour shift during which analyses are performed, GC/MS system performance and calibration are verified for all CDDs/CDFs and labeled compounds. For these tests, analysis of the CS3 calibration verification (VER) standard (Section 7.13 and Table 4) and the isomer specificity test standards (Section 7.15 and Table 5) shall be used to verify all performance criteria. Adjustment and/or recalibration (Section 10) shall be performed until all performance criteria are met. Only after all performance criteria are met may samples, blanks, IPRs, and OPRs be analyzed.
- 15.2 MS Resolution—A static resolving power of at least 10,000 (10% valley definition) must be demonstrated at the appropriate m/z before any analysis is performed. Static resolving power checks must be performed at the beginning and at the end of each 12-hour shift according to procedures in Section 10.1.2. Corrective actions must be implemented whenever the resolving power does not meet the requirement.
- 15.3 Calibration Verification
- 15.3.1 Inject the VER standard using the procedure in Section 14.

- 15.3.2 The m/z abundance ratios for all CDDs/CDFs shall be within the limits in Table 9; otherwise, the mass spectrometer shall be adjusted until the m/z abundance ratios fall within the limits specified, and the verification test shall be repeated. If the adjustment alters the resolution of the mass spectrometer, resolution shall be verified (Section 10.1.2) prior to repeat of the verification test.
- 15.3.3 The peaks representing each CDD/CDF and labeled compound in the VER standard must be present with S/N of at least 10; otherwise, the mass spectrometer shall be adjusted and the verification test repeated.
- 15.3.4 Compute the concentration of each CDD/CDF compound by isotope dilution (Section 10.5) for those compounds that have labeled analogs (Table 1). Compute the concentration of the labeled compounds by the internal standard method (Section 10.6). These concentrations are computed based on the calibration data in Section 10.
- 15.3.5 For each compound, compare the concentration with the calibration verification limit in Table 6. If only 2,3,7,8-TCDD and 2,3,7,8-TCDF are to be determined, compare the concentration to the limit in Table 6a. If all compounds meet the acceptance criteria, calibration has been verified and analysis of standards and sample extracts may proceed. If, however, any compound fails its respective limit, the measurement system is not performing properly for that compound. In this event, prepare a fresh calibration standard or correct the problem causing the failure and repeat the resolution (Section 15.2) and verification (Section 15.3) tests, or recalibrate (Section 10).
- 15.4 Retention Times and GC Resolution
- 15.4.1 Retention times
- 15.4.1.1 Absolute—The absolute retention times of the $^{13}\text{C}_{12}$ -1,2,3,4-TCDD and $^{13}\text{C}_{12}$ -1,2,3,7,8,9-HxCDD GCMS internal standards in the verification test (Section 15.3) shall be within ± 15 seconds of the retention times obtained during calibration (Sections 10.2.1 and 10.2.4).
- 15.4.1.2 Relative—The relative retention times of CDDs/CDFs and labeled compounds in the verification test (Section 15.3) shall be within the limits given in Table 2.
- 15.4.2 GC resolution
- 15.4.2.1 Inject the isomer specificity standards (Section 7.15) on their respective columns.
- 15.4.2.2 The valley height between 2,3,7,8-TCDD and the other tetra-dioxin isomers at m/z 319.8965, and between 2,3,7,8-TCDF and the other tetra-furan isomers at m/z 303.9016 shall not exceed 25% on their respective columns (Figures 6 and 7).

- 15.4.3 If the absolute retention time of any compound is not within the limits specified or if the 2,3,7,8-isomers are not resolved, the GC is not performing properly. In this event, adjust the GC and repeat the verification test (Section 15.3) or recalibrate (Section 10), or replace the GC column and either verify calibration or recalibrate.
- 15.5 Ongoing Precision and Recovery
- 15.5.1 Analyze the extract of the ongoing precision and recovery (OPR) aliquot (Section 11.4.2.5, 11.5.4, 11.6.2, 11.7.4, or 11.8.3.2) prior to analysis of samples from the same batch.
- 15.5.2 Compute the concentration of each CDD/CDF by isotope dilution for those compounds that have labeled analogs (Section 10.5). Compute the concentration of 1,2,3,7,8,9-HxCDD, OCDF, and each labeled compound by the internal standard method (Section 10.6).
- 15.5.3 For each CDD/CDF and labeled compound, compare the concentration to the OPR limits given in Table 6. If only 2,3,7,8-TCDD and 2,3,7,8-TCDF are to be determined, compare the concentration to the limits in Table 6a. If all compounds meet the acceptance criteria, system performance is acceptable and analysis of blanks and samples may proceed. If, however, any individual concentration falls outside of the range given, the extraction/concentration processes are not being performed properly for that compound. In this event, correct the problem, re-prepare, extract, and clean up the sample batch and repeat the ongoing precision and recovery test (Section 15.5).
- 15.5.4 Add results that pass the specifications in Section 15.5.3 to initial and previous ongoing data for each compound in each matrix. Update QC charts to form a graphic representation of continued laboratory performance. Develop a statement of laboratory accuracy for each CDD/CDF in each matrix type by calculating the average percent recovery (R) and the standard deviation of percent recovery (S_R). Express the accuracy as a recovery interval from $R-2S_R$ to $R+2S_R$. For example, if $R = 95\%$ and $S_R = 5\%$, the accuracy is 85-105%.
- 15.6 Blank—Analyze the method blank extracted with each sample batch immediately following analysis of the OPR aliquot to demonstrate freedom from contamination and freedom from carryover from the OPR analysis. The results of the analysis of the blank must meet the specifications in Section 9.5.2 before sample analyses may proceed.

16.0 Qualitative Determination

A CDD, CDF, or labeled compound is identified in a standard, blank, or sample when all of the criteria in Sections 16.1 through 16.4 are met.

- 16.1 The signals for the two exact m/z 's in Table 8 must be present and must maximize within the same two seconds.
- 16.2 The signal-to-noise ratio (S/N) for the GC peak at each exact m/z must be greater than or equal to 2.5 for each CDD or CDF detected in a sample extract, and greater than or equal to 10 for all CDDs/CDFs in the calibration standard (Sections 10.2.3 and 15.3.3).

- 16.3 The ratio of the integrated areas of the two exact m/z's specified in Table 8 must be within the limit in Table 9, or within $\pm 10\%$ of the ratio in the midpoint (CS3) calibration or calibration verification (VER), whichever is most recent.
- 16.4 The relative retention time of the peak for a 2,3,7,8-substituted CDD or CDF must be within the limit in Table 2. The retention time of peaks representing non-2,3,7,8-substituted CDDs/CDFs must be within the retention time windows established in Section 10.3.
- 16.5 Confirmatory Analysis—Isomer specificity for 2,3,7,8-TCDF cannot be achieved on the DB-5 column. Therefore, any sample in which 2,3,7,8-TCDF is identified by analysis on a DB-5 column must have a confirmatory analysis performed on a DB-225, SP-2330, or equivalent GC column. The operating conditions in Section 10.1.1 may be adjusted to optimize the analysis on the second GC column, but the GC/MS must meet the mass resolution and calibration specifications in Section 10.
- 16.6 If the criteria for identification in Sections 16.1 through 16.5 are not met, the CDD or CDF has not been identified and the results may not be reported for regulatory compliance purposes. If interferences preclude identification, a new aliquot of sample must be extracted, further cleaned up, and analyzed.

17.0 Quantitative Determination

- 17.1 Isotope Dilution Quantitation—By adding a known amount of a labeled compound to every sample prior to extraction, correction for recovery of the CDD/CDF can be made because the CDD/CDF and its labeled analog exhibit similar effects upon extraction, concentration, and gas chromatography. Relative response (RR) values are used in conjunction with the initial calibration data described in Section 10.5 to determine concentrations directly, so long as labeled compound spiking levels are constant, using the following equation:

$$C_{ex} \text{ (ng/mL)} = \frac{(A_n + A_n) C_i}{(A_i + A_i) RR}$$

where,

C_{ex} = The concentration of the CDD/CDF in the extract, and the other terms are as defined in Section 10.5.2.

- 17.1.1 Because of a potential interference, the labeled analog of OCDF is not added to the sample. Therefore, OCDF is quantitated against labeled OCDD. As a result, the concentration of OCDF is corrected for the recovery of the labeled OCDD. In instances where OCDD and OCDF behave differently during sample extraction, concentration, and cleanup procedures, this may decrease the accuracy of the OCDF results. However, given the low toxicity of this compound relative to the other dioxins and furans, the potential decrease in accuracy is not considered significant.

17.1.2 Because $^{13}\text{C}_{12}$ -1,2,3,7,8,9-HxCDD is used as an instrument internal standard (i.e., not added before extraction of the sample), it cannot be used to quantitate the 1,2,3,7,8,9-HxCDD by strict isotope dilution procedures. Therefore, 1,2,3,7,8,9-HxCDD is quantitated using the averaged response of the labeled analogs of the other two 2,3,7,8-substituted HxCDD's: 1,2,3,4,7,8-HxCDD and 1,2,3,6,7,8-HxCDD. As a result, the concentration of 1,2,3,7,8,9-HxCDD is corrected for the average recovery of the other two HxCDD's.

17.1.3 Any peaks representing non-2,3,7,8-substituted CDDs/CDFs are quantitated using an average of the response factors from all of the labeled 2,3,7,8-isomers at the same level of chlorination.

17.2 Internal Standard Quantitation and Labeled Compound Recovery

17.2.1 Compute the concentrations of 1,2,3,7,8,9-HxCDD, OCDF, the ^{13}C -labeled analogs and the ^{37}C -labeled cleanup standard in the extract using the response factors determined from the initial calibration data (Section 10.6) and the following equation:

$$C_{ex} \text{ (ng/mL)} = \frac{(A_s + A_{i_s}) C_{is}}{(A_{i_s} + A_{i_s}) RF}$$

where,

C_{ex} = The concentration of the CDD/CDF in the extract, and the other terms are as defined in Section 10.6.1.

NOTE: *There is only one m/z for the ^{37}Cl -labeled standard.*

17.2.2 Using the concentration in the extract determined above, compute the percent recovery of the ^{13}C -labeled compounds and the ^{37}C -labeled cleanup standard using the following equation:

$$\text{Recovery (\%)} = \frac{\text{Concentration found } (\mu\text{g/mL})}{\text{Concentration spiked } (\mu\text{g/mL})} \times 100$$

17.3 The concentration of a CDD/CDF in the solid phase of the sample is computed using the concentration of the compound in the extract and the weight of the solids (Section 11.5.1), as follows:

$$\text{Concentration in solid (ng/kg)} = \frac{(C_{ex} \times V_{ex})}{W_s}$$

where,

C_{ex} = The concentration of the compound in the extract.

V_{ex} = The extract volume in mL.

W_s = The sample weight (dry weight) in kg.

17.4 The concentration of a CDD/CDF in the aqueous phase of the sample is computed using the concentration of the compound in the extract and the volume of water extracted (Section 11.4 or 11.5), as follows:

$$\text{Concentration in aqueous phase (pg/L)} = \frac{(C_{ex} \times V_{ex})}{V_s}$$

where,

C_{ex} = The concentration of the compound in the extract.

V_{ex} = The extract volume in mL.

V_s = The sample volume in liters.

17.5 If the SICP area at either quantitation m/z for any compound exceeds the calibration range of the system, a smaller sample aliquot is extracted.

17.5.1 For aqueous samples containing 1% solids or less, dilute 100 mL, 10 mL, etc., of sample to 1 L with reagent water and re-prepare, extract, clean up, and analyze per Sections 11 through 14.

17.5.2 For samples containing greater than 1% solids, extract an amount of sample equal to 1/10, 1/100, etc., of the amount used in Section 11.5.1. Re-prepare, extract, clean up, and analyze per Sections 11 through 14.

17.5.3 If a smaller sample size will not be representative of the entire sample, dilute the sample extract by a factor of 10, adjust the concentration of the instrument internal standard to 100 pg/ μ L in the extract, and analyze an aliquot of this diluted extract by the internal standard method.

17.6 Results are reported to three significant figures for the CDDs/CDFs and labeled compounds found in all standards, blanks, and samples.

17.6.1 Reporting units and levels

17.6.1.1 Aqueous samples—Report results in pg/L (parts-per-quadrillion).

17.6.1.2 Samples containing greater than 1% solids (soils, sediments, filter cake, compost)—Report results in ng/kg based on the dry weight of the sample. Report the percent solids so that the result may be corrected.

17.6.1.3 Tissues—Report results in ng/kg of wet tissue, not on the basis of the lipid content of the sample. Report the percent lipid content, so that the data user can calculate the concentration on a lipid basis if desired.

17.6.1.4 Reporting level

- 17.6.1.4.1 Standards (VER, IPR, OPR) and samples—Report results at or above the minimum level (Table 2). Report results below the minimum level as not detected or as required by the regulatory authority.
- 17.6.1.4.2 Blanks—Report results above one-third the ML.
- 17.6.2 Results for CDDs/CDFs in samples that have been diluted are reported at the least dilute level at which the areas at the quantitation m/z's are within the calibration range (Section 17.5).
- 17.6.3 For CDDs/CDFs having a labeled analog, results are reported at the least dilute level at which the area at the quantitation m/z is within the calibration range (Section 17.5) and the labeled compound recovery is within the normal range for the method (Section 9.3 and Tables 6, 6a, 7, and 7a).
- 17.6.4 Additionally, if requested, the total concentration of all isomers in an individual level of chlorination (i.e., total TCDD, total TCDF, total Paced, etc.) may be reported by summing the concentrations of all isomers identified in that level of chlorination, including both 2,3,7,8-substituted and non-2,3,7,8-substituted isomers.

18.0 Analysis of Complex Samples

- 18.1 Some samples may contain high levels (>10 ng/L; >1000 ng/kg) of the compounds of interest, interfering compounds, and/or polymeric materials. Some extracts will not concentrate to 10 µL (Section 12.7); others may overload the GC column and/or mass spectrometer.
- 18.2 Analyze a smaller aliquot of the sample (Section 17.5) when the extract will not concentrate to 10 µL after all cleanup procedures have been exhausted.
- 18.3 Chlorodiphenyl Ethers—If chromatographic peaks are detected at the retention time of any CDDs/CDFs in any of the m/z channels being monitored for the chlorodiphenyl ethers (Table 8), cleanup procedures must be employed until these interferences are removed. Alumina (Section 13.4) and Florisil (Section 13.8) are recommended for removal of chlorodiphenyl ethers.
- 18.4 Recovery of Labeled Compounds—In most samples, recoveries of the labeled compounds will be similar to those from reagent water or from the alternate matrix (Section 7.6).
- 18.4.1 If the recovery of any of the labeled compounds is outside of the normal range (Table 7), a diluted sample shall be analyzed (Section 17.5).
- 18.4.2 If the recovery of any of the labeled compounds in the diluted sample is outside of normal range, the calibration verification standard (Section 7.13) shall be analyzed and calibration verified (Section 15.3).
- 18.4.3 If the calibration cannot be verified, a new calibration must be performed and the original sample extract reanalyzed.

18.4.4 If the calibration is verified and the diluted sample does not meet the limits for labeled compound recovery, the method does not apply to the sample being analyzed and the result may not be reported for regulatory compliance purposes. In this case, alternate extraction and cleanup procedures in this method must be employed to resolve the interference. If all cleanup procedures in this method have been employed and labeled compound recovery remains outside of the normal range, extraction and/or cleanup procedures that are beyond this scope of this method will be required to analyze these samples.

19.0 Pollution Prevention

19.1 The solvents used in this method pose little threat to the environment when managed properly. The solvent evaporation techniques used in this method are amenable to solvent recovery, and it is recommended that the laboratory recover solvents wherever feasible.

19.2 Standards should be prepared in volumes consistent with laboratory use to minimize disposal of standards.

20.0 Waste Management

20.1 It is the laboratory's responsibility to comply with all federal, state, and local regulations governing waste management, particularly the hazardous waste identification rules and land disposal restrictions, and to protect the air, water, and land by minimizing and controlling all releases from fume hoods and bench operations. Compliance is also required with any sewage discharge permits and regulations.

20.2 Samples containing HCl to pH <2 are hazardous and must be neutralized before being poured down a drain or must be handled as hazardous waste.

20.3 The CDDs/CDFs decompose above 800°C. Low-level waste such as absorbent paper, tissues, animal remains, and plastic gloves may be burned in an appropriate incinerator. Gross quantities (milligrams) should be packaged securely and disposed of through commercial or governmental channels that are capable of handling extremely toxic wastes.

20.4 Liquid or soluble waste should be dissolved in methanol or ethanol and irradiated with ultraviolet light with a wavelength shorter than 290 nm for several days. Use F40 BL or equivalent lamps. Analyze liquid wastes, and dispose of the solutions when the CDDs/CDFs can no longer be detected.

20.5 For further information on waste management, consult "The Waste Management Manual for Laboratory Personnel" and "Less is Better—Laboratory Chemical Management for Waste Reduction," available from the American Chemical Society's Department of Government Relations and Science Policy, 1155 16th Street N.W., Washington, D.C. 20036.

21.0 Method Performance

Method performance was validated and performance specifications were developed using data from EPA's international interlaboratory validation study (References 30-31) and the

EPA/paper industry Long-Term Variability Study of discharges from the pulp and paper industry (58 FR 66078).

22.0 References

1. Tondeur, Yves. "Method 8290: Analytical Procedures and Quality Assurance for Multimedia Analysis of Polychlorinated Dibenzo-*p*-dioxins and Dibenzofurans by High Resolution Gas Chromatography/High Resolution Mass Spectrometry," USEPA EMSL, Las Vegas, Nevada, June 1987.
2. "Measurement of 2,3,7,8-Tetrachlorinated Dibenzo-*p*-dioxin (TCDD) and 2,3,7,8-Tetrachlorinated Dibenzofuran (TCDF) in Pulp, Sludges, Process Samples and Wastewaters from Pulp and Paper Mills," Wright State University, Dayton, OH 45435, June 1988.
3. "NCASI Procedures for the Preparation and Isomer Specific Analysis of Pulp and Paper Industry Samples for 2,3,7,8-TCDD and 2,3,7,8-TCDF," National Council of the Paper Industry for Air and Stream Improvement Inc., 260 Madison Avenue, New York, NY 10016, Technical Bulletin No. 551, Pre-Release Copy, July 1988.
4. "Analytical Procedures and Quality Assurance Plan for the Determination of PCDD/PCDF in Fish," USEPA, Environmental Research Laboratory, 6201 Congdon Boulevard, Duluth, MN 55804, April 1988.
5. Tondeur, Yves. "Proposed GC/MS Methodology for the Analysis of PCDDs and PCDFs in Special Analytical Services Samples," Triangle Laboratories, Inc., 801-10 Capitola Dr, Research Triangle Park, NC 27713, January 1988; updated by personal communication September 1988.
6. Lamparski, L.L. and Nestruck, T.J. "Determination of Tetra-, Hexa-, Hepta-, and Octachlorodibenzo-*p*-dioxin Isomers in Particulate Samples at Parts per Trillion Levels," *Analytical Chemistry*, 52: 2045-2054, 1980.
7. Lamparski, L.L. and Nestruck, T.J. "Novel Extraction Device for the Determination of Chlorinated Dibenzo-*p*-dioxins (PCDDs) and Dibenzofurans (PCDFs) in Matrices Containing Water," *Chemosphere*, 19:27-31, 1989.
8. Patterson, D.G., et. al. "Control of Interferences in the Analysis of Human Adipose Tissue for 2,3,7,8-Tetrachlorodibenzo-*p*-dioxin," *Environmental Toxicological Chemistry*, 5:355-360, 1986.
9. Stanley, John S. and Sack, Thomas M. "Protocol for the Analysis of 2,3,7,8-Tetrachlorodibenzo-*p*-dioxin by High Resolution Gas Chromatography/High Resolution Mass Spectrometry," USEPA EMSL, Las Vegas, Nevada 89114, EPA 600/4-86-004, January 1986.
10. "Working with Carcinogens," Department of Health, Education, & Welfare, Public Health Service, Centers for Disease Control, NIOSH, Publication 77-206, August 1977, NTIS PB-277256.
11. "OSHA Safety and Health Standards, General Industry," OSHA 2206, 29 CFR 1910.
12. "Safety in Academic Chemistry Laboratories," ACS Committee on Chemical Safety, 1979.

13. "Standard Methods for the Examination of Water and Wastewater," 18th edition and later revisions, American Public Health Association, 1015 15th St, N.W., Washington, DC 20005, 1-35: Section 1090 (Safety), 1992.
14. "Method 613—2,3,7,8-Tetrachlorodibenzo-*p*-dioxin," 40 *CFR* 136 (49 *FR* 43234), October 26, 1984, Section 4.1.
15. Provost, L.P. and Elder, R.S. "Interpretation of Percent Recovery Data," *American Laboratory*, 15: 56-83, 1983.
16. "Standard Practice for Sampling Water," ASTM Annual Book of Standards, ASTM, 1916 Race Street, Philadelphia, PA 19103-1187, 1980.
17. "Methods 330.4 and 330.5 for Total Residual Chlorine," USEPA, EMSL, Cincinnati, OH 45268, EPA 600/4-79-020, March 1979.
18. "Handbook of Analytical Quality Control in Water and Wastewater Laboratories," USEPA EMSL, Cincinnati, OH 45268, EPA-600/4-79-019, March 1979.
19. Williams, Rick. Letter to Bill Telliard, June 4, 1993, available from the EPA Sample Control Center operated by DynCorp Viar, Inc., 300 N Lee St, Alexandria, VA 22314, 703-519-1140.
20. Barkowski, Sarah. Fax to Sue Price, August 6, 1992, available from the EPA Sample Control Center operated by DynCorp Viar, Inc., 300 N Lee St, Alexandria VA 22314, 703-519-1140.
21. "Analysis of Multi-media, Multi-concentration Samples for Dioxins and Furans, PCDD/PCDF Analyses Data Package", Narrative for Episode 4419, MRI Project No. 3091-A, op.cit. February 12, 1993, Available from the EPA Sample Control Center operated by DynCorp Viar Inc, 300 N Lee St, Alexandria, VA 22314 (703-519-1140).
22. "Analytical Procedures and Quality Assurance Plan for the Determination of PCDD/PCDF in Fish", U.S. Environmental Protection Agency, Environmental Research Laboratory, Duluth, MN 55804, EPA/600/3-90/022, March 1990.
23. Afghan, B.K., Carron, J., Goulden, P.D., Lawrence, J., Leger, D., Onuska, F., Sherry, J., and Wilkenson, R.J., "Recent Advances in Ultratrace Analysis of Dioxins and Related Halogenated Hydrocarbons", *Can J. Chem.*, 65: 1086-1097, 1987.
24. Sherry, J.P. and Tse, H. "A Procedure for the Determination of Polychlorinated Dibenzo-*p*-dioxins in Fish", *Chemosphere*, 20: 865-872, 1990.
25. "Preliminary Fish Tissue Study", Results of Episode 4419, available from the EPA Sample Control Center operated by DynCorp Viar, Inc., 300 N Lee St, Alexandria, VA 22314, 703-519-1140.
26. Nestruck, Terry L. DOW Chemical Co., personal communication with D.R. Rushneck, April 8, 1993. Details available from the U.S. Environmental Protection Agency Sample Control Center operated by DynCorp Viar Inc, 300 N Lee St, Alexandria, VA 22314, 703-519-1140.

27. Barnstadt, Michael. "Big Fish Column", Triangle Laboratories of RTP, Inc., SOP 129-90, 27 March 27, 1992.
28. "Determination of Polychlorinated Dibenzo-*p*-Dioxins (PCDD) and Dibenzofurans (PCDF) in Environmental Samples Using EPA Method 1613", Chemical Sciences Department, Midwest Research Institute, 425 Volker Boulevard, Kansas City, MO 44110-2299, Standard Operating Procedure No. CS-153, January 15, 1992.
29. Ryan, John J. Raymonde Lizotte and William H. Newsome, *J. Chromatog.* 303 (1984) 351-360.
30. Telliard, William A., McCarty, Harry B., and Riddick, Lynn S. "Results of the Interlaboratory Validation Study of USEPA Method 1613 for the Analysis of Tetra-through Octachlorinated Dioxins and Furans by Isotope Dilution GC/MS," *Chemosphere*, 27, 41-46 (1993).
31. "Results of the International Interlaboratory Validation Study of USEPA Method 1613", October 1994, available from the EPA Sample Control Center operated by DynCorp Viar, Inc., 300 N Lee St, Alexandria, VA 22314, 703-519-1140.

23.0 Tables and Figures

TABLE 1. CHLORINATED DIBENZO-*P*-DIOXINS AND FURANS DETERMINED BY ISOTOPE DILUTION AND INTERNAL STANDARD HIGH RESOLUTION GAS CHROMATOGRAPHY (HRGC)/HIGH RESOLUTION MASS SPECTROMETRY (HRMS)

CDDs/CDFs ¹	CAS Registry	Labeled analog	CAS Registry
2,3,7,8-TCDD	1746-01-6	¹³ C ₁₂ -2,3,7,8-TCDD ³⁷ Cl ₄ -2,3,7,8-TCDD	76523-40-5 85508-50-5
Total TCDD	41903-57-5	—	—
2,3,7,8-TCDF	51207-31-9	¹³ C ₁₂ -2,3,7,8-TCDF	89059-46-1
Total-TCDF	55722-27-5	—	—
1,2,3,7,8-PeCDD	40321-76-4	¹³ C ₁₂ -1,2,3,7,8-PeCDD	109719-79-1
Total-PeCDD	36088-22-9	—	—
1,2,3,7,8-PeCDF	57117-41-6	¹³ C ₁₂ -1,2,3,7,8-PeCDF	109719-77-9
2,3,4,7,8-PeCDF	57117-31-4	¹³ C ₁₂ -2,3,4,7,8-PeCDF	116843-02-8
Total-PeCDF	30402-15-4	—	—
1,2,3,4,7,8-HxCDD	39227-28-6	¹³ C ₁₂ -1,2,3,4,7,8-HxCDD	109719-80-4
1,2,3,6,7,8-HxCDD	57653-85-7	¹³ C ₁₂ -1,2,3,6,7,8-HxCDD	109719-81-5
1,2,3,7,8,9-HxCDD	19408-74-3	¹³ C ₁₂ -1,2,3,7,8,9-HxCDD	109719-82-6
Total-HxCDD	34465-46-8	—	—
1,2,3,4,7,8-HxCDF	70648-26-9	¹³ C ₁₂ -1,2,3,4,7,8-HxCDF	114423-98-2
1,2,3,6,7,8-HxCDF	57117-44-9	¹³ C ₁₂ -1,2,3,6,7,8-HxCDF	116843-03-9
1,2,3,7,8,9-HxCDF	72918-21-9	¹³ C ₁₂ -1,2,3,7,8,9-HxCDF	116843-04-0
2,3,4,6,7,8-HxCDF	60851-34-5	¹³ C ₁₂ -2,3,4,6,7,8-HxCDF	116843-05-1
Total-HxCDF	55684-94-1	—	—
1,2,3,4,6,7,8-HpCDD	35822-46-9	¹³ C ₁₂ -1,2,3,4,6,7,8-HpCDD	109719-83-7
Total-HpCDD	37871-00-4	—	—
1,2,3,4,6,7,8-HpCDF	67562-39-4	¹³ C ₁₂ -1,2,3,4,6,7,8-HpCDF	109719-84-8
1,2,3,4,7,8,9-HpCDF	55673-89-7	¹³ C ₁₂ -1,2,3,4,7,8,9-HpCDF	109719-94-0
Total-HpCDF	38998-75-3	—	—
OCDD	3268-87-9	¹³ C ₁₂ -OCDD	114423-97-1
OCDF	39001-02-0	not used	—

¹ Chlorinated dibenzo-*p*-dioxins and chlorinated dibenzofurans

TCDD = Tetrachlorodibenzo-*p*-dioxin
 PeCDD = Pentachlorodibenzo-*p*-dioxin
 HxCDD = Hexachlorodibenzo-*p*-dioxin
 HpCDD = Heptachlorodibenzo-*p*-dioxin
 OCDD = Octachlorodibenzo-*p*-dioxin

TCDF = Tetrachlorodibenzofuran
 PeCDF = Pentachlorodibenzofuran
 HxCDF = Hexachlorodibenzofuran
 HpCDF = Heptachlorodibenzofuran
 OCDF = Octachlorodibenzofuran

TABLE 2. RETENTION TIME REFERENCES, QUANTITATION REFERENCES, RELATIVE RETENTION TIMES, AND MINIMUM LEVELS FOR CDDS AND CDFS

CDD/CDF	Retention time and quantitation reference	Relative retention time	Minimum level ¹		
			Water (pg/L; ppq)	Solid (ng/kg; ppt)	Extract (pg/μL; ppb)
<i>Compounds using ¹³C₁₂-1,2,3,4-TCDD as the injection internal standard</i>					
2,3,7,8-TCDF	¹³ C ₁₂ -2,3,7,8-TCDF	0.999–1.003	10	1	0.5
2,3,7,8-TCDD	¹³ C ₁₂ -2,3,7,8-TCDD	0.999–1.002	10	1	0.5
1,2,3,7,8-PeCDF	¹³ C ₁₂ -1,2,3,7,8-PeCDF	0.999–1.002	50	5	2.5
2,3,4,7,8-PeCDF	¹³ C ₁₂ -2,3,4,7,8-PeCDF	0.999–1.002	50	5	2.5
1,2,3,7,8-PeCDD	¹³ C ₁₂ -1,2,3,7,8-PeCDD	0.999–1.002	50	5	2.5
¹³ C ₁₂ -2,3,7,8-TCDF	¹³ C ₁₂ -1,2,3,4-TCDD	0.923–1.103			
¹³ C ₁₂ -2,3,7,8-TCDD	¹³ C ₁₂ -1,2,3,4-TCDD	0.976–1.043			
³⁷ Cl ₄ -2,3,7,8-TCDD	¹³ C ₁₂ -1,2,3,4-TCDD	0.989–1.052			
¹³ C ₁₂ -1,2,3,7,8-PeCDF	¹³ C ₁₂ -1,2,3,4-TCDD	1.000–1.425			
¹³ C ₁₂ -2,3,4,7,8-PeCDF	¹³ C ₁₂ -1,2,3,4-TCDD	1.011–1.526			
¹³ C ₁₂ -1,2,3,7,8-PeCDD	¹³ C ₁₂ -1,2,3,4-TCDD	1.000–1.567			
<i>Compounds using ¹³C₁₂-1,2,3,7,8,9-HxCDD as the injection internal standard</i>					
1,2,3,4,7,8-HxCDF	¹³ C ₁₂ -1,2,3,4,7,8-HxCDF	0.999–1.001	50	5	2.5
1,2,3,6,7,8-HxCDF	¹³ C ₁₂ -1,2,3,6,7,8-HxCDF	0.997–1.005	50	5	2.5
1,2,3,7,8,9-HxCDF	¹³ C ₁₂ -1,2,3,7,8,9-HxCDF	0.999–1.001	50	5	2.5
2,3,4,6,7,8-HxCDF	¹³ C ₁₂ -2,3,4,6,7,8-HxCDF	0.999–1.001	50	5	2.5
1,2,3,4,7,8-HxCDD	¹³ C ₁₂ -1,2,3,4,7,8-HxCDD	0.999–1.001	50	5	2.5
1,2,3,6,7,8-HxCDD	¹³ C ₁₂ -1,2,3,6,7,8-HxCDD	0.998–1.004	50	5	2.5
1,2,3,7,8,9-HxCDD	— ²	1.000–1.019	50	5	2.5
1,2,3,4,6,7,8-HpCDF	¹³ C ₁₂ -1,2,3,4,6,7,8-HpCDF	0.999–1.001	50	5	2.5
1,2,3,4,7,8,9-HpCDF	¹³ C ₁₂ -1,2,3,4,7,8,9-HpCDF	0.999–1.001	50	5	2.5
1,2,3,4,6,7,8-HpCDD	¹³ C ₁₂ -1,2,3,4,6,7,8-HpCDD	0.999–1.001	50	5	2.5
OCDF	¹³ C ₁₂ -OCDD	0.999–1.008	100	10	5.0
OCDD	¹³ C ₁₂ -OCDD	0.999–1.001	100	10	5.0
¹³ C ₁₂ -1,2,3,4,7,8-HxCDF	¹³ C ₁₂ -1,2,3,7,8,9-HxCDD	0.944–0.970			
¹³ C ₁₂ -1,2,3,6,7,8-HxCDF	¹³ C ₁₂ -1,2,3,7,8,9-HxCDD	0.949–0.975			
¹³ C ₁₂ -1,2,3,7,8,9-HxCDF	¹³ C ₁₂ -1,2,3,7,8,9-HxCDD	0.977–1.047			
¹³ C ₁₂ -2,3,4,6,7,8-HxCDF	¹³ C ₁₂ -1,2,3,7,8,9-HxCDD	0.959–1.021			
¹³ C ₁₂ -1,2,3,4,7,8-HxCDD	¹³ C ₁₂ -1,2,3,7,8,9-HxCDD	0.977–1.000			
¹³ C ₁₂ -1,2,3,6,7,8-HxCDD	¹³ C ₁₂ -1,2,3,7,8,9-HxCDD	0.981–1.003			
¹³ C ₁₂ -1,2,3,4,6,7,8-HpCDF	¹³ C ₁₂ -1,2,3,7,8,9-HxCDD	1.043–1.085			

TABLE 2. RETENTION TIME REFERENCES, QUANTITATION REFERENCES, RELATIVE RETENTION TIMES, AND MINIMUM LEVELS FOR CDDS AND CDFS

CDD/CDF	Retention time and quantitation reference	Relative retention time	Minimum level ¹		
			Water (pg/L; ppq)	Solid (ng/kg; ppt)	Extract (pg/μL; ppb)
¹³ C ₁₂ -1,2,3,4,7,8,9-HpCDF	¹³ C ₁₂ -1,2,3,7,8,9-HxCDD	1.057–1.151			
¹³ C ₁₂ -1,2,3,4,6,7,8-HpCDD	¹³ C ₁₂ -1,2,3,7,8,9-HxCDD	1.086–1.110			
¹³ C ₁₂ -OCDD	¹³ C ₁₂ -1,2,3,7,8,9-HxCDD	1.032–1.311			

¹The Minimum Level (ML) for each analyte is defined as the level at which the entire analytical system must give a recognizable signal and acceptable calibration point. It is equivalent to the concentration of the lowest calibration standard, assuming that all method-specified sample weights, volumes, and cleanup procedures have been employed.

²The retention time reference for 1,2,3,7,8,9-HxCDD is³ C₁₂-1,2,3,6,7,8-HxCDD, and 1,2,3,7,8,9-HxCDD is quantified using the averaged responses for ¹³C₁₂-1,2,3,4,7,8-HxCDD and ¹³C₁₂-1,2,3,6,7,8-HxCDD.

TABLE 3. CONCENTRATION OF STOCK AND SPIKING SOLUTIONS CONTAINING CDDS/CDFS AND LABELED COMPOUNDS

CDD/CDF	Labeled Compound Stock Solution ¹ (ng/mL)	Labeled Compound Spiking Solution ² (ng/mL)	PAR Stock Solution ³ (ng/mL)	PAR Spiking Solution ⁴ (ng/mL)
2,3,7,8-TCDD	—	—	40	0.8
2,3,7,8-TCDF	—	—	40	0.8
1,2,3,7,8-PeCDD	—	—	200	4
1,2,3,7,8-PeCDF	—	—	200	4
2,3,4,7,8-PeCDF	—	—	200	4
1,2,3,4,7,8-HxCDD	—	—	200	4
1,2,3,6,7,8-HxCDD	—	—	200	4
1,2,3,7,8,9-HxCDD	—	—	200	4
1,2,3,4,7,8-HxCDF	—	—	200	4
1,2,3,6,7,8-HxCDF	—	—	200	4
1,2,3,7,8,9-HxCDF	—	—	200	4
2,3,4,6,7,8-HxCDF	—	—	200	4
1,2,3,4,6,7,8-HpCDD	—	—	200	4
1,2,3,4,6,7,8-HpCDF	—	—	200	4
1,2,3,4,7,8,9-HpCDF	—	—	200	4
OCDD	—	—	400	8
OCDF	—	—	400	8
¹³ C ₁₂ -2,3,7,8-TCDD	100	2	—	—
¹³ C ₁₂ -2,3,7,8-TCDF	100	2	—	—
¹³ C ₁₂ -1,2,3,7,8-PeCDD	100	2	—	—
¹³ C ₁₂ -1,2,3,7,8-PeCDF	100	2	—	—
¹³ C ₁₂ -2,3,4,7,8-PeCDF	100	2	—	—
¹³ C ₁₂ -1,2,3,4,7,8-HxCDD	100	2	—	—
¹³ C ₁₂ -1,2,3,6,7,8-HxCDD	100	2	—	—
¹³ C ₁₂ -1,2,3,4,7,8-HxCDF	100	2	—	—
¹³ C ₁₂ -1,2,3,6,7,8-HxCDF	100	2	—	—
¹³ C ₁₂ -1,2,3,7,8,9-HxCDF	100	2	—	—
¹³ C ₁₂ -2,3,4,6,7,8-HxCDF	100	2	—	—
¹³ C ₁₂ -1,2,3,4,6,7,8-HpCDD	100	2	—	—
¹³ C ₁₂ -1,2,3,4,6,7,8-HpCDF	100	2	—	—
¹³ C ₁₂ -1,2,3,4,7,8,9-HpCDF	100	2	—	—
¹³ C ₁₂ -OCDD	200	4	—	—

TABLE 3. CONCENTRATION OF STOCK AND SPIKING SOLUTIONS CONTAINING CDDS/CDFS AND LABELED COMPOUNDS

CDD/CDF	Labeled Compound Stock Solution ¹ (ng/mL)	Labeled Compound Spiking Solution ² (ng/mL)	PAR Stock Solution ³ (ng/mL)	PAR Spiking Solution ⁴ (ng/mL)
	Concentration (ng/mL)			
<i>Cleanup Standard</i> ⁵				
³⁷ Cl ₄ -2,3,7,8-TCDD	0.8			
<i>Internal Standards</i> ⁶				
¹³ C ₁₂ -1,2,3,4-TCDD	200			
¹³ C ₁₂ -1,2,3,7,8,9-HxCDD	200			

¹ Section 7.10—prepared in nonane and diluted to prepare spiking solution.

² Section 7.10.3—prepared in acetone from stock solution daily.

³ Section 7.9—prepared in nonane and diluted to prepare spiking solution.

⁴ Section 7.14—prepared in acetone from stock solution daily.

⁵ Section 7.11—prepared in nonane and added to extract prior to cleanup.

⁶ Section 7.12—prepared in nonane and added to the concentrated extract immediately prior to injection into the GC (Section 14.2).

TABLE 4. CONCENTRATION OF CDDs/CDFs IN CALIBRATION AND CALIBRATION VERIFICATION SOLUTIONS ¹ (section 15.3)

	CDD/CDF	CS2 (ng/mL)	CS3 (ng/mL)	CS4 (ng/mL)	CS5 (ng/mL)
2,3,7,8-TCDD	0.5	2	10	40	200
2,3,7,8-TCDF	0.5	2	10	40	200
1,2,3,7,8-PeCDD	2.5	10	50	200	1000
1,2,3,7,8-PeCDF	2.5	10	50	200	1000
2,3,4,7,8-PeCDF	2.5	10	50	200	1000
1,2,3,4,7,8-HxCDD	2.5	10	50	200	1000
1,2,3,6,7,8-HxCDD	2.5	10	50	200	1000
1,2,3,7,8,9-HxCDD	2.5	10	50	200	1000
1,2,3,4,7,8-HxCDF	2.5	10	50	200	1000
1,2,3,6,7,8-HxCDF	2.5	10	50	200	1000
1,2,3,7,8,9-HxCDF	2.5	10	50	200	1000
2,3,4,6,7,8-HxCDF	2.5	10	50	200	1000
1,2,3,4,6,7,8-HpCDD	2.5	10	50	200	1000
1,2,3,4,6,7,8-HpCDF	2.5	10	50	200	1000
1,2,3,4,7,8,9-HpCDF	2.5	10	50	200	1000
OCDD	5.0	20	100	400	2000
OCDF	5.0	20	100	400	2000
¹³ C ₁₂ -2,3,7,8-TCDD	100	100	100	100	100
¹³ C ₁₂ -2,3,7,8-TCDF	100	100	100	100	100
¹³ C ₁₂ -1,2,3,7,8-PeCDD	100	100	100	100	100
¹³ C ₁₂ -PeCDF	100	100	100	100	100
¹³ C ₁₂ -2,3,4,7,8-PeCDF	100	100	100	100	100
¹³ C ₁₂ -1,2,3,4,7,8-HxCDD	100	100	100	100	100
¹³ C ₁₂ -1,2,3,6,7,8-HxCDD	100	100	100	100	100
¹³ C ₁₂ -1,2,3,4,7,8-HxCDF	100	100	100	100	100
¹³ C ₁₂ -1,2,3,6,7,8-HxCDF	100	100	100	100	100
¹³ C ₁₂ -1,2,3,7,8,9-HxCDF	100	100	100	100	100
¹³ C ₁₂ -1,2,3,4,6,7,8-HpCDD	100	100	100	100	100
¹³ C ₁₂ -1,2,3,4,6,7,8-HpCDF	100	100	100	100	100
¹³ C ₁₂ -1,2,3,4,7,8,9-HpCDF	100	100	100	100	100
¹³ C ₁₂ -OCDD	200	200	200	200	200
<i>Cleanup Standard</i>					
³⁷ Cl ₄ -2,3,7,8-TCDD	0.5	2	10	40	200
<i>Internal Standards</i>					
¹³ C ₁₂ -1,2,3,4-TCDD	100	100	100	100	100
¹³ C ₁₂ -1,2,3,7,8,9-HxCDD	100	100	100	100	100

TABLE 5. GC RETENTION TIME WINDOW DEFINING SOLUTION AND ISOMER SPECIFICITY TEST STANDARD (SECTION 7.15)

DB-5 Column GC Retention-Time Window Defining Solution		
CDD/CDF	First Eluted	Last Eluted
TCDF	1,3,6,8-	1,2,8,9-
TCDD	1,3,6,8-	1,2,8,9-
PeCDF	1,3,4,6,8-	1,2,3,8,9-
PeCDD	1,2,4,7,9-	1,2,3,8,9-
HxCDF	1,2,3,4,6,8-	1,2,3,4,8,9-
HxCDD	1,2,4,6,7,9-	1,2,3,4,6,7-
HpCDF	1,2,3,4,6,7,8-	1,2,3,4,7,8,9-
HpCDD	1,2,3,4,6,7,9-	1,2,3,4,6,7,8-

DB-5 Column TCDD Specificity Test Standard

1,2,3,7+1,2,3,8-TCDD

2,3,7,8-TCDD

1,2,3,9-TCDD

DB-225 Column TCDF Isomer Specificity Test Standard

2,3,4,7-TCDF

2,3,7,8-TCDF

1,2,3,9-TCDF

TABLE 6. ACCEPTANCE CRITERIA FOR PERFORMANCE TESTS WHEN ALL CDDS/CDFS ARE TESTED ¹

CDD/CDF	Test Conc. (ng/mL)	IPR ^{2,3}		OPR (ng/mL)	VER (ng/mL)
		s (ng/mL)	X (ng/mL)		
2,3,7,8-TCDD	10	2.8	8.3-12.9	6.7-15.8	7.8-12.9
2,3,7,8-TCDF	10	2.0	8.7-13.7	7.5-15.8	8.4-12.0
1,2,3,7,8-PeCDD	50	7.5	38-66	35-71	39-65
1,2,3,7,8-PeCDF	50	7.5	43-62	40-67	41-60
2,3,4,7,8-PeCDF	50	8.6	36-75	34-80	41-61
1,2,3,4,7,8-HxCDD	50	9.4	39-76	35-82	39-64
1,2,3,6,7,8-HxCDD	50	7.7	42-62	38-67	39-64
1,2,3,7,8,9-HxCDD	50	11.1	37-71	32-81	41-61
1,2,3,4,7,8-HxCDF	50	8.7	41-59	36-67	45-56
1,2,3,6,7,8-HxCDF	50	6.7	46-60	42-65	44-57
1,2,3,7,8,9-HxCDF	50	6.4	42-61	39-65	45-56
2,3,4,6,7,8-HxCDF	50	7.4	37-74	35-78	44-57
1,2,3,4,6,7,8-HpCDD	50	7.7	38-65	35-70	43-58
1,2,3,4,6,7,8-HpCDF	50	6.3	45-56	41-61	45-55
1,2,3,4,7,8,9-HpCDF	50	8.1	43-63	39-69	43-58
OCDD	100	19	89-127	78-144	79-126
OCDF	100	27	74-146	63-170	63-159
¹³ C ₁₂ -2,3,7,8-TCDD	100	37	28-134	20-175	82-121
¹³ C ₁₂ -2,3,7,8-TCDF	100	35	31-113	22-152	71-140
¹³ C ₁₂ -1,2,3,7,8-PeCDD	100	39	27-184	21-227	62-160
¹³ C ₁₂ -1,2,3,7,8-PeCDF	100	34	27-156	21-192	76-130
¹³ C ₁₂ -2,3,4,7,8-PeCDF	100	38	16-279	13-328	77-130
¹³ C ₁₂ -1,2,3,4,7,8-HxCDD	100	41	29-147	21-193	85-117
¹³ C ₁₂ -1,2,3,6,7,8-HxCDD	100	38	34-122	25-163	85-118
¹³ C ₁₂ -1,2,3,4,7,8-HxCDF	100	43	27-152	19-202	76-131
¹³ C ₁₂ -1,2,3,6,7,8-HxCDF	100	35	30-122	21-159	70-143
¹³ C ₁₂ -1,2,3,7,8,9-HxCDF	100	40	24-157	17-205	74-135
¹³ C ₁₂ -2,3,4,6,7,8,-HxCDF	100	37	29-136	22-176	73-137
¹³ C ₁₂ -1,2,3,4,6,7,8-HpCDD	100	35	34-129	26-166	72-138
¹³ C ₁₂ -1,2,3,4,6,7,8-HpCDF	100	41	32-110	21-158	78-129
¹³ C ₁₂ -1,2,3,4,7,8,9-HpCDF	100	40	28-141	20-186	77-129
¹³ C ₁₂ -OCDD	200	95	41-276	26-397	96-415
³⁷ Cl ₄ -2,3,7,8-TCDD	10	3.6	3.9-15.4	3.1-19.1	7.9-12.7

¹ All specifications are given as concentration in the final extract, assuming a 20 µL volume.² s = standard deviation of the concentration.³ X = average concentration.

TABLE 6A. ACCEPTANCE CRITERIA FOR PERFORMANCE TESTS WHEN ONLY TETRA COMPOUNDS ARE TESTED ¹

CDD/CDF	Test Conc. (ng/mL)	IPR ^{2,3}		OPR (ng/mL)	VER (ng/mL)
		s (ng/mL)	X (ng/mL)		
2,3,7,8-TCDD	10	2.7	8.7-12.4	7.3-14.6	8.2-12.3
2,3,7,8-TCDF	10	2.0	9.1-13.1	8.0-14.7	8.6-11.6
¹³ C ₁₂ -2,3,7,8-TCDD	100	35	32-115	25-141	85-117
¹³ C ₁₂ -2,3,7,8-TCDF	100	34	35-99	26-126	76-131
³⁷ Cl ₄ -2,3,7,8-TCDD	10	3.4	4.5-13.4	3.7-15.8	8.3-12.1

¹ All specifications are given as concentration in the final extract, assuming a 20 µL volume.

² s = standard deviation of the concentration.

³ X = average concentration.

TABLE 7. LABELED COMPOUND RECOVERY IN SAMPLES WHEN ALL CDDS/CDFS ARE TESTED

Compound	Test Conc. (ng/mL)	Labeled Compound Recovery	
		(ng/mL) ¹	(%)
¹³ C ₁₂ -2,3,7,8-TCDD	100	25-164	25-164
¹³ C ₁₂ -2,3,7,8-TCDF	100	24-169	24-169
¹³ C ₁₂ -1,2,3,7,8-PeCDD	100	25-181	25-181
¹³ C ₁₂ -1,2,3,7,8-PeCDF	100	24-185	24-185
¹³ C ₁₂ -2,3,4,7,8-PeCDF	100	21-178	21-178
¹³ C ₁₂ -1,2,3,4,7,8-HxCDD	100	32-141	32-141
¹³ C ₁₂ -1,2,3,6,7,8,-HxCDD	100	28-130	28-130
¹³ C ₁₂ -1,2,3,4,7,8-HxCDF	100	26-152	26-152
¹³ C ₁₂ -1,2,3,6,7,8-HxCDF	100	26-123	26-123
¹³ C ₁₂ -1,2,3,7,8,9-HxCDF	100	29-147	29-147
¹³ C ₁₂ -2,3,4,6,7,8,-HxCDF	100	28-136	28-136
¹³ C ₁₂ -1,2,3,4,6,7,8-HpCDD	100	23-140	23-140
¹³ C ₁₂ -1,2,3,4,6,7,8-HpCDF	100	28-143	28-143
¹³ C ₁₂ -1,2,3,4,7,8,9-HpCDF	100	26-138	26-138
¹³ C ₁₂ -OCDD	200	34-313	17-157
³⁷ Cl ₄ -2,3,7,8-TCDD	10	3.5-19.7	35-197

¹ Specification given as concentration in the final extract, assuming a 20-µL volume.

TABLE 7A. LABELED COMPOUND RECOVERY IN SAMPLES WHEN ONLY TETRA COMPOUNDS ARE TESTED

Compound	Test Conc. (ng/mL)	Labeled compound recovery	
		(ng/mL) ¹	(%)
¹³ C ₁₂ -2,3,7,8-TCDD	100	31-137	31-137
¹³ C ₁₂ -2,3,7,8-TCDF	100	29-140	29-140
³⁷ Cl ₄ -2,3,7,8-TCDD	10	4.2-16.4	42-164

¹ Specification given as concentration in the final extract, assuming a 20 µL volume.

TABLE 8. DESCRIPTORS, EXACT M/Z'S, M/Z TYPES, AND ELEMENTAL COMPOSITIONS OF THE CDDs AND CDFs

Descriptor	Exact M/Z ¹	M/Z Type	Elemental Composition	Substance ²
1	292.9825	Lock	C ₇ F ₁₁	PFK
	303.9016	M	C ₁₂ H ₄ ³⁵ Cl ₄ O	TCDF
	305.8987	M+2	C ₁₂ H ₄ ³⁵ Cl ₃ ³⁷ Cl O	TCDF
	315.9419	M	¹³ C ₁₂ H ₄ ³⁵ Cl ₄ O	TCDF ³
	317.9389	M+2	¹³ C ₁₂ H ₄ ³⁵ Cl ₃ ³⁷ Cl O	TCDF ³
	319.8965	M	C ₁₂ H ₄ ³⁵ Cl ₄ O ₂	TCDD
	321.8936	M+2	C ₁₂ H ₄ ³⁵ Cl ₃ ³⁷ Cl O ₂	TCDD
	327.8847	M	C ₁₂ H ₄ ³⁷ Cl ₄ O ₂	TCDD ⁴
	330.9792	QC	C ₇ F ₁₃	PFK
	331.9368	M	¹³ C ₁₂ H ₄ ³⁵ Cl ₄ O ₂	TCDD ³
	333.9339	M+2	¹³ C ₁₂ H ₄ ³⁵ Cl ₃ ³⁷ Cl O ₂	TCDD ³
	375.8364	M+2	C ₁₂ H ₄ ³⁵ Cl ₅ ³⁷ Cl O	HxCDFE
	2	339.8597	M+2	C ₁₂ H ₃ ³⁵ Cl ₄ ³⁷ Cl O
341.8567		M+4	C ₁₂ H ₃ ³⁵ Cl ₃ ³⁷ Cl ₂ O	PeCDF
351.9000		M+2	¹³ C ₁₂ H ₃ ³⁵ Cl ₄ ³⁷ Cl O	PeCDF
353.8970		M+4	¹³ C ₁₂ H ₃ ³⁵ Cl ₃ ³⁷ Cl ₂ O	PeCDF ³
354.9792		Lock	C ₉ F ₁₃	PFK
355.8546		M+2	C ₁₂ H ₃ ³⁵ Cl ₄ ³⁷ Cl O ₂	PeCDD
357.8516		M+4	C ₁₂ H ₃ ³⁵ Cl ₃ ³⁷ Cl ₂ O ₂	PeCDD
367.8949		M+2	¹³ C ₁₂ H ₃ ³⁵ Cl ₄ ³⁷ Cl O ₂	PeCDD ³
369.8919		M+4	¹³ C ₁₂ H ₃ ³⁵ Cl ₃ ³⁷ Cl ₂ O ₂	PeCDD ³
409.7974		M+2	C ₁₂ H ₃ ³⁵ Cl ₆ ³⁷ Cl O	HpCDPE
3	373.8208	M+2	C ₁₂ H ₂ ³⁵ Cl ₅ ³⁷ Cl O	HxCDF
	375.8178	M+4	C ₁₂ H ₂ ³⁵ Cl ₄ ³⁷ Cl ₂ O	HxCDF
	383.8639	M	¹³ C ₁₂ H ₂ ³⁵ Cl ₆ O	HxCDF ³
	385.8610	M+2	¹³ C ₁₂ H ₂ ³⁵ Cl ₅ ³⁷ Cl O	HxCDF ³
	389.8157	M+2	C ₁₂ H ₂ ³⁵ Cl ₅ ³⁷ Cl O ₂	HxCDD
	391.8127	M+4	C ₁₂ H ₂ ³⁵ Cl ₄ ³⁷ Cl ₂ O ₂	HxCDD

TABLE 8. DESCRIPTORS, EXACT M/Z's, M/Z TYPES, AND ELEMENTAL COMPOSITIONS OF THE CDDs AND CDFs

Descriptor	Exact M/Z ¹	M/Z Type	Elemental Composition	Substance ²
	392.9760	Lock	C ₉ F ₁₅	PFK
	401.8559	M+2	¹³ C ₁₂ H ₂ ³⁵ Cl ₃ ³⁷ Cl O	HxCDD ³
	403.8529	M+4	¹³ C ₁₂ H ₂ ³⁵ Cl ₄ ³⁷ Cl ₂ O	HxCDD ³
	430.9729	QC	C ₉ F ₁₇	PFK
	445.7555	M+4	C ₁₂ H ₂ ³⁵ Cl ₆ ³⁷ Cl ₂ O	OCDPE
4	407.7818	M+2	C ₁₂ H ³⁵ Cl ₆ ³⁷ Cl O	HpCDF
	409.7789	M+4	C ₁₂ H ³⁵ Cl ₅ ³⁷ Cl ₂ O	HpCDF
	417.8253	M	¹³ C ₁₂ H ³⁵ Cl ₇ O	HpCDF ³
	419.8220	M+2	¹³ C ₁₂ H ³⁵ Cl ₆ ³⁷ Cl O	HpCDF ³
	423.7766	M+2	C ₁₂ H ³⁵ Cl ₆ ³⁷ Cl O ₂	HpCDD
	425.7737	M+4	C ₁₂ H ³⁵ Cl ₅ ³⁷ Cl ₂ O	HpCDD
	430.9729	Lock	C ₉ F ₁₇	PFK
	435.8169	M+2	¹³ C ₁₂ H ³⁵ Cl ₆ ³⁷ Cl O ₂	HpCDD ³
	437.8140	M+4	¹³ C ₁₂ H ³⁵ Cl ₅ ³⁷ Cl ₂ O ₂	HpCDD ³
	479.7165	M+4	C ₁₂ H ³⁵ Cl ₇ ³⁷ Cl ₂ O	NCDPE
5	441.7428	M+2	C ₁₂ ³⁵ Cl ₇ ³⁷ Cl O	OCDF
	442.9728	Lock	C ₁₀ F ₁₇	PFK
	443.7399	M+4	C ₁₂ ³⁵ Cl ₆ ³⁷ Cl ₂ O	OCDF
	457.7377	M+2	C ₁₂ ³⁵ Cl ₇ ³⁷ Cl O ₂	OCDD
	459.7348	M+4	C ₁₂ ³⁵ Cl ₆ ³⁷ Cl ₂ O ₂	OCDD
	469.7779	M+2	¹³ C ₁₂ ³⁵ Cl ₇ ³⁷ Cl O ₂	OCDD ³
	471.7750	M+4	¹³ C ₁₂ ³⁵ Cl ₆ ³⁷ Cl ₂ O ₂	OCDD ³
	513.6775	M+4	C ₁₂ ³⁵ Cl ₈ ³⁷ Cl ₂ O	DCDPE

¹ Nuclidic masses used:

H = 1.007825	C = 12.00000	¹³ C = 13.003355	F = 18.9984
O = 15.994915	³⁵ Cl = 34.968853	³⁷ Cl = 36.965903	

² TCDD = Tetrachlorodibenzo- <i>p</i> -dioxin	TCDF = Tetrachlorodibenzofuran
PeCDD = Pentachlorodibenzo- <i>p</i> -dioxin	PeCDF = Pentachlorodibenzofuran
HxCDD = Hexachlorodibenzo- <i>p</i> -dioxin	HxCDF = Hexachlorodibenzofuran
HpCDD = Heptachlorodibenzo- <i>p</i> -dioxin	HpCDF = Heptachlorodibenzofuran
OCDD = Octachlorodibenzo- <i>p</i> -dioxin	OCDF = Octachlorodibenzofuran
HxCDPE = Hexachlorodiphenyl ether	HpCDPE = Heptachlorodiphenyl ether
OCDPE = Octachlorodiphenyl ether	NCDPE = Nonachlorodiphenyl ether
DCDPE = Decachlorodiphenyl ether	PFK = Perfluorokerosene

³ Labeled compound.⁴ There is only one m/z for ³⁷Cl₄-2,3,7,8,-TCDD (cleanup standard).

TABLE 9. THEORETICAL ION ABUNDANCE RATIOS AND QC LIMITS

Number of Chlorine Atoms	M/Z's Forming Ratio	Theoretical Ratio	QC Limit ¹	
			Lower	Upper
4 ²	M/(M+2)	0.77	0.65	0.89
5	(M+2)/(M+4)	1.55	1.32	1.78
6	(M+2)/(M+4)	1.24	1.05	1.43
6 ³	M/(M+2)	0.51	0.43	0.59
7	(M+2)/(M+4)	1.05	0.88	1.20
7 ⁴	M/(M+2)	0.44	0.37	0.51
8	(M+2)/(M+4)	0.89	0.76	1.02

¹ QC limits represent $\pm 15\%$ windows around the theoretical ion abundance ratios.

² Does not apply to ³⁷Cl₄-2,3,7,8-TCDD (cleanup standard).

³ Used for ¹³C₁₂-HxCDF only.

⁴ Used for ¹³C₁₂-HpCDF only.

TABLE 10. SUGGESTED SAMPLE QUANTITIES TO BE EXTRACTED FOR VARIOUS MATRICES ¹

Sample Matrix ²	Example	Percent Solids	Phase	Quantity Extracted
<i>Single-phase</i>				
Aqueous	Drinking water Groundwater Treated wastewater	<1	— ³	1000 mL
Solid	Dry soil Compost Ash	>20	Solid	10 g
Organic	Waste solvent Waste oil Organic polymer	<1	Organic	10 g
Tissue	Fish Human adipose	—	Organic	10 g
<i>Multi-phase</i>				
<i>Liquid/Solid</i>				
Aqueous/Solid	Wet soil Untreated effluent Digested municipal sludge Filter cake Paper pulp	1–30	Solid	10 g
Organic/solid	Industrial sludge Oily waste	1–100	Both	10 g
<i>Liquid/Liquid</i>				
Aqueous/organic	In-process effluent Untreated effluent Drum waste	<1	Organic	10 g
Aqueous/organic/solid	Untreated effluent Drum waste	>1	Organic & solid	10 g

¹ The quantity of sample to be extracted is adjusted to provide 10 g of solids (dry weight). One liter of aqueous samples containing 1% solids will contain 10 g of solids. For aqueous samples containing greater than 1% solids, a lesser volume is used so that 10 g of solids (dry weight) will be extracted.

² The sample matrix may be amorphous for some samples. In general, when the CDDs/CDFs are in contact with a multiphase system in which one of the phases is water, they will be preferentially dispersed in or adsorbed on the alternate phase because of their low solubility in water.

³ Aqueous samples are filtered after spiking with the labeled compounds. The filtrate and the materials trapped on the filter are extracted separately, and the extracts are combined for cleanup and analysis.

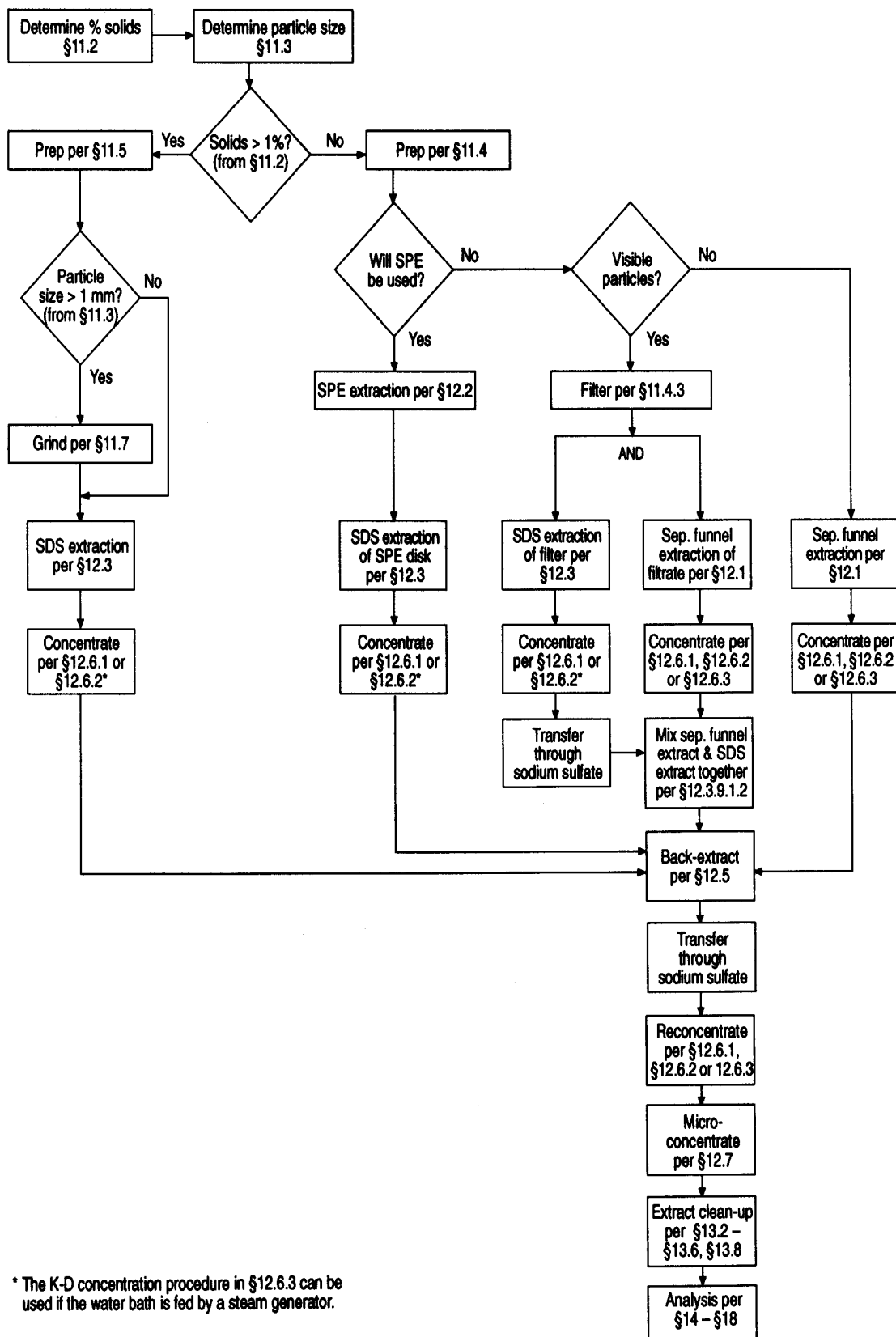

52-028-1A

Figure 1. Flow Chart for Analysis of Aqueous and Solid Samples

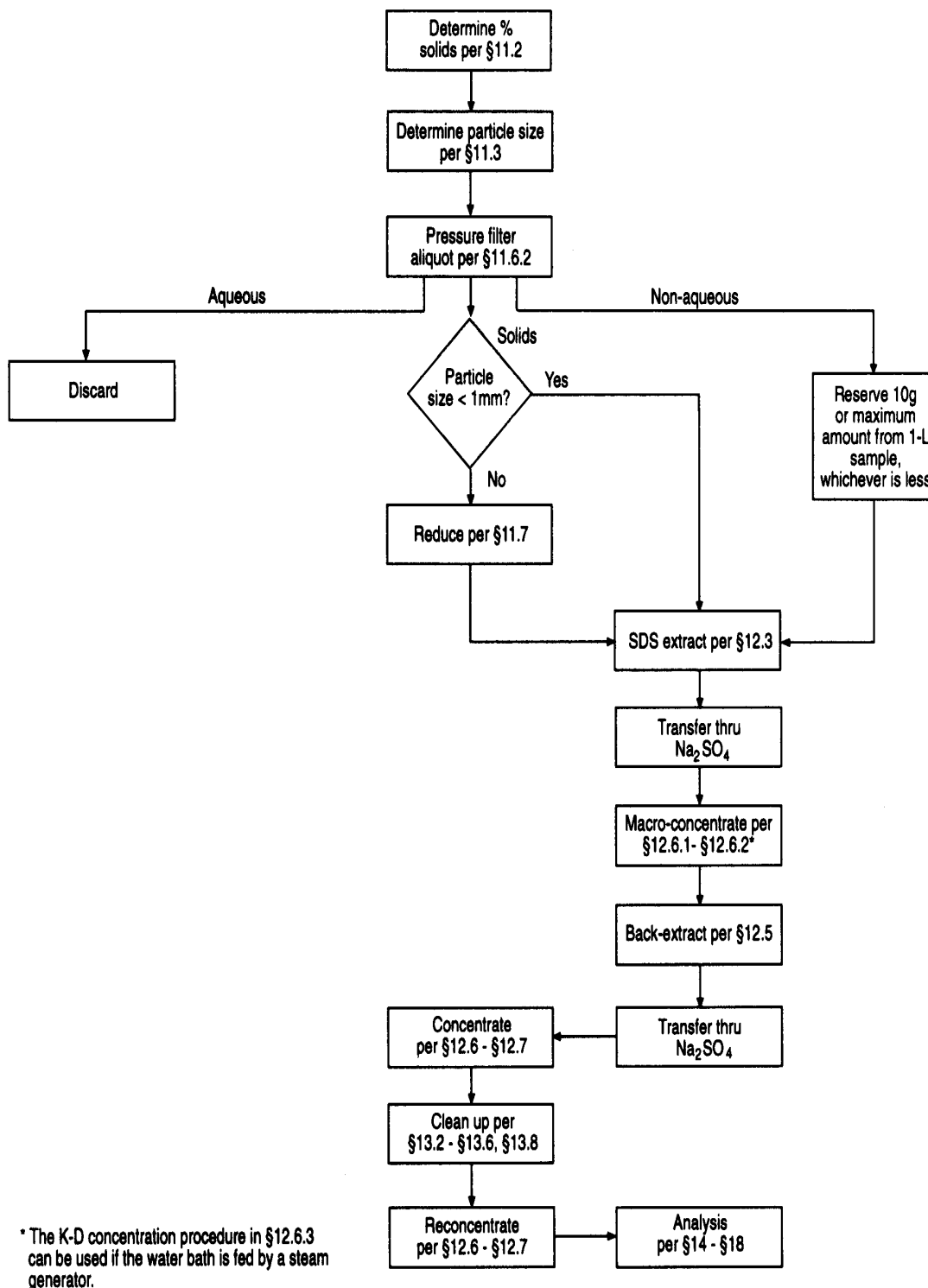
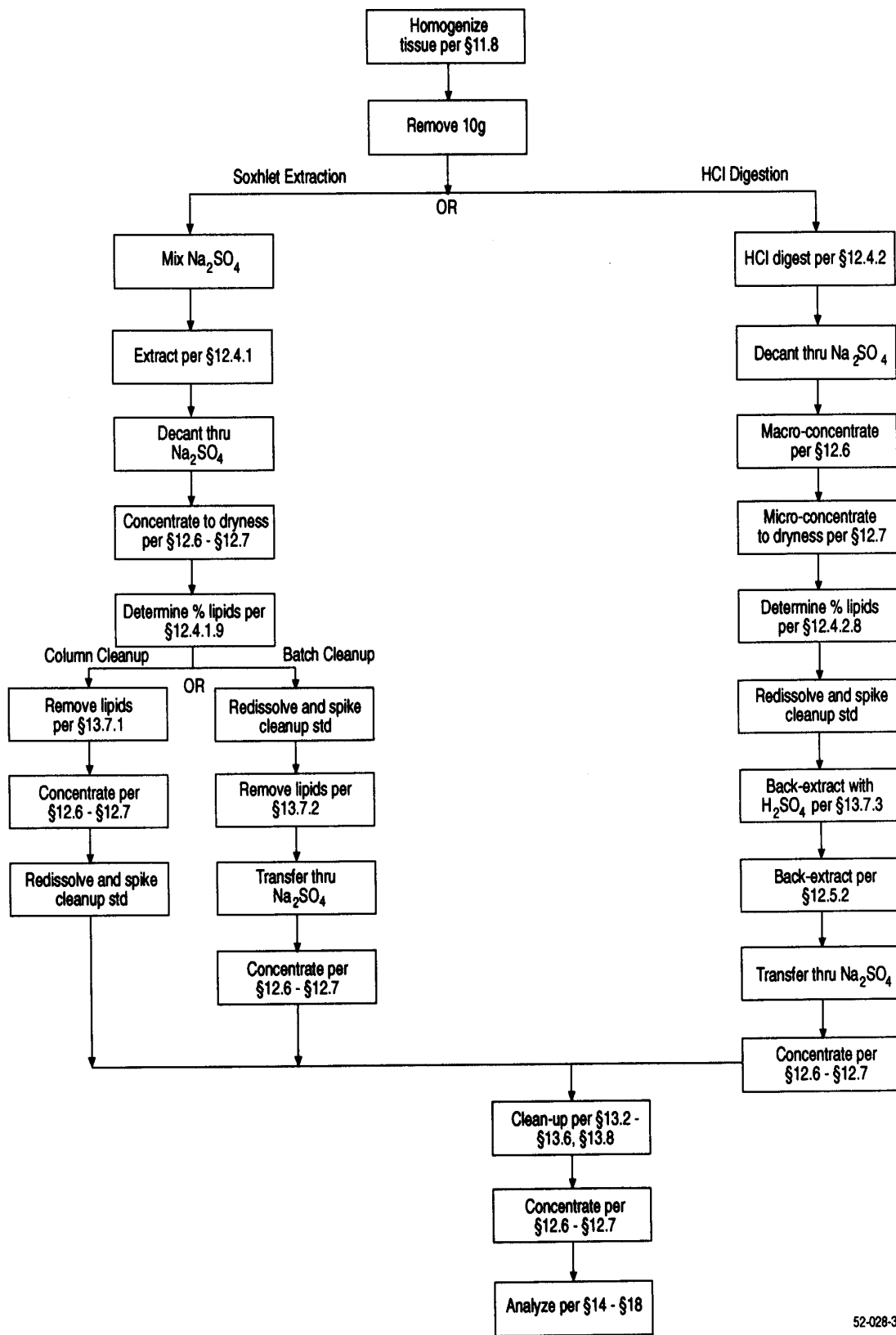

Figure 2. Flow Chart for Analysis of Multi-Phase Samples

52-028-2A



52-028-3A

Figure 3. Flow Chart for Analysis of Tissue Samples

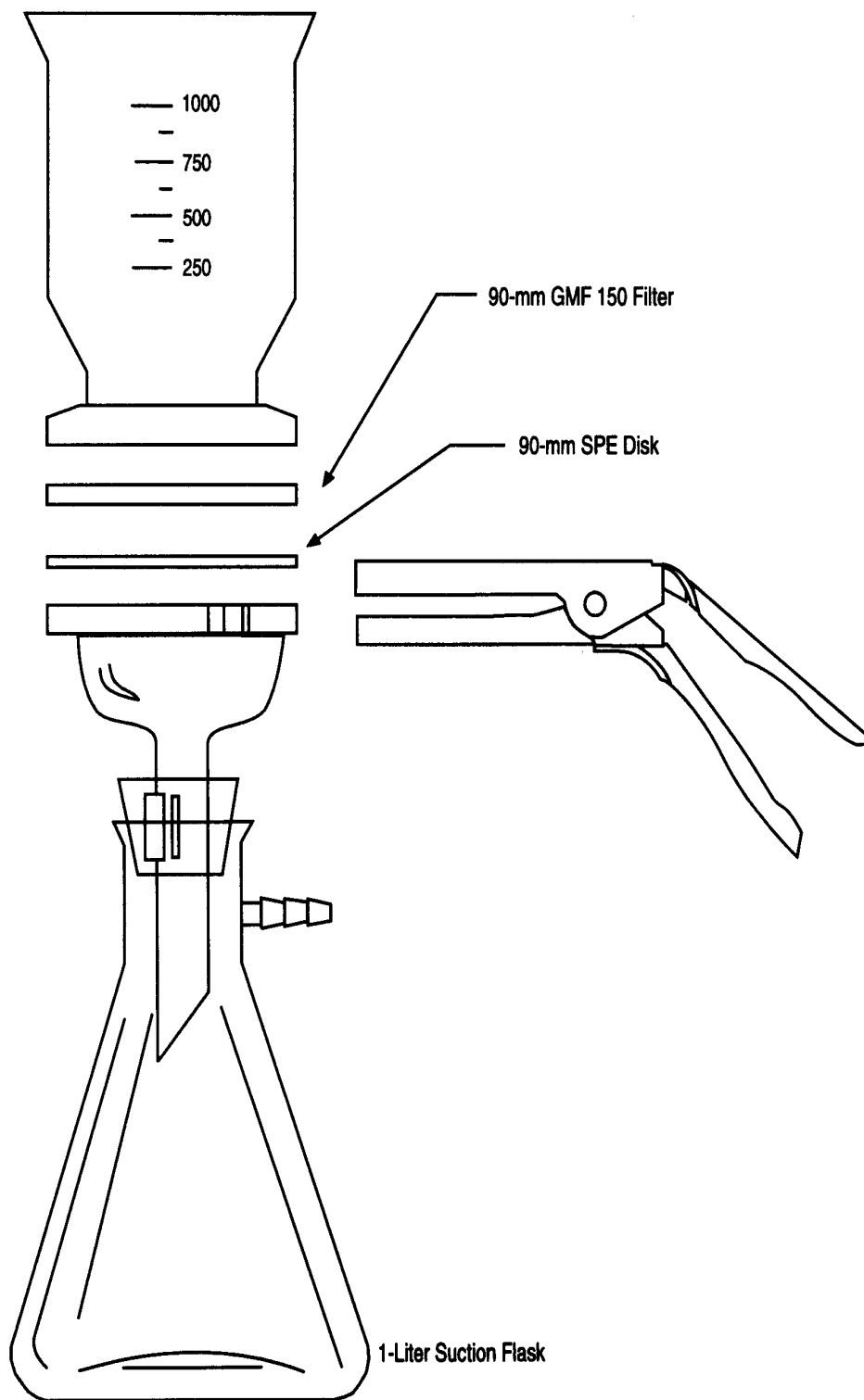
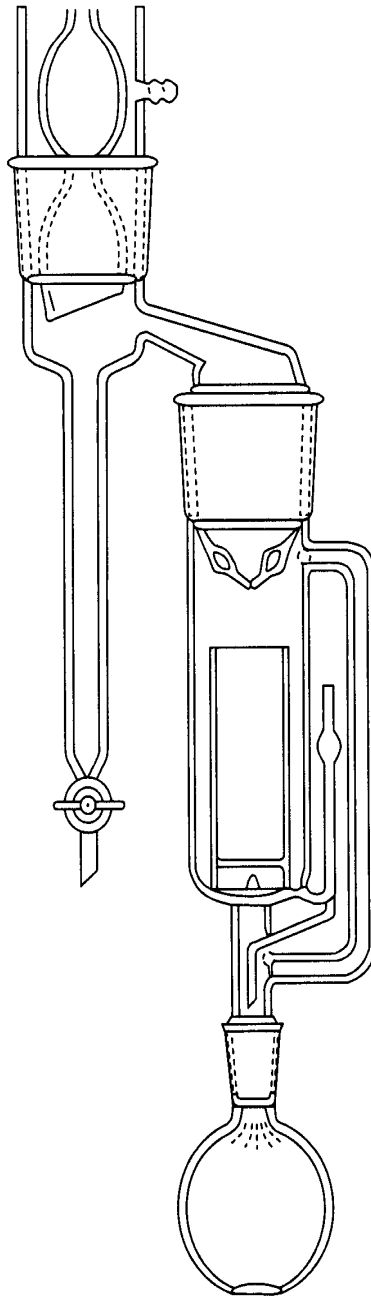

Figure 4. Solid-Phase Extraction Apparatus

52-027-1A



52-027-2A

Figure 5. Soxhlet/Dean-Stark Extractor

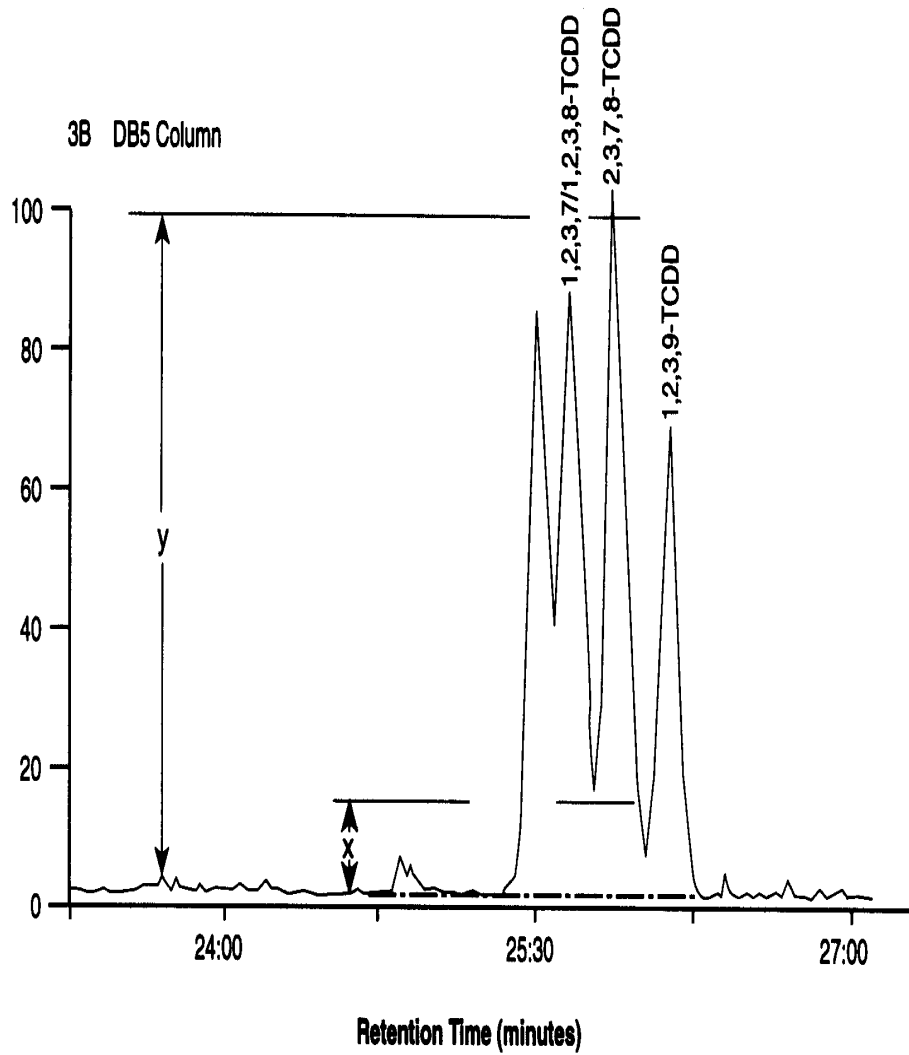

Figure 6. Isomer-Specific Separation of 2,3,7,8-TCDD on DB-5 Column

52-027-03

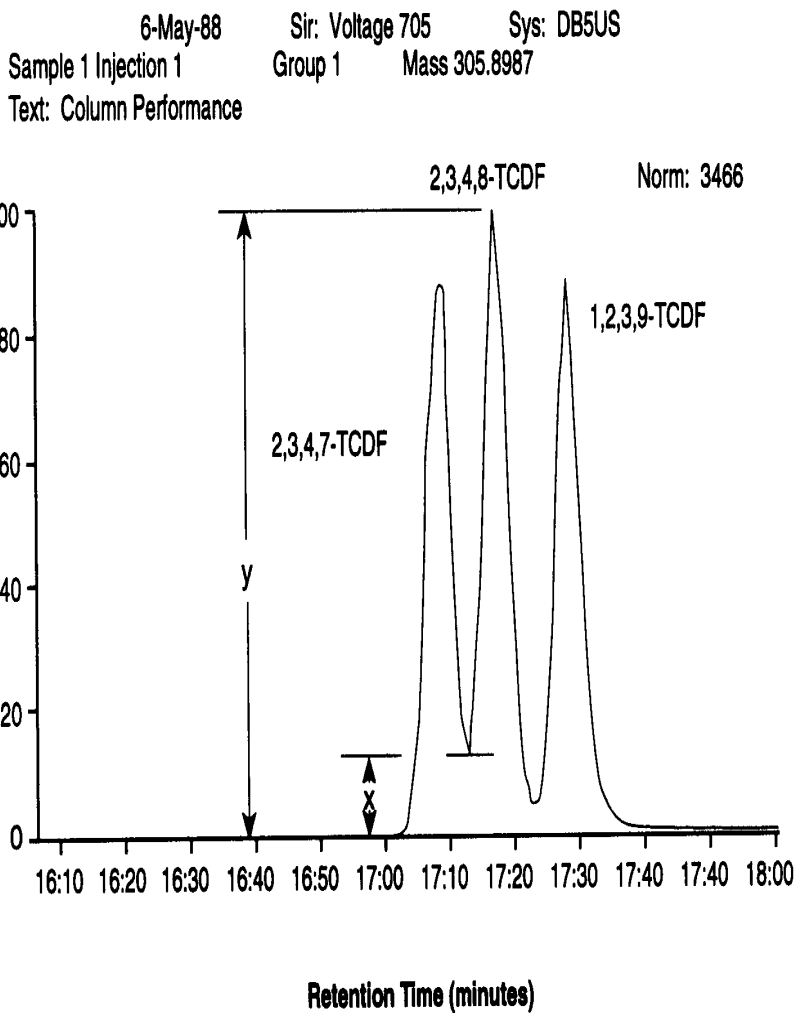

Figure 7. Isomer-Specific Separation of 2,3,7,8-TCDF on DB-5 Column

52-027-4A

24.0 Glossary of Definitions and Purposes

These definitions and purposes are specific to this method but have been conformed to common usage as much as possible.

24.1 Units of weight and Measure and Their Abbreviations

24.1.1 Symbols

°C	degrees Celsius
μL	microliter
μm	micrometer
<	less than
>	greater than
%	percent

24.1.2 Alphabetical abbreviations

amp	ampere
cm	centimeter
g	gram
h	hour
ID	inside diameter
in.	inch
L	liter
M	Molecular ion
m	meter
mg	milligram
min	minute
mL	milliliter
mm	millimeter
m/z	mass-to-charge ratio
N	normal; gram molecular weight of solute divided by hydrogen equivalent of solute, per liter of solution
OD	outside diameter
pg	picogram
ppb	part-per-billion
ppm	part-per-million
ppq	part-per-quadrillion
ppt	part-per-trillion
psig	pounds-per-square inch gauge
v/v	volume per unit volume
w/v	weight per unit volume

24.2 Definitions and Acronyms (in Alphabetical Order)

Analyte—A CDD or CDF tested for by this method. The analytes are listed in Table 1.

Calibration Standard (CAL)—A solution prepared from a secondary standard and/or stock solutions and used to calibrate the response of the instrument with respect to analyte concentration.

Calibration Verification Standard (VER)—The mid-point calibration standard (CS3) that is used in to verify calibration. See Table 4.

CDD—Chlorinated Dibenzo-*p*-ioxin—The isomers and congeners of tetra- through octa-chlorodibenzo-*p*-dioxin.

CDF—Chlorinated Dibenzofuran—The isomers and congeners of tetra- through octa-chlorodibenzofuran.

CS1, CS2, CS3, CS4, CS5—See Calibration standards and Table 4.

Field Blank—An aliquot of reagent water or other reference matrix that is placed in a sample container in the laboratory or the field, and treated as a sample in all respects, including exposure to sampling site conditions, storage, preservation, and all analytical procedures. The purpose of the field blank is to determine if the field or sample transporting procedures and environments have contaminated the sample.

GC—Gas chromatograph or gas chromatography.

GPC—Gel permeation chromatograph or gel permeation chromatography.

HPLC—High performance liquid chromatograph or high performance liquid chromatography.

HRGC—High resolution GC.

HRMS—High resolution MS.

IPR—Initial precision and recovery; four aliquots of the diluted PAR standard analyzed to establish the ability to generate acceptable precision and accuracy. An IPR is performed prior to the first time this method is used and any time the method or instrumentation is modified.

K-D—Kuderna-Danish concentrator; a device used to concentrate the analytes in a solvent.

Laboratory Blank—See method blank.

Laboratory Control sample (LCS)—See ongoing precision and recovery standard (OPR).

Laboratory Reagent Blank—See method blank.

May—This action, activity, or procedural step is neither required nor prohibited.

May Not—This action, activity, or procedural step is prohibited.

Method Blank—An aliquot of reagent water that is treated exactly as a sample including exposure to all glassware, equipment, solvents, reagents, internal standards, and surrogates that are used with samples. The method blank is used to determine if analytes or interferences are present in the laboratory environment, the reagents, or the apparatus.

Minimum Level (ML)—The level at which the entire analytical system must give a recognizable signal and acceptable calibration point for the analyte. It is equivalent to the concentration of the lowest calibration standard, assuming that all method-specified sample weights, volumes, and cleanup procedures have been employed.

MS—Mass spectrometer or mass spectrometry.

Must—This action, activity, or procedural step is required.

OPR—Ongoing precision and recovery standard (OPR); a laboratory blank spiked with known quantities of analytes. The OPR is analyzed exactly like a sample. Its purpose is to assure that the results produced by the laboratory remain within the limits specified in this method for precision and recovery.

PAR—Precision and recovery standard; secondary standard that is diluted and spiked to form the IPR and OPR.

PFK—Perfluorokerosene; the mixture of compounds used to calibrate the exact m/z scale in the HRMS.

Preparation Blank—See method blank.

Primary Dilution Standard—A solution containing the specified analytes that is purchased or prepared from stock solutions and diluted as needed to prepare calibration solutions and other solutions.

Quality Control Check Sample (QCS)—A sample containing all or a subset of the analytes at known concentrations. The QCS is obtained from a source external to the laboratory or is prepared from a source of standards different from the source of calibration standards. It is used to check laboratory performance with test materials prepared external to the normal preparation process.

Reagent Water—Water demonstrated to be free from the analytes of interest and potentially interfering substances at the method detection limit for the analyte.

Relative Standard Deviation (RSD)—The standard deviation times 100 divided by the mean. Also termed "coefficient of variation."

RF—Response factor. See Section 10.6.1.

RR—Relative response. See Section 10.5.2.

RSD—See relative standard deviation.

SDS—Soxhlet/Dean-Stark extractor; an extraction device applied to the extraction of solid and semi-solid materials (Reference 7).

Should—This action, activity, or procedural step is suggested but not required.

SICP—Selected ion current profile; the line described by the signal at an exact m/z.

SPE—Solid-phase extraction; an extraction technique in which an analyte is extracted from an aqueous sample by passage over or through a material capable of reversibly adsorbing the analyte. Also termed liquid-solid extraction.

Stock Solution—A solution containing an analyte that is prepared using a reference material traceable to EPA, the National Institute of Science and Technology (NIST), or a source that will attest to the purity and authenticity of the reference material.

TCDD—Tetrachlorodibenzo-*p*-dioxin.

TCDF—Tetrachlorodibenzofuran.

VER—See calibration verification standard.

Annex XIX:

Method 1668

**Toxic Polychlorinated Biphenyls by Isotope Dilution High Resolution Gas
Chromatography/High Resolution Mass Spectrometry**

United States
Environmental Protection
Agency

Office of Water
(4303)

EPA-821-R-97-001
March 1997
DRAFT



Method 1668

Toxic Polychlorinated Biphenyls by Isotope Dilution High Resolution Gas Chromatography/High Resolution Mass Spectrometry

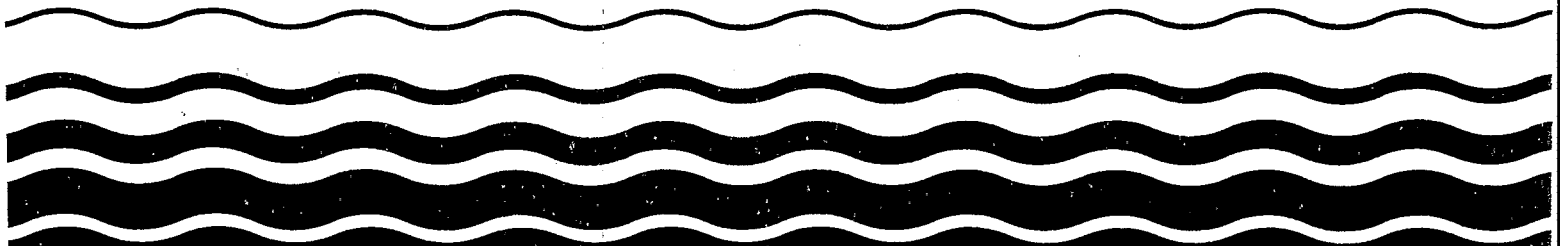



Method 1668

Toxic Polychlorinated Biphenyls by Isotope Dilution High Resolution Gas Chromatography/High Resolution Mass Spectrometry

Method 1668

Acknowledgments

Method 1668 was prepared under the direction of William A. Telliard of the Engineering and Analysis Division within the EPA Office of Water (OW). This document was prepared under EPA Contract No. 68-C3-0337 by DynCorp Environmental, Energy & National Security Programs with assistance from its subcontractor Interface, Inc.

Disclaimer

This method has been reviewed by the Engineering and Analysis Division, U.S. Environmental Protection Agency, and approved for publication. Mention of trade names or commercial products does not constitute endorsement or recommendation for use.

Note: *This method is a draft based on preliminary validation in a single laboratory. In surveys of several laboratories using this method, EPA has found that it is normal for background levels of certain congeners that are found in high concentrations in PCBs to be present in the analytical systems in this method. Therefore, the concentrations of certain congeners in calibration and other solutions have been adjusted for these backgrounds. EPA welcomes constructive suggestions for improvement of this method.*

Introduction

Method 1668 was developed by the United States Environmental Protection Agency's Office of Science and Technology for congener-specific determination of the toxic co-planar and mono-ortho-substituted polychlorinated biphenyls (PCBs) in aqueous, solid, and tissue matrices by isotope dilution, high resolution capillary column gas chromatography (HRGC)/high resolution mass spectrometry (HRMS).

Questions and comments concerning this method or its application should be addressed to:

William A. Telliard, Director
Analytical Methods Staff (4303)
U.S. Environmental Protection Agency
401 M Street, SW
Washington, DC 20460
Phone: 202-260-7120
Fax: 202-260-7134

Method 1668

Method 1668

Toxic Polychlorinated Biphenyls by Isotope Dilution High Resolution Gas Chromatography/High Resolution Mass Spectrometry

1.0 Scope and Application

- 1.1 This method is for determination of the toxic polychlorinated biphenyls (PCBs) in water, soil, sediment, sludge, tissue, and other sample matrices by high resolution gas chromatography/high resolution mass spectrometry (HRGC/HRMS). The method is for use in EPA's data gathering and monitoring programs associated with the Clean Water Act, the Resource Conservation and Recovery Act, the Comprehensive Environmental Response, Compensation and Liability Act, and the Safe Drinking Water Act. The method is based on a compilation of methods from the technical literature (References 1-3) and on EPA Method 1613.
- 1.2 The toxic PCBs listed in Table 1 (Reference 4) and other specific congeners may be determined by this method.
- 1.3 The detection limits and quantitation levels in this method are usually dependent on the level of interferences rather than instrumental limitations. The minimum levels (MLs) in Table 2 are the levels at which the PCBs can be determined with only common laboratory interferences present. The Method Detection Limit (MDL) for PCB #126 has been determined as 40 pg/L (picograms/Liter; parts-per-quadrillion) in water using this method.
- 1.4 The GC/MS portions of this method are for use only by analysts experienced with HRGC/HRMS or under the close supervision of such qualified persons. Each laboratory that uses this method must demonstrate the ability to generate acceptable results using the procedure in Section 9.2.
- 1.5 This method is performance-based. The analyst is permitted to modify the method to overcome interferences or lower the cost of measurements, provided that all performance criteria in this method are met. The requirements for establishing method equivalency are given in Section 9.1.2.
- 1.6 Any modification of this method, beyond those expressly permitted, shall be considered a major modification subject to application and approval of alternate test procedures under 40 CFR Parts 136.4 and 136.5.

2.0 Summary of Method

Flow charts that summarize procedures for sample preparation, extraction, and analysis are given in Figure 1 for aqueous and solid samples, Figure 2 for multi-phase samples, and Figure 3 for tissue samples.

*Method 1668***2.1 Extraction.**

- 2.1.1** Aqueous samples (samples containing less than 1% solids)—Stable isotopically labeled analogs of the toxic PCBs are spiked into a 1-L sample, and the sample is vacuum-filtered through a glass-fiber filter on top of a solid-phase extraction (SPE) disk. Sample components on the filter and disk are eluted with methylene chloride and the eluant is concentrated for cleanup.
- 2.1.2** Solid, semi-solid, and multi-phase samples (but not tissue)—The labeled compounds are spiked into a sample containing 10 g (dry weight) of solids. Samples containing multiple phases are pressure filtered and any aqueous liquid is discarded. Coarse solids are ground or homogenized. Any non-aqueous liquid from multi-phase samples is combined with the solids and extracted in an SDS extractor. The extract is concentrated for cleanup.
- 2.1.3** Fish and other tissue—A 20-g aliquot of sample is homogenized, and a 10-g aliquot is spiked with the labeled compounds. The sample is mixed with sodium sulfate, allowed to dry for 12-24 hours, and extracted for 18-24 hours using methylene chloride:n-hexane (1:1) in a Soxhlet extractor. The extract is evaporated to dryness, and the lipid content is determined.

2.2 After extraction, samples are cleaned up using back-extraction with sulfuric acid and/or base, and gel permeation, silica gel, Florisil and activated carbon chromatography. High-performance liquid chromatography (HPLC) can be used for further isolation of specific isomers or congeners. Prior to the cleanup procedures cited above, tissue extracts are cleaned up using an anthropogenic isolation column.

2.3 After cleanup, the extract is concentrated to near dryness. Immediately prior to injection, internal standards are added to each extract, and an aliquot of the extract is injected into the gas chromatograph. The analytes are separated by the GC and detected by a high-resolution ($\geq 10,000$) mass spectrometer. Two exact m/z 's are monitored for each analyte.

2.4 An individual PCB congener is identified by comparing the GC retention time and ion-abundance ratio of two exact m/z 's with the corresponding retention time of an authentic standard and the theoretical or acquired ion-abundance ratio of the two exact m/z 's. Isomer specificity for the toxic PCBs is achieved using GC columns that resolve these congeners from the other PCBs.

2.5 Quantitative analysis is performed using selected ion current profile (SICP) areas in one of two ways:

2.5.1 For PCBs with labeled analogs (see Table 1), the GC/MS system is calibrated, and the concentration of each compound is determined using the isotope dilution technique.

2.5.2 For PCBs without labeled compounds, the GC/MS system is calibrated, and the concentration of each compound is determined using the internal standard technique.

2.6 The quality of the analysis is assured through reproducible calibration and testing of the extraction, cleanup, and GC/MS systems.

3.0 Definitions

Definitions are given in the glossary at the end of this method.

4.0 Contamination and Interferences

- 4.1 Solvents, reagents, glassware, and other sample processing hardware may yield artifacts and/or elevated baselines causing misinterpretation of chromatograms. Specific selection of reagents and purification of solvents by distillation in all-glass systems may be required. Where possible, reagents are cleaned by extraction or solvent rinse. The non-coplanar PCB congeners 105, 114, 118, 123, 156, 157, 167, and 180 have been shown to be very difficult to completely eliminate from the laboratory at the MDLs in this method, and baking of glassware in a kiln or furnace at 450-500 °C may be necessary to remove these and other contaminants.
- 4.2 Proper cleaning of glassware is extremely important because glassware may not only contaminate the samples but may also remove the analytes of interest by adsorption on the glass surface.
- 4.2.1 Glassware should be rinsed with solvent and washed with a detergent solution as soon after use as is practical. Sonication of glassware containing a detergent solution for approximately 30 seconds may aid in cleaning. Glassware with removable parts, particularly separatory funnels with fluoropolymer stopcocks, must be disassembled prior to detergent washing.
- 4.2.2 After detergent washing, glassware should be rinsed immediately; first with methanol, then with hot tap water. The tap water rinse is followed by another methanol rinse, then acetone, and then methylene chloride.
- 4.2.3 Baking of glassware in kiln or other high temperature furnace (450-500 °C) may be warranted after particularly dirty samples are encountered. However, baking should be minimized, as repeated baking of glassware may cause active sites on the glass surface that may irreversibly adsorb PCBs.
- 4.2.4 Immediately prior to use, the Soxhlet apparatus should be pre-extracted with toluene for approximately 3 hours (see Sections 12.3.1-12.3.3). The solid-phase extraction apparatus (Section 6.4.1.5) should be rinsed with methylene chloride/toluene (80/20 mixture).
- 4.3 All materials used in the analysis shall be demonstrated to be free from interferences by running reference matrix method blanks (Section 9.5) initially and with each sample batch (samples started through the extraction process on a given 12-hour shift to a maximum of 20 samples).
- 4.3.1 The reference matrix must simulate as closely as possible the sample matrix under test. Ideally, the reference matrix should not contain the PCBs in detectable amounts, but should contain potential interferences in the concentrations expected to be found in the samples to be analyzed.
- 4.3.2 When a reference matrix that simulates the sample matrix under test is not available, reagent water (Section 7.6.1) can be used to simulate water samples; playground sand (Section 7.6.2) or white quartz sand (Section 7.3.2) can be used to simulate soils; filter paper (Section 7.6.3) can be used to simulate papers and similar materials; and corn oil (Section 7.6.4) can be used to simulate tissues.
- 4.4 Interferences coextracted from samples will vary considerably from source to source, depending on the diversity of the site being sampled. Interfering compounds may be present at concentrations several orders of magnitude higher than the PCBs. The most frequently encountered interferences are chlorinated dioxins and dibenzofurans, methoxy biphenyls, hydroxy-diphenyl ethers, benzylphenyl ethers, polynuclear aromatics, and pesticides. Because very low

Method 1668

levels of PCBs are measured by this method, the elimination of interferences is essential. The cleanup steps given in Section 13 can be used to reduce or eliminate these interferences and thereby permit reliable determination of the PCBs at the levels shown in Table 2.

- 4.5 Each piece of reusable glassware should be numbered to associate that glassware with the processing of a particular sample. This will assist the laboratory in tracking possible sources of contamination for individual samples, identifying glassware associated with highly contaminated samples that may require extra cleaning, and determining when glassware should be discarded.
- 4.6 Cleanup of tissue—The natural lipid content of tissue can interfere in the analysis of tissue samples for the PCBs. The lipid contents of different species and portions of tissue can vary widely. Lipids are soluble to varying degrees in various organic solvents and may be present in sufficient quantity to overwhelm the column chromatographic cleanup procedures used for cleanup of sample extracts. Lipids must be removed by the lipid removal procedures in Section 13.6, followed by Florisil (Section 13.7), and carbon (Section 13.4) as minimum additional cleanup steps.

5.0 Safety

- 5.1 The toxicity or carcinogenicity of each chemical used in this method has not been precisely determined; however, each compound should be treated as a potential health hazard. Exposure to these compounds should be reduced to the lowest possible level.
- 5.1.1 The PCBs have been tentatively classified as known or suspected human or mammalian carcinogens. On the basis of the available toxicological and physical properties of the PCBs, pure standards should be handled only by highly trained personnel thoroughly familiar with handling and cautionary procedures and the associated risks.
- 5.1.2 It is recommended that the laboratory purchase dilute standard solutions of the analytes in this method. However, if primary solutions are prepared, they shall be prepared in a hood, and a NIOSH/MESA approved toxic gas respirator shall be worn when high concentrations are handled.
- 5.2 The laboratory is responsible for maintaining a current awareness file of OSHA regulations regarding the safe handling of the chemicals specified in this method. A reference file of material safety data sheets (MSDSs) should also be made available to all personnel involved in these analyses. It is also suggested that the laboratory perform personal hygiene monitoring of each analyst who uses this method and that the results of this monitoring be made available to the analyst. Additional information on laboratory safety can be found in References 5-8. The references and bibliography at the end of Reference 8 are particularly comprehensive in dealing with the general subject of laboratory safety.
- 5.3 The pure PCBs and samples suspected to contain these compounds are handled using essentially the same techniques employed in handling radioactive or infectious materials. Well-ventilated, controlled access laboratories are required. Assistance in evaluating the health hazards of particular laboratory conditions may be obtained from certain consulting laboratories and from State Departments of Health or Labor, many of which have an industrial health service. Each laboratory must develop a strict safety program for handling these compounds. The practices in Reference 11 for handling chlorinated dibenzo-*p*-dioxins and dibenzofurans (CDDs/CDFs) are also recommended for handling the toxic PCBs.

- 5.3.1 Facility**—When finely divided samples (dusts, soils, dry chemicals) are handled, all operations (including removal of samples from sample containers, weighing, transferring, and mixing) should be performed in a glove box demonstrated to be leak tight or in a fume hood demonstrated to have adequate air flow. Gross losses to the laboratory ventilation system must not be allowed. Handling of the dilute solutions normally used in analytical and animal work presents no inhalation hazards except in the case of an accident.
- 5.3.2 Protective equipment**—Disposable plastic gloves, apron or lab coat, safety glasses or mask, and a glove box or fume hood adequate for radioactive work should be used. During analytical operations that may give rise to aerosols or dusts, personnel should wear respirators equipped with activated carbon filters. Eye protection equipment (preferably full face shields) must be worn while working with exposed samples or pure analytical standards. Latex gloves are commonly used to reduce exposure of the hands. When handling samples suspected or known to contain high concentrations of the PCBs, an additional set of gloves can also be worn beneath the latex gloves.
- 5.3.3 Training**—Workers must be trained in the proper method of removing contaminated gloves and clothing without contacting the exterior surfaces.
- 5.3.4 Personal hygiene**—Hands and forearms should be washed thoroughly after each manipulation and before breaks (coffee, lunch, and shift).
- 5.3.5 Confinement**—Isolated work areas posted with signs, segregated glassware and tools, and plastic absorbent paper on bench tops will aid in confining contamination.
- 5.3.6 Effluent vapors**—The effluents of sample splitters from the gas chromatograph (GC) and from roughing pumps on the mass spectrometer (MS) should pass through either a column of activated charcoal or be bubbled through a trap containing oil or high-boiling alcohols to condense PCB vapors.
- 5.3.7 Waste Handling**—Good technique includes minimizing contaminated waste. Plastic bag liners should be used in waste cans. Janitors and other personnel must be trained in the safe handling of waste.
- 5.3.8 Decontamination.**
- 5.3.8.1 Decontamination of personnel**—Use any mild soap with plenty of scrubbing action.
- 5.3.8.2 Glassware, tools, and surfaces**—Chloroethene NU Solvent is a less toxic solvent that should be effective in removing PCBs. Satisfactory cleaning may be accomplished by rinsing with Chloroethene, then washing with any detergent and water. If glassware is first rinsed with solvent, then the dish water may be disposed of in the sewer. Given the cost of disposal, it is prudent to minimize solvent wastes.
- 5.3.9 Laundry**—Clothing known to be contaminated should be collected in plastic bags. Persons who convey the bags and launder the clothing should be advised of the hazard and trained in proper handling. The clothing may be put into a washer without contact if the launderer knows of the potential problem. The washer should be run through a cycle before being used again for other clothing.
- 5.3.10 Wipe tests**—A useful method of determining cleanliness of work surfaces and tools is to wipe the surface with a piece of filter paper. Extraction and analysis by GC with an electron capture detector (ECD) can achieve a limit of detection of 0.1 g per wipe; analysis

Method 1668

using this method can achieve an even lower detection limit. Less than 0.1 µg per wipe indicates acceptable cleanliness; anything higher warrants further cleaning. More than 10 µg on a wipe constitutes an acute hazard and requires prompt cleaning before further use of the equipment or work space, and indicates that unacceptable work practices have been employed.

6.0 Apparatus, Equipment and Supplies

Note: *Brand names, suppliers, and part numbers are for illustration purposes only and no endorsement is implied. Equivalent performance may be achieved using apparatus and materials other than those specified here. Meeting the performance requirements of this method is the responsibility of the laboratory.*

6.1 Sampling equipment for discrete or composite sampling.

6.1.1 Sample bottles and caps.

- 6.1.1.1 Liquid samples (waters, sludges and similar materials containing 5% solids or less)—Sample bottle, amber glass, 1.1-L minimum, with screw cap.
- 6.1.1.2 Solid samples (soils, sediments, sludges, paper pulps, filter cake, compost, and similar materials that contain more than 5% solids)—Sample bottle, wide mouth, amber glass, 500-mL minimum.
- 6.1.1.3 If amber bottles are not available, samples shall be protected from light.
- 6.1.1.4 Bottle caps—Threaded to fit sample bottles. Caps shall be lined with fluoropolymer.
- 6.1.1.5 Cleaning.

6.1.1.5.1 Bottles are detergent water washed, then solvent rinsed before use.

6.1.1.5.2 Liners are detergent water washed and rinsed with reagent water (Section 7.6.1).

- 6.1.2 Compositing equipment—Automatic or manual compositing system incorporating glass containers cleaned per bottle cleaning procedure above. Only glass or fluoropolymer tubing shall be used. If the sampler uses a peristaltic pump, a minimum length of compressible silicone rubber tubing may be used in the pump only. Before use, the tubing shall be thoroughly rinsed with methanol, followed by repeated rinsing with reagent water to minimize sample contamination. An integrating flow meter is used to collect proportional composite samples.

6.2 Equipment for glassware cleaning—Laboratory sink with overhead fume hood.

6.3 Equipment for sample preparation.

- 6.3.1 Laboratory fume hood of sufficient size to contain the sample preparation equipment listed below.
- 6.3.2 Glove box (optional).
- 6.3.3 Tissue homogenizer—VirTis Model 45 Macro homogenizer (American Scientific Products H-3515, or equivalent) with stainless steel Macro-shaft and Turbo-shear blade.
- 6.3.4 Meat grinder—Hobart, or equivalent, with 3- to 5-mm holes in inner plate.

- 6.3.5 Equipment for determining percent moisture.
 - 6.3.5.1 Oven—Capable of maintaining a temperature of $110 \pm 5^\circ\text{C}$.
 - 6.3.5.2 Desiccator.
- 6.3.6 Balances.
 - 6.3.6.1 Analytical—Capable of weighing 0.1 mg.
 - 6.3.6.2 Top loading—Capable of weighing 10 mg.
- 6.4 Extraction apparatus.
 - 6.4.1 Water samples.
 - 6.4.1.1 pH meter, with combination glass electrode.
 - 6.4.1.2 pH paper, wide range (Hydrion Papers, or equivalent).
 - 6.4.1.3 Graduated cylinder, 1-L capacity.
 - 6.4.1.4 Liquid/liquid extraction—Separatory funnels, 250-, 500-, and 2000-mL, with fluoropolymer stopcocks.
 - 6.4.1.5 Solid-phase extraction.
 - 6.4.1.5.1 1-L filtration apparatus, including glass funnel, frit support, clamp, adapter, stopper, filtration flask, and vacuum tubing (Figure 4). For wastewater samples, the apparatus should accept 90 or 144 mm disks. For drinking water or other samples containing low solids, smaller disks may be used.
 - 6.4.1.5.2 Vacuum source capable of maintaining 25 in. Hg, equipped with shutoff valve and vacuum gauge.
 - 6.4.1.5.3 Glass-fiber filter—Whatman GMF 150 (or equivalent), 1 micron pore size, to fit filtration apparatus in Section 6.4.1.5.1.
 - 6.4.1.5.4 Solid-phase extraction disk containing octadecyl (C_{18}) bonded silica uniformly enmeshed in an inert matrix—Fisher Scientific 14-378F (or equivalent), to fit filtration apparatus in Section 6.4.1.5.1.
 - 6.4.2 Soxhlet/Dean-Stark (SDS) extractor (Figure 5 and Reference 12) for filters and solid/sludge samples.
 - 6.4.2.1 Soxhlet—50-mm ID, 200-mL capacity with 500-mL flask (Cal-Glass LG-6900, or equivalent, except substitute 500-mL round-bottom flask for 300-mL flat-bottom flask).
 - 6.4.2.2 Thimble— 43×123 to fit Soxhlet (Cal-Glass LG-6901-122, or equivalent).
 - 6.4.2.3 Moisture trap—Dean Stark or Barret with fluoropolymer stopcock, to fit Soxhlet.
 - 6.4.2.4 Heating mantle—Hemispherical, to fit 500-mL round-bottom flask (Cal-Glass LG-8801-112, or equivalent).
 - 6.4.2.5 Variable transformer—Powerstat (or equivalent), 110-volt, 10-amp.
 - 6.4.3 Beakers—400- to 500-mL.
 - 6.4.4 Spatulas—Stainless steel.
- 6.5 Filtration apparatus.

Method 1668

- 6.5.1 Pyrex glass wool—Solvent-extracted by SDS for 3 hours minimum.
- 6.5.2 Glass funnel—125- to 250-mL.
- 6.5.3 Glass-fiber filter paper—Whatman GF/D (or equivalent), to fit glass funnel in Section 6.5.2.
- 6.5.4 Drying column—15- to 20-mm ID Pyrex chromatographic column equipped with coarse-glass frit or glass-wool plug.
- 6.5.5 Buchner funnel—15-cm.
- 6.5.6 Glass-fiber filter paper for Buchner funnel above.
- 6.5.7 Filtration flasks—1.5- to 2.0-L, with side arm.
- 6.5.8 Pressure filtration apparatus—Millipore YT30 142 HW, or equivalent.
- 6.6 Centrifuge apparatus.
 - 6.6.1 Centrifuge—Capable of rotating 500-mL centrifuge bottles or 15-mL centrifuge tubes at 5,000 rpm minimum.
 - 6.6.2 Centrifuge bottles—500-mL, with screw-caps, to fit centrifuge.
 - 6.6.3 Centrifuge tubes—12- to 15-mL, with screw-caps, to fit centrifuge.
- 6.7 Cleanup apparatus.
 - 6.7.1 Automated gel permeation chromatograph (Analytical Biochemical Labs, Inc, Columbia, MO, Model GPC Autoprep 1002, or equivalent).
 - 6.7.1.1 Column—600-700 mm long × 25 mm ID, packed with 70 g of SX-3 Bio-beads (Bio-Rad Laboratories, Richmond, CA, or equivalent).
 - 6.7.1.2 Syringe—10-mL, with Luer fitting.
 - 6.7.1.3 Syringe filter holder—stainless steel, and glass- fiber or fluoropolymer filters (Gelman 4310, or equivalent).
 - 6.7.1.4 UV detectors—254-nm, preparative or semi-preparative flow cell (Isco, Inc., Type 6; Schmadzu, 5-mm path length; Beckman-Altex 152W, 8- μ L micro-prep flow cell, 2-mm path; Pharmacia UV-1, 3-mm flow cell; LDC Milton-Roy UV-3, monitor #1203; or equivalent).
 - 6.7.2 Reverse-phase high-performance liquid chromatograph.
 - 6.7.2.1 Column oven and detector—Perkin-Elmer Model LC-65T (or equivalent) operated at 0.02 AUFS at 235 nm.
 - 6.7.2.2 Injector—Rheodyne 7120 (or equivalent) with 50- μ L sample loop.
 - 6.7.2.3 Column—Two 6.2 mm × 250 mm Zorbax-ODS columns in series (DuPont Instruments Division, Wilmington, DE, or equivalent), operated at 30°C and 2.0 mL/min with gradient from TBD percent methanol:acetonitrile to 100 percent acetonitrile in TBD minutes.
 - 6.7.2.4 Pump—Altex 110A (or equivalent).
 - 6.7.3 Pipets.
 - 6.7.3.1 Disposable, Pasteur, 150-mm long × 5-mm ID (Fisher Scientific 13-678-6A, or equivalent).

- 6.7.3.2 Disposable, serological, 50-mL (8- to 10- mm ID).
- 6.7.4 Glass chromatographic columns.
- 6.7.4.1 150-mm long × 8-mm ID, (Kontes K-420155, or equivalent) with coarse-glass frit or glass-wool plug and 250-mL reservoir.
- 6.7.4.2 200-mm long × 15-mm ID, with coarse-glass frit or glass-wool plug and 250-mL reservoir.
- 6.7.4.3 300-mm long × 22-mm ID, with coarse-glass frit, 300-mL reservoir, and glass or fluoropolymer stopcock.
- 6.7.5 Stirring apparatus for batch silica cleanup of tissue extracts.
- 6.7.5.1 Mechanical stirrer—Corning Model 320, or equivalent.
- 6.7.5.2 Bottle—500- to 600-mL wide-mouth clear glass.
- 6.7.6 Oven—For baking and storage of adsorbents, capable of maintaining a constant temperature ($\pm 5^{\circ}\text{C}$) in the range of 105-250°C.
- 6.8 Concentration apparatus.
- 6.8.1 Rotary evaporator—Buchi/Brinkman-American Scientific No. E5045-10 or equivalent, equipped with a variable temperature water bath.
- 6.8.1.1 Vacuum source for rotary evaporator equipped with shutoff valve at the evaporator and vacuum gauge.
- 6.8.1.2 A recirculating water pump and chiller are recommended, as use of tap water for cooling the evaporator wastes large volumes of water and can lead to inconsistent performance as water temperatures and pressures vary.
- 6.8.1.3 Round-bottom flask—100-mL and 500-mL or larger, with ground-glass fitting compatible with the rotary evaporator.
- 6.8.2 Kuderna-Danish (K-D) concentrator.
- 6.8.2.1 Concentrator tube—10-mL, graduated (Kontes K-570050-1025, or equivalent) with calibration verified. Ground-glass stopper (size 19/22 joint) is used to prevent evaporation of extracts.
- 6.8.2.2 Evaporation flask—500-mL (Kontes K-570001-0500, or equivalent), attached to concentrator tube with springs (Kontes K-662750-0012 or equivalent).
- 6.8.2.3 Snyder column—Three-ball macro (Kontes K-503000-0232, or equivalent).
- 6.8.2.4 Boiling chips.
- 6.8.2.4.1 Glass or silicon carbide—Approximately 10/40 mesh, extracted with methylene chloride and baked at 450°C for 1 hour minimum.
- 6.8.2.4.2 Fluoropolymer (optional)—Extracted with methylene chloride.
- 6.8.2.5 Water bath—Heated, with concentric ring cover, capable of maintaining a temperature within $\pm 2^{\circ}\text{C}$, installed in a fume hood.
- 6.8.3 Nitrogen blowdown apparatus—Equipped with water bath controlled in the range of 30 - 60°C (N-Evap, Organomation Associates, Inc., South Berlin, MA, or equivalent), installed in a fume hood.

Method 1668

- 6.8.4 Sample vials.
- 6.8.4.1 Amber glass, 2- to 5-mL with fluoropolymer-lined screw-cap.
 - 6.8.4.2 Glass, 0.3-mL, conical, with fluoropolymer-lined screw or crimp cap.
- 6.9 Gas chromatograph—Shall have splitless or on-column injection port for capillary column, temperature program with isothermal hold, and shall meet all of the performance specifications in Section 10.
- 6.9.1 GC columns—The pair of GC columns listed below are capable of resolving all 209 PCB congeners. Other GC columns may be used so long as PCBs 126 and 169 are each resolved from their respective most closely eluted leading and trailing congeners. The valley height between PCB 126 or 169 and its respective most closely eluted leading and trailing congeners must be less than 10 percent of the height of the shorter of the pair.
 - 6.9.2 Column #1— 30 ± 5 -m long \times 0.25 ± 0.02 -mm ID; 0.25 - μ m film SPB-Octyl (Supelco 2-4218, or equivalent).
 - 6.9.3 Column #2— 30 ± 5 -m long \times 0.25 ± 0.02 -mm ID; 0.25 - μ m film DB-1 (J&W, or equivalent).
- 6.10 Mass spectrometer—28- to 40-eV electron impact ionization, shall be capable of repetitively selectively monitoring 12 exact m/z's minimum at high resolution ($\geq 10,000$) during a period less than 1.5 seconds, and shall meet all of the performance specifications in Section 10.
- 6.11 GC/MS interface—The mass spectrometer (MS) shall be interfaced to the GC such that the end of the capillary column terminates within 1 cm of the ion source but does not intercept the electron or ion beams.
- 6.12 Data system—Capable of collecting, recording, and storing MS data.

7.0 Reagents and Standards

- 7.1 pH adjustment and back-extraction.
- 7.1.1 Potassium hydroxide—Dissolve 20 g reagent grade KOH in 100 mL reagent water.
 - 7.1.2 Sulfuric acid—Reagent grade (specific gravity 1.84).
 - 7.1.3 Hydrochloric acid—Reagent grade, 6N.
 - 7.1.4 Sodium chloride—Reagent grade, prepare at 5% (w/v) solution in reagent water.
- 7.2 Solution drying and evaporation.
- 7.2.1 Solution drying—Sodium sulfate, reagent grade, granular, anhydrous (Baker 3375, or equivalent), rinsed with methylene chloride (20 mL/g), baked at 400°C for 1 hour minimum, cooled in a desiccator, and stored in a pre-cleaned glass bottle with screw-cap that prevents moisture from entering. If, after heating, the sodium sulfate develops a noticeable grayish cast (due to the presence of carbon in the crystal matrix), that batch of reagent is not suitable for use and should be discarded. Extraction with methylene chloride (as opposed to simple rinsing) and baking at a lower temperature may produce sodium sulfate that is suitable for use.
 - 7.2.2 Tissue drying—Sodium sulfate, reagent grade, powdered, treated and stored as above.
 - 7.2.3 Purified nitrogen.

7.3 Extraction.

7.3.1 Solvents—Acetone, toluene, n-hexane, methanol, methylene chloride, and nonane; distilled in glass, pesticide quality, lot-certified to be free of interferences.

7.3.2 White quartz sand, 60/70 mesh—For Soxhlet/Dean-Stark extraction (Aldrich Chemical, Cat. No. 27-437-9, or equivalent). Bake at 450°C for 4 hours minimum.

7.4 GPC calibration solution—Prepare a solution containing 300 mg/mL corn oil, TBD mg/mL PCB 209, 1.4 mg/mL pentachlorophenol, 0.1 mg/mL perylene, and 0.5 mg/mL sulfur. [To be modified if necessary.]

7.5 Adsorbents for sample cleanup.**7.5.1 Silica gel.**

7.5.1.1 Activated silica gel—100-200 mesh, Supelco 1-3651 (or equivalent), rinsed with methylene chloride, baked at 180°C for a minimum of 1 hour, cooled in a desiccator, and stored in a precleaned glass bottle with screw-cap that prevents moisture from entering.

7.5.1.2 Acid silica gel (30% w/w)—Thoroughly mix 44.0 g of concentrated sulfuric acid with 100.0 g of activated silica gel in a clean container. Break up aggregates with a stirring rod until a uniform mixture is obtained. Store in a screw-capped bottle with fluoropolymer-lined cap.

7.5.1.3 Basic silica gel—Thoroughly mix 30 g of 1N sodium hydroxide with 100 g of activated silica gel in a clean container. Break up aggregates with a stirring rod until a uniform mixture is obtained. Store in a screw-capped bottle with fluoropolymer-lined cap.

7.5.1.4 Potassium silicate.

7.5.1.4.1 Dissolve 56 g of high purity potassium hydroxide (Aldrich, or equivalent) in 300 mL of methanol in a 750- to 1000-mL flat-bottom flask.

7.5.1.4.2 Add 100 g of activated silica gel (Section 7.5.1.1) and a stirring bar, and stir on a hot plate at 60-70°C for 1-2 hours.

7.5.1.4.3 Decant the liquid and rinse the potassium silicate twice with 100-mL portions of methanol, followed by a single rinse with 100 mL of methylene chloride.

7.5.1.4.4 Spread the potassium silicate on solvent-rinsed aluminum foil and dry for 2-4 hours in a hood.

7.5.1.4.5 Activate overnight at 200-250°C.

7.5.2 Carbon.

7.5.2.1 Carbpak C—(Supelco 1-0258, or equivalent).

7.5.2.2 Celite 545—(Supelco 2-0199, or equivalent).

7.5.2.3 Thoroughly mix 18.0 g Carbpak C and 18.0 g Celite 545 to produce a 50% w/w mixture. Activate the mixture at 130°C for a minimum of 6 hours. Store in a desiccator.

7.5.3 Anthropogenic isolation column—Pack the column in Section 6.7.4.3 from bottom to top with the following:

Method 1668

- 7.5.3.1 2 g activated silica gel (Section 7.5.1.1).
- 7.5.3.2 2 g potassium silicate (Section 7.5.1.4).
- 7.5.3.3 2 g granular anhydrous sodium sulfate (Section 7.2.1).
- 7.5.3.4 10 g acid silica gel (Section 7.5.1.2).
- 7.5.3.5 2 g granular anhydrous sodium sulfate.
- 7.5.4 Florisil column.
 - 7.5.4.1 Florisil—PR grade, 60-100 mesh (U.S. Silica Corp, Berkeley Springs, WV, or equivalent). Fill a clean 1- to 2-L bottle 1/2 to 2/3 full with Florisil and place in an oven at 130-150 °C for a minimum of three days.
 - 7.5.4.2 Immediately prior to use, dry pack a 300-mm x 22-mm ID glass column (Section 6.7.4.3) bottom to top with 0.5-1.0 cm of anhydrous sodium sulfate (Section 7.2.1), 10-10.5 cm of warm to hot activated Florisil (Section 7.5.4.1), and 1-2 cm of warm to hot anhydrous sodium sulfate. Allow the column to cool and wet immediately with 100 mL of n-hexane to prevent water from entering.
 - 7.5.4.3 Using the procedure in Section 13.7, establish the elution pattern for each carton of Florisil received.
- 7.6 Reference matrices—Matrices in which the PCBs and interfering compounds are not detected by this method.
 - 7.6.1 Reagent water—Bottled water purchased locally or prepared by passage through activated carbon.
 - 7.6.2 High-solids reference matrix—Playground sand or similar material. Prepared by extraction with methylene chloride and/or baking at 450°C for a minimum of 4 hours.
 - 7.6.3 Paper reference matrix—Glass-fiber filter, Gelman type A, or equivalent. Cut paper to simulate the surface area of the paper sample being tested.
 - 7.6.4 Tissue reference matrix—Corn or other vegetable oil. May be prepared by extraction with methylene chloride.
 - 7.6.5 Other matrices—This method may be verified on any reference matrix by performing the tests given in Section 9.2. Ideally, the matrix should be free of the PCBs, but in no case shall the background level of the PCBs in the reference matrix exceed three times the minimum levels in Table 2. If low background levels of the PCBs are present in the reference matrix, the spike level of the analytes used in Section 9.2 should be increased to provide a spike-to-background ratio in the range of 1:1 to 5:1 (Reference 11).
- 7.7 Standard solutions—Purchased as solutions or mixtures with certification to their purity, concentration, and authenticity, or prepared from materials of known purity and composition. If the chemical purity is 98% or greater, the weight may be used without correction to compute the concentration of the standard. When not being used, standards are stored in the dark at room temperature in screw-capped vials with fluoropolymer-lined caps. A mark is placed on the vial at the level of the solution so that solvent loss by evaporation can be detected. If solvent loss has occurred, the solution should be replaced.

- 7.8 Stock solutions.**
- 7.8.1** Preparation—Prepare in nonane per the steps below or purchase as dilute solutions (Cambridge Isotope Laboratories (CIL), Woburn, MA, or equivalent). Observe the safety precautions in Section 5 and the recommendation in Section 5.1.2.
- 7.8.2** Dissolve an appropriate amount of assayed reference material in solvent. For example, weigh 1 to 2 mg of PCB 126 to three significant figures in a 10-mL ground-glass-stoppered volumetric flask and fill to the mark with nonane. After the PCB is completely dissolved, transfer the solution to a clean 15-mL vial with fluoropolymer-lined cap.
- 7.8.3** Stock standard solutions should be checked for signs of degradation prior to the preparation of calibration or performance test standards. Reference standards that can be used to determine the accuracy of calibration standards are available from several vendors.
- 7.9 PAR stock solution.**
- 7.9.1** All PCBs—Using the solutions in Section 7.8, prepare the PAR stock solution to contain the PCBs of interest at the concentrations shown in Table 3. When diluted, the solution will become the PAR (Section 7.14).
- 7.9.2** If the toxic, non-ortho, co-planar PCBs (PCBs 77, 126, and 169) only are to be determined, prepare the PAR stock solution to contain these compounds only.
- 7.10 Labeled-compound spiking solution.**
- 7.10.1** All toxic PCBs—From stock solutions, or from purchased mixtures, prepare this solution to contain the labeled compounds in nonane at the concentrations shown in Table 3. This solution is diluted with acetone prior to use (Section 7.10.3).
- 7.10.2** If PCBs 77, 126, and 169 only are to be determined, prepare the labeled-compound solution to contain these compounds only. This solution is diluted with acetone prior to use (Section 7.10.3).
- 7.10.3** Dilute a sufficient volume of the labeled compound solution (Section 7.10.1 or 7.10.2) by a factor of 500 with acetone to prepare a diluted spiking solution. Each sample requires 1.0 mL of the diluted solution, but no more solution should be prepared than can be used in one day.
- 7.11** Cleanup standard—Prepare PCBs 81 and 111 in nonane at the concentration shown in Table 3. The cleanup standard is added to all extracts prior to cleanup to measure the efficiency of the cleanup process.
- 7.12** Internal standard(s).
- 7.12.1** All toxic PCBs—Prepare the internal standard solution to contain labeled PCBs 52, 101, 138, and 178 in nonane at the concentration shown in Table 3.
- 7.12.2** If PCBs 77, 126, and 169 only are to be determined, the internal standard solution may be prepared to contain PCBs 52, 101, and 138 only.
- 7.13** Calibration standards (CS1 through CS5)—Combine the solutions in Sections 7.9-7.12 to produce the five calibration solutions shown in Table 4 in nonane. These solutions permit the relative response (labeled to native) and response factor to be measured as a function of concentration. The CS3 standard is used for calibration verification (VER). If the PCBs 77, 126, and 169 only are to be determined, combine the solutions appropriate to these compounds.

Method 1668

- 7.14 Precision and recovery (PAR) standard—Used for determination of initial (Section 9.2) and ongoing (Section 15.5) precision and recovery (See Table 3). Dilute 200 µL of the PAR stock solution (Section 7.9.1 or 7.9.2) to 10 mL with acetone for each sample matrix for each sample batch. One mL of each are required for the blank and OPR with each matrix in each batch.
- 7.15 GC retention time window defining solution and isomer specificity test standard—Used to define the beginning and ending retention times for the PCB congeners and to demonstrate isomer specificity of the GC columns employed for determination of PCB 126. The standard must contain the compounds listed in Table 5 (CIL , or equivalent), at a minimum. It is not necessary to monitor all of the window-defining compounds if PCBs 77, 126, and 169 only are to be determined. In this case, a congener-specificity test standard containing the most closely eluted isomers listed in Table 5 (CIL , or equivalent) may be used.
- 7.16 QC Check Sample—A QC Check Sample should be obtained from a source independent of the calibration standards. Ideally, this check sample would be a certified standard reference material (SRM) containing the PCBs in known concentrations in a sample matrix similar to the matrix being analyzed. The National Institute of Standards and Technology (NIST) in Gaithersburg, Maryland has SRMs for several individual PCB congeners, and as Aroclors in transformer and motor oil, in combination with pesticides in cod liver oil, and in combination with 2,3,7,8-TCDD in human serum.
- 7.17 Stability of solutions—Standard solutions used for quantitative purposes (Sections 7.9 through 7.15) should be analyzed periodically, and should be assayed against reference standards before further use.

8.0 Sample Collection, Preservation, Storage, and Holding Times.

- 8.1 Collect samples in amber glass containers following conventional sampling practices (Reference 12).
- 8.2 Aqueous samples.
- 8.2.1 Samples that flow freely are collected as grab samples or in refrigerated bottles using automatic sampling equipment.
- 8.2.2 If residual chlorine is present, add 80 mg sodium thiosulfate per liter of water. EPA Methods 330.4 and 330.5 may be used to measure residual chlorine (Reference 13).
- 8.2.3 Adjust sample pH 2-3 with sulfuric acid.
- 8.2.4 Maintain aqueous samples in the dark at 0-4°C from the time of collection until receipt at the laboratory. Store in the dark at 0-4°C.
- 8.3 Solid samples.
- 8.3.4 Solid samples are collected as grab samples using wide-mouth jars.
- 8.3.4 Maintain solid, semi-solid, oily, and mixed-phase samples in the dark at <4°C from the time of collection until receipt at the laboratory. Store solid, semi-solid, oily, and mixed-phase samples in the dark at <-10°C.
- 8.4 Fish and tissue samples.

- 8.4.1 Fish may be cleaned, filleted, or processed in other ways in the field, such that the laboratory may expect to receive whole fish, fish fillets, or other tissues for analysis.
- 8.4.2 Fish collected in the field should be wrapped in aluminum foil and must be maintained at a temperature less than 4°C from the time of collection until receipt at the laboratory.
- 8.4.3 Samples must be frozen upon receipt at the laboratory and maintained in the dark at <-10°C until prepared. Maintain unused sample in the dark at <-10°C.

8.5 Holding times.

- 8.5.1 There are no demonstrated maximum holding times associated with the PCBs in aqueous, solid, semi-solid, tissues, or other sample matrices. If stored in the dark at 0-4°C and preserved as given above (if required), aqueous samples may be stored for up to one year. Similarly, if stored in the dark at <-10°C, solid, semi-solid, multi-phase, and tissue samples may be stored for up to one year.
- 8.5.2 Store sample extracts in the dark at <-10°C until analyzed. If stored in the dark at <-10°C, sample extracts may be stored for up to one year.

9.0 Quality Assurance/Quality Control

- 9.1 Each laboratory that uses this method is required to operate a formal quality assurance program (Reference 14). The minimum requirements of this program consist of an initial demonstration of laboratory capability, analysis of samples spiked with labeled compounds to evaluate and document data quality, and analysis of standards and blanks as tests of continued performance. Laboratory performance is compared to established performance criteria to determine if the results of analyses meet the performance characteristics of the method.

If the method is to be applied to a sample matrix other than water (e.g., soils, filter cake, compost, tissue) the most appropriate alternate matrix (Sections 7.6.2-7.6.5 and 7.16) is substituted for the reagent water matrix (Section 7.6.1) in all performance tests.

- 9.1.1 The analyst shall make an initial demonstration of the ability to generate acceptable accuracy and precision with this method. This ability is established as described in Section 9.2.
- 9.1.2 In recognition of advances that are occurring in analytical technology and to allow the analyst to overcome sample matrix interferences, the analyst is permitted certain options to improve separations or lower the costs of measurements. These options include alternate extraction, concentration, cleanup procedures, and changes in columns and detectors. Alternate determinative techniques, such as the substitution of spectroscopic or immunoassay techniques, and changes that degrade method performance, are not allowed. If an analytical technique other than the techniques specified in this method is used, that technique must have a specificity equal to or better than the specificity of the techniques in this method for the analytes of interest.
 - 9.1.2.1 Each time a modification is made to this method, the analyst is required to repeat the procedure in Section 9.2. If the detection limit of the method will be affected by the change, the laboratory is required to demonstrate that the MDL (40 CFR Part 136, Appendix B) is lower than one-third the regulatory compliance level or one-third the

Method 1668

ML in this method, whichever is higher. If calibration will be affected by the change, the analyst must recalibrate the instrument per Section 10.

9.1.2.2 The laboratory is required to maintain records of modifications made to this method. These records include the following at a minimum:

9.1.2.2.1 The names, titles, addresses, and telephone numbers of the analyst(s) who performed the analyses and modification, and of the quality control officer who witnessed and will verify the analyses and modifications.

9.1.2.2.2 A listing of pollutant(s) measured, by name and CAS Registry number.

9.1.2.2.3 A narrative stating reason(s) for the modifications.

9.1.2.2.4 Results from all quality control (QC) tests comparing the modified method to this method. These results are to include the following:

- a) Calibration (Section 10.5-10.7).
- b) Calibration verification (Section 15.3).
- c) Initial precision and recovery (Section 9.2).
- d) Labeled compound recovery (Section 9.3).
- e) Analysis of blanks (Section 9.5).
- f) Accuracy assessment (Section 9.4).

9.1.2.2.5 Data that will allow an independent reviewer to validate each determination by tracing the instrument output (peak height, area, or other signal) to the final result. These data are to include the following:

- a) Sample numbers and other identifiers.
- b) Extraction dates.
- c) Analysis dates and times.
- d) Analysis sequence/run chronology.
- e) Sample weight or volume (Section 11).
- f) Extract volume prior to each cleanup step (Section 13).
- g) Extract volume after each cleanup step (Section 13).
- h) Final extract volume prior to injection (Section 14).
- i) Injection volume (Section 14.3).
- j) Dilution data, differentiating between dilution of a sample or extract (Section 17.5).
- k) Instrument and operating conditions.
- l) Column (dimensions, liquid phase, solid support, film thickness, etc).
- m) Operating conditions (temperatures, temperature program, flow rates).
- n) Detector (type, operating conditions, etc).
- o) Chromatograms, printer tapes, and other recordings of raw data.
- p) Quantitation reports, data system outputs, and other data to link the raw data to the results reported.

9.1.3 Analyses of method blanks are required to demonstrate freedom from contamination (Section 4.3). The procedures and criteria for analysis of a method blank are described in Sections 9.5 and 15.6.

9.1.4 The laboratory shall spike all samples with labeled compounds to monitor method performance. This test is described in Section 9.3. When results of these spikes indicate

- atypical method performance for samples, the samples are diluted to bring method performance within acceptable limits. Procedures for dilution are given in Section 17.5.
- 9.1.5** The laboratory shall, on an ongoing basis, demonstrate through calibration verification and the analysis of the ongoing precision and recovery aliquot that the analytical system is in control. These procedures are described in Sections 15.1 through 15.5.
- 9.1.6** The laboratory shall maintain records to define the quality of data that is generated. Development of accuracy statements is described in Section 9.4.
- 9.2** Initial precision and recovery (IPR)—To establish the ability to generate acceptable precision and recovery, the analyst shall perform the following operations.
- 9.2.1** For low solids (aqueous, < 1% solids) samples, extract, concentrate, and analyze four 1-L aliquots of reagent water spiked with the diluted labeled compound spiking solution (Section 7.10.3) and the precision and recovery standard (Section 7.14) according to the procedures in Sections 11 through 18. For an alternative sample matrix, four aliquots of the alternative reference matrix (Section 7.6) are used. All sample processing steps that are to be used for processing samples, including preparation (Section 11), extraction (Section 12), and cleanup (Section 13), shall be included in this test.
- 9.2.2** Using results of the set of four analyses, compute the average concentration (X) of the extracts in ng/mL and the standard deviation of the concentration (s) in ng/mL for each compound, by isotope dilution for PCBs with a labeled analog, and by internal standard for the PCBs without a labeled analog, and the labeled compounds.
- 9.2.3** For each PCB and labeled compound, compare s and X with the corresponding limits for initial precision and recovery in Table 6. If PCBs 77, 126, and 169 only are to be determined, compare s and X with the corresponding limits for initial precision and recovery in Table 6a. If s and X for all compounds meet the acceptance criteria, system performance is acceptable and analysis of blanks and samples may begin. If, however, any individual s exceeds the precision limit or any individual X falls outside the range for accuracy, system performance is unacceptable for that compound. Correct the problem and repeat the test (Section 9.2).
- 9.3** The laboratory shall spike all samples with the diluted labeled compound spiking solution (Section 7.10.3) to assess method performance on the sample matrix.
- 9.3.1** Analyze each sample according to the procedures in Sections 11 through 18.
- 9.3.2** Compute the percent recovery of the labeled compounds and the cleanup standard using the internal standard method (Section 17.2).
- 9.3.3** The recovery of each labeled compound must be within the limits in Table 7 when all of the toxic PCBs are determined, and within the limits in Table 7a when PCBs 77, 126, and 169 only are determined. If the recovery of any compound falls outside of these limits, method performance is unacceptable for that compound in that sample. Additional cleanup procedures must then be employed to attempt to bring the recovery within the normal range. If the recovery cannot be brought within the normal range after all cleanup procedures have been employed, water samples are diluted and smaller amounts of soils, sludges, sediments, and other matrices are analyzed per Section 18.4.

Method 1668

- 9.4 Recovery of labeled compounds from samples should be assessed and records should be maintained.
- 9.4.1 After the analysis of five samples of a given matrix type (water, soil, sludge, pulp, etc.) for which the labeled compounds pass the tests in Section 9.3, compute the average percent recovery (R) and the standard deviation of the percent recovery (S_R) for the labeled compounds only. Express the assessment as a percent recovery interval from $R - 2S_R$ to $R + 2S_R$ for each matrix. For example, if $R = 90\%$ and $S_R = 10\%$ for five analyses of pulp, the recovery interval is expressed as 70 to 110%.
- 9.4.2 Update the accuracy assessment for each labeled compound in each matrix on a regular basis (e.g., after each five to ten new measurements).
- 9.5 Method blanks—Reference matrix method blanks are analyzed to demonstrate freedom from contamination (Section 4.3).
- 9.5.1 Prepare, extract, clean up, and concentrate a method blank with each sample batch (samples of the same matrix started through the extraction process on the same 12-hour shift, to a maximum of 20 samples). The matrix for the method blank shall be similar to sample matrix for the batch; e.g., a 1-L reagent water blank (Section 7.6.1), high-solids reference matrix blank (Section 7.6.2), paper matrix blank (Section 7.6.3), tissue blank (Section 7.6.4), or alternative reference matrix blank (Section 7.6.5). Analyze the blank immediately after analysis of the OPR (Section 15.5) to demonstrate freedom from contamination.
- 9.5.2 If any PCB (Table 1) is found in the blank at greater than the minimum level (Table 2) or one-third the regulatory compliance level whichever is greater, or if any potentially interfering compound is found in the blank at the minimum level for each level of chlorination given in Table 2 (assuming a response factor of 1 relative to the internal standard at that level of chlorination for compounds not listed in Table 1), analysis of samples is halted until the blank associated with the sample batch shows no evidence of contamination at this level. All samples must be associated with an uncontaminated method blank before the results for those samples may be reported for regulatory compliance purposes.
- 9.6 QC Check Sample—Analyze the QC Check Sample (Section 7.16) periodically to assure the accuracy of calibration standards and the overall reliability of the analytical process. It is suggested that the QC Check Sample be analyzed at least quarterly.
- 9.7 The specifications contained in this method can be met if the apparatus used is calibrated properly and then maintained in a calibrated state. The standards used for calibration (Section 10), calibration verification (Section 15.3), and for initial (Section 9.2) and ongoing (Section 15.5) precision and recovery should be identical, so that the most precise results will be obtained. A GC/MS instrument will provide the most reproducible results if dedicated to the settings and conditions required for the analyses of PCBs by this method.
- 9.8 Depending on specific program requirements, field replicates may be collected to determine the precision of the sampling technique, and spiked samples may be required to determine the accuracy of the analysis when the internal standard method is used.

10.0 Calibration

10.1 Establish the operating conditions necessary to meet the minimum retention times for the internal standards in Section 10.2.4 and the relative retention times for the PCBs in Table 2.

10.1.1 Suggested GC operating conditions:

Injector temperature:	290°C
Interface temperature:	290°C
Initial temperature:	150°C
Initial time:	2 minutes
Temperature program:	150 to 200°C at 10°C/minute 200 to 280°C at 2.0°C/minute

Note: *All portions of the column that connect the GC to the ion source shall remain at or above the interface temperature specified above during analysis to preclude condensation of less volatile compounds.*

The GC conditions may be optimized for compound separation and sensitivity. Once optimized, the same GC conditions must be used for the analysis of all standards, blanks, IPR and OPR aliquots, and samples.

10.1.2 Mass spectrometer (MS) resolution—Obtain a selected ion current profile (SICP) of each analyte in Table 3 at the two exact m/z 's specified in Table 8 and at $\geq 10,000$ resolving power by injecting an authentic standard of the PCBs either singly or as part of a mixture in which there is no interference between closely eluted components.

10.1.2.1 The analysis time for PCBs may exceed the long-term mass stability of the mass spectrometer. Because the instrument is operated in the high-resolution mode, mass drifts of a few ppm (e.g., 5 ppm in mass) can have serious adverse effects on instrument performance. Therefore, a mass-drift correction is mandatory and a lock-mass m/z from PFK is used for drift correction. The lock-mass m/z is dependent on the exact m/z 's monitored within each descriptor, as shown in Table 8. The level of PFK metered into the HRMS during analyses should be adjusted so that the amplitude of the most intense selected lock-mass m/z signal (regardless of the descriptor number) does not exceed 10% of the full-scale deflection for a given set of detector parameters. Under those conditions, sensitivity changes that might occur during the analysis can be more effectively monitored.

Note: *Excessive PFK (or any other reference substance) may cause noise problems and contamination of the ion source necessitating increased frequency of source cleaning.*

10.1.2.2 If the HRMS has the capability to monitor resolution during the analysis, it is acceptable to terminate the analysis when the resolution falls below 10,000 to save reanalysis time.

Method 1668

- 10.1.2.3** Using a PFK molecular leak, tune the instrument to meet the minimum required resolving power of 10,000 (10% valley) at m/z 304.9824 or any other reference signal close to m/z 305 (from PeCB). For each descriptor (Table 8), monitor and record the resolution and exact m/z 's of three to five reference peaks covering the mass range of the descriptor. The resolution must be greater than or equal to 10,000, and the deviation between the exact m/z and the theoretical m/z (Table 8) for each exact m/z monitored must be less than 5 ppm.
- 10.2** Ion abundance ratios, minimum levels, signal-to-noise ratios, and absolute retention times—
Choose an injection volume of either 1- or 2- μ L, consistent with the capability of the HRGC/HRMS instrument. Inject a 1 or 2 μ L aliquot of the CS1 calibration solution (Table 4) using the GC conditions from Section 10.1.1. If PCBs 77, 126, and 169 only are to be determined, the operating conditions and specifications below apply to analysis of those compounds only.
- 10.2.1** Measure the SICP areas for each analyte, and compute the ion abundance ratios at the exact m/z 's specified in Table 8. Compare the computed ratio to the theoretical ratio given in Table 9.
- 10.2.1.1** The exact m/z 's to be monitored in each descriptor are shown in Table 8. Each group or descriptor shall be monitored in succession as a function of GC retention time to ensure that all of the toxic PCBs are detected. Additional m/z 's may be monitored in each descriptor, and the m/z 's may be divided among more than the descriptors listed in Table 8, provided that the laboratory is able to monitor the m/z 's of all the PCBs that may elute from the GC in a given retention-time window. If PCBs 77, 126, and 169 only are to be determined, the descriptors may be modified to include only the exact m/z 's for the tetra-, penta-, and hexa-, congeners, and the lock m/z 's.
- 10.2.1.2** The mass spectrometer shall be operated in a mass-drift correction mode, using PFK to provide lock m/z 's. The lock mass for each group of m/z 's is shown in Table 8. Each lock mass shall be monitored and shall not vary by more than $\pm 20\%$ throughout its respective retention time window. Variations of the lock mass by more than 20% indicate the presence of coeluting interferences that may significantly reduce the sensitivity of the mass spectrometer. Reinjection of another aliquot of the sample extract will not resolve the problem. Additional cleanup of the extract may be required to remove the interferences.
- 10.2.2** All PCBs and labeled compounds in the CS1 standard shall be within the QC limits in Table 9 for their respective ion abundance ratios; otherwise, the mass spectrometer shall be adjusted and this test repeated until the m/z ratios fall within the limits specified. If the adjustment alters the resolution of the mass spectrometer, resolution shall be verified (Section 10.1.2) prior to repeat of the test.
- 10.2.3** Verify that the HRGC/HRMS instrument meets the minimum levels in Table 2. The peaks representing the PCBs and labeled compounds in the CS1 calibration standard must have signal-to-noise ratios (S/N) greater than or equal to 10.0. Otherwise, the mass spectrometer shall be adjusted and this test repeated until the minimum levels in Table 2 are met.

- 10.2.4** The absolute retention time of PCB 169 (Section 7.12) shall exceed 20 minutes on the SPB-Octyl column, and the retention time of PCB 157 shall exceed 25 minutes on the DB-1 column; otherwise, the GC temperature program shall be adjusted and this test repeated until the above-stated minimum retention time criteria are met.
- 10.3** Retention-time windows—Analyze the window defining mixtures (Section 7.15) using the optimized temperature program in Section 10.1. Table 5 gives the elution order (first/last) of the window-defining compounds. If PCBs 77, 126, and 169 only are to be determined, the window-defining tetra-, penta-, and hepta-PCBs are the only compounds that need to be tested.
- 10.4** Isomer specificity.
- 10.4.1** Analyze the isomer specificity test standards (Section 7.15) using the procedure in Section 14 and the optimized conditions for sample analysis (Section 10.1.1).
- 10.4.2** Compute the percent valley between the GC peaks that elute most closely to PCB 126 and 169 on the SPB-Octyl column and to PCB 156/157 on the DB-1 column, per Figures 6 and 7.
- 10.4.3** Verify that the height of the valley between the most closely eluted isomers and the PCBs given in Section 10.4.2 is less than 25% (computed as $100 \times y$ in Figures 6 and 7). If the valley exceeds 25%, adjust the analytical conditions and repeat the test or replace the GC column and recalibrate (Sections 10.1.2 through 10.7).
- 10.5** Calibration by isotope dilution—Isotope dilution calibration is used for the native PCBs for which labeled compounds are added to samples prior to extraction. The reference compound for each native compound is shown in Table 2.
- 10.5.1** A calibration curve encompassing the concentration range is prepared for each compound to be determined. The relative response (RR) (labeled to native) vs. concentration in standard solutions is plotted or computed using a linear regression. Relative response is determined according to the procedures described below. Five calibration points are employed.
- 10.5.2** The response of each native PCB relative to its labeled analog is determined using the area responses of both the primary and secondary exact m/z 's specified in Table 8, for each calibration standard as follows:

$$RR = \frac{(A1_n + A2_n) C_l}{(A1_l + A2_l) C_n}$$

Where:

$A1_n$ and $A2_n$ = The areas of the primary and secondary m/z 's for the PCB.

$A1_l$ and $A2_l$ = The areas of the primary and secondary m/z 's for the labeled compound.

C_l = The concentration of the labeled compound in the calibration standard (Table 4).

C_n = The concentration of the native compound in the calibration standard (Table 4).

- 10.5.3** To calibrate the analytical system by isotope dilution, inject a volume of calibration standards CS1 through CS5 (Section 7.13 and Table 4) identical to the volume chosen in

Method 1668

Section 10.2, using the procedure in Section 14 and the conditions in Section 10.1.1 and Table 2. Compute the relative response (RR) at each concentration.

- 10.5.4** Linearity—If the relative response for any compound is constant (less than 20% coefficient of variation) over the five-point calibration range, an averaged relative response may be used for that compound; otherwise, the complete calibration curve for that compound shall be used over the five-point calibration range.
- 10.6** Calibration by internal standard—The internal standard method is applied to determination of the native PCBs for which a labeled compound is not available and to the determination of labeled compounds for intralaboratory statistics (Sections 9.4 and 15.5.4).
- 10.6.1** Response factors—Calibration requires the determination of response factors (RF) defined by the following equation:

$$RF = \frac{(A1_s + A2_s) C_{is}}{(A1_{is} + A2_{is}) C_s}$$

Where:

- $A1_s$ and $A2_s$ = The areas of the primary and secondary m/z's for the PCB.
 $A1_{is}$ and $A2_{is}$ = The areas of the primary and secondary m/z's for the internal standard.
 C_{is} = The concentration of the internal standard (Table 4).
 C_s = The concentration of the compound in the calibration standard (Table 4).

Note: *There is only one m/z for PCBs 81 and 111 (see Table 8).*

- 10.6.2** To calibrate the analytical system by internal standard, inject 1.0 or 2.0 μ L of calibration standards CS1 through CS5 (Section 7.13 and Table 4) using the procedure in Section 14 and the conditions in Section 10.1.1 and Table 2. Compute the response factor (RF) at each concentration.
- 10.6.3** Linearity—If the response factor (RF) for any compound is constant (less than 35% coefficient of variation) over the five-point calibration range, an averaged response factor may be used for that compound; otherwise, the complete calibration curve for that compound shall be used over the five-point range.
- 10.7** Combined calibration—By using calibration solutions (Section 7.13 and Table 4) containing the native PCBs, labeled compounds, and the internal standards, a single set of analyses can be used to produce calibration curves for the isotope dilution and internal standard methods. These curves are verified (Section 15.3) each shift by analyzing the calibration verification standard (VER, Table 4). Recalibration is required if any of the calibration verification criteria (Section 15.3) cannot be met.
- 10.8** Data storage—MS data shall be collected, recorded, and stored.
- 10.8.1** Data acquisition—The signal at each exact m/z shall be collected repetitively throughout the monitoring period and stored on a mass storage device.
- 10.8.2** Response factors and multipoint calibrations—The data system shall be used to record and maintain lists of response factors (response ratios for isotope dilution) and multipoint

calibration curves. Computations of relative standard deviation (coefficient of variation) shall be used to test calibration linearity. Statistics on initial performance (Section 9.2) and ongoing performance (Section 15.5) should be computed and maintained, either on the instrument data system or on a separate computer system.

11.0 Sample Preparation

11.1 Sample preparation involves modifying the physical form of the sample so that the PCBs can be extracted efficiently. In general, the samples must be in a liquid form or in the form of finely divided solids in order for efficient extraction to take place. Table 10 lists the phases and suggested quantities for extraction of various sample matrices.

For samples known or expected to contain high levels of the PCBs, the smallest sample size representative of the entire sample should be used (see Section 17.5).

For all samples, the blank and IPR/OPR aliquots must be processed through the same steps as the sample to check for contamination and losses in the preparation processes.

11.1.1 For samples that contain particles, percent solids and particle size are determined using the procedures in Sections 11.2 and 11.3, respectively.

11.1.2 Aqueous samples—Because PCBs may be bound to suspended particles, the preparation of aqueous samples is dependent on the solids content of the sample.

11.1.2.1 Aqueous samples containing 1% solids or less are prepared per Section 11.4 and extracted directly using the SPE technique in 12.2.

11.1.2.2 For aqueous samples containing greater than 1% solids, a sample aliquot sufficient to provide 10 g of dry solids is used as described in Section 11.5.

11.1.3 Solid samples are prepared using the procedure described in Section 11.5 followed by extraction via the SDS procedure in Section 12.3.

11.1.4 Multiphase samples—The phase(s) containing the PCBs is separated from the non-PCB phase using pressure filtration and centrifugation as described in Section 11.6. The PCBs will be in the organic phase in a multiphase sample in which an organic phase exists.

11.1.5 Procedures for grinding, homogenization, and blending of various sample phases are given in Section 11.7.

11.1.6 Tissue samples—Preparation procedures for fish and other tissues are given in Section 11.8.

11.2 Determination of percent suspended solids.

Note: *This aliquot is used for determining the solids content of the sample, not for determination of PCBs.*

11.2.1 Aqueous liquids and multi-phase samples consisting of mainly an aqueous phase.

11.2.1.1 Desiccate and weigh a GF/D filter (Section 6.5.3) to three significant figures.

11.2.1.2 Filter 10.0 ± 0.02 mL of well-mixed sample through the filter.

11.2.1.3 Dry the filter a minimum of 12 hours at $110 \pm 5^\circ\text{C}$ and cool in a desiccator.

Method 1668

11.2.1.4 Calculate percent solids as follows:

$$\% \text{ solids} = \frac{\text{weight of sample aliquot plus filter after drying (g)} - \text{weight of filter (g)}}{10 \text{ g}} \times 100$$

11.2.2 Non-aqueous liquids, solids, semi-solid samples, and multi-phase samples in which the main phase is not aqueous, but not tissues.

11.2.2.1 Weigh 5 to 10 g of sample to three significant figures in a tared beaker.

11.2.2.2 Dry a minimum of 12 hours at $110 \pm 5^\circ\text{C}$, and cool in a desiccator.

11.2.2.3 Calculate percent solids as follows:

$$\% \text{ solids} = \frac{\text{weight of sample aliquot after drying}}{\text{weight of sample aliquot before drying}} \times 100$$

11.3 Determination of particle size.

11.3.1 Spread the dried sample from Section 11.2.2.2 on a piece of filter paper or aluminum foil in a fume hood or glove box.

11.3.2 Estimate the size of the particles in the sample. If the size of the largest particles is greater than 1 mm, the particle size must be reduced to 1 mm or less prior to extraction using the procedures in Section 11.7.

11.4 Preparation of aqueous samples containing 1% suspended solids or less.

11.4.1 Aqueous samples containing 1% suspended solids or less are prepared using the procedure below and extracted using the SPE technique in Section 12.2.

11.4.2 Preparation of sample and QC aliquots.

11.4.2.1 Mark the original level of the sample on the sample bottle for reference. Weigh the sample-plus bottle to ± 1 g.

11.4.2.2 Spike 1.0 mL of the diluted labeled-compound spiking solution (Section 7.10.3) into the sample bottle. Cap the bottle and mix the sample by careful shaking. Allow the sample to equilibrate for 1 to 2 hours, with occasional shaking.

11.4.2.3 For each sample or sample batch (to a maximum of 20 samples) to be extracted during the same 12-hour shift, place two 1.0-L aliquots of reagent water in clean sample bottles or flasks.

11.4.2.4 Spike 1.0 mL of the diluted labeled-compound spiking solution (Section 7.10.3) into both reagent water aliquots. One of these aliquots will serve as the method blank.

11.4.2.5 Spike 1.0 mL of the PAR standard (Section 7.14) into the remaining reagent water aliquot. This aliquot will serve as the OPR (Section 15.5).

11.4.2.6 Add 5 mL of methanol to the sample and QC aliquots. Cap and shake the sample and QC aliquots to mix thoroughly and proceed to Section 12.2 for extraction.

- 11.5** Preparation of samples containing greater than 1% solids.
- 11.5.1** Weigh a well-mixed aliquot of each sample (of the same matrix type) sufficient to provide 10 g of dry solids (based on the solids determination in Section 11.2) into a clean beaker or glass jar.
 - 11.5.2** Spike 1.0 mL of the diluted labeled compound spiking solution (Section 7.10.3) into the sample.
 - 11.5.3** For each sample or sample batch (to a maximum of 20 samples) to be extracted during the same 12 hour shift, weigh two 10-g aliquots of the appropriate reference matrix (Section 7.6) into clean beakers or glass jars.
 - 11.5.4** Spike 1.0 mL of the diluted labeled compound spiking solution (Section 7.10.3) into each reference matrix aliquot. One aliquot will serve as the method blank. Spike 1.0 mL of the PAR standard (Section 7.14) into the other reference matrix aliquot. This aliquot will serve as the OPR (Section 15.5).
 - 11.5.5** Stir or tumble and equilibrate the aliquots for 1 to 2 hours.
 - 11.5.6** Decant excess water. If necessary to remove water, filter the sample through a glass-fiber filter (Section 6.5.6) and discard the aqueous liquid.
 - 11.5.7** If particles >1 mm are present in the sample (as determined in Section 11.3.2), spread the sample on clean aluminum foil in a hood. After the sample is dry, grind to reduce the particle size (Section 11.7).
 - 11.5.8** Extract the sample and QC aliquots using the SDS procedure in Section 12.3.
- 11.6** Multiphase samples.
- 11.6.1** Using the percent solids determined in Section 11.2.1 or 11.2.2, determine the volume of sample that will provide 10 g of solids, up to 1 L of sample.
 - 11.6.2** Pressure filter the amount of sample determined in Section 11.6.1 through Whatman GF/D glass-fiber filter paper (Section 6.5.3). Pressure filter the blank and OPR aliquots through GF/D papers also. If necessary to separate the phases and/or settle the solids, centrifuge these aliquots prior to filtration.
 - 11.6.3** Discard any aqueous phase (if present). Remove any non-aqueous liquid present and reserve the maximum amount filtered from the sample (Section 11.6.1) or 10 g, whichever is less, for combination with the solid phase (Section 12.3.5).
 - 11.6.4** If particles >1 mm are present in the sample (as determined in Section 11.3.2) and the sample is capable of being dried, spread the sample and QC aliquots on clean aluminum foil in a hood. After the aliquots are dry, or if the sample cannot be dried, reduce the particle size using the procedures in Section 11.7 and extract the reduced particles using the SDS procedure in Section 12.3. If particles >1 mm are not present, extract the particles and filter in the sample and QC aliquots directly using the SDS procedure in Section 12.3.
- 11.7** Sample grinding, homogenization, or blending—Samples with particle sizes greater than 1 mm (as determined in Section 11.3.2) are subjected to grinding, homogenization, or blending. The method of reducing particle size to less than 1 mm is matrix-dependent. In general, hard particles can be reduced by grinding with a mortar and pestle. Softer particles can be reduced by grinding in a Wiley mill or meat grinder, by homogenization, or in a blender.

Method 1668

- 11.7.1 Each size-reducing preparation procedure on each matrix shall be verified by running the tests in Section 9.2 before the procedure is employed routinely.
- 11.7.2 The grinding, homogenization, or blending procedures shall be carried out in a glove box or fume hood to prevent particles from contaminating the work environment.
- 11.7.3 Grinding—Certain papers and pulps, slurries, and amorphous solids can be ground in a Wiley mill or heavy duty meat grinder. In some cases, reducing the temperature of the sample to freezing or to dry ice or liquid nitrogen temperatures can aid in the grinding process. Grind the sample aliquots from Sections 11.5.7 or 11.6.4 in a clean grinder. Do not allow the sample temperature to exceed 50°C. Grind the blank and reference matrix aliquots using a clean grinder.
- 11.7.4 Homogenization or blending—Particles that are not ground effectively, or particles greater than 1 mm in size after grinding, can often be reduced in size by high speed homogenization or blending. Homogenize and/or blend the particles or filter from Sections 11.5.7 or 11.6.4 for the sample, blank, and OPR aliquots.
- 11.7.5 Extract the aliquots using the SDS procedure in Section 12.3.
- 11.8 Fish and other tissues—Prior to processing tissue samples, the laboratory must determine the exact tissue to be analyzed. Common requests for analysis of fish tissue include whole fish—skin on, whole fish—skin removed, edible fish fillets (filleted in the field or by the laboratory), specific organs, and other portions. Once the appropriate tissue has been determined, the sample must be homogenized.
 - 11.8.1 Homogenization.
 - 11.8.1.1 Samples are homogenized while still frozen, where practical. If the laboratory must dissect the whole fish to obtain the appropriate tissue for analysis, the unused tissues may be rapidly refrozen and stored in a clean glass jar for subsequent use.
 - 11.8.1.2 Each analysis requires 10 g of tissue (wet weight). Therefore, the laboratory should homogenize at least 20 g of tissue to allow for re-extraction of a second aliquot of the same homogenized sample, if re-analysis is required. When whole fish analysis is necessary, the entire fish is homogenized.
 - 11.8.1.3 Homogenize the sample in a tissue homogenizer (Section 6.3.3) or grind in a meat grinder (Section 6.3.4). Cut tissue too large to feed into the grinder into smaller pieces. To assure homogeneity, grind three times.
 - 11.8.1.4 Transfer approximately 10 g (wet weight) of homogenized tissue to a clean, tared, 400- to 500-mL beaker.
 - 11.8.1.5 Transfer the remaining homogenized tissue to a clean jar with a fluoropolymer-lined lid. Seal the jar and store the tissue at <-10°C. Return any tissue that was not homogenized to its original container and store at <-10°C.
 - 11.8.2 QC aliquots.
 - 11.8.2.1 Prepare a method blank by adding approximately 10 g of the oily liquid reference matrix (Section 7.6.4) to a 400- to 500-mL beaker.
 - 11.8.2.2 Prepare a precision and recovery aliquot by adding approximately 10 g of the oily liquid reference matrix (Section 7.6.4) to a separate 400- to 500-mL beaker. Record

the weight to the nearest 10 mg. If the initial precision and recovery test is to be performed, use four aliquots; if the ongoing precision and recovery test is to be performed, use a single aliquot.

11.8.3 Spiking.

11.8.3.1 Spike 1.0 mL of the labeled compound spiking solution (Section 7.10.3) into the sample, blank, and OPR aliquot.

11.8.3.2 Spike 1.0 mL of the PAR standard (Section 7.14) into the OPR aliquot.

11.8.4 Extract the aliquots using the procedures in Section 12.4.

12.0 Extraction and Concentration

12.1 Extraction procedures include solid phase (Section 12.2) for aqueous liquids; Soxhlet/Dean-Stark (Section 12.3) for solids and filters; and Soxhlet extraction (Section 12.4) for tissues. Acid/base back-extraction (Section 12.5) is used for initial cleanup of extracts.

Macro-concentration procedures include rotary evaporation (Section 12.6.1), heating mantle (Section 12.6.2), and Kuderna-Danish (K-D) evaporation (Section 12.6.3). Micro-concentration uses nitrogen blowdown (Section 12.7).

12.2 SPE of samples containing less than 1% solids.

12.2.1 Disk preparation.

12.2.1.1 Remove the test tube from the suction flask (Figure 4). Place an SPE disk on the base of the filter holder and wet with methylene chloride. While holding a GMF 150 filter above the SPE disk with tweezers, wet the filter with methylene chloride and lay the filter on the SPE disk, making sure that air is not trapped between the filter and disk. Clamp the filter and SPE disk between the 1-L glass reservoir and the vacuum filtration flask.

12.2.1.2 Rinse the sides of the reservoir with approximately 15 mL of methylene chloride using a squeeze bottle or pipet. Apply vacuum momentarily until a few drops appear at the drip tip. Release the vacuum and allow the filter/disk to soak for approximately one minute. Apply vacuum and draw all of the methylene chloride through the filter/disk. Repeat the wash step with approximately 15 mL of acetone and allow the filter/disk to air dry.

12.2.2 Sample extraction.

12.2.2.1 Pre-wet the disk by adding approximately 20 mL of methanol to the reservoir. Pull most of the methanol through the filter/disk, retaining a layer of methanol approximately 2 mm thick on the filter. Do not allow the filter/disk to go dry from this point until the extraction is completed.

12.2.2.2 Add approximately 20 mL of reagent water to the reservoir and pull most through, leaving a layer approximately 2 mm thick on the filter/disk.

12.2.2.3 Allow the sample (Section 11.4.2.2) to stand for 1-2 hours, if necessary, to settle the suspended particles. Decant the clear layer of the sample, the blank (Section 11.4.2.4), or IPR/OPR aliquot (Section 11.4.2.5) into the reservoir and turn on the vacuum to begin the extraction. Adjust the vacuum to complete the extraction in no less than 10

Method 1668

minutes. For samples containing a high concentration of particles (suspended solids), the extraction time may be one hour or longer.

12.2.2.4 Before all of the sample has been pulled through the filter/disk, add approximately 50 mL of reagent water to the sample bottle, swirl to suspend the solids (if present), and pour into the reservoir. Pull through the filter/disk. Use additional reagent water rinses until all solids are removed.

12.2.2.5 Before all of the sample and rinses have been pulled through the filter/disk, rinse the sides of the reservoir with small portions of reagent water.

12.2.2.6 Partially dry the filter/disk under vacuum for approximately 3 minutes.

12.2.3 Elution of the filter/disk.

12.2.3.1 Release the vacuum, remove the entire filter/disk/reservoir assembly from the vacuum flask, and empty the flask. Insert a test tube for eluant collection into the flask. The test tube should have sufficient capacity to contain the total volume of the elution solvent (approximately 50 mL) and should fit around the drip tip. The drip tip should protrude into the test tube to preclude loss of sample from spattering when vacuum is applied. Reassemble the filter/disk/reservoir assembly on the vacuum flask.

12.2.3.2 Wet the filter/disk with 4-5 mL of acetone. Allow the acetone to spread evenly across the disk and soak for 15-20 seconds. Pull the acetone through the disk, releasing the vacuum when approximately 1 mm thickness remains on the filter.

12.2.3.3 Rinse the sample bottle with approximately 20 mL of methylene chloride and transfer to the reservoir. Pull approximately half of the solvent through the filter/disk and release the vacuum. Allow the filter/disk to soak for approximately 1 minute. Pull all of the solvent through the disk. Repeat the bottle rinsing and elution step with another 20 mL of methylene chloride. Pull all of the solvent through the disk.

12.2.3.4 Release the vacuum, remove the filter/disk/reservoir assembly, and remove the test tube containing the sample solution. Quantitatively transfer the solution to a 250-mL separatory funnel and proceed to Section 12.5 for back-extraction.

12.3 SDS extraction of samples containing particles.

12.3.1 Charge a clean extraction thimble (Section 6.4.2.2) with 5.0 g of 100/200 mesh silica (Section 7.5.1.1) topped with 100 g of quartz sand (Section 7.3.2).

Note: *Do not disturb the silica layer throughout the extraction process.*

12.3.2 Place the thimble in a clean extractor. Place 30 to 40 mL of toluene in the receiver and 200 to 250 mL of toluene in the flask.

12.3.3 Pre-extract the glassware by heating the flask until the toluene is boiling. When properly adjusted, 1 to 2 drops of toluene will fall per second from the condenser tip into the receiver. Extract the apparatus for a minimum of 3 hours.

12.3.4 After pre-extraction, cool and disassemble the apparatus. Rinse the thimble with toluene and allow to air dry.

- 12.3.5** Load the wet sample and/or filter from Sections 11.5.8, 11.6.4, 11.7.3, or 11.7.4 and any nonaqueous liquid from Section 11.6.3 into the thimble and manually mix into the sand layer with a clean metal spatula, carefully breaking up any large lumps of sample.
- 12.3.6** Reassemble the pre-extracted SDS apparatus, and add a fresh charge of toluene to the receiver and reflux flask. Apply power to the heating mantle to begin refluxing. Adjust the reflux rate to match the rate of percolation through the sand and silica beds until water removal lessens the restriction to toluene flow. Frequently check the apparatus for foaming during the first 2 hours of extraction. If foaming occurs, reduce the reflux rate until foaming subsides.
- 12.3.7** Drain the water from the receiver at 1 to 2 hours and 8 to 9 hours, or sooner if the receiver fills with water. Reflux the sample for a total of 16 to 24 hours. Cool and disassemble the apparatus. Record the total volume of water collected.
- 12.3.8** Remove the distilling flask. Drain the water from the Dean-Stark receiver and add any toluene in the receiver to the extract in the flask.
- 12.3.9** Concentrate the extracts from particles (Sections 11.5-11.7) to approximately 10 mL using the rotary evaporator or heating mantle (Section 12.6.1 or 12.6.2), transfer to a 250-mL separatory funnel, and proceed with back-extraction (Section 12.5).
- 12.4** Extraction of tissue.
- 12.4.1** Add 30 to 40 g of powdered anhydrous sodium sulfate to each of the beakers (Section 11.8.1.4, 11.8.2.1, and 11.8.2.2) and mix thoroughly. Cover the beakers with aluminum foil and allow to equilibrate for 12-24 hours. Remix prior to extraction to prevent clumping.
- 12.4.2** Assemble and pre-extract the Soxhlet apparatus per Sections 12.3.1-12.3.4, except use the methylene chloride:n-hexane (1:1) mixture for the pre-extraction and rinsing and omit the quartz sand. The Dean-Stark moisture trap may also be omitted, if desired.
- 12.4.3** Reassemble the pre-extracted Soxhlet apparatus and add a fresh charge of methylene chloride:n-hexane to the reflux flask.
- 12.4.4** Transfer the sample/sodium sulfate mixture (Section 12.4.1) to the Soxhlet thimble, and install the thimble in the Soxhlet apparatus.
- 12.4.5** Rinse the beaker with several portions of solvent mixture and add to the thimble. Fill the thimble/receiver with solvent. Extract for 18 to 24 hours.
- 12.4.6** After extraction, cool and disassemble the apparatus.
- 12.4.7** Quantitatively transfer the extract to a macro-concentration device (Section 12.6), and concentrate to near dryness. Set aside the concentration apparatus for re-use.
- 12.4.8** Complete the removal of the solvent using the nitrogen blowdown procedure (Section 12.7) and a water bath temperature of 60°C. Weigh the receiver, record the weight, and return the receiver to the blowdown apparatus, concentrating the residue until a constant weight is obtained.
- 12.4.9** Percent lipid determination—The lipid content is determined by extraction of tissue with the same solvent system (methylene chloride:n-hexane) that was used in EPA's National Dioxin Study (Reference 15) so that lipid contents are consistent with that study.

Method 1668

- 12.4.9.1 Redissolve the residue in the receiver in n-hexane and spike 1.0 mL of the cleanup standard (Section 7.11) into the solution.
- 12.4.9.2 Transfer the residue/n-hexane to the anthropogenic isolation column (Section 13.6.1), retaining the boiling chips in the concentration apparatus. Use several rinses to assure that all material is transferred. If necessary, sonicate or heat the receiver slightly to assure that all material is re-dissolved. Allow the receiver to dry. Weigh the receiver and boiling chips.
- 12.4.9.3 Calculate the lipid content to the nearest three significant figures as follows:

$$\text{Percent lipid content} = \frac{\text{Weight of residue (g)}}{\text{Weight of tissue (g)}} \times 100$$

- 12.4.9.4 It is not necessary to determine the lipid content of the blank, IPR, or OPR aliquots.

12.5 Back-extraction with base and acid.

- 12.5.1 Spike 1.0 mL of the cleanup standard (Section 7.11) into the separatory funnels containing the sample and QC extracts from Section 12.2.3.4 or 12.3.9.
 - 12.5.2 Partition the extract against 50 mL of potassium hydroxide solution (Section 7.1.1). Shake for 2 minutes with periodic venting into a hood. Remove and discard the aqueous layer. Repeat the base washing until no color is visible in the aqueous layer to a maximum of four washings. Minimize contact time between the extract and the base to prevent degradation of the PCBs. Stronger potassium hydroxide solutions may be employed for back-extraction, provided that the laboratory meets the specifications for labeled compound recovery and demonstrates acceptable performance using the procedure in Section 9.2.
 - 12.5.3 Partition the extract against 50 mL of sodium chloride solution (Section 7.1.4) in the same way as with base. Discard the aqueous layer.
 - 12.5.4 Partition the extract against 50 mL of sulfuric acid (Section 7.1.2) in the same way as with base. Repeat the acid washing until no color is visible in the aqueous layer to a maximum of four washings.
 - 12.5.5 Repeat the partitioning against sodium chloride solution and discard the aqueous layer.
 - 12.5.6 Pour each extract through a drying column containing 7 to 10 cm of granular anhydrous sodium sulfate (Section 7.2.1). Rinse the separatory funnel with 30 to 50 mL of solvent, and pour through the drying column. Collect each extract in a round-bottom flask. Re-concentrate the sample and QC aliquots per Sections 12.6-12.7, and clean up the samples and QC aliquots per Section 13.
- 12.6 Macro-concentration—Extracts in toluene are concentrated using a rotary evaporator or a heating mantle; extracts in methylene chloride or n-hexane are concentrated using a rotary evaporator, heating mantle, or Kuderna-Danish apparatus.
- 12.6.1 Rotary evaporation—Concentrate the extracts in separate round-bottom flasks.
 - 12.6.1.1 Assemble the rotary evaporator according to manufacturer's instructions, and warm the water bath to 45°C. On a daily basis, preclean the rotary evaporator by concentrating

100 mL of clean extraction solvent through the system. Archive both the concentrated solvent and the solvent in the catch flask for a contamination check if necessary. Between samples, three 2- to 3-mL aliquots of solvent should be rinsed down the feed tube into a waste beaker.

- 12.6.1.2** Attach the round-bottom flask containing the sample extract to the rotary evaporator. Slowly apply vacuum to the system, and begin rotating the sample flask.
- 12.6.1.3** Lower the flask into the water bath, and adjust the speed of rotation and the temperature as required to complete concentration in 15 to 20 minutes. At the proper rate of concentration, the flow of solvent into the receiving flask will be steady, but no bumping or visible boiling of the extract will occur.

Note: *If the rate of concentration is too fast, analyte loss may occur.*

- 12.6.1.4** When the liquid in the concentration flask has reached an apparent volume of approximately 2 mL, remove the flask from the water bath and stop the rotation. Slowly and carefully admit air into the system. Be sure not to open the valve so quickly that the sample is blown out of the flask. Rinse the feed tube with approximately 2 mL of solvent.
- 12.6.1.5** Proceed to Section 12.6.4 for preparation for back-extraction or micro-concentration and solvent exchange.
- 12.6.2** Heating mantle—Concentrate the extracts in separate round-bottom flasks.
- 12.6.2.1** Add one or two clean boiling chips to the round-bottom flask, and attach a three-ball macro-Snyder column. Pre-wet the column by adding approximately 1 mL of solvent through the top. Place the round-bottom flask in a heating mantle, and apply heat as required to complete the concentration in 15 to 20 minutes. At the proper rate of distillation, the balls of the column will actively chatter, but the chambers will not flood.
- 12.6.2.2** When the liquid has reached an apparent volume of approximately 10 mL, remove the round-bottom flask from the heating mantle and allow the solvent to drain and cool for at least 10 minutes. Remove the Snyder column and rinse the glass joint into the receiver with small portions of solvent.
- 12.6.2.3** Proceed to Section 12.6.4 for preparation for back-extraction or micro-concentration and solvent exchange.
- 12.6.3** Kuderna-Danish (K-D)—Concentrate the extracts in separate 500-mL K-D flasks equipped with 10-mL concentrator tubes. The K-D technique is used for solvents such as methylene chloride and n-hexane. Toluene is difficult to concentrate using the K-D technique unless a water bath fed by a steam generator is used.
- 12.6.3.1** Add 1 to 2 clean boiling chips to the receiver. Attach a three-ball macro-Snyder column. Pre-wet the column by adding approximately 1 mL of solvent through the top. Place the K-D apparatus in a hot water bath so that the entire lower rounded surface of the flask is bathed with steam.

Method 1668

- 12.6.3.2 Adjust the vertical position of the apparatus and the water temperature as required to complete the concentration in 15 to 20 minutes. At the proper rate of distillation, the balls of the column will actively chatter but the chambers will not flood.
- 12.6.3.3 When the liquid has reached an apparent volume of 1 mL, remove the K-D apparatus from the bath and allow the solvent to drain and cool for at least 10 minutes. Remove the Snyder column and rinse the flask and its lower joint into the concentrator tube with 1 to 2 mL of solvent. A 5-mL syringe is recommended for this operation.
- 12.6.3.4 Remove the three-ball Snyder column, add a fresh boiling chip, and attach a two-ball micro-Snyder column to the concentrator tube. Pre-wet the column by adding approximately 0.5 mL of solvent through the top. Place the apparatus in the hot water bath.
- 12.6.3.5 Adjust the vertical position and the water temperature as required to complete the concentration in 5 to 10 minutes. At the proper rate of distillation, the balls of the column will actively chatter but the chambers will not flood.
- 12.6.3.6 When the liquid reaches an apparent volume of 0.5 mL, remove the apparatus from the water bath and allow to drain and cool for at least 10 minutes.
- 12.6.3.7 Proceed to 12.6.4 for preparation for back-extraction or micro-concentration and solvent exchange.
- 12.6.4 Preparation for back-extraction or micro-concentration and solvent exchange.
 - 12.6.4.1 For back-extraction (Section 12.5), transfer the extract to a 250-mL separatory funnel. Rinse the concentration vessel with small portions of n-hexane, adjust the n-hexane volume in the separatory funnel to 10 to 20 mL, and proceed to back-extraction (Section 12.5).
 - 12.6.4.2 For determination of the weight of residue in the extract or for clean-up procedures other than back-extraction, transfer the extract to a blowdown vial using 2-3 rinses of solvent. Proceed with micro-concentration and solvent exchange (Section 12.7).
- 12.7 Micro-concentration and solvent exchange.
 - 12.7.1 Extracts to be subjected to GPC or HPLC cleanup are exchanged into methylene chloride. Extracts to be cleaned up using silica gel, carbon, and/or Florisil are exchanged into n-hexane.
 - 12.7.2 Transfer the vial containing the sample extract to a nitrogen blowdown device. Adjust the flow of nitrogen so that the surface of the solvent is just visibly disturbed.

Note: *A large vortex in the solvent may cause analyte loss.*

- 12.7.3 Lower the vial into a 45°C water bath and continue concentrating.
 - 12.7.3.1 If the extract is to be concentrated to dryness for weight determination (Sections 12.4.8 and 13.6.4), blow dry until a constant weight is obtained.
 - 12.7.3.2 If the extract is to be concentrated for injection into the GC/MS or the solvent is to be exchanged for extract cleanup, proceed as follows:

- 12.7.4 When the volume of the liquid is approximately 100 μ L, add 2 to 3 mL of the desired solvent (methylene chloride for GPC and HPLC, or n-hexane for the other cleanups) and continue concentration to approximately 100 μ L. Repeat the addition of solvent and concentrate once more.
- 12.7.5 If the extract is to be cleaned up by GPC, adjust the volume of the extract to 5.0 mL with methylene chloride. If the extract is to be cleaned up by HPLC, further concentrate the extract to 30 μ L. Proceed with GPC or HPLC cleanup (Section 13.2 or 13.5, respectively).
- 12.7.6 If the extract is to be cleaned up by column chromatography (silica gel, Carbopak/Celite, or Florisil), bring the final volume to 1.0 mL with n-hexane. Proceed with column cleanups (Sections 13.3 - 13.4 and 13.7).
- 12.7.7 If the extract is to be concentrated for injection into the GC/MS (Section 14), quantitatively transfer the extract to a 0.3-mL conical vial for final concentration, rinsing the larger vial with n-hexane and adding the rinse to the conical vial. Reduce the volume to approximately 100 μ L. Add 10 μ L of nonane to the vial, and evaporate the solvent to the level of the nonane. Seal the vial and label with the sample number. Store in the dark at room temperature until ready for GC/MS analysis. If GC/MS analysis will not be performed on the same day, store the vial at $<-10^{\circ}\text{C}$.

13.0 Extract Cleanup

- 13.1 Cleanup may not be necessary for relatively clean samples (e.g., treated effluents, groundwater, drinking water). If particular circumstances require the use of a cleanup procedure, the analyst may use any or all of the procedures below or any other appropriate procedure. Before using a cleanup procedure, the analyst must demonstrate that the requirements of Section 9.2 can be met using the cleanup procedure. If PCBs 77, 126, and 169 only are to be determined, the cleanup procedures may be optimized for isolation of these compounds.
 - 13.1.1 Gel permeation chromatography (Section 13.2) removes high molecular weight interferences that cause GC column performance to degrade. It should be used for all soil and sediment extracts. It may be used for water extracts that are expected to contain high molecular weight organic compounds (e.g., polymeric materials, humic acids). It may also be used for tissue extracts after initial cleanup on the anthropogenic isolation column (Section 13.6).
 - 13.1.2 Acid, neutral, and basic silica gel (Section 13.3) and Florisil (Section 13.7) are used to remove nonpolar and polar interferences.
 - 13.1.3 Carbopak/Celite (Section 13.4) can be used to separate PCBs 77, 126, and 169 from the mono- and di- ortho-substituted PCBs, if desired.
 - 13.1.4 HPLC (Section 13.5) is used to provide specificity for certain congeners and congener groups.
 - 13.1.5 The anthropogenic isolation column (Section 13.6) is used for removal of lipids from tissue samples.
- 13.2 Gel permeation chromatography (GPC).
 - 13.2.1 Column packing.
 - 13.2.1.1 Place 70 to 75 g of SX-3 Bio-beads (Section 6.7.1.1) in a 400- to 500-mL beaker.

Method 1668

- 13.2.1.2 Cover the beads with methylene chloride and allow to swell overnight (a minimum of 12 hours).
- 13.2.1.3 Transfer the swelled beads to the column (Section 6.7.1.1) and pump solvent through the column, from bottom to top, at 4.5 to 5.5 mL/minute prior to connecting the column to the detector.
- 13.2.1.4 After purging the column with solvent for 1 to 2 hours, adjust the column head pressure to 7 to 10 psig and purge for 4 to 5 hours to remove air. Maintain a head pressure of 7 to 10 psig. Connect the column to the detector (Section 6.7.1.4).
- 13.2.2 Column calibration.
 - 13.2.2.1 Load 5 mL of the calibration solution (Section 7.4) into the sample loop.
 - 13.2.2.2 Inject the calibration solution and record the signal from the detector. The elution pattern will be corn oil, PCB 209, pentachlorophenol, perylene, and sulfur.
 - 13.2.2.3 Set the "dump time" to allow >85% removal of the corn oil and >85% collection of PCB 209.
 - 13.2.2.4 Set the "collect time" to the peak minimum between perylene and sulfur.
 - 13.2.2.5 Verify the calibration with the calibration solution after every 20 extracts. Calibration is verified if the recovery of the pentachlorophenol is greater than 85%. If calibration is not verified, the system shall be recalibrated using the calibration solution, and the previous 20 samples shall be re-extracted and cleaned up using the calibrated GPC system.
- 13.2.3 Extract cleanup—GPC requires that the column not be overloaded. The column specified in this method is designed to handle a maximum of 0.5 g of high molecular weight material in a 5-mL extract. If the extract is known or expected to contain more than 0.5 g, the extract is split into aliquots for GPC, and the aliquots are combined after elution from the column. The residue content of the extract may be obtained gravimetrically by evaporating the solvent from a 50- μ L aliquot.
 - 13.2.3.1 Filter the extract or load through the filter holder (Section 6.7.1.3) to remove the particles. Load the 5.0-mL extract onto the column.
 - 13.2.3.2 Elute the extract using the calibration data determined in Section 13.2.2. Collect the eluate in a clean 400- to 500-mL beaker.
 - 13.2.3.3 Rinse the sample loading tube thoroughly with methylene chloride between extracts to prepare for the next sample.
 - 13.2.3.4 If a particularly dirty extract is encountered, a 5.0-mL methylene chloride blank shall be run through the system to check for carry-over.
 - 13.2.3.5 Concentrate the eluate per Section 12.6 and Section 12.7 for further cleanup or injection into the GC/MS.
- 13.3 Silica gel cleanup.
 - 13.3.1 Place a glass-wool plug in a 15-mm ID chromatography column (Section 6.7.4.2). Pack the column bottom to top with 1 g silica gel (Section 7.5.1.1), 4 g basic silica gel (Section 7.5.1.3), 1 g silica gel, 8 g acid silica gel (Section 7.5.1.2), 2 g silica gel, and 4 g granular anhydrous sodium sulfate (Section 7.2.1). Tap the column to settle the adsorbents.

-
- 13.3.2 Pre-elute the column with 50 to 100 mL of n-hexane. Close the stopcock when the n-hexane is within 1 mm of the sodium sulfate. Discard the eluate. Check the column for channeling. If channeling is present, discard the column and prepare another.
- 13.3.3 Apply the concentrated extract to the column. Open the stopcock until the extract is within 1 mm of the sodium sulfate.
- 13.3.4 Rinse the receiver twice with 1-mL portions of n-hexane, and apply separately to the column. Elute the PCBs with 25 mL of n-hexane and collect the eluate.
- 13.3.5 Concentrate the eluate per Section 12.6 and 12.7 for further cleanup or injection into the HPLC or GC/MS.
- 13.3.6 For extracts of samples known to contain large quantities of other organic compounds (such as paper mill effluents), it may be advisable to increase the capacity of the silica gel column. This may be accomplished by increasing the strengths of the acid and basic silica gels. The acid silica gel (Section 7.5.1.2) may be increased in strength to as much as 44% w/w (7.9 g sulfuric acid added to 10 g silica gel). The basic silica gel (Section 7.5.1.3) may be increased in strength to as much as 33% w/w (50 mL 1N NaOH added to 100 g silica gel), or the potassium silicate (Section 7.5.1.4) may be used.
-

Note: *The use of stronger acid silica gel (44% w/w) may lead to charring of organic compounds in some extracts. The charred material may retain some of the analytes and lead to lower recoveries of the PCBs. Increasing the strengths of the acid and basic silica gel may also require different volumes of n-hexane than those specified above to elute the analytes from the column. Therefore, the performance of the method after such modifications must be verified by the procedure in Section 9.2.*

13.4 Carbon column (Reference 16).

- 13.4.1 Cut both ends from a 50-mL disposable serological pipet (Section 6.7.3.2) to produce a 20-cm column. Fire-polish both ends and flare both ends if desired. Insert a glass-wool plug at one end, and pack the column with 3.6 g of Carbopak/Celite (Section 7.5.2.3) to form an adsorbent bed 20 cm long. Insert a glass-wool plug on top of the bed to hold the adsorbent in place.
- 13.4.2 Pre-elute the column with 20 mL each in succession of toluene, methylene chloride, and n-hexane.
- 13.4.3 When the solvent is within 1 mm of the column packing, apply the n-hexane sample extract to the column. Rinse the sample container twice with 1-mL portions of n-hexane and apply separately to the column. Apply 2 mL of n-hexane to complete the transfer.
- 13.4.4 Elute the column with 25 mL of n-hexane and collect the eluate. This fraction will contain the mono- and di-ortho PCBs. If carbon particles are present in the eluate, filter through glass-fiber filter paper.
- 13.4.5 Elute the column with 15 mL of methanol and discard the eluate. The fraction discarded will contain residual lipids and other potential interferents, if present.

Method 1668

- 13.4.6 Elute the column with 15 mL of toluene and collect the eluate. This fraction will contain PCBs 77, 126, and 169. If carbon particles are present in the eluate, filter through glass-fiber filter paper.
- 13.4.7 Concentrate the fractions per Section 12.6 and 12.7 for further cleanup or injection into the HPLC or GC/MS.
- 13.5 HPLC (Reference 17).
- 13.5.1 Column calibration.
- 13.5.1.1 Prepare a calibration standard containing the toxic congeners and other congeners of interest at a concentration of approximately TBD pg/ μ L in methylene chloride.
- 13.5.1.2 Inject 30 μ L of the calibration solution into the HPLC and record the signal from the detector. Collect the eluant for reuse. The elution order will be the mono- through deca- congeners.
- 13.5.1.3 Establish the collection time for the congeners of interest. Following calibration, flush the injection system with copious quantities of methylene chloride, including a minimum of five 50- μ L injections while the detector is monitored, to ensure that residual PCBs are removed from the system.
- 13.5.1.4 Verify the calibration with the calibration solution after every 20 extracts. Calibration is verified if the recovery of the PCBs from the calibration standard is 75 to 125% compared to the calibration (Section 13.5.1.1). If calibration is not verified, the system shall be recalibrated using the calibration solution, and the previous 20 samples shall be re-extracted and cleaned up using the calibrated system.
- 13.5.2 Extract cleanup—HPLC requires that the column not be overloaded. The column specified in this method is designed to handle a maximum of 30 μ L of extract. If the extract cannot be concentrated to less than 30 μ L, it is split into fractions and the fractions are combined after elution from the column.
- 13.5.2.1 Rinse the sides of the vial twice with 30 μ L of methylene chloride and reduce to 30 μ L with the evaporation apparatus (Section 6.8.3).
- 13.5.2.2 Inject the 30 μ L extract into the HPLC.
- 13.5.2.3 Elute the extract using the calibration data determined in Section 13.5.1. Collect the fraction(s) in a clean 20-mL concentrator tube containing 5 mL of n-hexane:acetone (1:1 v/v).
- 13.5.2.4 If an extract containing greater than TBD ng/mL of total PCBs is encountered, a 30- μ L methylene chloride blank shall be run through the system to check for carry-over.
- 13.5.2.5 Concentrate the eluate per Section 12.7 for injection into the GC/MS.
- 13.6 Anthropogenic isolation column (References 1-2)—Used for removal of lipids from tissue extracts.
- 13.6.1 Prepare the column as given in Section 7.5.3.
- 13.6.2 Pre-elute the column with 100 mL of n-hexane. Drain the n-hexane layer to the top of the column, but do not expose the sodium sulfate.

- 13.6.3** Load the sample and rinses (Section 12.4.9.2) onto the column by draining each portion to the top of the bed. Elute the PCBs from the column into the apparatus used for concentration (Section 12.4.7) using 200 mL of n-hexane.
- 13.6.4** Concentrate the cleaned up extract (Sections 12.6-12.7) to constant weight per Section 12.7.3.1. If more than 500 mg of material remains, repeat the cleanup using a fresh anthropogenic isolation column.
- 13.6.5** Redissolve the extract in a solvent suitable for the additional cleanups to be used (Section 13.2-13.5 and 13.7).
- 13.6.6** Spike 1.0 mL of the cleanup standard (Section 7.11) into the residue/solvent.
- 13.6.7** Clean up the extract using the procedures in Sections 13.2-13.5 and 13.7. Florisil (Section 13.7) and carbon (Section 13.4) are recommended as minimum additional cleanup steps.
- 13.6.8** Following cleanup, concentrate the extract to 10 μ L as described in Section 12.7 and proceed with the analysis in Section 14.
- 13.7** Florisil cleanup (Reference 18).
- 13.7.1** Begin to drain the n-hexane from the column (Section 7.5.4). Adjust the flow rate of eluant to 4.5-5.0 mL/min.
- 13.7.2** When the n-hexane is within 1 mm of the sodium sulfate, apply the sample extract (in n-hexane) to the column. Rinse the sample container twice with 1-mL portions of n-hexane and apply to the column.
- 13.7.3** Elute the mono-ortho and di-ortho PCBs with approximately 165 mL of n-hexane and collect the eluate. Elute the non-ortho co-planar PCBs with approximately 100 mL of 6% ether:n-hexane and collect the eluate. The exact volumes of solvents will need to be determined for each batch of Florisil. If the mono/di-ortho PCBs are not to be separated from the non-ortho co-planar PCBs, elute all PCBs with 6% ether:n-hexane.
- 13.7.4** Concentrate the eluate(s) per Sections 12.6-12.7 for further cleanup or for injection into the HPLC or GC/MS.

14.0 HRGC/HRMS Analysis

- 14.1** Establish the operating conditions given in Section 10.1.
- 14.2** Add 10 μ L of the appropriate internal standard solution (Section 7.12) to the sample extract immediately prior to injection to minimize the possibility of loss by evaporation, adsorption, or reaction. If an extract is to be reanalyzed and evaporation has occurred, do not add more instrument internal standard solution. Rather, bring the extract back to its previous volume (e.g., 19 μ L) with pure nonane only (18 μ L if 2 μ L injections are used).
- 14.3** Inject 1.0 or 2.0 μ L of the concentrated extract containing the internal standard solution, using on-column or splitless injection. The volume injected must be identical to the volume used for calibration (Section 10). Start the GC column initial isothermal hold upon injection. Start MS data collection after the solvent peak elutes. Stop data collection after the $^{13}\text{C}_{12}$ -PCB 209 has eluted. If PCBs 77, 126, and 169 only are to be determined, stop data collection after $^{13}\text{C}_{12}$ -PCB 169 has eluted. Return the column to the initial temperature for analysis of the next extract or standard.

15.0 System and Laboratory Performance

- 15.1 At the beginning of each 12-hour shift during which analyses are performed, GC/MS system performance and calibration are verified for all native PCBs and labeled compounds. For these tests, analysis of the CS3 calibration verification (VER) standard (Section 7.13 and Table 4) and the congener specificity test standards (Section 7.15 and Table 5) shall be used to verify all performance criteria. Adjustment and/or recalibration (Section 10) shall be performed until all performance criteria are met. Only after all performance criteria are met may samples, blanks, IPRs, and OPRs be analyzed.
- 15.2 MS resolution—A static resolving power of at least 10,000 (10% valley definition) must be demonstrated at the appropriate m/z before any analysis is performed. Static resolving power checks must be performed at the beginning and at the end of each 12-hour shift according to procedures in Section 10.1.2. Corrective actions must be implemented whenever the resolving power does not meet the requirement.
- 15.3 Calibration verification.
- 15.3.1 Inject the VER standard using the procedure in Section 14.
- 15.3.2 The m/z abundance ratios for all PCBs shall be within the limits in Table 9; otherwise, the mass spectrometer shall be adjusted until the m/z abundance ratios fall within the limits specified, and the verification test shall be repeated. If the adjustment alters the resolution of the mass spectrometer, resolution shall be verified (Section 10.1.2) prior to repeat of the verification test.
- 15.3.3 The peaks representing each native PCB and labeled compound in the VER standard must be present with a S/N of at least 10; otherwise, the mass spectrometer shall be adjusted and the verification test repeated.
- 15.3.4 Compute the concentration of each native PCB compound by isotope dilution (Section 17.1) for those compounds that have labeled analogs (Table 1). Compute the concentration of each native compound that does not have a labeled analog and of each labeled compound by the internal standard method (Section 17.2). These concentrations are computed based on the calibration data in Section 10.
- 15.3.5 For each compound, compare the concentration with the calibration verification limit in Table 6. If PCBs 77, 126, and 169 only are to be determined, compare the concentration to the limit in Table 6a. If all compounds meet the acceptance criteria, calibration has been verified and analysis of standards and sample extracts may proceed. If, however, any compound fails its respective limit, the measurement system is not performing properly for that compound. In this event, prepare a fresh calibration standard or correct the problem causing the failure and repeat the resolution (Section 15.2) and verification (Section 15.3) tests, or recalibrate (Section 10).
- 15.4 Retention times and GC resolution.
- 15.4.1 Retention times.
- 15.4.1.1 Absolute—The absolute retention times of the GC/MS internal standards in the verification test (Section 15.3) shall be within ± 15 seconds of the retention times obtained during calibration (Section 10.2.4).

- 15.4.1.2** Relative—The relative retention times of native PCBs and labeled compounds in the verification test (Section 15.3) shall be within 5 percent of the relative retention times given in Table 2.
- 15.4.2** GC resolution.
- 15.4.2.1** Inject the isomer specificity standards (Section 7.15) on their respective columns.
- 15.4.2.2** The valley height between PCBs 123 and 118 at m/z 325.8804 shall not exceed 10 percent on the SPB-Octyl column, and the valley height between PCBs 156 and 157 shall not exceed 10 percent at m/z 359.8415 on the DB-1 column (Figures 6 and 7).
- 15.4.3** If the absolute retention time of any compound is not within the limits specified or if the congeners are not resolved, the GC is not performing properly. In this event, adjust the GC and repeat the verification test (Section 15.3) or recalibrate (Section 10), or replace the GC column and either verify calibration or recalibrate.
- 15.5** Ongoing precision and recovery.
- 15.5.1** Analyze the extract of the ongoing precision and recovery (OPR) aliquot (Section 11.4.2.5, 11.5.4, 11.6.2, 11.7.4, or 11.8.3.2) prior to analysis of samples from the same batch.
- 15.5.2** Compute the concentration of each native PCB by isotope dilution for those compounds that have labeled analogs (Section 17.1). Compute the concentration of the native PCBs that have no labeled analog and each labeled compound by the internal standard method (Section 17.2).
- 15.5.3** For each PCB and labeled compound, compare the concentration to the OPR limits given in Table 6. If PCBs 77, 126, and 169 only are to be determined, compare the concentration to the limits in Table 6a. If all compounds meet the acceptance criteria, system performance is acceptable and analysis of blanks and samples may proceed. If, however, any individual concentration falls outside of the range given, the extraction/concentration processes are not being performed properly for that compound. In this event, correct the problem, re-prepare, extract, and clean up the sample batch and repeat the ongoing precision and recovery test (Section 15.5).
- 15.5.4** Add results that pass the specifications in Section 15.5.3 to initial and previous ongoing data for each compound in each matrix. Update QC charts to form a graphic representation of continued laboratory performance. Develop a statement of laboratory accuracy for each congener in each matrix type by calculating the average percent recovery (R) and the standard deviation of percent recovery (S_R). Express the accuracy as a recovery interval from $R - 2S_R$ to $R + 2S_R$. For example, if $R = 95\%$ and $S_R = 5\%$, the accuracy is 85 to 105%.
- 15.6** Blank—Analyze the method blank extracted with each sample batch immediately following analysis of the OPR aliquot to demonstrate freedom from contamination and freedom from carryover from the OPR analysis. The results of the analysis of the blank must meet the specifications in Section 9.5.2 before sample analyses may proceed.

16.0 Qualitative Determination

A PCB or labeled compound is identified in a standard, blank, or sample when all of the criteria in Sections 16.1 through 16.4 are met.

- 16.1 The signals for the two exact m/z 's in Table 8 must be present and must maximize within the same two seconds.
- 16.2 The signal-to-noise ratio (S/N) for the GC peak at each exact m/z must be greater than or equal to 2.5 for each PCB detected in a sample extract, and greater than or equal to 10 for all PCBs in the calibration standard (Sections 10.2.3 and 15.3.3).
- 16.3 The ratio of the integrated areas of the two exact m/z 's specified in Table 8 must be within the limit in Table 9, or within ± 10 percent of the ratio in the midpoint (CS3) calibration or calibration verification (VER), whichever is most recent.
- 16.4 The relative retention time of the peak for a toxic PCB must be within 5 percent of the relative retention times listed in Table 2. The retention time of peaks representing PCBs other than the toxic PCBs must be within the retention time windows established in Section 10.3.
- 16.5 Confirmatory analysis—Isomer specificity for PCBs 156 and 157 cannot be achieved on the SPB-Octyl column. Therefore, any sample in which these PCBs are tentatively identified by analysis on the SPB-Octyl column and when rigorous identification is required must have a confirmatory analysis performed on a DB-1 or equivalent GC column. The operating conditions in Section 10.1.1 may be adjusted to optimize the analysis on the second GC column, but the GC/MS must meet the mass resolution and calibration specifications in Section 10.
- 16.6 If the criteria for identification in Sections 16.1-16.5 are not met, the PCB has not been identified and the results may not be reported for regulatory compliance purposes. If interferences preclude identification, a new aliquot of sample must be extracted, further cleaned up, and analyzed.

17.0 Quantitative Determination

- 17.1 Isotope dilution quantitation—By adding a known amount of a labeled compound to every sample prior to extraction, correction for recovery of the PCB can be made because the native compound and its labeled analog exhibit similar effects upon extraction, concentration, and gas chromatography. Relative response (RR) values are used in conjunction with the initial calibration data described in Section 10.5 to determine concentrations directly, so long as labeled compound spiking levels are constant, using the following equation:

$$C_{ex} \text{ (ng/mL)} = \frac{(A1_n + A2_n) C_l}{(A1_l + A2_l) RR}$$

where:

C_{ex} = The concentration of the PCB in the extract.

The other terms are as defined in Section 10.5.2

Any peaks representing the other congeners are quantitated using an average of the response factors from all of the labeled PCBs isomers at the same level of chlorination.

17.2 Internal standard quantitation and labeled compound recovery.

- 17.2.1** Compute the concentrations of labeled analogs (including the cleanup standard) in the extract using the response factors determined from the initial calibration data (Section 10.6) and the following equation:

$$C_{ex} \text{ (ng/mL)} = \frac{(A1_s + A2_s) C_{is}}{(A1_{is} + A2_{is}) RF}$$

where:

C_{ex} = The concentration of the labeled compound in the extract.

The other terms are as defined in Section 10.6.1

- 17.2.2** Using the concentration in the extract determined above, compute the percent recovery of the labeled compounds (including the cleanup standard) using the following equation:

$$\text{Recovery (\%)} = \frac{\text{Concentration found } (\mu\text{g/mL})}{\text{Concentration spiked } (\mu\text{g/mL})} \times 100$$

- 17.3** The concentration of a native PCB in the solid phase of the sample is computed using the concentration of the compound in the extract and the weight of the solids (Section 11.2.2.3), as follows:

$$\text{Concentration in solid (ng/kg)} = \frac{(C_{ex} \times V_{ex})}{W_s}$$

where:

C_{ex} = The concentration of the compound in the extract.

V_{ex} = The extract volume in mL.

W_s = The sample weight (dry weight) in kg.

- 17.4** The concentration of a native PCB in the aqueous phase of the sample is computed using the concentration of the compound in the extract and the volume of water extracted (Section 11.4), as follows:

$$\text{Concentration in aqueous phase (pg/L)} = \frac{(C_{ex} \times V_{ex})}{V_s}$$

where:

C_{ex} = The concentration of the compound in the extract.

V_{ex} = The extract volume in mL.

V_s = The sample volume in liters.

Method 1668

- 17.5 If the SICP area at either quantitation m/z for any compound exceeds the calibration range of the system, a smaller sample aliquot is extracted.
- 17.5.1 For aqueous samples containing 1% solids or less, dilute 100 mL, 10 mL, etc., of sample to 1 L with reagent water and re-prepare, extract, clean up, and analyze per Sections 11 - 14.
- 17.5.2 For samples containing greater than 1% solids, extract an amount of sample equal to 1/10, 1/100, etc., of the amount used in Section 11.5.1. Re-prepare, extract, clean up, and analyze per Sections 11-14.
- 17.5.3 If a smaller sample size will not be representative of the entire sample, dilute the sample extract by a factor of 10, adjust the concentration of the instrument internal standard to 100 pg/ μ L in the extract, and analyze an aliquot of this diluted extract by the internal standard method.
- 17.6 Results are reported to three significant figures for the PCBs and labeled compounds found in all standards, blanks, and samples.
- 17.6.1 Reporting units and levels.
- 17.6.1.1 Aqueous samples—Report results in pg/L (parts-per-quadrillion).
- 17.6.1.2 Samples containing greater than 1% solids (soils, sediments, filter cake, compost)—Report results in ng/kg based on the dry weight of the sample. Report the percent solids so that the result may be corrected.
- 17.6.1.3 Tissues—Report results in ng/kg of wet tissue, not on the basis of the lipid content of the sample. Report the percent lipid content, so that the data user can calculate the concentration on a lipid basis if desired.
- 17.6.1.4 Reporting level.
- 17.6.1.4.1 Standards (VER, IPR, OPR) and samples—Report results at or above the minimum level (Table 2). Report results below the minimum level as not detected or as required by the regulatory authority.
- 17.6.1.4.2 Blanks—Report results above the MDL or as required by the regulatory authority. Do not blank-correct results. If a blank accompanying a sample result shows contamination above the MDL for the congener, flag the sample result and report the results for the sample and the accompanying blank.
- 17.6.2 Results for PCBs in samples that have been diluted are reported at the least dilute level at which the areas at the quantitation m/z 's are within the calibration range (Section 17.5).
- 17.6.3 For PCBs having a labeled analog, results are reported at the least dilute level at which the area at the quantitation m/z is within the calibration range (Section 17.5) and the labeled compound recovery is within the normal range for the method (Section 9.3 and Tables 6, 6a, 7, and 7a).
- 17.6.4 Additionally, if requested, the total concentration of all congeners at a given level of chlorination (i.e., total TCB, total PeCB, total HxCB, etc.) may be reported by summing the concentrations of all congeners identified in that level of chlorination, including both the toxic and other congeners.

18.0 Analysis of Complex Samples

- 18.1 Some samples may contain high levels (>10 ng/L; >1000 ng/kg) of the compounds of interest, interfering compounds, and/or polymeric materials. Some extracts will not concentrate to 10 μ L (Section 12.7); others may overload the GC column and/or mass spectrometer.
- 18.2 Analyze a smaller aliquot of the sample (Section 17.5) when the extract will not concentrate to 10 μ L after all cleanup procedures have been exhausted.
- 18.3 Several laboratories have reported that elimination of several of the toxic PCBs, particularly non-coplanar congeners 105, 114, 118, 123, 156, 157, and 167 is difficult. Backgrounds of these congeners can therefore interfere with the determination of these congeners in environmental samples. Care should therefore be exercised in the determination of these congeners.
- 18.4 Recovery of labeled compounds—In most samples, recoveries of the labeled compounds will be similar to those from reagent water or from the alternate matrix (Section 7.6).
 - 18.4.1 If the recovery of any of the labeled compounds is outside of the normal range (Table 7), a diluted sample shall be analyzed (Section 17.5).
 - 18.4.2 If the recovery of any of the labeled compounds in the diluted sample is outside of normal range, the calibration verification standard (Section 7.13) shall be analyzed and calibration verified (Section 15.3).
 - 18.4.3 If the calibration cannot be verified, a new calibration must be performed and the original sample extract reanalyzed.
 - 18.4.4 If the calibration is verified and the diluted sample does not meet the limits for labeled compound recovery, the method does not apply to the sample being analyzed and the result may not be reported for regulatory compliance purposes. In this case, alternate extraction and cleanup procedures in this method must be employed to resolve the interference. If all cleanup procedures in this method have been employed and labeled compound recovery remains outside of the normal range, extraction and/or cleanup procedures that are beyond this scope of this method will be required to analyze these samples.

19.0 Method Performance

For this draft version of Method 1668, performance was validated and preliminary data were collected in a single laboratory.

20.0 Pollution Prevention

- 20.1 The solvents used in this method pose little threat to the environment when managed properly. The solvent evaporation techniques used in this method are amenable to solvent recovery, and it is recommended that the laboratory recover solvents wherever feasible.
- 20.2 Standards should be prepared in volumes consistent with laboratory use to minimize disposal of standards.

*Method 1668***21.0 Waste Management**

- 21.1 It is the laboratory's responsibility to comply with all federal, state, and local regulations governing waste management, particularly the hazardous waste identification rules and land disposal restrictions, and to protect the air, water, and land by minimizing and controlling all releases from fume hoods and bench operations. Compliance is also required with any sewage discharge permits and regulations.
- 21.2 Samples containing HCl or H₂SO₄ to pH <2 are hazardous and must be neutralized before being poured down a drain or must be handled as hazardous waste.
- 21.3 The PCBs decompose above 800°C. Low-level waste such as absorbent paper, tissues, animal remains, and plastic gloves may be burned in an appropriate incinerator. Gross quantities (milligrams) should be packaged securely and disposed of through commercial or governmental channels that are capable of handling extremely toxic wastes.
- 21.4 [This section may need to be modified to accommodate the PCBs: Liquid or soluble waste should be dissolved in methanol or ethanol and irradiated with ultraviolet light with a wavelength shorter than 290 nm for several days. Use F40 BL or equivalent lamps. Analyze liquid wastes, and dispose of the solutions when the PCBs can no longer be detected.]
- 21.5 For further information on waste management, consult "The Waste Management Manual for Laboratory Personnel" and "Less is Better—Laboratory Chemical Management for Waste Reduction," available from the American Chemical Society's Department of Government Relations and Science Policy, 1155 16th Street N.W., Washington, D.C. 20036.

22.0 References

- 1 Kuehl, D.W., B.C. Butterworth, J. Libal, and P. Marquis, "An Isotope Dilution High Resolution Gas Chromatographic-High Resolution Mass Spectrometric Method for the Determination of Coplanar Polychlorinated Biphenyls: Application to Fish and Marine Mammals," *Chemosphere* 22:9-10, 849-858, 1991.
- 2 Feltz, Kevin P., Donald E. Tillitt, Robert W. Gale, Paul H. Peterman, *Environ. Sci. Tech.* TBD.
- 3 "Analysis of Coplanar PCBs," Axys Environmental Systems Ltd., Fax from Mary McFarland to Dale Rushneck dated November 25, 1994, available from the EPA Sample Control Center, operated by DynCorp I&ET, 300 N. Lee St, Alexandria, VA 22314.
- 4 Ahlborg, U.G., G.C. Becking, L.S. Birnbaum, A. Brouwer, H.J.G.M. Derks, M. Feeley, G. Golor, A. Hanberg, J.C. Larsen, A.K.D. Liem, S.H. Safe, C. Schlatter, F. Waern, M. Younes, and E. Yrjänheikki, "Toxic Equivalency Factors for Dioxin-like PCBs," *Chemosphere* 28:6, 1049-1067, 1994.
- 5 "Working with Carcinogens," Department of Health, Education, & Welfare, Public Health Service, Centers for Disease Control, NIOSH, Publication 77-206, August 1977, NTIS PB-277256.
- 6 "OSHA Safety and Health Standards, General Industry," OSHA 2206, 29 CFR 1910.
- 7 "Safety in Academic Chemistry Laboratories," ACS Committee on Chemical Safety, 1979.

- 8 "Standard Methods for the Examination of Water and Wastewater," 18th edition and later revisions, American Public Health Association, 1015 15th St, N.W., Washington, DC 20005, 1-35: Section 1090 (Safety), 1992.
- 9 "Method 613—2,3,7,8-Tetrachlorodibenzo-*p*-dioxin," 40 *CFR* 136 (49 *FR* 43234), October 26, 1984, Section 4.1.
- 10 Lamparski, L.L., and Nestruck, T.J., "Novel Extraction Device for the Determination of Chlorinated Dibenzo-*p*-dioxins (PCDDs) and Dibenzofurans (PCDFs) in Matrices Containing Water," *Chemosphere*, 19:27-31, 1989.
- 11 Provost, L.P., and Elder, R.S., "Interpretation of Percent Recovery Data," *American Laboratory*, 15: 56-83, 1983.
- 12 "Standard Practice for Sampling Water," ASTM Annual Book of Standards, ASTM, 1916 Race Street, Philadelphia, PA 19103-1187, 1980.
- 13 "Methods 330.4 and 330.5 for Total Residual Chlorine," USEPA, EMSL, Cincinnati, OH 45268, EPA 600/4-70-020, March 1979.
- 14 "Handbook of Analytical Quality Control in Water and Wastewater Laboratories," USEPA EMSL, Cincinnati, OH 45268, EPA-600/4-79-019, March 1979.
- 15 "Analytical Procedures and Quality Assurance Plan for the Determination of PCDD/PCDF in Fish", U.S. Environmental Protection Agency, Environmental Research Laboratory, Duluth MN 55804, EPA/600/3-90/022, March 1990.
- 16 Storr-Hansen, E. and T. Cederberg, "Determination of Coplanar Polychlorinated Biphenyl (CB) Congeners in Seal Tissues by Chromatography on Active Carbon, Dual-Column High Resolution GC/ECD and High Resolution GC/High Resolution MS" *Chemosphere* 24:9, 1181-1196, 1992.
- 17 Workman, S.M., TBD [or Peterman in Reference 2]
- 18 Tessari, J.D., Personal communication with Dale Rushneck, available from the EPA Sample Control Center, operated by DynCorp I&ET, 300 N. Lee St., Alexandria, VA 22314 (703-519-1140).

Method 1668

23.0 Tables and Figures

Table 1. Toxic Polychlorinated Biphenyls Determined by Isotope Dilution and Internal Standard High Resolution Gas Chromatography (HRGC)/High Resolution Mass Spectrometry (HRMS)

PCB ¹	Native compound CAS Registry No.	IUPAC No.	¹³ C ₁₂ analog CAS Registry No.
3,3',4,4'-TCB	32598-13-3	77	160901-67-7
2,3,3',4,4'-PeCB	32598-14-4	105	160901-70-2
2,3,4,4',5-PeCB	74472-37-0	114	160901-72-4
2,3',4,4',5-PeCB	31508-00-6	118	160901-73-5
2',3,4,4',5-PeCB	65510-44-3	123	160901-74-6
3,3',4,4',5-PeCB	57465-28-8	126	160901-75-7
2,3,3',4,4',5-HxCB	38380-08-4	156	160901-77-9
2,3,3',4,4',5'-HxCB	69782-90-7	157	160901-78-0
2,3',4,4',5,5'-HxCB	52663-72-6	167	161627-18-5
3,3',4,4',5,5'-HxCB	32774-16-6	169	160901-79-1
2,2',3,3',4,4',5-HpCB	35065-30-6	170	160901-80-4
2,2',3,4,4',5,5'-HpCB	35065-29-3	180	160901-82-6
2,3,3',4,4',5,5'-HpCB	39635-31-9	189	160901-83-7
Cleanup standards			
¹³ C ₁₂ -3,4,4',5-TCB		81	160901-68-8
¹³ C ₁₂ -2,3,3',5,5'-PeCB		111	160901-71-3
Internal standards			
¹³ C ₁₂ -2,2',5,5'-TCB		52	160901-66-6
¹³ C ₁₂ -2,2',4,4,5'-PeCB		101	160901-69-9
¹³ C ₁₂ -2,2',3,4,4',5'-HxCB		138	160901-76-8
¹³ C ₁₂ -2,2',3,3',5,5',6-HpCB		178	160901-81-5
Final eluter standard			
¹³ C ₁₂ -DCB		209	160901-84-8

¹ Polychlorinated biphenyls:

TCB	=	Tetrachlorobiphenyl
PeCB	=	Pentachlorobiphenyl
HxCB	=	Hexachlorobiphenyl
HpCB	=	Heptachlorobiphenyl
DCB	=	Decachlorobiphenyl

Table 2. Retention Time (RT) References, Quantitation References, Relative Retention Times (RRTs), Estimated Method Detection Limits (EMDLs), and Estimated Minimum Levels (EMLs) for the Toxic PCBs^a

IUPAC ¹ No.	Labeled or native PCB	IUPAC ¹ No.	Retention time and quantitation reference	RT (min) ²	RRT	Matrix and Concentration							
						Water (pg/l)	EMDL	EML	Other (ng/Kg)	EMDL	EML	Extract (pg/ul)	EML
52L	13C12-2,2',5,5'-TCB	52L	13C12-2,2',5,5'-TCB	12.87	1.000								
81L	13C12-3,4,4',5'-TCB ⁴	52L	13C12-2,2',5,5'-TCB	19.65	1.527								
77L	13C12-3,3',4,4'-TCB	52L	13C12-2,2',5,5'-TCB	20.15	1.566								
77	3,3',4,4'-TCB	77L	13C12-3,3',4,4'-TCB	20.18	1.002	5	20	0.5	2	1			
Penta congeners using 13C12-2,2',4,4',5,5'-PeCB (#101L) as the injection internal standard													
101L	13C12-2,2',4,5,5'-PeCB	101L	13C12-2,2',4,5,5'-PeCB	17.83	1.000								
111L	13C12-2,3,3',5,5'-PeCB ⁴	101L	13C12-2,2',4,5,5'-PeCB	20.12	1.128								
123	2,3,4,4',5-PeCB	118L	13C12-2,3',4,4',5-PeCB	21.98	0.987	40	100	4	10	5			
118L	13C12-2,3',4,4',5-PeCB	101L	13C12-2,2',4,5,5'-PeCB	22.27	1.249								
118	2,3',4,4',5-PeCB	118L	13C12-2,3',4,4',5-PeCB	22.30	1.001	60	200	6	20	10			
114	2,3,4,4',5-PeCB	105L	13C12-2,3,3',4,4',5-PeCB	22.82	0.974	600	2000	60	200	100			
105L	13C12-2,3,3',4,4',5-PeCB	101L	13C12-2,2',4,5,5'-PeCB	23.42	1.313								
105	2,3,3',4,4'-PeCB	105L	13C12-2,3,3',4,4',5-PeCB	23.43	1.000	400	1000	40	100	50			
126L	13C12-3,3',4,4',5-PeCB	101L	13C12-2,2',4,5,5'-PeCB	26.55	1.489								
126	3,3',4,4',5-PeCB	126L	13C12-3,3',4,4',5-PeCB	26.56	1.000	40	100	10	4	5			
Hexa congeners using 13C12-2,2',3,4,4',5'-HxCB (#138L) as the injection internal standard													
138L	13C12-2,2',3,4,4',5'-HxCB	101L	13C12-2,2',4,5,5'-PeCB	25.35	1.422								
167L	13C12-2,3',4,4',5'-HxCB	138L	13C12-2,2',3,4,4',5'-HxCB	28.50	1.124								
167	2,3',4,4',5'-HxCB	167L	13C12-2,3',4,4',5,5'-HxCB	28.52	1.001	60	200	6	20	10			
156L	13C12-2,3,3',4,4',5'-HxCB	138L	13C12-2,2',3,4,4',5'-HxCB	29.77	1.174								
157L	13C12-2,3,3',4,4',5'-HxCB	138L	13C12-2,2',3,4,4',5'-HxCB	29.77	1.174								
156	2,3,3',4,4',5'-HxCB	156L	13C12-2,3,3',4,4',5'-HxCB	29.80	1.001	60	200	6	20	10			
157	2,3,3',4,4',5'-HxCB	157L	13C12-2,3,3',4,4',5'-HxCB	29.80	1.001	60	200	6	20	10			
169L	13C12-3,3',4,4',5,5'-HxCB	138L	13C12-2,2',3,4,4',5'-HxCB	33.38	1.317								
169	3,3',4,4',5,5'-HxCB	169L	13C12-3,3',4,4',5,5'-HxCB	33.42	1.001	60	200	6	20	10			

^aContinued on next page

Table 2. (cont.) Retention Time (RT) References, Quantitation References, Relative Retention Times (RRTs), Estimated Method Detection Limits (EMDLs), and Estimated Minimum Levels (EMLs) for the Toxic PCBs

IUPAC ¹ No.	Labeled or native PCB	IUPAC ¹ No.	Retention time and quantitation reference	RT (min) ²	RRT	Matrix and Concentration		
						Water (pg/l)	Other (ng/kg)	Extract (pg/l)
Hepta and deca congeners using 13C12-2,2',3,3',5,5',6-HpCB (#178L) as the injection internal standard								
178L	13C12-2,2',3,3',5,5',6-HpCB	101L	13C12-2,2',4,5,5',6-PeCB	25.78	1.446			
180L	13C12-2,2',3,4,4',5,5'-HpCB	178L	13C12-2,2',3,3',5,5',6-HpCB	31.30	1.214			
180	2,2',3,4,4',5,5'-HpCB	180L	13C12-2,2',3,4,4',5,5'-HpCB	31.32	1.001	60	200	6
170	2,2',3,3',4,4',5-HpCB	180L	13C12-2,2',3,4,4',5,5'-HpCB	32.75	1.046	60	200	6
189L	13C12-2,3,3',4,4',5,5'-HpCB	178L	13C12-2,2',3,3',5,5',6-HpCB	36.32	1.409			
189	2,3,3',4,4',5,5'-HpCB	189L	13C12-2,3,3',4,4',5,5'-HpCB	36.35	1.001	60	200	6
209L	13C12-DCB ⁵	178L	13C12-2,2',3,3',5,5',6-HpCB	43.48	1.687			20

¹ Suffix "L" indicates labeled compound
² Retention time data are for SPB-octyl column sorted in ascending retention time order within each congener group
³ Some EMDLs and EMLs have been set above the lowest calibration point (Table 4) because backgrounds of these particular congeners are difficult to eliminate from laboratory analytical systems
⁴ Cleanup standard
⁵ Final eluter

Table 3. Concentrations of Stock and Spiking Solutions Containing the Native PCBs and Labeled Compounds

PCB congener	IUPAC No.	Labeled compound		Precision and Recovery	
		Stock ¹ (ng/mL)	Spiking ² (ng/mL)	Stock ³ (ng/mL)	Spiking ⁴ (ng/mL)
3,3',4,4'-TCB	77	-	-	220	0.4
2,3,3',4,4'-PeCB	105	-	-	1000	20.0
2,3,4,4',5-PeCB	114	-	-	1000	20.0
2,3',4,4',5-PeCB	118	-	-	1000	20.0
2',3,4,4',5-PeCB	123	-	-	1000	20.0
3,3',4,4',5-PeCB	126	-	-	100	2.0
2,3,3',4,4',5-HxCB	156	-	-	1000	20.0
2,3,3',4,4',5'-HxCB	157	-	-	1000	20.0
2,3',4,4',5,5'-HxCB	167	-	-	1000	20.0
3,3',4,4',5,5'-HxCB	169	-	-	200	4.0
2,2',3,3',4,4',5-HpCB	170	-	-	200	4.0
2,2',3,4,4',5,5'-HpCB	180	-	-	1000	20.0
2,3,3',4,4',5,5'-HpCB	189	-	-	200	4.0
13C12-3,3',4,4'-TCB	77L	1000	2.0	-	-
13C12-2,3,3',4,4'-PeCB	105L	1000	2.0	-	-
13C12-2,3',4,4',5-PeCB	118L	1000	2.0	-	-
13C12-3,3',4,4',5-PeCB	126L	1000	2.0	-	-
13C12-2,3,3',4,4',5-HxCB	156L	1000	2.0	-	-
13C12-2,3,3',4,4',5'-HxCB	157L	1000	2.0	-	-
13C12-2,3',4,4',5,5'-HxCB	167L	1000	2.0	-	-
13C12-3,3',4,4',5,5'-HxCB	169L	1000	2.0	-	-
13C12-2,2',3,4,4',5,5'-HpCB	180L	1000	2.0	-	-
13C12-2,3,3',4,4',5,5'-HpCB	189L	1000	2.0	-	-
13C12-DCB	209L	2000	4.0	-	-
Cleanup standards⁵					
13C12-3,4,4',5-TCB	81L	200	1.0	-	-
13C12-2,3,3',5,5'-PeCB	111L	1000	5.0	-	-
Internal standards⁶					
13C12-2,2',5,5'-TCB	52L	1000	-	-	-
13C12-2,2',4,5,5'-PeCB	101L	1000	-	-	-
13C12-2,2',3,4,4',5'-HxCB	138L	1000	-	-	-
13C12-2,2',3,3',5,5',6-HpCB	178L	1000	-	-	-

¹ Section 7.10-prepared in nonane and diluted to prepare spiking solution

² Section 7.10.3-prepared in acetone from stock solution daily

³ Section 7.9-prepared in nonane and diluted to prepare spiking solution. Concentrations are adjusted for expected background levels.

⁴ Section 7.14-prepared in acetone from stock solution daily. Concentrations are adjusted for expected background levels.

⁵ Section 7.11-prepared in nonane and added to extract prior to cleanup

⁶ Section 7.12-prepared in nonane and added to concentrated extract prior to injection

Table 4. Concentrations of PCBs in Calibration and Calibration Verification Solutions

Toxic PCB congener	IUPAC ¹ No.	CS1 (ng/mL)	CS2 (ng/mL)	CS3 ² (ng/mL)	CS4 (ng/mL)	CS5 (ng/mL)
3,3',4,4'-TCB	77	0.5	2	10	40	200
2,3,3',4,4'-PeCB	105	2.5	10	50	200	1000
2,3,4,4',5-PeCB	114	2.5	10	50	200	1000
2,3',4,4',5-PeCB	118	2.5	10	50	200	1000
2',3,4,4',5-PeCB	123	2.5	10	50	200	1000
3,3',4,4',5-PeCB	126	2.5	10	50	200	1000
2,3,3',4,4',5-HxCB	156	5	20	100	400	2000
2,3,3',4,4',5'-HxCB	157	5	20	100	400	2000
2,3',4,4',5,5'-HxCB	167	5	20	100	400	2000
3,3',4,4',5,5'-HxCB	169	5	20	100	400	2000
2,2',3,3',4,4',5-HpCB	170	5	20	100	400	2000
2,2',3,4,4',5,5'-HpCB	180	5	20	100	400	2000
2,3,3',4,4',5,5'-HpCB	189	5	20	100	400	2000
<i>Labeled congener</i>						
13C12-3,3',4,4'-TCB	77L	100	100	100	100	100
13C12-2,3,3',4,4'-PeCB	105L	100	100	100	100	100
13C12-2,3',4,4',5-PeCB	118L	100	100	100	100	100
13C12-3,3',4,4',5-PeCB	126L	100	100	100	100	100
13C12-2,3,3',4,4',5-HxCB	156L	100	100	100	100	100
13C12-2,3,3',4,4',5'-HxCB	157L	100	100	100	100	100
13C12-3,3',4,4',5,5'-HxCB	169L	100	100	100	100	100
13C12-2,2',3,4,4',5,5'-HpCB	180L	100	100	100	100	100
13C12-2,3,3',4,4',5,5'-HpCB	189L	100	100	100	100	100
13C12-DCB	209L	200	200	200	200	200
<i>Cleanup standards</i>						
13C12-3,4,4',5-TCB	81L	0.5	2	10	40	200
13C12-2,3,3',5,5'-PeCB	111L	2.5	10	50	200	1000
<i>Internal standards</i>						
13C12-2,2',5,5'-TCB	52L	100	100	100	100	100
13C12-2,2',4,5,5'-PeCB	101L	100	100	100	100	100
13C12-2,2',3,4,4',5'-HxCB	138L	100	100	100	100	100
13C12-2,2',3,3',5,5',6-HpCB	178L	100	100	100	100	100

¹ Suffix "L" indicates labeled compound² Section 15.3, calibration verification solution

Table 5. GC Retention Time Window Defining Solution and Congener Specificity Test Standard^{1,2}
(Section 7.15)

Congener Group	First eluted ³		Last eluted	
	Retention Time	Substituents	Retention Time	Substituents
TCB	54	2,2',6,6'	77	3,3',4,4'
PeCB	104	2,2',4,6,6'	126	3,3',4,4',5
HxCB	155	2,2',4,4',6,6'	169	3,3',4,4',5,5'
HpCB	188	2,2',3,4',5,6,6'	189	2,3,3',4,4',5,5'

SPB-Octyl resolution test compounds

123	2',3,4,4',5-PeCB
118	2,3',4,4',5-PeCB
114	2,3,4,4',5-PeCB

DB-1 column resolution test compounds

156	2,3,3',4,4',5-HxCB
157	2,3,3',4,4',5'-HxCB

¹ All compounds are at a concentration of 100 ng/mL in nonane.

² It is not necessary to monitor for the earliest eluted compounds if the toxic PCBs only are to be determined. If the co-planar PCBs (77, 126, 169) only are to be determined, it is necessary to resolve these co-planar PCBs and potentially interfering compounds only; i.e., use of the compounds listed in this Table is not required.

³ The earliest eluted compound in each congener group is provided for those instances in which all PCBs in that congener group are to be determined. If the toxic PCBs only (Table 1) are to be determined, use of the first eluted compounds is not required.

Table 6. Preliminary Acceptance Criteria for Performance Tests When All Toxic PCBs are Tested¹

Congener	IUPAC No.	Test (ng/mL)	IPR		OPR (ng/mL)	VER (ng/mL)
			s ² (ng/mL)	X ³ (ng/mL)		
3,3',4,4'-TCB	77	20	5.6	16-26	14-32	16-26
2,3,3',4,4'-PeCB	105	1000	172	720-1500	680-1600	780-1300
2,3,4,4',5'-PeCB	114	1000	390	160-2800	130-3300	770-1300
2,3',4,4',5'-PeCB	118	1000	172	720-1500	680-1600	780-1300
2',3,4,4',5'-PeCB	123	1000	390	160-2800	130-3300	770-1300
3,3',4,4',5'-PeCB	126	100	17	72-150	68-160	78-130
2,3,3',4,4',5'-HxCB	156	1000	222	740-1600	640-1700	780-1300
2,3,3',4,4',5'-HxCB	157	1000	222	740-1600	640-1700	780-1300
2,3',4,4',5,5'-HxCB	167	1000	222	740-1600	640-1700	780-1300
3,3',4,4',5,5'-HxCB	169	200	45	148-320	128-340	156-260
2,2',3,3',4,4',5'-HpCB	170	200	33	152-260	140-280	172-232
2,2',3,4,4',5,5'-HpCB	180	1000	165	760-1300	700-1400	860-1160
2,3,3',4,4',5,5'-HpCB	189	200	33	152-260	140-280	172-232
13C12-3,3',4,4'-TCB	77L	100	37	28-134	20-175	71-140
13C12-2,3,3',4,4'-PeCB	105L	100	39	16-279	13-328	77-130
13C12-2,3',4,4',5'-PeCB	118L	100	39	16-279	13-328	77-130
13C12-3,3',4,4',5'-PeCB	126L	100	39	16-279	13-328	77-130
13C12-2,3,3',4,4',5'-HxCB	156L	100	34	24-157	17-205	70-143
13C12-2,3,3',4,4',5'-HxCB	157L	100	43	24-157	17-205	70-143
13C12-3,3',4,4',5,5'-HxCB	169L	100	43	24-157	17-205	70-143
13C12-2,2',3,4,4',5,5'-HpCB	180L	100	41	28-141	20-186	72-138
13C12-2,3,3',4,4',5,5'-HpCB	189L	200	82	56-282	40-372	144-276
Cleanup standards						
13C12-3,4,4',5'-TCB	81L	20	7.2	8-31	6-38	15-26
13C12-2,3,3',5,5'-PeCB	111L	100	36	39-154	31-191	79-127

Table 6a. Preliminary Acceptance Criteria for Performance Tests when PCBs 77, 126, and 169 only are Tested¹

Native PCB	IUPAC	Test (ng/mL)	IPR		OPR (ng/mL)	VER (ng/mL)
			s ² (ng/mL)	X ³ (ng/mL)		
3,3',4,4'-TCB	77	20	5.4	17-25	15-30	16-25
3,3',4,4',5'-PeCB	126	100	17	72-150	68-160	78-130
3,3',4,4',5,5'-HxCB	169	200	45	148-320	128-340	156-260
13C12-3,3',4,4'-TCB	77L	100	34	32-115	25-141	76-131
13C12-3,3',4,4',5'-PeCB	126L	100	17	72-150	68-160	78-130
13C12-3,3',4,4',5,5'-HxCB	169L	200	45	148-320	128-340	156-260
Cleanup standards						
13C12-3,4,4',5'-TCB	81L	20	7.2	8-31	6-38	15-26
13C12-2,3,3',5,5'-PeCB	111L	100	36	39-154	31-191	79-127

¹ Preliminary criteria transferred from Method 1613. All criteria given as concentration in the final extract, assuming a 20- μ L volume.

² s=standard deviation

³ X=average concentration

Table 7. Labeled Compound Recovery in Samples When All PCBs are Tested

Labeled PCB	IUPAC No.	Test conc (ng/mL)	Labeled compound recovery	
			(ng/mL)	(%)
13C12-3,3',4,4'-TCB	77	100	24-169	24-169
13C12-2,3,3',4,4'-PeCB	105	100	21-178	21-178
13C12-2,3',4,4',5-PeCB	118	100	21-178	21-178
13C12-3,3',4,4',5-PeCB	126	100	21-178	21-178
13C12-2,3,3',4,4',5-HxCB	156	100	26-152	26-152
13C12-2,3,3',4,4',5'-HxCB	157	100	26-152	26-152
13C12-2,3',4,4',5,5'-HxCB	167	100	26-152	26-152
13C12-3,3',4,4',5,5'-HxCB	169	100	26-152	26-152
13C12-2,2',3,4,4',5,5'-HpCB	180	100	23-143	23-143
13C12-2,3,3',4,4',5,5'-HpCB	189	100	23-143	23-143
Cleanup standards				
13C12-3,4,4',5-TCB	81	20	7-40	35-197
13C12-2,3,3',5,5'-PeCB	111	100	35-197	35-197

Table 7a. Labeled Compound Recovery When PCBs 77, 126, and 169 Only are Tested¹

Labeled PCB	IUPAC No.	Test conc (ng/mL)	Labeled compound Recovery	
			(ng/mL)	(%)
13C12-3,3',4,4'-TCB	77	100	29-140	29-140
13C12-3,3',4,4',5-PeCB	126	100	21-178	21-178
13C12-3,3',4,4',5,5'-HxCB	169	100	26-152	26-152
Cleanup standards				
13C12-3,4,4',5-TCB	81	20	8-33	42-164
13C12-2,3,3',5,5'-PeCB	111	100	35-197	35-197

¹ Preliminary criteria transferred from Method 1613. Criteria are given as concentration in the final extract, assuming a 20 uL volume.

Table 8. Descriptors, Exact m/z's, m/z Types, and Elemental Compositions of the PCBs

Descriptor	Exact m/z ¹	m/z type	Elemental composition	Substance ²
1.	289.9224	M	C12 H6 35Cl4	TCB
	291.9194	M+2	C12 H6 35Cl3 37Cl4	TCB
	292.9825	Lock	C7 F11	PFK
	301.9626	M	¹³ C12 H6 35Cl4	PeCB ³
	303.9597	M+2	¹³ C12 H6 35Cl3 37Cl	PeCB ³
	325.8804	M+2	C12 H5 35Cl4 37Cl	PeCB
	327.8775	M+4	C12 H5 35Cl3 37Cl2	PeCB
	330.9792	QC	C7 F13	PFK
2.	325.8804	M+2	C12 H5 35Cl4 37Cl	PeCB
	327.8775	M+4	C12 H5 35Cl3 37Cl2	PeCB
	337.9207	M+2	¹³ C12 H5 35Cl4 37Cl	PeCB ³
	339.9178	M+4	¹³ C12 H5 35Cl3 37Cl2	PeCB ³
	354.9892	Lock	C9 F13	PFK
	359.8415	M+2	C12 H4 35Cl5 37Cl	HxCB
	361.8385	M+4	C12 H4 35Cl4 37Cl2	HxCB
	371.8817	M+2	¹³ C12 H4 35Cl5 37Cl	HxCB ³
	373.8788	M+4	¹³ C12 H4 35Cl4 37Cl2	HxCB ³
	393.8025	M+2	C12 H3 35Cl6 37Cl	HpCB
	395.7996	M+4	C12 H3 35Cl5 37Cl2	HpCB
	405.8428	M+2	¹³ C12 H3 35Cl6 37Cl	HpCB ³
	407.8398	M+4	¹³ C12 H3 35Cl5 37Cl2	HpCB ³
	3.	442.9728	Lock	C10 F17
509.7229		M+4	¹³ C12 35Cl10 37Cl2	DCB ³
511.7199		M+6	¹³ C12 35Cl9 37Cl3	DCB ³
513.7170		M+8	¹³ C12 35Cl8 37Cl4	DCB ³

¹ Nuclidic masses used were:

H = 1.007825

C = 12.00000

¹³C = 13.003355

³⁵Cl = 34.968853

³⁷Cl = 36.965903

² TCB = Tetrachlorobiphenyl

PeCB = Pentachlorobiphenyl

HxCB = Hexachlorobiphenyl

HpCB = Heptachlorobiphenyl

DCB = Decachlorobiphenyl

³ ¹³C labeled compound

Table 9. Theoretical Ion Abundance Ratios and QC Limits

Chlorine atoms	m/z's forming ratio	Theoretical ratio	QC Limit ¹	
			Lower	Upper
4	M/(M+2)	0.77	0.65	0.89
5	(M+2)/(M+4)	1.55	1.32	1.78
6	M/(M+2)	0.51	0.43	0.59
6	(M+2)/(M+4)	1.24	1.05	1.43
7	M/(M+2)	0.44	0.37	0.51
7	(M+2)/(M+4)	1.05	0.88	1.20
8	(M+2)/(M+4)	0.89	0.76	1.02

¹ QC limits represent +/- 15 % windows around the theoretical ion abundance ratio. These limits are preliminary.

Table 10. Suggested Sample Quantities to be Extracted for Various Matrices¹

Sample matrix ²	Example	Percent solids	Phase	Quantity extracted
Single-phase				
Aqueous	Drinking water	<1	— ³	1000 mL
	Groundwater			
	Treated wastewater			
Solid	Dry soil	>20	Solid	10 g
	Compost			
	Ash			
Organic	Waste solvent	<1	Organic	10 g
	Waste oil			
	Organic polymer			
Tissue	Fish	—	Organic	10 g
	Human adipose			
Multi-phase				
Liquid/Solid				
Aqueous/Solid	Wet soil	1-30	Solid	10 g
	Untreated effluent			
	Digested municipal sludge			
	Filter cake			
	Paper pulp			
Organic/solid	Industrial sludge	1-100	Both	10 g
	Oily waste			
Liquid/Liquid				
Aqueous/organic	In-process effluent	<1	Organic	10 g
	Untreated effluent			
	Drum waste			
Aqueous/organic/solid	Untreated effluent	>1	Organic & solid	10 g
	Drum waste			

¹ The quantity of sample to be extracted is adjusted to provide 10 g of solids (dry weight). One liter of aqueous samples containing one percent solids will contain 10 grams of solids. For aqueous samples containing greater than one percent solids, a lesser volume is used so that 10 grams of solids (dry weight) will be extracted.

² The sample matrix may be amorphous for some samples. In general, when the PCBs are in contact with a multiphase system in which one of the phases is water, they will be preferentially dispersed in or adsorbed on the alternate phase because of their low solubility in water.

³ Aqueous samples are filtered after spiking with the labeled compounds. The filtrate and the materials trapped on the filter are extracted separately, and the extracts are combined for cleanup and analysis.

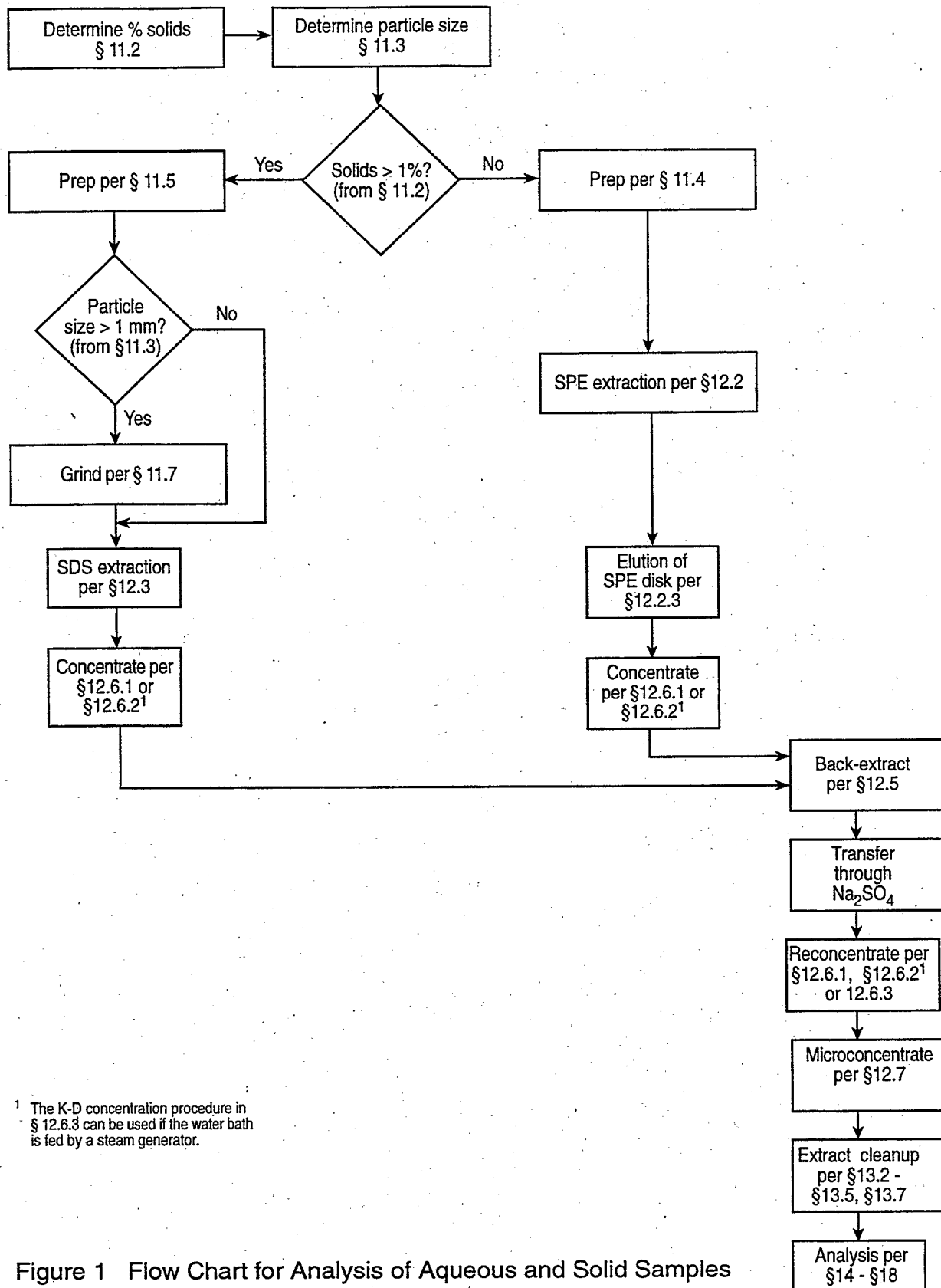

¹ The K-D concentration procedure in § 12.6.3 can be used if the water bath is fed by a steam generator.

Figure 1 Flow Chart for Analysis of Aqueous and Solid Samples

52-001-126

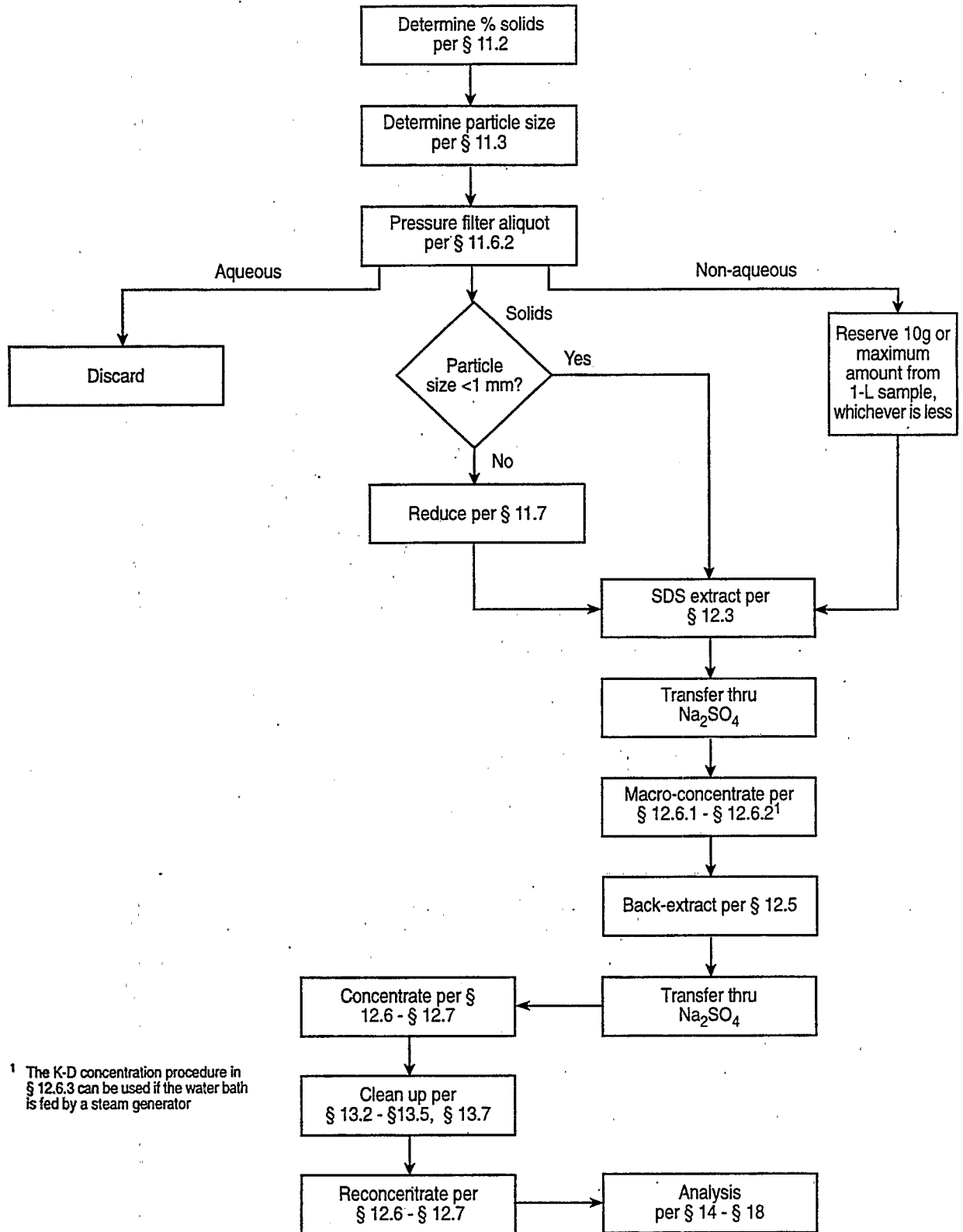

¹ The K-D concentration procedure in § 12.6.3 can be used if the water bath is fed by a steam generator

Figure 2 Flow Chart for Analysis of Multi-Phase Samples

52-001-127

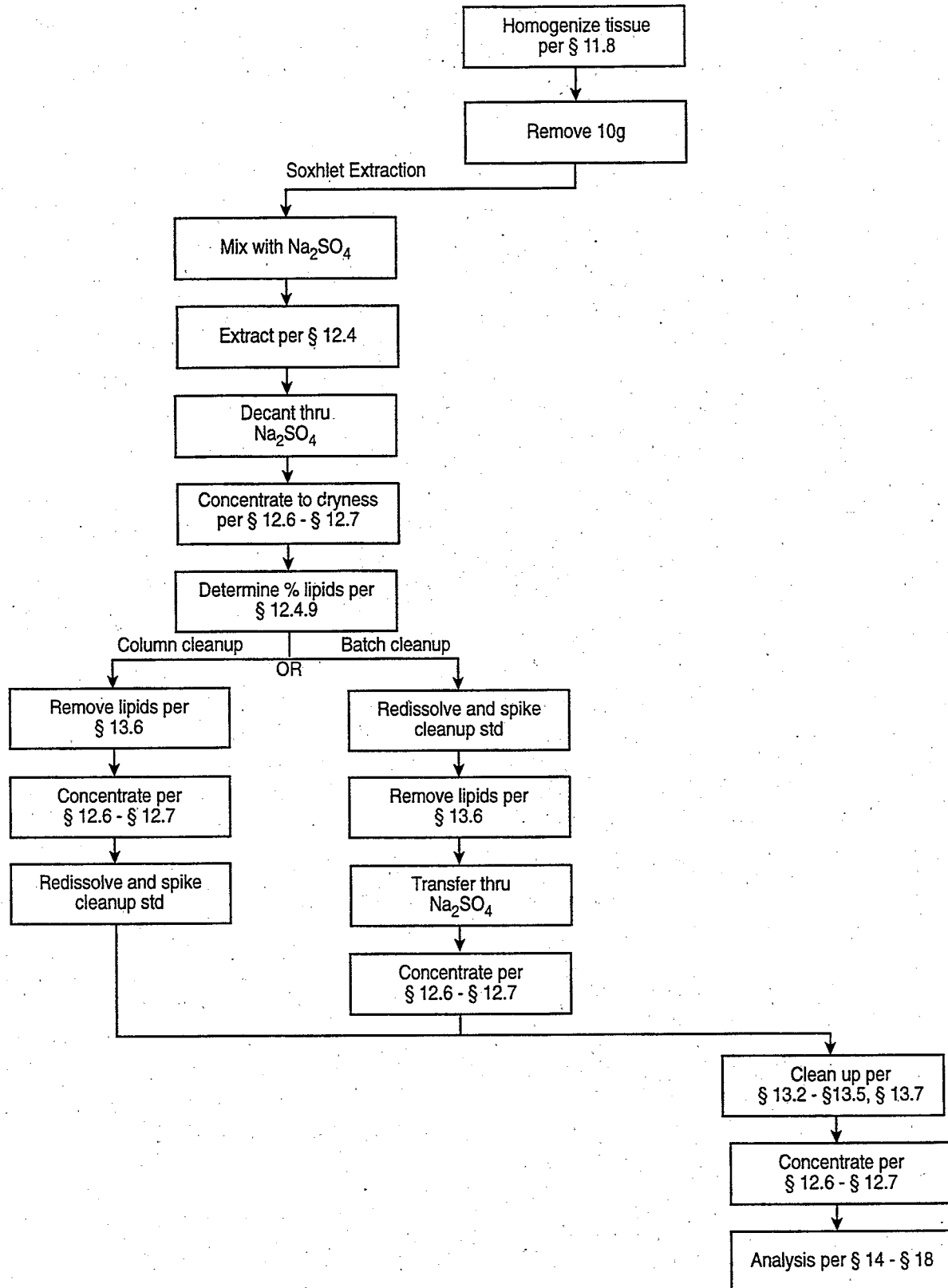

Figure 3 Flow Chart for Analysis of Tissue Samples

52-001-128

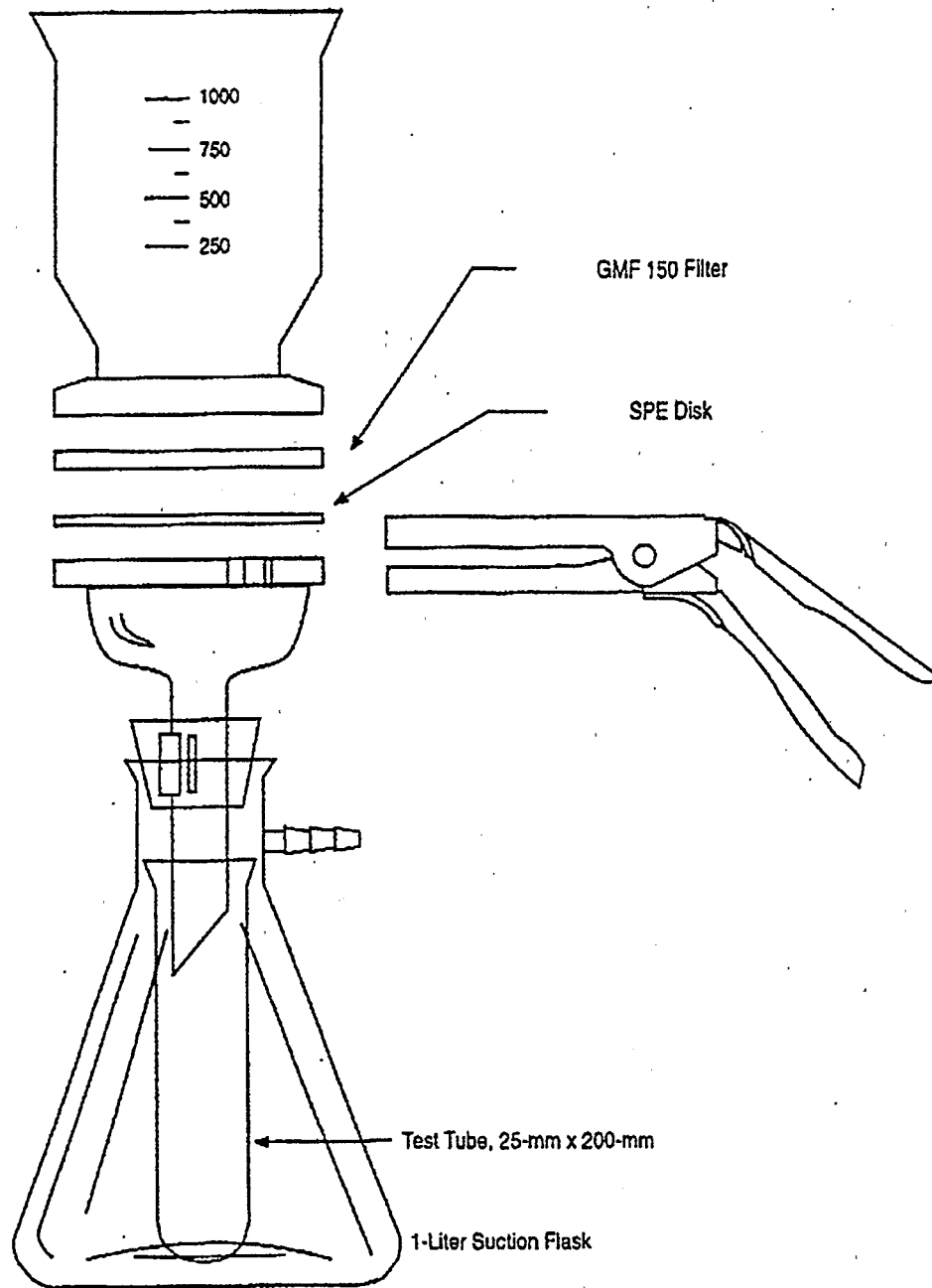
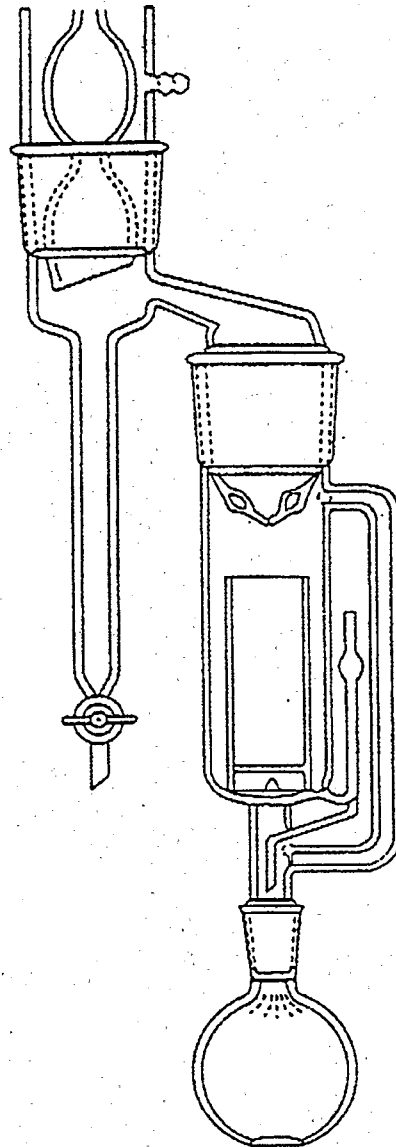

Figure 4 Solid-phase Extraction Apparatus



52-027-02

Figure 5 Soxhlet/Dean-Stark Extractor

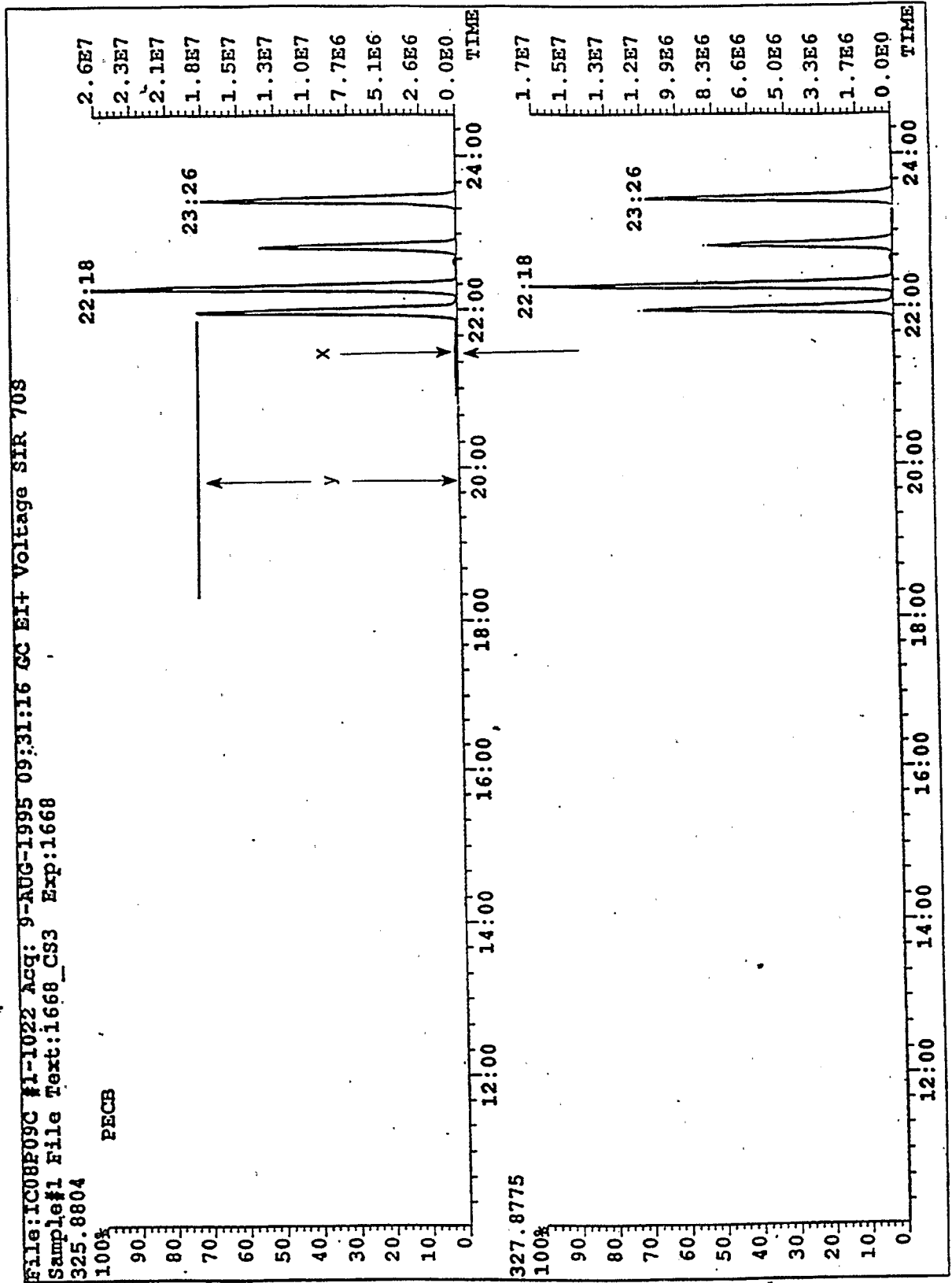

Figure 6 Congener-Specific Separation of Resolution Test Compounds on SPB-Octyl Column

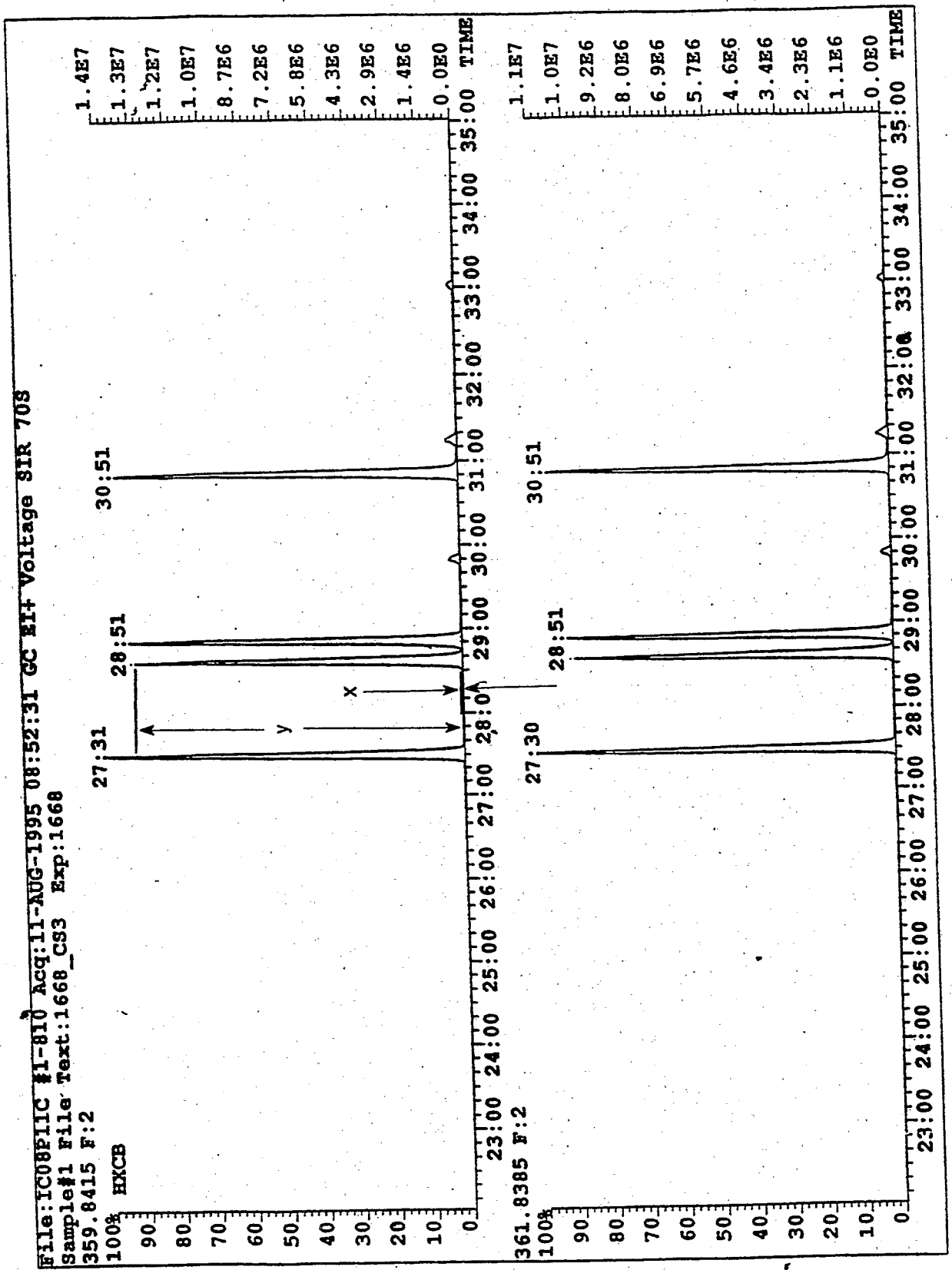

Figure 7 Congener-Specific Separation of PCBs 156 and 17 on DB-1 Column

24.0 Glossary of Definitions and Purposes

These definitions and purposes are specific to this method but have been conformed to common usage as much as possible.

24.1 Units of weight and measure and their abbreviations

24.1.1 Symbols

°C	degrees Celsius
µL	microliter
µm	micrometer
<	less than
>	greater than
%	percent

24.1.2 Alphabetical abbreviations

amp	ampere
cm	centimeter
g	gram
h	hour
ID	inside diameter
in.	inch
L	liter
M	Molecular ion
m	meter
mg	milligram
min	minute
mL	milliliter
mm	millimeter
m/z	mass-to-charge ratio
N	normal; gram molecular weight of solute divided by hydrogen equivalent of solute, per liter of solution
OD	outside diameter
pg	picogram
ppb	part-per-billion
ppm	part-per-million
ppq	part-per-quadrillion
ppt	part-per-trillion
psig	pounds-per-square inch gauge
v/v	volume per unit volume
w/v	weight per unit volume

24.2 Definitions and acronyms (in alphabetical order).

Analyte: A PCB tested for by this method. The analytes are listed in Table 1.

Calibration standard (CAL): A solution prepared from a secondary standard and/or stock solutions and used to calibrate the response of the instrument with respect to analyte concentration.

Calibration verification standard (VER): The mid-point calibration standard (CS3) that is used in to verify calibration. See Table 4.

CS1, CS2, CS3, CS4, CS5: See Calibration standards and Table 4.

DCB: Decachlorobiphenyl (PCB 209)

Field blank: An aliquot of reagent water or other reference matrix that is placed in a sample container in the laboratory or the field, and treated as a sample in all respects, including exposure to sampling site conditions, storage, preservation, and all analytical procedures. The purpose of the field blank is to determine if the field or sample transporting procedures and environments have contaminated the sample.

GC: Gas chromatograph or gas chromatography.

GPC: Gel permeation chromatograph or gel permeation chromatography.

HpCB: Heptachlorobiphenyl

HPLC: High performance liquid chromatograph or high performance liquid chromatography.

HRGC: High resolution GC.

HRMS: High resolution MS.

HxCB: Hexachlorobiphenyl

IPR: Initial precision and recovery; four aliquots of the diluted PAR standard analyzed to establish the ability to generate acceptable precision and accuracy. An IPR is performed prior to the first time this method is used and any time the method or instrumentation is modified.

K-D: Kuderna-Danish concentrator; a device used to concentrate the analytes in a solvent.

Laboratory blank: See Method blank.

Laboratory control sample (LCS): See Ongoing precision and recovery standard (OPR).

Laboratory reagent blank: See Method blank.

May: This action, activity, or procedural step is neither required nor prohibited.

May not: This action, activity, or procedural step is prohibited.

Method blank: An aliquot of reagent water that is treated exactly as a sample including exposure to all glassware, equipment, solvents, reagents, internal standards, and surrogates that are used with samples. The method blank is used to determine if analytes or interferences are present in the laboratory environment, the reagents, or the apparatus.

Minimum level (ML): The level at which the entire analytical system must give a recognizable signal and acceptable calibration point for the analyte. It is equivalent to the concentration of the lowest calibration standard, assuming that all method-specified sample weights, volumes, and cleanup procedures have been employed.

MS: Mass spectrometer or mass spectrometry.

Must: This action, activity, or procedural step is required.

OPR: Ongoing precision and recovery standard (OPR); a laboratory blank spiked with known quantities of analytes. The OPR is analyzed exactly like a sample. Its purpose is to assure that the results produced by the laboratory remain within the limits specified in this method for precision and recovery.

PAR: Precision and recovery standard; secondary standard that is diluted and spiked to form the IPR and OPR.

PFK: Perfluorokerosene; the mixture of compounds used to calibrate the exact m/z scale in the HRMS.

Preparation blank: See Method blank.

Primary dilution standard: A solution containing the specified analytes that is purchased or prepared from stock solutions and diluted as needed to prepare calibration solutions and other solutions.

Quality control check sample (QCS): A sample containing all or a subset of the analytes at known concentrations. The QCS is obtained from a source external to the laboratory or is prepared from a source of standards different from the source of calibration standards. It is used to check laboratory performance with test materials prepared external to the normal preparation process.

PeCB: Pentachlorobiphenyl

PCB: Polychlorinated biphenyl

Reagent water: water demonstrated to be free from the analytes of interest and potentially interfering substances at the method detection limit for the analyte.

Relative standard deviation (RSD): The standard deviation times 100 divided by the mean. Also termed "coefficient of variation."

RF: Response factor. See Section 10.6.1.

RR: Relative response. See Section 10.5.2.

RSD: See Relative standard deviation.

SDS: Soxhlet/Dean-Stark extractor; an extraction device applied to the extraction of solid and semi-solid materials (Reference 12 and Figure 5).

Should: This action, activity, or procedural step is suggested but not required.

SICP: Selected ion current profile; the line described by the signal at an exact m/z.

SPE: Solid-phase extraction; an extraction technique in which an analyte is extracted from an aqueous sample by passage over or through a material capable of reversibly adsorbing the analyte. Also termed liquid-solid extraction.

Specificity: The ability to measure an analyte of interest in the presence of interferences and other analytes of interest encountered in a sample.

Stock solution: A solution containing an analyte that is prepared using a reference material traceable to EPA, the National Institute of Science and Technology (NIST), or a source that will attest to the purity and authenticity of the reference material.

TCB: Tetrachlorobiphenyl.

VER: See Calibration verification standard.

Annex XX:

Maximum levels for certain foodstuffs (EC Regulations)

Maximum Levels of Heavy Metals – (EC) Regulation 1881/2006

Maximum levels for certain foodstuffs (EC Regulations)**Maximum Levels of Heavy Metals – (EC) Regulation 1881/2006**

	Foodstuffs	Maximum levels $\mu\text{g kg}^{-1}$ wet weight		
		Cadmium	Lead	Mercury
1	Muscle meat of fish ⁽¹⁾	0.050 Excluding species listed in 2 and 3	0.30	0.50 Excluding species listed in 4
2	Muscle meat of the following fish ⁽¹⁾ anchovy (<i>Engraulis species</i>) bonito (<i>Sarda sarda</i>) common two-banded seabream (<i>Diplodus vulgaris</i>) eel (<i>Anguilla anguilla</i>) grey mullet (<i>Mugil labrosus labrosus</i>) horse mackerel or scad (<i>Trachurus species</i>) louvar or luvar (<i>Luvarus imperialis</i>) sardine (<i>Sardina pilchardus</i>) sardinops (<i>Sardinops species</i>) tuna (<i>Thunnus species</i> , <i>Euthynnus species</i> , <i>Katsuwonus pelamis</i>) wedge sole (<i>Dicologlossa cuneata</i>)	0.10		
3	Muscle meat of swordfish (<i>Xiphias gladius</i>) ⁽¹⁾	0.30		
4	Muscle meat of the following fish: anglerfish (<i>Lophius species</i>) atlantic catfish (<i>Anarhichas lupus</i>) bonito (<i>Sarda sarda</i>) eel (<i>Anguilla species</i>) emperor, orange roughy, rosy soldierfish (<i>Hoplostethus species</i>) grenadier (<i>Coryphaenoides rupestris</i>) halibut (<i>Hippoglossus hippoglossus</i>) marlin (<i>Makaira species</i>) megrim (<i>Lepidorhombus species</i>) mullet (<i>Mullus species</i>) pike (<i>Esox lucius</i>)			1.0

	plain bonito (<i>Orcynopsis unicolor</i>) poor cod (<i>Tricopterus minutus</i>) portuguese dogfish (<i>Centroscymnus coelolepis</i>) rays (<i>Raja species</i>) redfish (<i>Sebastes marinus</i> , <i>S. mentella</i> , <i>S. viviparus</i>) sail fish (<i>Istiophorus platypterus</i>) scabbard fish (<i>Lepidopus caudatus</i> , <i>Aphanopus carbo</i>) seabream, pandora (<i>Pagellus species</i>) shark (all species) snake mackerel or butterfish (<i>Lepidocybium flavobrunneum</i> , <i>Ruvettus pretiosus</i> , <i>Gempylus serpens</i>) sturgeon (<i>Acipenser species</i>) swordfish (<i>Xiphias gladius</i>) tuna (<i>Thunnus species</i> , <i>Euthynnus species</i> , <i>Katsuwonus pelamis</i>)			
5	Crustaceans, excluding brown meat of crab and excluding head and thorax meat of lobster and similar large crustaceans	0.50	0.50	0.50
6	Bivalve molluscs	1.0	1.5	
7	Cephalopods (without viscera)	1.0	1.0	

(1) Exclusion of liver. Where fish are intended to be eaten whole, the maximum level shall apply to the whole fish

Maximum Levels of

Benzo(a)pyrene and sum of four PAHs (benzo(a)pyrene, benz(a)anthracene, benzo(b)fluoranthene and chrysene) Regulation No 835/2011 amending Regulation (EC) 1881/2006

Foodstuffs	Maximum levels ($\mu\text{g kg}^{-1}$)	
	Benzo(a)pyrene	Sum of benzo(a)pyrene, benz(a)anthracene, benzo(b)fluoranthene and chrysene *
Bivalve molluscs (fresh, chilled or frozen)	5.0	30.0

* Lower bound concentrations are calculated on the assumption that all the values of the four substances below the limit of quantification are zero

Maximum Levels of

Dioxins and PCBs - Regulation (EC) 1259/2011 amending Regulation (EC) 1881/2006

Foodstuffs	Maximum levels		
	Sum of dioxins (WHO-PCDD/F-TEQ) ⁽¹⁾	Sum of dioxins and dioxin-like PCBs (WHO-PCDD/F-PCB-TEQ) ⁽¹⁾	Sum of PCB28, PCB52, PCB101, PCB138, PCB153 and PCB180 (ICES 6)
Muscle meat of fish and fishery products and products thereof ⁽²⁾ with the exemption of: <ul style="list-style-type: none"> • wild caught eel • wild caught fresh water fish, with the exception of diadromous fish species caught in fresh water • fish liver and derived products • marine oils The maximum level for crustaceans applies to muscle meat from appendages and abdomen. In case of crabs and crab-like crustaceans (<i>Brachyura</i> and <i>Anomura</i>) it applies to muscle meat from appendages.	3.5 pg g ⁻¹ wet weight	6.5 pg g ⁻¹ wet weight	75 ng g ⁻¹ wet weight

(1) Dioxins (sum of polychlorinated dibenzo-para-dioxins (PCDDs) and polychlorinated dibenzofurans (PCDFs), expressed as World Health Organisation (WHO) toxic equivalent using the WHO-toxic equivalency factors (WHO-TEFs)) and sum of dioxins and dioxin-like PCBs (sum of PCDDs, PCDFs and polychlorinated biphenyls (PCBs), expressed as WHO toxic equivalent using the WHO-TEFs). WHO-TEFs for human risk assessment based on the conclusions of the World Health Organization (WHO) (For TEF values see note 31, (EC) Regulation 1259/2011 – Annex 1.1.9.).

(2) Where fish are intended to be eaten whole, the maximum level shall apply to the whole fish.

Annex XXI:

References

References

Black, K., Kalantzi, I., Karakassis, I., Papageorgiou, N., Pergantis, S., Shimmield, T. (2013). Heavy metals, trace elements and sediment geochemistry at four Mediterranean fish farms, *Science of the Total Environment*. 444, 128–137.

CEN (1997) European Standard EN 1948: Stationary source emissions, determination of the mass concentration of PCDDs/PCDFs. CEN, Brussels, Belgium

Charles M.J, Green B., Tondeur J.R, Hass R. (1989). Optimisation of a hybrid-mass spectrometer method for the analysis of polychlorinated dibenzo-p-dioxins and polychlorinated dibenzofurans. *Chemosphere* 19, 51–57

Codex Alimentarius (FAO/WHO) : <http://www.fao.org/fao-who-codexalimentarius>

Commission Regulation (EU) No 835/2011 amending Regulation (EC) No 1881/2006 as regards maximum levels for polycyclic aromatic hydrocarbons in foodstuffs

Enamorado-Báez, S.M., Abril, JM and Gómez-Guzmán, JM (2013) Determination of 25 Trace Element Concentrations in Biological Reference Materials by ICP-MS following Different Microwave-Assisted Acid Digestion Methods Based on Scaling Masses of Digested Samples. *Hindawi Publishing Corporation, ISRN Analytical Chemistry, Volume 2013, Article ID 851713, 14 pages.* <http://dx.doi.org/10.1155/2013/851713>

EU Commission Regulation (EC) No 333/2007, laying down the methods of sampling and analysis for the official control of the levels of lead, cadmium, mercury, inorganic tin, 3-MCPD and benzo(a)pyrene in foodstuffs

EU Commission Regulation (EC) 836/2011 amending Commission Regulation (EC) No 333/2007, laying down the methods of sampling and analysis for the official control of the levels of lead, cadmium, mercury, inorganic tin, 3-MCPD and benzo(a)pyrene in foodstuffs

EU Commission Regulation (EC) No 1259/2011, amending Regulation (EC) No 1881/2006 as regards maximum levels for dioxins, dioxin-like PCBs and non-dioxin-like PCBs in foodstuffs (Annex IV);

EU Commission Regulation (EC) No 1881/2006, setting maximum levels for certain contaminants in seafood (Annex I)

Focant J.F, Pirard C, Eppe G, DePauw E. (2005). Recent advances in mass spectrometric measurement of dioxins *J. Chromatography A*. 1067:265–275

Harms, U. 1985. Possibilities of improving the determination of extremely low lead concentrations in marine fish by graphite furnace atomic absorption spectrometry. *Fresenius Journal of Analytical Chemistry*, 322: 53-56.

HELCOM (2012a). Manual for marine monitoring in the COMBINE programme. Annex B-12, Appendix 4: Technical note on the determination of trace metallic elements in biota

HELCOM (2012b). COMBINE Annex B-12, Appendix 4, Attachment 1. Technical note on the determination of Total Mercury in marine biota by Cold Vapour Atomic Absorption Spectroscopy

HELCOM (2012c). Manual for marine monitoring in the COMBINE programme. Annex B-12, Appendix 3. Technical note on the determination of chlorinated biphenyls and organochlorine pesticides in biota.

HELCOM (2012d). Manual for marine monitoring in the COMBINE programme. Annex B-12, Appendix 2. Technical Note on the determination of Polycyclic Aromatic Hydrocarbons in Biota

IAEA (2011a). Recommended method on microwave digestion of marine samples for the determination of trace element content (IAEA/Marine Environmental Studies Laboratory in co-operation with UNEP/MAP MED POL)

IAEA (2011b) Recommended method for the determination of selected trace element in samples of marine origin by flame atomic absorption spectrometry

IAEA (2011c) Recommended method for the determination of selected trace element in samples of marine origin by atomic absorption spectrometry using graphite furnace

IAEA (2012a) Recommended method on the determination of Total Hg in marine samples by Thermal Decomposition Amalgamation and Atomic Absorption Spectrometry

IAEA (2012b). Recommended method on the determination of Total Hg in samples of marine origin by Cold Vapour Atomic Absorption Spectrometry

ICES/OSPAR (2018). CEMP Guidelines for monitoring contaminants in biota and sediments. Technical Annex 3: Determination of parent and alkylated PAHs in biological materials

ISO (2004) ISO 18073: Water quality—Determination of tetraocta-chlorinated dioxins and furans—Method using isotope dilution HRGC/HRMS. International Organization for Standardization (ISO), Geneva, Switzerland

ISO (2006) ISO 17585: Water quality—Determination of dioxin-like polychlorinated biphenyls—method using gas chromatography and mass spectrometry. International Organization for Standardization (ISO), Geneva, Switzerland

Petrovic M., Eljarrat E., Lopez de Alda M.J, Barcelo D. (2002). Recent advances in the mass spectrometric analysis related to endocrine disrupting compounds in aquatic environmental samples. *J. Chromatography A* 974:23–51.

Reiner, E.J, Clement, R.E, Okey, A.B., Marvin, C.H. (2006). Advances in analytical techniques for polychlorinated dibenzo-p-dioxins, polychlorinated dibenzofurans and dioxin-like PCBs. *Anal Bioanal Chem* (2006) 386: 791–806.

Reiner E.J, Schellenberg D.H, Taguchi V.Y (1991). Environmental applications for the analysis of chlorinated dibenzo-p-dioxins and dibenzofurans using mass-spectrometry. *Environ Sci Technol* 25:110–117

Reiner E.J, Schellenberg D.H Taguchi V.Y, Mercer R.S, Townsend J.A, Thompson T.S, Clement R.E (1990). Application of tandem quadrupole mass spectrometry for ultra-trace determination of polychlorinated dibenzo-p-dioxins and dibenzofurans. *Chemosphere* 20, 1385-1392.

Richter B.E, Jones B.A, Ezzell J.L, Porter N.L, Avdalovic N, Pohl C (1996). Accelerated Solvent Extraction: A Technique for Sample Preparation. *Analytical Chemistry*, 68:1033–1039

Taylor KZ, Waddell DS, Reiner EJ, MacPherson KA (1995). Direct Elution of Solid Phase Extraction Disks for the Determination of Polychlorinated Dibenzo-p-dioxins and Polychlorinated Dibenzofurans in Effluent Samples. *Analytical Chemistry*, 67:1186–1190

Thomson, M. (2000). Recent trends in inter-laboratory precision at ppb and sub-ppb concentrations in relation to fitness for purpose criteria in proficiency testing. *Analyst* 125, 385-386

UNEP (2019). UNEP/MED WG.467/5. IMAP Guidance Factsheets: Update for Common Indicators 13, 14, 17, 18, 20 and 21: New proposal for candidate indicators 26 and 27

UNEP/IAEA (2011d). Sample work-up for the analysis of selected chlorinated hydrocarbons in the marine environment. Reference Methods for Marine Pollution Studies No 71.

US EPA (1994) US-EPA Method 200.8: Determination of trace elements in waters and wastes by inductively coupled plasma-mass spectrometry

US EPA (2007). U.S. Environmental Protection Agency, EPA method 7473, Mercury in solids and solutions by thermal decomposition, amalgamation and atomic absorption spectrophotometry Rev 0. <http://www.epa.gov/osw/hazard/testmethods/sw846/pdfs/7473.pdf>

US EPA (2007b). U.S. Environmental Protection Agency, EPA method 7473, Mercury in solids and solutions by thermal decomposition, amalgamation and atomic absorption spectrophotometry Rev 0. <http://www.epa.gov/osw/hazard/testmethods/sw846/pdfs/7473.pdf>

US EPA (2008) Method 1668, Revision B: Chlorinated biphenyl congeners in water, soil, sediment, and tissue by HRGC/HRMS, EPA-821-R-08-020. Office of Water, US Environmental Protection Agency, Washington, DC (Annex XVI)

Appendix 27

Monitoring Guidelines/Protocols for Analytical Quality Assurance for IMAP Common Indicators 13, 14, 17, 18 and 20

1. Introduction

1. The Data Quality Assurance (DQA) programme jointly organised and implemented by MED POL and IAEA/MESL since 1986, provided assistance to several Mediterranean laboratories for improving the quality of their monitoring data. As a result, data generation in the Mediterranean basin has been greatly improved in quantity and quality since the early stages of the MED POL Programme. However, there is room for improvement, because important differences still exist in data quality among different Mediterranean laboratories. If the quality of analytical data is not assured, information on contaminant concentrations variations (both in space and time) and on the biological effects of pollutants may be misleading, resulting to erroneous measures to improve the quality of the marine environment. Therefore, the generation of quality assured data is the key component of a marine pollution monitoring programme. Consequently, the Data Quality Assurance programme is a key component of the UNEP/MAP IMAP.

2. The Data Quality component involves three groups of stakeholders in an ascending order: i) the national laboratories responsible for the collection, analysis and reporting of data; ii) the IMAP users (i.e. MEDPOL Focal Points and national IMAP competent laboratories); iii) IMAP Info System (the UNEP/MAP - INFO/RAC; MED POL). The four Protocols of this Monitoring Guidelines elaborates the Analytical Quality Assurance for IMAP Common Indicators 13, 14, 17, 18 and 20 regarding the following steps of the analytical procedure chain: a) sample collection); b) sample processing; c) determination of hydrographic parameters; d) analytical determination of key nutrients and chlorophyll *a* in water column; as well as analytical determinations of contaminant in relevant matrices and evaluation of their biological effects and d) reporting of monitoring data.

3. The responsibility of IMAP competent laboratories within the Quality Assurance system is to ensure consistent measurements and accurate analytical data complying with international standards in terms of scientific/analytical QA and within its specific field (ca. chemistry and biology). Therefore, the objective of the Protocols of this Guideline is to assist laboratories working in implementation of IMAP Pollution Cluster to produce analytical data of the required quality. The guideline intends also to help establishing or improving quality assurance management in the laboratories concerned.

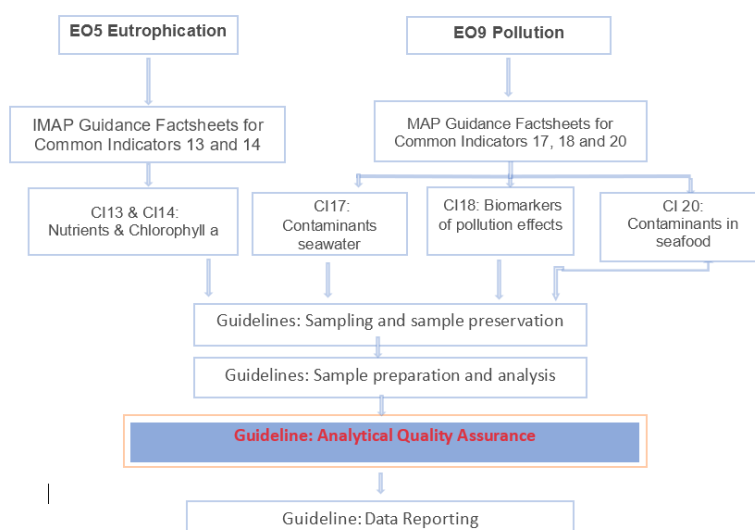

Flow Diagram: Monitoring Guidelines for IMAP Ecological Objectives 5 and 9

2. Technical note for a Quality Assurance scheme

4. The schemes for Quality Assurance and Control of Data for MED POL Monitoring Database and IMAP (Pilot) Info System have been established in two levels. On the first level there is a monitoring data Quality Assurance and Quality Control (QA/QC) for each IMAP Common Indicator; on the second level there is a full Database Quality Management and Reporting Schemes. Quality Assurance addresses the activities the laboratory undertakes to provide confidence that quality requirements will be fulfilled, whereas Quality Control describes the individual measures which are used to actually fulfil the requirements (EURACHEM, 2014⁵⁰⁴).

5. The main attributes to be fulfilled in view of obtaining “quality data” are completeness, accuracy, consistency, accessibility, timeliness and validity (UNEP/MAP, 2019a⁵⁰⁵), EURACHEM, 2014):

- i) Completeness refers to the fact that provided information should include both data (i.e. the parameter of interest) and associated metadata (i.e. environmental information);
- ii) Accuracy refers to the degree to which the result of a measurement approaches to a reference value and it is usually studied as two components: trueness and precision. Trueness is expressed quantitatively in terms of bias and precision is usually expressed by statistical parameters which describe the spread of results, typically the standard deviation.
- iii) Consistency refers to the attribute of being able to produce results with the same level of performance over time indifferently of external constrains, extending to any type of data (e.g., data and associated metadata);
- iv) Accessibility refers to a user’s ability to access or retrieved data stored within a database;
- v) Timeliness refers to the requisite of the data to be reported in a timely manner, to ensure the maximization of the value of the collected data from a user’s perspective; and
- vi) Validity refers to the fact that the data quality concept is a fit-for-purpose target and should comply with certain conditions to serve their expected use. These conditions are the Data Control to be defined in accordance to each parameter (UNEP/MAP, 2019a).

6. It has to be emphasized that Quality Assurance (QA) applies to all aspects of analytical procedures (sampling, sample pre-treatment, analysis and reporting) (ICES, 2004a⁵⁰⁶) (UNEP/MED WG.492/Inf.13, Annex I). Therefore, it is of paramount importance to establish an integrated data Quality Assurance system for each IMAP Common Indicator.

7. The Quality System has to be provided in a Quality Manual that needs to be maintained and up-to date. In case the laboratory has an accreditation for the specific analyses (nutrients, chl-a, trace elements, organic contaminants, biomarkers) in relevant matrices (sediment/biota/seawater as appropriate), it has to follow the procedures described in the Quality Manual. If the laboratory is not accredited for such analytical determinations, it has to prepare an Internal Standard Operational Procedures (SOPs) for the analytical methods used, which has to be followed in every relevant laboratory activity, in order to establish an internal Quality Assurance. Guidance on the procedures to

⁵⁰⁴ EURACHEM Guide: The Fitness for Purpose of Analytical Methods – A Laboratory Guide to Method Validation and Related Topics, (2nd ed. 2014). B. Magnusson and U. Ormemark (eds.) ISBN 978-91-87461-59-0. Available from www.eurachem.org.”

⁵⁰⁵ UNEP/MAP (2019a) UNEP/MED WG.467/13. Schemes for Database Quality and Quality Assurance and Quality Control (QA/QC) of data related to pollution

⁵⁰⁶ ICES (2004a). ICES Techniques in Marine Environmental Sciences, No 35. Chemical measurements in the Baltic Sea: Guidelines on quality assurance

follow in order to establish a Quality System in an analytical laboratory can be found in the ISO Standard 17025 “General Requirements for the Technical Competence of Calibration and Testing Laboratories” (2017⁵⁰⁷).

8. A very important part in the organisation of the laboratory is the necessary documentation related to analysis, which includes a clear description of the analytical methods (CIs 13, 14, 17, 18 and 20); a strict keeping of laboratory journals; keeping of instrument journals; laboratory protocols for sample identification; and clear labelling of samples, reference materials, chemicals, reagents, volumetric equipment, stating date, calibration status, concentration or content as appropriate and signature of the person responsible for the analysis (ICES, 2004a, ICES, 2004b⁵⁰⁸).

9. The QA systems includes the participation of laboratories in interlaboratory comparison exercises (ILCs) and/or Proficiency Tests (PTs) procedures to ensure a known long term stability of the laboratory’s performance, the use of reference materials, and the documentation required (ICES/OSPAR, 2018a⁵⁰⁹) (UNEP/MED WG.492/Inf.13, Annex II).

10. Therefore, under Technical Note for a Quality Assurance Scheme, this Guideline elaborates the following four Protocols to support efforts of national laboratories that are responsible for IMAP implementation:

- Protocol on QA in sample collection;
- Protocol on QA in sample processing;
- Protocol on QA in analytical methods;
- Protocol on QA in reporting of data.

2.1 Protocol on QA in sample collection

11. Quality Assurance for sample collection includes the following principal elements (ICES, 2004a):

- i) A knowledge of the purpose of the investigation is essential to establish the required data quality, which has to be defined by the Contracting Parties;
- ii) Provision and optimization of appropriate facilities and sampling equipment;
- iii) Selection and training of staff for the sampling task in question;
- iv) Establishment of definitive directions for appropriate collection, preservation, storage, and transport procedures to maintain the integrity of samples prior to analysis;
- v) Use of suitable Standard Operating Procedures (SOPs) with appropriate Quality Control for sample handling to prevent uncontrolled contamination and/or loss of the determinant in the sample, as well as collection of field blanks; Standard Operating Procedures is a set of step-by-step instructions compiled by an organization to help workers carry out routine operations. SOPs aim to achieve efficiency, quality output and uniformity of performance, while reducing miscommunication and failure to comply with industry regulations

507 ISO/IEC 17025:2017. General requirements for the competence of testing and calibration laboratories

508 ICES (2004b). Biological monitoring: General guidelines for quality assurance. Ed. by H. Rees. ICES Techniques in Marine Environmental Sciences, No. 32.

509 ICES/OSPAR (2018a). CEMP Guidelines for Monitoring Contaminants in Sediments. Technical Annex 6: Determination of metals in sediments – analytical methods.

- vi) Preparation and use of written instructions, sampling protocols and sampling logs, so that sample collection data can be traced to the relevant samples and vice versa

12. Field blanks are used to estimate contamination of a sample during the collection and transportation procedure. A field blank is a sample that is prepared in the field to evaluate the potential for contamination of a sample by site contaminants from a source not associated with the sample collected (for example air-borne dust or organic vapors which could contaminate a seawater, sediment or biota sample). Deionized and organic-free water is taken to the field in sealed containers. The water is poured into the appropriate sample containers at pre-designated locations at the site. The containers are preserved according to the procedures for seawater, sediment and biota samples, are transported in the laboratory for analysis (USEPA, 2017⁵¹⁰).

13. In case the laboratory has an established quality system for sampling sediment/biota/seawater samples, it has to follow the relevant Standard Operational Procedures. In case the laboratory is accredited for sampling it has to follow its Quality Manual.

14. Before embarking on a cruise/field trip to collect samples, the following preparations have to be made:

- i) Setting a sampling strategy, including sampling sites, water depths, kind and number of samples to be collected;
- ii) Decide on the sampling methods to be applied and make sure that involved staff is familiar with them;
- iii) Cleaning and purification of all equipment, containers and tools to be used for sample collection, pre-treatment and storage;
- iv) Preparation for the collection of field blanks;
- v) Identification of samples: clear understanding of the information to be recorded on each sample container
- vi) Preparation of reagents to be used during sampling;
- vii) Preparation of a detailed sampling protocol (such as use of equipment, pre-treatment, blankdetermination, recording, sample splitting if required, etc.);
- viii) Distribute responsibilities to staff.

15. During sampling the following procedures need to be applied:

- i) Implementing the sampling protocol;
- ii) Maintaining sample's integrity by using appropriate sampling procedures
- iii) Collecting field blanks;
- iv) Record all necessary relevant information (such as time, sea condition, sediment characteristics, water turbidity, temperature, etc.);

⁵¹⁰ USEPA (2017). Field sampling quality control: operational procedure. SESDRPROC-011-05.

- v) Avoiding sample contamination handling samples according to relevant IMAP Guidelines;
- vi) Making sure that all samples/sub-samples are properly identified;
- vii) Applying appropriate pre-treatment to samples as required;
- viii) Storing and preserving samples and blanks according to the sample preservation and storage protocol, making sure that sample characteristics are not altered;
- ix) Maintaining a record of all activities that demonstrates an unbroken control over the sample from collection to its final disposition.

2.2 Protocol on QA in sample processing

16. Quality Assurance for sample processing before analysis includes the following principal elements (ICES, 2004a, UNEP/MED WG.492/Inf.13, Annex I):

- i) A knowledge of the purpose of the investigation is essential to establish the required data quality;
- ii) Provision and optimization of appropriate laboratory facilities and equipment for processing and pre-treatment of samples;
- iii) Selection and training of staff for the laboratory task in question;
- iv) Use of suitable pre-treatment procedures prior to the analysis of samples, to prevent uncontrolled contamination and loss of the determinant in the samples;
- v) Validation of appropriate processing methods to ensure that sample processing will not alter the measurement of the analyte under investigation;
- vi) Conduct of regular intra-laboratory checks on the accuracy of routine measurements related to IMAP Common Indicators 13, 14, 17, 18 and 20, including sample processing using Certified Reference Materials (CRMs), to assess whether the processing methods used are remaining under control, and document results on control charts (A CRM is a Reference Material accompanied by a certificate, one or more of whose property values are certified by a procedure which establishes its traceability to an accurate realisation of the unit in which the property values are expressed, and for which each certified value is accompanied by an uncertainty at a stated level of confidence);
- vii) Preparation and use of written instructions, laboratory protocols, laboratory journals, etc., so that specific data can be traced to the relevant samples and vice versa.

17. Sample processing as presented in relevant IMAP Guidelines, includes:

- i) CI13: Seawater: storage (freezing -20 °C);
- ii) CI14: Seawater: - Chlorophyll *a* (pre-filtration (mesh size > 200 µm), filtration (Glass fibre filter GF/F), filter storage (freezing -80 °C)); - salinity (storage);
- iii) CI17: Sediment samples: sieving for grain size (< 2 mm and < 63 µm), freeze drying (if appropriate), weighting and storage; Biota samples: measuring length, sex and weight (fresh), dissection to collect appropriate tissue (muscle from fish and whole body for bivalves, freeze drying (if appropriate), weighting and storage; Seawater samples: filtration (0.7 µm GF/F pre combusted glass fiber filters of organic contaminants and 0.45 µm polycarbonate filters for the

analysis of heavy metals (except mercury)), filtrate preservation and storage, SPM drying, weighting and storage;

- iv) CI18: For all biota samples: measuring length, sex and weight (fresh), eviscerated weight, liver weight, gonad weight and dissection to collect appropriate tissue. For fish samples: taking liver samples for the evaluation of lysosomal membrane stability (LMS), muscle for the evaluation of AChE activity, blood cells from the caudal vein for the evaluation of Micronuclei frequency. Also, there is a need to undertake the following measurements: Fulton's condition factor (K), gonadosomatic index (GSI), Liver Somatic Index (LSI), as well as a storage at -80 °C. For bivalves, a dissection is needed to remove gills for the evaluation of AChE activity and Micronuclei frequency, whilst Haemolymph cells and digestive gland are needed for the evaluation of LMS);
- v) CI20: For seafood samples: measuring length, sex and weight (fresh), dissection to collect appropriate tissue, freeze drying, weighting and storage.

18. In case the laboratory has an accreditation for these processes it has to follow the procedures described in the relevant Quality Manual. If the laboratory is not accredited for such processes, it has to prepare internal Standard Operational Procedures for sample processing, which has to be followed in every relevant laboratory activity, in order to establish an internal Quality Assurance.

19. All sample processing procedures for sediment, biota, seafood and seawater, should be performed under the same Quality Assurance and with the same requirements as other parts of the analytical chain. Therefore sieving, drying, weighting and storage methods used in the laboratory have to be validated following the appropriate methodology presented in ISO Standard 17025 (2017).

2.3 Protocol on QA in determination of hydrographical parameters, analytical determinations of dissolved oxygen, pH nutrients, chlorophyll *a* and contaminants in relevant matrices, biomarker evaluation and environmental analysis

20. Quality Assurance for the determination of hydrographical parameter, analysis of dissolved oxygen, pH, nutrients, chlorophyll *a* and contaminants in appropriate matrices (sediment, marine biota tissues, seawater) and biomarker evaluation in molluscs and fish, includes the following elements:

- i) A knowledge of the purpose of investigation is essential to establish the required data quality;
- ii) Provision and optimization of appropriate laboratory facilities and analytical equipment;
- iii) Selection and training of staff for the analytical task in question;
- iv) Use of suitable procedures during the analysis of samples, to prevent uncontrolled contamination and loss of the determinant in the samples;
- v) Validation of appropriate analytical methods to ensure that chemical measurements are of the required quality to meet the needs of the investigations, according the Contracting Parties decision on this matter; For biomarkers, use of appropriate analytical methods as described in the Protocols specific for the analysis of the different biomarkers to ensure that measurements are of the required quality to meet the needs of the investigations;
- vi) Conduct of regular intra-laboratory checks on the accuracy of routine measurements, by the analysis of appropriate reference materials for contaminants analysis and blind samples for biomarker determination, to assess whether the analytical methods are remaining under control. Intra-laboratory checks should be continuously performed and the results documented and

interpreted using control charts. Immediate corrective action should be undertaken in case intra-laboratory checks indicate a data quality problem;

- vii) Yearly participation in inter-laboratory quality assessments (proficiency testing schemes) to provide an independent assessment of the laboratory's capability of producing reliable measurements. Corrective action should be undertaken by concerned laboratories in case inter-laboratory checks indicate a data quality problem;
- viii) Quality Assurance responsible staff needs to keep records on the calibration of the equipment used for chemical analysis;
- ix) Quality Assurance responsible staff needs to verify that the analysts in charge to the specific analysis follow the analytical methods validated in the laboratory, taking into consideration the following analytical Guidelines: i) Monitoring Guidelines/Protocols for Determination of Hydrographic Physical Parameters (UNEP/MED WG.482/6); ii) Monitoring Guidelines/Protocols for Determination of Hydrographic Chemical Parameters (UNEP/MED WG.509/32); iii) Monitoring Guidelines/Protocols for Determination of Concentration of Key nutrients in Seawater – Nitrogen Compounds (UNEP/MED WG.509/33); iv) Monitoring Guidelines/Protocols for Determination of Concentration of Key Nutrients in Seawater – Phosphorous and Silica Compounds (UNEP/MED WG.509/19); v) Monitoring Guidelines/Protocols for Determination of Chlorophyll *a* in Seawater (UNEP/MED WG.509/20); vi) Monitoring Guidelines/Protocols for Sample Preparation and Analysis of Sediment for IMAP Common Indicator 17: Heavy and Trace Elements and Organic Contaminants (UNEP/MED WG.509/22); vii) Monitoring Guidelines/Protocols for Sample Preparation and Analysis of Marine Biota for IMAP Common Indicator 17: Heavy and Trace Elements and Organic Contaminants (UNEP/MED WG.509/24); viii) Monitoring Guidelines/Protocols for Sample Preparation and Analysis of Seawater for IMAP Common Indicator 17: Heavy and Trace Elements and Organic Contaminants (UNEP/MED WG.509/26); ix) Monitoring Guidelines/Protocols for Sample Preparation and Analysis of Sea Food for IMAP Common Indicator 20: Heavy and Trace Elements and Organic Contaminants (UNEP/MED WG.509/28); x) Biomarker Analysis Monitoring Guidelines/Protocols for Sampling and Sample Preservation of Marine Molluscs (such as *Mytilus sp.*) and Fish (such as *Mullus barbatus*) for IMAP Common Indicator 18 (UNEP/MED WG.509/27); xi) Monitoring Guidelines/Protocols for Biomarker Analysis of Marine Molluscs (such as *Mytilus sp.*) and Fish (such as *Mullus barbatus*) for IMAP Common Indicator 18 (UNEP/MED WG.509/28; UNEP/MED WG.509/29);
- x) The preparation and use of written instructions, laboratory protocols, laboratory journals, etc., so that specific analytical data can be traced to the relevant samples and vice versa.

21. For hydrographic parameters specifically obtained with CTD probes the main QC/QA scheme is related to the calibration and traceability of sensors that mostly depend on the manufacturer. It is important to build this information in the QA. Detailed description of the steps for QA in the determination of hydrographic parameter by CTD are presented in ICES Guidelines, (2004a) (UNEP/MED WG.492/Inf.13, Annex I).

22. For contaminants analysis, LOD and LOQ are method validation parameters that are defined in each laboratory and depend on many things (equipment used, the analytical method, blanks, sample matrix, concentrations of interfering compounds and on the mass of sediment/biota taken for analysis). When reporting monitoring data, laboratories have to include information on concentration values <

LOQ and concentration values < LOD, as indicated in the Data Dictionaries on contaminants concentrations (UNEP/MED WG.467/8)⁵¹¹.

23. For metal analysis in sediment, achievable LOQs for Cd and Pb using ICP-MS are 0.01 and 0.2 mg kg⁻¹ dry weight (d.w.) respectively, while Cd and Pb LOQs with AAS are 0.5 and 5 mg kg⁻¹ (d.w.) respectively. In biota, LOQs of 5 µg kg⁻¹ wet weight (w.w.) for Cd, 10 µg kg⁻¹ (w.w.) for Hg and 20 µg kg⁻¹ (w.w.) for Pb are also achievable. Therefore, every element in each matrix should have its own Quality Control and Quality Assurance (QC/ QA) scheme including relevant LOD and LOQ. A CRM should be included in each batch to confirm that measuring instrument is operating correctly. Detailed description of the steps for QA in the analysis of metals are presented in (ICES/OSPAR (2018a) (UNEP/MED WG.492/Inf.13, Annex II).

24. For organic contaminant's analysis (PCBs, HCB, chlorinated pesticides and PAHs), Quality Assurance should include: i) extraction efficiency and clean-up; ii) calibrant and calibration; iii) system performance; iv) long-term stability; v) use of internal standards; and vi) frequent participation in interlaboratory proficiency testing schemes

25. For chlorinated compounds in sediments LOQs of 0.1 µg kg⁻¹ (d.w., sediment fraction < 2mm) for individual PCBs are achievable. Detailed description of the steps for QA in the analysis of chlorinated compounds are presented in ICES/OSPAR (2018b⁵¹²) (UNEP/MED WG.492/Inf.13, Annex III) and HELCOM (2012a⁵¹³) (UNEP/MED WG.492/Inf.13, Annex IV).

26. For polycyclic aromatic hydrocarbons (PAHs), achievable LOQ for each individual component in sediments using GC-MS are 2 µg kg⁻¹ (d.w.), while for biota, LOQs of 0.05 to 0.5 µg kg⁻¹ (w.w.) for individual PAH compounds are achievable. Detailed description of the steps for QA in the analysis of PAHs in sediments and biota are presented in ICES/OSPAR (2018c⁵¹⁴) (UNEP/MED WG.492/Inf.13, Annex V) and HELCOM (2012b⁵¹⁵) (UNEP/MED WG.492/Inf.13, Annex VI).

27. For all analyses a procedural blank should be measured with each sample batch and should be prepared simultaneously using the same chemical reagents and solvents (if appropriate) as for the samples. The procedural blank is also very important in the calculation of limits of detection and limits of quantification for the analytical method. In addition, A CRM or an in-house Quality Control Material developed by a laboratory for its own internal use (ISO Guide 80, 2014⁵¹⁶) should be analysed within each sample batch. Ideally, stability tests should have been undertaken to show that the reference material yields consistent results over time. The analysis of the reference material is primarily intended as a check that the analytical method is under control and yields acceptable precision, but a certified reference material (CRM) of a similar matrix should be analysed periodically in order to check the method bias.

1. For biomarkers analysis (CI18) (i.e. LMS, MNi frequency, AChE activity and SoS), an intra-laboratory programme for the evaluation of blind mollusc and fish samples should be organized and the

⁵¹¹ UNEP/MAP (2019b). UNEP/MED WG.467/8. IMAP Pilot Info System and related Quality Assurance Issues; Data Standards and Data Dictionaries; MAP Data Management Policy.

⁵¹² ICES/OSPAR (2018b). CEMP Guidelines for Monitoring Contaminants in Sediments. Technical Annex 2: technical annex on the analysis of PCBs in sediments

⁵¹³ HELCOM (2012a). Manual for marine monitoring in the COMBINE programme. Annex B-13, Appendix 2. Technical note on the determination of chlorinated biphenyls in marine sediment

⁵¹⁴ ICES/OSPAR (2018c). CEMP Guidelines for monitoring contaminants in sediments. Technical Annex 3: Determination of parent and alkylated PAHs in sediments

⁵¹⁵ HELCOM (2012b). Manual for marine monitoring in the COMBINE programme. Annex B-13, Appendix 1. Technical note on the determination of Polycyclic Aromatic Hydrocarbons (PAHs) in sediment

⁵¹⁶ ISO GUIDE 80:2014. Guidance for the in-house preparation of quality control materials (QCMs)

labs should be involved in the intercalibration activity of the different biomarkers. These activities will ensure that all the labs involved in the programme collect comparable biomarker data. In addition to the elements above described, a laboratory staff should be specifically designated as responsible of the biomarker analysis QA, whilst a Biomarker Analysis Register must be created to register the required information. This Register needs to contain the Animals Collection Reports as provided in Monitoring Guidelines/Protocols for Sampling and Sample Preservation of Marine Molluscs (such as *Mytilus sp.*) and Fish (*Mullus barbatus*) for IMAP Common Indicator 18 (UNEP/MED WG. 509/27) and all the information concerning the biomarker analysis and reporting.

Validation of analytical methods

2. Validation is the confirmation by examination and the provision of objective evidence that the particular requirements for a specific intended use are fulfilled (ISO/IEC 17025). According to EURACHEM, (2014), the performance characteristics commonly evaluated during method validation include:

- i) Selectivity, is the extent to which the method can be used to determine particular analytes in mixtures or matrices without interferences from other components of similar behavior
- ii) Analytical sensitivity is the change in instrument response which corresponds to a change in the measured quantity (for example an analyte concentration), i.e. the gradient of the response
- iii) Working Range of the method is the interval over which the method provides results with an acceptable uncertainty. The lower end of the working range is bounded by the limit of quantification LOQ. The upper end of the working range is defined by concentrations at which significant anomalies in the analytical sensitivity are observed.
- iv) Limit of Detection (LOD) of an analytical method is the smallest concentration (the smallest amount) that the analyst can expect to detect with a given degree of confidence. The limit of detection, defined in terms of either concentration (cL) or amount (qL), is related to the smallest measure of response (xL) that can be detected with reasonable certainty in a given analytical method (IUPAC, 1978⁵¹⁷). According to this definition, the detection limit in chemical analysis is given by

$$cL(\text{or } qL) = k \cdot Sb/b$$

where Sb = standard deviation of the blank and b = sensitivity (the slope of the standard curve). A value of $k = 3$ is strongly recommended by IUPAC.

- v) Limit of Quantification (LOQ) is the smallest amount or the lowest concentration of a substance that is possible to be determined by means of a given analytical procedure with the established accuracy, precision, and uncertainty. LOQ should be estimated by using the proper standard measurement or standard sample. In practice, LOQ is calculated by most conventions to be the analyte concentration corresponding to the obtained standard deviation of blank samples multiplied by a factor, $k = 5, 6, 10$, based on "fitness for purpose" criteria (EURACHEM, 2014).
- vi) Trueness of a measurement is an expression of how close the mean of an infinite number of results (produced by the method) is to a reference value. Since it is not possible to take an infinite number of measurements, trueness cannot be measured. However, a practical assessment of the trueness can be expressed in terms of bias. A practical determination of bias relies on comparison of the mean of the results (\bar{x}) from the candidate method with a suitable reference value ($\text{ref } x$).

⁵¹⁷ IUPAC. 1978. Nomenclature, symbols, units and their usage in spectrochemical analysis - II. Spectrochimica Acta, Part B, 33: 242

- v) Precision of a measurement is a measure of how close results are to one another. It is usually expressed by statistical parameters which describe the spread of results, typically the standard deviation (or relative standard deviation), calculated from results obtained by carrying out replicate measurements on a suitable material under specified conditions.
- vi) Uncertainty is not a performance characteristic of a particular measurement procedure, but is a property of the results obtained using that measurement procedure, is also a part of the validation procedure. According to EURACHEM (2014) “uncertainty is an interval associated with a measurement result which expresses the range of values that can reasonably be attributed to the quantity being measured. An uncertainty estimate should take account of *all recognized effects* operating on the result. The uncertainties associated with each effect are combined according to well-established procedures
- vii) Ruggedness (robustness) of an analytical procedure is a measure of its capacity to remain unaffected by small, but deliberate variations in method parameters. Ruggedness provides an indication of the method’s reliability during normal usage

3. Detailed guidelines for the full validation of analytical methods can be found in ISO Standard 17025 (2017), ICES (2004a) (UNEP/MED WG.492/Inf.13, Annex I), EURACHEM Guide (2014) and EURACHEM/CITAC 2016⁵¹⁸).

Internal laboratory Quality Control

4. After developing an analytical system suitable for producing analytical results of the required accuracy, it is important to establish a continuous control over the system and to show that all causes of errors remain the same in routine analyses. Therefore continuous quantitative experimental evidence must be provided in order to demonstrate that the stated performance characteristics of the method chosen remain constant (ICES 2004a), by regularly analysed alongside the samples Certified Reference Materials (CRMs), or an in-house Quality Control Material, which have been checked against a relevant CRM. The CRMs or QCMs should be of similar chemical composition, physical properties, and contaminant concentrations as the samples under investigation.

5. The ICES Marine Chemistry Working Group (MCWG) regularly publishes comprehensive list of suitable CRMs for marine monitoring programmes including certified determinant concentrations. Further information on CRMs can be obtained from the COMAR database (i.e. “The international database for certified reference materials” at <https://www.comar.bam.de>).

6. The International Atomic Energy Agency (IAEA) produces a variety of CRMs in different matrices, characterised for analytes belonging to one of the following groups: Radionuclides, Trace Elements and Methyl Mercury, Organic Compounds and Stable Isotopes (<https://www.iaea.org/services/laboratory-services/analytical-reference-materials-for-laboratories>). The on-line catalogue for the available CRMs can be found in the webpage <https://nucleus.iaea.org/sites/ReferenceMaterials/SitePages/Home.aspx>

7. A list of CRMs for heavy metals and organic contaminants in marine matrices (sediment, biota, seawater) prepared by ICES (2004a) are presented in UNEP/MED WG.492/Inf.13 (Annex I, pages 43-44). A list of available Reference Materials (RMs) and Certified Reference Materials (CRMs) prepared by IAEA (Marine Environmental Studies Laboratory) are presented in Annex I.

⁵¹⁸ EURACHEM/CITAC Guide: Guide to Quality in Analytical Chemistry: An Aid to Accreditation (3rd ed. 2016). ISBN 978-0-948926-32-7.

8. The means to demonstrate that the stated performance characteristics of the method chosen remain constant over time, is the completion of Analytical Quality Control Charts (AQCC). An Analytical Quality Control Chart example is the X-Chart, which can be applied using appropriate Certified Reference Materials for heavy metals and organic contaminants in marine matrices (sediment, biota and seawater). A guidance to use simple X-Charts, as well as other methods to perform internal laboratory Quality Control, is provided in ICES (2004a), including the following:

- i) Select an appropriate Certified Reference Material (CRM) to be analysed on a regular basis with environmental samples;
- ii) Analyse the CRM at least ten times for the given determinant. The analyses should be done on different days spread over a period of time to ensure that the full range of random errors (for within- and between-batch analyses) is covered. This enables a calculation of the total standard deviation (st);
- iii) Calculate the mean value (\bar{x}), the standard deviation (st), and the following values: $x + 2st$, $x - 2st$, $x + 3st$, $x - 3st$. Use these data to produce the plot.

9. If the data for the CRM follow a Normal distribution, 95% of them should fall within $x \pm 2st$ (between the Upper Warning Limit and Lower Warning Limit) and 99.7% should fall within $x \pm 3st$ (between the Upper Control Limit (UCL) and Lower Control Limit (LCL)) (Figure 1). However, if one result falls outside the warning limits, the analyst should not doubt the result or take any action provided that the next result falls within the warning limits. Also, if the results on more than 10 successive occasions fall on the same side of the X line (either between X and UWL or X and LWL) then the analyst needs to check the analytical procedure to determine the cause of this error.

10. For Biomarkers internal Quality Control, and to demonstrate that the analytical method applied is fit for the purpose of the investigations to be carried out, the Biomarkers QA responsible staff shall organise, at least once a year, a biomarker analysis using blind samples from control and polluted sites; the results will be reported in the Biomarker Analysis Register. It would be convenient that labs collect extra biological material during monitoring surveys to be used later in time as Biomarker internal Quality Control Material as CRM are not available.

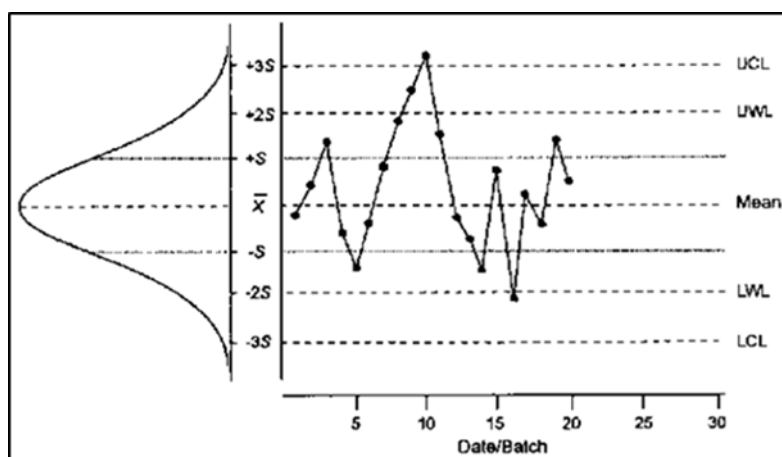

Figure 1. Analytical Quality Control Chart

External Quality Control

11. The use of validated analytical methods and the performance of internal routine quality control ensures the generation of reliable measurements results within the laboratory. However, laboratories have also to demonstrate that their results are comparable with the results provided by other

Mediterranean laboratories participating in implementation of the Integrated Monitoring and Assessment Programme of UNEP/MAP. Therefore laboratories should also participate in external quality assessment processes, i.e. Interlaboratory Comparisons and/or Proficiency Tests, organised by IAEA/MESL or other international/regional organisations, which provide an independent means to detect possible undiscovered sources of errors, demonstrating thus that the analytical quality control of the laboratory is effective.

12. Proficiency Tests for the determination of heavy metals and organic contaminants (petroleum hydrocarbons including (PAHs), polychlorinated biphenyls (PCBs) and several organochlorine (OC) pesticides) in sediment and biota (fish or bivalves) have been regularly organised since 1986 by UNEP/MAP – MED POL with the collaboration of the IAEA (Marine Environmental Studies Laboratory). In the framework of IMAP participation of designated laboratories in the yearly organised PTs for all target contaminants is mandatory.

13. The Proficiency Test for the determination of nutrients and chlorophyll-a in seawater has been piloted in the scope of QUASIMEME with assistance of UNEP/MAP – MED POL. However, considering a necessity of comprehensive assistance to support implementation of IMAP Common Indicators 13 and 14, related proposal for inter-calibration proficiency testing and training courses for nutrients and chlorophyll-a will be prepared.

14. In Proficiency Tests for biomarkers identical sub-samples (test materials) from a uniform homogenized and stable bulk material (sediment, biota or seawater) are sent to the participating laboratories, which are requested to analyse the sample independently of each another. The participating laboratories have to use the methods described in the related protocols as provided in the Guidelines for biomarker analysis CI18 of marine molluscs (such as *Mytilus sp.*) and fish (such as *Mullus barbatus*) (UNEP/MED WG.509/27; UNEP/MED WG.509/29). The protocols also describe in detail the equipment, the materials, the chemicals and methodologies to be used in the different biomarker analysis. (ICES, 2010⁵¹⁹, 2011⁵²⁰; OSPAR, 2013⁵²¹; Viarengo et al., 2000⁵²²).

15. Considering the results of the intercalibration exercise realised in the initial phase of the MEDPOL biomonitoring programme, as well as similar international monitoring programmes (e.g. the EU Funded Research Programme realized in 1998 “The Biological Effects Quality Assurance in Monitoring Programmes (BELQUAM)”; Project “Biological Effects of Environmental Pollution in marine coastal ecosystems” (BEEP) supported by EU in 2002; Background document and technical annexes for biological effects monitoring of OSPAR Commission, as updated in 2013), the inter-calibration testing is proposed to guarantee the comparability of the biomarkers data as provided in document (UNEP/MAP WG. 492/6). Due to the differences in the methodologies used for the collection of the data for different biomarkers, the intercalibration activities are elaborated separately for the four different biomarker analysis’ (i.e. for Intercalibration of Lysosomal Membrane Stability (LMS); Intercalibration of Micronuclei frequency (MNi); Intercalibration of Acetylcholinesterase activity (AChE) and Intercalibration of Stress on Stress (SoS)).

Follow-up actions

⁵¹⁹ ICES. 2010. Report of the ICES\OSPAR Workshop on Lysosomal Stability Data Quality and Interpretation (WKLYS), 13–17 September 2010, Alessandria, Italy. ICES CM 2010/ACOM:61

⁵²⁰ ICES. 2011. Report of the Study Group on Integrated Monitoring of Contaminants and Biological Effects (SGIMC), 14–18 March 2011, Copenhagen, Denmark. ICES CM 2011/ACOM:30

⁵²¹ OSPAR 2013. Background document and technical annexes for biological effects monitoring, Update 2013

⁵²² Viarengo, A.; Lafaurie, M.; Gabrielides, G.P.; Fabbri, R.; Marro, A., Roméo, M., 2000. Critical evaluation of an intercalibration exercise undertaken in the framework of the MED POL biomonitoring program. Mar. Environ. Res. 49, 1-18

16. Proficiency Tests provide objective information on the performance of laboratories in the analysis of contaminants, nutrients and biomarkers, indicating issues that need to be taken into consideration in order to improve performance, if necessary. Therefore, laboratories (especially those with unsatisfactory performance) should use the results of the Proficiency Tests for identifying the causes of their unsatisfactory performance in view of correcting them.

17. Laboratories that face data quality problems but are not in the position to resolve them internally should request external assistance for the identification and solution of potential causes of unsatisfactory performance. It is important to underline that good quality of data can only be achieved if the laboratory is strongly dedicated to improving its performance, as a continuous process.

18. It should also be noted, that during the last 30 years UNEP/MAP – MED POL with the assistance of the IAEA (MESL) organizes the hand-on training course to assist the Mediterranean laboratories to improve their analytical performance on the determination of heavy metals and organic contaminants in sediment and marine biota samples, complementary to the proficiency testing. In the future, these training courses should primary target laboratories showing unsatisfactory performance. Following experience in organization of the training courses for IMAP Common Indicator 17, UNEP/MAP – MEDPOL has prepared the proposal of training course aimed at strengthening of the analytical capacities of IMAP competent laboratories to implement IMAP Common Indicator 18 as provided in (UNEP/MAP WG. 492/6).

2.4 Protocol on QA in Reporting of Data

19. Data quality assurance requires a proper design of functions to ensure a smooth flow of the monitoring process, which starts with the sample collection and ends with the data reporting in the appropriate format (UNEP/MAP 2019b). Therefore, reporting of data and metadata of IMAP is an important task, which has to be implemented by National Laboratories guaranteeing the traceability of the datasets (ICES, 2004a).

20. A UNEP/MAP Monitoring Guideline on Reporting Monitoring Data for IMAP Common Indicators 13, 14, 17, 18 and 20, as provided in UNEP/MED WG.509/33 provides detail reporting templates for IMAP Common Indicators 13, 14, 17, 18 and 20. The objective of this Monitoring Guideline is to assist the laboratories working in marine monitoring to report analytical data in line with the content, format and structure of the database and relationship between its different elements as requested in relevant IMAP Data Standards (DSs) and Data Dictionaries (DDs).

21. An important insight into the data flows for QA in marine pollution monitoring is to ensure, as much as possible, that the generated data at each process is quality assured by two or more persons, which might not have participated in the chain of analytical procedure (e.g. sampling, processing, analysis and reporting). This means that if solely a person participated in the sample processing and analytical determinations, he/she should not be the solely person performing the reporting/registry QA for the entire process. This is applicable to all the processes including the final reporting from IMAP users (i.e. MEDPOL Focal Points and national IMAP competent laboratories) to IMAP Info System, which should be checked by a second staff member. In brief, the person(s) that does the operations could not be the same that performs the quality assurance (QA) for a given process and data reporting (UNEP/MAP, 2019a).

22. For analytical data for IMAP Common Indicators 13, 14, 17, 18 and 20, Quality Assurance information, such as inter-laboratory performance results should be included in the Reporting Templates, with automatic flagging of categories according to the QA information (z scores). The UNEP/MAP document on Quality Assurance / Quality Control (UNEP/MAP, 2019a) proposes five Data QA categories to be flagged in the Reporting Templates for IMAP Common Indicators of Ecological Objectives 05 and 09:

- Category A (CI13, CI14, CI17, CI20). Laboratories/Contracting Parties reporting successful Proficiency testing ($|z| \leq 2$) and/or accreditation for the chemical or parameter analysed; metadata completed and timely submitted (max 2 years delay).
- Category A (CI18). Laboratories/Contracting Parties reporting successful Proficiency testing and/or accreditation for the biomarkers or parameter analysed; metadata completed and timely submitted (max 2 years delay).
- Category B (CI13, CI14, CI17, CI20). Laboratories/ Contracting Parties reporting Proficiency testing for the chemical or parameter analysed ($2 < |z| < 3$) and/or accreditation; metadata completed and timely submitted (max 2 years delay).
- Category B. (CI18). Laboratories/ Contracting Parties reporting Proficiency testing for the biomarkers or parameter analysed and/or accreditation; metadata completed and timely submitted (max 2 years delay).
- Category C. Laboratories/ Contracting Parties with no participation in Proficiency testing (for the last 2 years); metadata completed and timely submitted. It also could include scientific literature with full QA reported.
- Category D. Laboratories/ Contracting Parties with no participation in Proficiency testing (for the latest 5 years); metadata completed but not timely submitted. It also includes scientific literature without QA specifically reported.
- Category E. Laboratories/ Contracting Parties with gross reporting errors, although might be completed and timely submitted.

23. The ‘flagging quality’ scheme based on the Database QA and Reporting Procedures will help to develop an accurate assessment with known source of uncertainty, as well as to boost the national capabilities and resources to fit the requirements.

24. The IMAP Info System includes Data Controls (i.e. algorithms to set the range of acceptable values), such as:

- Minimum and maximum values allowed for a parameter;
- Valid concentration range of the parameter;
- Limit of Detection (LOD);
- Limit of Quantification (LOQ).

Annex I**List of Reference Materials (RMs) and Certified Reference Materials (CRMs) produced by the IAEA (Marine Environmental Studies Laboratory) for heavy metals and organic contaminants in marine matrices (sediment and biota)**

Reference Material	Matrix	Analyte Group	Type of certificate
IAEA 406	Fish Homogenate	OC	RM
IAEA 417	Marine sediment	OC	RM
IAEA 432	Mussel Homogenate	OC	RM
IAEA 435a	Tuna Homogenate	OC	RM
IAEA 451	Clams Whole Body	OC	CRM
IAEA 459	Marine sediment	OC	CRM
IAEA 477	Sediment	OC	CRM
IAEA 314	Stream Sediment	TE	RM
IAEA 392	Algae	TE	RM
IAEA 413	Algae	TE	RM
IAEA 407	Fish Muscle	TE + MeHg	RM
IAEA 158	Marine sediment	TE + MeHg	RM
IAEA 436a	Tuna Homogenate	TE + MeHg	CRM
IAEA 450	Algae	TE and Platinum	CRM
IAEA 452	Scallop Whole Body	TE + MeHg	CRM
IAEA 456	Marine sediment	TE + MeHg	CRM
IAEA 457	Marine sediment	TE	CRM
IAEA 458	Marine sediment	TE + MeHg	CRM
IAEA 461	Clams Whole Body	OC	CRM
IAEA 470	Oyster Whole Body	TE + MeHg	CRM
IAEA 475	Marine sediment	TE + MeHg	CRM
IAEA 476	Fish Homogenate	TE + MeHg	CRM

TE: Trace Elements; MeHg: Methyl Mercury; OC: Organic Contaminants (Chlorinated HCs and PAHs); RM* (Reference Material); CRM** (Certified Reference Material)

*A Reference Material is a material one or more of whose property values are sufficiently homogeneous and well established to be used for the calibration of an apparatus. The assessment of a measurement method, or for assigning values to materials.

**A Certified Reference Material is a Reference Material accompanied by a certificate, one or more of whose property values are certified by a procedure which establishes its traceability to an accurate realization of the unit in which the property values are expressed, and for which each certified value is accompanied by an uncertainty at a stated level of confidence.

References

EURACHEM Guide: The Fitness for Purpose of Analytical Methods – A Laboratory Guide to Method Validation and Related Topics, (2nd ed. 2014). B. Magnusson and U. Ornemark (eds.) ISBN 978-91-87461-59-0. Available from www.eurachem.org.”

EURACHEM/CITAC Guide: Guide to Quality in Analytical Chemistry: An Aid to Accreditation (3rd ed. 2016). ISBN 978-0-948926-32-7. Guidelines on quality assurance

HELCOM (2012a). Manual for marine monitoring in the COMBINE programme. Annex B-13, Appendix 2. Technical note on the determination of chlorinated biphenyls in marine sediment

HELCOM (2012b). Manual for marine monitoring in the COMBINE programme. Annex B-13, Appendix 1. Technical note on the determination of Polycyclic Aromatic Hydrocarbons (PAHs) in sediment

ICES (2004a). ICES Techniques in Marine Environmental Sciences, No 35. Chemical measurements in the Baltic Sea:

ICES (2004b). Biological monitoring: General guidelines for quality assurance. Ed. by H. Rees. ICES Techniques in Marine Environmental Sciences, No. 32.

ICES. 2010. Report of the ICES/OSPAR Workshop on Lysosomal Stability Data Quality and Interpretation (WKLYS), 13–17 September 2010, Alessandria, Italy. ICES CM 2010/ACOM:61

ICES. 2011. Report of the Study Group on Integrated Monitoring of Contaminants and Biological Effects (SGIMC), 14–18 March 2011, Copenhagen, Denmark. ICES CM 2011/ACOM:30

ICES/OSPAR (2018a). CEMP Guidelines for Monitoring Contaminants in Sediments. Technical Annex 6: Determination of metals in sediments – analytical methods.

ICES/OSPAR (2018b). CEMP Guidelines for Monitoring Contaminants in Sediments. Technical Annex 2: technical annex on the analysis of PCBs in sediments

ICES/OSPAR (2018c). CEMP Guidelines for monitoring contaminants in sediments. Technical Annex 3: Determination of parent and alkylated PAHs in sediments

ISO GUIDE 80:2014. Guidance for the in-house preparation of quality control materials (QCMs)

ISO/IEC 17025:2017. General requirements for the competence of testing and calibration laboratories

IUPAC. 1978. Nomenclature, symbols, units and their usage in spectrochemical analysis - II. *Spectrochimica Acta*, Part B, 33: 242

OSPAR 2013. Background document and technical annexes for biological effects monitoring, Update 2013

UNEP/MAP (2019a) UNEP/MED WG.467/13. Schemes for Database Quality and Quality Assurance and Quality Control (QA/QC) of data related to pollution

UNEP/MAP (2019b). UNEP/MED WG.467/8. IMAP Pilot Info System and relate Quality Assurance Issues; Data Standards and Data Dictionaries; MAP Data Management Policy.

USEPA (2017). Field sampling quality control: operational procedure. SESDRPROC-011-05

Viarengo, A.; Lafaurie, M.; Gabrielides, G.P.; Fabbri, R.; Marro, A., Roméo, M., 2000. Critical evaluation of an intercalibration exercise undertaken in the framework of the MED POL biomonitoring program. *Mar. Environ. Res.* 49, 1-18

Appendix 28

**Monitoring Guideline for Reporting Monitoring Data for IMAP Common
Indicators 13, 14, 17, 18 and 20**

1. Introduction

- Reporting is an important step within the monitoring process of the marine environment. Through proper reporting assessment of GES regarding Ecological Objectives 5 and 9, as presented in detail in the IMAP Guidance Factsheets (UNEP/MAP, 2019)⁵²⁴ will be allowed and maintained.
- Hence this Guideline on Reporting Monitoring Data for IMAP Common Indicators 13, 14, 17, 18 and 20, elaborates the protocols for data reporting to IMAP/Info System, along with detail guidance on applying necessary procedures, addressing weak points and resolving the problems.
- This Guideline builds upon the UNEP/MAP Integrated Monitoring and Assessment Programme (IMAP) respectively IMAP Guidance Fact Sheets for IMAP Common Indicators 13, 14, 17, 18 and 20 (UNEP/MAP, 2019); standardized protocols (UNEP/MAP, 2019a)⁵²⁵; Data Quality Assurance schemes (UNEP/MAP, 2019b)⁵²⁶; Data Standards (DSs) and Data Dictionaries (DDs) for Common Indicators related to Pollution and Marine Litter (UNEP/MAP, 2019c)⁵²⁷ and IMAP Pilot Info System: Quality Assurance and Quality Controls (UNEP/MAP, 2019d)⁵²⁸ in order to allow the comparability of the data for reliable assessment of GES.
- The below flow diagram informs on the category of this Monitoring Guidelines related to reporting of monitoring data within the structure of all Monitoring guidelines prepared for IMAP Common Indicators 13, 14, 17, 18 and 20.

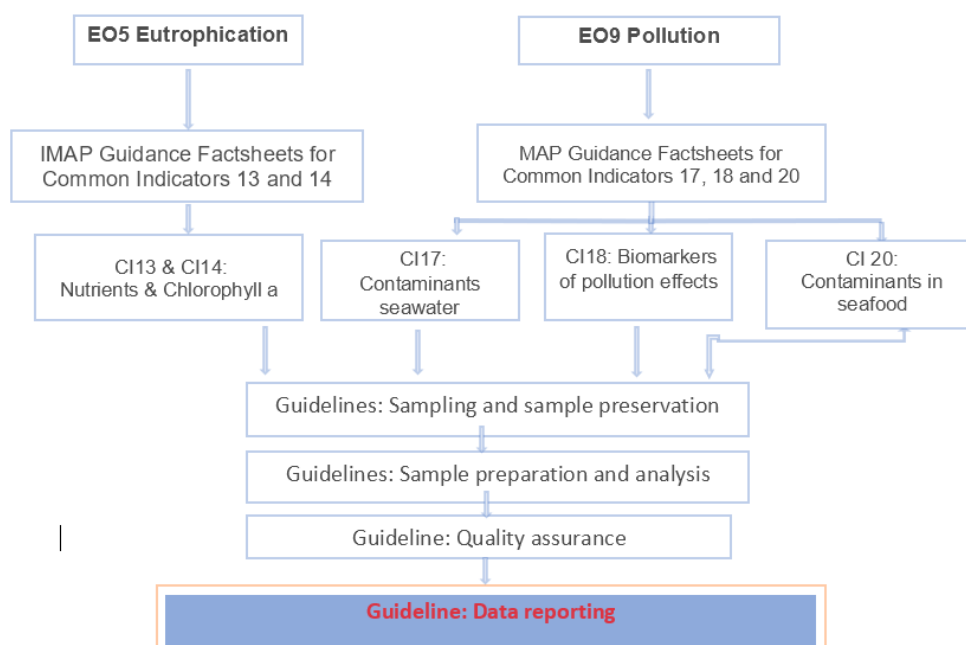

Flow Diagram: Monitoring Guidelines for IMAP Ecological Objectives 5 and 9.

⁵²⁴ (UNEP/MAP, 2019), UNEP/MED WG.467/5. IMAP Guidance Factsheets: Update for Common Indicators 13, 14, 17, 18, 20 and 21: New proposal for candidate indicators 26 and 27.

⁵²⁵ (UNEP/MAP, 2019a), UNEP/MED WG.463/6. Monitoring Protocols for IMAP Common Indicators related to pollution.

⁵²⁶ (UNEP/MAP, 2019b), UNEP/MED WG.467/13. Schemes for Quality Assurance and Control of Data related to Pollution

⁵²⁷ UNEP/MAP, 2019c. UNEP/MED WG.467/8. Data Standards and Data Dictionaries for Common Indicators related to Pollution and Marine Litter

⁵²⁸ (UNEP/MAP, 2019d). UNEP/MAP WG. 467/12. MAP Pilot Info System: Quality Assurance and Quality Controls

Data quality

5. The 'data quality' management process is without a doubt the most important component of the overall data management system structure to ensure 'quality data'. The data management involves data policy, data warehousing, and data security components, only to mention a few. However, 'quality data' should guide and support any data-related endeavour, such as the gathering of environmental information through scientific-based monitoring strategies to assess the status of the marine environment (e.g. IMAP of UNEP /MAP).

6. The 'data quality' approach is a common approach to ensure, control and optimize the value of data from observations in all fields, including science, medicine, business, and politics. However, the 'data quality' concept has many functional attributes.

7. The building of databases for the collection and use of the monitoring data and pollution load data was seen as a necessity very early within the MED POL Programme. The Monitoring MED POL Database (ca. Microsoft Access SQL database software) was created and included some components and modules, such as plotting and mapping, trend analysis, a remote access module, etc., in an all-in-one approach.

8. At that time, the overall 'data quality' protocol was based on the internal procedures in place. Briefly, once the dataset files were received from the Contracting Parties, the officer in charge sent the files to the database managers to perform the automatic upload of the data into the database. If problems were encountered during the uploading of the data, a report was produced and sent back to the Contracting Parties for review, correct and officially resubmit the data.

9. Although this was the most logical procedure, it faced several technical difficulties such as i) the data sent back to the Contracting Parties could be delayed or new problems were found after resubmission; ii) the flagging function from the database could be used only by experts; iii) the errors detected cannot be sorted out easily (e.g. sometimes a digit or a different 'parameter name' invalidates the automatic loading); iv) the submission of 'out of range' values, which were the main causes of the limited direct database applicability for the regional marine assessments. To this aim, it has been decided to shift to an on-line system since 2007-2008.

10. The adoption of the Integrated Monitoring and Assessment Programme (IMAP) of the Mediterranean Sea and Coast and Related Assessment Criteria (Decision IG. 22/7, COP 19, February 2016) furthermore increased the need for even more and larger datasets. For this reason, and due to the fast developments in information systems and technologies, the Secretariat commissioned the development of a new database to the INFO/RAC.

11. IMAP (Pilot) Info System has been built to strengthen the capacities for data management, along with data reporting, quality assurance and quality controls (UNEP/MAP, 2019d, UNEP/MAP WG. 467/12). The new data management structure allows for an improved data management that is fit-for-purpose for the requirements of the IMAP (i.e. the Barcelona Convention marine monitoring system).

12. The schemes for Quality Assurance and Control of Data for IMAP (Pilot) Info System have been defined on two levels, as elaborated in UNEP/MAP, 2019b, UNEP/MED WG.467/13 (UNEP/MED WG. 492/Inf.14). On the first level, there is a monitoring data Quality Assurance and Quality Control (QA/QC) for each IMAP Common Indicator; on the second level, there is a full Database Quality Management and Reporting Schemes considering present functional modules (i.e. MEDPOL Database approach), both for data technical validation and data flagging.

13. Generic QA schemes are defined for IMAP Pollution Cluster Common Indicator to be measured and reported at the primary level (Table 2 of UNEP/MAP, 2019b). It further describes both the QA Schemes and QA Categories for each Common Indicator according to its specificities and overall 'data quality' needs to be reported by the Contracting Parties to IMAP (Pilot) Info System

(Tables 4a and 4b, of UNEP/MAP, 2019b). Level 1 of QA/QC provides the scheme for data quality assurance, whilst Level 2 provides the scheme for quality assurance of data assessment.

14. There are basic attributes (i.e. specific requirements of the ‘data’ within the overall quality framework) to be fulfilled to guarantee both the ‘data quality’ from an objective point of view and their fit-for-purpose, under the overall Database Quality Management, including the Reporting Schemes. The completeness, accuracy, consistency, timeliness, accessibility and validity are the main attributes to be fulfilled to obtain ‘quality data’ reported to the IMAP Info System. This is elaborated in UNEP/MED WG.492/7, providing the Monitoring Guidelines/Protocols for Analytical Quality Assurance for IMAP Common Indicators 13, 14, 17, 18 and 20, as well as in UNEP/MED WG.467/13 (UNEP/MED WG. 492/Inf.14).

15. The achievement of these basic attributes guarantees the ‘data quality’ and should be considered during all the planning process of the data generation, from data collection and reporting, through data storage, up to the data usage by interested parties. The new IMAP (Pilot) Info System platform is designed to facilitate these procedures through data quality algorithms built to support data loading by the Contracting Parties.

16. The first step of the QA process of IMAP (Pilot) Info System (UNEP/MAP, 2019d) has been the definition of Data Standards (DSs) and Data Dictionary (DDs) and associated formal Quality Controls for the monitoring modules associated to the selected 11 IMAP Common Indicators. They aggregate information in different tables (represented by excel spreadsheets) and, for each table, several fields with different formats are defined. When a field has to be filled by selecting a value included in a predefined list of admissible values, such lists constitute the DD associated to DS. Data are compliant to DSs and DDs if all of the following formal quality controls are satisfied: format; unique coding; coherent linking; regular expression and admissible values.

17. The second step of QA process of IMAP (Pilot) Info System (UNEP/MAP, 2019d) requires implementation of formal Quality Controls associated to each DSs and DDs in order to verify compliance of data. In particular, for each DS that corresponds to a monitoring module, the above list of formal quality controls has been defined and implemented in the IMAP (Pilot) Info System. Each row in the list is represented by QC_Code; IMAP Ecological Objective; Common Indicator; DS/module; spreadsheet; field and description.

18. The process for the collection and quality control of data sets reported into IMAP (Pilot) Info System is implemented for each data standard by the three-way handshaking communication (UNEP/MAP, 2019d):

- Step 1: the user, respectively a Contracting Party, downloads the Data Standard corresponding to the monitoring module for which there is a need to transfer monitoring data;
- Step 2: after filling the Data Standard with monitoring data, the user uploads the file into the system for the data flow which corresponds to the Data Standard used;
- Step 3: The system produces a report of QC formal check validation, with the results of formal quality control applied to the file uploaded and if every quality control is passed, the file is considered as ‘formally compliant’ (OK!); otherwise as ‘formally non - compliant’ (Not OK) and the user has to correct the file and upload it again into the system in order pass all the formal quality controls.

19. The report of QC formal check validation is produced as an excel file containing the information for each row that does not pass the quality control check. Formally compliant data sets, i.e. data that pass above presented the formal Quality Controls, are stored in the Relational Data Base Management System (RDBMS) of the IMAP (Pilot) InfoSystem.

20. Further application of a higher level Database Quality Controls considers (UNEP/MAP, 2019d), for example, the following issues:

- Check of admissible ranges or maximum or minimum values for parameters based on statistical analysis of monitoring data; scientific literature reviews and/or fixed constraints due to physical or chemical characteristics, as for example, the range 0-14 of pH;
- Geographical location of monitoring stations.

21. Quality Assurance process for data quality also includes application of additional higher level Quality Controls that needs to be applied for the implementation of the standardized and harmonized monitoring practices related to a specific IMAP Common Indicator (i.e. sampling, sample preservation and transportation, sample preparation and analysis). These Quality Controls are directly related to data quality and control procedures of national IMAP competent laboratories, which include the accreditation process, use of certified reference material or standardized monitoring protocols, participation of laboratory to proficiency testing, etc., and elaborated in the Monitoring Guidelines/Protocols for Analytical Quality Assurance for IMAP Common Indicators 13, 14, 17, 18 and 20 (UNEP/MED 492/7) for consideration during present Meeting.

22. It should be noted, that the IMAP (Pilot) Info System has been designed to further implement higher level Quality Controls, as elaborated above, as well as to collect additional information on laboratory data quality and control procedures and implementation of Monitoring Guidance/ Protocols as discussed and agreed by the Integrated Meetings of the Ecosystem Approach Correspondence Groups on IMAP Implementation (CORMONs) held from 1-3 December 2020 and the present Meeting of the Ecosystem Approach Correspondence Group on Pollution Monitoring. Such information are included in specific DDs and DSs and linked to monitoring data in order to apply a categorization for flagging data sets for EO5 and EO9 (i.e. Category A, Category B, Category C, Category D, Category E), as provided in UNEP/MAP 2019b (UNEP/MED WG. 492/Inf.14).

23. It should be noted that the migration of data from the Monitoring MED POL Database to IMAP Pilot Info System has been completed, therefore providing an access to monitoring data in the format of IMAP (Pilot) Info System Data Dictionaries. Furthermore, reporting of data was continued during the testing phase of IMAP Info System, as well as since being launched in July 2020.

Data quality organizational levels

24. In order to guarantee the quality of the IMAP (Pilot) Info System, and well as the previous MED POL Database, the relevant roles and responsibilities in terms of database quality management have been defined (i.e. from the sample collection until the use of the final validated data) to ensure that the quality chain is followed by the Contracting Parties.

25. There are basically three groups of stakeholders within the data management system, as elaborated in UNEP/MAP, 2019b (UNEP/MED WG. 492/Inf.14). Namely, the Contracting Parties' IMAP competent laboratories (i); the ministry or delegated national agency with the responsibility to report monitoring data to IMAP (Pilot) Info System (ii) on behalf of the respective MED POL Focal Points (iii), corresponding to a primary, secondary and tertiary levels in the data quality chain.

26. Each level has a different degree of responsibility to fulfil the 'data quality' attributes to ensure the usefulness of the monitoring data at national and regional scales within the implementation of IMAP. These three organizational levels of responsibility for 'data quality' management and data flows, provide the basis for a common understanding of the 'data quality' requirements and serve to the establishment of the 'data quality' categories.

2. Technical Note for reporting Monitoring Data for IMAP Common Indicators 13, 14, 17, 18 and 20

27. This Technical Note interrelates the procedures for reporting of monitoring data with the Data Standards (DSs) and Data Dictionaries (DSs)⁵²⁹ as agreed and built into IMAP (Pilot) Info System for IMAP Common Indicators 13, 14 and 17, as well as defines the elements for data reporting for IMAP Common Indicators 18 and 20 in order to guide ongoing preparation of the Data Standards (DSs) and Data Dictionaries (DSs) for IMAP Common Indicators 18 and 20. To that effect, under this Technical Note, this Monitoring Guideline provides the following IMAP Protocols for reporting of monitoring data:

- Protocol for reporting Monitoring Data for IMAP Common Indicators 13 and 14;
- Protocol for reporting Monitoring Data for IMAP Common Indicators 17;
- Protocol for reporting Monitoring Data for IMAP Common Indicators 18; and
- Protocol for reporting Monitoring Data for IMAP Common Indicators 20.

2.1 Protocol for Reporting Monitoring Data for IMAP Common Indicators 13 and 14

28. Considering the already developed DSs and DDs for CI13 and CI14 (UNEP/MAP 2019c), being built into IMAP Info System, as well as the IMAP Guidance factsheets for CI13 and CI14 (UNEP/MAP (2019b)), the following two procedures on reporting monitoring data related to IMAP CI13 and CI14 needs to be applied: a) reporting data related to sampling stations, and b) reporting data related to eutrophication.

29. *The DSs and DDs for stations* for CIs 13 and 14 are structured around data sets that are defined as mandatory in relevant IMAP Guidance Factsheets. Therefore, there is a need to report the following data: i) country code; ii) national station ID; iii) national station name; iv) latitude and longitude of station; vi) TCM matrix-water column; vii) station distance from the coast in km; viii) sea depth in meters, and ix) typology of the monitored area (R = Reference, C = Coastal, HS = Hot spot, O = Other) and x) Remarks (notes). However, there is also a possibility to fill in non-mandatory data (i.e. region - administrative subdivision of first level to which the station belongs and pressure type) as to allow for the CP that already have monitoring systems in place collecting a wider set of data to also report them as additional data sets.

30. *The DDs and DDs for eutrophication* are structured around data sets related to CIs 13 and 14 that are defined as mandatory parameters in relevant IMAP Guidance Factsheets. Specifically, there is a need to report data related to i) country code as ISO two digits; ii) national station ID; iii) year, month, day and time of sampling; vii) sample code; viii) name of the physico-chemical parameter or of the nutrient; ix) unit of measurement of the physico-chemical parameter or nutrient; x) LOD_LOQ_flag; xi) concentration measure; xii) sample depth in meters and xiii) analytical method in line with IMAP, as a variety of methods exists (e.g. Chlorophyll a concentration - spectrophotometer, fluorometer, HPLC, in situ) for measurements with different underlying variability, along with a coding list for the used Analytical Methods, corresponding to a combination of analyte and methods.

31. Annex I provides both DDs for reporting on CIs13 and 14 for stations and eutrophication mandatory parameters as follows: Table 1. Station Information; Table 2. Physicochemical information; Table 3. List of physicochemical parameters, as they have been approved by the 7th Meeting of the Ecosystem Approach Coordination Group, held on 9 September 2019 (Athens, Greece), and consequently made operational for data reporting within IMAP Pilot Info System.

2.2 Protocol for Reporting Monitoring Data for IMAP Common Indicators 17

⁵²⁹ DSs and DDs are a set of information describing the content, format and structure of a database and relationship between the elements. DSs are prepared in a form of Excel spreadsheets in which every row indicates a field to be filled by the data providers, aligned with the current MED POL Database for the common cases. The DSs are accompanied by DDs provided in a form of a column next to each Data Standard or excel spreadsheet to guide the data provider.

32. Considering that the already developed DSs and DDs for CI17 (UNEP/MAP 2019c) are being built into IMAP Pilot Info System, as well as the IMAP Guidance Factsheets for CI17 (UNEP/MAP (2019b)), the following two procedures on reporting monitoring data related to IMAP CI17, need to be applied: a) reporting data related to sampling stations and b) reporting data related to contaminants.

33. *The DSs and DDs for stations* for CI 17 are structured around data sets that are defined as mandatory in relevant IMAP Guidance Factsheet. Therefore, there is a need to report the following data: i) country code; ii) national station ID; iii) national station name; iv) latitude and longitude of station; vi) TCM matrix (Biota, Sediment, Seawater or a combination of these matrices); vii) bottom depth in meters; viii) typology of the monitored area (R = Reference, C = Coastal, HS = Hot spot, O = Other) and pressure type (IP = industrial plants, MT = Maritime Traffic). However, there is also a possibility to fill in non-mandatory data i.e. region - administrative subdivision of first level to which the station belongs and closest coast in km as to allow for the CP that already have monitoring systems in place collecting a wider set of data to also report them as additional data sets.

34. *The DDs and DSs for contaminants* are structured around data sets related to CI 17 that are defined as mandatory parameters in related IMAP Guidance Factsheets (UNEP/MAP, 2019b). Specifically, there is a need to report data related to: i) country code as ISO two digits; ii) national station ID; iii) year, month, day and time of sampling; vii) sample ID - code; viii) sample matrix (seawater, sediment, biota); ix) name of the contaminant (Label in list of contaminants); x) ID of the contaminant (ID in list of contaminants); xi) CAS number of the contaminant; xii) unit of measurement of the contaminant; xiii) dry (DW) or wet weight (WW) for sediment and biota; xiv) <LOD_<LOQ_flag; xv) concentration value; xvi) sample depth in meters and xvii) salinity (psu) and temperature (°C); xviii) dissolved oxygen concentration; xix) sediment fraction (max size in µm); xx) sediment depth in m; xx) biota species ID (ID list_species); xxi) biota species name (Label List_species); xxii) specimen length in cm and specimen length standard deviation (specimens in pool in cm); xxiii) specimen weight in g and specimen weight standard deviation (specimens in pool in g); xxiv) pooling (content of pooling and number of specimens); xxv) extractable organic matter in mg g⁻¹; xxvi) tissue (for biota – fluids, eggs, tissues, kidney, liver, muscle, other, soft tissues); xxvii) fat content (percentage of total wet matter); xxviii) analytical method in line with IMAP, as a variety of methods exists (e.g. metal concentration – AAS, GC-AAS, ICP-MS; organic contaminant concentration – GC-ECD, GC-MS, HPLC) for measurements with different underlying variability, along with a coding list for the used Analytical Methods, corresponding to a combination of analyte and methods; xxix) LOQ; xxx) Emodnet codeP01 (code of the parameter/EMODNet method according to List_dictionary_P01); xxxi) Remarks (notes). There is also a possibility to fill in non-mandatory data (i.e. for sediment matrix: grain type, Total Carbon %, Total Organic Carbon %, Total Inorganic Carbon %, Total Nitrogen %) as to allow for the CP that already have monitoring systems in place collecting a wider set of data to also report them as additional data sets.

35. The list of reference for the CI 17 on chemicals, which is also in use by the European Environmental Agency (EEA, WISE-Marine) includes either the CAS numbers (Chemical Abstract Service reference number) or the EEA reference number (for particular EEA requirements). The mandatory reporting is foreseen only for the biota and sediment matrices as agreed under IMAP Guidance Factsheets (UNEP/MAP, 2019b) and for specific compounds under each Common Indicator, despite any other substance and matrix can be reported by applying then harmonized CAS number. For Biota matrices, a list with the codes of reference species is provided in Annex I.

36. Annex I provides both DDs for Reporting on CI17 for stations and contaminants mandatory parameters as follows: Table 4. Station Information; Table 5. Contaminants' information; Table 6. List of mandatory contaminants; Table 7. List of reference species, as they have been approved by the 7th Meeting of the Ecosystem Approach Coordination Group, held on 9 September 2019 (Athens, Greece), and consequently made operational for data reporting within IMAP Info System.

2.3 Protocol for Reporting Monitoring Data for IMAP Common Indicators 18

37. The DSs and DDs specific for CI18 Stations and Contaminants are under preparation by UNEP/MAP (MEDPOL and INFO/RAC). In line with the structure and content of DDs for CI17, the

present document provides elements for building DSs and DDs for CI18, as provided in Annex II. Similarly to procedure established for CIs 13, 14 and 17, the following two procedures on reporting monitoring data related to IMAP CI18 are proposed: a) reporting data related to sampling stations and b) reporting data related to biomarkers.

38. *The proposed DSs and DDs for stations and parameters* related to CI18 are structured around data sets that are defined as mandatory in relevant IMAP Guidance Factsheet. Annex II provides both proposals of DDs for Reporting on CI18 for stations and biomarkers mandatory parameters as follows: Table 1. Station Information, Table 2. List of mandatory biomarkers, Table 3. Biomarker information and Table 4. List of reference species. The organisms that should be analysed are for molluscs the *Mytilus* sp. and for fish *Mullus barbatus*.

39. In line with above protocol for reporting monitoring data for IMAP CI 18, the elements of Data Standards (DS) and Data Dictionaries (DDs) specific for CI 18 are prepared, as presented in Annex II, for receiving the suggestions of present Meeting and guiding further work of INFO/RAC and MEDPOL.

2.4 Protocol for Reporting Monitoring Data for IMAP Common Indicators 20

40. Taking into consideration already developed DSs and DDs for CI17 (UNEP/MAP 2019c), as well as the IMAP Guidance factsheets for CI20 prepared by UNEP/MAP (2019b), the following two procedures on reporting monitoring data related to IMAP CI20 are proposed: a) reporting data related to sampling stations and b) reporting data related to contaminants.

41. *The DSs and DDs for stations* related to CI20 are structured around data sets that are defined as mandatory in relevant IMAP Guidance Factsheet. Sampling stations may be at sea (on board of a fishing boat) or on land (fishing port or fish market). Therefore, each seafood sampling lot must be traced back unambiguously to the sub-region where the organisms were initially captured. Therefore, DDs for stations should include information as for CI17, in order to be able to relate environmental quality data (CI17) with seafood safety data (CI20): i) Country code; ii) Station code (sampling); iii) Station name (sampling); iv) Station geographical coordinates (sampling); v) Seafood species; vi) Station code (where seafood samples were initially captured); vii) Station name (where seafood samples were initially captured); viii) Station geographical coordinates (where seafood samples were initially captured) and ix) Additional information on the area of organism's capture (such as fishing area code, area name, coordinates, date of fishing, etc.)

42. *The DDs and DSs for contaminants* related to CI 20 for characteristic parameters including contaminants information and the List of reference on chemicals are not yet developed for CI20, but they can be based on the DDs (contaminants information), which have been developed by INFO/RAC and MED POL for CI17 (UNEP/MAP 2019c).

43. The list of reference for the CI 17 on chemicals is also in use by the European Environmental Agency (EEA, WISE-Marine) and includes either the CAS numbers (Chemical Abstract Service reference number) or the EEA reference number (for particular EEA requirements). The IMAP Guidance Factsheet related to CI 17 contains the agreed chemical compounds and those can be found in the EEA list with its CAS number. The mandatory reporting is foreseen only for the biota and sediment matrices as agreed under relevant IMAP Guidance Factsheets and for specific compounds under each Common Indicator, despite any other substance and matrix can be reported by applying then harmonized CAS number. For Biota matrices, a list with the codes of reference species is provided.

44. For the CI20, contaminants' levels should also be expressed in absolute figures and not only in relation to the regulatory level (i.e. above or below the regulatory level). Regulatory levels for the protection of human health as presented in EU Regulations (EC) No 1881/2006, (EC) No 835/2011 and EC No 1259/2011 (Annex III) are usually high in relation to the normal ambient concentrations of contaminants in marine organisms. However, recording the absolute concentration (and not the relative above/below the regulatory level information) triggers a warning signal in the event of an ascending

trend of contaminants concentrations, even if these concentrations are still below the regulatory limit. It has to be underlined that concentrations below regulatory levels are not necessarily indicators of good environmental status, since environmental effects might be present at lower concentrations (JRC, 2010). Furthermore, recording the absolute concentration of pollutants generate data for contaminants, which may not be regulated yet but which might be regulated in the future.

45. The concentration limits for the regulated contaminants in the EU are presented in a concise format in Annex III. The list of contaminants includes Cd, Hg, Pb, four PAHs (benzo(a)pyrene, benz(a)anthracene, benzo(b)fluoranthene and chrysene), dioxins, dioxin-like and non-dioxin-like PCBs and radionuclides. Non-regulated contaminants could be included in the CI20 monitoring programme, but for the time being no concentration limits are set in the EU legislation.

46. Integration of monitoring data for CI20 should be made with care. JRC (2010) suggests taking into account “the frequency that levels exceed the regulatory levels, the actual levels that have been detected, the number of contaminants for which exceeding levels have been detected and in parallel the origin of the contamination (geological versus anthropogenic, local versus or long distance)”. Also “further an intake assessment taking into account the importance in the human diet of the species showing the exceeding levels could be taken into account” (JRC, 2010). If regulatory levels are exceeded in one species, that doesn’t mean that all seafood consumption from this sub-region is dangerous.

47. In line with above protocol for reporting monitoring data for IMAP CI 20, elements of Data Standards (DS) and Data Dictionaries (DDs) specific for CI 20 are proposed, as presented in Annex III, for receiving the suggestions of present Meeting and guiding further work of INFO/RAC and MEDPOL.

Annex I:**Data Standards and Data Dictionaries for IMAP Common Indicators 13, 14 and 17****ECOLOGICAL OBJECTIVE 5: Common Indicators 13 and 14****Table 1:** Data Dictionaries (stations information) for CI13 and CI14.

Field	Description	List of values
Country Code	Enter member country code as ISO two digits, for example "IT" for Italy.	
National Station ID	Station code	
National Station Name	Station name	
Region	Administrative first level subdivision to which the station belongs to	
Latitude	Latitude of the station in the WGS84 decimal degrees reference system with at least 5 digits (xx.xxxxx).	
Longitude	Longitude of the station in the WGS84 decimal degrees reference system with at least 5 digits (xx.xxxxx). Use positive values without '+' before numbers (for ex. 13.98078) for coordinates east of the of the Greenwich Meridian (0°) and negative values with '-' for coordinates west of the Greenwich Meridian (0°) (for ex. -2.6893).	
Closest Coast	Station distance from the coast in km	
TCM Matrix	Measure of seawater at the station	W = Sea water column
Sea Depth	Sea depth in meters	
Area Typology	Typology of the monitored area enter one of the values in the list	R = Reference C = Coastal HS = Hot spot O = Other
Pressure Type	If the monitoring station id dedicated to monitor pressure, indicate the typology of pressure monitored, enter one of the values in the list	AP = Aquaculture plant RP = River Plume UWWTP = Urban Wastewater Treatment Plant IP = Industrial Plant O = Others
Remarks		

*non-mandatory under IMAP Guidance Factsheets

Table 2: Data Dictionaries (physicochemical information) for EO5 Common Indicator 13 and 14.

Field	Description	List of values
Country Code	Enter member country code as ISO two digits, for example "IT" for Italy.	
National Station ID	Station code	
Year	Year of sampling in AAAA format	
Month	Month of sampling in 1-12 format	
Day	Day of sampling in 1-31 format	
Time	Hour-minutes-seconds of sampling in HH:MM:SS format	

Field	Description	List of values
Sample ID	Sample Code if multiple replies are made with the same value as Year, Month, Day and Time	
Determin_Nutrients	Name of the physico-chemical parameter or of the nutrient, enter one of the values in the list in the "List_PhysicoChemical"	
Nutrients Seawater_unit	Unit of measurement of the physiochemical parameter or nutrient, enter one of the values in the list	% = Oxygen saturation m = Secchi disks depth pH = pH °C = Temperature µg/L = Chlorophyll <i>a</i> µmol/L = Ammonium, Nitrate, Nitrite, Total Nitrogen µmol/L = Dissolved Oxygen µmol/L = Orthophosphate, Total Phosphorus µmol/L = Orthosilicate µS/cm = Conductivity
LOD_LOQ_Flag	Enter the value LOQ in case the concentration value is less than the quantification limit or the value LOD in case the concentration value is less than the detection limit. In the other cases, leave the field empty.	"LOQ = Concentration value below the quantification limit LOD = Concentration value below detection limit
Concentration	Concentration measure	
Sample Depth	Sampling depth in meters	
Analytical Method	Analytical method List of analytical methods, in line with IMAP, will be completed. Suggestion to use code from List_P01 provided in an Excel file	
Remarks		

Table 3: List of physicochemical parameters under IMAP Guidance Factsheets EO5 and provided as mandatory in Data Dictionaries for Common Indicators 13 and 14.

Field	Description	Remarks
Temperature (water)	Water Temperature (°C)	
Salinity	Salinity (psu)	
Conductivity	Conductivity (µS/cm)	
Dissolved oxygen	Dissolved Oxygen (µmol/L)	
Oxygen saturation	Dissolved Oxygen - saturation percentage (%)	
pH	pH	
Chlorophyll <i>a</i>	Chlorophyll- <i>a</i> (µg/L)	
Secchi disk depth	Secchi disk (m)	
Nitrate	Nitrate (µmol/L)	
Nitrite	Nitrite (µmol/L)	
Ammonium	Ammonium (µmol/L)	
Total phosphorus	Total Phosphorus (µmol/l)	
Orthophosphate	Orthophosphate (µmol/L)	
Total nitrogen	Total Nitrogen (µmol/L)	
Orthosilicate	Reactive silicate (µmol/L)	

ECOLOGICAL OBJECTIVE 9: Common Indicator 17**Table 4:** Data Dictionaries (Stations Information) for Common Indicator 17 within EO9.

Field	Description	List of values
Country Code	Enter member country code as ISO two digits, for example "IT" for Italy.	
National Station ID	Station code	
National Station Name	Station name	
*Region	Administrative subdivision after country which the station belongs to (according to the country subdivision)	
Latitude	Latitude of the station in the WGS84 decimal degrees reference system with at least 5 digits (xx.xxxxx).	
Longitude	Longitude of the station in the WGS84 decimal degrees reference system with at least 5 digits (xx.xxxxx). Use positive values without '+' before numbers (for ex. 13.98078) for coordinates east of the Greenwich Meridian (0°) and negative values with '-' for coordinates west of the Greenwich Meridian (0°) (for ex. -2.6893).	
*Closest Coast	Station distance from the coast in km	
TCM Matrix	Environmental matrix measured in the station, enter one value of the list	B = Biota BS = Biota and sediment BSW = Biota, sediment and sea water column BW = Biota and sea water column S = Sediment SW = Sediment and sea water column W = Sea water column
Sea Depth	Sea depth in meters	
Area Typology	Indicate the typology of the monitored area, enter one of the values in the list	R = Reference C = Coastal HS = Hot spot O = Others
PressureType	If the monitoring station is dedicated to monitor pressure, indicate the typology of pressure monitored, enter one of the values in the list	IP = Industrial Plants MT = Maritime Traffic

*non-mandatory under IMAP Guidance Factsheets

Table 5: Data Dictionaries (contaminants information)

Field	Description	List of values
Country Code	Enter member country code as ISO two digits, for example "IT" for Italy.	
National Station ID	Station code	
Year	Year of sampling in YYYY format	
Month	Month of sampling in 1-12 format	
Day	Day of sampling in 1-31 format	

Field	Description	List of values
Time	Hours-minutes-seconds of sampling in HH:MM:SS format	
Sample ID	Sample Code if multiple replies are made with the same value as Year, Month, Day and Time	
Matrix	Sample matrix, enter one value of the list	W = Water S = Sediments B = Biota
Determin Haz Subs Name	Name of the contaminant, enter one value of the column 'Label' of the list 'List contaminants'	
Determin Haz Subs ID	ID of the contaminant, enter one value of the column 'ID_Contaminant' of the list 'List contaminants'	
CAS Number	CAS number of contaminant, enter one value of the column CAS Number of list 'List contaminants'	
Haz Subs_unit	Unit of measurement for the contaminant, enter one value of the list	µg/l = water matrix µg/kg = sediments and biota matrices
Haz Subs_WD	For sediment or biota, specify dry or wet weight, enter one value of the list	WW = Wet weight DW = Dry weight
LOD_LOQ_Flag	Enter the value '<' in case the concentration value is less than the quantification limit or the value '[' in case the concentration value is less than the detection limit. In the other cases, leave the field empty.	<= Concentration value below the quantification limit [= Concentration value below detection limit
Concentration	Concentration value. In the case of analytes sums in which at least one is not less than the LOQ, use the Concentration field with the sum of solely quantifiable analytes (i.e. not lower than the LOQ). In case the concentration value of the single analyte or all the analytes constituent the sum is less than the LOQ, the LOD_LOQ_Flag field and the Concentration field should be used as follows: in the case of a single analyte enter the value of LOQ/2; in the case of analytical additions, enter the zero value taking into account that the individual substances below the quantification limit do not contribute to the value of the sum.	
Sample Depth	Sampling depth in meters	
Salinity	For water matrix: Salinity (psu)	
Temperature	For water matrix: Temperature (°C)	
Dissolved oxygen	For water matrix: dissolved oxygen (µmol O ₂ /l)	

Field	Description	List of values
*Grain Type	For sediment matrix: typology of sediment, enter one value of the list	CS = Coarse Sand FS = Fine Sand G = Gravel M = Mud MS = Middle Sand
Fraction	Per sediment matrix: maximum size of sediment particles in μm	
Sediment Depth	For the sediment matrix: Depth of the collected sample of sediment, measured as a range, in centimeters, starting at the seafloor surface. The range would start by zero if the top of the sediment sample is the seafloor surface. For ex. insert '0-10' if 10 cm of sediments have been sampled starting from seafloor surface or insert '5-15' if 10 cm of sediments have been sampled starting from 5 cm from the seafloor surface.	
*TC	For sediment matrix: Total carbon content in % unit	
*TOC	For sediment matrix: Total organic carbon in % unit	
*TIC	For sediment matrix: Total inorganic carbon in % unit	
*TN	For sediment matrix: Total nitrogen content in % unit	
Species ID	For the biota matrix: monitored species. Enter one value of the column 'ID_Species' of the list 'List_species'	
Species Name	For the biota matrix: monitored species. Enter one value of the column 'Label' of the list 'List_species'	
Specimen_length	For the biota matrix: length of specimen in cm. In case of pooling, indicate mean length	
Specimen_length_sd	For the biota matrix: Standard deviation of average length of specimens in a pool in cm.	
Specimen_weight	For the biota matrix: weight of specimen in g. In case of pooling, indicate mean weight.	
Specimen_weight_sd	For the biota matrix: Standard deviation of average weight of specimens in a pool in g.	
Pooling	In case of pooling, describe the content of pooling as number of specimens and other methodological issues	
Extractable Organic Matter	Extractable Organic Matter in mg/g	

Field	Description	List of values
Tissue	For biota matrix: tissue element of the monitored species, enter one of the list values	<p>BL = Fluids - Blood. Includes haemolymph, erythrocytes, haemocytes, serum (blood component without cells and clotting factors) and plasma (serum including clotting factors)</p> <p>EG = Eggs. Includes bird eggs and fish eggs (roe). Use the remarks field to provide additional information, if necessary.</p> <p>FA = Tissues - Fat. Any type of adipose tissue or organ. Includes the form code BB for "Blubber".</p> <p>GO = Organs - Gonads. Includes female gonads (ovaries) and male gonads (testes). Use the remarks field to provide additional information, if necessary.</p> <p>KI = Organs - Kidney. Use the remarks field to provide additional information, if necessary.</p> <p>LI = Organs - Liver. Includes hepatopancreas. Use the remarks field to provide additional information, if necessary.</p> <p>MU = Tissues - Muscle. Any type of muscle tissue or organ. Includes the former code TM for "Tail muscle".</p> <p>OT = Other. Use the remarks field to provide additional information, if necessary.</p> <p>ST = Tissues - Soft tissue. Includes any body tissue except mineralized tissue (hard tissue)</p>
Fat Content	Fat content as percentage of total wet matter	
Analytical Method	Analytical method	
LOQ	Limit of quantification	
EmodnetCodeP01	Code of the parameter/ EMODNet method according to the dictionary P01, enter one value of the list "List dictionary P01"	
Remarks	Notes	

*non-mandatory under IMAP Guidance Factsheets

Table 6: Example of the List of physicochemical parameters under IMAP Guidance Factsheets EO9, that are also available in the EEA reference list of contaminants (Code list), showing compounds provided as mandatory in the Data Dictionaries for Common Indicator 17 (PAHs not shown). The full list is provided with related Excel files presented at the IMAP Best Practices Meeting.

ID_Contaminant	Label	CAS Number	Matrix	Mandatory	Additional
CAS_309-00-2	Aldrin	309-00-2	Sediments	Y	
CAS_7429-90-5	Aluminium and its compounds	7429-90-5	Sediments	Y	
CAS_7440-43-9	Cadmium and its compounds	7440-43-9	Biota, Sediments	Y	
CAS_60-57-1	Dieldrin	60-57-1	Sediments	Y	
CAS_58-89-9	Gamma-HCH (Lindane)	58-89-9	Biota, Sediments	Y	
CAS_118-74-1	Hexachlorobenzene	118-74-1	Biota, Sediments	Y	
CAS_7439-92-1	Lead and its compounds	7439-92-1	Biota, Sediments	Y	
CAS_7439-97-6	Mercury and its compounds	7439-97-6	Biota, Sediments	Y	
CAS_3768-0-73-2	PCB 101 (2,2',4,5,5'-pentachlorobiphenyl)	37680-73-2	Biota, Sediments	Y	
CAS_3259-8-14-4	PCB 105 (2,3,3',4,4'-pentachlorobiphenyl)	32598-14-4	Biota, Sediments	Y	
CAS_3150-8-00-6	PCB 118 (2,3',4,4',5-pentachlorobiphenyl)	31508-00-6	Biota, Sediments	Y	
CAS_3506-5-28-2	PCB 138 (2,2',3,4,4',5'-hexachlorobiphenyl)	35065-28-2	Biota, Sediments	Y	
CAS_3506-5-27-1	PCB 153 (2,2',4,4',5,5'-hexachlorobiphenyl)	35065-27-1	Biota, Sediments	Y	
CAS_3838-0-08-4	PCB 156 (2,3,3',4,4',5-hexachlorobiphenyl)	38380-08-4	Biota, Sediments	Y	
CAS_3506-5-29-3	PCB 180 (2,2',3,4,4',5,5'-heptachlorobiphenyl)	35065-29-3	Biota, Sediments	Y	
CAS_7012-37-5	PCB 28 (2,4,4'-trichlorobiphenyl)	7012-37-5	Biota, Sediments	Y	
CAS_3569-3-99-3	PCB 52 (2,2',5,5'-tetrachlorobiphenyl)	35693-99-3	Biota, Sediments	Y	
EEA_33-38-5	Polychlorinated biphenyls(7 PCB: 28,52,101,118,138,153,180)		Biota, Sediments	Y	
EEA_32-03-1	Total DDT (DDT, p,p' + DDT, o,p' + DDE, p,p' + DDD, p,p')		Biota, Sediments	Y	
CAS_7440-66-6	Zinc and its compounds	7440-66-6	Biota, Sediments		Y

Table 7: Example of the List of available reference species (Code list) for Data Dictionaries and Data Standards of the IMAP (Pilot) Info System for EO9 (CI17 and CI20).

Species code	Species
2279156	<i>Holothuria tubulosa</i>
2357093	<i>Hoplostethus atlanticus</i>
2481126	<i>Larus</i>
2481156	<i>Larus glaucoides</i>
2481127	<i>Larus hyperboreus</i>
2409391	<i>Lepidorhombus whiffiagonis</i>
2419875	<i>Leucoraja naevus</i>
5213960	<i>Limanda limanda</i>
2301117	<i>Littorina littorea</i>
2415070	<i>Lophius budegassa</i>
2415075	<i>Lophius piscatorius</i>
2291262	<i>Lymnaea palustris</i>
2286995	<i>Macoma balthica</i>
5214420	<i>Mallotus villosus</i>
2415822	<i>Melanogrammus aeglefinus</i>
2415788	<i>Merlangius merlangus</i>
2415643	<i>Merluccius merluccius</i>
2415777	<i>Micromesistius poutassou</i>
5214022	<i>Microstomus kitt</i>
5214883	<i>Molva dypterygia</i>
5214880	<i>Molva molva</i>
5220008	<i>Monodon monoceros</i>
4284897	<i>Mullus barbatus</i>
7791733	<i>Mya arenaria</i>
7865139	<i>Mya truncata</i>
2333785	<i>Myoxocephalus scorpius</i>
8288896	<i>Mytilus edulis</i>
2285683	<i>Mytilus galloprovincialis</i>
2303019	<i>Nassarius reticulatus</i>
2226962	<i>Nephrops norvegicus</i>
5193449	<i>Nucella lapillus</i>
2286060	<i>Ostrea edulis</i>

Annex II**Elements proposed for preparation of Data Standards and Data Dictionaries for
IMAP Common Indicator 18 as amended by the Meeting of CorMon on Pollution Monitoring****Common Indicator 18****Table 1:** Data Dictionaries (Stations Information) for Common Indicator 18 within EO9.

Field	Description	List of values
Country Code	Enter member country code as ISO two digits, for example "IT" for Italy.	
National Station ID	Station code	
National Station Name	Station name	
*Region	Administrative subdivision after country which the station belongs to (according to the country subdivision)	
Latitude	Latitude of the station in the WGS84 decimal degrees reference system with at least 5 digits (xx.xxxxx).	
Longitude	Longitude of the station in the WGS84 decimal degrees reference system with at least 5 digits (xx.xxxxx). Use positive values without '+' before numbers (for ex. 13.98078) for coordinates east of the of the Greenwich Meridian (0°) and negative values with '-' for coordinates west of the Greenwich Meridian (0°) (for ex. -2.6893).	
*Closest Coast	Station distance from the coast in km	
Sea Depth	Sea depth in meters	
Area Typology	Indicate the typology of the monitored area, enter one of the values in the list	R = Reference C = Coastal HS = Hot spot O = Others
Pressure Type	If the monitoring station id dedicated to monitor pressure, indicate the typology of pressure monitored, enter one of the values in the list	AG = Agriculture and livestock IP = Industrial Plants MN = Mining MT = Maritime Traffic

*non-mandatory under IMAP Guidance Factsheets

Table 2. Biomarkers for which reporting of parameters is mandatory in line with related IMAP Guidance Factsheet

Biomarker	Organism	Tissue	Mandatory	Additional (Not-mandatory)
Lysosomal membrane stability on cryostat sections - enzymatic determination	Fish/Mussel	Liver/Digestive gland	Y	
Lysosomal membrane stability in mussel haemocytes - in vivo determination (neutral red retention time (NRRT) assay)	Mussel	Haemocytes (<i>in vivo</i>)	Y	
Micronuclei frequency in fish blood cells	Fish	Erythrocytes	Y	
Micronuclei (MNi) frequency in mussel gill cells and haemocytes	Mussel	Gill cells, Haemocytes	Y	
Acetylcholinesterase activity - enzymatic determination	Mussel / Fish	Gills / Muscle	Y	
% LMS	Mussel	Haem Common methodologies and techniques for the assessment and monitoring of adverse impacts of dumping activities ocytes		Y
Metallothioneins	Fish	Digestive gland		Y
Stress on stress	Mussel			Y
Other: Specify	Specify	Specify	-	Y

Table 3. Data Dictionaries for providing mandatory information/parameters for biomarkers defined for Common Indicator 18, as listed in Table 2

Field	Description	List of values
Country Code	Enter member country code as ISO two digits, for example "IT" for Italy.	
National Station ID	Station code	
Year	Year of sampling in YYYY format	
Month	Month of sampling in 1-12 format	
Day	Day of sampling in 1-31 format	
Time	Hours-minutes-seconds of sampling in HH:MM:SS format	
Sample ID	Sample Code if multiple replies are made with the same value as Year, Month, Day and Time	
Sample Type	Wild / Caged (add information about the collection site)	
Sample Depth	Sampling depth in meters	
Salinity	Water Salinity (psu)	
Temperature	Water Temperature (°C)	
Dissolved oxygen	Water dissolved oxygen (µmol O ₂ /L)	

Field	Description	List of values
Species ID	Monitored species. Enter one value of the column 'ID_Species' of the list 'List_species', if present.	
Species Name	Monitored species. Enter one value of the column 'Label' of the list 'List_species'; if the species is not present in the List, enter the name of the species.	
Gender	Specify gender	F= female M=male I= Undefined Stage Maturation degree of the gonads
Maturity Key	Maturation degree of the gonads for demersal species as referred according Workshop on Sexual Maturity Sampling (ICES WKMAT 2007).	I= Inactive II = Maturing III= Spawning IV= Post-spawning
Specimen_lenght	Length of specimen in cm. In case of pooling, indicate mean length	
Specimen_length_SD/SE	Standard deviation/standard error of ⁵³⁰ average length ofspecimens in a pool in cm.	
Specimen_weight	Weight of specimen in g. In case of pooling, indicate mean weight.	
Specimen_weight_SD/SE	Standard deviation/standard error of average weightof specimens in a pool in g.	
Pooling	In case of pooling, describe the content of pooling and other methodological issues	
Pooling_N	Number of specimens pooled	
Pooling_SD/SE	Which statistical measure is provided	SD = Standard Deviation SE = Standard Error

⁵³⁰ The terms “standard error” and “standard deviation” are often confused. The contrast between these two terms reflects the important distinction between data description and inference, one that all researchers should appreciate. The standard deviation (often SD) is a measure of variability. The standard error of the sample depends on both the standard deviation and the sample size; this interrelation is provided by the simple equation $SE = SD/\sqrt{\text{sample size}}$. The standard error falls as the sample size increases, as the extent of chance variation is reduced;- this underlies the sample size calculation for a controlled trial, for example. By contrast the standard deviation will not tend to change if the size of sample is increased.

Field	Description	List of values
Tissue	Tissue used for biomarker analysis of the monitored species, enter one of the list values	<p>BL = Fluids - Blood. Includes haemolymph, erythrocytes, haemocytes</p> <p>GO = Organs - Gonads. Includes female gonads (ovaries) and male gonads (testes). Use the remarks field to provide additional information, if necessary.</p> <p>LI = Organs - Liver. Includes digestive gland. Use the remarks field to provide additional information, if necessary.</p> <p>GI = Organs - Gills.</p> <p>MU = Tissues – Muscle. Any type of muscle tissue or organ. Includes the former code TM for “Tail muscle”.</p> <p>OT = Other. Use the remarks field to provide additional information, if necessary.</p> <p>ST = Tissues – Soft tissue. Includes any body tissue except mineralized tissue (hard tissue)</p>
Tissue_weight	Weight of tissue in g. In case of pooling, indicate mean weight.	
Tissue_weight_SD/SE	Standard deviation/standard error of average weight of specimens in a pool in g.	
Remarks	Notes	

Table 4: The List of available reference species (Code list) for Data Dictionaries and Data Standards of the IMAP (Pilot) Info System for EO9 (CI17, CI18 and CI20)

Species code	Species
2279156	Holothuria tubulosa
2357093	Hoplostethus atlanticus
2481126	Larus
2481156	Larus glaucooides
2481127	Larus hyperboreus
2409391	Lepidorhombus whiffiagonis
2419875	Leucoraja naevus
5213960	Limanda limanda
2301117	Littorina littorea
2415070	Lophius budegassa
2415075	Lophius piscatorius
2291262	Lymnaea palustris
2286995	Macoma balthica
5214420	Mallotus villosus
2415822	Melanogrammus aeglefinus
2415788	Merlangius merlangus
2415643	Merluccius merluccius
2415777	Micromesistius poutassou
5214022	Microstomus kitt
5214883	Molva dypterygia

Species code	Species
5214880	<i>Molva molva</i>
5220008	<i>Monodon monoceros</i>
4284897	<i>Mullus barbatus</i>
7791733	<i>Mya arenaria</i>
7865139	<i>Mya truncate</i>
2333785	<i>Myoxocephalus Scorpius</i>
8288896	<i>Mytilus edulis</i>
2285683	<i>Mytilus galloprovincialis</i>
2303019	<i>Nassarius reticulatus</i>
2226962	<i>Nephrops norvegicus</i>
5193449	<i>Nucella lapillus</i>
2286060	<i>Ostrea edulis</i>

Annex III**Elements proposed for preparation of Data Standards and Data Dictionaries for IMAP****Common Indicator 20**

The elements of Data Standards (DS) and Data Dictionaries (DDs) specific for CI 20 are provided in the tabular format as presented here-below for receiving the suggestions of present Meeting and guiding further work of INFO/RAC and MEDPOL. They are based on the concentration limits for the contaminants regulated in the EU, as defined in EU Commission Regulations (EC) No 1881/2006⁵³¹, (EC) No 835/2011⁵³² and EC No 1259/2011⁵³³.

Maximum Levels of Heavy Metals – (EC) Regulation 1881/2006

	Foodstuffs	Maximum levels µg kg ⁻¹ wet weight		
		Cadmium	Lead	Mercury
1	Muscle meat of fish ⁽¹⁾	0.050 Excluding species listed in 2 and 3	0.30	0.50 Excluding species listed in 4
2	Muscle meat of the following fish ⁽¹⁾ anchovy (<i>Engraulis species</i>) bonito (<i>Sarda sarda</i>) common two-banded seabream (<i>Diplodus vulgaris</i>) eel (<i>Anguilla anguilla</i>) grey mullet (<i>Mugil labrosus labrosus</i>) horse mackerel or scad (<i>Trachurus species</i>) louvar or luvar (<i>Luvarus imperialis</i>) sardine (<i>Sardina pilchardus</i>) sardinops (<i>Sardinops species</i>) tuna (<i>Thunnus species</i> , <i>Euthynnus species</i> , <i>Katsuwonus pelamis</i>) wedge sole (<i>Dicologlossa cuneata</i>)	0.10		
3	Muscle meat of swordfish (<i>Xiphias gladius</i>) ⁽¹⁾	0.30		
4	Muscle meat of the following fish: anglerfish (<i>Lophius species</i>) atlantic catfish (<i>Anarhichas</i>)			1.0

⁵³¹ Commission Regulation (EC) No 1881/2006, setting maximum levels for certain contaminants in seafood

⁵³² Commission Regulation (EC) No 835/2011 amending Regulation (EC) No 1881/2006 as regards maximum levels for polycyclic aromatic hydrocarbons in foodstuffs;

⁵³³ Commission Regulation (EC) No 1259/2011, amending Regulation (EC) No 1881/2006 as regards maximum levels for dioxins, dioxin-like PCBs and non-dioxin-like PCBs in foodstuffs

	<p><i>lupus</i>) bonito (<i>Sarda sarda</i>) eel (<i>Anguilla species</i>) emperor, orange roughy, rosy soldierfish (<i>Hoplostethus species</i>) grenadier (<i>Coryphaenoides rupestris</i>) halibut (<i>Hippoglossus hippoglossus</i>) marlin (<i>Makaira species</i>) megrim (<i>Lepidorhombus species</i>) mullet (<i>Mullus species</i>) pike (<i>Esox lucius</i>) plain bonito (<i>Orcynopsis unicolor</i>) poor cod (<i>Tricopterus minutes</i>) portuguese dogfish (<i>Centroscymnus coelolepis</i>) rays (<i>Raja species</i>) redfish (<i>Sebastes marinus, S. mentella, S. viviparus</i>) sail fish (<i>Istiophorus platypterus</i>) scabbard fish (<i>Lepidopus caudatus, Aphanopus carbo</i>) seabream, pandora (<i>Pagellus species</i>) shark (all species) snake mackerel or butterfish (<i>Lepidocybium flavobrunneum, Ruvettus pretiosus, Gempylus serpens</i>) sturgeon (<i>Acipenser species</i>) swordfish (<i>Xiphias gladius</i>) tuna (<i>Thunnus species, Euthynnus species, Katsuwonus pelamis</i>)</p>			
5	Crustaceans, excluding brown meat of crab and excluding head and thorax meat of lobster and similar large crustaceans	0.50	0.50	0.50
6	Bivalve molluscs	1.0	1.5	
7	Cephalopods (without viscera)	1.0	1.0	

(1) Exclusion of liver. Where fish are intended to be eaten whole, the maximum level shall apply to the whole fish

Maximum Levels of Benzo(a)pyrene and sum of four PAHs (benzo(a)pyrene, benz(a)anthracene, benzo(b)fluoranthene and chrysene) Regulation No 835/2011 amending Regulation (EC) 1881/2006

Foodstuffs	Maximum levels ($\mu\text{g kg}^{-1}$)	
	Benzo(a)pyrene	Sum of benzo(a)pyrene, benz(a)anthracene, benzo(b)fluoranthene and chrysene *
Bivalve molluscs (fresh, chilled or frozen)	5.0	30.0

* Lower bound concentrations are calculated on the assumption that all the values of the four substances below the limit of quantification are zero

Maximum Levels of Dioxins and PCBs - Regulation (EC) 1259/2011 amending Regulation (EC) 1881/2006

Foodstuffs	Maximum levels		
	Sum of dioxins (WHO-PCDD/F-TEQ) ⁽¹⁾	Sum of dioxins and dioxin-like PCBs (WHO-PCDD/F-PCB-TEQ) ⁽¹⁾	Sum of PCB28, PCB52, PCB101, PCB138, PCB153 and PCB180 (ICES 6)
Muscle meat of fish and fishery products and products thereof ⁽²⁾ with the exemption of: <ul style="list-style-type: none"> • wild caught eel • wild caught fresh water fish, with the exception of diadromous fish species caught in fresh water • fish liver and derived products • marine oils The maximum level for crustaceans applies to muscle meat from appendages and abdomen. In case of crabs and crab-like crustaceans (<i>Brachyura</i> and <i>Anomura</i>) it applies to muscle meat from appendages.	3.5 pg g^{-1} wet weight	6.5 pg g^{-1} wet weight	75 ng g^{-1} wet weight

(1) Dioxins (sum of polychlorinated dibenzo-para-dioxins (PCDDs) and polychlorinated dibenzofurans (PCDFs), expressed as World Health Organisation (WHO) toxic equivalent using the WHO-toxic equivalency factors (WHO-TEFs)) and sum of dioxins and dioxin-like PCBs (sum of PCDDs, PCDFs and polychlorinated biphenyls (PCBs), expressed as WHO toxic equivalent using the WHO-TEFs). WHO-TEFs for human risk assessment based on the conclusions of the World Health Organization (WHO) (For TEF values see note 31, (EC) Regulation 1259/2011 – Annex 1.1.9.).

(2) Where fish are intended to be eaten whole, the maximum level shall apply to the whole fish.

Annex IV

Proposal of Data Standards and Data Dictionaries for IMAP Common Indicators 18 and 20 as prepared after the Meeting of CorMon on Pollution Monitoring for consideration of the 8th Meeting of Coordination Group Meeting

Data Standards and Data Dictionaries for IMAP Contaminants (EO9): Common Indicators 18

1. The present proposal builds on the initial proposal of DSs and DDs for IMAP CI 18, as provided in the document UNEP/MED WG. 492/8 that was discussed at the Meeting of CorMon on Pollution Monitoring (26-28) and further revised in line with the comments of CPs received during the Meeting (as provided in Annex II). It also includes the changes introduced to address the comments provided from the participants of the Meeting of CorMon Pollution Monitoring, as well additional fields added to allow the correct functioning of the data flow and analogy with DDs and DSs for other CIs.
2. The list of reference species provided in Table 3 represents the list of species approved for the IMAP CI 17 by the 7th Meeting of the Ecosystem Approach Coordination Group and consequently made operational for data reporting for DSs and DDs for EO9 within IMAP Info System.
3. This proposal of DSs and DDs for IMAP CI 18 provides broader data sets and associated dictionaries than requested as mandatory by related IMAP Guidance Factsheets and Metadata Templates. In the Data Standards the **mandatory** data are represented in **black** and the **non-mandatory** ones in **red colour**. The possibility to fill in also non-mandatory fields is given to allow the Contracting Parties that already have monitoring systems collecting a wider set of data to also report them as the additional data. Although it is at the discretion of the Contracting Parties to decide, reporting on non-mandatory data sets is **strongly encouraged** to avoid knowledge gaps between IMAP and other national data flows.

Table 1: DSs & DDs Module PMO1 (Level of pollution effects) for IMAP CI 18: Stations

Field	Description	List of value
CountryCode	Enter member country code as ISO two digits, for example "IT" for Italy.	
NationalStationID	Station code	
NationalStationName	Station name	
*Region	Administrative subdivision of the first level where the station belongs to (according to the country subdivision)	
Latitude	Latitude of the station in the WGS84 decimal degrees reference system with at least 5 digits (xx.xxxxx).	
Longitude	Longitude of the station in the WGS84 decimal degrees reference system with at least 5 digits (xx.xxxxx). Use positive values without '+' before numbers (for ex. 13.98078) for coordinates east of the of the Greenwich Meridian (0°) and negative values with '-' for	

Field	Description	List of value
	coordinates west of the Greenwich Meridian (0°) (for ex. -2.6893).	
*ClosestCoast	Station distance from the coast in km	
TCMMatrix	Environmental matrix measured in the station, enter one of the values in the list.	B = Biota
SeaDepth	Sea depth in meters	
AreaTypology	Indicate the typology of the monitored area, enter one of the values in the list	R = Reference sites C = Coastal HS = Hot spot O = Others
Pressure Type	If the monitoring station is dedicated to monitoring of pressure, indicate the typology of pressure monitored, enter one of the values in the list	AG = Agriculture and livestock IP = Industrial Plants MN = Mining MT = Maritime Traffic
Remarks	Notes	

* non-mandatory under IMAP Guidance Factsheets

Table 2: DSs & DDs Module PMO1 (Level of pollution effects) for IMAP CI 18 –Biomarkers

Field	Description	List of value
CountryCode	Member country code as ISO two digits, for example "IT" for Italy.	
NationalStationID	Station code.	
Year	Year of sampling in YYYY format	
Month	Month of sampling in 1-12 format	
Day	Day of sampling in 1-31 format	
Time	Hours-minutes-seconds of sampling in HH:MM:SS format	
SampleID	Sample Code if multiple replies are made with the same value as Year, Month, Day and Time"	
SampleType	Wild/Caged (add information about the collection site)	

Field	Description	List of value
Matrix	Sample matrix, enter one value of the list	B = Biota
SampleDepth	Sampling depth in meters	
* Salinity	Salinity (psu)	
* Temperature	Temperature (°C)	
* DissolveOxygen	Dissolved oxygen ($\mu\text{mol O}_2/\text{l}$)	
SpeciesID	Monitored species. Enter one value of the column 'ID_Species' of the list 'List_species'	
SpeciesName	Monitored species. Enter one value of the column 'Label' of the list 'List_species'	
SpeciesNameOther	Name of the species, if not included in the list 'List_species'	
*SpeciesGender	Gender of the species. Enter one value of the List of values.	M = male F = female U = undefined
MaturationKey	Maturation degree of the gonads for demersal species according to the Workshop on Sexual Maturity Sampling (ICES WKMAT 2007). Enter one value of the List of values.	I= Inactive II = Maturing III= Spawning IV= Post-spawning
Specimen_lenght	Length of specimen in cm. In case of pooling, indicate mean length. (precision at 0,1 cm). In the case of fish, this value refers to the total length; for mussels it refers to the length of the valve; for crustaceans it refers to the length of the carapace.	
Specimen_length_SD_SE	Standard deviation/standard error of average length of specimens in a pool in cm. The standard deviation (SD) is a measure of variability. The standard error of the sample depends on both the standard deviation and the sample size.	

Field	Description	List of value
Specimen_weight	Weight of specimen in g. In case of pooling, indicate mean weight. (precision at 0,1 g)	
Specimen_weight_SD_SE	Standard deviation/standard error of average weight of specimens in a pool in g.	
Pooling	In case of pooling, describe the content of pooling and other methodological issues	
Pooling_N	Specify the number of specimens pooled	
Pooling_SD_SE	Specify which statistical measure is provided. Enter one value of the List of values.	SD = Standard Deviation SE = Standard Error
*Liver_weight	Weight of liver in grammes (precision at 0,01 g) to define hepatosomatic index (HSI)	
*Gonad_weight	Weight of Gonad in grammes (precision at 0,01 g) to define gonadosomatic index (GSI)	
Tissue	Tissue element of the monitored species, enter one of the values in the list.	BL = Fluids - Blood. Includes erythrocytes, haemocytetes, serum (blood component without cells and clotting factors) and plasma (serum including clotting factors) EG = Eggs. Includes bird eggs and fish eggs (roe). Use the remarks field to provide additional information, if necessary. GO = Organs - Gonads. Includes female gonads (ovaries) and male gonads (testes). Use the remarks field to provide additional information, if necessary. LI = Organs - Liver. Includes hepatopancreas. Use the remarks field to provide additional information, if necessary. MU = Tissues - Muscle. Any type of muscle tissue or organ. Includes the former code TM for "Tail muscle". ST = Tissues - Soft tissue. Includes any body tissue except mineralised tissue (hard tissue) GI = Organs - Gills

Field	Description	List of value
		OT = Other. Use the remarks field to provide additional information, if necessary.
Tissue_weight	Weight of tissue in g. In case of pooling, indicate mean weight.	
Tissue_weight_SD_SE	Standard deviation/standard error of average weight of specimens in a pool in g.	
AnalyticalMethod	Analytical method used. Reference methodological protocol used for analysis – indicate method elaborated in Monitoring Guideline/Protocols for Biomarker Analysis (UNEP/MED WG. 492/4-5); Add any other methods different from these by specifying name of scientific paper	
Biomarker_Name	Name of biomarker. Enter one value of the column 'Biomarkers' of the list 'List_Biomarkers'	
Biomarker_Name_NM	Specify the name of biomarker if the 'Biomarker_Name' field has been filled in with 'NM'	
Biomarker_Value	Value of each biomarker. Precision to the second decimal place (ex.:0,01), except for MN where the precision is to the first decimal place (e.g.: 1) and for LMS-HEXO and for LMS-NRRT where the precision is to the integer number (ex.:1).	
Biomarker_Unit	Unit of measure (different for each biomarker). Enter one of the values in the List of Values. For the 'LMS biomarker' the unit of measure is 'min' both in the case of LMS-HEXO and LMS-NRRT but, in the first case it refers to	min = Lysosomal Membrane Stability (LMS) (labilization /retention minutes) nmol/min/mg protein = Acetylcholinesterase (AChE) activity (nmol/min/mg protein in gills (bivalves))

Field	Description	List of value
	'labilization time' in the second case it refers to 'retention time'. If the CP wishes to report data on Additional – not Mandatory Biomarkers, other than mandatory biomarkers insert 'NM' and specify unit of measure in the 'Biomarker_Unit_NM' field.	% = Mean percentage lysosomal membrane stability in mussel (%LMS) number of cases /1000 cells = Micronucleus test (MN)(frequency) $\mu\text{g/g}$ = Metallothioneins level (MT) ($\mu\text{g/g}$ digestive gland) LT50 (days) = Stress on Stress (SoS) NM = unit for additional not mandatory biomarker
Biomarker_Unit_NM	Unit of measure for 'Biomarker_Name_NM'. Fill in this field if the 'Biomarker_Unit' field has been filled in with 'NM'	
Remarks	Notes	

* non-mandatory under IMAP Guidance Factsheets

Table 3: DSs&DDs Module PMO1 (Level of pollution effects) for IMAP CI 18 – List of species ⁵³⁴

ID_Species	Label
8006460	<i>Anarhichas lupus</i>
2392194	<i>Anarhichas minor</i>
5212973	<i>Anguilla anguilla</i>
2389391	<i>Aphanopus carbo</i>
2440728	<i>Balaenoptera acutorostrata</i>
2420330	<i>Bathyraja brachyurops</i>
2401415	<i>Bathysaurus ferox</i>
5210955	<i>Boops boops</i>
2415752	<i>Boreogadus saida</i>
2415505	<i>Brosme brosme</i>

⁵³⁴ List of available reference species (Code list) for EO9.

ID_Species	Label
2481312	<i>Cepphus grylle</i>
2286583	<i>Cerastoderma edule</i>
2336668	<i>Chelidonichthys kumu</i>
2417343	<i>Chimaera monstrosa</i>
8351946	<i>Clupea harengus</i>
2403490	<i>Conger conger</i>
5215150	<i>Coryphaenoides rupestris</i>
2222188	<i>Crangon crangon</i>
8534921	<i>Crassostrea angulata</i>
2286069	<i>Crassostrea gigas</i>
5220003	<i>Delphinapterus leucas</i>
8324617	<i>Delphinus delphis</i>
5729032	<i>Donax trunculus</i>
2287072	<i>Dreissena polymorpha</i>
2287250	<i>Ensis siliqua</i>
2336597	<i>Eutrigla gurnardus</i>
7832266	<i>Fucus</i>
3196291	<i>Fucus ceranoides</i>
3196437	<i>Fucus serratus</i>
8222574	<i>Fucus vesiculosus</i>
2481433	<i>Fulmarus glacialis</i>
8084280	<i>Gadus morhua</i>
2415827	<i>Gadus ogac</i>
2440596	<i>Globicephala melas</i>
5213996	<i>Glyptocephalus cynoglossus</i>
2376483	<i>Gobius</i>
7788295	<i>Haematopus ostralegus</i>
2434806	<i>Halichoerus grypus</i>
2293076	<i>Haliotis tuberculata</i>
2409108	<i>Hippoglossoides platessoides</i>
2279156	<i>Holothuria tubulosa</i>
2357093	<i>Hoplostethus atlanticus</i>

ID_Species	Label
2481126	<i>Larus</i>
2481156	<i>Larus glaucoides</i>
2481127	<i>Larus hyperboreus</i>
2409391	<i>Lepidorhombus whiffiagonis</i>
2419875	<i>Leucoraja naevus</i>
5213960	<i>Limanda limanda</i>
2301117	<i>Littorina littorea</i>
2415070	<i>Lophius budegassa</i>
2415075	<i>Lophius piscatorius</i>
2291262	<i>Lymnaea palustris</i>
2286995	<i>Macoma balthica</i>
5214420	<i>Mallotus villosus</i>
2415822	<i>Melanogrammus aeglefinus</i>
2415788	<i>Merlangius merlangus</i>
2415643	<i>Merluccius merluccius</i>
2415777	<i>Micromesistius poutassou</i>
5214022	<i>Microstomus kitt</i>
5214883	<i>Molva dypterygia</i>
5214880	<i>Molva molva</i>
5220008	<i>Monodon monoceros</i>
4284897	<i>Mullus barbatus</i>
7791733	<i>Mya arenaria</i>
7865139	<i>Mya truncata</i>
2333785	<i>Myoxocephalus scorpius</i>
841	<i>Mysida</i>
2285679	<i>Mytilus</i>
8288896	<i>Mytilus edulis</i>
2285683	<i>Mytilus galloprovincialis</i>
2303019	<i>Nassarius reticulatus</i>
2226962	<i>Nephrops norvegicus</i>
5193449	<i>Nucella lapillus</i>
2286060	<i>Ostrea edulis</i>

ID_Species	Label
2224987	<i>Palaemon serratus</i>
2222355	<i>Pandalus borealis</i>
2285980	<i>Pecten maximus</i>
2409966	<i>Pegusa lascaris</i>
8140485	<i>Perca fluviatilis</i>
2434773	<i>Phoca hispida</i>
2434793	<i>Phoca vitulina</i>
2440669	<i>Phocoena phocoena</i>
2409330	<i>Platichthys flesus</i>
7700106	<i>Pleuronectes platessa</i>
2415872	<i>Pollachius pollachius</i>
2415861	<i>Pollachius virens</i>
2409416	<i>Psetta maxima</i>
5216024	<i>Raja clavata</i>
5216014	<i>Raja montagui</i>
5216208	<i>Raja radiata</i>
2409383	<i>Reinhardtius hippoglossoides</i>
2481205	<i>Rissa tridactyla</i>
5175681	<i>Saduria entomon</i>
7595433	<i>Salmo salar</i>
8215487	<i>Salmo trutta</i>
4284021	<i>Salvelinus alpinus</i>
2413224	<i>Sardina pilchardus</i>
2374149	<i>Scomber scombrus</i>
2409403	<i>Scophthalmus rhombus</i>
2418684	<i>Scyliorhinus canicula</i>
2335392	<i>Sebastes marinus</i>
2335427	<i>Sebastes mentella</i>
5214139	<i>Solea solea</i>
2498352	<i>Somateria mollissima</i>
2413452	<i>Sprattus sprattus</i>
5216368	<i>Squalus acanthias</i>

ID_Species	Label
5229227	<i>Sterna hirundo</i>
2373946	<i>Thunnus alalunga</i>
2373980	<i>Thunnus thynnus</i>
8635	<i>Triglidae</i>
2481342	<i>Uria aalge</i>
2481339	<i>Uria lomvia</i>
2433451	<i>Ursus maritimus</i>
2287751	<i>Venerupis decussata</i>
2287753	<i>Venerupis philippinarum</i>
7744449	<i>Zeus faber</i>
2381013	<i>Zoarces viviparus</i>

Table 4: DSs&DDs Module PMO1 (Level of pollution effects) for IMAP C.I. 18 – List of Biomarkers

Biomarker	Description (EN)	Organism	Tissue	Mandatory	Additional (Not-mandatory)
LMS-HEXO	Lysosomal membrane stability on cryostat sections - enzymatic determination	Fish/Mussel	Liver/Digestive gland	Y	
LMS-NRRT	Lysosomal membrane stability in mussel haemocytes - in vivo determination (neutral red retention time (NRRT) assay)	Mussel	Haemocytes (in vivo)	Y	
MN_F	Micronuclei frequency in fish blood cells	Fish	Erythrocytes	Y	
MN_MH	Micronuclei (MNi) frequency in mussel gill cells and haemocytes	Mussel	Gill cells, Haemocytes	Y	
AChE	Acetylcholinesterase activity - enzymatic determination	Mussel / Fish	Gills / Muscle	Y	
% LMS	% LMS Mean percentage of Lysosomal membrane stability in	Mussel	Haemocytes		Y

	mussel				
MT	Metallothioneins	Fish	Digestive gland		Y
SoS	Stress on stress	Mussel			Y
NM	Other: not mandatory biomarker	Specify	Specify	-	Y

Data Standards and Data Dictionaries for IMAP Contaminants (EO9): Common Indicators 20

1. The present document provides proposal of the Data Standards and Data Dictionaries (DSs & DDs) for IMAP Common Indicator 20 aimed at collecting data on actual levels of contaminants that have been detected and number of contaminants which have exceeded maximum regulatory levels in commonly consumed seafood in the Mediterranean Sea.
2. The initial proposal of the elements that have been agreed by the Meeting of CorMon on Pollution Monitoring (Annex III) were used for preparing this proposal of the Data Standards (DS) and Data Dictionaries (DDs) specific for CI 20 as provided here-below.
3. The list of reference for chemicals proposed for IMAP CI 20 (Table 3) is also in use by the European Environmental Agency (EEA, WISE-Marine) and includes either the CAS numbers (Chemical Abstract Service reference number) or the EEA reference number (for particular EEA requirements). The mandatory contaminants⁵³⁵ are represented in black (Cd, Hg, Pb, four PAHs (benzo(a)pyrene, benz(a)anthracene, benzo(b)fluoranthene and chrysene), dioxins, dioxin-like and non dioxin-like PCBs and radionuclides) and the non-mandatory ones in red color.
4. The list of commercial species reported in Table 4 refers to JRC list of marine species of commercial interest in the different Mediterranean Regions (Marine strategy framework directive Task group 9 contaminants in fish and other seafood, April 2010)⁵³⁶.
5. If any species is not present among those listed, it is always possible to insert related data by filling in the SpeciesNameOther field.
6. The proposal of DSs and DDs provides broader data sets and associated dictionaries than requested as mandatory by related IMAP Guidance Factsheets and Metadata Templates. In the Data Standards the **mandatory** data are represented in **black** and the **non-mandatory** ones in **red color**. The possibility to fill in also non-mandatory fields is given to allow the Contracting Parties that already have monitoring systems collecting a wider set of data to also report them as the additional data. Although it is at the discretion of the Contracting Parties to decide, reporting on non-mandatory data sets is **strongly encouraged** to avoid knowledge gaps between IMAP and other national data flows.

Table 5: DSs & DDs Module PSF1 (Levels of contaminants in seafood for IMAP CI20: Stations

Field	Description	List of value
-------	-------------	---------------

⁵³⁵ This list has been included in Annex III of the Monitoring Guideline for Reporting Monitoring Data for IMAP Common Indicators 13, 14, 17, 18 and 20 (UNEP/MED WG. 492/08)

⁵³⁶ This list has been included in Annex I of the Monitoring Guidelines/Protocols for Sampling and Sample Preservation of Sea Food for IMAP Common Indicator 20: Heavy and Trace Elements and Organic Contaminants (UNEP/MED WG. 482/17)

CountryCode	Member country code as ISO two digits, for example "IT" for Italy.	
NationalStationID	Specify the station code of the sample collection. In case information on location of collection is not available, then provide code of the fishing area. Specifically, in the case of fishing area, insert one of the Geographical Subarea number present in the 'Value' column of the Excel sheet 'List_GSA'.	
NationalStationName	Specify the station name of the sample collection. In case information on location of collection is not available, then provide name of the fishing area. Specifically, in the case of fishing area, insert one of the Geographical Subarea name present in the 'Description' column of the Excel sheet 'List_GSA'.	
*Region	Administrative subdivision of first level which the station belongs to (according to the country subdivision)	
Latitude	Latitude of the sample collection in the WGS84 decimal degrees reference system with at least 5 digits (xx.xxxxx). In case information on location of collection is not available, then provide the latitude of the centroid of the Fishing Area, referring to the Geographical Subarea (GSA) specified in NationalStationID.	
Longitude	Longitude of the sample collection in the WGS84 decimal degrees reference system with at least 5 digits (xx.xxxxx). Use positive values without '+' before numbers (for ex. 13.98078) for coordinates east of the of the Greenwich Meridian (0°) and negative values with '-' for coordinates west of the Greenwich Meridian (0°) (for ex. -2.6893). In case information on location of collection is not available, then provide the longitude of the centroid of the Fishing Area, referring to the Geographical Subarea (GSA) specified in NationalStationID.	
SampleCollectionType	Specify if the geographical information, entered in "Latitude" and "Longitude" fields, refers to the collection location (CL) or to the fishing area (FA), in case information on location of collection is not available. Enter one value in the list.	CL = Collection Location FA = Fishing Area
*ClosestCoast	Station distance from the coast in km	
TCMMatrix	Environmental matrix measured in the station, enter one of the values in the list.	B = Biota
SeaDepth	Sea depth in meters	

AreaTypology	Indicate the typology of the monitored area, enter one of the values in the list	R = Reference sites C = Coastal HS = Hot spot O = Others
Remarks	Notes	

* non-mandatory under IMAP Guidance Factsheets

Table 6: DSs & DDs Module PSF1 (Levels of contaminants in seafood) for IMAP CI 20: Contaminants

Field	Description	List of value
CountryCode	Member country code as ISO two digits, for example "IT" for Italy.	
NationalStationID	Specify the station code of the sample collection. In case information on location of collection is not available, then provide code of the fishing area. Specifically, in the case of fishing area, insert one of the Geographical Subarea number present in the 'Value' column of the Excel sheet 'List_GSA'.	
Year	Year of sampling in YYYY format	
Month	Month of sampling in 1-12 format	
Day	Day of sampling in 1-31 format	
Time	Hours-minutes-seconds of sampling in HH:MM:SS format	
SampleID	Sample Code if multiple sampling are made with the same value as Year, Month, Day and Time.	
Matrix	Sample matrix, enter one value of the list	B = Biota
SampleDepth	Sampling depth in meters	
Salinity	Salinity (psu)	
Temperature	Temperature (°C)	
DissolveOxygen	Dissolved oxygen (µmol O ₂ /l)	
SpeciesID	Monitored species. Enter one value of the column 'ID_Species' of the list 'List_species'	
SpeciesName	Monitored species. Enter one value of the column 'Label' of the list 'List_species'	
SpeciesNameOther	Name of species, in case not included in the list 'List_species'	
Specimen_lenght	Length of specimen in cm. In case of pooling, indicate mean lenght. (precision at 0,1 cm)	
*Specimen_lenght_sd	Standard deviation of average length of specimens in a pool in cm.	

Specimen_weight	Weight of specimen in g. In case of pooling, indicate mean weight. (precision at 0,1 g)	
*Specimen_weight_sd	Standard deviation of average weight of specimens in a pool in g.	
*Pooling	In case of pooling, describe the content of pooling as number of specimens and other methodological issues, taking into consideration the sampling requirements described in IMAP Monitoring Guidelines UNEP/MED WG.482/17	
DeterminHazSubsName	Name of the contaminant, enter one value of the column 'Label' of the list 'List_contaminants'	
DeterminHazSubsID	ID of the contaminant, enter one value of the column 'ID_Contaminant' of the list 'List_contaminants'	
CASNumber	CAS number of contaminant, enter one value of the column 'CASNumber' of list 'List_contaminants'	
Concentration	Concentration value of detected contaminant (DeterminHazSubsID)	
MRL	Maximum Regulatory Level for contaminant (DeterminHazSubsID)	
HazSubs_unit	Unit of measurement for the contaminant. Enter one value of the list	mg/kg = metals ug/kg = not metals
MRL_Flag	Enter the value '>' in case the concentration value of detected contaminant is above the Maximum Regulatory Level for contaminant (MRL). In the other cases, leave the field empty.	> = Concentration value of detected contaminant above MRL
Remarks	Notes	

* non-mandatory under IMAP Guidance Factsheets

Table 7: DSs & DDs Module PSF1 (Levels of contaminants in seafood) for CI 20: List of contaminants

ID_Contaminant	Label	CAS Number
*CAS_90-12-0	1-methylnaphthalene	90-12-0
*CAS_75-34-3	1,1-dichloroethane	75-34-3
*CAS_75-35-4	1,1-dichloroethene	75-35-4
*CAS_563-58-6	1,1-dichloropropene	563-58-6
*CAS_71-55-6	1,1,1-trichloroethane	71-55-6
*CAS_630-20-6	1,1,1,2-tetrachloroethane	630-20-6
*CAS_1070-78-6	1,1,1,3-tetrachloropropane	1070-78-6
*CAS_79-00-5	1,1,2-trichloroethane	79-00-5

ID_Contaminant	Label	CAS Number
*CAS_79-34-5	1,1,2,2-tetrachloroethane	79-34-5
*CAS_96-12-8	1,2-dibromo-3-chloropropane	96-12-8
*CAS_106-93-4	1,2-dibromoethane	106-93-4
*CAS_95-50-1	1,2-dichlorobenzene	95-50-1
*CAS_107-06-2	1,2-dichloroethane	107-06-2
*CAS_540-59-0	1,2-dichloroethene	540-59-0
*CAS_78-87-5	1,2-dichloropropane	78-87-5
*CAS_87-61-6	1,2,3-trichlorobenzene	87-61-6
*CAS_96-18-4	1,2,3-trichloropropane	96-18-4
*CAS_35822-46-9	1,2,3,4,6,7,8-H7CDD	35822-46-9
*CAS_67562-39-4	1,2,3,4,6,7,8-H7CDF	67562-39-4
*CAS_3268-87-9	1,2,3,4,6,7,8,9-O8CDD	3268-87-9
*CAS_39001-02-0	1,2,3,4,6,7,8,9-O8CDF	39001-02-0
*CAS_39227-28-6	1,2,3,4,7,8-H6CDD	39227-28-6
*CAS_70648-26-9	1,2,3,4,7,8-H6CDF	70648-26-9
*CAS_55673-89-7	1,2,3,4,7,8,9-H7CDF	55673-89-7
*CAS_57653-85-7	1,2,3,6,7,8-H6CDD	57653-85-7
*CAS_57117-44-9	1,2,3,6,7,8-H6CDF	57117-44-9
*CAS_40321-76-4	1,2,3,7,8-P5CDD	40321-76-4
*CAS_57117-41-6	1,2,3,7,8-P5CDF	57117-41-6
*CAS_19408-74-3	1,2,3,7,8,9-H6CDD	19408-74-3
*CAS_72918-21-9	1,2,3,7,8,9-H6CDF	72918-21-9
*CAS_120-82-1	1,2,4-trichlorobenzene	120-82-1
*CAS_95-63-6	1,2,4-trimethylbenzene	95-63-6
*CAS_3194-55-6	1,2,5,6,9,10-hexabromocyclododecane	3194-55-6
*CAS_541-73-1	1,3-dichlorobenzene	541-73-1
*CAS_142-28-9	1,3-dichloropropane	142-28-9
*CAS_542-75-6	1,3-dichloropropene	542-75-6
*CAS_108-70-3	1,3,5-trichlorobenzene	108-70-3
*CAS_108-67-8	1,3,5-trimethylbenzene	108-67-8
*CAS_25637-99-4	1,3,5,7,9,11-hexabromocyclododecane	25637-99-4

ID_Contaminant	Label	CAS Number
*CAS_106-46-7	1,4-dichlorobenzene	106-46-7
*CAS_123-91-1	1,4-dioxane	123-91-1
*CAS_4904-61-4	1,5,9-cyclododecatriene	4904-61-4
*CAS_57-63-6	17alpha-ethinylestradiol (EE2)	57-63-6
*CAS_50-28-2	17beta-estradiol (E2)	50-28-2
*CAS_288-88-0	1H-1,2,4-Triazole	288-88-0
*CAS_25140-90-3	2-(2,6-dichlorophenoxy) propionic acid (2,6-DCPP)	25140-90-3
*CAS_3307-39-9	2-(4-chlorophenoxy) propionic acid (4-CPP)	3307-39-9
*CAS_16672-87-0	2-chloroethylphosphonic acid	16672-87-0
*CAS_95-57-8	2-chlorophenol	95-57-8
*CAS_95-49-8	2-chlorotoluene	95-49-8
*CAS_5466-77-3	2-Ethylhexyl 4-methoxycinnamate	5466-77-3
*CAS_1668-54-8	2-methyl-4-amino-6-methoxy-s-triazine	1668-54-8
*CAS_95-48-7	2-methyl-phenol	95-48-7
*CAS_91-57-6	2-methylnaphthalene	91-57-6
*CAS_135-19-3	2-naphthol	135-19-3
*CAS_594-20-7	2,2-dichloropropane	594-20-7
*CAS_526-75-0	2,3-dimethyl-phenol	526-75-0
*CAS_4901-51-3	2,3,4,5-tetrachlorophenol	4901-51-3
*CAS_58-90-2	2,3,4,6-tetrachlorophenol	58-90-2
*CAS_60851-34-5	2,3,4,6,7,8-H6CDF	60851-34-5
*CAS_57117-31-4	2,3,4,7,8-P5CDF	57117-31-4
*CAS_50-31-7	2,3,6-trichlorobenzoic acid	50-31-7
*CAS_51207-31-9	2,3,7,8-T4CDF	51207-31-9
*CAS_94-82-6	2,4-DB	94-82-6
*CAS_133-53-9	2,4-dichloro-3,5-dimethylphenol	133-53-9
*CAS_120-83-2	2,4-dichlorophenol	120-83-2
*CAS_94-75-7	2,4-dichlorophenoxyacetic acid, 2-4 D	94-75-7
*CAS_105-67-9	2,4-dimethyl-phenol	105-67-9
*CAS_121-14-2	2,4-dinitrotoluene	121-14-2
*CAS_93-76-5	2,4,5-T	93-76-5

ID_Contaminant	Label	CAS Number
*CAS_95-95-4	2,4,5-trichlorophenol	95-95-4
*CAS_732-26-3	2,4,6-tri-tert-butylphenol	732-26-3
*CAS_36065-30-2	2,4,6-tribromophenyl 2-methyl-2,3-dibromopropyl ether	36065-30-2
*CAS_88-06-2	2,4,6-trichlorophenol	88-06-2
*CAS_118-96-7	2,4,6-trinitrotoluene	118-96-7
*CAS_95-87-4	2,5-dimethylphenol	95-87-4
*CAS_2008-58-4	2,6-dichlorobenzamide	2008-58-4
*CAS_50-30-6	2,6-dichlorobenzoic acid	50-30-6
*CAS_87-65-0	2,6-dichlorophenol	87-65-0
*CAS_576-26-1	2,6-dimethyl-phenol	576-26-1
*CAS_128-37-0	2,6-Ditert-butyl-4-methylphenol	128-37-0
*CAS_16655-82-6	3-hydroxycarbofuran	16655-82-6
*CAS_59-50-7	3-methyl-4-chlorophenol	59-50-7
*CAS_55525-54-7	3,3'-(ureylenedimethylene)bis(3,5,5'- trimethylcyclohexyl) diisocyanate	55525-54-7
*CAS_95-76-1	3,4-dichloroaniline	95-76-1
*CAS_95-65-8	3,4-dimethyl-phenol	95-65-8
*CAS_108-68-9	3,5-dimethyl-phenol	108-68-9
*CAS_793-24-8	4-(dimethylbutylamino) diphenylamin (6PPD)	793-24-8
*CAS_101-55-3	4-bromophenyl phenyl ether	101-55-3
*CAS_1570-64-5	4-chloro-2-methylphenol	1570-64-5
*CAS_106-43-4	4-chlorotoluene	106-43-4
*CAS_99-87-6	4-isopropyltoluene	99-87-6
*CAS_106-44-5	4-methyl-phenol	106-44-5
*CAS_104-40-5	4-nonylphenol	104-40-5
*CAS_84852-15-3	4-nonylphenol, branched	84852-15-3
*CAS_98-51-1	4-tert-butyltoluene	98-51-1
*CAS_1570-65-6	4,6-dichloro-2-methylphenol	1570-65-6
*CAS_83-32-9	Acenaphthene	83-32-9
*CAS_208-96-8	Acenaphthylene	208-96-8
*CAS_160430-64-8	Acetamiprid	160430-64-8
*CAS_34256-82-1	Acetochlor	34256-82-1

ID_Contaminant	Label	CAS Number
*CAS_187022-11-3	Acetochlor ESA	187022-11-3
*CAS_194992-44-4	Acetochlor OA	194992-44-4
*EEA_3151-01-7	Acid neutralizing capacity	
*EEA_3153-01-3	Acid neutralizing capacity to pH 4.5	
*CAS_74070-46-5	Aclonifen	74070-46-5
*CAS_79-06-1	Acrylamide	79-06-1
*CAS_107-13-1	Acrylonitrile	107-13-1
*CAS_15972-60-8	Alachlor	15972-60-8
*CAS_142363-53-9	Alachlor ESA	142363-53-9
*CAS_171262-17-2	Alachlor OA	171262-17-2
*CAS_116-06-3	Aldicarb	116-06-3
*CAS_1646-87-3	Aldicarb sulfoxide	1646-87-3
*CAS_1646-88-4	Aldoxycarb	1646-88-4
*CAS_309-00-2	Aldrin	309-00-2
*EEA_33-01-2	Alkalised benzene	
*CAS_959-98-8	Alpha-Endosulfan	959-98-8
*CAS_319-84-6	Alpha-HCH	319-84-6
*CAS_134237-50-6	alpha-Hexabromocyclododecane	134237-50-6
*CAS_7429-90-5	Aluminium and its compounds	7429-90-5
*CAS_834-12-8	Ametryn	834-12-8
*CAS_120923-37-7	Amidosulfuron	120923-37-7
*CAS_1066-51-9	Aminomethylphosphonic acid (AMPA)	1066-51-9
*CAS_7664-41-7	Ammonia	7664-41-7
*CAS_14798-03-9	Ammonium	14798-03-9
*CAS_120-12-7	Anthracene	120-12-7
*CAS_7440-36-0	Antimony	7440-36-0
*CAS_59473-04-0	AOX	59473-04-0
*CAS_140-57-8	Aramite	140-57-8
*CAS_12767-79-2	Aroclor	12767-79-2
*CAS_7440-38-2	Arsenic and its compounds	7440-38-2
*CAS_1332-21-4	Asbestos	1332-21-4

ID_Contaminant	Label	CAS Number
*CAS_3337-71-1	Asulam	3337-71-1
*CAS_29122-68-7	Atenolol	29122-68-7
*CAS_1912-24-9	Atrazine	1912-24-9
*CAS_2642-71-9	Azinphos-ethyl	2642-71-9
*CAS_86-50-0	Azinphos-methyl	86-50-0
*CAS_83905-01-5	Azitromycin	83905-01-5
*CAS_131860-33-8	Azoxystrobin	131860-33-8
*CAS_7440-39-3	Barium	7440-39-3
*CAS_189084-64-8	BDE 100 (2,2',4,4',6-pentabromodiphenyl ether)	189084-64-8
*CAS_182677-30-1	BDE 138 (2,2',3,4,4',5'-hexabromodiphenyl ether)	182677-30-1
*CAS_68631-49-2	BDE 153 (2,2',4,4',5,5'-hexabromodiphenyl ether)	68631-49-2
*CAS_207122-15-4	BDE 154 (2,2',4,4',5,6'-hexabromodiphenyl ether)	207122-15-4
*CAS_68928-80-3	BDE 183 (Heptabromodiphenylether)	68928-80-3
*CAS_41318-75-6	BDE 28 (2,4,4'-tribromodiphenyl ether)	41318-75-6
*CAS_5436-43-1	BDE 47 (2,2',4,4'-tetrabromodiphenyl ether)	5436-43-1
*CAS_182346-21-0	BDE 85 (2,2',3,4,4'-pentabromodiphenyl ether)	182346-21-0
*CAS_60348-60-9	BDE 99 (2,2',4,4',5-pentabromodiphenyl ether)	60348-60-9
*CAS_3813-05-6	Benazolin	3813-05-6
*CAS_22781-23-3	Bendiocarb	22781-23-3
*CAS_1861-40-1	Benfluralin	1861-40-1
*CAS_83055-99-6	Bensulfuron-methyl	83055-99-6
*CAS_25057-89-0	Bentazone	25057-89-0
*CAS_71-43-2	Benzene	71-43-2
CAS_56-55-3	Benzo(a)anthracene	56-55-3
CAS_50-32-8	Benzo(a)pyrene	50-32-8
CAS_205-99-2	Benzo(b)fluoranthene	205-99-2
*CAS_191-24-2	Benzo(g,h,i)perylene	191-24-2
*CAS_207-08-9	Benzo(k)fluoranthene	207-08-9
*EEA_33-02-3	Benzol	
*CAS_95-14-7	Benzotriazol	95-14-7
*CAS_7440-41-7	Beryllium	7440-41-7

ID_Contaminant	Label	CAS Number
*CAS_33213-65-9	Beta-Endosulfan	33213-65-9
*CAS_319-85-7	Beta-HCH	319-85-7
*CAS_134237-51-7	beta-Hexabromocyclododecane	134237-51-7
*CAS_41859-67-0	Bezafibrate	41859-67-0
*CAS_42576-02-3	Bifenox	42576-02-3
*CAS_1163-19-5	Bis(pentabromophenyl) ether	1163-19-5
*CAS_80-05-7	Bisphenol A	80-05-7
*EEA_3133-01-5	BOD5	
*EEA_3133-02-6	BOD7	
*CAS_7440-42-8	Boron	7440-42-8
*CAS_188425-85-6	Boscalid	188425-85-6
*CAS_314-40-9	Bromacil	314-40-9
*CAS_15541-45-4	Bromate	15541-45-4
*CAS_24959-67-9	Bromide	24959-67-9
*EEA_32-04-2	Brominated diphenylethers (congener numbers 28, 47, 99, 100, 153 and 154)	
*EEA_33-04-5	Brominated flame retardants	
*CAS_108-86-1	Bromobenzene	108-86-1
*CAS_74-97-5	Bromochloromethane	74-97-5
*CAS_75-27-4	Bromodichloromethane	75-27-4
*CAS_75-25-2	Bromoform	75-25-2
*CAS_74-83-9	Bromomethane	74-83-9
*CAS_1689-84-5	Bromoxynil	1689-84-5
*CAS_1689-99-2	Bromoxynil octanoate	1689-99-2
*CAS_52-51-7	Bronopol	52-51-7
*EEA_33-05-6	BTEX	
*CAS_41483-43-6	Bupirimate	41483-43-6
*CAS_3766-60-7	Buturon	3766-60-7
*CAS_85-68-7	Butyl benzyl phthalate (BBP)	85-68-7
CAS_7440-43-9	Cadmium and its compounds	7440-43-9
*CAS_58-08-2	Caffeine	58-08-2
*CAS_7440-70-2	Calcium	7440-70-2

ID_Contaminant	Label	CAS Number
*CAS_133-06-2	Captan	133-06-2
*CAS_298-46-4	Carbamazepin	298-46-4
*CAS_63-25-2	Carbaryl	63-25-2
*CAS_10605-21-7	Carbendazim	10605-21-7
*CAS_16118-49-3	Carbetamide	16118-49-3
*CAS_1563-66-2	Carbofuran	1563-66-2
*CAS_7440-44-0	Carbon	7440-44-0
*CAS_56-23-5	Carbon tetrachloride	56-23-5
*CAS_3812-32-6	Carbonate	3812-32-6
*CAS_786-19-6	Carbophenothion	786-19-6
*EEA_123-06-8	Charaphytes presence	
*CAS_10599-90-3	Chloramide	10599-90-3
*CAS_14866-68-3	Chlorates	14866-68-3
*CAS_13360-45-7	Chlorbromuron	13360-45-7
*CAS_57-74-9	Chlordane	57-74-9
*CAS_143-50-0	Chlordecone (Kepone)	143-50-0
*CAS_6164-98-3	Chlordimeform	6164-98-3
*CAS_470-90-6	Chlorfenvinphos	470-90-6
*CAS_7790-93-4	Chloric acid	7790-93-4
*CAS_1698-60-8	Chloridazon	1698-60-8
*CAS_6339-19-1	Chloridazon desphenyl	6339-19-1
*CAS_17254-80-7	Chloridazon methyl desphenyl	17254-80-7
*CAS_16887-00-6	Chloride	16887-00-6
*EEA_33-06-7	Chlorinated benzene	
*EEA_33-07-8	Chlorinated phenol	
*EEA_3142-02-7	Chlorine Cl-	
*CAS_14998-27-7	Chlorite	14998-27-7
*CAS_85535-84-8	Chloroalkanes C10-13	85535-84-8
*CAS_85535-85-9	Chloroalkanes C14-17,MCCP	85535-85-9
*CAS_108-90-7	Chlorobenzene	108-90-7
*CAS_75-01-4	Chloroethene (vinylchloride)	75-01-4

ID_Contaminant	Label	CAS Number
*EEA_3164-01-0	Chlorophyll a	
*CAS_1897-45-6	Chlorothalonil	1897-45-6
*CAS_1418095-02-9	Chlorothalonil ESA (VIS-01)	1418095-02-9
*CAS_1982-47-4	Chloroxuron	1982-47-4
*CAS_2921-88-2	Chlorpyrifos	2921-88-2
*CAS_5598-13-0	Chlorpyrifos-methyl	5598-13-0
*CAS_64902-72-3	Chlorsulfuron	64902-72-3
*CAS_1918-13-4	Chlorthiamid	1918-13-4
*CAS_15545-48-9	Chlortoluron	15545-48-9
*EEA_33-08-9	Chromium (III)	
*CAS_18540-29-9	Chromium (VI)	18540-29-9
*CAS_7440-47-3	Chromium and its compounds	7440-47-3
*CAS_1333-82-0	Chromium trioxide (CrO ₃)	1333-82-0
CAS_218-01-9	Chrysene	218-01-9
*CAS_156-59-2	cis-1,2-dichloroethene	156-59-2
*CAS_10061-01-5	cis-1,3-dichloropropene	10061-01-5
*CAS_81103-11-9	Clarithromycin	81103-11-9
*CAS_81777-89-1	Clomazone	81777-89-1
*CAS_1702-17-6	Clopyralid	1702-17-6
*CAS_210880-92-5	Clothianidin	210880-92-5
*CAS_23593-75-1	Clotrimazole	23593-75-1
*CAS_7440-48-4	Cobalt and its compounds	7440-48-4
*EEA_3133-03-7	CODCr	
*EEA_3133-04-8	CODMn	
*CAS_7440-50-8	Copper and its compounds	7440-50-8
*CAS_56-72-4	Coumaphos	56-72-4
*CAS_21725-46-2	Cyanazine	21725-46-2
*EEA_11-06-3	Cyanobacteria biomass	
*EEA_11-07-4	Cyanobacteria proportion	
*CAS_506-77-4	Cyanogen chloride	506-77-4
*CAS_28159-98-0	Cybutryne	28159-98-0

ID_Contaminant	Label	CAS Number
*CAS_294-62-2	Cyclododecane	294-62-2
*CAS_101205-02-1	Cycloxydim	101205-02-1
*CAS_57966-95-7	Cymoxanil	57966-95-7
*CAS_52315-07-8	Cypermethrin	52315-07-8
*CAS_121552-61-2	Cyprodinil	121552-61-2
*CAS_75-99-0	Dalapon	75-99-0
*CAS_789-02-6	DDT, o,p'	789-02-6
*CAS_50-29-3	DDT, p,p'	50-29-3
*CAS_3397-62-4	Deisopropyldeethylatrazine	3397-62-4
*CAS_319-86-8	Delta-HCH	319-86-8
*CAS_52918-63-5	Deltamethrin	52918-63-5
*CAS_919-86-8	Demeton-S-methyl	919-86-8
*CAS_17040-19-6	Demeton-S-methylsulfon	17040-19-6
*CAS_52236-30-3	Desamino-diketo-metribuzin	52236-30-3
*CAS_6190-65-4	Desethylatrazine	6190-65-4
*CAS_30125-63-4	Desethylterbuthylazine	30125-63-4
*CAS_1007-28-9	Desisopropylatrazine	1007-28-9
*CAS_13684-56-5	Desmedipham	13684-56-5
*CAS_1014-69-3	Desmetryn	1014-69-3
*EEA_33-09-0	Detergents	
*CAS_84-66-2	Di-ethyl phthalate	84-66-2
*CAS_84-69-5	Di-iso-butyl phthalate	84-69-5
*CAS_117-81-7	Di(2-ethylhexyl)phthalate (DEHP)	117-81-7
*CAS_333-41-5	Diazinon	333-41-5
*CAS_53-70-3	Dibenzo(a,h)anthracene	53-70-3
*CAS_262-12-4	Dibenzodioxin	262-12-4
*CAS_3252-43-5	Dibromoacetonitrile	3252-43-5
*CAS_124-48-1	Dibromochlorometane	124-48-1
*CAS_74-95-3	Dibromomethane	74-95-3
*CAS_84-74-2	Dibutylphthalate	84-74-2
*CAS_1002-53-5	Dibutyltin	1002-53-5

ID_Contaminant	Label	CAS Number
*CAS_1918-00-9	Dicamba	1918-00-9
*CAS_1194-65-6	Dichlobenil	1194-65-6
*CAS_79-43-6	Dichloroacetic acid	79-43-6
*CAS_3018-12-0	Dichloroacetonitrile	3018-12-0
*EEA_33-10-3	Dichlorobenzene	
*CAS_75-71-8	Dichlorodifluoromethane	75-71-8
*CAS_75-09-2	Dichloromethane	75-09-2
*EEA_33-11-4	Dichlorophenol	
*CAS_120-36-5	Dichlorprop (2,4-DP)	120-36-5
*CAS_15165-67-0	Dichlorprop-P	15165-67-0
*CAS_62-73-7	Dichlorvos	62-73-7
*CAS_15307-86-5	Diclofenac	15307-86-5
*CAS_15307-79-6	Diclofenac sodium	15307-79-6
*CAS_99-30-9	Dicloran	99-30-9
*CAS_115-32-2	Dicofol	115-32-2
*CAS_60-57-1	Dieldrin	60-57-1
*CAS_134-62-3	Diethyltoluamide (DEET)	134-62-3
*CAS_35367-38-5	Diflubenzuron	35367-38-5
*CAS_83164-33-4	Diflufenican	83164-33-4
*CAS_56507-37-0	Diketo-metribuzin	56507-37-0
*CAS_50563-36-5	Dimethachlor	50563-36-5
*CAS_87674-68-8	Dimethenamid	87674-68-8
*CAS_205939-58-8	Dimethenamid ESA	205939-58-8
*CAS_380412-59-9	Dimethenamid OA	380412-59-9
*CAS_60-51-5	Dimethoate	60-51-5
*CAS_110488-70-5	Dimethomorph	110488-70-5
*CAS_131-11-3	Dimethyl phthalate	131-11-3
*CAS_534-52-1	Dinitro-o-cresol (DNOC)	534-52-1
*CAS_88-85-7	Dinoseb	88-85-7
*CAS_2813-95-8	Dinoseb acetate	2813-95-8
*CAS_512-04-9	Diosgenin	512-04-9

ID_Contaminant	Label	CAS Number
EEA_33-54-5	Dioxin-like polychlorinated biphenyls (12 PCB-DLs: 77,81,105,114,118,123,126,156,157,167,169,189)	
EEA_33-58-9	Dioxins and dioxin-like compounds (7 PCDDs + 10 PCDFs + 12 PCB-DLs)	
*CAS_131-18-0	Dipentyl phthalate	131-18-0
*CAS_131-16-8	Dipropyl phthalate	131-16-8
*EEA_3133-05-9	Dissolved organic carbon (DOC)	
*EEA_3132-01-2	Dissolved oxygen	
*CAS_298-04-4	Disulfoton	298-04-4
*CAS_330-54-1	Diuron	330-54-1
*EEA_33-13-6	DOX	
*CAS_60-00-4	EDTA	60-00-4
*EEA_3142-01-6	Electrical conductivity	
*CAS_115-29-7	Endosulfan	115-29-7
*CAS_72-20-8	Endrin	72-20-8
*CAS_106-89-8	Epichlorohydrin	106-89-8
*CAS_133855-98-8	Epoiconazole	133855-98-8
*CAS_6108-10-7	Epsilon-HCH	6108-10-7
*CAS_114-07-8	Erythromycin	114-07-8
*CAS_53-16-7	Estrone (E1)	53-16-7
*CAS_135410-20-7	Ethanimidamide	135410-20-7
*CAS_29973-13-5	Ethiofencarb	29973-13-5
*CAS_563-12-2	Ethion	563-12-2
*CAS_23947-60-6	Ethirimol	23947-60-6
*CAS_26225-79-6	Ethofumesate	26225-79-6
*CAS_2104-64-5	Ethyl O-(p-nitrophenyl) phenyl phosphonothionate (EPN)	2104-64-5
*CAS_100-41-4	Ethylbenzene	100-41-4
*CAS_75-21-8	Ethylene oxide	75-21-8
*CAS_96-45-7	Ethylenethiourea (ETU)	96-45-7
*CAS_80844-07-1	Etofenprox	80844-07-1
*EEA_33-14-7	Extractable organically bound chlorine	
*CAS_120928-09-8	Fenazaquin	120928-09-8
*CAS_13356-08-6	Fenbutatin oxide	13356-08-6

ID_Contaminant	Label	CAS Number
*CAS_299-84-3	Fenclorphos	299-84-3
*CAS_122-14-5	Fenitrothion	122-14-5
*CAS_93-72-1	Fenoprop	93-72-1
*CAS_95617-09-7	Fenoxaprop	95617-09-7
*CAS_67564-91-4	Fenpropimorph	67564-91-4
*CAS_134098-61-6	Fenpyroximate	134098-61-6
*CAS_55-38-9	Fenthion	55-38-9
*CAS_101-42-8	Fenuron	101-42-8
*EEA_14-03-9	FishEQR_A	
*EEA_14-04-0	FishEQR_E	
*EEA_14-01-7	FishEQR_G	
*EEA_14-02-8	FishEQR_H	
*CAS_79241-46-6	Fluazifop-P-butyl	79241-46-6
*CAS_70124-77-5	Flucythrinate	70124-77-5
*CAS_142459-58-3	Flufenacet	142459-58-3
*CAS_201668-32-8	Flufenacet ESA	201668-32-8
*CAS_206-44-0	Fluoranthene	206-44-0
*CAS_86-73-7	Fluorene	86-73-7
*CAS_16984-48-8	Fluoride	16984-48-8
*CAS_7782-41-4	Fluorine	7782-41-4
*CAS_144-49-0	Fluoroacetic acid	144-49-0
*CAS_54910-89-3	Fluoxetine	54910-89-3
*CAS_136426-54-5	Fluquinconazole	136426-54-5
*CAS_69377-81-7	Fluroxypyr	69377-81-7
*CAS_81406-37-3	Fluroxypyr-meptyl	81406-37-3
*CAS_133-07-3	Folpet	133-07-3
*CAS_72178-02-0	Fomesafen	72178-02-0
*CAS_944-22-9	Fonofos	944-22-9
*CAS_50-00-0	Formaldehyde	50-00-0
*CAS_2540-82-1	Formothion	2540-82-1
*CAS_57-12-5	Free cyanide	57-12-5

ID_Contaminant	Label	CAS Number
*CAS_121776-33-8	Furilazole	121776-33-8
*CAS_58-89-9	Gamma-HCH (Lindane)	58-89-9
*CAS_134237-52-8	gamma-Hexabromocyclododecane	134237-52-8
*CAS_1071-83-6	Glyphosate	1071-83-6
*EEA_34-02-6	Groundwater Directive Annex II pollutant	
*EEA_33-15-8	Halogenated organic compounds	
*EEA_31-01-6	Hardness	
*EEA_32-25-7	Heavy metals - aggregated	
*CAS_76-44-8	Heptachlor	76-44-8
*EEA_33-50-1	Heptachlor and heptachlor epoxide	
*CAS_1024-57-3	Heptachlor epoxide	1024-57-3
*CAS_32241-08-0	Heptachloronaphthalene	32241-08-0
*CAS_2440-02-0	Heptachloronorborene	2440-02-0
*CAS_36355-01-8	Hexabromobiphenyl	36355-01-8
*EEA_33-57-8	Hexabromocyclododecanes (HBCDD)	
*CAS_36483-60-0	Hexabromodiphenylether	36483-60-0
*CAS_118-74-1	Hexachlorobenzene	118-74-1
*CAS_87-68-3	Hexachlorobutadiene	87-68-3
*CAS_608-73-1	Hexachlorocyclohexane	608-73-1
*CAS_77-47-4	Hexachlorocyclopentadiene (HCCP)	77-47-4
*CAS_1335-87-1	Hexachloronaphthalene	1335-87-1
*CAS_107-46-0	Hexamethyldisiloxane (HMDS)	107-46-0
*CAS_51235-04-2	Hexazinone	51235-04-2
*EEA_33-17-0	Hydrocarbons	
*CAS_71-52-3	Hydrogen Carbonate (Bicarbonate) HCO ₃	71-52-3
*CAS_74-90-8	Hydrogen cyanide	74-90-8
*CAS_7783-06-4	Hydrogen sulphide	7783-06-4
*CAS_2163-68-0	Hydroxyatrazine	2163-68-0
*CAS_2599-11-3	Hydroxysimazine	2599-11-3
*CAS_66753-07-9	Hydroxyterbutylazine	66753-07-9
*CAS_15687-27-1	Ibuprofen	15687-27-1

ID_Contaminant	Label	CAS Number
*CAS_182636-13-1	Imazamox	182636-13-1
*CAS_138261-41-3	Imidacloprid	138261-41-3
*CAS_105827-78-9	Imidacloprid (Watch list only alternative code)	105827-78-9
*CAS_193-39-5	Indeno(1,2,3-cd)pyrene	193-39-5
*EEA_32-27-9	Industrial pollutants - aggregated	
*EEA_13-03-6	InvertebrateEQR_A	
*EEA_13-04-7	InvertebrateEQR_E	
*EEA_13-01-4	InvertebrateEQR_G	
*EEA_13-02-5	InvertebrateEQR_H	
*CAS_20461-54-5	Iodide	20461-54-5
*CAS_18181-70-9	Iodofenphos	18181-70-9
*CAS_185119-76-0	Iodosulfuron-methyl	185119-76-0
*CAS_1689-83-4	Ioxynil	1689-83-4
*CAS_36734-19-7	Iprodione	36734-19-7
*CAS_140923-17-7	Iprovalicarb	140923-17-7
*CAS_7439-89-6	Iron and its compounds	7439-89-6
*CAS_297-78-9	Isobenzane	297-78-9
*CAS_465-73-6	Isodrin	465-73-6
*EEA_123-07-9	Isoetides presence	
*CAS_98-82-8	Isopropylbenzene	98-82-8
*CAS_34123-59-6	Isoproturon	34123-59-6
*CAS_141112-29-0	Isoxaflutole	141112-29-0
*CAS_4234-79-1	Kelevan	4234-79-1
*EEA_3161-01-1	Kjeldahl nitrogen	
*CAS_143390-89-0	Kresoxim-methyl	143390-89-0
CAS_7439-92-1	Lead and its compounds	7439-92-1
*CAS_2164-08-1	Lenacil	2164-08-1
*CAS_330-55-2	Linuron	330-55-2
*CAS_7439-93-2	Lithium	7439-93-2
*CAS_108-38-3	M-xylene	108-38-3
*EEA_123-05-7	Macrophyte depth limit	

ID_Contaminant	Label	CAS Number
*EEA_123-03-5	MacrophyteEQR_A	
*EEA_123-04-6	MacrophyteEQR_E	
*EEA_123-01-3	MacrophyteEQR_G	
*EEA_123-02-4	MacrophyteEQR_H	
*CAS_7439-95-4	Magnesium	7439-95-4
*CAS_121-75-5	Malathion	121-75-5
*CAS_123-33-1	Maleinhydrazid	123-33-1
*CAS_7439-96-5	Manganese and its compounds	7439-96-5
*CAS_94-74-6	MCPA	94-74-6
*CAS_94-81-5	MCPB	94-81-5
*CAS_7085-19-0	Mecoprop	7085-19-0
*CAS_16484-77-8	Mecoprop-P (MCP-P)	16484-77-8
CAS_7439-97-6	Mercury and its compounds	7439-97-6
*CAS_104206-82-8	Mesotrione	104206-82-8
*EEA_33-18-1	Meta xylene + para xylene	
*CAS_57837-19-1	Metalaxyl	57837-19-1
*CAS_70630-17-0	Metalaxyl-M	70630-17-0
*CAS_41394-05-2	Metamitron	41394-05-2
*CAS_67129-08-2	Metazachlor	67129-08-2
*CAS_172960-62-2	Metazachlor ESA	172960-62-2
*CAS_1231244-60-2	Metazachlor OA	1231244-60-2
*CAS_18691-97-9	Methabenzthiazuron	18691-97-9
*CAS_10265-92-6	Methamidophos	10265-92-6
*CAS_950-37-8	Methidathion	950-37-8
*CAS_2032-65-7	Methiocarb	2032-65-7
*CAS_16752-77-5	Methomyl	16752-77-5
*CAS_72-43-5	Methoxychlor	72-43-5
*CAS_136-85-6	Methylbenzotriazol	136-85-6
*CAS_3060-89-7	Metobromuron	3060-89-7
*CAS_51218-45-2	Metolachlor	51218-45-2
*CAS_171118-09-5	Metolachlor ESA	171118-09-5

ID_Contaminant	Label	CAS Number
*CAS_152019-73-3	Metolachlor OA	152019-73-3
*CAS_37350-58-6	Metoprolol	37350-58-6
*CAS_139528-85-1	Metosulam	139528-85-1
*CAS_19937-59-8	Metoxuron	19937-59-8
*CAS_21087-64-9	Metribuzin	21087-64-9
*CAS_35045-02-4	Metribuzin-DA	35045-02-4
*CAS_74223-64-6	Metsulfuronmethyl	74223-64-6
*CAS_7786-34-7	Mevinphos	7786-34-7
*CAS_77238-39-2	Microcystin	77238-39-2
*CAS_2385-85-5	Mirex	2385-85-5
*CAS_2212-67-1	Molinate	2212-67-1
*CAS_7439-98-7	Molybdenum and its compounds	7439-98-7
*EEA_33-19-2	Mono basic phenols	
*EEA_33-20-5	Monochlorophenols	
*CAS_1746-81-2	Monolinuron	1746-81-2
*CAS_150-68-5	Monuron	150-68-5
*CAS_4636-83-3	Morfamquat	4636-83-3
*CAS_1634-04-4	MTBE	1634-04-4
*CAS_81-15-2	Musk xylene	81-15-2
*CAS_104-51-8	n-butylbenzene	104-51-8
*CAS_4245-76-5	N-methyl-N'-nitroguanidine	4245-76-5
*CAS_103-65-1	n-propylbenzene	103-65-1
*CAS_3984-14-3	N,N-dimethylsulfamide	3984-14-3
*CAS_91-20-3	Naphthalene	91-20-3
*CAS_70776-03-3	Naphthalene, chloro derivatives	70776-03-3
*CAS_15299-99-7	Napropamide	15299-99-7
*CAS_22204-53-1	Naproxen	22204-53-1
*CAS_555-37-3	Neburon	555-37-3
*CAS_7440-02-0	Nickel and its compounds	7440-02-0
*CAS_111991-09-4	Nicosulfuron	111991-09-4
*CAS_14797-55-8	Nitrate	14797-55-8

ID_Contaminant	Label	CAS Number
*EEA_3164-08-7	Nitrate to orthophosphate ratio	
*CAS_14797-65-0	Nitrite	14797-65-0
*EEA_33-21-6	Nitrobenzene	
*CAS_556-88-7	Nitroguanidine	556-88-7
*CAS_1836-75-5	Nitrophen	1836-75-5
*CAS_100-02-7	Nitrophenol	100-02-7
*EEA_31613-01-1	Non-ionised ammonia	
*EEA_33-59-0	Nonylphenol and nonylphenol ethoxylates (NP + NPEs)	
*CAS_9016-45-9	Nonylphenol ethoxylate	9016-45-9
*CAS_139-13-9	NTA	139-13-9
*CAS_95-47-6	O-xylene	95-47-6
*CAS_53-19-0	o,p'-DDD	53-19-0
*CAS_3424-82-6	o,p'-DDE	3424-82-6
*CAS_32536-52-0	Octabromodiphenyl ether	32536-52-0
*CAS_2234-13-1	Octachloronaphthalene	2234-13-1
*CAS_1806-26-4	Octylphenol	1806-26-4
*CAS_140-66-9	Octylphenol (4-(1,1',3,3'-tetramethylbutyl)-phenol)	140-66-9
*EEA_33-55-6	Octylphenols (CAS 1806-26-4) including isomer 4-(1,1',3,3'-tetramethylbutyl)-phenol (CAS 140-66-9)	
*EEA_33-22-7	Oil fractions (C10-40)	
*CAS_1113-02-6	Omethoate	1113-02-6
*CAS_34622-58-7	Orbencarb	34622-58-7
*EEA_33-60-3	Organotin compounds (as total Sn)	
*EEA_00-00-0	Other chemical parameter	
*EEA_34-03-7	Other pollutants - aggregated	
*CAS_19666-30-9	Oxadiazon	19666-30-9
*CAS_23135-22-0	Oxamyl	23135-22-0
*EEA_3131-01-9	Oxygen saturation	
*CAS_79-57-2	Oxytetracycline	79-57-2
*CAS_106-42-3	P-xylene	106-42-3
*CAS_72-54-8	p,p'-DDD	72-54-8
*CAS_72-55-9	p,p'-DDE	72-55-9

ID_Contaminant	Label	CAS Number
*CAS_56-38-2	Parathion	56-38-2
*CAS_298-00-0	Parathion-methyl	298-00-0
*EEA_3161-04-4	Particulate organic nitrogen	
CAS_37680-73-2	PCB 101 (2,2',4,5,5'-pentachlorobiphenyl)	37680-73-2
*CAS_60145-21-3	PCB 103 (2,2',4,5',6-pentachlorobiphenyl)	60145-21-3
*CAS_32598-14-4	PCB 105 (2,3,3',4,4'-pentachlorobiphenyl)	32598-14-4
*CAS_70362-41-3	PCB 106 (2,3,3',4,5'-pentachlorobiphenyl)	70362-41-3
*CAS_74472-37-0	PCB 114 (2,3,4,4',5-pentachlorobiphenyl)	74472-37-0
*CAS_31508-00-6	PCB 118 (2,3',4,4',5-pentachlorobiphenyl)	31508-00-6
*CAS_65510-44-3	PCB 123 (1,2,3-trichloro-5-(2,4-dichlorophenyl)benzene)	65510-44-3
*CAS_57465-28-8	PCB 126 (3,3',4,4',5-pentachlorobiphenyl)	57465-28-8
CAS_35065-28-2	PCB 138 (2,2',3,4,4',5'-hexachlorobiphenyl)	35065-28-2
CAS_35065-27-1	PCB 153 (2,2',4,4',5,5'-hexachlorobiphenyl)	35065-27-1
*CAS_38380-08-4	PCB 156 (2,3,3',4,4',5-hexachlorobiphenyl)	38380-08-4
*CAS_69782-90-7	PCB 157 (2,3,3',4,4',5'-hexachlorobiphenyl)	69782-90-7
*CAS_52663-72-6	PCB 167 (1,2,3-trichloro-5-(2,4,5-trichlorophenyl)benzene)	52663-72-6
*CAS_32774-16-6	PCB 169 (3,3',4,4',5,5'-hexachlorobiphenyl)	32774-16-6
*CAS_35065-30-6	PCB 170 (1,2,3,4-tetrachloro-5-(2,3,4-trichlorophenyl)benzene)	35065-30-6
CAS_35065-29-3	PCB 180 (2,2',3,4,4',5,5'-heptachlorobiphenyl)	35065-29-3
*CAS_39635-31-9	PCB 189 (1,2,3,4-tetrachloro-5-(3,4,5-trichlorophenyl)benzene)	39635-31-9
*CAS_35694-08-7	PCB 194 (1,2,3,4-tetrachloro-5-(2,3,4,5-tetrachlorophenyl)benzene)	35694-08-7
*CAS_2051-24-3	PCB 209 (5,5',6,6'-decachlorobiphenyl)	2051-24-3
CAS_7012-37-5	PCB 28 (2,4,4'-trichlorobiphenyl)	7012-37-5
CAS_35693-99-3	PCB 52 (2,2',5,5'-tetrachlorobiphenyl)	35693-99-3
*CAS_41464-42-0	PCB 72 (2,3',5,5'-Tetrachlorobiphenyl)	41464-42-0
*CAS_32598-13-3	PCB 77 (3,3',4,4'-tetrachlorobiphenyl)	32598-13-3
*CAS_70362-50-4	PCB 81 (3,4,4',5-tetrachlorobiphenyl)	70362-50-4
*CAS_66246-88-6	Penconazole	66246-88-6
*CAS_40487-42-1	Pendimethalin	40487-42-1
*CAS_32534-81-9	Pentabromodiphenylether	32534-81-9
*CAS_85-22-3	Pentabromoethylbenzene	85-22-3

ID_Contaminant	Label	CAS Number
*CAS_1825-21-4	Pentachloroanisole	1825-21-4
*CAS_608-93-5	Pentachlorobenzene	608-93-5
*CAS_16478-18-5	Pentachloriodobenzene	16478-18-5
*CAS_1321-64-8	Pentachloronaphthalene	1321-64-8
*CAS_87-86-5	Pentachlorophenol	87-86-5
*CAS_1763-23-1	Perfluorooctane sulfonic acid (PFOS) and its derivatives	1763-23-1
*CAS_52645-53-1	Permethrin-cis+trans	52645-53-1
*EEA_32-26-8	Pesticides - aggregated	
*EEA_34-01-5	Pesticides (Active substances in pesticides, including their relevant metabolites, degradation and reaction products)	
*CAS_106700-29-2	Pethoxamid	106700-29-2
*EEA_33-23-8	Petroleum hydrocarbons	
*EEA_33-24-9	Petroleum products	
*CAS_335-67-1	PFOA	335-67-1
*EEA_3152-01-0	pH	
*CAS_85-01-8	Phenanthrene	85-01-8
*CAS_108-95-2	Phenol	108-95-2
*CAS_64743-03-9	Phenols	64743-03-9
*CAS_298-02-2	Phorate	298-02-2
*CAS_2310-17-0	Phosalone	2310-17-0
*CAS_14265-44-2	Phosphate	14265-44-2
*EEA_124-03-8	PhytobenthosEQR_A	
*EEA_124-04-9	PhytobenthosEQR_E	
*EEA_124-01-6	PhytobenthosEQR_G	
*EEA_124-02-7	PhytobenthosEQR_H	
*EEA_11-03-0	PhytoplanktonEQR_A	
*EEA_11-04-1	PhytoplanktonEQR_E	
*EEA_11-01-8	PhytoplanktonEQR_G	
*EEA_11-02-9	PhytoplanktonEQR_H	
*CAS_1918-02-1	Picloram	1918-02-1
*CAS_137641-05-5	Picolinafen	137641-05-5
*CAS_23103-98-2	Pirimicarb	23103-98-2

ID_Contaminant	Label	CAS Number
*CAS_23505-41-1	Pirimiphos-ethyl	23505-41-1
*CAS_29232-93-7	Pirimiphos-methyl	29232-93-7
*CAS_1336-36-3	Polychlorinated biphenyls	1336-36-3
EEA_33-38-5	Polychlorinated biphenyls(7 PCB: 28,52,101,118,138,153,180)	
*EEA_33-26-1	Polychlorinated dibenzodioxins (PCDD)	
*CAS_136677-10-6	Polychlorinated dibenzofurans (10 PCDFs)	136677-10-6
*CAS_7440-09-7	Potassium	7440-09-7
*CAS_86209-51-0	Primisulfuron-methyl	86209-51-0
*CAS_67747-09-5	Prochloraz	67747-09-5
*CAS_32809-16-8	Procymidone	32809-16-8
*CAS_1610-18-0	Prometon	1610-18-0
*CAS_7287-19-6	Prometryn	7287-19-6
*CAS_1918-16-7	Propachlor	1918-16-7
*CAS_709-98-8	Propanil	709-98-8
*CAS_139-40-2	Propazine	139-40-2
*CAS_31218-83-4	Propetamphos	31218-83-4
*CAS_60207-90-1	Propiconazole	60207-90-1
*CAS_114-26-1	Propoxur	114-26-1
*CAS_525-66-6	Propranolol	525-66-6
*CAS_23950-58-5	Propyzamide	23950-58-5
*CAS_52888-80-9	Prosulfocarb	52888-80-9
*CAS_94125-34-5	Prosulfuron	94125-34-5
*CAS_129-00-0	Pyrene	129-00-0
*CAS_96489-71-3	Pyridaben	96489-71-3
*CAS_55512-33-9	Pyridate	55512-33-9
*CAS_53112-28-0	Pyrimethanil	53112-28-0
*CAS_124495-18-7	Quinoxifen	124495-18-7
*CAS_82-68-8	Quintozene	82-68-8
*CAS_76578-12-6	Quizalofop	76578-12-6
*CAS_100646-51-3	Quizalofop-P-ethyl	100646-51-3
EEA_33-27-2	Radionuclides	

ID_Contaminant	Label	CAS Number
*CAS_122931-48-0	Rimsulfuron	122931-48-0
*CAS_7286-69-3	Sebuthylazine	7286-69-3
*CAS_135-98-8	sec-butylbenzene	135-98-8
*CAS_26259-45-0	Secbumeton	26259-45-0
*EEA_3111-01-1	Secchi depth	
*CAS_7782-49-2	Selenium and its compounds	7782-49-2
*EEA_3163-01-7	Silicate	
*CAS_7440-21-3	Silicon	7440-21-3
*CAS_7440-22-4	Silver	7440-22-4
*CAS_122-34-9	Simazine	122-34-9
*CAS_7440-23-5	Sodium	7440-23-5
*CAS_151-21-3	Sodium dodecyl sulfate	151-21-3
*CAS_118134-30-8	Spiroxamine	118134-30-8
*CAS_7440-24-6	Strontium	7440-24-6
*CAS_100-42-5	Styrene	100-42-5
*CAS_99105-77-8	Sulcotrione	99105-77-8
*CAS_723-46-6	Sulfamethoxazol	723-46-6
*CAS_141776-32-1	Sulfosulfuron	141776-32-1
*CAS_18785-72-3	Sulphate	18785-72-3
*EEA_33-28-3	Surfactants (anionic and nonionic)	
*EEA_33-29-4	Surfactants (anionic)	
*CAS_994-05-8	TAME	994-05-8
*CAS_1746-01-6	TCDD (2,3,7,8-tetrachlorodibenzo-p-dioxin)	1746-01-6
*CAS_107534-96-3	Tebuconazole	107534-96-3
*CAS_112410-23-8	Tebufenozide	112410-23-8
*CAS_13071-79-9	Terbufos	13071-79-9
*CAS_33693-04-8	Terbumeton	33693-04-8
*CAS_5915-41-3	Terbuthylazine	5915-41-3
*CAS_886-50-0	Terbutryn	886-50-0
*CAS_98-06-6	tert-butylbenzene	98-06-6
*CAS_79-94-7	Tetrabromobisphenol A (TBBP-A)	79-94-7

ID_Contaminant	Label	CAS Number
*CAS_40088-47-9	Tetrabromodiphenylether	40088-47-9
*CAS_1461-25-2	Tetrabutyltin	1461-25-2
*CAS_127-18-4	Tetrachloroethylene	127-18-4
*CAS_1335-88-2	Tetrachloronaphthalene	1335-88-2
*CAS_25167-83-3	Tetrachlorophenols	25167-83-3
*CAS_2227-13-6	Tetrasul	2227-13-6
*CAS_7440-28-0	Thallium	7440-28-0
*CAS_111988-49-9	Thiacloprid	111988-49-9
*CAS_153719-23-4	Thiamethoxam	153719-23-4
*CAS_79277-27-3	Thifensulfuron-methyl	79277-27-3
*CAS_28249-77-6	Thiobencarb	28249-77-6
*CAS_23564-05-8	Thiophanate-methyl	23564-05-8
*CAS_137-26-8	Thiram	137-26-8
*CAS_7440-31-5	Tin and its compounds	7440-31-5
*CAS_36756-79-3	Tiocarbazil	36756-79-3
*CAS_7440-32-6	Titanium	7440-32-6
*CAS_108-88-3	Toluene	108-88-3
*CAS_13351-73-0	Tolyltriazole	13351-73-0
*EEA_32-23-5	Total Benzo(b)fluor-anthene (CAS_205-99-2) + Benzo(k)fluor-anthene (CAS_207-08-9)	
*EEA_32-24-6	Total Benzo(g,h,i)perylene (CAS_191-24-2) + Indeno(1,2,3-cd)pyrene (CAS_193-39-5)	
*EEA_33-63-6	Total brominated diphenylethers (penta-BDE + octa-BDE + deca-BDE)	
*EEA_33-31-8	Total chrysene + triphenylene	
*EEA_33-64-7	Total cyanide	
*EEA_32-02-0	Total cyclodiene pesticides (aldrin + dieldrin + endrin + isodrin)	
*EEA_33-32-9	Total DDD (DDD, o,p' + DDD, p,p')	
*EEA_32-03-1	Total DDT (DDT, p,p' + DDT, o,p' + DDE, p,p' + DDD, p,p')	
EEA_33-40-9	Total dioxins and furans (PCDD + PCDF)	
*EEA_31-03-8	Total dissolved solids	
*EEA_33-53-4	Total Estrone (E1) + 17beta-estradiol (E2)	
*EEA_33-44-3	Total highly volatile halogenated hydrocarbons	

ID_Contaminant	Label	CAS Number
*EEA_33-36-3	Total hydrocarbons	
*EEA_3161-05-5	Total inorganic nitrogen	
*EEA_33-51-2	Total macrolide antibiotics (erythromycin + clarithromycin + azithromycin)	
*EEA_33-52-3	Total neonicotinoid insecticides (imidacloprid + thiacloprid + thiamethoxam + clothianidin + acetamiprid)	
*EEA_31615-01-7	Total nitrogen	
*EEA_3164-07-6	Total nitrogen to total phosphorus ratio	
*EEA_3133-06-0	Total organic carbon (TOC)	
*EEA_3161-03-3	Total organic nitrogen	
*EEA_3161-02-2	Total oxidised nitrogen	
EEA_33-62-5	Total PAHs (4 PAHs: Benzo(a)pyrene, Benzo(b)fluoranthene, Benzo(k)fluoranthene, Indeno(1,2,3-cd)pyrene)	
EEA_33-56-7	Total PAHs (Benzo(a)pyrene, Benzo(b)fluoranthene, Benzo(k)fluoranthene, Benzo(ghi)perylene, Indeno(1,2,3-cd)pyrene)	
*CAS_7723-14-0	Total phosphorus	7723-14-0
*EEA_11-05-2	Total phytoplankton biomass	
*EEA_31-02-7	Total suspended solids	
*EEA_33-41-0	Total tri-, tetra- and pentachlorophenol	
*EEA_33-42-1	Total trichloroethylene + tetrachloroethylene	
*EEA_33-43-2	Total trihalomethanes	
*CAS_8001-35-2	Toxaphene	8001-35-2
*CAS_87820-88-0	Tralkoxydim	87820-88-0
*CAS_156-60-5	trans-1,2-dichloroethene	156-60-5
*CAS_10061-02-6	trans-1,3-dichloropropene	10061-02-6
*CAS_39765-80-5	trans-Nonachlor	39765-80-5
*CAS_2303-17-5	Tri-allate	2303-17-5
*CAS_43121-43-3	Triadimefon	43121-43-3
*CAS_55219-65-3	Triadimenol	55219-65-3
*CAS_82097-50-5	Triasulfuron	82097-50-5
*CAS_24017-47-8	Triazophos	24017-47-8
*CAS_36643-28-4	Tributyltin-cation	36643-28-4
*CAS_76-03-9	Trichloroacetic acid	76-03-9

ID_Contaminant	Label	CAS Number
*CAS_12002-48-1	Trichlorobenzenes (all isomers)	12002-48-1
*CAS_79-01-6	Trichloroethylene	79-01-6
*CAS_75-69-4	Trichlorofluoromethane	75-69-4
*CAS_67-66-3	Trichloromethane	67-66-3
*CAS_1321-65-9	Trichloronaphthalene	1321-65-9
*CAS_55335-06-3	Triclopyr	55335-06-3
*CAS_3380-34-5	Triclosan	3380-34-5
*CAS_1912-26-1	Trietazine	1912-26-1
*CAS_1582-09-8	Trifluralin	1582-09-8
*CAS_126535-15-7	Triflusulfuron-methyl	126535-15-7
*CAS_738-70-5	Trimethoprim	738-70-5
*CAS_603-35-0	Triphenyl phosphine	603-35-0
*EEA_33-61-4	Triphenyltin and compounds	
*CAS_10028-17-8	Tritium	10028-17-8
*CAS_7440-33-7	Tungsten and its compounds	7440-33-7
*EEA_3112-01-4	Turbidity	
*CAS_7440-61-1	Uranium	7440-61-1
*CAS_7440-62-2	Vanadium and its compounds	7440-62-2
*CAS_50471-44-8	Vinclozolin	50471-44-8
*CAS_51000-52-3	Vinyl neodecanoate	51000-52-3
*EEA_33-45-4	Volatile halogenated hydrocarbons (VHH)	
*EEA_33-46-5	Volatile organic halogens (VOX)	
*EEA_3121-01-5	Water temperature	
*CAS_1330-20-7	Xylene	1330-20-7
*CAS_7440-66-6	Zinc and its compounds	7440-66-6
*CAS_137-30-4	Ziram	137-30-4

* non-mandatory under IMAP Guidance Factsheets

Table 8: DSs & DDs Module PSF1 (Levels of contaminants in seafood) for CI 20: List of species

ID_Species	Label
Alosa spp	125715
Argyrosomus regius	127007
Aristeus antennatus	107083
Auxis rokei	127015
Boops boops	127047
Brevoortia pectinata	275501
Dicentrarchus labrax	126975
Engraulis encrasicolus	126426
Epinephelus spp	126068
Loligo vulgaris	140271
Lophius piscatorius	126555
Merluccius merluccius	126484
Micromesistius poutassou	126439
Mugil cephalus	126983
Mullus barbatus	126985
Mullus spp.	126034
Mullus surmuletus	126986
Mytilus galloprovincialis	140481
Nephrops norvegicus	107254
Octopus vulgaris	140605
Pagellus bogaraveo	127059
Pagellus erythrinus	127060
Pagrus pagrus	127063
Parapenaeus longirostris	107109
Penaeus kerathurus	246388
Ruditapes decussates	231749
Ruditapes philippinarum	231750
Sarda sarda	127021
Sardina pilchardus	126421
Sardinella aurita	126422
Sardinella spp	125721
Scomber japonicus	127022
Scomber scombrus	127023
Scomber spp	126063
Scomberesox saurus	126392
Sepia officinalis	141444
Sparus aurata	151523
Sphyraena spp	126084
Spicara spp	125949
Squilla mantis	136137
Thunnus thynnus	127029
Trachurus mediterraneus	126820
Trachurus spp	125946
Trachurus trachurus	126822
Xiphias gladius	127094

Table 9: DSs & DDs Module PSF1 (Levels of contaminants in seafood) for CI 20: List of GSA

Value	Description
1	Northern Alboran Sea
2	Alboran Island
3	Southern Alboran Sea
4	Algeria
5	Balearic Islands
6	Northern Spain
7	Gulf of Lion
8	Corsica
9	Ligurian Sea and Northern Tyrrhenian Sea
10	Southern and Central Tyrrhenian Sea
11.1	Western Sardinia
11.2	Eastern Sardinia
12	Northern Tunisia
13	Gulf of Hammamet
14	Gulf of Gabes
15	Malta
16	Southern Sicily
17	Northern Adriatic Sea
18	Southern Adriatic Sea
19	Western Ionian Sea
20	Eastern Ionian Sea
21	Southern Ionian Sea
22	Aegean Sea
23	Crete
24	Northern Levant Sea
25	Cyprus
26	Southern Levant Sea
27	Eastern Levant Sea
28	Marmara Sea
29	Black Sea
30	Azov Sea

References

UNEP/MAP, 2019. UNEP/MED WG.467/5. IMAP Guidance Factsheets: Update for Common Indicators 13, 14, 17, 18, 20 and 21: New proposal for candidate indicators 26 and 27.

UNEP/MAP, 2019a. UNEP/MED WG.463/6. Monitoring Protocols for IMAP Common Indicators related to pollution.

UNEP/MAP, 2019b. UNEP/MED WG.467/13. Schemes for Quality Assurance and Control of Data related to Pollution.

UNEP/MAP, 2019c. UNEP/MED WG.467/8. Data Standards and Data Dictionaries for Common Indicators related to Pollution and Marine Litter.

UNEP/MAP, 2019d. UNEP/MAP WG. 467/12. MAP Pilot Info System: Quality Assurance and Quality Controls.

Commission Regulation (EC) No 1881/2006, setting maximum levels for certain contaminants in Seafood.

Commission Regulation (EC) No 835/2011 amending Regulation (EC) No 1881/2006 as regards maximum levels for polycyclic aromatic hydrocarbons in foodstuffs.

Commission Regulation (EC) No 1259/2011, amending Regulation (EC) No 1881/2006 as regards maximum levels for dioxins, dioxin-like PCBs and non-dioxin-like PCBs in foodstuffs.

Appendix 29
Monitoring Guidelines/Protocols for Floating Microplastics

1. Introduction

1. The basic elements, describing sampling methodology for floating microplastics as well as laboratory techniques and analysis for identification, characterization and quantification, are reported below aiming to provide technical guidance and to facilitate the Contracting Parties to evaluate the abundance and composition of microplastic, found in sea surface waters around the Mediterranean. The present guidelines are referred to and are tackling only microplastics, and not micro-litter at large, which is in-line with the definition of IMAP-Common Indicator 23 “*Trends in the amount of litter in the water column including microplastics and on the seafloor (EO10)*”. The present chapter has been based on a number of guidance documents for monitoring floating microplastics.⁵³⁷

2. Definition of Microplastics: Microplastics includes all sorts of small particles of plastic (man-made artificial polymers) with a diameter smaller than 5 mm and that pass through a 5 mm mesh screen but are retained by a lower mesh size, according to the chosen size class⁵³⁸ (i.e. 330 µm - 5 mm). Microplastics can be found dispersed in the marine and coastal environment as a consequence of plastic pollution.

3. Microplastics are present in a variety of products, ranging from cosmetics to synthetic clothing to fragmentation of larger products such as plastic bags and bottles into smaller items. Consequently, microplastics are divided into two types according to their origin: primary and secondary. Examples of primary microplastics include microbeads found in personal care products, plastic pellets used in industrial manufacturing, and plastic fibres used in synthetic textiles (e.g. polyester, acrylic, nylon). Primary microplastics enter the environment directly through any of various channels, for example personal care products being washed into wastewater systems from households, unintentional loss from spills during manufacturing or transport, or abrasion during washing (e.g., laundering of clothing made with synthetic textiles). On the other hand, secondary microplastics originate from the breakdown of larger plastics; this typically happens when larger plastics in the marine environment

⁵³⁷ Galgani F., G. Hanke, S. Werner, et al. (2013) Guidance on Monitoring of Marine Litter in European Seas. EU/JRC editor, EUR 26113, 123 pages, doi:10.2788/99475 (pdf).

Zampoukas N., Palialexis A., Duffek A., et al. (2014) Technical guidance on monitoring for the Marine Strategy Framework Directive. EUR – Scientific and Technical Research series – ISSN 1831-9424, 166 pages, doi: 10.2788/70344.

Ryan, PG, 2013. A simple technique for counting the sea steep gradients between the Straits of Malacca and the Bay of Bengal. *Marine Pollution Bulletin* 69 (1), 128-136.

UNEP, 2015. Marine Litter Assessment in the Mediterranean. UNEP / MAP Athens, 45 pp.

UNEP / MAP MEDPOL, 2011. Results of the Assessment of the Status of Marine Litter in the Mediterranean Sea, (UNEP / MAP (DEPI) / MED WG.357 / Inf.4).

GESAMP (2019). Guidelines on the monitoring and assessment of plastic litter and microplastics in the ocean (Kershaw P.J., Turra A. and Galgani F. editors), (IMO/FAO/UNESCO-IOC/UNIDO/WMO/IAEA/UN/UNEP/UNDP/ISA Joint Group of Experts on the Scientific Aspects of Marine Environmental Protection). Rep. Stud. GESAMP No. 99, 130p.

⁵³⁸ Galgani F., Giorgetti A., Vinci, M., Le Moigne M., Moncoiffe, G., Brosich, A., Molina, E., Lipizer, M., Holdsworth, N., Schlitzer, R. Hanke, G., Schaap, D., 2019. Proposal for gathering and managing data sets on marine micro-litter on a European scale, 07/06/2019, 34 pp., DOI: 10.6092/8ce4e8b7-f42c-4683-9ece-c32559606dbd.

GESAMP, 2016. “Sources, fate, and effects of microplastics in the marine environment: part two of a global assessment” (Kershaw, P. J., and Rochman, C. M., eds). (IMO/FAO/UNESCO-IOC/UNIDO/WMO/IAEA/UN/UNEP/UNDP Joint Group of Experts on the Scientific Aspects of Marine Environmental Protection). Rep.Stud. GESAMP No. 93, 220 p.

undergo weathering, through exposure to wave action, wind abrasion, and ultraviolet radiation from sunlight, amongst others.

4. Due to their small size, lightweight properties and diversity in density, microplastics may be found on the sea surface, or even deeper the entire. Microplastics can also sink to seafloor bottom due to their specific density, fouling by organisms or weathering. Monitoring of microplastics in sediment are not considered in this document.

2. Sampling of Microplastics at Sea

5. When focusing on sampling floating microplastic, it is advisable to conduct the sampling in calm sea conditions, preferably when the wind intensity is less than three (3) Beaufort (approximately 13 - 19 km/h).

2.1 Manta Net Properties

6. The Manta Net or Manta Trawl is the most commonly used sampling equipment. This tool is specifically designed to collect samples from the surface layer of the sea. The use of Manta Net allows the sampling of large volumes of water, retaining at the same time the target material (i.e. microplastics). High Speed Manta Net is also used but given that its use is not so common it is not taken into consideration in this document.

7. Mouth size and length: The Manta Net (Figure 1) consists of a rectangular metal floating device from which a net cone is attached, having a final collection sock (or any other relevant collection equipment) at its very end where the microplastics and the organic matter are collected. The dimensions of the mouth of the metal device are not pre-determined, it is however advisable to always maintain a ratio equal to $\frac{1}{2}$ between the height and the width of the mouth of the metal device. The most common dimensions of the mouth of the Manta Net are 50 cm in width and 25 cm in height, however other dimension are possible. This dimensions refer to the inside size of the mouth, the part to which the 2.5 m net in length is connected. The outer part is wider assuming an overall truncated pyramid shape.

8. Mesh of the net and cup/sock: The net cone, which is attached to the floating metal device, should be made out of a net with a mesh size of approximately 330 μm . In order to avoid problems of regurgitation following clogging, especially in eutrophic waters, it is necessary to constantly check the effectiveness of sampling. Optional, for areas with high gelatinous organisms and zooplankton, a metal net (mesh 1-2 cm) could be added in front of the mouth of the manta net.

9. Dimensions of the wings: Two metal wings are attached right and left from the metal device to ensure that the Manta Net is always kept floating on the sea surface (Figure 1). The dimensions of the wings depend on the weight of the mouth, since they are used to ensure the buoyancy of the instrument. Therefore, it depends on the weight of the metal floating device. In most cases, each wing has the same dimension in length as the metal mouth. A size of 40–70 cm in length is generally expected, In any case, they should be sufficiently large to keep the Manta Net afloat.

2.2 Use of Manta Net

10. The Manta Net is lowered slowly from the boat or the vessel to the sea and is left afloat. According to the dimension of the boat it is possible to tow the net from stern or from the side. If the net is lowered to stern, the distance between the boat and the Manta Net should be at least 50-70 m. If

the net is lowered on the side, of the boat the net should be kept at the distance of around 3 m. When possible, it is suggested to use non plastic material rope in order to avoid contamination. The pull of the manta net from the side of the vessel or the zodiac may be another option (Figures 2 and 3). It is extremely important for the manta net to be left outside of the bow wave caused by the spinning of the propeller because this turbulence will significantly influence the amount of collected microplastics as well as the contamination due to paint chips from the vessel (Figure 1).



Figure 1: Manta net being operated in calm sea, outside of the bow wave caused by the spinning of the propeller (Photo: © Christos Ioakeimidis, UNEP/MAP).

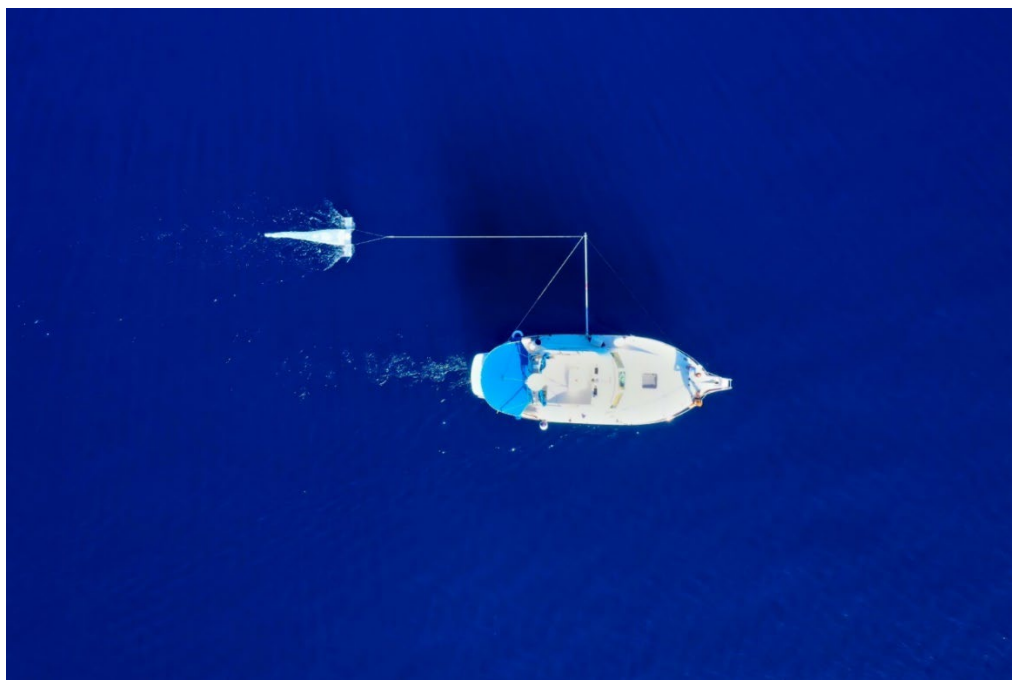

Figure 2: A manta net being pulled from the side of the vessel (Credit © Stipe Muslim, Croatia)



Figure 3: A manta net being pulled from the side of the vessel (Credit © Cecilia Silvestri & Marco Matiddi, Italy)

2.3 Designing a Monitoring Campaign

11. Method for sampling: A proper design of the monitoring surveys should include at least coastal and offshore sampling. For coastal surveys, sampling should be carried out at 3 stations located at different distances from the coastline (e.g. 0.5, 1.5, 3 Naut. Miles) set along an orthogonal line to the coast. For offshore surveys, the samples should be carried out at 3 stations located at 6, 12 and 24 Naut. Miles following the trajectories of the coastal ones. Once the boat/vessel is positioned at the sampling point, the manta net is lowered and trawled for approximately 20 minutes or more (according to the Manta Net clogging) along a straight transects, with a speed approximately of 1-2 knots. In order to allow the Manta Net to properly filter the water and thus have its whole mouth submerged into the sea, under no circumstances the speed should exceed 3 knots. The 20-minute trawl must be conducted in the opposite direction to the surface current or in any case opposite to the wind direction.

12. *Optional:* In case of large quantities of organic matter, mucilage and gelatinous zooplankton are present during the sampling, it is suggested to split the sampling time into two 10 minutes hauls. Both samples will be merged to have an equivalent to one 20-minutes trawl.

13. GPS Coordinates: For each trawl the GPS coordinates (grades and thousandths, GG°, GGGGG) at the beginning and end of sampling must be recorded in WGS 84 UTM 32. Additional GPS coordinates (e.g. every 10 minutes) are most welcomed as will allows us to confirm, or not, the rectilinear transect and even to determine a more accurate length of the trawl. In case of large quantities of organic matter and relevant organic gel are present during the sampling, it is suggested to decrease the sampling time into two 10-15 minutes hauls.

14. Wind direction and intensity should be recorded along with sea condition.

15. Position of the survey stations: The position of the stations for coastal monitoring must be determined according to the characteristics of the survey area (i.e. upwelling and downwelling areas,

storage areas for local hydrodynamic conditions, distance from direct input sources, such as river mouths, distance from port facilities or relevant urban settlements etc.). The position of the stations for offshore sampling must be complementary to those of the coastal ones, along the trajectories of the coastal stations at 6;12 and 24 miles and/or fall within the accumulation areas envisaged by the predictive models. The number and position of the survey stations will be established in order to have a better representation of the entire region, considering areas of both high and minimum anthropogenic activity/impact. The criteria for choosing the position of the transects must be recorded on dedicated sampling sheets.

16. **Replicates:** Because of the variability of floating microparticles distribution, it is necessary to increase the data representativity. Further, it is strongly recommended to carry out replicates from the same sampling point. Three replicates for each station are recommended. Each replicates must be conducted following the transect in the opposite direction to the surface current or in any case opposite to the wind direction, approximately parallel to the first one. Using twin manta nets in order to collect duplicate samples in one time is suggested (less time consuming).

2.4 Calculating the Surveyed Areas

17. **The surface area of the surveyed water:** The calculation of the amount of microplastics should be expressed in number of microplastic particles per square meter based on the following methodological approach:

The surface areas of surveyed water (S) is calculated using the following formula:

$$S = D \times W$$

Where: D: is the distance of the sampled rectilinear transect

W: is the width of the mouth of the Manta Net

* It is possible to calculate D by using a flowmeter, or GPS coordinates, or vessel instruments

18. **Optional:** It is also possible to calculate the filtered volume (m³) by: (i) multiplying the area of the mouth of the net by the distance covered during the tow; or (ii) applying the appropriate formula of the flowmeter as follow:

$$(i) V = D \times A$$

$$(ii) V = N \times A \times c$$

D: is the distance of the sampled transect (m)

N: is the number of turns of the propeller recorded by the flow meter during the transect;

A: is the area of the mouth of the used Manta net;(width x height)

c: is a constant value, typical of each flowmeter.

It should be considered that the filtered volume using a flowmeter is more accurate, but the flowmeter needs a continuous maintenance, and it can stuck during sampling. For this reason, the square meter measure must be always calculated.

2.5 Sample Collection and Storage

19. Once brought back to the boat or the vessel, the net must be rinsed each time, with sea water from the outside to the inside, from its part close to the mouth towards the collection sock, in order to concentrate all the natural and man-made materials to the cod-end. The collection sock is removed, and the material is transferred into a 250 or 500 ml glass bottles for subsequent qualitative and quantitative analysis (Figure 3). The sock/cup should be washed, from the outside, using distilled water or sea water, and from inside using only distilled water, in order to collect all the material stacked among the mesh. Larger pieces of biological material, including e.g. leaves, bugs, larger algae or wood are picked out of the samples with metal tweezers and carefully rinsed on a metal sieve (< 330 µm). Macro-plastics are picked out and rinsed in the same way, but instead of discarding them, they could be counted and stored for further analysis. It is important to separate macro-plastic from the sample in order to avoid fragmentation.



Figure 3: Microplastic and organic matter collected in a metal sieve just after the sampling (Photo: © Christos Ioakeimidis, UNEP/MAP).

20. The samples can then be stored in refrigerators (but not in freezers), protected from light and heat. It is possible to add a fixative (i.e. 70% ethyl alcohol), solely in order to prevent the decomposition of the organic matter present (e.g. zooplankton, phytoplankton, etc.), which would release unpleasant odors during the analysis of the samples. This procedure it is not suggested because it can change the microplastic colour.

3. Laboratory Analyses of Samples Collected at Sea:

21. The analysis is aimed at identifying and quantifying the different microplastic particle (as non-degradable) found present in the sample/s.

3.1 Cross Contamination

22. All laboratory equipment should be ensured to be made of glass or metal as much as possible in order to prevent the contamination of the sample, with microplastic particles deriving from the potential plastic equipment, as well as to avoid microplastic fragments from sticking to the walls of the equipment. To avoid this carefully rinsing of the equipment with distilled water should be ensured. The use of distilled water during all the wash/rinsing steps should be ensured. during all laboratory steps. Furthermore, particular attention must be paid to the cleaning of the working area in order to avoid contamination of the sample with microplastic particles, mainly fibers, being present in the atmosphere or being generated from relevant plastic equipment. To this extent, important precautions should be taken to limit the risk of contamination such as:

- Avoid wearing synthetic clothes which could release plastic fibres (such as fleece or stretch fabrics in lycra - polyamide) during the laboratory analyses and wear pure cotton clothes. Always wear a 100% cotton lab coat.
- Avoid the exposure of the sample into the atmospheric air, and thus ensuring to cover the corresponding laboratory spaces to avoid contamination.
- Do not leave windows open while analysing the samples.
- Reduce personnel in the lab during operation.
- Use of laminar flow cabinet is recommended.
- Cover the petri dish during the first stereomicroscopic analysis with a glass.
- Place a damp filter paper in a petri dish in the working area for a blank control in every step representing the whole process of treatment.

3.2 Equipment at the Laboratory

23. The following equipment will be required during the laboratory analysis:

Requirement:

- 5 mm metal sieve;
- 300 µm metal sieve;
- Drying oven;
- Filtration device;
- Petri dishes (glass);
- Jars/Beakers (glass);
- Tweezers;
- Distilled water;
- Micrometre;
- Stereoscope.

Optional:

- *Micrometer;*
- *Additional sieves for size classes;*
- *Oxygen Peroxide or Potassium hydroxide;*
- *Drying oven or hot plat or hot bath;*
- *Laminar flow cabinet;*
- *Vacuum pump system and fiber glasses membrane;*
- *Hot needle, optical microscope, FT-IR or RAMAN spectroscopy.*

3.3 Five Steps at the Laboratory

24. The following **five steps** should be followed during the analysis of the samples:

25. Step 1: Wet Sieving:

- Pour the sample through a stacked arrangement of 5mm and 330 µm metal mesh sieves.

- *Optional: in order to subdivide the items in different size classes it is possible to stack additional sieves (e.g. 1 mm).*
- Pinse the container where the samples are stored several times with distilled water, in order to recover all the microplastics.
- The fraction consisting of plant or animal residues larger than 5 mm (retained by the sieve with the larger mesh) must be thoroughly rinsed with distilled water.
- *Optional: In the presence of large quantities of organic matter, incubate samples on hot plate, hot bath or oven ($\leq 40^{\circ}\text{C}$) adding supplementary 15% H_2O_2 or KOH 10% to the sample while evaporate, until all organic matter is digested. Be careful not to exceed 40°C degree.*
- For the digestion process, the jars with the collected samples should be kept at room temperature for 5 days or less according to the digestion rate. Jars should be covered with aluminum foil or glass dish during the digestion processes.
- *Optional: The digested matter can be filtered on GF/C fiber glasses membrane under vacuum pump, rinse the funnel several time and the membrane with distilled water to remove the organic matter.*

26. Step 2: Transfer Sieved Solid Material:

- Once the sample is filtered, transfer all solids collected in the $330\ \mu\text{m}$ sieves into a Petri dish with the help of a spatula and minimum rinsing with a squirt bottle containing distilled water.
- Ensure all solids are transferred into the glass jars.

27. Step 3: Visual Sorting of Samples:

- Place the Petri dish under the stereomicroscope and proceed with the identification of microplastics. For this, plastic items are counted through visual sorting of the sample and it is recommended to move the Petri dish top-down from the left to the right and vice versa, to facilitate the particle count, perform two rounds of visual sorting under the stereomicroscope
- Filaments with a length $> 5\text{mm}$ must still be counted.
- In case of suspected micro-items, hot needle or optical microscope or spectroscopy equipment should be used to detect if it is plastic material.
- *Optional: For size categorization and in order to subdivide the collected items in different size classes put a sheet of graph paper under the Petri dish, this procedure can also be performed with a micrometre inserted in the eyepiece or with an image analysis software (i.e. Image J) which helps in the measurement of identified microplastics.*
- During the entire visual sorting of samples, a blank control will be done for this, an uncovered Petri dish with a filter inside it will be left beside the stereomicroscope and will be inspected for potential airborne contamination after each sample. Colour and shape of identified particles in the blanks will be recorded. If the blank is contaminated, micro-litter items with similar characteristics (e.g. shape, color, polymer type), the amount of this micro-items should be excluded from the results of the same bath.

28. Step 4: Categorization and Classification:

- The identified microplastic particles should be categorized and classified.
- The microplastic particles which are identified in the glass Petri dish should be divided and counted based on the shape (i.e., fiber, filament, film/sheet, fragment granule, pellet, foam) and colour (Figure 4).
- Types of shapes used in microplastics characterization:

- Fiber: only from textile. They are very flexible with different thicknesses and colours. They can be made by natural or synthetic material.
- Filament: filiform element elongated, threadlike, thin and less flexible than a fiber, made by artificial polymer (e.g. fishing line).
- Film/sheet: broken soft plastic piece as foil, they are thinner and more flexible; than fragments (e.g. pieces of plastic bags).
- Fragment: broken and hard plastic piece, thick, with an irregular shape.
- Granule: spherical shape, with a regular round shape bead .
- Pellet: only from industrial origin, irregular, round shapes, and normally bigger in size, than granule.
- Foam: soft consistency irregular or spheroid shape (e.g. polystyrene, rubber silicone).



Figure 4: Common shapes of microplastics. (1: fibers, 2-3: filaments, 4-7: films, 8-11: fragments, 12-14: foams, 15: pellet, 16-17: granule) (Photo: © Ülgen Aytan, Turkey).

29. Attention should be given in distinguishing Fibres (from textile) and Filament (threadlike artificial polymer: i.e. fishing line), as the first one should pass through a 330 µm mesh and are more susceptible to originate from airborne contamination.

30. Figure 4 highlights the differences between Fibres and Filament, while fibers are generally thinner in diameter, with frayed edges and it is often ending in helical winding. In addition, the fibers, when approached with a needle bend and deform (Fig. 5, 1 red fiber and 2 blue fibers).

31. On the other side, filaments have generally a well-defined shape: cylindroid with clear margins, and the colour is more uniform. Furthermore, the filaments are stiffer than the fibers and less deformable (Fig. 5: 2 filaments in blue).

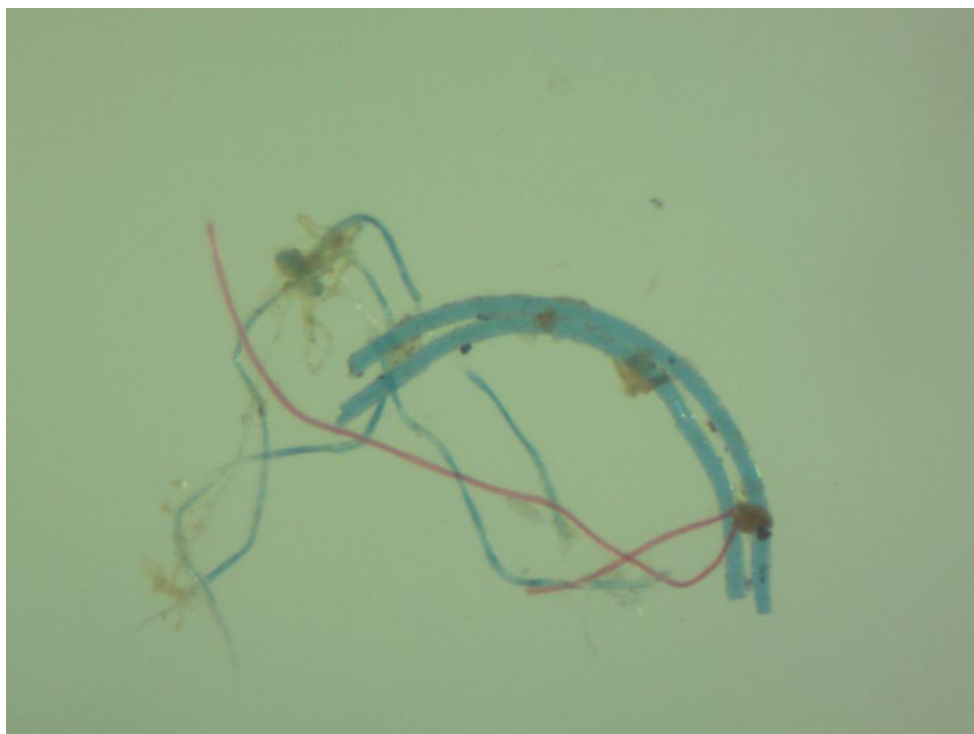

Figure 5: Differences between fiber and filament microplastics (Photo: © Marco Matiddi, Italy).

32. The colour of each microplastic particle should be recorded based on the following approach: white, black, red, blue, green, and other colour (Figures 6 and 7). In case of biofouling or degradation, yellow must be included in the white category and brown in the black category, whereas, orange and pink in the red category. The "*other colour*" category includes all the remaining colours which cannot be specified, or in case an item has different colour on two sides. Furthermore, when a fragment is made up of two different colours depending on the side this has to be always included in the "*other colour*" category. A more specific differentiation is possible when it has relevance for a specific purpose (e.g. project etc.)

33. Finally, for each colour identified, the transparency must be specified, with the proceeding column of the data file indicating if the pieces are opaque or transparent.

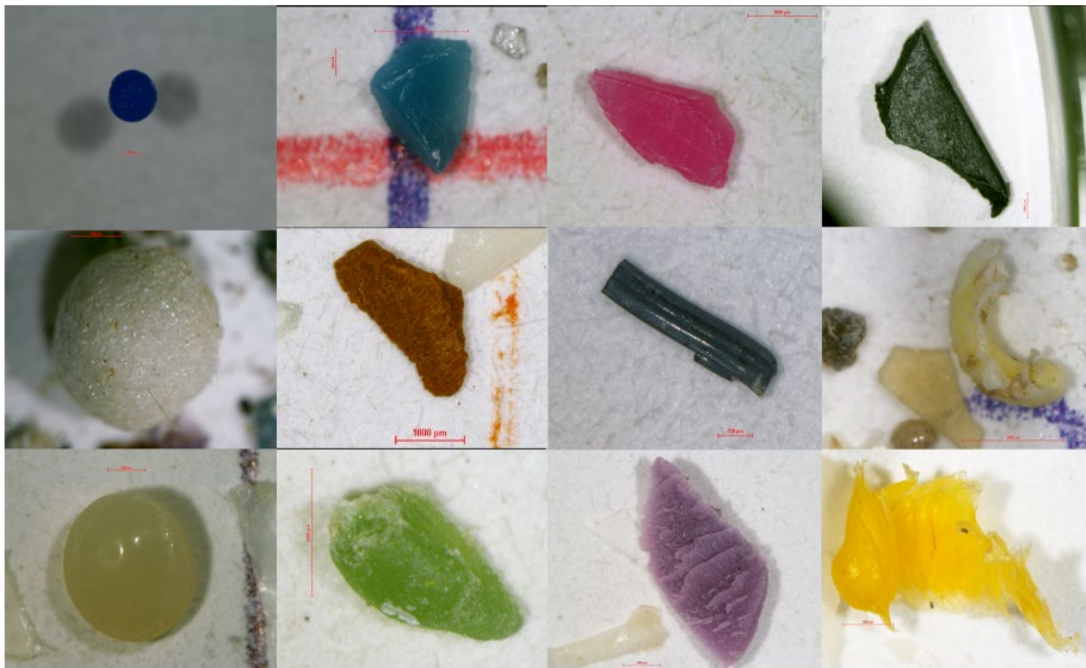

Figure 6: Different colors of microplastics (Photo: © Ofrat Raveh, Israel)

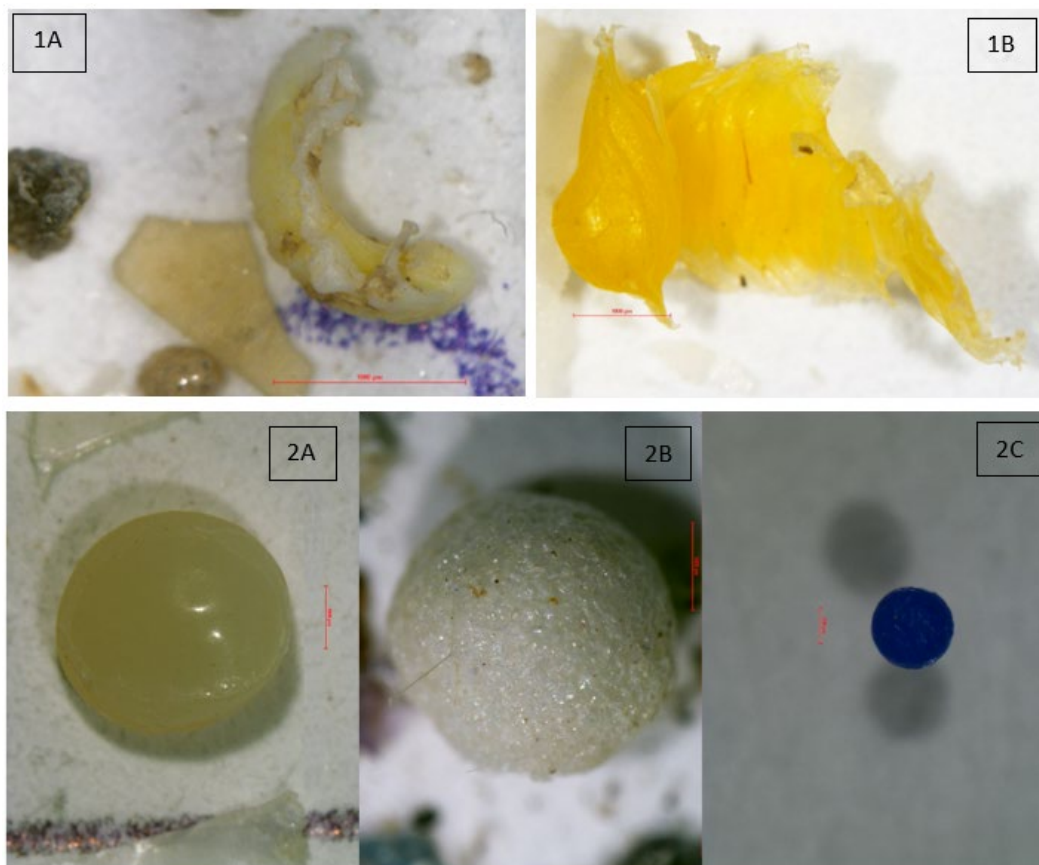

Figure 7: Examples of color categorization for microplastics: [1A] a colored microplastic degraded because of biofouling that should be regarded as “white”; [1B] a yellow-colored microplastic which should be considered as “other color”]; [2A] a pellet which should be considered as “white” (scale bar 1000µm); [2B] A white-colored foam (scale bar 1000µm); [2C] a colored blue granular (scale bar 250µm). (Photo: © Ofrat Raveh and Yael Segal Israel)

34. Step 5.Reporting units

The reporting units for microplastics abundance from water samples are:

Option 1: Number of Microplastics per Surveyed Area

(No, Particles / km² | No, Particles/ m²)

Option 2: Number of Microplastics per Volume

(No, Particles / m³)

35. The first one is mandatory as required by the IMAP Common indicator 23 and the Criteria D10C2 of the MSFD. The second one is optional.

36. Information referring to shape and colour of microplastics identified, are useful for source identification.

4. Keynotes

37. Spectral optical procedures such as FT-IR or Raman spectroscopy are very important techniques to differentiated microplastics from non-plastic materials and further verifying plastic polymers which is also necessary for obtaining useful information regarding sources of sea surface plastics. These instruments can perform counting, shape measurement and material identification simultaneously but they are expensive so not all laboratories can afford them. For laboratories that have the possibility to use them, in the case that time and resources do not allow analysis of all samples, the recommendation is to proceed with a representative spectroscopic analysis for a subsample of 10% of the total, choosing the suspected microparticles to verify visual identification.

38. A list of additional physical and chemical parameters of the water column are recommended (non-mandatory) by means of a multiparametric, integrated sampling, which are hereunder listed:

- Depth (m);
- Temperature (°C);
- Salinity (psu);
- Oxygen (dissolved oxygen – percentage of saturation);
- pH; and
- Transparency (m).

Appendix 30

**Guideline on estimation techniques and applied methodologies for non-point source releases
from agriculture**

1. Introduction

1. Following the 21st Meeting of the Contracting Parties to the Barcelona Convention COP21 (held in Napoli, Italy, 2-5 December 2019)¹ and the adoption of Decision IG.24/14,² the Programme of Work mandated MED POL Programme to develop/update technical guidelines addressing estimation techniques of pollutant releases from non-point (diffuse) sources (agriculture, catchments runoff) as well as from aquaculture (point source).

2. To achieve this mandate, this guidance document was developed. It elaborates on techniques and applied methodologies for estimating non-point (diffuse) source emissions to air and releases to water and land from activities classified under the **agricultural sector** including, but not limited to, releases of pollutants listed in Annex I to the LBS Protocol.

3. The scope of this guidance document covers the following:
 - a. Characteristics of non-point sources emissions to air and releases to water and land from farming of animals as NBB/PRTR sector of activity; and
 - b. Release estimation methods and techniques for non-point sources including pollutants, overview of approaches for emission estimations for non-point sources releases; their accuracy and uncertainties as well as quality control/quality assurance (QC/QA).
4. The non-point (diffuse) sources addressed in this guidance document include:
 - a. Farming animals, especially those generated by enteric fermentation, manure management, feed management (silage leachate) and field burning of agricultural waste (dead animals); and
 - b. Agriculture Crop Production Sectors pertinent to NBB sector of activities and as well as, where applicable for PRTRs including use of fertilizers, use of pesticides, manure application and field burning of agricultural waste (i.e., biomass including crops, dead or damaged trees and other plant material) for the Mediterranean region.

5. Bearing in mind that estimation methodologies for non-point sources of pollutions are quite complex and usually depend on processes and pathways where the scientific information is scarce, the methodology to develop this document consisted of an extensive literature review conducted systematically in a stepwise approach with a focus on the following topics summarized below:

- a. Available information on characteristics of emissions and releases/discharges of pollutants from agricultural non-point sources to air, water and land from agriculture generated by the processes of enteric fermentation, manure and feed management, field burning of agricultural waste (livestock mortalities and biomass) and use of fertilizers and pesticides;
- b. Available information on different approaches, methods and techniques recommended for use in current inventories and technical reports to estimate emissions for non-point (diffuse) sources to air and releases/discharges to water and land;
- c. Peer reviewed research papers describing methodologies and techniques proposed to estimate emissions and releases from the above non-point (diffuse) sources; as well as

¹ <https://www.unenvironment.org/unepmap/events/meeting/21st-meeting-contracting-parties-convention-protection-marine-environment-and>

² https://wedocs.unep.org/bitstream/handle/20.500.11822/31712/19ig24_22_2414_eng.pdf

- d. Potential issues and drawbacks regarding accuracy and uncertainty associated with the proposed estimation methods, techniques and approaches.

6. The guidelines will complement the NBB/PRTR Methodology for reporting of non-point sources of pollution under NBB/PRTR data calls as well as will serve to facilitate the monitoring of implementation of the Regional Plans for Agriculture and Aquaculture (to be developed in the biennium 2022-2023). It is expected that the newly proposed techniques for estimation of pollution loads to air, water and land will enable the generation of compatible data to evaluate the effectiveness of adopted measures in the National Action Plans and the Regional Plans for Agriculture and Aquaculture.

7. Finally, this document presents to the Contracting Parties to Barcelona Convention an extensive bibliography and supplemental information containing recommendations for further sources of information and peer reviewed research papers which investigated emissions and releases in Mediterranean region (Annex I, Appendices A to E).

2. Legal basis of the NBB guidance document

8. The Protocol for the Protection of the Mediterranean Sea against Pollution from Land-Based Sources and Activities (the LBS Protocol) is one of the six Barcelona Convention Protocols. It was adopted on 17th May 1980 by the Conference of Plenipotentiaries of the Coastal States of the Mediterranean Region and entered into force on 17th June 1983.³ This original Protocol was modified by amendments adopted on 7th March 1996 (UNEP(OCA)/MED IG.7/4)⁴ and recorded as the “Protocol for the Protection of the Mediterranean Sea against Pollution from Land-Based Sources and Activities”. It entered into force on 18th May 2006.⁵

9. The LBS Protocol requires the Contracting Parties to submit reports which shall include inter alia: (i) data resulting from monitoring and (ii) quantities of pollutants discharged from their territories (Article 13, para 2).⁶ For this purpose, the National Baseline Budget of pollutants (NBB) was agreed by the Contracting Parties as “the monitoring tool” to track progress, on a five-yearly basis, of discharged loads of pollutants reflecting the effectiveness of measures taken to reduce and prevent pollution from LBS.

10. To assist the Countries in this mandate, updated NBB guidelines were developed in 2015 (UNEP(DEPI)/MED WG.404/7 Annex IV, Appendix B, Page 11).⁷ However, these updated NBB guidelines, do not offer means by which pollutants from non-point (diffuse) sources can be estimated. This point was discussed at the Regional Meeting on Reporting of Releases to Marine and Coastal Environment from Land Based Sources and Activities and Related Indicators, which was held in Tirana, Albania on 19-20 March 2019.⁸ During the Meeting it was highlighted that reporting of diffuse sources can be only undertaken based on estimation techniques and emission factors which may vary on national and regional levels of each country. Therefore, the recommendation was made to support the Contracting Parties to complement the National Baseline Budget/Pollution Release and Transfer Registers (NBB/PRTRs) methodology with estimation techniques for diffuse sources related to agriculture and as well as aquaculture (UNEP/MED WG.462/8).

3. Characteristics of non-point (diffuse) sources and pollutants from agriculture

³ <https://www.informe.org/en/treaties/land-based-sources-protocol>

⁴ <https://wedocs.unep.org/handle/20.500.11822/3016>

⁵ https://wedocs.unep.org/bitstream/handle/20.500.11822/7096/Consolidated_LBS96_ENG.pdf?sequence=5&isAllowed=y

⁶ https://wedocs.unep.org/bitstream/handle/20.500.11822/3016/96ig7_4_lbsprotocol_eng.pdf?sequence=1&isAllowed=y

⁷ https://wedocs.unep.org/bitstream/handle/20.500.11822/5481/1/15wg417_inf6_eng.pdf

⁸ file:///C:/Users/aleks/AppData/Local/Temp/19wg462_08_Meeting%20Report.pdf

11. A detailed information regarding the substances that need to be reduced and eliminated from the land-based pollution sources are identified and listed in the LBS Protocol, Article 5, Annex I⁹. The MEDPOL PRTR Implementation Guide (UNEP/MED WG.473/12)¹⁰ provides a list of sectors of activities (Annex I) and List of Pollutants (Annex II) which are mandatory for NBB reporting.

12. Pollutants discharges are dispersed from numerous sources which are broadly classified as:
- Point (end of a pipe) pollution discharges and
 - Non-point (diffuse) pollution sources

13. Both point and non-point discharges may originate from a variety of sources, including: municipal wastewater treatment facilities (largely sewage consisting of human wastes), onsite residential septic systems (containing human wastes, detergents, other organic wastes from food households; septic systems drainage (leachate) fields), industrial (chemical, organic, and thermal wastes), urban and suburban runoff from parking lots, commercial buildings and houses (roofs and gardens), construction sites, golf-courses and roads, and agricultural [2-4].

14. Agricultural non-point (diffuse) pollution sources include surface and subsurface runoff from livestock operations (animal wastes, animal production areas such as barnyards, feedlots and composting piles) and cropping systems (pesticides and fertilizers applications), their field level interactions (both temporal and spatial) and climate (storm frequency and hydrology, temperature) [2-7]. Therefore, estimating pollution loadings and controlling this type of contamination is very complex and requires integration of scientific, technological and socio-economic factors [3-4].

15. The major types of non-point (diffuse) source emissions from agriculture-related activities include use of pesticides, herbicides, and fungicides; excess manure production; burning of waste biomass; and combustion emissions from use of tractors, harvesters and other motorized equipment, and heating of greenhouses [5]. The main criteria air pollutants comprise carbon monoxide (CO), Ozone (O₃), particles, nitrogen dioxide (NO₂), sulphur dioxide (SO₂) [1][6]. Types of pollutants commonly included in inventories on discharges to water include nutrients (total N and total P); other inorganic pollutants (e.g., metals); organic pollutants (e.g., POPs); suspended particles; and indicators such as BOD, COD, TOC, salinity. A full list of PRTRs containing RETs can be found in the OECD's Resource Centre for PRTRs¹¹. Based on OECD Compendiums [1][6] Table 5.1 provides an updated summary of pollutants originating from other non-point (diffuse) sources associated with Farming of Animals and Agriculture NBB Sectors:

Table 2.1: Summary of pollutants originating from agriculture non-point (diffuse) sources

Sources		Process	Pollutants		
Sector	Subsector		air	water	land
Farming of Animals (NBB)	Other from non-point (diffuse) sources	Enteric fermentation	CH ₄ , CO ₂		
		Manure management	CH ₄ , N ₂ O, NH ₃ , NO _x , volatile organic compounds (VOCs)	Nutrients, pathogens, BOD, TC or COD, emerging contaminants (veterinary antibiotics etc.)	Nutrients, pathogens, BOD, TC or COD, emerging contaminants (veterinary antibiotics etc.)
		Silage leachate	volatile organic compounds	BOD, TC or COD, TSS, nutrients, pathogens,	BOD, TC or COD, TSS, nutrients, pathogens,

⁹ [https://eur-lex.europa.eu/legal-content/EN/TXT/?uri=CELEX:21983A0312\(01\)](https://eur-lex.europa.eu/legal-content/EN/TXT/?uri=CELEX:21983A0312(01))

¹⁰ https://wedocs.unep.org/bitstream/handle/20.500.11822/28072/19wg473_12_eng.pdf

¹¹ <http://www.prtr-rc.fi/>

Sources		Process	Pollutants		
Sector	Subsector		air	water	land
			(VOCs), NH ₃ , NO _x , CH ₄ , CO ₂	<i>veterinary antibiotics</i> ⁶	veterinary antibiotics
		Field burning and disposal of livestock mortalities	CO ₂ , CH ₄ , N ₂ O, NH ₃ , NO _x , volatile organic compounds (VOCs)	BOD, TC or COD, TSS	BOD, TC or COD, TSS
Agriculture	Other from crop production non-point (diffuse) sources	Biomass burning	CO ₂ , CH ₄ , N ₂ O, NH ₃ , NO _x , volatile organic compounds (VOCs)	BOD, TC or COD, TSS, nutrients	BOD, TC or COD, TSS, nutrients
		Fertilizer application	Air emissions from the equipment including NH ₃ , NO _x , CO ₂	N, P and potassium (K), sulfur (S), magnesium (Mg), calcium (Ca), zinc (Zn), copper (Cu)	N, P, K, S, Mg, Ca, Zn, Cu
		Pesticide application	Air emissions from the equipment	Various insecticides, herbicides, rodenticides, and fungicides.	Various insecticides, herbicides, rodenticides, and fungicides.
		Manure spreading and land application	Air emissions from the equipment and from the soil	N, P, minerals, emerging contaminants (veterinary antibiotics)	N, P, minerals, emerging contaminants (veterinary antibiotics)

16. Detailed characteristics and emissions from Enteric Fermentation; Manure Management; Silage Leachate; Field burning of agricultural waste (disposal of livestock mortalities); Crop Production including use of fertilizers; use of pesticides; and biomass burning are presented in Annex I of this document.

4. Non-point/diffuse Sources Pollution Inventories

17. Estimation techniques for non-point (diffuse) sources require different types of data and approaches compared to point sources of pollutants. Sources of information may include statistical data on economic activities, demographic data, remote sensing data, emission factors and engineering data, while tools may include geographical information systems (GIS) and computer models (e.g., hydrology/water flow models, transportation models and others). In the case of agriculture, the parameters could include the size and composition of cultivated area, the quantity of pesticide or fertilizer use and the locations where these chemicals are applied. In this manner, one can perform a reasonable estimate of aggregate emissions arising from non-point or diffuse sources of certain pollutants starting from simple, known parameters that are readily measured or obtained for each source type.

18. Overview of approaches for air, water and land inventories for estimating emissions from non-point (diffuse) sources to air from agriculture as well as additional information and references on Non-point/diffuse sources pollution inventories are provided in Annex II.

4.1 Inventories on air emissions

19. The OECD Resource Compendiums of PRTR release estimation techniques [1][6] provide detailed summary of air emission inventories. These inventories have developed over several decades and methodologies for estimating emissions from non-point sources in these inventories are well established. National inventories (such as greenhouse gas inventories) tend to be used to monitor trends and progress towards emissions reduction strategies, to support national or state policy development, and may be used for broad scale modelling [1]. An important characteristic of air emission inventories is that they include extensive underlying data sets [1]. Greenhouse gas (GHG) inventories are closely linked to the requirements of UN Framework Convention on Climate Change (UNFCCC) [7]. Another international convention, the UNECE Convention on Long-Range Transboundary Air Pollution (CLRTAP), the US and Canada, provides information on spatial aggregation of emissions [8]. The convention covers emissions to air of acidifying compounds, particles, metals and persistent organic compounds and involves scientific coordination led by the European Monitoring and Evaluation Programme (EMEP). EMEP collects emission data, measures air and precipitation quality and models atmospheric transport and deposition of air pollutants. These data are used to evaluate the quantity and significance of transboundary fluxes (changes to air pollutant composition and concentrations) and any areas that exceed critical loads and threshold levels [8].

4.3 Inventories on discharges to water

20. Given the magnitude of eutrophication globally [2], the inventories on discharges to water from non-point (diffuse) sources typically involve the estimation of nutrient loads entering inland or marine waters. Nutrients are normally represented by estimates of total nitrogen and phosphorous loads (g or kg/d), calculated by multiplying daily flow (m^3/d) with daily nutrient concentration (g/m^3). As summarized in the OECD Compendium [1], the estimation of pollutant export rates (releases) is often linked with mathematical modelling of pollution impacts on receiving waters using catchment runoff models. Other indicators that are not chemical species are usually included in the model, for example, biological oxygen demand, suspended solids and bacteriological agents. Driven by growing awareness of their impacts and reporting requirements, other pollutants, such as metals and organic chemicals, are becoming addressed. The atmospheric contribution of some of these pollutants, most notably nitrogen, is often included in the catchment modelling. This reflects an important connection between inventories of emissions to air and releases to water [1].

4.4 Inventories on discharges and emissions to land

21. Agriculture non-point (diffuse) sources that can result in emissions to soil include manure management, silage leachate, field burning of animal carcasses, fertilizer use, pesticide use and biomass burning. However, to date, most of the non-point (diffuse) sources inventories are focused on emissions to air or releases to water [1].

22. Disposal or placement of waste that can potentially lead to the contamination of soil are prohibited by law [1][6]. Berlin Ecologic Institute [9] recently provided a comprehensive 462-page update Inventory and Assessment of soil protection policy instruments in EU Member States. The World Inventory of Soil Emission Potentials (WISE) project (1991-2016)^{12, 13} generated a range of world databases of soil property estimates (point and grid-based) to support environmental studies at a global scale including soil vulnerability to pollution, soil carbon stocks and change, and soil gaseous emission potentials.

¹² <https://www.isric.org/explore/wise-databases>

¹³ <https://www.isric.org/projects/world-inventory-soil-emission-potentials-wise>

5 Release Estimation Methods and Techniques for Non-Points (Diffuse)

23. Techniques used to estimate releases from non-point (diffuse) agriculture sources are divided into (i) non-point sources from farming of animals and intensive livestock production and (ii) non-point sources from crop production. These are discussed below:

5.1 Summary of techniques used to estimate releases from non-point (diffuse) sources from farming of animals and intensive livestock production

24. Techniques used to estimate releases from non-point (diffuse) agriculture sources from farming animals and livestock production have been described in several guidance documents [1] [5-6][10]. The IPCC guidelines [10] provide a thorough description of steps to define categories and subcategories of livestock, and choice of methods. They also highlight that collecting data on livestock characterization (livestock species, animal population) should be performed as a good practice to support emissions estimates.

25. In the following sections, techniques for estimation of emissions and releases to air, water and land are presented for:

- a. Emissions from the enteric fermentation to air;
- b. Releases from manure management to air, water and land;
- c. Releases from silage leachate (proposed for the first time, further to an extensive literature performed for that purpose in this document);
- d. Emissions from agricultural burning from disposal of livestock mortalities¹⁴;
- e. Emissions from agricultural biomass burning¹⁴.

5.1.1 Techniques used to estimate methane releases from Enteric Fermentation to Air

26. According to the OECD Compendium [1] the general approach to estimate CH₄ emissions from livestock is to multiply the number of animals by an emissions factor. Thus, the basic formula is:

$$CH_4 \text{ Emissions} = N_T (\text{Number of Animals}) * CH_4 \text{ Emissions Factor} \quad (\text{Equation 5.1})$$

27. Therefore, the three key steps to estimate methane emissions for livestock are to: a) Collect animal population and animal characteristics data; b) Estimate the emissions factor for the animal type; and c) Multiply the emission factor estimate by the population to get the total CH₄ emission estimate for the population. The emissions factors are an estimate of the amount of CH₄ produced (kg) per animal. There are two methods by which to estimate emissions factors:

- a. The Tier 1 method relies on the default emissions factors in the IPCC Guidelines and requires data on the number of animals only [1]. The latest refinement of the IPCC Guidelines [58] suggests that for estimating number of animals for a growing population on the territory, the updated equation should be used:

$$N_T = \text{Days_Alive} * \frac{NAPA}{365} \quad (\text{Equation 5.2})$$

where:

N_T = the number of head of livestock species per category within a given country (equivalent to annual average population); $NAPA$ = number of animals produced annually.

¹⁴ To date, all Inventories used term “field burning of agricultural waste”. We propose separating this process and emissions/releases from agricultural burning from disposal of livestock mortalities (d) and biomass burning (e).

- b. The Tier 2 method involves collecting feed and animal data to calculate the emissions factor. According to [1] using the Tier 2 method, uncertainty in the emissions factors is generally lower because these emissions factors are based on country-specific conditions.

28. Wolf et al [11] updated information for cattle and swine by region, based on reported changes in animal body mass, feed quality and quantity, milk productivity, and management of animals and manure. They used this updated information to calculate new livestock methane emissions factors for enteric fermentation in cattle, and for manure management in cattle and swine.

29. The IPCC Refinement to the 2006 IPCC Guidelines [10] provides a detailed description of methane emissions from enteric fermentation in section 10.3, consisting of three steps:

Step 1: Divide the livestock population into subgroups and characterize each subgroup as described in Section 10.2 of the Guidelines [10].

Step 2: Estimate emission factors for each subgroup as kilograms of CH₄ per animal per year.

Step 3: Multiply the subgroup emission factors by the subgroup populations to estimate subgroup emission, and sum across the subgroups to estimate total emission.

30. They suggest that Tier 3 method should be used by countries for which livestock emissions are particularly important and which may wish to incorporate additional country-specific information in their estimates. Tier 3 approach could employ the development of sophisticated models that consider diet composition in detail, concentration of products arising from ruminant fermentation, seasonal variation in animal population or feed quality and availability, and possible mitigation strategies. Many of these estimates would be derived from direct experimental measurements. However, the guidelines highlighted that it is recommended that Tier 3 method should be subjected to a wide degree of international peer review to ensure that they improve the accuracy and / or precision of estimates.

Comments on reliability

31. The OECD Compendium [1] summarized main points regarding reliability of methods proposed above. They pointed out that because the emission factors for Tier 1 are not based on country-specific data, they may not represent accurately the livestock characteristics for each country. As a result, they may make emissions factors highly uncertain. In the Tier 2, the primary source of uncertainty emissions factors are the livestock characteristics, because these data are dependent on the methods used to collect the data for each country.

32. Sources of further information are provided in Annex III, Appendix A.

5.1.2 Techniques used to estimate emissions and releases from manure management

33. According to the OECD Compendium [1] the process of estimating emissions from manure management involves the following five steps:

Step 1: Determine whether housed livestock in the study region may be an important source of emissions, assuming ammonia and/or greenhouse gases are included in the inventory;

Step 2: Determine the availability of activity data including livestock numbers for different classes of animals, geographic distribution, i.e., location of farms, and other information about waste management practices, feed intake, etc.;

Step 3: Based on available data, resources and inventory objectives, decide on the most suitable methodology;

Step 4: Collect the necessary data and estimate emissions for each animal type then sum for each pollutant;

Step 5: Spatially and temporally disaggregate as required.

5.1.2.1 Emissions to Air

34. IPCC Guidelines 2006 [12] and 2019 Refinement of IPCC Guidelines 2006 [10] provide the most comprehensive description of techniques and methods to estimate emissions to air from manure management.

Methane emissions

35. IPCC Guidelines [12][10] recommended the following four as a good practice for estimating methane emissions from manure:

Step 1: Collect population data from the Livestock Population Characterization as described in IPCC Guidelines, Annex I, Appendix B.

Step 2: Use default values or develop country-specific emission factors for each livestock subcategory in terms of kilograms of methane per animal per year.

Step 3: Multiply the livestock subcategory emission factors by the subcategory populations to estimate subcategory emissions, and sum across the subcategories to estimate total emissions by primary livestock species.

Step 4: Sum emissions from all defined livestock species to determine national emissions.

36. The updated IPCC Guidelines [10] recommend the use of the following equation for CH₄ emissions estimate (Tier 1):

$$\text{where: } CH_{4(mm)} = \left[\sum_{T,S,P} (N_{(T,P)} \cdot VS_{(T,P)} \cdot AWMS_{(T,S,P)} \cdot EF_{T,S,P}) / 1000 \right] \quad (\text{Equation 5.3})$$

CH_{4(mm)} = CH₄ emissions from manure management in the country, kg CH₄ yr⁻¹

N_(T,P) = number of head of livestock species/category T in the country, for productivity system P, when applicable

VS_(T,P) = annual average volatile solids (VS) excretion per head of species/category T, for productivity system P, when applicable in kg VS animal⁻¹ yr⁻¹ (calculated by Equation 5.3),

AWMS_(T,S,P) = fraction of total annual VS for each livestock species/category T that is managed in manure management system S in the country, for productivity system P, when applicable; dimensionless,

EF_(T,S,P) = emission factor for direct CH₄ emissions from manure management system S, by animal

species/category T, in manure management system S, for productivity system P, when applicable g CH₄ kg VS⁻¹

S = manure management system¹⁵

T = species/category of livestock

P = high productivity system or low productivity system for use in advanced Tier 1a – omitted if using a simple Tier 1 approach.

37. Volatile solids (VS) are the organic material in livestock manure and consist of both biodegradable and nonbiodegradable fractions. VS excretion rates can be calculated as:

$$VS_{(T,P)} = \left(VS_{rate(T,P)} \cdot \frac{TAM_{T,P}}{1000} \right) \cdot 365 \quad (\text{Equation 5.4})$$

where:

VS (T, P) = annual VS excretion for livestock category T, for productivity system P (when applicable), kg VS animal⁻¹ yr⁻¹

VS rate (T, P) = default VS excretion rate, for productivity system P (when applicable), kg VS (1000 kg animal mass)⁻¹yr⁻¹

¹⁵ <https://ipcl.org/manure-collection-and-handling-systems/>

TAMT, P = typical animal mass for livestock category T, for productivity system P (when applicable), kg animal⁻¹.

N₂O Emissions from manure management

38. IPCC Guidelines 2006 [12] and 2019 [10] provide a comprehensive description of the principles of N flow, methods to estimate the N₂O produced, directly and indirectly, during the storage and treatment of manure before it is applied to land or otherwise used for feed, fuel, or construction purposes in Chapter 10.5. The approach is based on N excretion, emission factors for N₂O emissions, as well as volatilization and leaching factors. This section also discusses the connection between IPCC N₂O reporting and NH₃ and NO_x reporting required for UNECE countries.

39. The IPCC 2019 [10] provides a thorough description of Tiers 1-3 and five steps for calculating direct N₂O emissions from Manure Management. They recommend the use of the following equation:

$$N_2O_{D(mm)} = \left[\sum_S \left[\sum_{T,P} \left((N_{(T,P)} \cdot Nex_{(T,P)}) \cdot AWMS_{(T,S,P)} \right) + N_{cdg(s)} \right] \cdot EF_{3(S)} \right] \cdot \frac{44}{28} \quad (\text{Equation 5.5})$$

N₂O D(mm) = direct N₂O emissions from Manure Management in the country, kg N₂O yr⁻¹

N (T, P) = number of head of livestock species/category T in the country, for productivity system P, when applicable

N_{ex} (T, P) = annual average N excretion per head of species/category T in the country, for productivity system P, when applicable in kg N animal⁻¹ yr⁻¹

N = annual N input via co-digestate in the country, kg N yr⁻¹, where the system (s) refers exclusively to anaerobic digestion

AWMS (T, S, P) = fraction of total annual N excretion for each livestock species/category T that is managed in manure management system S in the country, dimensionless; to consider productivity class P, if using a Tier 1a approach

EF₃(S) = emission factor for direct N₂O emissions from manure management system S in the country, kg NO-N/kg N in manure management system S

S = manure management system

T = species/category of livestock

P = productivity class, high or low, to be considered if using the Tier 1a approach

44/28 = conversion of N₂O-N(mm) emissions to N₂O(mm) emissions

40. To estimate the indirect N₂O emissions due to volatilization of N in forms of NH₃ and NO_x (N₂O_G (mm)) from manure management, the IPCC Guidelines [10] recommends the following equation:

$$N_2O_{G(mm)} = (N_{\text{volatilization-MMS}} \cdot EF_4) \cdot \frac{44}{28} \quad (\text{Equation 5.6a})$$

where:

N₂O_G(mm) = indirect N₂O emissions due to volatilization of N from Manure Management in the country, kg N₂O yr⁻¹

N_{volatilization-MMS} = amount of manure N that is lost due to volatilization of NH₃ and NO_x, kg N yr⁻¹

EF₄ = emission factor for N₂O emissions from atmospheric deposition of nitrogen on soils and water surfaces, kg N₂O-N (kg NH₃-N + NO_x-N volatilised)⁻¹ (as per Chapter 11, Table 11.3, ref [58])

41. The indirect N₂O emissions due to leaching and runoff from manure management (N₂O_L (mm)) are estimated as following:

$$N_2O_{L(mm)} = (N_{\text{leaching-MMS}} \cdot EF_5) \cdot \frac{44}{28} \quad (\text{Equation 5.6b})$$

where:

$N_2O_{L(mm)}$ = indirect N_2O emissions due to leaching and runoff from manure management in the country, $kg\ N_2O\ yr^{-1}$

$N_{leaching-MMS}$ = amount of manure nitrogen that is lost due to leaching, $kg\ N\ yr^{-1}$

EF_5 = emission factor for N_2O emissions from N leaching and runoff, $kg\ N_2O-N/kg\ N$ leached and runoff (can be found in Annex I, Appendix B, ref [10] Chapter 11, Table 11.3)

42. The choice of emission factors including estimates and calculations of the annual average N excretion rates $N_{ex}(T, P)$ for Tier 2 method, N intake rate for cattle, sheep, goats, swine and poultry, default values for N excretion rates per geographic territory, and other relevant information is discussed in detail in Chapter 10.5.2. of the IPCC Guidelines [10].

5.1.2.2 Release to Water

43. Manure runoff from cropland and pastures or discharging animal feeding operations and concentrated animal feeding operations (CAFOs) often reaches surface and groundwater systems through surface runoff or infiltration, posing a significant threat to water quality. However, current inventories, including the European Inventory of Emissions to Inland Waters [13], the OECD [1][6] and IPCC Guidelines [10] do not propose any methods to estimate pollution loading (nutrients, pathogens, veterinary antibiotics and other emerging contaminants) from this source.

44. There is a large body of the peer reviewed literature which describes agricultural pollution caused by manure runoff [2] [13-22]. The European Inventory of Emissions to Inland Waters [13] suggests that diffuse pollution load is usually calculated by means of coefficients. The coefficients are usually calibrated by means of data from small homogeneous catchments and that further estimates of pollution load can be made using a mass-balance approach on a river basin scale.

45. Malve et al [23] developed an export coefficient model for estimation of diffuse pollution loads in Europe for continental scale modelling. The aim was to provide reasonable estimates across the whole of Europe based on readily accessible datasets, and that would be amenable to application within a gridded model of water quality loadings to surface waters. The export coefficient models for biochemical oxygen demand (BOD), total nitrogen (TN) and total phosphorus (TP) were fitted to data from European Union European Environment Agency databases of 79–106 selected river basins around Europe depending on the variable in question. The analysis showed that estimated export coefficients were on a reasonable level with estimates made by other methods within Europe. Furthermore, it was demonstrated that runoff, number of livestock and point load were common factors for BOD, TP and TN loads with runoff as the most important factor; 2) cropland area also contributed to diffuse TN load; 3) average slope steepness and runoff, as a combined factor, had a negative effect on diffuse TP load and 4) lake area reduced diffuse loads because of retention mechanisms in lakes.

46. According to the US EPA Guide of Pollutant Load Estimation Techniques [14], reliable estimates of the pollutant loads (quantity of pollutants delivered from various sources within a watershed) are essential for development of watershed plans to address the identified water quality problems or issues. They use methods developed by Richards [24] who defined a *pollutant load* as “the mass or weight of pollutant transported in a specified unit of time from pollutant sources to a waterbody”, and the loading rate, or flux, as the instantaneous rate at which the load is passing a point of reference on a river, such as a sampling station, and has units of mass/time such as grams/second or tons/day.

47. The US EPA Guide [14] suggests three basic steps for estimating pollutant load:

- measuring water discharge (m^3s^{-1}),
- measuring pollutant concentration (mgL^{-1}), and
- calculating pollutant loads (multiplying discharge times concentration over the time frame of interest).

48. Since the flux varies with time, it is expressed in integral form, as the product of concentration and flow (Equation 5.7).

$$\text{Load} = k \int_t c(t)q(t)dt \quad (\text{Equation 5.7})$$

where:

k is a constant for converting units

c(t) is the pollutant concentration at time=t, and

q(t) is the water discharge at time=t.

49. Richards [24] pointed out that it is not uncommon for 80 to 90% or more of the annual load to be delivered during the 10% of the time which corresponds with high fluxes. Based on review of evaluative studies of loading approaches, Richards recommended the following approaches: averaging methods (e.g., for monthly or quarterly loads), regression approaches and ratio approaches. Most of the studies showed that ratio approaches performed better than regression and averaging methods [24].

50. The US EPA Guide of National Management Measures to Control Nonpoint Source Pollution from Agriculture [14] provides a detailed description of load estimation models including simple methods, Mid-range models, Detailed models, Field-Scale Loading Models and Integrated Modeling Systems. They also describe planning process associated with the model selection, Model Calibration and Validation, Uncertainty in Modelling Predictions, and the use of Geographic Information Systems (GIS) Technology in Model Applications. The Guide also includes a comprehensive description of water quality monitoring techniques for non-point (diffuse) sources of pollution [25]. It highlights that without current information on water quality conditions and pollutant sources, effects of land-based activities on water quality cannot be assessed, effective management and remediation programs cannot be implemented, and program success cannot be evaluated [25].

51. The National Risk Management Research Laboratory (NRMRL) of the US EPA developed a Risk Management Evaluation (RME) tool to provide information needed to address and plan future research on the environmental impacts of concentrated animal feeding operations (CAFOs). The RME provides a comprehensive description of watershed stressors resulting from CAFO pollution, types of pollutants (e.g., nutrients, pathogens, emerging contaminants), their transport mechanisms to water, air and land and common manure management practices [26]. However, no methods or techniques for estimates of the pollution loading were proposed.

Nutrients

52. USGS [27] estimated Nutrient Inputs from Livestock Manure over 20 years period (1982 to 2001). The estimates were based on county-level livestock population data collected by the Census of Agriculture. The method took into account differences in the life cycles of farm animals (the time from birth to slaughter) during the year, and for nutrient losses in storage, handling, and application of manure. Estimates of nutrient input were made separately for each livestock group. The total mass of nutrients in manure from a livestock group was calculated as the product of the population, the nutrient content of manure, and the number of days in the life cycle.

53. In general, in the USA, nutrient balance assessment on a farm is usually calculated from records of the nutrient-containing materials coming onto the farm (feed, fertilizer, purchased animals) and those leaving the farm in the form of products (milk, meat, eggs, crops, etc.). Balances can be expressed as percentage remaining, lbs/acre remaining or, for dairy farms, as lbs remaining per unit milk produced. Researchers from Cornell University, USA, developed Whole Farm Nutrient Balance Software as a tool for calculating the farm nutrient mass balance. An estimate of the whole farm nutrient balance can also be determined from the density (the number of animal units per surface area) of livestock on the farm [28]. Gross nutrient balances for European countries are computed by Eurostat [29-31].

54. Researchers from the Joint European Research Center developed GREEN-Rgrid, a conceptual statistical regression model to estimate nutrient fluxes into the Mediterranean Sea [32]. The major

benefit of this model is that that links nutrient inputs to water quality measurements. It runs on an annual basis on a grid cell size of 5 min (0.083333 degree, about 10 km at the equator) and can be used to estimate total nitrogen (TN) and phosphorus (TP), nitrate (N-NO₃) and orthophosphate (P-PO₄) from both non-point (diffuse) and point sources. This document contains excellent source of references for nutrient inputs from a variety of diffuse and point sources for the entire Mediterranean Basin.

55. Sources of further information are provided in Annex III, Appendix B.

5.1.2.3 Land

56. Similar to releases to water, current Inventories do not propose methods for estimating pollutants release from manure to land (either via surface runoff infiltration or direct application to land). The reviewed peer reviewed literature and technical reports suggest that pollutants releases (nutrients, pathogens, veterinary antibiotics and other emerging contaminants) can be estimated by determining their content in the manure, the quantities of manure generated on farm and applied to land [33] [34-39]. Rayne and Aula [37] recently provided a comprehensive review of the impacts of livestock manure on soil health. Eghball et al. [38] pointed out that generally, the amount of a nutrient that is mineralized in manure is a function of manure characteristics, environmental factors, soil properties, and microbial activity. Loyon [39] pointed out that manure type (slurry, farmyard manure, dropping) and the quantities generated on farm depend on the housing type and the stage of animal rearing. Manure management in the building (drying belt, scrapping, flushing, storage pit, etc.) also affect the quantities of manure to be handled.

5.1.2.4 Comments on reliability Accuracy and uncertainty in calculations

57. The OECD Compendiums [1][6] point out that regarding emissions to air, the use of a simple methodology involving default emission factors for NH₃ for each class of animal will be less accurate than a country specific approach that takes account of different farming situations. The also highlight the fact that the uncertainty regarding agricultural emissions of N₂O is including emission factors and N excretion is at high levels in general. The available emission factors do not account for the effects of soil type, crops or climate on N₂O formation. The USA EPA [14][25] discusses the importance of model calibration and validation, addressing of uncertainty in modeling approach and field measurement errors.

5.1.3 Techniques used to estimate releases from silage leachate

58. As silage leachate represents the most toxic waste stream on farm, it is very important to estimate pollutants loading rates and releases on water and land. Yet, the literature on this subject is scarce. One of the key reasons is most probably associated with the complexity and costs of equipment and labor for in-situ flow and contaminants monitoring [2][26] [40-44].

59. Based on the literature review in agricultural pollution assessment and control [2] [40-49] we propose the following four steps to estimate releases from silage leachate:

Step 1: Collect relevant data on farm numbers from the Census of Agriculture and Statistics databases for each country^{16,17, 18}; Consult the Directorate-General for Agriculture and Rural Development (DG AGRI) and relevant organizations in the country to estimate number of dairy farms (e.g. feed bunks and other areas containing silage heaps).

¹⁶ https://ec.europa.eu/eurostat/statistics-explained/index.php/Farms_and_farmland_in_the_European_Union_-_statistics

¹⁷ <https://ec.europa.eu/eurostat/web/agriculture/agri-environmental-indicators>

¹⁸ <https://feal-future.org/atlant/en/node/17>

- Step 2: Conduct a comprehensive search of both peer reviewed and gray literature to determine available information on the silage making process in the country (e.g. type of forage, fodder used), nutrient, pathogens, organic matter, veterinary antibiotics (and other emerging contaminants) content of silage and farm practices employed to control runoff from silage.
- Step 3: Estimate the amount of surface runoff generated for your country (using literature review and site assessment if feasible, please see equation 5.8).
For example, in Canada, the government of Ontario developed AgriSuite software which can estimate the amount of silo seepage expected from the bunker silos¹⁹ [49].
- Step 4: Calculate pollutant loading (equation 5.7) to estimate total discharge from a silage/seepage effluent. The same equation can be used for all parameters listed in Table 2.1.
- Step 5: Sum emissions from all defined livestock farms to determine national emissions from this source.

60. Morin [50] provided a good summary of rainfall-runoff relationships. He highlighted that the runoff from a given rainstorm is a function of i) rainfall intensity distribution and sequence, during a particular rainstorm event; ii) soil infiltration rates; and iii) the soil surface storage capacity. He proposed a simple equation to calculate surface runoff of a storm with varying rainfall rates:

$$SR_i = S (p_i + SD_i^{-1} - F_i - SD_m) \quad (\text{Equation 5.8})$$

where:

R_i = surface runoff (mm) for the time segment

SD_i = surface storage detention (mm) for the time segment

SD_m = maximum storage detention (mm)

F_i = the potential infiltration (mm) of any time segment t_i (mm).

61. Ohana-Levi discussed rainfall-runoff relationships in a Semiarid, Eastern Mediterranean Watershed [51]. In the USA, Wright et al. [41] discussed the challenges of collecting the information on the amount of leachate produced. They pointed out that the amount and concentration of the effluent is partially dependent on rainfall and can be variable from season to season and from day to day depending on crop maturity and harvest conditions. Moreover, nutrient and other pollutant concentrations in silage runoff are variable, likely due to the concentration of silage leachate, storm size, season, and bunker conditions. More recently, Bernardes et al. [48] provided a comprehensive review of unique challenges associated with making silage in hot and cold regions.

62. Sources of further information are provided in Annex III, Appendix C.

5.1.4 Techniques used to estimate emissions and releases from field burning and disposal of livestock mortalities

63. As described earlier, within the EU countries, the incineration (either on or off-farm) is the main disposal route of livestock mortalities. However, other techniques including burial, burning, rendering, composting, anaerobic digestion, and alkaline hydrolysis are also practiced [52].

5.1.4.1 Emissions to Air

64. The UNEP Guidelines on Best Available Techniques (BATs) and Provisional Guidance on Best Environmental Practices (BEPs) relevant to Article 5 and Annex C of the Stockholm Convention on Persistent Organic Pollutants provide a comprehensive overview of the emissions which may

¹⁹ <http://www.omafra.gov.on.ca/english/nm/nman/agrisuite.htm>

originate from the destruction of animal carcasses in Section VI.I. [53]. Airborne emissions from destruction of carcasses consist of nitrogen oxides (NO_x), carbon monoxide (CO), Sulphur dioxide (SO₂), particulate matter, metal compounds, organic compounds and polychlorinated dibenzodioxins (PCDD) and dibenzofurans (PCDF) [53]. The Guidelines highlighted that there is a lack of reliability in data for polychlorinated biphenyls (PCB) and hexachlorobenzene (HCB) emissions. The Guidelines provide recommendations for primary and secondary measures and for destruction of animal carcasses, however, the protocol for determination of the emissions is not given.

65. The UK Department for Environment, Food and Rural Affairs (DEFRA) developed a test protocol to determine emissions of eight pollutants (SO₂, HCl, NO_x, TPM, CO, CO₂, dioxins/furans and VOCs) [54]. The method consisted of a comprehensive literature review to determine available information available on the emissions from small incinerators, followed by the site assessment. A protocol to measure emissions from the animal carcass incinerators was developed from reference test methods used for assessing emissions from industrial processes. A full list of protocols for each parameter is provided in Table 1 of the report [98]. In addition, a continuous emission monitoring system (CEMS) was implemented on the site to determine concentrations of NO_x, SO₂, CO, CO₂ and O₂ [54].

5.1.4.2 Releases to water and land

66. During carcass disposal processes surface and cooling water, can be contaminated by body fluids, suspended solids, fats and oils. Ash and other by-products from disposal are disposed of to land. However, according to the UNEP Guidelines [53] if waste products are disposed of properly to landfill, they are not anticipated to give rise to large risk of population exposure; the main route for such exposure is thus considered to be emissions to air.

5.2 Summary of Techniques used to Estimate Releases from Non-Point Sources from Crop Production

67. In the following sections, techniques for estimation of emissions and releases to air, water and land are presented for:

- a. Emissions due to field burning of agricultural waste (biomass burning);
- b. Releases from crop applications for use of fertilizers;
- c. Releases from crop applications for use of pesticides.

5.2.1 Field burning of agricultural waste (biomass burning)

68. Biomass (stubble, crop residues, trees and other waste) burning (BB) can represent a significant pollution source, with global, regional and local impacts on air quality, public health and climate, globally.

5.2.1.1 Emissions to Air

69. The UNITAR Guidelines [5] propose that in the case of crop associated burning, the emissions can be estimated as following:

$$E_{AP(BB)} = EF_{(BT, AP)} * BB_w \quad (\text{Equation 5.9})$$

where:

EAP(BB) = emissions of air pollutant due to biomass burned (kg of air pollutant emissions)

EF (BT, AP) = emission factor specific to biomass type and air pollutant (kg emissions/tonne burned); The necessary emission factors can be obtained from the literature.

BBw = (total tonnes of biomass burned).

70. In a case the primary data is obtained via remote sensing a different emission factor would have to be obtained relating emissions expected from the burning of the vegetation mass in question per unit area burned. This emission factor would have to be multiplied by the total area burned, as indicated by the remote sensing data, using the following equation:

$$E_{AP(BB)} = EF(VT) * AT(BB) \quad (\text{Equation 5.10})$$

where:

EAE (BB) = emissions air emissions due to biomass burned (tonnes of air emissions)

EF (VT) = emission factor specific to vegetation type being burned (tonne air emissions/unit km²)

AT(BB) = total area of burned biomass (total km² burned)

71. The EMEP/EEA air pollutant emission inventory guidebook discusses choice of methods for estimating the emissions and provides comprehensive description of **Tier 1** default approach, **Tier 2** technology-specific approach and **Tier 3** emission modelling and use of facility data [55].

72. The simplest approach (**Tier 1**) is to use a single emission factor for each pollutant representing emission per mass of waste burned. This approach requires input data on the amount of waste per hectare of farmland and the total area and the Guidebook includes Tables with default values for the amount of waste per hectare of arable farmland, and some typical emission factors for dioxins, PAHs, VOCs and NH₃/NH₄ [1].

73. The OECD Compendium [1] recommends the following steps for the estimates of air emissions from BB:

Step 1: Determine which forms of agricultural burning are relevant to the study region and the extent of available activity data and local fuel loading values, emission factors and other data;

Step 2: Decide which estimation methods to use and collect the data needed;

Step 3: Calculate emissions for each sub-category, then aggregate as required;

Step 4: Spatially and temporally disaggregate as required.

5.2.1.2 Releases to water and land

74. Sundarambal et al. [56] investigated the impact of biomass burning on ocean water quality in Southeast Asia. They reported that atmospheric deposition represents a significant and rising source of nutrients to freshwater and marine ecosystems. It occurs either as “wet deposition” or as “dry deposition” of particles and “gaseous exchange” between the air and water. Blake and Downing [57] provide comprehensive overview and evaluation of direct methods for measuring atmospheric nutrient deposition to inland waters.

5.2.1.3 Comments on reliability

75. The OECD Compendium [1] pointed out that although activity data on the areas of farmland and crop harvests may be quite good in many countries, estimates of waste (residue/crop ratios) from crops are often unreliable. In particular, some emission factors (e.g., dioxins, PAHs in particular) may have a high degree of uncertainty. For the releases to water, Blake and Downing [57] proposed that quantification of contamination of deposition samplers by materials such as insects, plant parts, and bird droppings should be made.

76. Sources of further information are provided in Annex III, Appendix D.

5.2.2 Techniques used to estimate emissions and releases from the use of fertilizers

5.2.2.1 Data on the global chemical fertilizer (nitrogenous, potash, and phosphate fertilizers) consumption per country, measured as the quantity of plant nutrients used per unit of arable land (excluding plant and animal manures) can be found in the agricultural data compiled by the World Bank.⁵

5.2.2.2 Emissions to Air

77. The UNITAR Guidelines [5] and the OECD Compendiums [1][6] provide detailed description of techniques for estimating fertilizer emissions to air. The extent to which NH₃ is emitted to the atmosphere is dependent on the chemical composition, including the concentration of NH₃ of the fertilizer solution, the temperature of the solution, the surface area of the soil that is exposed to the atmosphere, and the resistance of NH₃ transport in the atmosphere.

NH₃ and NO emissions

78. According to the OECD Compendium [1] NH₃ and NO emissions from N fertilizers are estimated using the following **Tier 1** equation:

$$E_{\text{pollutant}} = AR_{\text{fertiliser_applied}} \cdot EF_{\text{pollutant}} \quad (\text{Equation 5.11})$$

Where:

$E_{\text{pollutant}}$ = amount of pollutant emitted (kg a⁻¹),

$AR_{\text{fertiliser_applied}}$ = amount of N applied (kg a⁻¹),

$EF_{\text{pollutant}}$ = EF of pollutant (kg kg⁻¹).

79. The equation 5.11 is applied at the national level, using data on the annual national total fertilizer nitrogen use. According to the OECD Compendium [1] **Tier 1** approach above, default NH₃ emission factor is derived from a mean of default emission factors for individual N fertilizers weighted based on their use. The emission factors are reported as 0.05 kg NH₃ kg⁻¹ fertilizer applied for NH₃ from N fertilizer, is 0.05 kg NH₃ kg⁻¹ fertilizer applied, and 0.04 kg kg⁻¹ for NO fertilizer applied, reported as NO₂ [1].

CO₂ emissions

80. The CO₂ emissions from urea fertilizers are estimated using the following Tier 1 equation:

$$\text{CO}_2\text{-C Emission} = M \cdot EF \quad (\text{Equation 5.12})$$

Where:

CO₂-C Emission = annual C emissions from urea application, tonnes C yr⁻¹

M = annual amount of urea fertilisation, tonnes urea yr⁻¹

EF = emission factor, tonne of C (tonne of urea)⁻¹

81. According to the OECD compendium [1] an overall emission factor of 0.20, which is the equivalent to the carbon content of urea on an atomic weight basis, for urea is applied. CO₂-C emissions should be multiplied by 44/12 to convert into CO₂.

82. The CO₂ emissions from additions of carbonate limes to soil are estimated as following (Tier 1):

$$\text{CO}_2\text{-C Emission} = (M_{\text{Limestone}} \cdot EF_{\text{Limestone}}) + (M_{\text{Dolomite}} \cdot EF_{\text{Dolomite}}) \quad (\text{Equation 5.13})$$

Where:

CO₂-C Emission = annual C emissions from lime application, tonnes C yr⁻¹

M = annual amount of calcic limestone (CaCO₃) or dolomite (CaMg(CO₃)₂), tonnes yr⁻¹

EF = emission factor, tonne of C (tonne of limestone or dolomite)⁻¹

83. An overall emission factors of 0.12 and 0.13 are applied for limestone and dolomite, respectively. They represent the equivalents to carbonate carbon contents of the materials. CO₂-C emissions should be multiplied by 44/12 to convert into CO₂ [1].

5.2.2.3 Releases to water and land

84. Fertilizers emissions and releases to water in the European River Basin Districts (RBD) are allocated using JRC's GREEN model for Nutrient-N and Nutrient-P [1] [32][58-59]. Nutrient inputs from agriculture are estimated based on the CORINE Land Cover map²⁰ and fertiliser rate by NUTS2²¹ region and crop type. Activity rates and emission factors are both taken into account in the model calculations. Emissions from agriculture to surface water estimated using this method are then spatially allocated to RBD and their Sub-Units (RBDSU) spatial levels using GIS techniques. Proxy data used for spatial allocation are land use data, fertilizer application rates from the Common Agricultural Policy Regional Impact (CAPRI) model²², and population statistics [1].

85. In the USA, the USGS [27] performed estimates of nutrient inputs to the land surface from fertilizers, manure and atmospheric deposition for the period 1982–2001 as a part of the National Water-Quality Assessment Program. The methods and techniques used as well as detailed maps are provided in the report [27].

5.2.2.4 Comments on reliability

86. The OECD Compendium [1] summarizes key factors that may affect the reliability of calculations of fertilizer emissions and releases to air, water and land. The compendium points out that as the area of crops under cultivation is probably accurate to better than ± 10 percent in most countries, the emission factor represents the main uncertainty in the emissions calculations for fertilizer.

87. The overall emissions in the NH₃ measurements from mineral fertilizer are about ± 50 percent. For NO emission estimates, the relative 95 percent-confidence interval may vary from -80 percent to +406 percent. Therefore, the overall uncertainty may be a factor of four. Furthermore, for CO₂ emissions from urea or liming, there are uncertainties in the amount of urea or lime applied to soils and in the net amount of carbon from urea or liming that is emitted as CO₂. The emission factors for urea and lime have an uncertainty of -50 percent [1]. There are also uncertainties associated with determination of net amount of carbon added to soils from urea or lime fertilization that is emitted as CO₂.

88. The reliability of activity data depends on the accuracy of fertilizer production, sales, import/export, and/or usage data. Since the import/export and production data have additional uncertainties due to inferences about application, the OECD Compendium [1] suggest that inventory compilers may use a conservative approach and assume that all urea or lime available for application or purchased is applied to soils.

5.2.3 Techniques used to estimate emissions and releases from the use of pesticides

89. Techniques and methodologies to estimate releases from the use of pesticides are described in UNITAR [5] and OECD Guidelines [1][6]. The European Commission established a Pesticides Database which provides thorough information on active substances used in plant protection products, maximum residue levels (MRLs) in food products, and emergency authorizations of plant protection products in Member States [60]. According to the OECD Compendium [1] pesticide emissions are potentially influenced by:

- The way in which a pesticide is applied;

²⁰ CORINE Land Cover map. url: <https://land.copernicus.eu/pan-european/corine-land-cover>

²¹ <https://ec.europa.eu/eurostat/web/nuts/background>

²² <https://www.capri-model.org/dokuwiki/doku.php?id=capri:concept:spatfert>

- Whether the application takes place in closed spaces (greenhouses) or fields;
- The vapor pressure of the pesticide involved;
- Additives used with pesticides in order to increase their uptake;
- The meteorological conditions during application; and
- The height of the crop.

90. The compendium highlighted that quantitative data on all the factors noted above are necessary in order to calculate pesticide emissions precisely. However, in practice, this type of data is not available. Moreover, even the information on the methods of pesticides application is rare and unreliable. For this reason, the methodology proposed in the compendium assumes that application takes place under normal field conditions (i.e., no specific measures taken to avoid emissions), with a standard meteorology.

5.2.3.1 Air emissions

91. The UNITAR Guidelines [5] underlined that both the solvent carrier and the active compound usually vaporize and contribute to VOC emissions. However, the VOC content of the formulation can vary substantially from product to product, as pesticides liquid formulations can either be water or solvent based mixtures of the active compound.

92. According to the OECD Compendium [1], the emissions to air from pesticide use can be estimated from the amount of the pesticide applied and an emission factor (EF_{pest_i}) as following:

$$E_{pest} = \sum m_{pest_i} * EF_{pest_i} \quad (\text{Equation 5.14})$$

Where:

E_{pest} = total emission of pesticides (in $t a^{-1}$),
 m_{pest_i} = mass of individual pesticide applied ($t a^{-1}$),
 EF_{pest_i} = Emission Factor (EF) for individual pesticide ($kg kg^{-1}$).

93. The EFs can be derived from the vapour pressure of the pesticides, which are currently found as the most convenient way to estimate emissions [1].

5.2.3.2 Releases to Water

94. Factors that determine the specific risk of pesticide use on water pollution include [61-62]:

- Active ingredient(s) in the pesticide formulation
- Contaminants that exist as impurities in the active ingredient(s)
- Additives that are mixed with the active ingredient(s) (wetting agents, diluents or solvents, extenders, adhesives, buffers, preservatives, and emulsifiers)
- compounds formed during chemical, microbial, or photochemical degradation of the active ingredient
- Pesticide half-life: The more stable the pesticide, the longer it takes to break down. and the higher its persistence. The half-life is unique to individual products but variable depending on specific environmental and application factors.

5.2.3.3 Releases to Land

95. All pesticides have unique mobility properties, both vertically and horizontally through the soil structure. Residual herbicides applied directly to the soil are designed to bond to the soil structure.

96. Once a pesticide is applied to soil, it will follow one of three pathways: (i) adhering to soil particles (mainly organic matter and clays), (ii) degrading by organisms and/or free enzymes, and (iii) moving through the soil with water. From the physical-chemical data of adsorption, mobility, and degradation obtained in the laboratory, it is possible to predict with a high degree of reliability the

behavior of pesticides in the soil [62]. OECD proposed several guidelines including adsorption [63], degradation [64], and leaching [65].

5.2.3.4 Comments on reliability

97. The OECD Compendium [1] pointed out that although the activity data on the areas of farmland and crop harvests may be quite good in many countries, estimates of waste (residue/crop ratios) from crops are often unreliable and as a consequence, some emission factors (e.g., dioxins, PAHs in particular) may have a high degree of uncertainty. The UNITAR Guidelines highlighted that i) in the case of the estimation techniques based on pesticide residue data generated through monitoring programs, their reliability and accuracy will depend on the availability and comprehensiveness of local pesticide monitoring studies [5]. The reliability and accuracy of the estimation techniques based on mathematical models is discussed in previous subsections and [14][16].

98. Sources of further information are provided in Annex III, Appendix E.

6 Conclusions

99. This document provides a comprehensive literature review of techniques and applied methodologies for estimation of non-point (diffuse) source emissions to air and releases to water and land from the animal farming and crop production agricultural sectors including, enteric fermentation, manure management, feed management (silage leachate), field burning of and disposal of livestock mortalities, biomass burning, use of fertilizers and use of pesticides.

100. During the process of desktop research and compilation of information, it became apparent that:

- a. Information about emissions to air from the above sources is well documented; and
- b. The estimation techniques about releases to water and land from the above agricultural non-point (diffuse) sources is rather limited due to the fact that data collection and estimating of pollution loadings from these pollution sources to water and land is very complex and often requires integration of scientific, technological, socio-economical and educational factors.

101. For the purpose of the document, an extensive peer-reviewed literature was compiled and integrated to assist the Contracting Parties in determination of the most appropriated methods and techniques to estimate potential pollution releases from these non-point sources. An extensive bibliography and supplemental information containing recommendations for further sources of information and peer reviewed research papers particularly relevant to Mediterranean region are presented in Annex III, Appendices A-E, for the further benefit of the Contracting Parties.

102. Apart from integrating the available information for the first time, the additional value of this document is in:

- a. Inclusion of silage leachate as a non-point (diffuse) pollution source in the NBB Animal farming/PRTR Intensive livestock production Sector (Table 2.1) and proposed techniques to estimate releases from this source; and
- b. Introducing two separate process categories, e.g., “field burning and disposal of livestock mortalities” (Animal farming Sector) and Biomass Burning (Agricultural Sector) instead of a single “burning of agricultural waste” process.

Annex I

Characteristics of Non-point (diffuse) Sources from Agriculture

A. Introduction

1. Characteristics of emissions and releases from the following agricultural processes: (i) Enteric Fermentation; (ii) Manure Management; (iii) Silage Leachate; (iv) Field burning of agricultural waste (disposal of livestock mortalities); (v) Crop Production including use of fertilizers; use of pesticides; and biomass burning are presented in the following sections.

B. Emissions from Enteric Fermentation

2. Enteric fermentation is a natural part of the digestive process in ruminant animals such as cattle, sheep, goats, and buffalo²³. Microbes resident in the animal's digestive system or rumen, decompose and ferment food, and produce methane (CH₄) as a by-product. This CH₄ is exhaled or belched and expelled by the animal and accounts for the majority of emissions from ruminants [66-68]. The primary drivers affecting gaseous emissions are the number of animals and the type and quantity of feed consumed. The intensity of enteric methane emissions, and the potential to reduce these emissions, varies greatly across regions and production systems due to different regional conditions, and farming management practices [66]. Moss et al. [69] reported that in the EU, approximately two-thirds of annual regional methane emissions - amounting to some 6.8 million tonnes - have been attributed to enteric fermentation in ruminants. In the New Zealand, where grazing ruminants dominate the agrarian landscape, enterically generated methane accounts for 97.6% of CH₄ emissions from the agricultural sector, and 85.6% of all anthropogenic CH₄ discharges [67]. Gibbs et al (2001) provided a thorough overview of emissions from enteric fermentation, including methodologies to estimate methane emissions [68]. A comprehensive review of enteric fermentation process, different methods to estimate the emissions from enteric fermentation and their contribution to a global methane budget has been conducted by Thorpe (2009) [67].

C. Emissions and releases from Manure Management

Emissions to Air

3. Manure generated from farming of animals and intensive livestock production contains substantial quantities of inorganic nitrogen (N), carbon (C), and water which are the crucial substrates required for the microbial production of nitrous oxide (N₂O) and methane (CH₄). These greenhouse gases can be generated and emitted at each stage of the manure management including the livestock buildings, manure storage facilities, manure treatment and manure spreading to land [69-71]. The contribution of manure management to total national agricultural emissions of N₂O and CH₄ varies, however Chadwick et al [70] highlighted that it can exceed 50% in countries reporting to the UNFCCC.²⁴ They also provided a comprehensive review of N₂O and CH₄ emissions at each stage of manure management process [70].

Releases to water and land

²³ Pigs are not included because they are monogastric, meaning they have one major stomach compartment and rely primarily on enzymes for digestion. This is in contrast to ruminants, which have three pre-stomach chambers devoted to fermentation of feedstuffs and an enzymatic stomach as well (<https://extension.oregonstate.edu/node/99076/printable/print>).

²⁴ <https://unfccc.int/process/transparency-and-reporting/reporting-and-review-under-the-convention/greenhouse-gas-inventories/submissions-of-annual-greenhouse-gas-inventories-for-2017/submissions-of-annual-ghg-inventories-2009>

4. Animal waste, including manure has serious implications for water quality. The most common pathway for contaminant (nutrients, pathogens, veterinary antibiotics and pathogens) transport is through runoff from open barnyards and feed lots, manure and feed storage units and land application. When applied to land, all contaminants contained in animal manure can travel and get transported and released to water and land via surface water runoff, soil erosion, drainage or leaching [72-74].

5. In the last 15 years veterinary medicines (antibiotics, vaccines and hormones), emerged as a new class of agricultural pollutants. Detailed information on these pollutants releases to water and their impact on the ecosystems, human health and the environment globally can be found in the Reports published by the Food and Agriculture Organization (FAO) of the United Nations Rome and joined publication of FAO and the International Water Management Institute (IWMI) [73-74].

Effects on the environment

6. Each of the above-described processes have adverse effects on the environment and human health. For example, the accumulation of nutrients from fertilizers and manure application to land, and animals farming (runoff from manure and feedlots) is a principal cause of nutrient enrichment (eutrophication) of lakes and coastal waters [2][75]. Eutrophication has many detrimental impacts on the environment, health (animal and human) and the economy. These were recently reviewed by Drizo [2] and include: i) intensified growth and production of algae, cyanobacteria (blue-green algae) and aquatic plants, commonly referred to as “harmful algal blooms (HABs)” which results in reducing oxygen content of water and hypoxia, loss of biodiversity, and fish kills; ii) excretion of toxins that may seriously affect human health. For example, the well-known blue-baby syndrome in which high levels of nitrates in water can cause methemoglobinemia; a potentially fatal illness in infants. Moreover, recent studies revealed that most cyanobacteria produce the neurotoxin beta-N-methylamino-L-alanine (BMAA) which was linked with the development of neurodegenerative diseases (Alzheimer's and Parkinson's diseases, and Amyotrophic Lateral Sclerosis (ALS)); and iii) diminishing of potable water supplies, reduction in property values, tourism and recreation leading to considerable economic losses. In addition, there is an increasing evidence that Global Climate Change will promote cyanobacterial growth and intensify algal blooms at much larger scales, further diminishing water availability and potable water supplies [2].

D. Silage Leachate

7. Silage is a type of feed made from green foliage crops which have been preserved by acidification, achieved through fermentation. It is used to feed domesticated livestock, such as cattle, sheep and other ruminants. Silage leachate (effluent) is generated from the moisture that either drains out of forage material (during or after the ensiling process) or from external water that comes into contact with and flows through the silage—or from a combination of both of these sources. It is about 200 times more polluting than raw domestic sewage, and is the most toxic waste streams on farm, containing large concentrations of organic compounds and nutrients [40][76-77]. Gebrehanna et al [76] provide an excellent summary of biochemical characteristics of silage effluent reported in the literature. A typical effluent can contain 12,000-90,000 mg/L biochemical oxygen demand (BOD), 300- 600 mg/L phosphorus (P), 800 to 3,700 mg/L organic N, and 350-700 mg/L ammonium (NH₃-N). It also has a very low pH, ranging from 3.5 to 5.5.

E. Field burning of agricultural waste (disposal of livestock mortalities)

8. Animal farming systems generate a significant volume of mortalities that need to be disposed of safely, practically and economically. The most widely utilised methods for disposal of on-farm mortalities have been burial and to a lesser extent, burning. However, the implementation of the

European Union (EU) Animal By-Product Regulations (1774/2002)²⁵ forbade these practices within the EU due to fears that infectious agents may inadvertently enter both the human food and animal feed chains and water pollution. Thus, the main disposal route became incineration (either on or off-farm) [52][78-79]. However, the emissions of gases and particulates resulting from incineration of animal carcasses may contain chemicals and other toxins and create air pollution. Incineration is known to release toxic wastes containing dioxin, mercury, lead, and other harmful substances into the air as waste is burned, to emit particle pollution, to produce toxic ashes, and to contaminate local soil and vegetation [52][80]. Gwyther et al. [52] conducted a comprehensive review of the legislation and environmental and biosecurity characteristics of livestock carcass disposal methods.

F. Crop Production

Use of fertilizers

9. Farmers and agricultural producers apply millions of tons of chemical fertilizers and manure to improve crop yields. The global use of fertilizers increased 19-fold in the last century, with global use of P fertilizers increasing from about 873 million tonnes in 1913 to about 16 591 million tonnes of P in the late 1980s [33] [81-82]. There is a vast variety in the type and rates of application and many fields may receive a mix of manure/fertilizer types in several applications over a single growing season. For example, grassland fields sometimes receive 10 times more dairy manure volume than fields receiving poultry or swine manure [82] [2]. Similar to releases of contaminants from manure (Section 1.1.2.2) when fertilizers are applied to land, the main pathways of contaminants transport and releases to water and land are surface water runoff, soil erosion, drainage and leaching [33] [81-82]. The World Bank provides a comprehensive list of data on the global chemical fertilizer (nitrogenous, potash, and phosphate fertilizers) consumption per country, measured as the quantity of plant nutrients used per unit of arable land (excluding plant and animal manures).²⁶ They also provide information on land surface area [83], percent of arable land and annual fertilizer consumption (kg/ha).²⁷ Based on World Bank data^{26,27}, the total annual fertilizer consumption in the Mediterranean region is (12 x 10⁶ tons). Of these, 78.3% is used in France (3 x 10⁶ tons) followed by Turkey (2.8 x 10⁶ tons), Egypt (1.81 x 10⁶ tons) and Spain (1.77 x 10⁶ tons).

Use of pesticides

10. A pesticide is defined as any active substance or mixture used to eradicate unwanted organisms, or pests, including weeds, insects, fungi, bacteria, and rodents. Agriculture accounts for approximately 85 percent of all pesticide use. They are mainly used before or after harvest to protect and preserve crops, orchards and other plants or plant products, and to influence their growth. However, they are also used to suppress pests in confined animal farm operations (CAFOs). Therefore, the main transport and pathways of contaminants (contained in pesticides) releases to water and land are the same as those described for manure and fertilizers (Section 1.1.2) e.g., surface runoff from open lots, soil erosion, drainage and leaching [84-85]. However, unlike manure and fertilizers, pesticides are also applied on crops, fruit, vegetables and other plants and therefore are also transported in a food chain. As most pesticides are potentially toxic to humans causing both acute and chronic health effects,

²⁵ <https://eur-lex.europa.eu/legal-content/EN/TXT/?uri=celex%3A32002R1774>

²⁶ World Bank (2021a). Fertilizer consumption (kilograms per hectare of arable land). <https://data.worldbank.org/indicator/AG.CON.FERT.ZS>, accessed 19th January 2021.

²⁷ World Bank (2021b). Arable land (% of land area). url: <https://data.worldbank.org/indicator/AG.LND.ARBL.ZS>, accessed 19th January 2021.

depending on the quantity and ways in which a person is exposed, their overuse represents a high risk to human health [84-86].

11. Pesticide can be applied in both liquid and solid form: as concentrates, solutions, aerosols, and gas; and as dusts, granules, and powders. They are generally categorized on the basis of the type of pest they are primarily designed to target, the main types of pesticides in worldwide use being herbicides (40 percent), insecticides (33 percent), and fungicides (10 percent) [84-85].

12. An extensive database of pesticides uses per area of cropland (kg/ha) for the period 1990 to 2018 has been compiled by FAO.²⁸ It shows that in Mediterranean region, Malta is the top user (8.6 kg/ha) followed by Italy (5.9 kg/ha) and France (4.4 kg/ha). The EU Pesticides Database [60] assists users to search for information on active substances used in plant protection products, maximum residue levels (MRLs) in food products, and emergency authorisations of plant protection products in Member States.

13. The adverse effects of agricultural use of pesticides on water quality, human health and ecology have been documented for the past 25 years [3] [61-62][84-86]. Their effects depend not only on how heavily they are applied, but also on their toxicity and persistence in the environment, their handling, and the exposure of non-target organisms [85]. Pesticide accumulation in water and the food chain, with demonstrated detrimental effects on humans, led to the widespread banning of certain broad-spectrum and persistent pesticides (such as DDT and many organophosphates), but some such pesticides are still used in poorer countries, causing acute and likely chronic health effects [84].

Biomass burning

14. Biomass burning (BB) is a significant air pollution source, with global, regional and local impacts on air quality, public health and climate, globally. Agricultural residues burning emits significant amounts of greenhouse gases (CO₂, CH₄, CO and hydrocarbons); other gaseous pollutants such as SO₂ and NO_x; and smoke particles which can carry carcinogenic substances with a wide size distribution [87]. Koppmann et al. [88] and Reid et al. [89-90] made a comprehensive description of biomass-burning particles properties and their emissions impacts on air quality, health and climate. A number of researchers investigated the effects of biomass burning on air pollution in Mediterranean [91-95].

²⁸ FAOSTAT. Pesticides indicators. url: <http://www.fao.org/faostat/en/#data/EP/visualize>

Annex II

Non-point/diffuse sources pollution inventories approach for estimating emissions from non-point (diffuse) sources to air, water and land from agriculture

A. Background

15. Sources of pollution inventories have been long established and documented. Economopoulos and the World Health Organization (WHO) described early approaches for rapid source inventory techniques for assessment of air, land and water pollution, and their use in formulating environmental control strategies nearly three decades ago [96]. UNITAR published Guidance for estimating pollution from non-point (diffuse) source emissions in 1998 [5]. They highlighted that estimation techniques for this type of sources requires different types of data and approaches compared to point sources and may include statistical data on economic activities, demographic data, remote sensing data, emission factors and engineering data; tools may include geographical information systems (GIS) and computer models (e.g., hydrology/water flow models, transportation models and others). The Guidance [5] further suggested to construct appropriate emission factors which are linked to source parameters that are known or easily obtained. For example, in the case of agriculture, the parameters could include the size and composition of cultivated area, the quantity of pesticide or fertilizer use and the locations where these chemicals are applied. In this manner, one can perform a reasonable estimate of aggregate emissions arising from non-point or diffuse sources of certain pollutants starting from simple, known parameters that are readily measured or obtained for each source type.

16. The OECD Resource Compendia of PRTR release estimation techniques provide updated description of aims and uses of emissions inventories [1][6]. The documents underline that while there are many types of inventories in OECD countries, in general, those that include non-point (diffuse) sources are usually not integrated across the environmental media, but relate to a specific environmental medium (i.e., to air, water or land). Additionally, they often apply to smaller geographic regions and are defined by jurisdictional or administrative boundaries, urban airsheds or catchments [1]. The regulatory and community right-to-know generally focus on point source emissions while government planning, policy development and reporting tools usually include both point and non-point sources and may have more restricted pollutant lists than inventories developed for the purposes of community right-to-know [1].

B. Overview of approaches for inventories on non-point (diffuse) source discharges to air from agriculture

17. The LBS Protocol stipulates the Contracting Parties to submit reports containing information on: (i) monitoring data and (ii) quantities of pollutants discharged from their territories (Article 13, para 2). The Contracting Parties agreed on development of NBB for this purpose to serve as “the monitoring tool” and to track progress, on a five-yearly basis, of discharged loads of pollutants reflecting the effectiveness of measures taken to reduce and prevent pollution from LBS. To assist countries, an updated NBB guideline was developed in 2015 (UNEP(DEPI)/MED WG.404/7 Annex IV, Appendix B, Page 11)⁷.

18. Air inventories and methodologies for estimating emissions from non-point (diffuse) sources to air are well established and documented [1][5-6][96]. For example, Economopoulos and the WHO [96] suggested system analysis approach which consists of the analysis of existing problems, the identification of the most critical ones, setting of pollution control objectives and development of strategies to meet these objectives. However, their guide does not include approaches for non-point (diffuse) sources.

19. The OECD Compendiums [1][6] provide an exhaustive overview of approaches for air inventories. These inventories highlight the most common generic approaches relevant to non-point source air inventories which include:

- Emission factors (based on test data or surveys of manufacturers);
- Materials balance (assumes that all solvent in a product evaporates);
- Fuel analysis (assumes complete conversion of S to SO₂ during combustion); and
- Emission estimation models (empirically derived sets of equations to estimate emissions, e.g., MOVES, COPERT 5).

20. For guidance on survey methods, the Compendia recommend Australian National Pollutant Inventory (NPI) Emission Estimation Technique (EET) manual for Aggregated Emissions from Domestic Lawn Mowing [97]. However, this manual does not discuss nor provide any estimation techniques for emissions caused by agriculture non-point (diffuse) pollution sources and processes listed in Table 5.1. To compile an emission inventory, all relevant sources of the pollutants should be identified and quantified. For further guidance we recommend the following documents:

- The UNECE Convention on Long-range Transboundary Air Pollution Task Force on Emission Inventories and Projections (TFEIP) website²⁹. It provides a technical forum and expert network to harmonise emission factors, establish methodologies for the evaluation of emission data and projections and identify problems related to emissions reporting. It also offers the information on various resources and guidance documents are available to assist national emission inventory compilers with development, improvement and reporting of national emission inventories.
- IPCC (2019)³⁰. 2019 Refinement to the 2006 IPCC Guidelines for National Greenhouse Gas Inventories, Volume 4, Agriculture, Forestry and Other Land Use, Chapter 10: Emissions from Livestock and Manure Management [10].
- Canada's Air Pollutant Emissions Inventory Report 2020: annex 2. The report describes approaches and methods used for the estimates of NH₃ emissions from Canadian livestock, emissions calculations for annual cattle, sheep, swine and other livestock populations, emissions emitted when synthetic fertilizers are applied for annual and perennial crop production³¹.

C. Overview of approaches for inventories on non-point (diffuse) source discharges to water from agriculture

21. Techniques for estimating non-point (diffuse) sources releases to water are generally incorporated into empirical, conceptual and/or physics-based catchment models. Most of these models require spatial data on land use coverage, amount of fertilizer used, livestock numbers are other data [1][6].

22. The US EPA National Management Measures to Control Nonpoint Source Pollution from Agriculture provides a detailed guide of load estimation techniques through monitoring and modelling of pollutant load [14]. Loading models include techniques which are primarily designed to predict pollutant movement from the land surface to waterbodies and are categorized as (a) watershed loading models, (b) field-scale models, and (c) receiving-water models. Of these, field-scale models are most frequently used in agricultural systems [48]. More recently, USA EPA developed a document that describes and catalogues tools that are currently in use to estimate nitrogen, phosphorus, and sediment

²⁹ <https://www.tfeip-secretariat.org/guidance-and-resources-1>

³⁰ <https://www.ipcc-nggip.iges.or.jp/public/2019rf/vol4.html>

³¹ <https://www.canada.ca/en/environment-climate-change/services/air-pollution/publications/emissions-inventory-report-2020/annex-2-4.html>

losses and identifies the uses for which these tools are most appropriate to achieve watershed protection [15].

23. In Europe, the European Pollutant Release and Transfer Register (E-PRTR) promulgated by the Regulation No 166/2006³² stipulates that E-PRTR database must include releases of pollutants from diffuse sources where available [16]. When such data are not available, the European Commission is required to take actions to initiate reporting on these sources. In the last 15 years several international activities were initiated by the Commission and the European Environmental Agency (EEA) to stimulate and facilitate reporting on diffuse sources. One of these projects was “Diffuse water emissions in E-PRTR Project” completed in 2013 is of particular relevance as the researchers 1) gathered available data on diffuse releases to surface water with data sets available up to 2009; 2) proposed alternative estimation methods where emission data are not available on the European scale; 3) developed a methodology to derive disaggregated spatial data to obtain geographical information system layers; 4) derived gridded emission map layers covering all EU27 Member States and the EFTA countries (Switzerland, Liechtenstein, Norway and Iceland) for the selected sectors and pollutants with the highest resolution possible [16].

D. Overview of approaches for inventories on non-point (diffuse) source discharges to land from agriculture

24. Compared to the available information for air and water, the information on the methodologies for estimates of the non-point (diffuse) source discharges on land is limited. Wierl et al [98] described several sources and methods used in the watershed in Wisconsin, USA which can be applied to other regions. These included: nonpoint-source control plans, field inventories, conservation plans for farm operations, county databases, and other agricultural management agencies. Watershed descriptions were developed for each of the evaluation monitoring watersheds and include information on location, climate, soil types, topography, nonpoint pollution sources, and surface-water resources. The land-use inventory team identified and quantified agricultural sources of pollutants, which included barnyard-animal waste, streambank erosion, upland soil loss, and manure spreading [98]. Lokupitiya and Paustian [99] provide a comprehensive description of methodologies and approaches for estimating GHG emissions and removals in agricultural soils.

25. For further guidance, the following documents are recommended:

- **European Commission (2016). *Soil Threats in Europe. JRC Technical Report* [100].** This report provides comprehensive information on the major soil threats in Europe. It also includes definition of the soil threat and processes involved, state of the soil degradation, drivers/pressures (including climate, human activities, policies), key indicators and effects of the soil threat, and effects of the soil threat on soil functions.
- **OECD (2020). *Resource Compendium of PRTR release estimation techniques, Part II: Summary of Diffuse Source Techniques, Series on Pollutant Release and Transfer Registers No. 19. ENV/JM/MONO (2020)30* [1].** This is the most recent Compendium of PRTR release estimation techniques which provides the most comprehensive, up-to-date information available on diffuse source techniques to estimate emissions and releases to air, water and land.
- **Xiang, C., Wang, Y. and Liu, H. (2017). *A scientometrics review on nonpoint source pollution research. Ecological Engineering 99: 400–408* [17].** This paper provides insights and global trends in non-point source pollution research. 3246 journal articles on nonpoint source pollution were retrieved from the SCI-E and SSCI databases for the 14 years period (2001 to 2015).

³² <https://eur-lex.europa.eu/eli/reg/2006/166/2009-08-07>

E. Accuracy and uncertainty

26. The quality of inventories is influenced by a number of factors including accuracy (the measure of ‘truth’ of a measure or estimate); comparability (between different methods or datasets); completeness (the proportion of all emissions sources that are covered by the inventory); and representativeness (in relation to the study region and sources of emissions) [1].

27. The feasibility and level of accuracy of non-point (diffuse) source emissions sources is determined by the types and quality of available information [5]. The UNITAR Guidelines highlighted that the availability of information needed vary greatly between countries and for different regions within a country. Therefore, the evaluation of availability and accuracy of information is a key when considering types of non-point (diffuse) to be included in the national PRTR system [5].

28. In discussing the accuracy and uncertainty, the OECD Compendium [1] points out definitions of accuracy and confidence described in the EEA Guidebook 2016 (updated in 2019) [101]. The Compendium highlights the fact that although the “truth” for any specific emission rate or magnitude is seldom known, the emissions can be estimated with both confidence and reliability. While confidence in inventory estimates does not make them accurate or precise, it assists in the development of a consensus that the data can be incorporated into the inventory [1]. The USEPA highlighted that prediction uncertainty is caused by natural process variability, and bias and error in sampling, measurement, and modeling [14]. A comprehensive description of uncertainties which may occur in the National Greenhouse Gas Inventories is provided in chapter 3 of the IPCC Refinement 2019 to the 2006 IPCC Guidelines [102].

29. According to the OECD Compendia [1][6], errors or uncertainty in the preparation of the inventories may include: 1) Emission factors (which do not reflect real life conditions); 2) Activity data that do not adequately reflect the study region (scaling down national or state activity data to smaller regions always results in decreased accuracy); 3) Spatial and temporal disaggregation may introduce errors that are difficult to quantify; 4) Sample surveys may be subject to sampling errors.

F. Quality control and quality assurance

30. The IPCC Refinement 2019 to the 2006 IPCC Guidelines for National Greenhouse Gas Inventories provides a comprehensive description of the quality assurance/quality control (QA/QC) and verification in chapter 6 [103]. These are also relevant to inventories of non-point (diffuse) sources

Box A.1.: Definitions of QA/QC and Verification

Quality Control (QC) is a system of routine technical activities and procedures to assess and maintain the quality of the inventory as it is being compiled and is compiled by the inventory team. The QC system is designed to: (i) Provide routine and consistent checks to ensure data integrity, correctness, and completeness; (ii) Identify and address errors and omissions; and (iii) Document and archive inventory material and record all activities. QC activities comprise general methods such as accuracy checks on data acquisition and calculations, and the use of approved standardised procedures for emission and removal calculations, measurements, estimating uncertainties, archiving information and reporting. QC activities also include technical reviews of categories, activity data, emission factors, other estimation parameters, and methods.

Quality Assurance (QA) is a system of review procedures conducted by independent third parties. The purpose of reviews is to verify that measurable objectives (data quality objectives) are met, and to ensure that the inventory represents the best possible estimates of emissions and removals given the current state of scientific knowledge and data availability and support the effectiveness of the QC programme.

Verification refers to the collection of activities and procedures conducted during the planning and development stage, or after the completion of an inventory that can help to establish its reliability for the intended applications of the inventory.

to water and land. The IPCC Guidelines document highlights the fact that a QA/QC and verification system contribute to the objectives of good practice in inventory development, and in particular to the improvements in transparency, consistency, comparability, completeness, and accuracy of inventories. It also provides definitions of QC, QA, and verification (Box A.1):

31. The OECD Compendiums [1][6] also provide summary of QA/QC. They highlight the importance of proper documentation, which ensures reproducibility, transparency and assists future inventory updates. Documentation should include all raw data used, assumptions, steps in calculations, and communications with data providers and QA/QC processes. Important missing data (e.g., missing pollutants, missing source types) also need to be acknowledged and documented [1][6].

Sources of Further Information on Techniques used to estimate methane releases from Enteric Fermentation to Air

International

- IPCC (2019). 2019 Refinement to the 2006 IPCC Guidelines for National Greenhouse Gas Inventories. Gavrilova, O., Leip, A., Dong, H., MacDonald, J.D., Bravo, C.A.G., Amon, B., Rosales, R.B., del Prado, A., de Lima, M.A., Oyhantçabal, W, van der Weerden, T.J. and Widiawati, Y. (eds). Volume 4 General Guidance and Reporting. Chapter 10: Emissions from Livestock and Manure Management. Published: IPCC, Switzerland. url: <https://www.ipcc-nggip.iges.or.jp/public/2019rf/vol4.html>
This document provides updated data on Tier 1 enteric fermentation factors for cattle and buffalo for each region of the World (Table 10.11) [ref 10].

US

- US EPA (1995-2018), Compilation of Air Pollutant Emission Factors, Volume I, Stationary Point and Area Sources, AP-42 (United States Environmental Protection Agency, North Carolina, US), Chapter 14, Section 4: Enteric Fermentation – Greenhouse Gases, <http://www3.epa.gov/ttnchie1/ap42/ch14/final/c14s04.pdf>

Canada

- Basarab, J.A., Okine, E.K., Baron, V.S., Marx, T.H., Ramsey, P., Ziegler, K., and Lyle, K.L. (2005). Methane emissions from enteric fermentation in Alberta's beef cattle population: A model methodology for Canada. Canadian Journal of Animal Science, 85(4), pp. 501-512 [ref 104].
- Karimi-Zindashty, Y., MacDonald, J.D., Desjardins, R.L., Worth, D.E., Hutchinson, J.J., and Vergé, X.P.C. (2012). "Sources of uncertainty in the IPCC Tier 2 Canadian livestock model.", Journal of Agricultural Science, 150(5), pp. 556-569. Doi : 10.1017/s002185961100092x [ref 105]

Australia

- Lines-Kelly, R. (2014). Enteric methane research: A summary of current knowledge and research. Published by the New South Wales Department of Primary Industries. url: https://www.dpi.nsw.gov.au/_data/assets/pdf_file/0011/532694/ag-resources-climate-enteric-methane.pdf [ref 106]

Mediterranean Region

- Córdor, R.D, Valli, L., De Rosa, G., Di Francia, A. and De Lauretis, R. (2008). Estimation of the methane emission factor for the Italian Mediterranean buffalo. Animal 2(8):1247-1253. <https://doi.org/10.1017/S1751731108002292> [ref 107]
- Ammar, H., Abidi, S., Ayed, M., Moujahed, N., deHaro Martí, M.E., Chahine, M., Bouraoui, R., López, S., Cheikh M'hamed, H. and Hechlef, H. (2020). Estimation of Tunisian

Greenhouse Gas Emissions from Different Livestock Species1. *Agriculture* 10: 562-579. doi:10.3390/agriculture10110562. [ref 108]

- Ibidhi, R., & Calsamiglia, S. (2020). Carbon Footprint Assessment of Spanish Dairy Cattle Farms: Effectiveness of Dietary and Farm Management Practices as a Mitigation Strategy. *Animals: an open access journal from MDPI*, 10(11), 2083. <https://doi.org/10.3390/ani10112083> [ref 109]
- Koch, J., Dayan, U. and Mey-Marom, A. (2000). Inventory of Greenhouse Gaseous Emissions Israel. *Water Air and Soil Pollution* 123(1):259-271. DOI: 10.1023/A:1005271424293 [ref 110]
- Ersoy E, Ugurlu A. The potential of Turkey's province-based livestock sector to mitigate GHG emissions through biogas production. *Journal of Environmental Management*. 2020 Feb;255:109858. DOI: 10.1016/j.jenvman.2019.109858. [ref 111]
- Grossi, G., Vitali, A., Lacetera, N., Danieli, P. P., Bernabucci, U., & Nardone, A. (2020). Carbon Footprint of Mediterranean Pasture-Based Native Beef: Effects of Agronomic Practices and Pasture Management under Different Climate Change Scenarios. *Animals: an open access journal from MDPI*, 10(3), 415. <https://doi.org/10.3390/ani10030415> [ref 112]

Sources of Further Information on Techniques used to estimate emissions and releases from Manure management

International

- Boezeman, D., Wiering, M. and Crabbé, A. (2020). Agricultural Diffuse Pollution and the EU Water Framework Directive: Problems and Progress in Governance. Editorial to the MDPI Special Issue "Water Quality and Agricultural Diffuse Pollution in Light of the EU Water Framework Directive". *Water* 12 2590: doi:10.3390/w12092590 [ref 113]
- Tao, Y., Liu, J., Guan, X., Chen, H., Ren, X., Wang, S., Ji, M. (2020). Estimation of potential agricultural non-point source pollution for Baiyangdian Basin, China, under different environment protection policies. *PLoS One* 15(9): e0239006. Published online 2020 Sep 22. doi: 10.1371/journal.pone.0239006 [ref 22].

Europe

- Preux, D. and Fribourg-Blanc, B. (2005). Overview of emissions to water - existing data collections. European Topic Centre on Water. url: https://unstats.un.org/unsd/environment/envpdf/pap_wasess4b1france.pdf [ref 18].
- Special Issue "Water Quality and Agricultural Diffuse Pollution in Light of the EU Water Framework Directive", https://www.mdpi.com/journal/water/special_issues/Water_Framework_Directive_Pollution

USA

- Richards, R.P. (1998). Estimation of Pollutant Loads in Rivers and Streams: A Guidance Document for Nonpoint Source Pollution (NPS) Programs. url: <http://abca.iwebsmart.net/downloads/Richards-1998.pdf> [ref 24]
- US EPA (2003). National Management Measures to Control Nonpoint Source Pollution from Agriculture. Chapter 7: Load Estimation Techniques. url: <https://www.epa.gov/nps/national-management-measures-control-nonpoint-source-pollution-agriculture> [ref 14].
- IPCC (2019). 2019 Refinement to the 2006 IPCC Guidelines for National Greenhouse Gas Inventories. Gavrilova, O., Leip, A., Dong, H., MacDonald, J.D., Bravo, C.A.G., Amon, B., Rosales, R.B., del Prado, A., de Lima, M.A., Oyhantçabal, W., van der Weerden, T.J. and Widiawati, Y. (eds). Volume 4 General Guidance and Reporting. Chapter 10: Emissions from Livestock and Manure Management. Published: IPCC, Switzerland. url: <https://www.ipcc-nggip.iges.or.jp/public/2019rf/vol4.html> [10]US EPA (2018). Nutrient

and Sediment Estimation Tools for Watershed Protection. url:

<https://www.epa.gov/sites/production/files/2018-08/documents/loadreductionmodels2018.pdf> [ref 15].

- US EPA (2003). National Management Measures to Control Nonpoint Source Pollution from Agriculture. Chapter 6: Monitoring and Tracking Techniques. url: <https://www.epa.gov/sites/production/files/2015-10/documents/chap6.pdf> [ref 25]

Mediterranean Region

- Loyon, L. (2018). Overview of Animal Manure Management for Beef, Pig, and Poultry Farms in France. *Frontiers in Sustainable Food Systems* 2:36. doi: 10.3389/fsufs.2018.00036 [ref 114]
- Velthof, G. L., Lesschen, J. P., Webb, J., Pietrzak, S., Miatkowski, Z., Pinto, M., et al. (2014). The impact of the Nitrates Directive on nitrogen emissions from agriculture in the EU-27 during 2000–2008. *Sci. Tot. Environ.* 468–469, 1225–1233. doi: 10.1016/j.scitotenv.2013.04.058 [ref 115]
- Webb, J., Sommer, S., Kupper, T., Groenestein, K., Hutchings, N., Eurich-Menden, B., et al. (2012). Emissions of ammonia, nitrous oxide and methane during the management of solid manures. *Agroecology and Strategies for Climate Change*, ed E. Lichtfouse (Springer): 67–107 [ref 116].

Sources of Further Information on Techniques used to estimate releases from Silage leachate

International

- Bernardes, T. F., Daniel, J. L. P., Adesogan, A. T., McAllister, T. A., Drouin, P., L., Nussio, G., Huhtanen, P., Tremblay, G. F., Bélanger, G. and Cai, Y. (2018). Silage review: Unique challenges of silages made in hot and cold regions. *Journal of Dairy Science* 101:4001–4019. <https://doi.org/10.3168/jds.2017-13703> [ref 48].
- Zalidis, G., Stamatiadis, S., Takavakoglou, V., Eskridge, K. and Misopolinos, N. (2002). Impacts of agricultural practices on soil and water quality in the Mediterranean region and proposed assessment methodology. *Agriculture, Ecosystems and Environment* 88: 137–146 [ref 117].

Europe

- Špulerová, J., Kruse, A., Branduini, P., Centeri, C., Eiter, S., Ferrario, V. et al. (2020). Past, Present and Future of Hay-making Structures in Europe. *Sustainability* 11, 5581. doi:10.3390/su11205581 [118].

US

- Holly, M.A., Larson, R.A., Cooley, E.T. and Wunderlin, A.M. (2018). Silage storage runoff characterization: Annual nutrient loading rate and first flush analysis of bunker silos. *Agriculture, Ecosystems & Environment* 264: 85 – 93 [ref 40].
- Mitchell, R., Bolinger, D. and Rector, N. (2002). Controlling Silage Leachate. Comprehensive Nutrient Management Plan Providers Course. url: <https://maeap.org/wp-content/uploads/2019/03/SilageLeachateManagement.pdf> [ref 119]
- US EPA (2003). National Management Measures to Control Nonpoint Source Pollution from Agriculture. Chapter 6: Monitoring and Tracking Techniques. url: <https://www.epa.gov/sites/production/files/2015-10/documents/chap6.pdf> [ref 25]

Canada

- Gebrehanna, M.M., Gordon, R.J., Madani, A., VanderZaag, A.C. and Wood, J.D. (2014). Silage effluent management: A review. *Journal of Environmental Management* 143:113–122 [ref 76].

- Bray, D. and Ward, D. (2020). Managing Silage Effluent. OMARFA Fact Sheet. #20-039| AGDEX 732/50| June 2020. url: <https://files.ontario.ca/omafra-managing-silage-effluent-20-039-en-02-07-2020.pdf> [ref 49].

Sources of Further Information on Field burning of agricultural waste (Biomass Burning)

International

- Markaki, Z., Oikonomou, K., Kocak, M., Kouvarakis, G., Chaniotaki, A., Kubilay, N., and Mihalopoulos, N. (2003). Atmospheric deposition of inorganic phosphorus in the Levantine Basin, eastern Mediterranean: spatial and temporal variability and its role in seawater productivity. *Limnology and Oceanography* 48: 1557-1568 [ref 95].
- IPCC (2019). 2019 Refinement to the 2006 IPCC Guidelines for National Greenhouse Gas Inventories. Calvo Buendia, E., Tanabe, K., Kranjc, A., Baasansuren, J., Fukuda, M., Ngarize, S., Osako, A., Pyrozhenko, Y., Shermanau, P. and Federici, S. (eds). Volume 1 General Guidance and Reporting. Chapter 3: Uncertainties. Published: IPCC, Switzerland. url: <https://www.ipcc-nggip.iges.or.jp/public/2019rf/vol1.html> [ref 102]

Europe

- EMEP/EEA (2019). EMEP/EEA air pollutant emission inventory guidebook 2019. EEA Report No 13/2019. Published 17th October 2019. <https://www.eea.europa.eu/publications/emep-eea-guidebook-2019> [ref 101].
- Webb, J., Hutchings, N. and Amon, B. (eds) (2019). 3.F Field burning of agricultural wastes. https://www.eea.europa.eu/ds_resolveuid/REO2CVQ0WT. In: EMEP/EEA (2019). Air pollutant emission inventory guidebook 2019 [ref 55].
- DEFRA (2002). Atmospheric Emissions from Small Carcass Incinerators. DEFRA / WA0806 Report. url: <https://uk-air.defra.gov.uk/assets/documents/reports/cat07/aeat-env-r-0920.pdf> [ref 54].

US

- US EPA (1999). Methods for Estimating Greenhouse Gas Emissions from Burning of Agricultural Crop Wastes, Chapter 11 from Volume VIII of EIIIP Document Series, prepared by ICF Consulting, US (United States Environmental Protection Agency, North Carolina, US). <https://p2infohouse.org/ref/17/ttn/volume08/viii11.pdf>. [ref 120]

Sources of Further Information on Techniques used to estimate emissions and releases from the use of Pesticides

International

- Larramendy, M.L. and Soloneski, S. (2019) (eds). Pesticides - Use and Misuse and their Impact in the Environment. DOI: 10.5772/intechopen.78909 [ref 62].

Europe

- European Commission (2021). EU Pesticides Database. url: https://ec.europa.eu/food/plant/pesticides/eu-pesticides-db_en [ref 60]

US

- Milton, T.D. (2020). Pesticide Rate and Dosage Calculations. University of Georgia Extension Special Bulletin 28. Georgia Pest Management Handbook—2020 Commercial Edition. url: <https://extension.uga.edu/content/dam/extension/programs-and-services/integrated-pest-management/documents/handbooks/2020-pmh-chapters/PesticideRate-Dosage.pdf> [ref 121].

References

- [1] OECD (2020). Resource Compendium of PRTR release estimation techniques, Part II: Summary of Diffuse Source Techniques, Series on Pollutant Release and Transfer Registers No. 19. ENV/JM/MONO (2020)30. Published 25th November 2020.
- [2] Drizo, A. (2019). Phosphorus Pollution Control: Policies and Strategies pp. 176. Wiley-Blackwell, October 2019. ISBN: 978-1-118-82548-8. |url: <https://www.wiley.com/en-us/Phosphorus+Pollution+Control%3A+Policies+and+Strategies-p-9781118825426>
- [3] Novotny, V. (1999). Diffuse Pollution from Agriculture – A Worldwide Outlook. Water Science and Technology 39(3): 1-13.
- [4] Novotny, V. (2005). Diffuse Pollution from Agriculture in the World. Proceedings European Commission Workshop "Where do the fertilizers go?" held in Ispra, Italy, June 28-29, 2005
- [5] UNITAR (1998). UNITAR Series of PRTR Technical Support Materials - No. 3. Guidance on Estimating Non-point Source Emissions. url: https://cwm.unitar.org/cwmplatformscms/site/assets/files/1264/prtr_tech_support_3_nov2003.pdf
- [6] OECD (2003). Resource Compendium of PRTR Release Estimation Techniques. Part 2: Summary of Diffuse Source Techniques. OECD Environment, Health and Safety Publications Series on Pollutant Release and Transfer Registers No. 6. ENV/JM/MONO (2003)14. Published 11th September 2003. url: [http://www.oecd.org/officialdocuments/publicdisplaydocumentpdf/?cote=env/jm/mono\(2003\)14&dclanguage=en](http://www.oecd.org/officialdocuments/publicdisplaydocumentpdf/?cote=env/jm/mono(2003)14&dclanguage=en)
- [7] UNFCCC (2021). Reporting requirements. url: <https://unfccc.int/process-and-meetings/transparency-and-reporting/reporting-and-review-under-the-convention/greenhouse-gas-inventories-annex-i-parties/reporting-requirements>.
- [8] UNECE (2021). Air. url: <https://unece.org/environment-policy/air>, accessed January 21st 2021.
- [9] Frelth-Larsen, A., C. Bowyer, S. Albrecht, C. Keenleyside, M. Kemper, S. Nanni, S. Naumann, R., D. Mottershead, R. Landgrebe, E. Andersen, P. Banfi, S. Bell, I. Brémere, J. Cools, S. Herbert, A. Iles, E. Kampa, M. Kettunen, Z. Lukacova, G. Moreira, Z. Kiresiewa, J. Rouillard, J. Okx, M. Pantzar, K. Paquel, R. Pederson, A. Peepson, F. Pelsy, D. Petrovic, E. Psaila, B. Šarapatka, J. Sobocka, A.-C. Stan, J. Tarpey, R. Vidaurre(2016). Updated Inventory and Assessment of Soil Protection Policy Instruments in EU Member States. Final Report to DG Environment. Berlin: Ecologic Institute. url: https://ec.europa.eu/environment/soil/pdf/Soil_inventory_report.pdf
- [10] IPCC (2019). 2019 Refinement to the 2006 IPCC Guidelines for National Greenhouse Gas Inventories. Gavrilo, O., Leip, A., Dong, H., MacDonald, J.D., Bravo, C.A.G., Amon, B., Rosales, R.B., del Prado, A., de Lima, M.A., Oyhantçabal, W., van der Weerden, T.J. and Widiawati, Y. (eds). Volume 4 General Guidance and Reporting. Chapter 10: Emissions from Livestock and Manure Management. Published: IPCC, Switzerland. url: <https://www.ipcc-nggip.iges.or.jp/public/2019rf/vol4.html>
- [11] Wolf, J., Asrar, G.R. and West, T.O. (2017). Revised methane emissions factors and spatially distributed annual carbon fluxes for global livestock. Carbon Balance Manage 12 (16). <https://doi.org/10.1186/s13021-017-0084-y>
- [12] IPCC (2006). 2006 Intergovernmental Panel on Climate Change Guidelines for National Greenhouse Gas Inventories Prepared by the National Greenhouse Gas Inventories Programme. Eggleston H.S., Buendia L., Miwa K., Ngara T. and Tanabe K. (eds). Published: IGES, Japan. <http://www.ipcc-nggip.iges.or.jp/public/2006gl/>.
- [13] European Environmental Agency (1998). [A European Inventory of Emissions to Inland Waters. A first Proposal. Technical Report No.8](#). url: <https://www.eea.europa.eu/publications/TEC08>
- [14] US EPA (2003). National Management Measures to Control Nonpoint Source Pollution from Agriculture. Chapter 7: Load Estimation Techniques. url: <https://www.epa.gov/nps/national-management-measures-control-nonpoint-source-pollution-agriculture>.

- [15] US EPA (2018). Nutrient and Sediment Estimation Tools for Watershed Protection. url: <https://www.epa.gov/sites/production/files/2018-08/documents/loadreductionmodels2018.pdf>
- [16] Roovaart, J. van den, N. van Duijnhoven, M. Knecht, J. Theloke, P. Coenen, H. ten Broeke (2013). Diffuse water emissions in E-PRTR, Project report. Report 1205118-000-ZWS-0016, Deltares.
- [17] Xiang, C., Wang, Y. and Liu, H. (2017). A scientometrics review on nonpoint source pollution research. *Ecological Engineering* 99: 400–408. DOI: 10.1016/j.ecoleng.2016.11.028
- [18] Preux, D. and Fribourg-Blanc, B. (2005). Overview of emissions to water - existing data collections. European Topic Centre on Water. url: https://unstats.un.org/unsd/environment/envpdf/pap_wasess4b1france.pdf
- [19] Withers, P.J.A., H.P. Jarvie, R.A. Hodgkinson, E.J. Palmer-Felgate, A. Bates, M. Neal, R. Howells, C.M. Withers, and H.D. Wickham (2009). Characterization of phosphorus sources in rural watersheds. *Journal of Environmental Quality* 38:1998–2011.
- [20] Sutton, M.A., Howard, C.M., Erisman, J.W., Billen, G., Bleeker, A., Grennfelt, P., van Grinsven, H. and Grizzetti, B. (2011). The European Nitrogen Assessment. Published by Cambridge University Press 2011. http://www.nine-esf.org/files/ena_doc/ENA_pdfs/ENA_c2.pdf
- [21] Arhonditsis, G., Giourga, C., Loumou, A. & Koulouri, M. (2002). Quantitative Assessment of Agricultural Runoff and Soil Erosion Using Mathematical Modeling: Applications in the Mediterranean Region. *Environmental Management* 30: 434–453. DOI: 10.1007/s00267-001-2692-1
- [22] Tao, Y., Liu, J., Guan, X., Chen, H., Ren, X., Wang, S., Ji, M. (2020). Estimation of potential agricultural non-point source pollution for Baiyangdian Basin, China, under different environment protection policies. *PLoS One* 15(9): e0239006. Published online 2020 Sep 22. doi: 10.1371/journal.pone.0239006
- [23] Malve, O., Tattari, S., Riihimäki, J., Jaakkola, E., Vob, A., Williams, R. and Bärlund, I. (2012). Estimation of diffuse pollution loads in Europe for continental scale modelling of loads and in-stream river water quality. *Hydrological Processes* 26: 2385–2394. DOI: 10.1002/hyp.9344
- [24] Richards, R.P. (1998). Estimation of Pollutant Loads in Rivers and Streams: A Guidance Document for Nonpoint Source Pollution (NPS) Programs. url: <http://abca.iwebsmart.net/downloads/Richards-1998.pdf>
- [25] US EPA (2003). National Management Measures to Control Nonpoint Source Pollution from Agriculture. Chapter 6: Monitoring and Tracking Techniques. url: <https://www.epa.gov/sites/production/files/2015-10/documents/chap6.pdf>
- [26] US EPA NRLM (2004). Risk Management Evaluation For Concentrated Animal Feeding Operations. url: https://cfpub.epa.gov/si/si_public_record_report.cfm?Lab=NRMRL&dirEntryId=85107
- [27] US Geological Survey (USGS) (2006). Ruddy, B.C., Lorenz, D.L. and Mueller, D.K. (eds). County-Level Estimates of Nutrient Inputs to the Land Surface of the Conterminous United States, 1982–2001. Scientific Investigations Report 2006-5012. <https://doi.org/10.3133/sir20065012>.
- [28] Livestock and Poultry Environmental Learning Community (LPELC) (2019). Whole Farm Nutrient Balance. Published March 5th, 2019. url: <https://lpelec.org/whole-farm-nutrient-balance/>
- [29] EuroStat (2016). Agriculture and environment – pollution risks. <https://ec.europa.eu/eurostat/statistics-explained/pdfscache/38080.pdf>
- [30] EuroStat (2017). Agri-environmental indicator - gross nitrogen balance. <https://ec.europa.eu/eurostat/statistics-explained/pdfscache/16811.pdf>
- [31] Eurostat (2020). Gross nutrient balance. Updated December 20th, 2020. url: https://ec.europa.eu/eurostat/databrowser/view/aei_pr_gnb/default/table?lang=en
- [32] Malagó, A., Bouraoui, F., Grizzetti, B. and De Roo, A. (2019). Modelling nutrient fluxes into the Mediterranean Sea. *Journal of Hydrology: Regional Studies* 22:100592: 1-18. <https://doi.org/10.1016/j.ejrh.2019.01.004>.

- [33] Kinley, R.D., Gordon, R.J., Stratton, G.W., Patterson, G.T. and Hoyle, J. (2007). Phosphorus Losses through Agricultural Tile Drainage in Nova Scotia, Canada. *Journal of Environmental Quality* 36: 469-477.
- [34] Kumar, R.R., Park, B.J. & Cho, J.Y. (2013). Application and environmental risks of livestock manure. *J Korean Soc Appl Biol Chem* 56, 497–503 (2013). <https://doi.org/10.1007/s13765-013-3184-8>
- [35] Liu, J., Kleinman, P.J.A., Aronsson, H., Flaten, D., McDowell, R.W., Bechmann, M., Beegle, D.B., Robinson, T.P., Bryant, R.B., Liu, H., Sharpley, A.N. and Veith, T.L. (2018). A review of regulations and guidelines related to winter manure application. *Ambio* 47(6): 657–670. doi: 10.1007/s13280-018-1012-4
- [36] Pornsukarom, S. and Thaku, S. (2016). Assessing the Impact of Manure Application in Commercial Swine Farms on the Transmission of Antimicrobial Resistant Salmonella in the Environment. *PLoS ONE* 11(10):e0164621. doi:10.1371/journal.pone.0164621
- [37] Rayne, N. and Aula, L. (2020). Livestock Manure and the Impacts on Soil Health: A Review. *Soil Systems* 2020, 4, 64; doi:10.3390/soilsystems4040064.
- [38] Eghball, B., Wienhold, B.J., Gilley, J.E. and Eigenberg, R.A. (2002). Mineralization of manure nutrients. *Journal of Soil Water Conservation* 57: 470-473.
- [39] Loyon, L. (2018). Overview of Animal Manure Management for Beef, Pig, and Poultry Farms in France. *Frontiers in Sustainable Food Systems* 2:36. doi: 10.3389/fsufs.2018.00036.
- [40] Holly, M.A., Larson, R.A., Cooley, E.T. and Wunderlin, A.M. (2018). Silage storage runoff characterization: Annual nutrient loading rate and first flush analysis of bunker silos. *Agriculture, Ecosystems & Environment* 264: 85 – 93.
- [41] Wright, P.E., Inglis, S.F., Goehring, L.D. (2004). Effectiveness of Silage Leachate Treatment with Vegetative Filter Areas. An ASAE/CSAE Meeting Presentation, Technical paper No. 042178. https://socwisconsin.org/wp-content/uploads/2016/05/Wrightetal_2004_SilageLeachateTrtmtVTA.pdf
- [42] Drizo, A. (2019). T1 Good Practice Tools and Guidance of Agricultural Runoff, pp. 54. url: <https://www.water-pro.eu/good-practices/>
- [43] Drizo, A. (2011). Phosphorus and E.Coli Reduction from Silage Leachate via Innovative Steel Slag Filtration. USDA Conservation Innovation Grants Program, Agreement Number: 69-3A75-9-121. Final Progress Report. Project period September 24th, 2010 - September 23rd, 2011.
- [44] Rozema, E.R., VanderZaag, A.C., Wood, J.D., Drizo, A., Zheng, Y., Madani, A. and Gordon, R. (2016). Constructed Wetlands for Agricultural Wastewater Treatment in Northeastern North America: A Review. *Water* 8(5):173. DOI: 10.3390/w8050173.
- [45] Gunes, K., Tuncsiper, B., Drizo, A., Masi, F., Ayaz, S. & Tufekci, H. (2015). Constructed and riverine wetlands design considerations for domestic and agricultural diffuse pollution treatment—a case study from Turkey. *Desalination and Water Treatment* 56 (26):11988-11998.
- [46] Carreau, R., VanAcker, S., VanderZaag, A., Madani, A., Drizo, A. and Gordon, R. (2012). Evaluation of a surface-flow constructed wetland treating abattoir wastewater. *Applied Engineering in Agriculture* 28(5): 757-766.
- [47] Bird, S. and Drizo, A. (2010). EAF Steel Slag Filters for Phosphorus Removal from Milk Parlor Effluent: The Effects of Solids Loading, Alternate Feeding Regimes, and In-Series Design. *Water* 2(3): 484-499; doi:10.3390/w2030484.
- [48] Bernardes, T. F., Daniel, J. L. P., Adesogan, A. T., McAllister, T. A., Drouin, P., L., Nussio, G., Huhtanen, P., Tremblay, G. F., Bélanger, G. and Cai, Y. (2018). Silage review: Unique challenges of silages made in hot and cold regions. *Journal of Dairy Science* 101:4001–4019. <https://doi.org/10.3168/jds.2017-13703>.
- [49] Bray, D. and Ward, D. (2020). Managing Silage Effluent. OMARFA Fact Sheet. #20-039| AGDEX 732/50| June 2020. url: <https://files.ontario.ca/omafra-managing-silage-effluent-20-039-en-02-07-2020.pdf>

- [50] Morin, J. (1993). Chapter 4: Rainfall analyses for tillage management decisions. In FAO: Soil tillage in Africa: needs and challenges. Land and Water Division. Serial Title: FAO Soils Bulletin. Series number: 0253-2050. url: http://www.fao.org/3/t1696e/t1696e05.htm#P27_1168
- [51] Ohana-Levi, N., Karnieli, A., Egozi, R., Givati, A. and Peeters, A. (2015). Modeling the Effects of Land-Cover Change on Rainfall-Runoff Relationships in a Semiarid, Eastern Mediterranean Watershed. *Advances in Meteorology* 2015, Article ID 838070, 16 pages. <http://dx.doi.org/10.1155/2015/838070>
- [52] Gwyther, C.L., Williams, A.P., Golyshin, P.N., Edwards-Jones, G. and Jones, D.L. (2011). The environmental and biosecurity characteristics of livestock carcass disposal methods: A review. *Waste Management* 31(4):767-778. doi: 10.1016/j.wasman.2010.12.005.
- [53] UNEP (2008). Best Available Techniques and Provisional Guidance on Best Environmental Practices relevant to Article 5 and Annex C of the Stockholm Convention on Persistent Organic Pollutants. 686 pp. Section VI.I.: Destruction of animal carcasses. <http://chm.pops.int/SearchResults/tabid/37/Default.aspx?Search=UNEP+POPs>
- [54] DEFRA (2002). Atmospheric Emissions from Small Carcass Incinerators. DEFRA / WA0806 Report. url: <https://uk-air.defra.gov.uk/assets/documents/reports/cat07/aeat-env-r-0920.pdf>
- [55] Webb, J., Hutchings, N. and Amon, B. (eds) (2019). 3.F Field burning of agricultural wastes. https://www.eea.europa.eu/ds_resolveuid/REO2CVQ0WT. In: EMEP/EEA (2019). Air pollutant emission inventory guidebook 2019.
- [56] Sundarambal, P., Balasubramanian, R., Tklich, P., and He, J. (2010). Impact of biomass burning on ocean water quality in Southeast Asia through atmospheric deposition: field observations. *Atmospheric Chemistry and Physics* 10: 11323–11336, www.atmos-chem-phys.net/10/11323/2010/. doi:10.5194/acp-10-11323-2010.
- [57] Blake, T.W. and Downing, J.A. (2009). Measuring atmospheric nutrient deposition to inland waters: Evaluation of direct methods. *Limnology and Oceanography: Methods* 7:638–647. url: <https://aslopubs.onlinelibrary.wiley.com/doi/pdf/10.4319/lom.2009.7.638>.
- [58] Grizzetti, B., Bouraoui, F., de Marsily, G. and Bidoglio, G. (2002). A statistical method for source apportionment of riverine nitrogen loads. *Journal of Hydrology* 304: 302-315, 10.1016/j.jhydrol.2004.07.036
- [59] Grizzetti, B., Bouraoui, F. and Aloe, A. (2012). Changes of nitrogen and phosphorus loads to European seas. *Global Change Biology* 18 (2): 769-782.
- [60] European Commission (2021). EU Pesticides Database. url: https://ec.europa.eu/food/plant/pesticides/eu-pesticides-db_en, accessed 29th January, 2021.
- [61] Safe Drinking Water Foundation (SDWF) (2021). Pesticides and Water Pollution. url: <https://www.safewater.org/fact-sheets-1/2017/1/23/pesticides>
- [62] Pérez-Lucas, G., Vela, N., El Aatik, A. and Navarro, S. (2018). Environmental Risk of Groundwater Pollution by Pesticide Leaching through the Soil Profile. DOI: 10.5772/intechopen.82418. In: Larramendy, M.L. and Soloneski, S. (2019) (eds). *Pesticides - Use and Misuse and their Impact in the Environment*. DOI: 10.5772/intechopen.78909.
- [63] OECD (2000). Guidelines for Testing of Chemicals No 106. Adsorption-Desorption using a Batch Equilibrium Method. Paris: Organization for Economic Cooperation and Development (OECD). url: https://www.oecd-ilibrary.org/environment/test-no-106-adsorption-desorption-using-a-batch-equilibrium-method_9789264069602-en
- [64] OECD (2002). Guidelines for Testing of Chemicals No 307. Aerobic and Anaerobic Transformation in Soil. Paris: OECD. url: https://www.oecd-ilibrary.org/environment/test-no-307-aerobic-and-anaerobic-transformation-in-soil_9789264070509-en
- [65] OECD (2007). Guidelines for Testing of Chemicals No 312. Leaching in Soil Columns. Paris: OECD. url: https://www.oecd-ilibrary.org/environment/test-no-312-leaching-in-soil-columns_9789264070561-en

- [66] Climate Clean Air Coalition (CCAC) (2021). Enteric Fermentation. url: <https://www.ccaoalition.org/en/activity/enteric-fermentation>, accessed 17th January 2021.
- [67] Thorpe, A. (2009). Enteric fermentation and ruminant eructation: the role (and control?) of methane in the climate change debate. *Climatic Change* 93: 407–431. url: <https://doi.org/10.1007/s10584-008-9506-x>
- [68] Gibbs, M.J., Conneely, D., Johnson, D., Lasse, K.R. and Ulyatt, M.J. (2001). CH₄ Emissions from Enteric Fermentation. In: Intergovernmental Panel on Climate Change (IPCC). Good Practice Guidance and Uncertainty Management in National Greenhouse Gas Inventories. Chapter 4, Agriculture. url: https://www.ipcc-nggip.iges.or.jp/public/gp/english/4_Agriculture.pdf
- [69] Moss AR, Jouany J-P, Newbold J (2000). Methane production by ruminants: its contribution to global warming. *Annales de zootechnie, INRA/EDP Sciences*, 49 (3): 231 – 253. Doi: 10.1051/animres:2000119. hal-00889894.
- [70] Chadwick, D., Sommer, S., Thorman, R., Fanguero, D., Cardenas, L., Amon, B., Misselbrook, T. (2011). Manure management: Implications for greenhouse gas emissions. *Animal Feed Science and Technology* 166: 514–531. <https://doi.org/10.1016/j.anifeeds.2011.04.036>.
- [71] Petersen, S. O. (2018). Symposium review: Greenhouse gas emissions from liquid dairy manure: Prediction and mitigation. *Journal of Dairy Science* 101:6642–6654. <https://doi.org/10.3168/jds.2017-13301>.
- [72] Ribaud, M., Gollehon, N., Aillery, M., Kaplan, J., Johansson, R., Agapoff, J., Christensen, L., Breneman, V. and Peters, M. (2003). Manure Management for Water Quality: Costs to Animal Feeding Operations of Applying Manure Nutrients to Land. Agricultural Economic Report No. (AER-824) 97 pp. url: <https://www.ers.usda.gov/publications/pub-details/?pubid=41587>.
- [73] FAO (2006). Livestock’s Long Shadow. Environmental issues and options. 416 pp. url: <http://www.fao.org/3/a0701e/a0701e00.htm>
- [74] FAO and IWMI (2017). Water pollution from agriculture: a global review. <http://www.fao.org/3/a-i7754e.pdf>
- [75] Ongley, E.D. (1996). Control of water pollution from agriculture - FAO irrigation and drainage paper 55. <http://www.fao.org/3/w2598e/w2598e00.htm>.
- [76] Gebrehanna, M.M., Gordon, R.J., Madani, A., VanderZaag, A.C. and Wood, J.D. (2014). Silage effluent management: A review. *Journal of Environmental Management* 143:113-122.
- [77] McDonald, P.N., Henderson, N., Heron, S. (1991). *The Biochemistry of Silage*, second ed. Chalcombe Publications, UK.
- [78] Anon (2002). The Animal By-Products Regulations (EC) No. 1774/2002. European Commission, Brussels.
- [79] Anon (2007). Disposal of dead livestock, No. 16–25. Washington State Legislature, Washington.
- [80] Groff, K., Bachli, E., Lansdowne, M. and Capaldo, T. (2014). Review of Evidence of Environmental Impacts of Animal Research and Testing. *Environments* 1: 14-30. doi:10.3390/environments1010014.
- [81] Hart, M.R., Quin, B.F. and Nguyen, M.L. (2004). Phosphorus Runoff from Agricultural Land and Direct Fertilizer Effects: A Review. *Journal of Environmental Quality* 33: 1954 – 1972.
- [82] FAO (1996). Control of water pollution from agriculture - FAO irrigation and drainage paper 55. Chapter 3: Chapter 3: Fertilizers as water pollutants. url: <http://www.fao.org/3/w2598e/w2598e00.htm#Contents>.
- [83] World Bank (2021). Agricultural land (sq. km). url: <https://data.worldbank.org/indicator/AG.LND.AGRI.K2>, accessed 19 January, 2021.
- [84] Cassou, E. (2018). Pesticides. Agricultural Pollution. World Bank, Washington, DC. <https://openknowledge.worldbank.org/handle/10986/29507> License: CC BY 3.0 IGO.

- [85] FAO (1996). Control of water pollution from agriculture - FAO irrigation and drainage paper 55. Chapter 3: Chapter 4: Pesticides as water pollutants. url: <http://www.fao.org/3/w2598e/w2598e07.htm#TopOfPage>
- [86] Pimentel, D., & Edwards, C. (1982). Pesticides and Ecosystems. *BioScience*, 32(7), 595-600. doi:10.2307/1308603
- [87] Chen, J., Li, C., Ristovski, Z., Milic, A., Gu, Y., Islam M.S. et al (2017). A review of biomass burning: Emissions and impacts on air quality, health and climate in China. *Science of The Total Environment* 579:1000-1034. url: <https://doi.org/10.1016/j.scitotenv.2016.11.025>
- [88] Koppmann, R., von Czapiewski, K., and Reid, J. S. (2005). A review of biomass burning emissions, part I: gaseous emissions of carbon monoxide, methane, volatile organic compounds, and nitrogen containing compounds. *Atmospheric Chemistry and Physics Discussions, European Geosciences Union* 5 (5):10455-10516. hal-00301877. url: <https://hal.archives-ouvertes.fr/hal-00301877/document>
- [89] Reid, J. S., Koppmann, R., Eck, T. F., and Eleuterio, D. P.(2005). A review of biomass burning emissions part II: intensive physical properties of biomass burning particles. *Atmospheric Chemistry and Physics* 5: 799-825. url: <https://acp.copernicus.org/articles/5/799/2005/acp-5-799-2005.pdf>
- [90] Reid, J. S., Eck, T. F., Christopher, S. A., Koppmann, R., Dubovik, O., Eleuterio, D. P., Holben, B. N., Reid, E. A., and Zhang, J. (2005). A review of biomass burning emissions part III: intensive optical properties of biomass burning particles. *Atmospheric Chemistry and Physics Discussions* 5: 827–849. url: <https://doi.org/10.5194/acp-5-827-2005>, 2005.
- [91] Reche C, Viana M, Amato F, Alastuey A, Moreno T, Hillamo R, Teinilä K, Saarnio K, Seco R, Peñuelas J, Mohr C, Prévôt AS, Querol X. (2012). Biomass burning contributions to urban aerosols in a coastal Mediterranean city. *Science of Total Environment* 427-428:175-90. doi: 10.1016/j.scitotenv.2012.04.012. Epub 2012 May 1. PMID: 22554530.
- [92] E. Bossioli, M. Tombrou, J. Kalogiros, J. Allan, A. Bacak, S. Bezantakos, G. Biskos, H. Coe, B.T. Jones, G. Kouvarakis, N. Mihalopoulos, C.J. Percival. (2016). Atmospheric composition in the Eastern Mediterranean: Influence of biomass burning during summertime using the WRF-Chem model. *Atmospheric Environment* 132: 317-331. <url:https://doi.org/10.1016/j.atmosenv.2016.03.011>.
- [93] Suman D.O. (1996) Biomass Burning in North Africa and Its Possible Relationship to Climate Change in the Mediterranean Basin. In: Guerzoni S., Chester R. (eds) *The Impact of Desert Dust Across the Mediterranean*. Environmental Science and Technology Library, vol 11. Springer, Dordrecht. https://doi.org/10.1007/978-94-017-3354-0_11
- [94] Brocchi, V., Krysztofiak, G., Catoire, V., Zbinden, R., Guth, J., ElAmraoui, L., Piguet, B., Dulac, F., Hamonou, E. and Ricaud, P. (2017). Impact of the intercontinental transport of biomass burning pollutants on the Mediterranean Basin during the CHARMEX-GLAM airborne campaign. *Geophysical Research Abstracts* 19, EGU2017-8053, 2017EGU General Assembly 2017.
- [95] Markaki, Z., Oikonomou, K., Kocak, M., Kouvarakis, G., Chaniotaki, A., Kubilay, N., and Mihalopoulos, N. (2003). Atmospheric deposition of inorganic phosphorus in the Levantine Basin, eastern Mediterranean: spatial and temporal variability and its role in seawater productivity. *Limnology and Oceanography* 48: 1557-1568.
- [96] Economopoulos, Alexander P & World Health Organization (1993). Prevention of Environmental Pollution Unit. Assessment of sources of air, water, and land pollution: a guide to rapid source inventory techniques and their use in formulating environmental control strategies. url: <https://apps.who.int/iris/handle/10665/58750>
- [97] Environment Australia (1999). Emission Estimation Technique Manual for Aggregated Emissions from Domestic Lawn Mowing. url: <http://www.npi.gov.au/resource/emission-estimation-technique-manual-aggregated-emissions-domestic-lawn-mowing>

- [98] Wierl, J.A., Rappold, K.F. and Amerson, F.U. (1996). Summary of the Land-Use Inventory for the Non-Point Source Evaluation Monitoring Watersheds in Wisconsin. U.S. Geological Survey Open-File Report 96-123. url: <https://doi.org/10.3133/ofr96123>
- [99] Lokupitiya, P. and Paustian, K. (2006). Agricultural Soil Greenhouse Gas Emissions: A Review of National Inventory Methods. *Journal of Environmental Quality* 35:1413–1427.
- [100] European Commission (2016). Soil Threats in Europe. JRC Technical Report. url: https://esdac.jrc.ec.europa.eu/public_path/shared_folder/doc_pub/EUR27607.pdf
- [101] EMEP/EEA (2019). EMEP/EEA air pollutant emission inventory guidebook 2019. EEA Report No 13/2019. Published 17th October 2019. <https://www.eea.europa.eu/publications/emep-eea-guidebook-2019>
- [102] IPCC (2019). 2019 Refinement to the 2006 IPCC Guidelines for National Greenhouse Gas Inventories.
- Calvo Buendia, E., Tanabe, K., Kranjc, A., Baasansuren, J., Fukuda, M., Ngarize, S., Osako, A., Pyrozhenko, Y., Shermanau, P. and Federici, S. (eds). Volume 1 General Guidance and Reporting. Chapter 3: Uncertainties. Published: IPCC, Switzerland. url: <https://www.ipcc-nggip.iges.or.jp/public/2019rf/vol1.html>
- [103] IPCC (2019). 2019 Refinement to the 2006 IPCC Guidelines for National Greenhouse Gas Inventories. Calvo Buendia, E., Tanabe, K., Kranjc, A., Baasansuren, J., Fukuda, M., Ngarize, S., Osako, A., Pyrozhenko, Y., Shermanau, P. and Federici, S. (eds). Volume 1 General Guidance and Reporting. Chapter 6: Quality Assurance/Quality Control and Verification. Published: IPCC, Switzerland. url: <https://www.ipcc-nggip.iges.or.jp/public/2019rf/vol1.html>
- [104] Basarab, J.A., Okine, E.K., Baron, V.S., Marx, T.H., Ramsey, P., Ziegler, K., and Lyle, K.L. (2005). Methane emissions from enteric fermentation in Alberta's beef cattle population: A model methodology for Canada. *Canadian Journal of Animal Science*, 85(4), pp. 501-512.
- [105] Karimi-Zindashty, Y., MacDonald, J.D., Desjardins, R.L., Worth, D.E., Hutchinson, J.J., and Vergé, X.P.C. (2012). "Sources of uncertainty in the IPCC Tier 2 Canadian livestock model.", *Journal of Agricultural Science*, 150(5), pp. 556-569. Doi : 10.1017/s002185961100092x.
- [106] Lines-Kelly, R. (2014). Enteric methane research: A summary of current knowledge and research. Published by the New South Wales Department of Primary Industries. url: https://www.dpi.nsw.gov.au/_data/assets/pdf_file/0011/532694/ag-resources-climate-enteric-methane.pdf
- [107] Córdor, R.D, Valli, L., De Rosa, G., Di Francia, A. and De Lauretis, R. (2008). Estimation of the methane emission factor for the Italian Mediterranean buffalo. *Animal* 2(8):1247-1253. <https://doi.org/10.1017/S1751731108002292>
- [108] Ammar, H., Abidi, S., Ayed, M., Moujahed, N., deHaro Martí, M.E., Chahine, M., Bouraoui, R., López, S., Cheikh M'hamed, H. and Hechlef, H. (2020). Estimation of Tunisian Greenhouse Gas Emissions from Different Livestock Species1. *Agriculture* 10: 562-579. doi:10.3390/agriculture10110562.
- [109] Ibidhi, R., & Calsamiglia, S. (2020). Carbon Footprint Assessment of Spanish Dairy Cattle Farms: Effectiveness of Dietary and Farm Management Practices as a Mitigation Strategy. *Animals: an open access journal from MDPI*, 10(11), 2083. <https://doi.org/10.3390/ani10112083>
- [110] Koch, J., Dayan, U. and Mey-Marom, A. (2000). Inventory of Greenhouse Gaseous Emissions Israel. *Water Air and Soil Pollution* 123(1):259-271. DOI: 10.1023/A:1005271424293
- [111] Ersoy E, Ugurlu A. The potential of Turkey's province-based livestock sector to mitigate GHG emissions through biogas production. *Journal of Environmental Management*. 2020 Feb;255:109858. DOI: 10.1016/j.jenvman.2019.109858.
- [112] Grossi, G., Vitali, A., Lacetera, N., Danieli, P. P., Bernabucci, U., & Nardone, A. (2020). Carbon Footprint of Mediterranean Pasture-Based Native Beef: Effects of Agronomic Practices and Pasture Management under Different Climate Change Scenarios. *Animals: an open access journal from MDPI*, 10(3), 415. <https://doi.org/10.3390/ani10030415>

- [113] Boezeman, D., Wiering, M. and Crabbé, A. (2020). Agricultural Diffuse Pollution and the EU Water Framework Directive: Problems and Progress in Governance. Editorial to the MDPI Special Issue “Water Quality and Agricultural Diffuse Pollution in Light of the EU Water Framework Directive”. *Water* 12 2590: doi:10.3390/w12092590
- [114] Loyon, L. (2018). Overview of Animal Manure Management for Beef, Pig, and Poultry Farms in France. *Frontiers in Sustainable Food Systems* 2:36. doi: 10.3389/fsufs.2018.00036
- [115] Velthof, G. L., Lesschen, J. P., Webb, J., Pietrzak, S., Miatkowski, Z., Pinto, M., et al. (2014). The impact of the Nitrates Directive on nitrogen emissions from agriculture in the EU-27 during 2000–2008. *Sci. Tot. Environ.* 468–469, 1225–1233. doi: 10.1016/j.scitotenv.2013.04.058
- [116] Webb, J., Sommer, S., Kupper, T., Groenestein, K., Hutchings, N., Eurich-Menden, B., et al. (2012). Emissions of ammonia, nitrous oxide and methane during the management of solid manures. *Agroecology and Strategies for Climate Change*, ed E. Lichtfouse (Springer): 67–107.
- [117] Zalidis, G., Stamatiadis, S., Takavakoglou, V., Eskridge, K. and Misopolinos, N. (2002). Impacts of agricultural practices on soil and water quality in the Mediterranean region and proposed assessment methodology. *Agriculture, Ecosystems and Environment* 88: 137–146.
- [118] Špulerová, J., Kruse, A., Branduini, P., Centeri, C., Eiter, S., Ferrario, V. et al. (2020). Past, Present and Future of Hay-making Structures in Europe. *Sustainability* 11, 5581. doi:10.3390/su11205581.
- [119] Mitchell, R., Bolinger, D. and Rector, N. (2002). Controlling Silage Leachate. *Comprehensive Nutrient Management Plan Providers Course*. url: <https://maeap.org/wp-content/uploads/2019/03/SilageLeachateManagement.pdf>
- [120] US EPA (1999). Methods for Estimating Greenhouse Gas Emissions from Burning of Agricultural Crop Wastes, Chapter 11 from Volume VIII of EIIP Document Series, prepared by ICF Consulting, US (United States Environmental Protection Agency, North Carolina, US). <https://p2infohouse.org/ref/17/ttn/volume08/viii11.pdf>
- [121] Milton, T.D. (2020). Pesticide Rate and Dosage Calculations. University of Georgia Extension Special Bulletin 28. *Georgia Pest Management Handbook—2020 Commercial Edition*. url: <https://extension.uga.edu/content/dam/extension/programs-and-services/integrated-pest-management/documents/handbooks/2020-pmh-chapters/PesticideRate-Dosage.pdf>

Appendix 31

Guideline on estimation techniques and applied methodologies for point source releases from aquaculture

1. Introduction

1. Following the 21st Meeting of the Contracting Parties to the Barcelona Convention COP21 (held in Napoli, Italy, 2-5 December 2019)¹ and the adoption of Decision IG.24/14,² the Programme of Work mandated the MED POL Programme to develop/update technical guidelines addressing estimation techniques of pollutant releases agriculture, catchments runoff and aquaculture.

2. To achieve this mandate, this guidance document on estimation techniques and applied methodologies for point source releases from aquaculture was developed. It elaborates on estimating point source releases to water from activities classified under the **aquacultural sector** including, but not limited to, releases of pollutants listed in Annex I to the LBS Protocol.

3. In particular, focus is made in this document on:

- a. Releases of total nitrogen, total phosphorus, copper and its compounds, zinc and its compounds and Total Organic Carbon (TOC), in the aquaculture sector;
- b. Release estimation methods and techniques to assess the aforementioned pollutants loads from the aquaculture sector.

4. Moreover, this guidance document provides information on the current status of aquaculture (including both inland and mariculture), in particular with respect to fish feed practices and industry (Annex I), as well as an overview of approaches for estimation techniques of pollutants' releases from the aquaculture sector, including accuracy and uncertainty of the estimation methods, and aspects related to quality control/quality assurance relevant to inventories of pollutants releases/discharges from aquaculture production and fish farming activities (Annex II). Finally, additional issues of concern were also evaluated in Annex III, where some POPs and Pesticides could enter, unintentionally, via fish feed to the marine environment.

5. The methodology used for developing this document comprised of several steps:

- a. An extensive literature review (Annex I-III) focusing on:
 - i. Current status of aquaculture sector (including both inland and mariculture), in particular with respect to fish feed practices and their adverse impacts on the environment.
 - ii. Pollutants releases and discharges to water as well as issues related to pollution loading of total nitrogen, total phosphorus, copper and its compounds, zinc and its compounds and Total Organic Carbon (TOC) from aquaculture production facilities and related estimation techniques as well as potential unintentional releases of pesticides and POPs;
 - iii. Technical reports, documents and peer reviewed research papers describing different approaches, methods and techniques recommended for estimations of the above pollutants' releases to water from aquaculture sector.
 - iv. Potential issues and drawbacks regarding accuracy and uncertainty associated with the proposed calculation methods, techniques and approaches.

Although the review was conducted on a global scale, the main focus was on the Mediterranean region. Relevant studies included available information from Europe, as well as from the USA, Canada, Australia and Asia.

¹ <https://www.unenvironment.org/unepmap/events/meeting/21st-meeting-contracting-parties-convention-protection-marine-environment-and>

² https://wedocs.unep.org/bitstream/handle/20.500.11822/31712/19ig24_22_2414_eng.pdf

- b. Elaborating streamlined methodologies and most appropriate techniques to estimate releases of nutrients; copper and its compounds; zinc and its compounds; TOC releases from aquaculture activities.
- c. Integrating available information and developing the guidance document for the methods and techniques to assist Contracting Parties to estimate releases of the pollutants and their discharges to water from the sector.

6. It is expected that the newly proposed techniques for estimation of pollution loads to water will enable the generation of compatible data to evaluate the effectiveness of adopted measures in the National Action Plans and the Regional Plan for Aquaculture Management in the Mediterranean.

2. Legal basis of the NBB guidance document for the Aquaculture sector

7. The Protocol for the Protection of the Mediterranean Sea against Pollution from Land-Based Sources and Activities (the LBS Protocol) is one of the six Barcelona Convention Protocols. It was adopted on 17th May 1980 by the Conference of Plenipotentiaries of the Coastal States of the Mediterranean Region and entered into force on 17th June 1983.³ This original Protocol was modified by amendments adopted on 7th March 1996 (UNEP(OCA)/MED IG.7/4)⁴ and recorded as the “Protocol for the Protection of the Mediterranean Sea against Pollution from Land-Based Sources and Activities”. It entered into force on 18th May 2006.⁵

8. The LBS Protocol requires the Contracting Parties to submit reports which shall include inter alia: (i) data resulting from monitoring and (ii) quantities of pollutants discharged from their territories (Article 13, para 2).⁶ For this purpose, the National Baseline Budget of pollutants (NBB) was agreed by the Contracting Parties as “the monitoring tool” to track progress, on a five-yearly basis, of discharged loads of pollutants reflecting the effectiveness of measures taken to reduce and prevent pollution from LBS.

9. To assist the Countries in this mandate, updated NBB guidelines were developed in 2015 (UNEP(DEPI)/MED WG.404/7 Annex IV, Appendix B, Page 11).⁷ However, these guidelines do not offer means by which pollutants from aquaculture can be estimated. Furthermore, current Inventories of Pollutant Release and Transfer Registers (PRTR) estimation techniques do not provide any information on releases from aquaculture. This point was discussed at the Regional Meeting on Reporting of Releases to Marine and Coastal Environment from Land Based Sources and Activities and Related Indicators, which was held in Tirana, Albania on 19-20 March 2019.⁸ Therefore, the recommendation was made to support the Contracting Parties to complement the National Baseline Budget/Pollution Release and Transfer Registers (NBB/PRTRs) methodology with estimation techniques for point sources related to the aquaculture sector (UNEP/MED WG.462/8).

3. Pollutants Releases and Discharges from Aquaculture

10. The principal pathways of contaminants which are discharged from aquaculture production activities are feed, chemicals used in the form of medications, disinfectants and antifoulants, and fish faecal material. While being a crucial factor of production in aquaculture, feed has been reported to be the major source of pollution in aquaculture systems [1-7]. The effect of waste production and pollution caused by fish feed varies with the amount of supplemental feed. It is dependent on a number

³ <https://www.informea.org/en/treaties/land-based-sources-protocol>

⁴ <https://wedocs.unep.org/handle/20.500.11822/3016>

⁵ https://wedocs.unep.org/bitstream/handle/20.500.11822/7096/Consolidated_LBS96_ENG.pdf?sequence=5&isAllowed=y

⁶ https://wedocs.unep.org/bitstream/handle/20.500.11822/3016/96ig7_4_lbsprotocol_eng.pdf?sequence=1&isAllowed=y

⁷ https://wedocs.unep.org/bitstream/handle/20.500.11822/5481/1/15wg417_inf6_eng.pdf

⁸ file:///C:/Users/aleks/AppData/Local/Temp/19wg462_08_Meeting%20Report.pdf

of factors including feed nutrient composition, method of production (extruded vs pelleted), ratio of feed size to fish size, quantity of feed per unit time, feeding method, and storage time [1][7].

3.1 Aquafeed Production

11. Feed types can be divided into three groups: i) industrially compounded feeds (ICF), ii) farm-made feeds (FMF) and iii) raw organisms (RO). Between 1995 and 2007, total industrial compound aquafeed production increased 3.5-fold, from 7.6 million tons (1995) to 27.1 million tons (2007), with production growing at an average annual rate of 11.1 percent [4]. In 2015, the total use of ICF in the production of major species was estimated at 39.62 million tons [8], the use of farm-made aqua feeds between 15 and 30 million tons, and direct use of raw organisms, mostly trash fish, was estimated to be between 3 and 6 million tons [1][8].

12. Fish species and shrimp diets need to contain approximately forty essential nutrients such as amino acids, vitamins, minerals, and fatty acids [1] [9-11-36]. These are provided in the feed through a number of ingredients including fishmeal, fish oil, plants, and animal trimmings. The feed is usually in the form of dried pellets.⁹ The exact diet differs per fish type and species. Schalekamp et al. [1] and Tacon et al. [3][12] provide a detailed overview of feed ingredients and composition for different fish types. For fed aquaculture species, the ingredients can be roughly divided into two categories: marine resources and terrestrial resources. Marine resources mainly consist of fishmeal and fish oil, whose production is depended on wild fisheries, and therefore limited [1] [9-11]. Tacon et al [5] reported that total usage of terrestrial animal by-product meals and oils within compound aquafeeds ranged between 0.15 and 0.30 million tons, e.g., less than 1 percent of total global compound aquafeed production. The key terrestrial resources for feed include soybeans, maize and rice [8-10]. Soybean meal is the most common source of plant proteins used representing about 25% total compound aquafeeds by weight [5]. Alternative lipid sources to fish oil are also being used in greater amounts with key substitutes including vegetable oils, preferably those with high omega-3 contents (e.g., farmed fish offal), and poultry oil [5].

13. To ensure the dietary nutrients are ingested, digested, absorbed, and transported to the cells, an increasing diversity of non-nutritive feed additives are being used in aquatic feeds [1] [10-12]. The range of feed additives used in aquatic feeds is diverse [13]. For example, some target the feed quality, including pellet binders, antioxidants, and feed preservatives (anti mold and antimicrobial compounds). Enzymes are used to improve the availability of certain nutrients (proteases, amylases) or to eliminate the presence of certain antinutrients (phytase, non-starch polysaccharides (NSP) enzymes). Other additives are used to improve the animals' performance and health including probiotics, prebiotics, immune-stimulants, phytogetic substances, and organic acids [13].

3.2 Adverse effects on the environment from potential releases of nutrients, copper and zinc and their compounds and organic carbon from aquaculture production facilities

14. Aquaculture production uses many resources including land, water, feed, fertilizer, energy, capital and labour, and affects ecosystems through the release or extraction of nutrients, chemical and microbial pollutants, the introduction of foreign species, the use of disinfectants and antibiotics, and the alteration of water flows [10] [14-20]. These adverse effects on the environment depend upon different factors such as type of aquaculture method used, geographical location, and produced species, including feeds offered, chemicals, excretions, dead animals, and the interactions between cultured and wild animals [18]. The accumulation of waste food and fish faecal material results in discharges of nutrients, chemical and microbial pollutants, immune-stimulants, and changes in the sediment under fish cages. Although significant environmental impacts have been reported in the

⁹ <https://www.fisheries.noaa.gov/insight/feeds-aquaculture>

literature at distances of up to 100 m from the cages, generally such impacts are localized within 20 to 50 m around the cages [14].

15. Aquaculture facilities may affect water quality by altering turbidity, pH (particularly in fresh water), an increase of nutrients concentration and primary production resulting in eutrophication and harmful algal blooms, decrease of dissolved oxygen (DO) concentrations [17-21] and toxicity [18] [24-30].

16. The use of pesticides in fish feed, in particular farmed salmon has caused an increased concern regarding their potential effects on human health in recent years [24-25] [28-32].

17. It has been reported that the escape of cultured organisms (or their reproductive cells) can influence wild populations by cross or hybridisation, depredation, competition, habitat destruction, or disease spread [18]. Shrimp farming has caused considerable destruction and loss of mangrove forests in East and South East Asia, Mexico and Brazil [33-34].

Nutrients (total N and total P)

18. The main pathways of nutrients release from aquaculture production facilities are via non-consumed feed (especially due to overfeeding), decomposition of died organisms, overfertilization and faecal material [34-41]. In inland feed-based aquaculture ponds, 60% to 80% of the nitrogen (N) in the protein of feeds enters the water as uneaten feed and feces or is excreted as ammonia nitrogen (NH₃-N) by aquatic animals [37-39]. To prevent ammonium toxicity, rainbow trout farms need large quantities of water, typically 86,000 m³/ton of trout produced and are therefore responsible for considerable ammonium discharges into rivers [39-41]. Although phosphorus (P) concentration in trout farm effluents is low (total P of 0.30 mg P/L), due to the quantities of water used, its overall mass loading is very high, and can trigger and cause eutrophication [42-43].

19. Coastal and marine aquaculture are also significant contributor to nutrient enrichment. For example, it had been reported that for a world annual shrimp production around 5 million tons, 5.5 million tons of organic matter, 360,000 tons of nitrogen, and 125,000 tons of phosphorous annually are discharged to the environment [37]. The increasing production of nitrogenous metabolites especially ammonia, is of a great concern because it is highly toxic in its unionized form (NH₃) for many aquatic organisms [37-38][44]. Bowman et al. [45] recently reported that release of dissolved and particulate nutrients by intensive mariculture results in increasing nutrient loads (finfish and crustaceans), and changes in nutrient stoichiometry (all mariculture types). The authors pointed out that mariculture represents a significant and expanding cause of coastal nutrient enrichment and projected that nutrients from mariculture will increase up to six-fold by 2050 with exceedance of the nutrient assimilative capacity in parts of the world exhibiting rapid mariculture growth [45]. They also highlighted the fact that increasing nutrient loads may promote an increase in harmful algal blooms (HABs) either directly or via stimulation of algae on which mixotrophic HABs may feed. HABs can kill or intoxicate the mariculture product with severe economic losses and can increase risks to human health [45-46][43].

Copper and its compounds

20. Copper and its compounds can enter the marine environment in several ways including: uneaten food and food additives [47-50], leaching from biocidal coating application on the submerged structures and net-cages commonly used in aquaculture production facilities [51-53] and farmed fish faecal waste [47][51]. The toxicity of a metal in the marine environment is mostly determined by its chemical form and whether it is bioavailable (i.e. in a form that an organism can directly absorb or ingest). The more toxic, and thus bioavailable, state is the free ionic or dissolved form. Clement et al. [52] provide a thorough review of ecological relevance of copper (Cu) and zinc (Zn) in sediments.

21. Applying a biocidal coating on the submerged structures and net-cages to prevent and reduce biofouling is commonly used practice in aquaculture. Anti-fouling paints are mostly based on Cu, usually in the form of copper oxide and consequently the sediment close to the fish farms have been found to exhibit high copper levels, often exceeding the recommended sediment quality guidelines

[47-48][51][53]. For example, Dean et al. [48] reported that 19 of the 25 anti-foulant products licensed for use in Scottish aquaculture have copper as the active ingredient (e.g. cuprous oxide (Cu₂O), copper thiocyanate (CuSCN) and copper sulphate (CuSO₄)), with some also containing zinc. The authors also highlighted that anti-foulants may provide a significant source of Cu, and possibly Zn, to the marine environment, since the active metal can be released in soluble or particulate form, either washed from treated nets or chipped from painted hard structures [48]. The extensive use of anti-fouling biocides is also considered a potential source of metal accumulation in cultured fish, which have been associated to lethal or sub-lethal effects and the immediate immune defense mechanism of the exposed fish [54].

Zinc and its compounds

22. Pathways for Zn and its compounds to the marine environment are the same as for Cu, e.g. uneaten food and food additives, leaching from biocidal coating application on the submerged structures and net-cages commonly used in aquaculture production facilities, and farmed fish faecal waste [47-54].

23. Zinc pyrithione (ZnPT) and Zineb are most commonly used Zn biocides in antifouling paints [55-56]. Soon et al. [56] recently provided a comprehensive review of the ZnPT use in marine environments, their toxicity and environmental fate. They highlighted that once ZnPT is released into the marine environment, it can easily be transchelated into other metal pyrithiones by releasing the zinc ion in the complex and absorbing other free metal ions in seawater.

24. Guardiola et al [55] highlighted that despite the beneficial effects of the chemicals to aquaculture, the use of biocides may also cause potential harm to aquatic organisms and even to humans. The authors underlined two types of risks associated with the use of biocides in aquaculture: (i) predators and humans may ingest the fish and shellfish that have accumulated in these contaminants and (ii) the development of antibiotic resistance in bacteria. Ingestion of the contaminated fish and shellfish can pose a great risk to human health [57-58]. The conditions and locations of the aquaculture farms play a significant role on the spread of these chemicals and heavy metals into the environment [58].

Total Organic Carbon (as Total C or COD)

25. The contribution of primary production to carbon loading in fed aquaculture, carbon accumulation and subsequent benthic deterioration under fish farms has been investigated by several researchers [4][17][22][37][57-62]. As a major element of organic matter, dissolved organic carbon (DOC) plays an important role in the carbon cycle and microbial loop in the marine environment and has been extensively studied over the past few decades [61-62]. The principal pathways for transfer of organic matter through seawater include dissolution of fecal pellets, excess feeding, breaking down of the cells and bacterial activity [57-62]. The sedimentation of organic carbon (OC) below fish farms has been found to be from 4 to 27 times higher than that at unaffected sites; declining rapidly with distance from the farm [63]. Additionally, the integration of lower trophic-level species (shellfish and seaweed) with monoculture of fish/shrimp in coastal water has potential assimilate organic matter from surrounding water and to release it through excretion that becomes a part of the organic pool [62]. Verdegem [17] estimated the contribution of primary production to carbon loading in fed aquaculture and pointed out that in flow-through systems (including cages), the environmental loading with carbon is higher than the amount fed. The author also highlighted that for fed aquaculture operations, a more detailed mass balance including growth and the different types of waste produced can be calculated for different feed components, including dry matter (DM), chemical oxygen demand (COD), carbon (C), N, ash and P.

3.3 Adverse effects on the environment from potential releases of pesticides and persistent organic compounds (POPs) from aquaculture production facilities

26. Being a growing concern, as mentioned previously, the principal pathways of contaminants which are discharged from aquaculture production activities are feed, chemicals used in the form of medications, disinfectants, and antifoulants, and fish faecal material. This guideline does not intend to look at the health-related issues, however, some additional issues of concerns are summarized in the Annex III.

4. Release Estimation Methods and Techniques for Pollutants from the Aquaculture Sector

27. Techniques used to estimate releases from the aquaculture sector are divided into (i) releases of nutrients, (ii) copper and zinc and their compounds and (iii) organic carbon. These are discussed below:

4.1 Summary of techniques used to estimate releases of nutrients, copper and zinc and their compounds and organic carbon from the aquaculture sector

28. To date, documents describing the Emission Estimation Techniques to determine pollutant loading from aquaculture facilities have been scarce and mostly focused on nutrient discharges. Below we summarize techniques and equations proposed by technical guidelines for use in Australia [64], Europe [65] and the USA [66]. This guidance document also describes techniques proposed in several peer-reviewed research papers.

29. As described earlier, feed inputs and feed practices (i.e. stocking density, the feeding regime, and the feeding rate) have been recognized as the major source of pollutant releases and drivers of effluent quality discharged from cage aquaculture production facilities [2-7]. Other pollution sources include chemicals used in the form of medications, disinfectants, and antifoulants, and fish faecal material. The actual amount of supplied feed that is consumed by the fish and its digestibility are the two most important factors that determine the amount of faecal wastes produced and released to the surrounding environment [66-67][].

30. Therefore, determining the feed content and the quantity of ingredients (e.g. N, P, organic matter, protein) in it from the feed suppliers is a key and should be a starting point in any estimation of potential for pollutant releases from the aquaculture production facility [19-22][65-66].

31. A particularly important parameter is the feed conversion ratio (FCR), which is defined as a measure of the feeding efficiency [66]. It is calculated as the ratio of the weight of feed applied to the weight of the fish produced:

$$\text{FCR} = \text{Dry weight of feed applied} / \text{Wet weight of fish gained} \quad (\text{Equation 4.1})$$

32. The US EPA [66] pointed out that with higher energy feeds, FCRs of 1.0 or less are now routinely observed in salmon and trout farming. Anytime FCRs are significantly greater, then less of the feed input goes to growth and more is used to support metabolic processes and there is increased waste generation, intrinsically as well as extrinsically (wasted feed).

4.1.1 Nutrients (total N and total P)

33. Australian EPA proposes two different techniques to estimate nutrient releases from temperate water finfish aquaculture facilities in Australia [64]:

- a. *Direct Measurement method*, which can be used on semi-closed and closed systems and involves direct measurement of total N and P in the discharge water. The Guidelines [64] highlighted that for this method, water quality data would need to be measured over a reasonable time to account for the variations before accurate, reliable figures could be determined for input into the direct measure equation (4.2).

$$T_{N+P} = E_{N/P} * F_A \quad (\text{Equation 4.2})$$

where:

T_{N+P} = discharge of total N and P to water (t/year)

$E_{N/P}$ = concentration of N and P in effluent (mg/L)

F_A = conversion factor (which was not provided in the document)

- b. *Mass Balance method*, which was recommended for use by both marine and freshwater land-based fish farming using semi-open systems:

$$T_{N+P} = (F_{N+P} * FCR) - (A_{N+P}) \quad (\text{Equation 4.3})$$

where:

T_{N+P} = discharge of total N and P to water (kg/t fish produced)

F_{N+P} = total N and P in feed¹⁰ (kg/t)

FCR = feed conversion rate (dimensionless)

A_{N+P} = N and P converted to fish biomass (kg/t)

34. The OSPAR Guidelines [65] proposed the following equation based on Nutrients in feed (N_{feed}) which are converted to fish biomass (N_{fish}) or released into the water as unconverted nutrients (N_{rel}):

$$N_{\text{feed}} = N_{\text{fish}} + N_{\text{rel}} \quad (\text{Equation 4.4})$$

35. For estimations of N_{feed} and N_{fish} , the Guidelines [65] referred to data provided by Germany's central environmental authority UBA¹¹ which stated that approximately 25% of the nutrients in feed are converted into biomass, with the remaining 75% discharged to the environment and Handy and Poxton¹² estimated that 52 – 95% of the nitrogen (N) added to aquaculture systems as feed will ultimately enter the environment.

36. The guidelines [65] also underlined that unconverted nutrients (N_{rel}) may occur as: i) uneaten feed, sedimented feed and inedible constituents; ii) faeces and indigestible feed; and iii) excreta (i.e., branchial and renal release).

37. US EPA [66] used the feed-to-pollutant conversion factors to estimate an untreated or “raw pollutant loading (RPL)” as following:

$$RPL = FI_A * F_{tP} \text{ conversion factor} \quad (\text{Equation 4.5})$$

where:

RPL = the pollutant load for each pollutant in question (i.e., TSS, BOD, TN, TP) in pounds (or tons)/year

FI_A is Annual feed input = the amount of feed distributed to the production system (pounds or tons/year)

F_{tP} is Feed-to-pollutant conversion factor = conversion of feed inputs into pollutant loadings (i.e., TSS, BOD, TN, TP) in pounds (tons) of pollutant per pound (ton) of feed.

38. Foy and Rosell [68] proposed an equation to determine nutrient loadings in aquaculture farms, based on the FCR value and the nutrient contents in the feed and in the fish, as

¹⁰ The proportion of P and N in the feed is obtained directly from the producers

¹¹ UBA (1996). Die Einflüsse der Fischerei und Aquakultur auf die marine Umwelt. UBA-Texte 46-96. Umweltbundesamt, Berlin.

¹² Handy, R.D. and Poxton, M.G. (1993). Nitrogen pollution in mariculture: toxicity and excretion of nitrogenous compounds by marine fish. Reviews in Fish Biology and Fisheries, 3: 205–241.

$$\text{Nutrient LOSS RATE} = (\text{FCR} \times \text{FEED}) - \text{FISH} \quad (\text{Equation 4.6})$$

where:

LOSS RATE = nutrient loss rate in kg/ton of fish produced;

FEED = nutrient content of the diet in kg/ton;

FISH = nutrient content in fish in kg/ton.

39. Olsen et al. [19] proposed a series of simple equations for estimation of nutrient release rate from fish, based on Mass balance in a Food-Fish-Waste system:

$$I = A + F = G + R + F \quad (\text{Equation 4.7})$$

where:

I = the food consumed;

A = assimilated food, or uptake in tissues;

F = defecation;

R = respiration, and

G = growth and reproduction (all in terms of carbon or energy).

40. The corresponding nutrient balance is expressed using the analogue equation:

$$I_{N,P} = A_{N,P} + F_{N,P} = G_{N,P} + E_{N,P} + F_{N,P} \quad (\text{Equation 4.8})$$

where excretion of N and P ($E_{N,P}$) replaces respiration.

41. The authors highlighted that these two general equations (4.7 and 4.8), together with knowledge on assimilation efficiencies of C, N, and P and the stoichiometric C:N:P composition of produced fish and feed, are fundamental for estimating nutrient and carbon intake, metabolism, and losses from individuals of cultured fish [19].

42. The assimilated food is the portion of the food that is digested by the fish and taken up in tissues, and the authors [19] estimated assimilation efficiency (AE) is defined as (similar for N and P):

$$AE = A/I \quad (\text{Equation 4.9})$$

43. The undigested food, termed faeces, passes through the fish gut undigested or partially digested. This fraction constitutes mainly particulate organic substances, including particulate forms of N and P, but some part is rapidly released in molecular dissolved forms in the water. The assimilated food supports growth and weight increment, and the growth efficiency (GE) is generally defined as (similar for N and P):

$$GE = G/I \quad (\text{Equation 4.10})$$

where:

GE = expresses the efficiency by which the food ingested is converted to new biomass. This is similar, although inverse, to the FCR which is an operational term established and used for aquaculture.

I = the food consumed (defined in equation 4.7)

G = growth and reproduction (defined in equation 4.7).

44. **The total wastes of carbon (TL_C) and nutrients (TL_{NP})** generated by cultured fish is expressed as:

$$TL_C = I - G = R + F \quad (\text{Equation 4.11})$$

$$TL_{NP} = I_{NP} - G_{NP} = E_{NP} + F_{NP} \quad (\text{Equation 4.12})$$

where I, G, R, F are defined in equation 4.7. as

I = the food consumed;

G = growth and reproduction;

R = respiration

F = defecation;

E_{NP} = excretion of N and P (defined in equation 4.8)

45. Respiration results in a release of inorganic CO_2 , the emission of **organic carbon wastes** (L_{OC}) is most easily estimated as:

$$L_{OC} = I - A = I(1 - AE) \quad (\text{Equation 4.13})$$

where:

A = assimilated food, or uptake in tissues (defined in equation 4.8).

AE = assimilation efficiency of carbon or energy which according to the authors [44] can be obtained from literature and in some cases from feed companies. The authors also pointed out that for the dissolved components from faeces, there is no formal way to distinguish these dissolved organic components (DOC) from the particulate organic waste components (POC), but that it is the particulate fraction is the most important, and that the corresponding estimate of **organic nutrient wastes** (L_{ONP}) from fish can be estimated as:

$$L_{ONP} = I_{NP} - A_{NP} = I_{NP}(1 - AE_{NP}) \quad (\text{Equation 4.14})$$

where:

I_{NP} = N and P consumed can be estimated based on total feed intake multiplied by feed N and P contents

The assimilation efficiency of N can be assumed to be equal to that of protein, and values are widely reported in literature and by feed companies; The assimilation efficiency of P is widely reported as well, but more uncertain because of the addition of indigestible P compounds from higher plants in the feed (phytate P). Regarding carbon input, there is no formal way to distinguish between dissolved organic nutrients (DON, DOP) and particulate organic nutrients waste components (PON, POP) originating from faeces, but the particulate nutrient fraction is more important.

46. **The inorganic N and P release** from the fish (L_{INP}) can be estimated as the difference between assimilation and production:

$$L_{INP} = A_{NP} - G_{NP} = (I_{NP} * AE_{NP}) - G_{NP} \quad (\text{Equation 4.15})$$

where:

G_{NP} = N and P in produced fish, obtained as produced fish weight times N and P contents

A_{NP} = N and P in assimilated food, or in tissues

I_{NP} = N and P consumed

AE_{NP} = assimilation efficiency for N and P.

4.1.2 Techniques used to estimate Cu and Zn releases

47. The information on emissions and releases estimation techniques to determine metals loading from aquaculture facilities is very sparse.

48. Dean et al. [48] investigated the high-resolution spatial distribution of the potentially ecotoxic metals zinc, copper and cadmium in sediments around a cage farm and attempted to derive a budget for these elements within the farming system. For each sediment core taken at depth y, concentration of each metal (Cu, Zn or other) was determined and converted to mass of metal per unit area ($g\ m^{-2}$) as following:

$$\text{Inventory (gm}^{-2}\text{)} = \frac{\sum_{i=1}^{n=y} ([\text{metal}]_i \text{ dry wt.})}{\text{Area}} \quad (\text{Equation 4.16})$$

where:

[metal]_i = metal concentration in the ith slice (mg g⁻¹);
 dry wt. = dry weight of full slice (g);
 area = r²π, r = core diameter (m²)

49. To estimate the metals budget, the total mass of metals within the feed and within the fish ‘on site’ was calculated, using the information on the feed and biomass input and feed conversion rate) FCR.

50. More recently, Earley et al. [69] evaluated environmental loading and metal leaching rates for four copper alloy materials and one traditional coated-nylon net material in a 365-day field test in San Diego Bay, California, USA.

51. The authors combined surface area of an example aquaculture farming pen (30 X 30 X 12 m) with leach rate data and a generic lifecycle model they developed [69] to estimate environmental life cycle loadings (total amount of copper released during the usable deployment life of the material) from aquaculture farming pens made from the copper alloy mesh (CAM) or Net materials.

52. The cumulative loading (CL) over a given time interval (x₀, x_n) was approximated from leach rate measurements (R) using the following equation:

$$CL_{x_0, x_n} \approx \sum_{x_0}^{x_n} (x_1 - x_0) \frac{R(x_0) + R(x_1)}{2} + (x_2 - x_1) \frac{R(x_1) + R(x_2)}{2} + (x_n - x_{n-1}) \frac{R(x_{n-1}) + R(x_n)}{2} \quad (\text{Equation 4.17})$$

where:

CL_{x₀, x_n} = the cumulative copper loading (μg cm⁻²) from day x₀ through x_n;
 x_n = a series of consecutive time points (days) during which release rate measurements were made beginning with day x₀ and ending with day x_n; and
 R(x_n) = the measured release rate (μg cm⁻² d⁻¹) for time point x_n.

53. The researchers [69-70] also reported that typical copper release rate patterns have an initial spike in concentration, followed by a decline to an asymptotic low or a pseudo-steady state (PSS). They proposed the following equation to calculate PSS:

$$PSS_{x_a, x_n} = \frac{CL_{x_a, x_n}}{(x_n - x_a)} \quad (\text{Equation 4.18})$$

where:

PSS_{x_a, x_n} = the pseudo steady state loading rate (μg cm⁻² d⁻¹), which occurs after day x_a and
 CL_{x_a, x_n} = the cumulative copper loading (μg cm⁻²) from day x_a through x_n;
 x_a = the time after which the copper release rates asymptote to PSS.

54. To capture the cumulative copper loading during the initial release period, the researchers [70] suggested the following equation:

$$IL_{x_0, x_a} = CL_{x_0, x_a} \quad (\text{Equation 4.19})$$

where:

IL_{x_0, x_a} = the initial release loading ($\mu\text{g cm}^2$), which occurs before day x_a ;

CL_{x_a, x_n} = the cumulative copper loading ($\mu\text{g cm}^{-2}$) from day x_0 through x_a ;

55. The total copper loading based on a materials life cycle was then estimated using the above variables with the following equation:

$$\text{Life Cycle Loading}_{s,f} = ((IL_{x_0,x_n}) \times (\Sigma E_{\text{cleaning}} + \Sigma E_{\text{replacement}})) + (PSS \times \Sigma D_{PSS}) \quad (\text{Equation 4.20})$$

where:

$\text{Life Cycle Loading}_{s,f}$ = Cumulative copper release ($\mu\text{g cm}^{-2}$), between time points x_s and x_f , the time over which the material is exposed to water;

$\Sigma E_{\text{cleaning}}$ = the total number of regularly scheduled material cleaning events over a given life cycle period.

$\Sigma E_{\text{replacement}}$ = the total number of regularly scheduled material replacement events over a given life cycle period (which includes the initial placement of material).

ΣD_{PSS} = the total number of days at which PSS releases are anticipated to occur.

4.1.3 Techniques used to estimate total organic Carbon releases

56. Total carbon (both organic and inorganic) release has been estimated by Olsen et al. [17] and has been described above in several equations, i.e. equations 4.7, and equations 4.11 to 4.13.

5. Conclusions

57. This document provides a comprehensive review of pollutants of concern (listed in the LBS Protocol) in aquaculture production facilities, and approaches, methods and techniques to estimate their releases focusing on nutrients, Cu and Zn, TOC.

58. Additionally, given an increasing concern regarding pesticides and persistent organic pollutants (POPs) pollution releases to waters from aquacultural production facilities, the document also reviewed issues related to potential pollution loading originating from these sources and provided a summary of current estimation techniques used to assess this type of pollution. Despite there is no agreed estimation methods, the potential estimation techniques are summarized in Annex III.

59. It should be noted that:

- a. Unlike the air emissions inventory, guidance documents and inventories on pollutants releases from aquaculture facilities are scarce.
- b. The estimation techniques about releases of pollutants from aquaculture production facilities are also very sparse.
- c. Estimation of pollutants discharges from aquaculture production facilities is a complex area of scientific research which requires expert knowledge.

60. With this guidance document information in the peer-reviewed literature has been researched, compiled and integrated to assist Contracting Parties in determination of the most appropriate methods and techniques to estimate potential pollution loading from aquaculture. There is an extensive bibliography of references and supplemental information containing recommendations for further sources of information and peer reviewed research papers particularly relevant to Mediterranean region presented in the Annex IV.

Annex I

Aquaculture Industry

A. Brief Overview

1. The FAO State of World Fisheries and Aquaculture Report [75-76] provides technical insight and exhaustive (22 Tables and 58 Figures) information on a sector and highlights major trends and patterns in global fisheries and aquaculture. These reports [75-76] highlighted that there has been a steep growth in the aquaculture industry for the last seven decades. Between 1961 and 2016, the average annual increase in global food fish consumption, grew from 9.0 kg in 1961 to 20.2 kg in 2015 (expressed per capita terms), at an average rate of about 1.5 percent per year [75]. In 2018, the world aquaculture production reached a record high of 179 million tons (Mt)¹³ in live weight, of which 156 Mt were used for human consumption, and the remaining 23 Mt to produce fishmeal and fish oil [76]. Aquaculture accounted for 46 % (82.3 Mt) of the total production and 52 percent of fish for human consumption (81.1 Mt) [76]. According to the OECD – FAO Agricultural Outlook 2020-2029 [77], global fish production is projected to reach 200 Mt by 2029, increasing by 25 Mt (or 14%) from the base period (average of 2017-19), though at slower pace (1.3% p.a.) than over the previous decade (2.3% p.a.).

Aquaculture in The Mediterranean

2. A detailed description of Aquaculture production in the Mediterranean has been described in several reports over the past five decades [78-81]. Although it was initially land-based, since the 1990s the Mediterranean marine fish farming was transferred to floating cages at sea [82-84]. In 2013, the marine fish farming in the Mediterranean was dominated by two main species: the European seabass *Dicentrarchus labrax* with ~161,000 metric tons year⁻¹ and the gilthead seabream *Sparus aurata* with ~135,000 metric tons year⁻¹. Farming of these species involves a first phase taking place in a land-based hatchery, then the moving of juvenile fish to floating cages at sea.

3. Of the brackish and freshwater form of aquaculture, the production of the Nile tilapia (*Oreochromis niloticus*) has been the greatest and the most important aquaculture industry in the Mediterranean region, with 769,000 metric tons produced in Egypt alone in 2012. Tilapia production continued rapid growth and expansion during the past several years [85-86]. Today, Egypt is the seventh-largest aquaculture producer in the world by production quantity and the largest in Africa, accounting for 73.8 % of aquaculture in Africa by volume and for 64.2 % by value [85-86]. Nile tilapia remains the main cultured species in Egypt contributing about 65.15% of the entire Egyptian fish production [86].

4. Taking into account both inland, brackish and marine waters production, since 2010 Egypt, France, Spain, Italy, Turkey and Greece have been the main aquaculture producing countries [87]. According to the Joint Research Centre (JRC) Scientific, Technical and Economic Committee for Fisheries (STECF)¹⁴ these countries remain the leaders in aquaculture production, with Spain (21%), France (15%), Italy (14%), and Greece (10%), making up 60% of the sales volume in EU27 [87]. Therefore, the guidelines on estimation techniques and methodologies to estimate potential pollutant loadings from aquaculture activities may be of particular interest to these countries.

¹³ In this FAO publication, the term “fish” indicates fish, crustaceans, molluscs and other aquatic animals, but excludes aquatic mammals, reptiles, seaweeds and other aquatic plants.

¹⁴ <https://stecf.jrc.ec.europa.eu/index.html>

B. Aquaculture Systems and Practices

5. There are several aquaculture practices which are used world-wide for production of a great variety of culture organisms. However, according to the water environment (freshwater, brackish water, marine water) in which the organisms are cultured, the three main types of aquaculture are:

- a. Freshwater aquaculture carried out either in fishponds, fish pens, fish cages or, on a limited scale, in rice paddies. It is located inland (hence, “inland aquaculture”) and represents 57% of animal aquaculture production [76] [88-90];
- b. Brackish water aquaculture, which is located in coastal areas, hence “coastal aquaculture”. It is practiced in completely or partially artificial structures in areas adjacent to the sea, such as coastal ponds and gated lagoons [88-92].
- c. Marine aquaculture, “mariculture” is conducted in the sea, in a marine water environment. It employs either fish cages or substrates for mollusks and seaweeds such as stakes, ropes, and rafts, and can be located along the coastline or off-shore (off-shore, high seas aquaculture) [91-95].

6. The environmental impact of aquaculture is largely determined by the farming method used. According to the water-holding facility in which the organisms are grown, the aquaculture production methods are grouped into four types: ponds, cages, raceways, and recirculating systems (Table A.1). Depending on the stocking density of the culture organisms, the level of inputs, and the degree of management, culture systems range from very extensive, through semi-intensive and highly intensive to hyper-intensive [88-96]. The management interventions, infrastructure and supporting technologies utilized in aquaculture include a wide range of activities, such as seed supply and stocking, handling, feeding, controlling, monitoring, sorting, treating, harvesting, processing and use of preventive measures [76] [88-96].

Table A.1: Aquaculture Methods¹⁵

High-Risk Systems
Open-net Pens or “cages” are found offshore, in coastal areas or in freshwater lakes. These systems allow for free exchange of waste, chemicals, parasites and disease between the farm production site and the surrounding environment. There is also the potential for farmed fish to escape. Farms can also attract predators, such as marine mammals, that can get tangled in fish farm nets and drown.
Ponds , which are semi or fully enclosed bodies of water, and typically used to farm Tilapia and shrimp. “High-risk” pond farms discharge untreated wastewater, which pollutes the surrounding environment and can also cause considerable habitat damage (for example, shrimp ponds are a leading cause of mangrove destruction [97-99]). To be considered a “low risk” method, discharged waste must be filtered and treated.
Low Risk Systems
Closed systems , or closed containment farming methods, use a barrier to control the exchange between farms and the natural environment. This method significantly reduces adverse effects on the environment including pollution, fish escapes, negative wildlife interactions, and parasite and disease transfer from farms to marine and freshwater ecosystems. The most common types are race ways and recirculating systems.
Raceways are typically used for raising rainbow trout. In this method, flowing water is diverted from natural streams or a well. To be considered a low-risk method, waste must be treated, and fish escapes prevented.

¹⁵ Modified from Seachoice.org. url: <https://www.seachoice.org/info-centre/aquaculture/aquaculture-methods/>

Re-circulation Systems: In these systems water is treated and re-circulated, with minimal wastewater discharge. Common species farmed this way include Arctic char, striped bass, barramundi, sturgeon, and increasingly, salmon. These systems are designed to treat effluent before it is discharged to natural water bodies, which reduces pollution, disease and parasite transfer. Fish escapes are virtually impossible, with appropriate barriers designed into the facilities.

Suspended aquaculture is the method of growing shellfish on beaches or suspended in water on ropes, plastic trays or in mesh bags. The shellfish farmed using these methods are filter feeders and require only clean water to thrive. Oysters, scallops, mussels, and clams are cultured using suspension systems. Shellfish farming in suspended aquaculture is often low risk, if the farmed species is native to the area, and if the farm has sufficient water flow to prevent waste accumulation.

Annex II

Overview of Release Estimation Techniques and Applied Methodologies for Estimation of Releases of Pollution from the Aquaculture Sector

A. Background

1. Aquaculture is one of the pillars of both the Common Fisheries Policy (CFP)¹⁶ and initiatives of the European Union, i.e., the Blue Growth Agenda Strategy¹⁷ and the strategic guidelines for the sustainable development of EU aquaculture¹⁸. However, until recently, regulations and international oversight for the aquaculture industry are extremely complex, with several agencies regulating aquaculture practices, including site selection, pollution control, water quality, feed supply, and food safety. Moreover, these practices differ from country to country and sometimes between states and territories within a country [100-101].

2. FAO [102] recently developed and proposed an ecosystem approach to aquaculture (EAA), which they defined as a “strategy for the integration of aquaculture within the wider ecosystem such that it promotes sustainable development, equity, and resilience of interlinked social-ecological systems”. The strategy is led by three key principles: 1) Aquaculture development and management should take account of the full range of ecosystem functions and services and should not threaten the sustained delivery of these to society; 2) Aquaculture should improve human well-being and equity for all relevant stakeholders; 3) Aquaculture should be developed in the context of other sectors, policies and goals. In describing the EAA, the authors [102] also discussed site selection and carrying capacity, which is an important concept for ecosystem-based management, and assist in setting the upper limits of aquaculture production given the environmental limits and social acceptability of aquaculture.

3. On May 17th, 2021, the European Commission proposed a new approach for a sustainable blue economy in the EU for the industries and sectors related to oceans, seas and coasts [140-141]. However, while this new approach includes pollution and waste prevention as a part of a strategy to achieve the objectives of climate neutrality and zero pollution, it does not provide any guidelines on methods and techniques for estimating pollutant loading from Aquaculture production activities.

B. Overview of approaches

4. To date there have been very few Inventories/Guidelines describing approaches, methods and techniques for estimating pollutant loading from Aquaculture production activities. In Europe, the two main guidelines have been developed over 20 years ago:

Guidelines on Nutrient Discharges from Fish Farming in the OSPAR Convention Area developed by the OSPAR Commission [65].

5. This Guidelines document proposed techniques to estimate nutrient discharges and provides methods to assess these discharges: (i) assessment based on the feed used; (ii) assessment based on production; and (iii) assessment based on national information and other sources (Table A.2).

6. The Guidelines also provide information on Nutrients discharged (ton/year) according to national calculations for several countries. However, these calculations are based on production data from over 25 years ago, therefore the information should be updated. Moreover, the data presented in the OSPAR guidelines [65] mainly concern aquaculture within the OSPAR Convention Area. Only a

¹⁶ https://ec.europa.eu/fisheries/cfp_en

¹⁷ http://ec.europa.eu/fisheries/cfp/aquaculture/index_en.htm

¹⁸ <https://eur-lex.europa.eu/legal-content/EN/TXT/PDF/?uri=CELEX:52013DC0229&from=EN>

proportion of the data included activities within the Mediterranean Sea, while data for a few countries are missing completely.

7. The guidelines concluded that Nutrient discharges should be calculated separately for the various types of aquaculture; the main distinctions being between marine and brackish-water net cage farming, intensive farming in ponds, basins and channels, and extensive carp pond farming. However, the data that would enable such distinctions were not available [65].

Table A.2: Methods for assessment of nutrient discharges from fish farming

Assessment based on the feed used¹
The feed used is determined by: <ul style="list-style-type: none"> • the species of fish farmed; • the type of farming (i.e. farm type, marine/freshwater, seasonal and climatic conditions, fish density); • the age of the fish (i.e. fry, adult); and the production objective (i.e. for food or as stock).
Assessment based on production²
This method estimates approximate nutrient discharges from the non-converted nutrients per ton of fish produced. Information must be obtained from the producers. At the time OSPAR guidelines were created in 2000, various producers estimated that approximately 40 – 70 kg N and 4 – 11 kg P/ton of fish produced are not converted when using dry feed with a DOM of > 90%.

¹ Notes: The guidelines [65] also provides information on the composition of the most frequently used feed which at the time (year 2000) was the same for marine and inland sectors (Table 6, pp. 14 of the OSPAR guidelines), and examples of calculation for both N and P releases; ² The Guidelines [65] highlighted that the assessments using this method are inexact because production-specific information such as aquaculture type, feeding method, the species farmed and its age structure, losses through mortality and the import/export of stock are not included in the calculation.

HELCOM Guidelines for the compilation for waterborne pollution load to the Baltic Sea (PLC-Water) [103]

8. This Guidelines describe methods for compilation of annual pollutant load for Fish farming plants in Section 3.1.3.3. For the quantification of discharges, the Guidelines highlight a distinction between two main production types: a) Plants without treatment (e.g., plants where the sludge is not collected or where the sludge is collected but discharged to the aquatic environment without treatment); and b) Plants with treatment (e.g., plants with permanent removal of sludge), where the N and P contents (and organic matter) in the sludge removed are quantified.

9. The two proposed quantification Approaches are:

- a. *Approach 1*, which is based on calculations from production parameters. The starting point is that information is available on both production and feed consumption at catchment level. The quantification method is based on mass balance equations.
- b. *Approach 2* is based on monitoring the discharge. It is practicable for ponds or other land-based production systems where the discharges are distinct point discharges (such as end of pipe/channel). The quantification of losses is also based on mass balance equation but on monitoring results³⁰.

10. In **Australia**, there are two main Guidelines documents, both developed 20 years ago [64][104]: 1) The Emissions Estimation Technique (EET) Manual for Aquaculture from Temperate Water Finfish Aquaculture provides a general overview of the temperate water finfish aquaculture methods and describes the procedures and methods for estimating emissions of Category 3 National Pollutant Inventory (NPI) listed substances, specifically total nitrogen (TN) and total phosphorus (TP) [64] It 2) The EET Manual for The Aquaculture of Barramundi, Prawns, Crocodiles, Pearl oysters,

Red claw and Tropical abalone In Tropical Australia [104], which describes the procedures and methods relevant only to Tropical Aquaculture Facilities.

11. In the **USA**, the US Environmental Protection Agency (USEPA) developed Guidelines for the Final Effluent Limitations Guidelines and New Source Performance Standards for the Concentrated Aquatic Animal Production Point Source Category [66]. It describes industry processes, pollutants generated, available control and treatment technologies, the technical basis for the final rule, and costs of the rule.

12. In **Canada**, aquaculture is managed by different levels of government. Provincial governments are the primary regulators and leasing authorities for aquaculture (except in British Columbia and Prince Edward Island), while the federal government has responsibility for navigation, disease prevention affecting international trade, and the environment under the Fisheries Act and the Health of Animals Act.¹⁹ Measures to reduce detriment are listed in Section 7 of the Aquaculture Activities Regulations guidance document. However, no estimation techniques or methods are described. Recommendations and rules for management of organic wastes can be found at the Fisheries and Oceans Canada website.²⁰

C. Accuracy and uncertainty

13. The UNITAR Guidelines [105] highlighted that evaluation of availability and accuracy of information is a key when considering types of pollution sources to be included in the national PRTR system. However, the availability of information needed varies greatly between countries and for different regions within a country [105]. The Guidelines also pointed out that quality of inventories is influenced by several factors including 1) accuracy (the measure of ‘truth’ of a measure or estimate); 2) comparability (between different methods or datasets); 3) completeness (the proportion of all emissions sources that are covered by the inventory); and 4) representativeness (in relation to the study region and sources of emissions) [105]. The USEPA highlighted that prediction uncertainty is caused by natural process variability, and bias and error in sampling, measurement, and modeling [137].

14. According to the OECD Compendium [106], errors or uncertainty in the preparation of the inventories may include: 1) Emission factors (which do not reflect real life conditions); 2) Activity data that do not adequately reflect the study region (scaling down national or state activity data to smaller regions always results in decreased accuracy); 3) Spatial and temporal disaggregation may introduce errors that are difficult to quantify; 4) Sample surveys may be subject to sampling errors.

15. One of the key documents for Aquaculture, the OSPAR Guidelines [65] underlined that they were not able to produce complete and reliable datasets on production and nutrient discharges from aquaculture. Some of the reasons for the lack of reliability were 1) missing or incomplete responses to the questionnaire; 2) a lack of detail in the response (e.g., no distinction between marine and freshwater production and the respective feed used); 3) little or no distinction between the total production of a particular country, production within the OSPAR Convention Area and/or production within ‘eutrophication problem areas’; 4) differences in the quality and accuracy of the data supplied, 5) owing to variability in the calculation procedures and assessment methods used; and 6) data supplied for different years.

¹⁹ Government of Canada (2021). Fisheries and Oceans Canada. Aquaculture Activities Regulations guidance document. url: <https://www.dfo-mpo.gc.ca/aquaculture/management-gestion/aar-raa-gd-eng.htm>

²⁰ <https://www.dfo-mpo.gc.ca/aquaculture/protect-protege/waste-dechets-eng.html>

16. The OSPAR Guidelines [65] also highlighted that a further limitation is imposed by the wide range of aquaculture systems in use. Moreover, factors crucial to an assessment of this type of pollutants release are not reported statistically due to the large number of farms and species farmed. Variability in the technical equipment used (for example cleaning and filtration systems) and types of farm-specific feed and feeding techniques also affected data accuracy.

D. Quality control and quality assurance

17. The OECD Compendium [106] provides summary of quality assurance/quality control (QA/QC). They highlight the importance of proper documentation, which ensures reproducibility, transparency and assists future inventory updates. Documentation should include all raw data used, assumptions, steps in calculations, and communications with data providers and QA/QC processes. Moreover, the important missing data (e.g., missing pollutants, missing source types) also need to be acknowledged and documented [106].

18. The International Plant Protection Convention (IPPC) Guidelines for National Greenhouse Gas Inventories provides a comprehensive description of the quality assurance/quality control (QA/QC) and verification which are also relevant to inventories of pollutants releases/discharges from aquaculture production and fish farming activities [107]. They also highlighted that well developed and established QA/QC contributes to the transparency, consistency, comparability, completeness, and accuracy of inventories (Box A.1).

Box A.1.: Definitions of QA/QC and Verification

Quality Control (QC) is a system of routine technical activities and procedures to assess and maintain the quality of the inventory. The QC system is compiled by the inventory team and is designed to: (i) Provide routine and consistent checks to ensure data integrity, correctness, and completeness; (ii) Identify and address errors and omissions; and (iii) Document and archive inventory material and record all activities. QC activities comprise general methods such as accuracy checks on data acquisition and calculations, and the use of approved standardized procedures. QC activities also include technical reviews of categories, activity data, emission factors, other estimation parameters, and methods.

Quality Assurance (QA) is a system of review procedures conducted by independent third parties. The purpose of reviews is to verify that measurable objectives (data quality objectives) are met, and to ensure that the inventory represents the best possible estimates of emissions and removals given the current state of scientific knowledge and data availability and support the effectiveness of the QC programme.

Verification refers to the collection of activities and procedures conducted during the planning and development stage, or after the completion of an inventory that can help to establish its reliability for the intended applications of the inventory.

Annex III

Additional Issues of Concern - Releases of Pesticides, Persistent Organic Compounds (POPs) and microplastics from the Aquaculture Sector

A. Brief Overview

1. Replacing marine ingredients with plant material in the feed results in introduction of pesticides used in terrestrial agriculture in aquaculture production facilities globally [28-32][108]. The aquaculture feed includes soybeans, maize and rice [8-10], with soybean meal representing about 25% total compound aquafeeds by weight [5].

2. The main source of persistent organic pollutants (POPs) in farmed fish, in particular farmed Atlantic salmon are fish oils, obtained from pelagic fish species, used in fish feed. Oil spill accidents are among the most concerning exposure events for Polycyclic aromatic hydrocarbons (PAH) pollution of aquatic environments [109-112]. Hydrocarbon chemicals are major components of crude oil and are classified as PAHs, aliphatic saturated hydrocarbons, aliphatic unsaturated hydrocarbons, and alicyclic saturated hydrocarbons [109-112]. The impact of these four categories of PAHs on the ecosystem is especially concerning because of their carcinogenicity [112-113]. Several studies reported PAHs in fish in various areas of Mediterranean Sea [25] [110-120].

3. Microplastics may enter aquatic environments through different pathways, and they have occurred in all environmental matrices (beaches, sediments, surface waters and water column). Microplastic exposure potential in marine fish, for example, is likely to arise from ingestion of particles in the water column or on the seafloor resembling prey or by ingesting prey that previously ingested microplastics themselves [121]. The exposure can also occur via feed. About 25% of global commercial marine fisheries landings are used to produce fishmeal and fish oil [121-122]. Recent research has shown that fishmeal is both a source of microplastics to the environment, and directly exposes organisms for human consumption to these particles [121-124]. Thiele et al. [121] made a conservative estimate that over 300 million microplastic particles (mostly < 1 mm) could be released annually to the oceans through marine aquaculture. Due to their widespread and increasing presence in both freshwater and marine environments, and their potential hazard risk to the marine environment via ingestion and accumulation of PBTs, microplastics have emerged as one of the most concerning environmental problems in the aquatic ecosystem [121-126].

4. Apart from the main pollutants described in the main document (Sections 1.3.2.1 to 1.3.2.4), all of the above pollutants described above accumulate in sediments [47-52] [59-61][118][127-128].

Pesticides

5. The main sources of pesticides in aquaculture production, in particular salmon, is through fish feed and also to control parasites²¹ [24-25] [28-32]. The use of pesticides in fish feed, in particular farmed salmon has caused an increased concern regarding their potential effects on human health in recent years [24-25] [28-32]. It has been reported that feed used in the seawater production phase of Atlantic salmon aquaculture typically contains 70% plant ingredients [63][129]. In Asia, Cheung et al [130] reported highly elevated concentrations of organochlorine pesticides (OCPs) in fish collected from the fishponds located in Pearl River Delta (PRD). The concentrations of OCPs in human tissues (e.g. milk and plasma) were significantly correlated with the frequency of fish consumption in both Hong Kong and Guangzhou populations [28][131]. In Europe, recent wide-scale screening of Atlantic salmon feeds has shown that they contain chlorpyrifos-methyl (CPM) [108][132]. Other compound

²¹ Caligus or “sea louse” is a small crustacean that attaches to the surface of the skin and gills of salmon, generating significant injuries to the fish.

found was Chlorpyrifos (CPF) a widely used agricultural organophosphorus pesticide (OP) that can be highly toxic to fish [108].

6. Pesticides pollution of fish is becoming a problem of increasing concern in the Mediterranean Sea. Pesticide residues (Metribuzin DADK, propamocarb HCl, and piperonyl butoxide (PBO)) were found in muscles of several marine fish species and seaweeds in Mediterranean (Iskenderun Bay, Turkey) [133]. Polychlorinated biphenyl (PCB) and OCP concentrations were determined in livers of two deep-sea fish species (roughsnout grenadier and hollowsnout grenadier), from the Adriatic Sea [134]. PCBs and Organochlorine Pesticides (OCPs) were also detected in the sediments and *Siganus rivulatus* (marble spinfoot) from two areas along the Egyptian Mediterranean Coast [127], Greece [135], Italy [136], Spain [137], France [128]. Ibrahim et al [138] found that 27 freshwater fish species that are native to Europe and widespread in the EU streams, ditches or ponds in agricultural landscapes are at the elevated risk of being exposed to pesticides.

Persistent organic pollutants (POPs)

7. Persistent organic pollutants (POPs) are toxic chemicals that adversely affect human health and the environment around the world and are listed as pollutants of concern in the LBS protocol. Fish can accumulate high amounts of POPs and Hg, and therefore can be the sources of their entry in human organism [117-118][139]. Polychlorinated dibenzo-p-dioxins (PCDDs), polychlorinated dibenzofurans (PCDFs) (collectively referred to as dioxins) highly lipophilic and accumulate in the fatty tissue of humans and animals and thus in the fatty fish livers [25]. Several studies demonstrated that the concentrations of organic contaminants in cod livers depend on the fishing area [25][120].

8. The main source of persistent organic pollutants (POPs) in farmed fish, in particular farmed Atlantic salmon are fish oils, obtained from pelagic fish species, used in fish feed. Oil spill accidents are among the most concerning exposure events for Polycyclic aromatic hydrocarbons (PAH) pollution of aquatic environments [109-112]. Hydrocarbon chemicals are major components of crude oil and are classified as PAHs, aliphatic saturated hydrocarbons, aliphatic unsaturated hydrocarbons, and alicyclic saturated hydrocarbons [109-112]. The impact of these four categories of PAHs on the ecosystem is especially concerning because of their carcinogenicity [112-113][111]. Several studies reported PAHs in fish in various areas of Mediterranean Sea [25] [108-120].

Microplastics

9. Microplastics are typically defined as plastic items which measure less than 5 mm in their longest dimension and include also nanoplastics (which are less than 100 nanometres long). These plastic items may be manufactured or may result from the degradation and fragmentation of larger plastic items (defined as secondary micro- and nanoplastics). Microplastics contain a mixture of various chemicals and additives from manufacturing process, and they can also efficiently sorb (adsorb or absorb) persistent, bioaccumulative and toxic contaminants (PBTs) from the environment [121-126].

10. Following Global Oceans Action Summit for Food Security and Blue Growth in 2014 recommendations, FAO, The International Maritime Organization (IMO) and UNEP worked together with the Group of Experts on the Scientific Aspects of Marine Environmental Protection (GESAMP) to improve the knowledge base on microplastics in the marine environment and provide policy advice on this topic [125].

B. Summary of techniques used to estimate releases of pesticides and persistent organic compounds (POPs) from the aquaculture sector

11. There are no techniques for estimation of the releases of pesticides and POPs as such, however, this document postulates some methods which could be evaluated for making such estimations. It should be noted that, these estimation techniques need to be further tested.

12. Similarly to nutrients, metals and TOC, pesticides and persistent organic compounds (POPs) entering aquaculture production facilities via fish feed, chemicals (medications, disinfectants, and antifoulants) and could be, unintentionally, released to the environment via uneaten food and fish faecal material.

13. Therefore, as highlighted earlier, determining the feed content and the quantity of its ingredients from the feed suppliers is key [19-22][65-66]. A particularly important parameter is the feed conversion ratio (FCR), determined as:

$$\text{FCR} = \text{Dry weight of feed applied/Wet weight of fish gained} \quad (\text{Equation 4.21.})$$

14. Most of the techniques used to estimate releases of nutrients, TOC and metals (e.g. Equations 4.3 to 4.5, 4.8, 4.9-4.10, 4.12, 4.15 to 4.20) could be applied to estimate pesticides and persistent organic compounds (POPs), where nutrients content/concentration would be substituted by the pollutant in question (i.e. pesticides, POPs), **though they would need to be tested**.

15. For example, if we follow the same analogy of techniques proposed for nutrients, a simple equation for nutrient discharges (equation 4.4.) proposed by OSPAR guidelines, an equation could be tested for determination of organic chemical releases:

$$\text{OC}_{\text{feed}} = \text{OC}_{\text{fish}} + \text{OC}_{\text{rel}} \quad (\text{Equation 4.22})$$

where:

OC_{feed} = organic chemical content in feed²²

OC_{fish} = Organic chemical content converted to fish biomass (OC_{fish}) or

OC_{rel} = unconverted organic chemical released into the water,

Pesticides and POPs

16. As mentioned above (paragraphs 7 and 8) equation 4.22 could also be used for determination of POPs, **though it would need to be tested**. Several authors developed models with the aim of predicting bioaccumulation of organic chemicals in aquatic food-webs in freshwater [71-74].

17. Mackay and Fraser [72] conducted an extensive literature review of mechanisms and models used for predictions and estimates of persistent organic chemicals bioaccumulation in fish (which would be OC_{fish}) and suggested a new empirical model for determination of bioconcentration (**Tier 1**) and mechanistic model for estimates of bioaccumulation (**Tier 2**). The authors [72] defined *bioconcentration* as the uptake of chemical by absorption from the water can only occur via the respiratory surface and/or the skin, and thus results in the chemical concentration in an aquatic organism being greater than that in water. The bioconcentration factor (BCF) is defined as the ratio of the chemical concentration in an organism C_B , to the total chemical concentration in the water C_{WT} , or to C_{WD} , the freely dissolved chemical concentration in water.

18. *Bioaccumulation* (BAF) is the process which causes an increased chemical concentration in an aquatic organism compared to that in water, due to uptake by all exposure routes including dietary absorption, transport across respiratory surfaces and dermal absorption. *Bioaccumulation can thus be viewed as a combination of bioconcentration and food uptake*.

²² This information can be obtained from the fish feed suppliers. Within the EU, According to Regulation (EC) No 396/2005 on maximum residue levels of pesticides in or on food and feed, Member States have to monitor pesticide residue levels in food samples including aquaculture products and submit the monitoring results to EFSA and the European Commission. http://publications.europa.eu/resource/ellar/7deccc8e-5c03-11eb-b487-01aa75ed71a1.0006.03/DOC_1

19. The authors [72] highlighted that bioaccumulation is particularly relevant for estimates of pesticides and POPs releases from aquaculture production facilities. The proposed models are summarized in Table 4.1. below.

20. In 2009, the US EPA Office of Pesticide Programs' Environmental Fate and Effects Division scientists developed KABAM (K_{OW} (based) Aquatic BioAccumulation Model) to estimate potential bioaccumulation of hydrophobic organic pesticides in freshwater aquatic food webs and subsequent risks to mammals and birds [73-74]. The KABAM model is composed of two parts: i) bioaccumulation model estimating pesticide concentrations in aquatic organisms, and ii) a risk component translating exposure and toxicological effects of a pesticide into risk estimates for mammals and birds consuming contaminated aquatic prey.²³ A detailed description of the model can be found on the USA EPA website [73-74].

Table 4.1: Tier 1 and Tier 2 Models for Bioconcentration and Bioaccumulation of persistent organic chemicals in fish

Tier 1 Empirical model of Bioconcentration $BCF = C_B/C_{WD} = (1 + L \cdot K_{OW})$, where L is lipid volume fraction, C_{WD} is dissolved concentration or equivalently for fugacity in biota f_B and in water f_W $f_B = f_W$ where $f_W = C_W/Z_W$, $f_B = C_B/Z_B$ and $BCF = Z_B/Z_W = (1 + LK_{OW})$ <i>Assumptions:</i> Partitioning is predominantly to lipids, no ionization, no metabolism, no biomagnification, 100% bioavailability, and equilibrium applies. <i>Criteria:</i> $BCF > 5000$ or $K_{OW} > 100000$	Tier 2 Mechanistic model of Bioaccumulation $BAF = C_B/C_{WD} = (k_1 + k_A C_A/C_{WD}) / (k_2 + k_M + k_E)$, where k_1 is the respiratory uptake rate constant, k_A is the food consumption rate constant, k_2 is the respiratory clearance rate constant = k_1/BCF k_M is the metabolic rate constant, and k_E is the egestion rate constant = $k_A/4$ <i>Assumptions:</i> Partitioning is predominantly to lipids, no ionization, no metabolism, no biomagnification, 100% bioavailability, and equilibrium applies. <i>Criteria:</i> $BCF > 5000$ or $K_{OW} > 100000$
<p>K_{OW} = octanol²⁴-water partition coefficient²⁵ represents the ratio of concentrations of a compound between two phases, one being octanol and the other water. It serves as a measure of the relationship between lipophilicity (fat solubility) and hydrophilicity (water solubility) of a substance.</p> <p><i>Fugacity</i> is partial pressure, a criterion of equilibrium analogous to temperature in the case of heat transfer.</p> <p>Z_w and Z_b are constants for water and biota, respectively. Z is a constant (units of mol/m³ Pa) specific to the chemical, the phase in which it is dissolved or sorbed and temperature and can be calculated from physical and chemical properties.</p>	

²³ <https://www.epa.gov/pesticide-science-and-assessing-pesticide-risks/kabam-version-10-users-guide-and-technical#Section1>

²⁴ Octanol is any of four liquid alcohols $C_8H_{17}OH$ derived from normal octane; Octane is a hydrocarbon and an alkane with the chemical formula C_8H_{18} , and the condensed structural formula $CH_3(CH_2)_6CH_3$. It has many structural isomers that differ by the amount and location of branching in the carbon chain. Octane is also an agent designed to control the life of pesticides: https://indigospecialty.com.au/wp-content/uploads/2019/11/ISP-Octane-5L-Label_F090919.pdf

²⁵ <https://www.sciencedirect.com/topics/chemistry/octanol-water-partition-coefficient>

References

- [1] Schalekamp, D., van den Hill, K. and Huisman, Y. (2016). A Horizon Scan on Aquaculture 2015: Fish Feed. Brief for GSDR – 2016 Update. url: https://sustainabledevelopment.un.org/content/documents/1034769_Schalekamp%20et%20al._A%20Horizon%20Scan%20on%20Aquaculture%202015-Fish%20Feed.pdf
- [2] Babatunde Dauda, A., Abdullateef Ajadi, Adenike Susan Tola-Fabunmi, Ayoola Olusegun Akinwale (2019). Waste production in aquaculture: Sources, components and managements in different culture systems, *Aquaculture and Fisheries* 4(3): 81-88. <https://doi.org/10.1016/j.aaf.2018.10.002>.
- [3] Martins, C.I.M., Eding, E.H., Verdegem, M.C.J., Heinsbroek, L.T.N., Schneider, O., Blancheton, J.P. et al. (2010). New developments in recirculating aquaculture systems in Europe: A perspective on environmental sustainability *Aquacultural Engineering* 43 (3): 83-93. <https://doi.org/10.1016/j.aquaeng.2010.09.002>
- [4] Tacon, A.G.J., Hasan, M.R., Allan, G., El-Sayed, A.-F., Jackson, A., Kaushik, S.J., Ng, W.-K., Suresh, V. & Viana, M.T. (2012). Aquaculture feeds: addressing the long-term sustainability of the sector. In R.P. Subasinghe, J.R. Arthur, D.M. Bartley, S.S. De Silva, M. Halwart, N. Hishamunda, C.V. Mohan & P. Sorgeloos (eds). *Farming the Waters for People and Food. Proceedings of the Global Conference on Aquaculture 2010, Phuket, Thailand. 22–25 September 2010.* pp. 193–231. FAO, Rome and NACA, Bangkok.
- [5] Tacon, A.G.J., Hasan, M.R. and Metian, M. (2011). Demand and supply of feed ingredients for farmed fish and crustaceans. Trends and prospects. FAO Fisheries and Aquaculture Technical Paper 564. url: <http://www.fao.org/3/ba0002e/ba0002e.pdf>
- [6] Miller, D. and Semmens, K. (2002). Waste management in aquaculture. *Aquaculture Information Series* (2002), pp. 1-10. #AQ02-1(January).
- [7] Read, P. and Fernandes, T. (2003). Management of environmental impacts of marine aquaculture in Europe. *Aquaculture* 226(1-4):139-163.
- [8] Tacon, A.G.J. & Metian, M. (2015). Feed Matters: Satisfying the Feed Demand of Aquaculture. *Reviews in Fisheries Science & Aquaculture* 23 (1): 1–10. doi:10.1080/23308249.2014.987209.
- [9] Tacon, A.G.J. & Metian, M. (2009). Fishing for aquaculture: non-food use of small pelagic forage fish – a global perspective. *Reviews in Fisheries Science* 17(3): 305-17. doi:10.1080/10641260802677074
- [10] Troell, M., Naylor, R.L., Metian, M., Beveridge, M., Tyedmers, P.H., Folke, C. and de Zeeuw, A. (2014). Does aquaculture add resilience to the global food system? *Proceedings of the National Academy of Sciences of the United States of America* 111(37):13257-63 doi:10.1073/pnas.1404067111.
- [11] Tacon, A.G.J. & Metian, M. (2008). Global overview on the use of fish meal and fish oil in industrially compounded aquafeeds: trends and future prospects. *Aquaculture* 285: 146–158.
- [12] Tacon, A.G.J., Metian, M. & Hasan, M.R. (2010). Feed ingredients and fertilizers for farmed aquatic animals: sources and composition. FAO Fisheries and Aquaculture Technical Paper No. 540. Rome, 210 pp.
- [13] Encarnação, P. (2015). Functional feed additives in aquaculture feeds. In: Nates, S.F. (2015). *Aquafeed Formulation.* Academic Press. 279 pp. url: <https://doi.org/10.1016/C2013-0-18878-2>
- [14] Mente, E., Graham J. P., Begona Santos, M. and Neofitou, C. (2006). Effect of feed and feeding in the culture of salmonids on the marine aquatic environment: a synthesis for European aquaculture. *Aquaculture International* 14:499–522. DOI 10.1007/s10499-006-9051-4
- [15] FAO (2009). Environmental impact assessment and monitoring in aquaculture Requirements, practices, effectiveness and improvements. Technical Report 527. 675 pages. <http://www.fao.org/3/i0970e/i0970e.pdf>
- [16] Jegatheesan, V., Shu, L. and Visvanathan, C. (2011). *Aquaculture Effluent: Impacts and Remedies for Protecting the Environment and Human Health*, Editor(s): J.O. Nriagu, Encyclopedia

- of Environmental Health, Elsevier 2011, Pages 123-135. ISBN 9780444522726, <https://doi.org/10.1016/B978-0-444-52272-6.00340-8>.
- [17] Verdegem, M.C.J. (2013). Nutrient discharge from aquaculture operations in function of system design and production environment. *Reviews in Aquaculture* 5(3):158-171.
- [18] Domínguez, L.M. and Martín, J.M.V. (2004). Aquaculture environmental impact assessment. *Waste Management and the Environment II*, V. Popov, H. Itoh, C.A. Brebbia & S. Kungolos (Editors). Pp. 321-333. url: <https://www.witpress.com/Secure/elibrary/papers/WM04/WM04032FU.pdf>
- [19] Olsen, L.M., Holmer, M. and Olsen, Y. (2008). Perspectives of nutrient emission from fish aquaculture in coastal waters: Literature review with evaluated state of knowledge. DOI: 10.13140/RG.2.1.1273.8006
- [20] Ying Zhang et al. (2015). Environmental Resources Letters 10 04500. Nutrient discharge from China's aquaculture industry and associated environmental impacts. url: <https://iopscience.iop.org/article/10.1088/1748-9326/10/4/045002/pdf>
- [21] Reid, G.K. (2007). Chapter One: Nutrient Releases from Salmon Aquaculture. In: Costa-Pearce B. (Ed.), *Nutrient Impacts of Farmed Atlantic Salmon (Salmo Salar) on Pelagic Ecosystems and Implications for Carrying Capacity*. World Wildlife Fund.
- [22] Tornero, V. and Hank, G. (2016). Identification of marine chemical contaminants released from sea-based sources. A review focusing on regulatory aspects. JRC Technical Report. 130 pp. <https://mcc.jrc.ec.europa.eu/documents/technicalreportmarinespecificcontaminants.pdf>
- [23] Alderman, D.J., Rosenthal, H., Smith, P., Steward, J. and Weston, D.. Chemicals used in mariculture. ICES-COOP. RES. REP. 100 pp. 1994.
- [24] Ole Jakob Nøstbakken, Helge T. Hove, Arne Duinker, Anne-Katrine Lundebye, Marc H.G. Berntssen, Rita Hannisdal, Bjørn Tore Lunestad, Amund Maage, Lise Madsen, Bente E. Torstensen, Kåre Julshamn (2015). Contaminant levels in Norwegian farmed Atlantic salmon (*Salmo salar*) in the 13-year period from 1999 to 2011. *Environment International* 74: 274-280. <https://doi.org/10.1016/j.envint.2014.10.008>.
- [25] Horst Karl, Ulrike Kammann, Marc-Oliver Aust, Monika Manthey-Karl, Anja Lüth, Günter Kanisch (2016). Large scale distribution of dioxins, PCBs, heavy metals, PAH-metabolites and radionuclides in cod (*Gadus morhua*) from the North Atlantic and its adjacent seas. *Chemosphere* 149: 294-303. <https://doi.org/10.1016/j.chemosphere.2016.01.052>.
- [26] Jureša, D. and Blanuša, M. (2003). Mercury, arsenic, lead and cadmium in fish and shellfish from the Adriatic Sea. *Food Additives and Contaminants* 20 (3): 241-246.
- [27] Guerranti, C., Grazioli, E., Focardi, S., Renzi, M. and Perra, G. (2016). Levels of chemicals in two fish species from four Italian fishing areas. *Marine Pollution Bulletin* 111 (1-2): 449-452. <https://doi.org/10.1016/j.marpolbul.2016.07.002>.
- [28] Zhang Cheng, Wing-Yin Mo, Yu-Bon Man, Xiang-Ping Nie, Kai-Bing Li, Ming-Hung Wong (2014). Replacing fish meal by food waste in feed pellets to culture lower trophic level fish containing acceptable levels of organochlorine pesticides: Health risk assessments. *Environment International* 73: 22-27. <https://doi.org/10.1016/j.envint.2014.07.001>.
- [29] Vidal, J. (2017). Salmon farming in crisis: 'We are seeing a chemical arms race in the seas'. url: <https://www.theguardian.com/environment/2017/apr/01/is-farming-salmon-bad-for-the-environment>
- [30] Kelly BC, Ikonomou MG, Higgs DA, Oakes J, Dubetz C. (2011). Flesh residue concentrations of organochlorine pesticides in farmed and wild salmon from British Columbia, Canada. *Environment Toxicology and Chemistry* 30(11):2456-64. doi: 10.1002/etc.662.
- [31] Fernandez, C. and Sanhueza, S. (2019). Consequences of the use of pesticides in salmon farming in Chile. url: <http://latinamericanscience.org/2019/05/consequences-use-pesticides-salmon-farming-chile/>

- [32] Edwards, R. (2021). Farm salmon is now most contaminated food on shelf. url: <http://www.eurocbc.org/page223.html>, accessed February 21, 2021.
- [33] Yisheng P., Xulin L I, Kalan W U, Yongui P. and Guizhu, C. (2009) Effect of an integrated mangroves- aquaculture system on aquaculture health. *Frontiers of Biology in China* 4(4): 579-784.
- [34] Bhavsar, Dhara O, H. Pandya and Y. Jasrai (2016). Aquaculture and Environmental Pollution -A Review work. *International journal of scientific research in science, engineering and technology* 2: 40-45.
- [35] Gyllenhammar, A. and Hakanson, L. (2005). Environmental consequence analyses of fish farm emissions related to different scales and exemplified by data from the Baltic—a review. *Marine Environmental Research*, 60 (2): 211–243.
- [36] Focardi, S., Corsi, I. and Franchi, E. (2005). Safety issues and sustainable development of European aquaculture: new tools for environmentally sound aquaculture. *Aquaculture International* 13 (1-2): 3–17.
- [37] Martinez-Porchas, M. and Martinez-Cordova, L.R. (2012). World Aquaculture: Environmental Impacts and Troubleshooting Alternatives. *The Scientific World Journal* Volume 2012, Article ID 389623, 9 p. doi:10.1100/2012/389623.
- [38] Zhou, L. and Boyd, C.E. (2015). Ammonia Nitrogen Management in Aquaculture Ponds. *Aquaculture Magazine*. October 2015.
- [39] Sidoruk, M. and Cymes, I. (2018). Effect of Water Management Technology Used in Trout Culture on Water Quality in Fish Ponds. *Water* 10(9), 1264; <https://doi.org/10.3390/w10091264>.
- [40] Sindilariu, P.D.; Brinker, A.; Reiter, R. Waste and particle management in a commercial, partially recirculating trout farm. *Aquatic Engineering* 41:127–135.
- [41] Bergero, D., Forneris, G., Palmegiano, G.B., Zoccaratoc, I., Gasco, L. and Sicuro, B. (2001). A description of ammonium content of output waters from trout farms in relation to stocking density and flow rates. *Ecological Engineering* 17: 451 – 455.
- [42] Naylor, S., Drizo, A., Brisson, J. and Comeau, Y. (2003). Treatment of freshwater fish farm effluent using constructed wetlands: the role of plants and substrate. *Water Science and Technology* 48 (5): 215-222.
- [43] Drizo, A. (2019). Phosphorus Pollution Control: Policies and Strategies pp. 176. Wiley-Blackwell], October 2019. ISBN: 978-1-118-82548-8. |url: <https://www.wiley.com/en-us/Phosphorus+Pollution+Control%3A+Policies+and+Strategies-p-9781118825426>
- [44] Kelly, L.A., Bergheim, A. and Hennessy, M.M (1994). Predicting output of ammonium from fish farms. *Water Research* 28 (6):1403-1405. [https://doi.org/10.1016/0043-1354\(94\)90307-7](https://doi.org/10.1016/0043-1354(94)90307-7).
- [45] Bouwman, L., Beusen, A., Glibert, P.M., Overbeek, C., Pawlowski, M., Herrera, J., Mulsow, S., Yu, R. and Zhou, M. (2013). Mariculture: significant and expanding cause of coastal nutrient enrichment. *Environmental Research Letters* 8: 044026. doi:10.1088/1748-9326/8/4/044026
- [46] Glibert, P.M. and Burford, M.A. (2017). Changing Nutrient Loads and Harmful Algal Blooms: Recent Advances, New Paradigms, and Continuing Challenges. *Oceanography* 30 (1): 58–69. JSTOR, www.jstor.org/stable/24897842. Accessed 23 Feb. 2021.
- [47] Tornero, V. and Hank, G. (2016). Chemical contaminants entering the marine environment from sea-based sources: A review with a focus on European seas. *Marine Pollution Bulletin* 112 (2016) 17–38. <http://dx.doi.org/10.1016/j.marpolbul.2016.06.091>.
- [48] Dean, R.J., Shimmield, T.M. and Black, K.D. (2007). Copper, zinc and cadmium in marine cage fish farm sediments: An extensive survey. *Environmental Pollution* 145 (1): 84-95.
- [49] Grigorakis, K., Rigos, G. (2011). Aquaculture effects on environmental and public welfare – the case of Mediterranean mariculture. *Chemosphere* 855, 899–919. doi: 10.1016/j.chemosphere.2011.07.015.

- [50] Burridge, L.E., Weis, J.S., Cabello, F., Pizarro, J., Bostik, K. (2010). Chemical use in salmon aquaculture: a review of current practices and possible environmental effects. *Aquaculture* 306, 7–23.
- [51] Simpson, S.L., Spadaro, D.A., O'Brien, D. (2013). Incorporating bioavailability into management limits for copper in sediments contaminated by antifouling paint used in aquaculture. *Chemosphere* 93: 2499–2525.
- [52] Clement, D., Keeley, N. and Sneddon, R. (2010). Ecological Relevance of Copper (Cu) and Zinc (Zn) in Sediments Beneath Fish Farms in New Zealand. Prepared for Marlborough District Council. Report No. 1805. 48 p. url: <https://envirolink.govt.nz/assets/Envirolink/877-MLDC48-Ecological-relevance-of-Cu-and-Zn-in-sediments-beneath-fish-farms-in-NZ.pdf>
- [53] Willemsen, P.R. (2005). Biofouling in European aquaculture: is there an easy solution? *European Aquaculture Society (EAS) Special Publication* 35: 82–87.
- [54] Nikolaou, M., Neofitou, N., Skordas, K., Castritsi-Catharios, I., Tziantziou, L. (2014). Fish farming and anti-fouling paints: a potential source of Cu and Zn in farmed fish. *Aquaculture Environment Interactions* 5:163–171.
- [55] Guardiola, F.A., Cuesta, A., Meseguer, J., Esteban, M.A. (2012). Risks of using antifouling biocides in aquaculture. *International Journal of Molecular Science* 13:1541–1560.
- [56] Muñoz, I.; Martínez Bueno, M.J.; Agüera, A.; Fernández-Alba, A.R. (2010). Environmental and human health risk assessment of organic micro-pollutants occurring in a Spanish marine fish farm. *Environmental Pollution* 158: 1809–1816.
- [57] Hites, R.A., Foran, J.A., Carpenter, D.O., Hamilton, M.C., Knuth, B.A., Schwager, S.J. (2004). Global assessment of organic contaminants in farmed salmon. *Science* 303: 226–229.
- [58] Soon, Z.Y., Jung, J.H., Jang, M. et al. (2019). Zinc Pyrithione (ZnPT) as an Antifouling Biocide in the Marine Environment—a Literature Review of Its Toxicity, Environmental Fates, and Analytical Methods. *Water Air Soil Pollution* 230: 310. <https://doi.org/10.1007/s11270-019-4361-0>
- [59] Sowles, J. W., L. Churchill, and W. Silvert (1994). The effect of benthic carbon loading on the degradation of bottom conditions under farm sites, p. 31–46. In B. T. Hargrave [ed]. *Modelling Benthic Impacts of Organic Enrichment from Marine Aquaculture*. Can. Tech. Rep. Fish. Aquat. Sci. 1949:125 p. url: <https://www.maine.gov/dmr/aquaculture/reports/documents/benthic%20C%20loading%201994.pdf>
- [60] Belias, C.V., Bikas, V.G., Dassenakis, M.J. et al. Environmental impacts of coastal aquaculture in eastern Mediterranean bays the case of Astakos gulf, Greece. *Environ Sci & Pollut Res* 10, 287 (2003).
- [61] Mahmood, T., Fang, J., Jiang, Z., Ying, W. and Zhang, J. (2017). Seasonal distribution, sources and sink of dissolved organic carbon in integrated aquaculture system in coastal waters. *Aquaculture International* (2017) 25:71–85. DOI 10.1007/s10499-016-0014-0.
- [62] Mostofa KMG, Liu C, Mottaleb MA, Wan G, Ogawa H, Vione D, Yoshioka T, Wu F. (2013) Dissolved organic matter in natural waters. In: Mostofa KMG, Yoshioka T, Mottaleb MA, Vione D (eds). *Photobiogeochemistry of organic matter: principles and practices in water environments*. Environmental science and engineering, Springer, Berlin, pp 1–137.
- [63] Gunnvør á Nori, Glud, R.N., Gaard, E. and Simonsen, K. (2011). Environmental impacts of coastal fish farming: carbon and nitrogen budgets for trout farming in Kaldbaksfjørur (Faroe Islands). *Marine Ecology Progress Series* 431: 223–241. doi: 10.3354/meps09113.
- [64] Environment Australia (2001). Emissions Estimation Technique Manual for Aquaculture from Temperate Water Finfish Aquaculture (Environment Australia, Canberra, Australia). <http://www.npi.gov.au/system/files/resources/e2fdd93d-2693-7df4-89fb-5b5a849b730d/files/aquatemp.pdf>
- [65] OSPAR Commission (2000). Nutrient Discharges from Fish Farming in the OSPAR Convention Area <https://www.ospar.org/documents?v=6911>

- [66] US EPA (2004). Technical Development Document for the Final Effluent Limitations Guidelines and New Source Performance Standards for the Concentrated Aquatic Animal Production Point Source Category (Revised August 2004). url: https://www.epa.gov/sites/production/files/2015-11/documents/caap-aquaculture_tdd_2004.pdf
- [67] Islam, M.S. (2005). Nitrogen and phosphorus budget in coastal and marine cage aquaculture and impacts of effluent loading on ecosystem: review and analysis towards model development. *Marine Pollution Bulletin* 50: 48–61.
- [68] Foy, R.H. and Rosell, R. (1991). Loadings of nitrogen and phosphorus from a Northern Ireland fish farm. *Aquaculture* 96:17–30.
- [69] Earley PJ, Swope BL, Barbeau K, Bundy R, McDonald JA, Rivera-Duarte I. (2014). Life cycle contributions of copper from vessel painting and maintenance activities. *Biofouling*. 30:51–68. doi:10.1080/08927014.2013.841891
- [70] Patrick J. Earley, Brandon L. Swope, Marianne A. Colvin, Gunther Rosen, Pei-Fang Wang, Jessica Carilli & Ignacio Rivera-Duarte (2020). Estimates of environmental loading from copper alloy materials, *Biofouling*, 36:3, 276-291, DOI: 10.1080/08927014.2020.1756267
- [71] Gobas, F.A.P.C. (1993). A model for predicting the bioaccumulation of hydrophobic organic chemicals in aquatic food-webs: application to Lake Ontario. *Ecological Modelling* 69 (1–2):1-17. [https://doi.org/10.1016/0304-3800\(93\)90045-T](https://doi.org/10.1016/0304-3800(93)90045-T).
- [72] Mackay, D. and Fraser, A. (2000). Bioaccumulation of persistent organic chemicals: mechanisms and models. *Environmental Pollution* 110: 375-391.
- [73] Arnot, J.A. and Gobas, F.A.P.C. (2004). A food web bioaccumulation model for organic chemicals in aquatic ecosystems. *Environmental Toxicology and Chemistry* 23 (10): 2343-2355. <https://doi.org/10.1897/03-438>
- [74] USA EPA (2021). KABAM Version 1.0 User's Guide and Technical Documentation - Appendix A - Description of Bioaccumulation Model (Kow (based) Aquatic BioAccumulation Model). url: <https://www.epa.gov/pesticide-science-and-assessing-pesticide-risks/kabam-version-10-users-guide-and-technical-7>
- [75] FAO (2018). 2018 The State of World Fisheries and Aquaculture. Meeting the Sustainable Development Goals. 227 pp. url: <http://www.fao.org/3/i9540en/i9540en.pdf>
- [76] FAO (2020). 2020 The State of World Fisheries and Aquaculture. Sustainability in Action. 224 pp. url: <http://www.fao.org/3/ca9229en/ca9229en.pdf>
- [77] OECD (2021). OECD-FAO Agricultural Outlook 2020-2029. Chapter 8 Fish. url: <https://www.oecd-ilibrary.org/sites/4dd9b3d0-en/index.html?itemId=/content/component/4dd9b3d0-en>
- [78] FAO (1979). Development of Coastal Aquaculture in the Mediterranean region. Report of a mission to formulate a cooperative programme of activities October 1978 – February 1979 url: <http://www.fao.org/3/N7865E/N7865E00.htm>
- [79] Basurco, B. (1996). Mediterranean Aquaculture: Marine Fish Farming Development. url: <https://www.oceandocs.org/bitstream/handle/1834/544/BBasurco.pdf?sequence=1>
- [80] Barazi-Yeroulanos, L. (2010). Aquaculture In The Mediterranean. url: <https://thefishsite.com/articles/aquaculture-in-the-mediterranean>
- [81] FAO (2018). General Fisheries Commission for the Mediterranean. Report of the twentieth session of the Scientific Advisory Committee on Fisheries, Tangiers, Morocco, 26-29 June 2018. FAO Fisheries and Aquaculture Report No. R1245. Rome, Italy. 225 pp.
- [82] Boudouresque C-F, Blanfuné A, Pergent G, Pergent-Martini C, Perret-Boudouresque M and Thibaut T (2020). Impacts of Marine and Lagoon Aquaculture on Macrophytes in Mediterranean Benthic Ecosystems. *Frontiers in Marine Science* 7:218. doi: 10.3389/fmars.2020.00218
- [83] Massa, F., Onofri, L., and Fezzardi, D. (2017). Aquaculture in the Mediterranean and the Black Sea: a blue growth perspective. In: Bunes, P. A. L. D., Svernnson, L. E. and Markadya, A. (eds).

Hanbook on the Economics and Management of Sustainable Oceans. Cheltenham: Edward Elgar Publishing, pp. 93–122.

- [84] Kaleem, O., Bio, A-F. and Sabi, S. (2020). Overview of aquaculture systems in Egypt and Nigeria, prospects, potentials, and constraints. *Aquaculture and Fisheries*, 2020. <https://doi.org/10.1016/j.aaf.2020.07.017>.
- [85] Feidi, I. (2018). Will the new large-scale Aquaculture projects make Egypt self-sufficient in fish supplies? *Mediterranean Fisheries and Aquaculture Research* 1(1): 31–41. url: <https://dergipark.org.tr/en/pub/medfar/issue/34642/364877>
- [86] Elsheshtawy, A., Yehia, N., Elkemary, M., & Soliman, H. (2019). Investigation of Nile tilapia summer mortality in Kafr El-sheikh governorate, Egypt. *Genetics of Aquatic Organisms* 3(1):17–25. https://www.genaqua.org/uploads/pdf_26.pdf
- [87] JRC (2019). European and Mediterranean Aquaculture data collection and reporting under the Scientific, Technical and Economic Committee for Fisheries (STECF). *MedAid Mini-Reviews and Opinion Pieces*. url: <http://www.medaid-h2020.eu/index.php/2019/02/25/aquaculture-data-collection-stecf/>.
- [88] Duarte, C.M., Holmer, M., Olsen, Y., Soto, D., Marba, N, Guiu, J, Black, K. & Karakassis, I. 2009. Will the oceans feed humanity? *BioScience*, 59(11): 967–976. url: <https://academic.oup.com/bioscience/article/59/11/967/251334>
- [89] Lucas, J. and Southgate, P. (2012) *Aquaculture: farming aquatic animals and plants*. Wiley-Blackwell, West Sussex, UK, pp. 1-648.
- [90] Bardach, J.E. (1997) (Ed). *Sustainable Aquaculture*. John Wiley and Sons Inc. 251 pp.
- [91] Baluyut, E.A. (1989). *Aquaculture Systems and Practices: A Selected Review*. Report Number ADCP/REP/89/43. <http://www.fao.org/3/t8598e/t8598e00.htm#Contents>
- [92] La Don, S. (1992). A Basic Overview of Aquaculture. url: <http://citeseerx.ist.psu.edu/viewdoc/summary?doi=10.1.1.503.1826>
- [93] Froehlich H.E., Smith, A., Gentry, R.R. and Halpern B.S. (2017). Offshore Aquaculture: I Know It When I See It. *Frontiers in Marine Sciences* 4:154. doi: 10.3389/fmars.2017.0015
- [94] Halwart M, Soto D, and Arthur JR (2007). Cage aquaculture: regional reviews and global overview: Food and Agriculture Organization of the United Nations, Technical Paper 498. pp. 241.
- [95] Funge-Smith, S. and Phillips, M.J. (2001). *Aquaculture Systems and Species*. In: NACA/FAO, 2001. *Aquaculture in the Third Millennium*. Subasinghe, R.P., Bueno, P., Phillips, M.J., Hough, C., McGladdery, S.E., & Arthur, J.E. (Eds.) *Technical Proceedings of the Conference on Aquaculture in the Third Millennium, Bangkok, Thailand. 20-25 February 2000*. NACA, Bangkok and FAO, Rome. 471pp. url: <http://www.fao.org/3/AB412E/ab412e07.htm>
- [96] Subasinghe, R.P., Bueno, P., Phillips, M.J., Hough, C., McGladdery, S.E., & Arthur, J.E. (2001). (Eds.) *Technical Proceedings of the Conference on Aquaculture in the Third Millennium, Bangkok, Thailand. 20-25 February 2000*. NACA, Bangkok and FAO, Rome. 471pp. url: <http://www.fao.org/3/AB412E/ab412e01.htm>
- [97] Ashton, E.A. (2008). The impact of shrimp farming on mangrove ecosystems. *CAB Reviews: Perspectives in Agriculture, Veterinary Science, Nutrition and Natural Resources* 3 (003). url: doi: 10.1079/PAVSNR20083003.
- [98] Doyle, A. (2012). Mangroves under threat from shrimp farms: U.N. url: <https://www.reuters.com/article/us-mangroves-idUSBRE8AD1EG20121114>
- [99] Bales, K. (2016). How Hunger for Shrimp and Slavery Destroy Mangroves. url: <https://www.scientificamerican.com/article/how-hunger-for-shrimp-and-slavery-destroy-mangroves-excerpt/>
- [100] Cole, D.W., Cole, R., Gaydos, S.J., Gray, J., Hyland, G., Jacques, M.L., Powell-Dunford, Charu Sawhney, N. and Au, W.W. (2009). Aquaculture: Environmental, toxicological, and health issues, *International Journal of Hygiene and Environmental Health* 212 (4): 369-377. <https://doi.org/10.1016/j.ijheh.2008.08.003>.

- [101] Siemers, H. (2009). A European Integrated Maritime Policy: An Innovative Approach to Policy Making. *Ocean Yearbook Online* 23 (1): 231–249. DOI: <https://doi.org/10.1163/22116001-90000195>.
- [102] Ross, L.G., Telfer, T.C., Falconer, L., Soto, D., Aguilar-Manjarrez, J., Asmah, R., et al. (2013). Carrying capacities and site selection within the ecosystem approach to aquaculture. In L.G. Ross, T.C. Telfer, L. Falconer, D. Soto & J. Aguilar-Manjarrez, eds. *Site selection and carrying capacities for inland and coastal aquaculture*, pp. 19–46. FAO/Institute of Aquaculture, University of Stirling, Expert Workshop, 6–8 December 2010. Stirling, the United Kingdom of Great Britain and Northern Ireland. FAO Fisheries and Aquaculture Proceedings No. 21. Rome, FAO. 282 pp. <http://www.fao.org/3/i3099e/i3099e02.pdf>
- [1103] HELCOM (2021). Guidelines for the compilation for waterborne pollution load to the Baltic Sea (PLC-Water). http://archive.iwlearn.net/helcom.fi/groups/monas/en_GB/plcwaterguide/index.html, accessed February 24th, 2021.
- [1104] Environment Australia (2000), Emission Estimation Technique Manual for The Aquaculture of Barramundi, Prawns, Crocodiles, Pearl oysters, Red claw and Tropical abalone In Tropical Australia (Environment Australia, Canberra, Australia). <http://www.npi.gov.au/system/files/resources/70e0763a-7f21-0674-3d2d-d2b1c7d441ad/files/aquatropic.pdf>
- [1105] UNITAR (1998). UNITAR Series of PRTR Technical Support Materials - No. 3. Guidance on Estimating Non-point Source Emissions. url: https://cwm.unitar.org/cwmplatformscms/site/assets/files/1264/prtr_tech_support_3_nov2003.pdf
- [106] OECD (2020). Resource Compendium of PRTR release estimation techniques, Part II: Summary of Diffuse Source Techniques, Series on Pollutant Release and Transfer Registers No. 19. ENV/JM/MONO (2020)30. Published 25th November 2020.
- [107] IPCC (2019). 2019 Refinement to the 2006 IPCC Guidelines for National Greenhouse Gas Inventories. Calvo Buendia, E., Tanabe, K., Kranjc, A., Baasansuren, J., Fukuda, M., Ngarize, S., Osako, A., Pyrozhenko, Y., Shermanau, P. and Federici, S. (eds). Volume 1 General Guidance and Reporting. Chapter 6: Quality Assurance/Quality Control and Verification. Published: IPCC, Switzerland. url: <https://www.ipcc-nggip.iges.or.jp/public/2019rf/vol1.html>
- [108] Olsvik PA, Larsen AK, Berntssen MHG, Goksøyr A, Karlsten OA, Yadetie F, Sanden M and Kristensen T (2019). Effects of Agricultural Pesticides in Aquafeeds on Wild Fish Feeding on Leftover Pellets Near Fish Farms. *Frontiers in Genetics* 10:794. doi: 10.3389/fgene.2019.00794.
- [109] Koyama, J., Uno, S., Nagai, Y., Anukorn, B. (2016). Early monitoring of spilled oil contamination in Rayong, Thailand. *Japan Journal of Environmental Toxicology* 19: 25–33.
- [110] Ladwani, K.D., Ladwani, K.D., Ramteke, D.S. (2013). Assessment of poly aromatic hydrocarbon (PAH) dispersion in the near shore environment of Mumbai, India after a large-scale oil spill. *Bulletin of Environmental Contaminat Toxicology* 90: 515–520.
- [111] Erin L. Pulster, Adolfo Gracia, Maickel Armenteros, Brigida E. Carr, Justin Mrowicki, Steven A. Murawski (2020). Chronic PAH exposures and associated declines in fish health indices observed for ten grouper species in the Gulf of Mexico. *Science of The Total Environment* 703: 135551. <https://doi.org/10.1016/j.scitotenv.2019.135551>.
- [112] Honda, M. and Suzuki, N. (2020). Toxicities of Polycyclic Aromatic Hydrocarbons for Aquatic Animals. *International Journal of Environmental Research and public Health* 17: 1363. doi:10.3390/ijerph17041363.
- [113] Rengarajan, T., Rajendran, P., Nandakumar, N., Lokeshkumar, B., Rajendran, P., Nishigaki, I. (2015). Exposure to polycyclic aromatic hydrocarbons with special focus on cancer. *Asian Pacific Journal of Tropical Biomedicine* 5:182–189.
- [114] Nagel, F., Kammann, U., Wagner, C., Hanel, R., 2012. Metabolites of polycyclic aromatic hydrocarbons (PAHs) in bile as biomarkers of pollution in European eel (*Anguilla anguilla*) from German rivers. *Arch. Environ. Contam. Toxicol.* 62: 254e263.

- [115] El Deeb, K.Z., Said, T.O., El Naggar, M.H. et al. (2007). Distribution and Sources of Aliphatic and Polycyclic Aromatic Hydrocarbons in Surface Sediments, Fish and Bivalves of Abu Qir Bay (Egyptian Mediterranean Sea). *Bull Environmental Contaminants Toxicology* 78:373–379. <https://doi.org/10.1007/s00128-007-9173-z>
- [116] Ferrante M, Zanghì G, Cristaldi A, Copat C, Grasso A, Fiore M, Signorelli SS, Zuccarello P, Oliveri Conti G. (2018). PAHs in seafood from the Mediterranean Sea: An exposure risk assessment. *Food Chem Toxicol.* 2018 May; 115:385-390. doi: 10.1016/j.fct.2018.03.024. Epub 2018 Mar 24. PMID: 29580821.
- [117] Barni MFS, Ondarza PM, Gonzalez M, Da Cuña R, Mejjide F, Grosman F, Sanzano P, Lo Nostro FL, Miglioranza KSB (2016). Persistent organic pollutants (POPs) in fish with different feeding habits inhabiting a shallow lake ecosystem. *Science of Total Environment* 550: 900-909. doi: 10.1016/j.scitotenv.2016.01.176.
- [118] Solé M, Manzanera M, Bartolomé A, Tort L, Caixach J. Persistent organic pollutants (POPs) in sediments from fishing grounds in the NW Mediterranean: ecotoxicological implications for the benthic fish *Solea* sp. (2013). *Marine Pollution Bulletin* 67(1-2):158-65. doi: 10.1016/j.marpolbul.2012.11.018.
- [119] Julshamn, K., Duinker, A., Berntssen, M., Nilsen, B.M., Frantzen, S., Nedreaas, K., Maage, A. (2013). A baseline study of polychlorinated dibenzo-p-dioxins, polychlorinated dibenzofurans, non-ortho and mono-ortho PCBs, non-dioxin-like PCBs and polybrominated diphenyl ethers in Northeast Arctic cod (*Gadus morhua*) from different parts of the Barents Sea. *Mar. Pollut. Bull.* 75, 250e258.
- [120] Karl, H., Lahrssen-Wiederholt, M. Dioxin and dioxin-like PCB levels in cod-liver and -muscle from different fishing grounds of the North- and Baltic Sea and the North Atlantic. *J. Verbr. Lebensm.* 4, 247 (2009). <https://doi.org/10.1007/s00003-009-0308-5>.
- [121] Thiele, C.J., Hudson, M.D., Russell, A.E., Saluveer, M. and Sidaoui-Haddad, G. (2021). Microplastics in fish and fishmeal: an emerging environmental challenge?. *Science Report* 11: 2045 (2021). <https://doi.org/10.1038/s41598-021-81499-8>
- [122] Wright, S. L., Thompson, R. C. & Galloway, T. S. (2013). The physical impacts of microplastics on marine organisms: A review. *Environmental Pollution.* 178: 483–492.
- [123] Lusher, A., Hollman, P. and Mendoza-Hill, J. (2017). Microplastics in fisheries and aquaculture. Status of knowledge on their occurrence and implications for aquatic organisms and food safety. *FAO Fisheries and Aquaculture Technical Paper* 615. url: <http://www.fao.org/3/i7677e/i7677e.pdf>
- [124] Collignon A, Hecq JH, Glagani F, Voisin P, Collard F, Goffart A. Neustonic microplastic and zooplankton in the North Western Mediterranean Sea (2012). *Marine Pollution Bulletin* 64(4):861-4. doi: 10.1016/j.marpolbul.2012.01.011.
- [125] Olgaç Güven, Kerem Gökdağ, Boris Jovanović, Ahmet Erkan Kideys (2017). Microplastic litter composition of the Turkish territorial waters of the Mediterranean Sea, and its occurrence in the gastrointestinal tract of fish. *Environmental Pollution* 223: 286-294, <https://doi.org/10.1016/j.envpol.2017.01.025>.
- [126] Zhang W, Zhang S, Wang J, Wang Y, Mu J, Wang P, Lin X, Ma D. Microplastic pollution in the surface waters of the Bohai Sea, China. *Environ Pollut.* 2017 Dec;231(Pt 1):541-548. doi: 10.1016/j.envpol.2017.08.058. Epub 2017 Aug 29. PMID: 28843202.
- [127] Mohamed Attia Sheradah, Amany Ahamed El-Sikaily, Nehad Mohamed Abdel Moneam, Nabila El Sayed Abdel Maguid and Marwa Gaber Zaki (2018). Polychlorinated Biphenyls (PCBs) and Pesticides in Sediments and *Siganus rivulatus* from Two Areas Along the Egyptian Mediterranean Coast. *Current Environmental Engineering*5: 168. <https://doi.org/10.2174/2212717805666181009101510>
- [128] Lazartigues A, Thomas M, Cren-Olivé C, Brun-Bellut J, Le Roux Y, Banas D, Feidt C. (2013). Pesticide pressure and fish farming in barrage pond in Northeastern France. Part II: residues of 13 pesticides in water, sediments, edible fish and their relationships. *Environmental Science Pollution Research International* 20(1):117-25. doi: 10.1007/s11356-012-1167-7.

- [129] Ytrestøyl, T., Aas, T. S., and Asgard, T. (2015). Utilisation of feed resources in production of Atlantic salmon (*Salmo salar*) in Norway. *Aquaculture* 448: 365–374. doi: 10.1016/j.aquaculture.2015.06.023.
- [130] Cheung KC, Leung HM, Kong KY, Wong, MH. (2007). Residual levels of DDTs and PAHs in freshwater and marine fish from Hong Kong markets and their health risk assessment. *Chemosphere* 66:460–8.
- [131] Wang HS, Chen ZJ, Wei W, Man YB, Giesy JP, Du J, et al. (2013). Concentrations of organochlorine pesticides (OCPs) in human blood plasma from Hong Kong: markers of exposure and sources from fish. *Environment International* 54:18–25.
- [132] Portoles, T., Ibanez, M., Garlito, B., Nacher-Mestre, J., Karalazos, V., Silva, J., et al. (2017). Comprehensive strategy for pesticide residue analysis through the production cycle of gilthead sea bream and Atlantic salmon. *Chemosphere* 179: 242–253. doi: 10.1016/j.chemosphere.2017.03.099.
- [133] Polat, A., Polat, S., Simsek, A. et al. (2018). Pesticide residues in muscles of some marine fish species and seaweeds of Iskenderun Bay (Northeastern Mediterranean), Turkey. *Environ Sci Pollut Res* 25, 3756–3764 (2018). <https://doi.org/10.1007/s11356-017-0756-x>
- [134] M.M. Storelli, S. Losada, G.O. Marcotrigiano, L. Roosens, G. Barone, H. Neels, A. Covaci (2009). Polychlorinated biphenyl and organochlorine pesticide contamination signatures in deep-sea fish from the Mediterranean Sea. *Environmental Research* 109 (7): 851-856. <https://doi.org/10.1016/j.envres.2009.07.008>.
- [135] Kasiotis, K. (2009). Organochlorine Pesticides Residues in Mussels of Greek Island Evia. *International Journal of Chemistry* 1(2): 1-9. 10.5539/ijc.v1n2p3
- [136] Masci M, Orban E, Navigato T. (2013). Organochlorine pesticide residues: an extensive monitoring of Italian fishery and aquaculture. *Chemosphere* 94:190-198. doi:10.1016/j.chemosphere.2013.10.016.
- [137] Roque Serrano, Mercedes Barreda, Miguel A. Blanes (2008). Investigating the presence of organochlorine pesticides and polychlorinated biphenyls in wild and farmed gilthead sea bream (*Sparus aurata*) from the Western Mediterranean Sea. *Marine Pollution Bulletin* 56 (5): 963-972. <https://doi.org/10.1016/j.marpolbul.2008.01.014>.
- [138] Ibrahim, L., Preuss, T. G., Ratte, H. T., & Hommen, U. (2013). A list of fish species that are potentially exposed to pesticides in edge-of-field water bodies in the European Union—a first step towards identifying vulnerable representatives for risk assessment. *Environmental science and pollution research international*, 20(4), 2679–2687. <https://doi.org/10.1007/s11356-013-1471-x>
- [139] Petrenya, N., Dobrodeeva, L., Brustad, M., Bichkaeva, F., Menshikova, E., Lutfaliev, G., Poletaeva, A., Poletaeva, A., Repina, V., Cooper, M. et al. (2011). Fish consumption and socio-economic factors among residents of Arkhangelsk city and the rural Nenets autonomous area. *International Journal of Circumpolar Health* 70: 46–5.
- [140] European Commission (2021). Sustainable blue economy. A new approach for a sustainable blue economy in the EU. url: https://ec.europa.eu/oceans-and-fisheries/ocean/blue-economy/sustainable-blue-economy_en
- [141] European Commission (2021). Communication from the Commission to the European Parliament, the Council, The European Economic and Social Committee and the Committee of the Regions on a new approach for a sustainable blue economy in the EU Transforming the EU's Blue Economy for a Sustainable Future. COM/2021/240 final. Document 52021DC0240. url: <https://eur-lex.europa.eu/legal-content/EN/TXT/?uri=COM:2021:240:FIN>

Appendix 32

**Guideline on estimation techniques and applied methodologies for non-point source releases
from catchment runoffs**

1. Introduction

1. Following the 21st Meeting of the Contracting Parties to the Barcelona Convention COP21 (held in Napoli, Italy, 2-5 December 2019)⁵⁹⁶ and the adoption of Decision IG.24/14,⁵⁹⁷ the Programme of Work mandated MEDPOL Programme to develop/update technical guidelines addressing estimation techniques of pollutant releases from diffuse sources (agriculture, catchments runoff and aquaculture).

2. To assist countries, updated NBB guidelines were developed in 2015 (UNEP(DEPI)/MED WG.404/7 Annex IV, Appendix B, Page 11). However, these updated NBB guidelines, do not offer means by which pollutants from non-point (diffuse) sources can be estimated. This point was discussed at the Regional Meeting on Reporting of Releases to Marine and Coastal Environment from Land Based Sources and Activities and Related Indicators, which was held in Tirana, Albania on 19-20 March 2019. During the Meeting it was highlighted that reporting of diffuse sources can be only undertaken based on estimation techniques and emission factors which may vary on national and regional levels of each country. Therefore, the recommendation was made to support the Contracting Parties to complement the National Baseline Budget/Pollution Release and Transfer Registers (NBB/PRTRs) methodology with estimation techniques for diffuse sources attributed to catchment runoff).

3. The aim of this guidance document is to provide an overview of estimation techniques and applied methodologies for non-point (diffuse) sources releases to water originating from catchment runoffs focusing on releases of Total Nitrogen (TN), Total Phosphorus (TP) and Total Organic Carbons (TOC) in order to assist the Contracting Parties to the Barcelona Convention on their calculations/estimations under the National Baseline Budget and Pollution Releases and Transfer Registers (NBB/PRTR).

4. Although the review has been made on a global scale, the major focus of this document is on the Mediterranean region.

5. This guidance document has been prepared with the following steps:

- a. **an extensive literature review** (over 80 research papers, documents, and reports) focusing on three key subjects:
 - i. Non-point (diffuse) Discharges to Water (focusing on catchment runoff characteristics and relevant pollutants from agriculture including nutrients, sediment, total organic carbon (TOC) and veterinary antibiotics and pharmaceuticals).
 - ii. Different approaches, methods and techniques recommended for use in current inventories and technical reports to estimate the above pollutant loadings to water from agricultural non-point (diffuse) sources catchment runoffs
 - iii. Peer reviewed research papers describing methodologies and techniques proposed to estimate discharges to water from the above agricultural non-point (diffuse) sources.
 - iv. In addition, we also reviewed potential issues and drawbacks regarding accuracy and uncertainty associated with the proposed calculation methods, techniques and approaches.

⁵⁹⁶ <https://www.unenvironment.org/unepmap/events/meeting/21st-meeting-contracting-parties-convention-protection-marine-environment-and>

⁵⁹⁷ https://wedocs.unep.org/bitstream/handle/20.500.11822/31712/19ig24_22_2414_eng.pdf

- b. **streamline the most appropriate methodologies and techniques** to estimate nutrients, sediment, TOC and veterinary antibiotics and pharmaceuticals discharges agricultural non-point (diffuse) sources to water via catchments runoff.
- c. **integrate this new information to create a guidance** of the methods and techniques to assist contracting parties in estimations of the pollutants emissions to air and discharges to water and land originating from farming of animals and agriculture non-point (diffuse) sources.

6. These guidelines will facilitate the monitoring of implementation of the Regional Plans for Agriculture and Stormwater Management, which will be developed in the biennium 2022-2023. Thus, the newly proposed techniques for estimation of pollution loads will enable the generation of compatible data to evaluate the effectiveness of the adopted measures in the framework of the National Action Plans and the new Regional Plans for Agriculture and Stormwater Runoff Management.

2. Non-point (diffuse) Discharges to Water

2.1 Runoff Characteristics

7. Runoff is the water consisting of surface and subsurface flows which occur when rainfall exceeds the soil infiltration rate (Box 1.1). Depending on the speed of appearance after rainfall or melting snow (a), and the source (b), the US Geological Survey (USGS) [2] classifies runoff as: *Direct or Base runoff (a) and Surface runoff, Storm interflow, or Groundwater (subsurface) runoff (b)*.

Box 1.1: Definitions of runoff. Source USGS [1].

1. The part of the precipitation, snow melt, or irrigation water that appears in uncontrolled (not regulated by a dam upstream) surface streams, rivers, drains or sewers.
2. The sum of total discharges described in (1), above, during a specified time period.
3. The depth to which a watershed (drainage area) would be covered if the entire runoff for a given period of time were uniformly distributed over it.

8. Factors affecting the runoff are summarized in Table 1:

Table 1: Meteorological and Physical factors influencing runoff (adapted from [2]).

Meteorological factors	Physical characteristics
<ul style="list-style-type: none"> • Type of precipitation (rain, snow, sleet, etc.) • Rainfall intensity • Rainfall amount • Rainfall duration • Distribution of rainfall over the watersheds • Direction of storm movement • Antecedent precipitation and resulting soil moisture • Other meteorological and climatic conditions that affect evapotranspiration, such as temperature, wind, relative humidity, and season. 	<ul style="list-style-type: none"> • Land use • Vegetation • Soil type (e.g., infiltration) • Drainage area • Basin/catchment shape • Elevation • Slope • Topography • Direction of orientation • Drainage network patterns

2.2 Catchment Runoff

9. As the goal of this document is to provide guidance to estimate pollution (nutrients, total organic carbon, pathogens, emerging contaminants) loads originating from the agricultural activities carried by catchments runoff, it is important to distinguish between catchment and watershed areas. Catchment area is defined as an area from which water drains into a particular lake, river, etc.; for example, the catchment area of a large river with its tributaries (Figure 1). Watershed (or a drainage basin) is defined as the topographical boundary dividing two adjacent catchment basins, such as a ridge or a crest. It is a region of land within which water flows down into a specified body, such as a river, lake, sea, or an ocean.

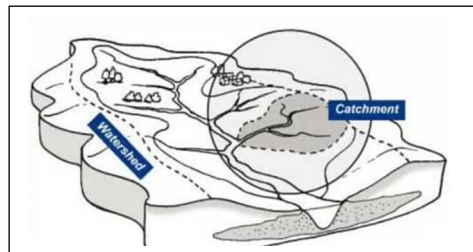

Figure 1: Catchment and watershed areas

2.2.1 Nature of the source and relevant pollutants from agriculture

10. Catchments in rural areas are influenced by direct anthropogenic impacts from both point and non-point nutrient sources. Catchment runoff originating from agricultural non-point (diffuse) sources includes surface and subsurface flows from animal farm and feeding operations, cropping systems, their field level interactions (both temporal and spatial) and climate (storm frequency and hydrology, temperature). Estimating pollution loadings and controlling this type of contamination is highly complex and requires integration of scientific, technological, socio-economical and educational factors [7-10].

11. Nutrients (total nitrogen and phosphorus) contained in catchment runoff from non-point (diffuse) agricultural sources are of the greatest concern and thus the most typically estimated [1] [8-11] [13-19]. These pollutants are also included in Annex (I) of the LBS Protocol and listed in the Annex IV of the NBB/PRTR Guidance (UNEP(DEPI)/MED WG.404/7)⁵. Other pollutants include total organic carbon [20-23] and veterinary antibiotics and pharmaceuticals [24-29].

Nutrients

12. Catchment runoff from non-point (diffuse) agricultural sources contains excessive quantities of nutrients which results in nutrient enrichment (eutrophication) of lakes and coastal waters [7-10] [13-15]. The European Environment Agency (EEA) declared eutrophication as a pan-European problem of a major concern 25 years ago [30-31]. Despite all the efforts and vast investments, it remains a major threat to achieving the good status of waters required by the WFD [4-6][31].

13. Eutrophication has numerous detrimental impacts on the environment, health (animal and human) and the economy. These are summarized in Table 2:

Table 2: Impacts of Eutrophication (Source: Drizo [31]).

Impact	Reference
Intensified growth and production of algae, cyanobacteria (blue-green algae) and aquatic plants usually appearing as algal scums or floating mats of plants and commonly referred to as “algal blooms”. This excessive abundance in vegetation and bacteria increases respiration rates causing significant fluctuations in dissolved oxygen (DO) concentrations and water transparency, eventually leading to hypoxia.	e.g. Corell, 1998 [32]; Smith and Schindler, 2009 [33]; Ansari et al, 2011 [34].
Fish kills and reduced biodiversity. Low DO causes loss of invertebrates and fish and through their decay, algae and bacteria proliferation, further reducing oxygen content of water and loss of biodiversity.	Corell, 1998 [32]; Ansari et al, 2011 [34]; Hautier et al, 2009 [35].

<p>Toxins excretion. Certain algal species, including cyanobacteria, produce toxins that may seriously affect the health of fish, birds and mammals. This can occur either through the food chain, or direct contact or ingestion of the algae. Recent studies revealed that most cyanobacteria produce the neurotoxin beta-N-methylamino-L-alanine (BMAA) which had been linked with the development of neurodegenerative diseases (Alzheimer's and Parkinson's diseases, and Amyotrophic Lateral Sclerosis (ALS)).</p>	<p>Briand et al, 2003 [36]; Banack et al, 2010 [37]; Brand et al, 2010 [38].</p>
<p>Aesthetics. Eutrophication causes increased turbidity, unpleasant odours, slimes and foam formation diminishing aesthetic value of waters.</p>	<p>e.g. Corell, 1998 [32]; Ansari et al, 2011 [34];</p>
<p>Considerable economic losses. Algal blooms reduce potable water supplies, property values, tourism and recreation. The losses of local economies due to eutrophication were estimated at \$2.2 billion per year in the USA in 2009, and between £75 to £114.3 million per year for England and Wales in 2003.</p>	<p>Dodds, 2009 [39]; Pretty et al, 2003 [40].</p>

14. Global Climate Change will promote cyanobacterial growth and exacerbate algal blooms at much larger scales, further diminishing water availability and potable water supplies [41-42] [31].

Total Organic Carbon (TOC)

15. The chemical composition and concentration of organic matter influence many critical biogeochemical processes in rivers. Human activities in agricultural catchments may alter the quantity and composition of organic matter delivered to rivers resulting in adverse effects on ecosystems and society [21-23][47]. For example, riverine dissolved organic carbon (DOC) contributes energy to aquatic food webs through uptake by microbes and abiotic processes that produce bioavailable particulate organic carbon (POC) from DOC (flocculation and sediment adsorption). TOC (DOC plus POC) influences light attenuation in rivers with effects on primary productivity and autochthonous DOC production. An elevated organic content promotes increase in the growth of microorganisms which contribute to the depletion of oxygen supplies and water transparency [21-23][47]. Decreased dissolved oxygen (DO) concentrations can cause loss of invertebrates and fish and loss of biodiversity.

Veterinary antibiotics and pharmaceuticals

16. The widespread use of large quantities of veterinary antibiotics and pharmaceuticals (tetracyclines, elfamycins, macrolides, lincosamides, polyethers, beta-lactams, quinoxalines, streptogramins, and sulfonamides, carbadox, amprolium, carbadox) in agricultural animal operations has become an issue of a global public health concern [24-29] [48-51].

17. In Europe, one-third of antibiotics consumption is related to veterinary use in livestock production for disease prevention, and for subtherapeutic use as a feed supplement for a growth promotion [27]. These antibiotics and supplements can make selective pressure on bacteria and boost growth of bacteria resistant to the effects of antimicrobials in the gastrointestinal tract of livestock. Manure from antibiotic treated livestock also contain unmetabolized antibiotics that facilitate development of the anti-microbial resistance (AMR). AMR is a natural mechanism in bacteria which prevents antibiotic bactericidal properties, thus rendering treatments ineffective [27-29][49]. Moreover, it can pass to pathogenic bacteria and potentially cause an incurable infection. In 2019, the UN Interagency Coordination Group (IACG) on Antimicrobial Resistance released a report highlighting that drug-resistant diseases already cause at least 700,000 deaths globally a year, and that number of deaths could increase to 10 million per year globally by 2050. The IACG also underlined that the economic damage of uncontrolled antimicrobial resistance could be comparable to those experienced during the 2008-2009 global financial crisis and result in dramatically increased health care expenditures, adverse impacts on food and feed production, trade and livelihoods, and increased poverty and inequality [51].

3. Description of techniques for estimating discharges from agricultural non-point (diffuse) sources releases to water via catchment runoffs

18. Several researchers investigated, modelled and attempted to estimate diffuse pollution loads and the effects of policy and mitigation measures at the catchment scales [12-23] [64-71]. However, models' accuracy is dependent on data input, whose collection for non-point (diffuse) sources is highly complex and expensive [70] [55-56][1][11]. Richards [70], NSW EPA National Pollutant Inventory [54] and US EPA National Management Measures to Control Nonpoint Source Pollution from Agriculture [56-57] provide comprehensive descriptions of load estimation techniques and problems associated with the fact that pollutant concentrations are generally sampled infrequently, often at routine intervals (i.e., daily, weekly, monthly, or seasonally). Additional information on "Non-point/diffuse Sources Pollution Inventories" are provided in Annex I.

19. These aforementioned documents highlight the fact that there are many different techniques used for calculating load estimates, varying in complexity, accuracy and bias. Factors affecting the choice of technique may depend on the data resolution, the operator's skills and mathematical ability, the computer technology available, and data collection methods employed.

3.1 Pollutant Load Estimation Methods and Techniques

3.1.1 Averaging

20. Averaging methods are generally considered to be the simplest available techniques for pollutant load (PL) estimation and are often applied because of an absence of more appropriate techniques. Estimates of PL over a time period are made by multiplying the average concentration (in that time period) by mean daily flow for each day in the time period to obtain a succession of estimated daily (unit) loads. Another approach involves multiplying the average observed concentration by the average flow based on all days of the year to obtain an "average" daily load, which is then converted to the total load [54][70]. The NSW EPA provides information on 14 different averaging techniques and equations used for the determination of annual riverine loads [54].

3.1.2 Ratio estimators

21. Ratio estimators determine the average daily load for the days with concentration observations, adjust it proportionally by reference to some parameter which is more thoroughly sampled and then calculate the total annual load by multiplying the adjusted daily load by 365 [54][70]. The most common parameter used for adjustment is discharge data, with ratio estimate calculated as:

$$Y_R = (y/x) X \quad (\text{Equation 3.1})$$

where:

y and x are the sample means of y_i (load data) and x_i (discharge data)

YR is the ratio estimate of a load and

X is the discharge.

22. Richards pointed out that while multivariate ratio estimators involving more than one adjustment parameter have been described in the statistical literature, the mathematics are very complex, and consequently such estimators have not been applied to load estimation problems [70].

23. Ratio estimators assume that there is a linear relationship between the daily loads and the adjustment parameter, which passes through the origin. As these conditions will not be met in the field, ratio estimators are often biased [54][70]. Several researchers developed estimators which include correction terms which eliminate or greatly reduce the bias (e.g. [72] (p. 150-186)).

3.1.3 Regression estimators

24. Regression estimators, commonly referred to as rating curves, are based on extrapolating a limited number of concentration measurements over the entire period of interest by developing a relationship between pollutant concentration or load and stream discharge, and applying this relationship to the entire discharge record [54][70]. Most regression estimators are based on a linear regression model, however, log transformation is frequently used, because many environmental parameters are approximately log-normally distributed and the log of pollutant load or concentration is assumed to be a linear relationship of the log of stream discharge.

25. However, a number of studies have shown that the regression curve estimates based on such log–log relationship are biased, in particular in predicting sediment loads [54].

26. The problems most encountered with regression estimators and attempts to overcome them have been discussed in detail in [54] and [70].

3.2 Nutrients

27. As stated earlier, documents on inventories on discharges to water provided by national governments and international agencies for countries to use are currently lacking. MED POL will thus use techniques proposed in peer reviewed scientific literature.

28. Malve et al. [69] developed an export coefficient model of diffuse pollution at large scales with the aim to provide reasonable estimates across the whole of Europe based on readily accessible datasets, and that would be agreeable to application within a gridded model of water quality loadings to surface waters. They used a linear export coefficient model and data from a set of observed river basins to estimate terrestrial diffuse non-point pollution loads. Total annual load transported out of observed catchments was calculated by summing up the loads from all land uses together with estimated losses from scattered settlement and point sources, by multiplying it with a retention coefficient and by subtracting the resulting amount with retention in lakes, as following:

$$L_j = r_1 * \left\{ \sum_{i=1}^n (e_i * C_{i,j}) + (S_j + P_j) \right\} - r_2 * lake_j \quad (\text{Equation 3.2})$$

where:

L_j = total load from terrestrial sources ($\text{kg km}^{-2} \text{y}^{-1}$)

r_1 = retention coefficient within the catchment and in streams, excluding lakes

e_i = export coefficient for I ($\text{kg y}^{-1} C_{i,j}$)

$C_{i,j}$ = characteristic (i) of catchment (j)

S_j = load from scattered settlement in a catchment j ($\text{kg km}^{-2} \text{y}^{-1}$)

P_j = load from point sources in a catchment j ($\text{kg km}^{-2} \text{y}^{-1}$)

r_2 = retention per lake percentage ($\text{kg km}^{-2} \text{y}^{-1} \%^{-1}$)

$lake_j$ = lake percentage of catchment j (%)

29. Detailed calculations of the linear export coefficient model for parameters required for NBB Reporting i.e., biochemical oxygen demand (BOD), total nitrogen (TN) and total phosphors (TP) can be found in [69]. The coefficients were fitted to data from European Union European Environment Agency databases of 79–106 selected river basins around Europe. The study showed that estimated export coefficients were on a reasonable level with estimates made by other methods within Europe. The main findings were that

- i) runoff, number of livestock and point load were common factors for BOD, TP and TN loads with runoff as the most important factor;
- ii) cropland area also contributed to diffuse TN load;

- iii) average slope steepness and runoff, as a combined factor, had a negative effect on diffuse TP load and iv) lake area reduced diffuse loads.

30. The authors pointed out that a larger set of data with higher spatial and temporal resolution and partitioning of the data based on, e.g., climate or spatial patterns would further improve the precision of the export coefficient estimates. Moreover, that when applied at the catchment scale, the parameters should be updated with local data. Finally, that an integration of data from the administrative monitoring, modelling and management of river basins would bring an improvement in data availability, model predictions and cost efficiency of management measures and policies.

31. Zhang et al. [65] used the ADAS Agricultural Pollutant Transfer (APT) framework to generate nitrogen, total phosphorus and sediment loading from non-point (diffuse) agricultural sources in England and Wales. The ADAS APT framework was developed for national scale modelling for policy support [73]. The framework predicts pollutant losses from agricultural land and woodland at field scale and includes pollutant loadings delivered to watercourses. A waterbody is represented as a great number of fields which are then subject to landscape scale retention to estimate delivery of pollution from agricultural land to rivers. Both surface and subsurface (land drainage) are included as delivery pathways. The framework requires three core types of data: daily weather information, physical attributes of the land, and crop and livestock management data. Detailed information can be found in [65] and [73].

32. More recently, Malago et al. [14] developed a conceptual statistical regression model (GREEN-Rgrid), to estimate nutrient fluxes into the Mediterranean Sea. The major benefit of this model is that that links nutrient inputs to water quality measurements. It runs on an annual basis on a routing grid cell structure to establish the emitting-receiving grid cell relationship, where the upstream nutrient load is added as an additional point source to the receiving downstream grid cell. This model can be used to estimate total nitrogen (TN) and phosphorus (TP), nitrate (N-NO₃) and orthophosphate (P-PO₄) from both non-point (diffuse) and point sources.

33. The load at the outlet of a grid cell is expressed as:

$$L_i = [\text{SUR}_i S_i R_i + (\text{PS}_i + \text{UL}_i) R_i] * (1-\text{RES}_i) \quad (\text{Equation 3.3})$$

where:

i represents the grid cell

L = is the annual nutrient load (ton y⁻¹)

SUR= the nutrient (nitrogen and phosphorus) surplus in the grid cell (ton y⁻¹)

PS = the point sources (ton y⁻¹)

UL = the upstream load (ton y⁻¹)

S and R = the soil and river reduction factors in each grid cell (dimensionless)

RES = the nutrient retention in lakes/reservoirs (dimensionless)

3.3 Total Organic Carbon (TOC)

34. Andrén and Kätterer [75] developed the Introductory Carbon Balance Model, ICBM as an instrument for predicting soil carbon balances in Swedish agricultural land. However, the authors pointed out that the model could also be used for other estimates of soil carbon dynamics, and that the Swedish regions could be replaced with any number of regions anywhere in the world. A detailed description of model assumptions and parameterization are described in detail in [75]. The authors also highlighted that for the general application of the model it is crucial to find ways to obtain good parameter values when available data are less complete and proposed a few strategies.

35. Nadeu [76] conducted a thorough review of models attempting to simulate erosion-induced C fluxes at the catchment or regional scale. The author pointed out that the only model that considers the effect of tillage erosion on soil and C redistribution is the SPEROS-C model [77] and highlighted that this model has been applied successfully in small agricultural catchments allowing to quantify C exported and redistributed at each site and its associated vertical fluxes [75][77]. The SPEROS-C

model consists of a soil redistribution component based on the SPEROS model [77] and a soil organic carbon (SOC) dynamics component based on the ICBM model [75]. The importance of SPEROS-C model is that simulates redistribution of sediments and the associated C both laterally, i.e., spatially between soil profiles, and vertically, i.e., within the soil profiles due to burial and erosion. It therefore integrates the soil erosion component in the evolution of the SOC at the slope or catchment scale and it does this through a multiple-layer approach.

36. More recently, Boix Fayos et al [21] used Nadeu's approach to estimate the total organic carbon (TOC) redistributed TOC_{red} by lateral flows at the catchment scale:

$$TOC_{red} = 0.26 \times TOC_{red} + 0.20 \times TOC_{red} + \sum TOC_{CD} + \sum TOC_{exp} \quad (\text{Equation 3.4})$$

where:

0.26 = the fraction of sediment that it is redeposited at the hillslopes after initial erosion extracted from modelling exercises at the sub-catchment level in the Rogativa catchment, Spain [75]

0.20 = the fraction of soil organic carbon that is mineralized during transport and deposition processes, extracted from literature review

TOC_{red} = redistributed total organic carbon

TOC_{CD} = total organic carbon stored in alluvial wedges behind check-dams

TOC_{exp} = represents organic carbon exported downstream check-dams, being both estimated from the volume and the density of sediments retained by check-dams and their trap efficiency

3.4 Veterinary antibiotics and pharmaceuticals

37. Wöhler et al [29] recently assessed pharmaceutical water pollution from both human and veterinary pharmaceuticals at three geographical levels: global, national (considering Germany and the Netherlands) and catchment level.

38. For veterinary pharmaceutical loads, they made separate estimates per animal type (beef cattle, dairy cattle, pigs, broiler and laying hens) for Germany and the Netherlands as a whole and for the for Vecht catchment, which is shared between the two countries. The main emission pathways via direct (excretion of grazing animals) and indirect (manure collection and application) emissions were taken into consideration.

39. Aggregated loads per pharmaceutical and livestock type were defined as:

$$L_t[i] = L_d[i] + \sum_m L_{in}[i, m] \quad (\text{Equation 3.5})$$

where:

$L_t[i]$ = the total load of a specific veterinary pharmaceutical from livestock type i (kg y^{-1})

$L_d[i]$ = the load from manure directly emitted to pastureland (kg y^{-1})

$L_{in}[i, m]$ = the indirect load from manure type m (liquid or solid) applied to fields after temporary storage.

40. Direct loads were estimated according to the method developed by Boxal et al. [78] as following:

$$L_d[i] = 365 \times a[i] \times f_e \times f_d[i] \quad (\text{Equation 3.6})$$

where:

a = the administered substance per day (kg d^{-1})

f_e = the excreted fraction

f_d = the fraction directly emitted to pastureland.

41. The pharmaceutical load from manure that has been stored before application to fields was estimated per livestock type i and manure type m (liquid or solid) using a first-order degradation model, assuming constant production of manure over time.

$$L_{in}[i, m] = \frac{365}{T[i, m]} \times \left(\frac{a[i] \times f_e \times (1 - f_d[i]) \times f_{man}[i, m]}{k[i, m]} \times (1 - e^{-k[i, m] \times T[i, m]}) \right) \quad (\text{Equation 3.7})$$

where:

$365/T$ = the number of storage periods per year

a = the administered substance per day (kg d^{-1})

f_e = the excreted fraction

$(1 - f_d)^{[i]}$ = the fraction of the daily production that is stored

$f_{man}^{[i, m]}$ = the fraction of manure type m

k = the degradation rate (day^{-1}); By definition, $k = \ln(2)$ divided by the half-life of the substance (which differs per type of manure and livestock type).

T = duration of one storage period (days)

42. The quantities of administered substances (separately for beef cattle, dairy cattle, pigs, broilers and laying hens) were estimated from the veterinary pharmaceutical sales data. Data on pharmaceutical degradation during manure storage were obtained from literature. Due to the lack of livestock-specific data, the authors assumed the same excretion fractions as in human metabolism.

43. Data sources and assumptions for the model can be found in the Supplemental Information⁵⁹⁸ of the research paper.

44. The researchers pointed out that while pharmaceutical transport to water through leaching and runoff has been investigated in experimental trials, modelling attempts and risk assessment methods, a comprehensive method is lacking.

45. Annex II provides overview information of “Release Estimation Techniques and Applied Methodologies for Estimation of Releases of Pollution from Catchments Runoff.”

3.5 Comments on reliability Accuracy and uncertainty in calculations

46. The reviewed studies and inventories underline that there are often large differences between measured and estimated loads computed using different methods. The reasons reported include a variety of factors including the lack of consideration of topography and soil erosion, climatic factors and the inaccurate interpretation/categorisation of land use classes, lack of reliable data [1][11] [52][54][64] [69-70]. The OECD Compendiums [1][11] recommend that in situation when data are poor or lacking, it is preferable not to rely on a single estimation technique and that in such cases, all the assumptions and the uncertainty limits of the outcomes should be clearly specified.

4. Conclusions

47. This document provides a comprehensive review of techniques and applied methodologies for estimation of non- point (diffuse) sources releases to water (i.e., catchment runoffs) focusing on releases of TN, TP, sediments, TOC, and veterinary antibiotics and pharmaceuticals.

48. During the process of desktop research and compilation of information (provided in Annex III), it became apparent that:

- a) The estimations should be considered at catchment level than the watershed level, where possible;

⁵⁹⁸ Appendix II. Supplementary data. <https://www.sciencedirect.com/science/article/pii/S2589914720300049#appsec1>

- b) unlike the air emissions inventory area, there are no extensive guidance documents on inventories on discharges to water provided by national governments and international agencies for countries to use.
- c) The estimation techniques about releases to water and land from the above non-point (diffuse) sources is often not available.
- d) Appropriate information on discharges to water from non-point (diffuse) sources is essential part of the catchment modelling process. However, it is a complex area of scientific research which requires a greater depth of expert knowledge.

Annex I

Non-point/diffuse Sources Pollution Inventories Brief Overview

1. The need for reliable estimation and prediction of non-point (diffuse) pollutant exports on a catchment scale has been discussed in several Inventories and Guidance documents [1][8] [52-55].
2. The first proposal of a European Inventory of Emissions to Inland Waters focused on four main issues:
 - i) the substances to report;
 - ii) the sources generating emissions/releases;
 - iii) the spatial; and
 - iv) time scales for reporting [52].
3. For the purposes of the EEA, only the topographic surface catchments were considered. The European Commission's Joint Research Centre (JRC) developed the River and Catchment Database as the first comprehensive database of river networks and catchment boundaries for the entire European continent. This Database enabled linking between river and area drained, and together with the hierarchical structure from small catchments to large river basins, allowed the study of relevant processes at a variety of scales and independent of national and/or administrative boundaries [53]. These data are available to the European Environment Agency, DG Eurostat, DG Environment and others for use within the European institutional framework and for supporting the Water Information System for Europe [53].
4. The Australian Inventory [54] is a comprehensive compilation of techniques which can be used to estimate catchment exports. It also provides information on categorisation of catchment models including the assumptions, inputs required, complexity, ease of use, availability and application to Australian catchments, model acceptance criteria and the uncertainty associated with model outputs. It also describes and discusses methods for pollutant load estimation based on direct observation and provides an inventory of nutrient generation rates and modelling groups in Australia. The authors concluded that physics-based models and the more complex conceptual models are not appropriate for estimating catchment exports across most Australian catchments. However, that empirical and conceptual approaches can be combined to provide models that enable i) event responsiveness and sensitivity to climate variability; ii) allow investigation of catchment source strengths and iii) general physical interpretability of modelling result [54]. Additionally, it was also concluded that there is no single optimal sediment and nutrient (direct) load estimation technique. The selection of an appropriate load estimation technique depends not only on the availability of concentration and discharge data, but also on the hydrological characteristics of the catchment being analyzed, the expected accuracy of estimates and the preferred complexity of the load estimation technique. All techniques considered were found to have disadvantages in certain situations [54].
5. The UNITAR Guidance [55] suggested linking of pollution factors with source parameters that are known or easily obtained. For example, in the case of agriculture, the parameters could include the size and composition of cultivated area, the quantity of pesticide or fertilizer use and the locations where these chemicals are applied. In this manner, one could perform a reasonable estimate of aggregate emissions arising from non-point (diffuse) sources of certain pollutants starting from simple, known parameters that are readily measured or obtained for each source type.
6. The OECD Resource Compendiums of PRTR release estimation techniques provide updated description of aims and uses of emissions inventories [1][11]. The documents underlined that
7. The preparation of non-point inventories on discharges to water represents an essential part of the catchment modelling process. They also acknowledged that it is also a complex area of scientific research which requires a greater depth of expert knowledge. Moreover, both Compendiums (2003 and more recent, 2020) highlighted that unlike the air emissions inventory area, there are no extensive guidance documents on inventories on discharges to water provided by national governments and international agencies for countries to use [1][11].

Annex II

Overview of Approaches, Accuracy and uncertainty and Quality control and quality assurance Associated with Techniques and Applied Methodologies for Estimation of Pollution Releases from Catchments Runoff

Overview of available approaches

8. The OECD Resource Compendium highlights that there is a wide variety of models and techniques to estimate the pollutant loads from catchment areas. These techniques are generally incorporated into empirical, conceptual and/or physics-based catchment models [1][11]. The US EPA National Management Measures to Control Nonpoint Source Pollution from Agriculture provides a detailed guide of load estimation techniques through monitoring and modelling of pollutant load [56] and on management measures to prevent and solve non-point source problems in watersheds [57]. It highlights the importance of site and catchment hydrology, and analysis of on-site treatment needs in understanding nonpoint source problems and the impacts of management measures on pollutant sources and delivery patterns [57]. The Chapter on Loading techniques [56] describes different loading models designed to predict pollutant movement from the land surface to waterbodies which are categorized as watershed loading models, field-scale models, and receiving-water models. Of these, field-scale models are most frequently used in agricultural systems [56]. Chapter 5 [57] provides a very good summary of models that have been evaluated for a relatively wide range of conditions and have been shown to be appropriate for the farm or field including GLEAMS [58], EPIC [59], DRAINMOD [60], REMM (Riparian Ecosystem Management Model) [61] and others.

9. The Australian National Pollutant Inventory [54] provides a thorough overview of techniques for pollutant loads estimates and the response of a catchment to rainfall events, the implementation of different modelling approaches including calibration acceptance criteria, and the factors affecting the predictive capacity of models.

10. In Europe, the European Pollutant Release and Transfer Register (E-PRTR) promulgated by the Regulation No 166/2006⁵⁹⁹ stipulates that E-PRTR database must include releases of pollutants from diffuse sources where available [62]. When such data are not available, the European Commission is required to take actions to initiate reporting on these sources. In the last 15 years a number of international activities were initiated by the Commission and the European Environmental Agency (EEA) to stimulate and facilitate reporting on diffuse sources. One of these projects was “Diffuse water emissions in E-PRTR Project” completed in 2013 is of particular relevance as the researchers 1) gathered available data on diffuse releases to surface water with data sets available up to 2009; 2) proposed alternative estimation methods where emission data are not available on the European scale; 3) developed a methodology to derive disaggregated spatial data to obtain geographical information system layers; 4) derived gridded emission map layers covering all EU27 Member States and the EFTA countries (Switzerland, Liechtenstein, Norway and Iceland) for the selected sectors and pollutants with the highest resolution possible [62].

11. However, despite these efforts, currently there are no extensive guidance documents on inventories on discharges to water provided by national governments and international agencies for countries to use [1][11].

Accuracy and uncertainty

12. The OECD Compendium summarizes factors that influence the quality of inventories. These include accuracy (the measure of ‘truth’ of a measure or estimate); comparability (between different

⁵⁹⁹ <https://eur-lex.europa.eu/eli/reg/2006/166/2009-08-07>

methods or datasets); completeness (the proportion of all emissions sources that are covered by the inventory); and representativeness (in relation to the study region and sources of emissions) [1][11]. For non-point (diffuse) source emissions sources the feasibility and level of accuracy are determined by the types and quality of available information [1]. The UNITAR Guidelines highlights that the availability of information needed varies greatly between countries and for different regions within a country. Therefore, the evaluation of availability and accuracy of information is a key when considering types of non-point (diffuse) to be included in the national PRTR system [55]. The USEPA highlighted that prediction uncertainty is caused by natural process variability, and bias and error in sampling, measurement, and modeling [56].

13. According to the OECD Compendium [1][11], errors or uncertainty in the preparation of the inventories may include: 1) Emission factors (which do not reflect real life conditions); 2) Activity data that do not adequately reflect the study region (scaling down national or state activity data to smaller regions always results in decreased accuracy); 3) Spatial and temporal disaggregation may introduce errors that are difficult to quantify; 4) Sample surveys may be subject to sampling errors.

Quality control and quality assurance

14. The IPCC Guidelines for National Greenhouse Gas Inventories provides a comprehensive description of the quality assurance/quality control (QA/QC) and verification which are also relevant to inventories of non-point (diffuse) sources to water [63]. Well-developed and established QA/QC contributes to the transparency, consistency, comparability, completeness, and accuracy of inventories (Box A.1):

Box A.1.: Definitions of QA/QC and Verification

Quality Control (QC) is a system of routine technical activities and procedures to assess and maintain the quality of the inventory. The QC system is compiled by the inventory team and is designed to: (i) Provide routine and consistent checks to ensure data integrity, correctness, and completeness; (ii) Identify and address errors and omissions; and (iii) Document and archive inventory material and record all activities. QC activities comprise general methods such as accuracy checks on data acquisition and calculations, and the use of approved standardised procedures. QC activities also include technical reviews of categories, activity data, emission factors, other estimation parameters, and methods.

Quality Assurance (QA) is a system of review procedures conducted by independent third parties. The purpose of reviews is to verify that measurable objectives (data quality objectives) are met, and to ensure that the inventory represents the best possible estimates of emissions and removals given the current state of scientific knowledge and data availability, and support the effectiveness of the QC programme.

Verification refers to the collection of activities and procedures conducted during the planning and development stage, or after the completion of an inventory that can help to establish its reliability for the intended applications of the inventory.

15. The OECD Compendium [1][11] also provide summary of QA/QC. They highlight the importance of proper documentation, which ensures reproducibility, transparency and assists future inventory updates. Documentation should include all raw data used, assumptions, steps in calculations, and communications with data providers and QA/QC processes. Moreover, the important missing data (e.g., missing pollutants, missing source types) also need to be acknowledged and documented [1][11].

References

- [1] OECD (2020). Resource Compendium of PRTR release estimation techniques, Part II: Summary of Diffuse Source Techniques, Series on Pollutant Release and Transfer Registers No. 19. ENV/JM/MONO (2020)30. Published 25th November 2020.
- [2] USGS (2021). Runoff: Surface and Overland Water Runoff. url: https://www.usgs.gov/special-topic/water-science-school/science/runoff-surface-and-overland-water-runoff?qt-science_center_objects=0#qt-science_center_objects, accessed February 3rd, 2021.
- [3] Voulvoulis, N., Arpon, K.D. and Giakoumis, T. (2017). The EU Water Framework Directive: From great expectations to problems with implementation. *Science of The Total Environment* 575 (1): 358-366.
- [4] Boezeman, D., Wiering, M. and Crabbé, A. (2020). Agricultural Diffuse Pollution and the EU Water Framework Directive: Problems and Progress in Governance. Editorial to the MDPI Special Issue “Water Quality and Agricultural Diffuse Pollution in Light of the EU Water Framework Directive”. *Water* 2020, 12 2590: doi:10.3390/w12092590
- [5] Wiering, M., Crabbé, A. and Boezeman, D. (2020) (Eds). url: MDPI Special Issue “Water Quality and Agricultural Diffuse Pollution in Light of the EU Water Framework Directive”. url: https://www.mdpi.com/journal/water/special_issues/Water_Framework_Directive_Pollution
- [6] Wiering, M., Boezeman, D. and Crabbé, A. (2020). The Water Framework Directive and Agricultural Diffuse Pollution: Fighting a Running Battle? *Water* 2020, 12, 1447. <https://doi.org/10.3390/w12051447>
- [7] Novotny, V. (1999). Diffuse Pollution from Agriculture – A Worldwide Outlook. *Water Science and Technology* 39(3): 1-13.
- [8] Withers, P.J.A., H.P. Jarvie, R.A. Hodgkinson, E.J. Palmer-Felgate, A. Bates, M. Neal, R. Howells, C.M. Withers, and H.D. Wickham (2009). Characterization of phosphorus sources in rural watersheds. *Journal of Environmental Quality* 38:1998–2011.
- [9] Sharpley, A.N., Bergstrom, L., Aronsson, H., Bechmann, M., Bolster, C.H., Borling, K., Djodjic, F., Jarvie, H.P., Schoumans, O.F., Stamm, C., Tonderski, K.S., Ulen, B., Uusitalo, R. and Withers, P. (2015). Future agriculture with minimized phosphorus losses to waters: Research needs and direction. *Ambio* 44 Suppl 2:163-79. doi: 10.1007/s13280-014-0612-x
- [10] OECD (2017). OECD (2017). Diffuse Pollution, Degraded Waters. Emerging Policy Solutions. Policy Brief. <https://www.oecd.org/environment/resources/Diffuse-Pollution-Degraded-Waters-Policy-Highlights.pdf>
- [11] OECD (2003). Resource Compendium of PRTR Release Estimation Techniques. Part 2: Summary of Diffuse Source Techniques. OECD Environment, Health and Safety Publications Series on Pollutant Release and Transfer Registers No. 6. ENV/JM/MONO(2003)14. Published 11th September 2003. url: [http://www.oecd.org/officialdocuments/publicdisplaydocumentpdf/?cote=env/jm/mono\(2003\)14&doclanguage=en](http://www.oecd.org/officialdocuments/publicdisplaydocumentpdf/?cote=env/jm/mono(2003)14&doclanguage=en)
- [12] Merheb, M., Moussa, R., Abdallah, C., Colin, F., Perrin, C. and Baghdadi, N. (2016). Hydrological response characteristics of Mediterranean catchments at different time scales: a meta-analysis. *Hydrological Sciences Journal* 61 (14): 2520-2539. <http://dx.doi.org/10.1080/02626667.2016.1140174>
- [13] García-Pintado J, Martínez-Mena M, Barberá GG, Albaladejo J, Castillo VM. (2007). Anthropogenic nutrient sources and loads from a Mediterranean catchment into a coastal lagoon: Mar Menor, Spain. *Science of Total Environment* 373(1):220-39. doi: 10.1016/j.scitotenv.2006.10.046.
- [14] Malagó, A., Bouraoui, F., Grizzetti, B. and De Roo, A. (2019). Modelling nutrient fluxes into the Mediterranean Sea. *Journal of Hydrology: Regional Studies* 22:100592: 1-18. <https://doi.org/10.1016/j.ejrh.2019.01.004>.

- [15] Caille, F., Riera, J. L. and Rosell-Mele, A. (2012). Modelling nitrogen and phosphorus loads in a Mediterranean river catchment (La Tordera, NE Spain). *Hydrological Earth Systems Science* 16: 2417–2435, doi:10.5194/hess-16-2417-2012.
- [16] Arhonditsis G, Giourga C, Loumou A, Koulouri M. (2002). Quantitative assessment of agricultural runoff and soil erosion using mathematical modeling: applications in the Mediterranean region. *Environmental Management* 30 (3):434-53. doi: 10.1007/s00267-001-2692-1. PMID: 12148076.
- [17] Estrany, J., Garcia, C. and Batalla, R. J. (2009). Suspended sediment transport in a small Mediterranean agricultural catchment. *Earth Surface Processes and Land Forms* 34 (7): 929-940. url: <https://doi.org/10.1002/esp.1777>
- [18] Lizaga, I., Gaspar, L., Latorre, B. and Navas, A. (2020). Variations in transport of suspended sediment and associated elements induced by rainfall and agricultural cycle in a Mediterranean agroforestry catchment. *Journal of Environmental Management* 272, 111020. url: <https://doi.org/10.1016/j.jenvman.2020.111020>.
- [19] Tuset, J., Vericat, D. and Batalla, R. J. (2016). Rainfall, runoff and sediment transport in a Mediterranean mountainous catchment. *Science of The Total Environment* 540: 114-132. <https://doi.org/10.1016/j.scitotenv.2015.07.075>
- [20] Roig-Planasdemunt, M., Llorens, P. and Latron, J. (2017). Seasonal and storm flow dynamics of dissolved organic carbon in a Mediterranean mountain catchment (Vallcebre, eastern Pyrenees). *Hydrological Sciences Journal* 62(1): 50-63. <https://doi.org/10.1080/02626667.2016.1170942>
- [21] Boix Fayos, C., de Vente, J., Nadeu, E., Almagro, M., Pérez-Cutillas, P., Navas, A., Gaspar, L., Martínez-Mena, M. (2017). Losses and redistribution of organic carbon by erosion in fragile agricultural and restored catchments. *Global Symposium on Soil Organic Carbon*. Held in Rome, Italy 21-23 March, 2017. url: <http://www.fao.org/3/a-br999e.pdf>
- [22] Alvarez-Cobelas, M., Angeler, D., Sánchez-Carrillo, S., & Almendros, G. (2012). A worldwide view of organic carbon export from catchments. *Biogeochemistry*, 107(1/3): 275-293. Retrieved February 7, 2021, from <http://www.jstor.org/stable/41410562>.
- [23] Glendell M. and Brazier, R.E. (2014). Accelerated export of sediment and carbon from a landscape under intensive agriculture. *Science of Total Environment* 476-477: 643-656. url: <https://doi.org/10.1016/j.scitotenv.2014.01.057>
- [24] Gros M, Mas-Pla J, Boy-Roura M, Geli I, Domingo F, Petrović M. (2019). Veterinary pharmaceuticals and antibiotics in manure and slurry and their fate in amended agricultural soils: Findings from an experimental field site (Baix Empordà, NE Catalonia). *Science of Total Environment* 654:1337-1349. <https://doi.org/10.1016/j.scitotenv.2018.11.061>
- [25] Jechalke S, Heuer H, Siemens J, Amelung W, Smalla K. (2014). Fate and effects of veterinary antibiotics in soil. *Trends in Microbiology* 22(9):536-45. doi: 10.1016/j.tim.2014.05.005.
- [26] Heuer H, Schmitt H, Smalla K. (2011). Antibiotic resistance gene spread due to manure application on agricultural fields. *Current Opinions in Microbiology* 14(3):236-43. doi: 10.1016/j.mib.2011.04.009.
- [27] Kaczala, F. and Blum, S. E. (2016). The Occurrence of Veterinary Pharmaceuticals in the Environment: A Review. *Current Analytical Chemistry* 12:169-182. <https://doi.org/10.2174/1573411012666151009193108>
- [28] Karcı A. and Balcioglu I.A. (2009). Investigation of the tetracycline, sulfonamide, and fluoroquinolone antimicrobial compounds in animal manure and agricultural soils in Turkey. *Science of Total Environment* 407:4652–4664. <https://doi.org/10.1016/j.scitotenv.2009.04.047>
- [29] Wöhler, L., Niebaum, G., Krol, M. and Hoekstra, A.Y. (2020). The grey water footprint of human and veterinary pharmaceuticals. *Water Research X* (7-1):100044. <https://doi.org/10.1016/j.wroa.2020.100044>
- [30] European Environmental Agency, EEA (1995). Stanners, D. and Bourdeau, P. (Eds). *Europe's Environment: The Dobris Assessment*. European Environment Agency, Copenhagen, Denmark. url: <http://www.aughty.org/pdf/dobris.pdf>

- [31] Drizo, A. (2019). Phosphorus Pollution Control: Policies and Strategies pp. 176. Wiley-Blackwell, October 2019. ISBN: 978-1-118-82548-8. |url: <https://www.wiley.com/en-us/Phosphorus+Pollution+Control%3A+Policies+and+Strategies-p-9781118825426>
- [32] Correll, D.L. (1998). The Role of Phosphorus in the Eutrophication of Receiving Waters: A Review. *Journal of Environmental Quality* 27:261-266.
- [33] Smith, V.H. and Schindler, D.W. (2009). Eutrophication science: where do we go from here? *Trends in Ecology & Evolution* 24, pp. 201–207.
- [34] Ansari, A.A., Sarvajeet, S.G., Lanza, G.R. and Rast, W. (Eds.) (2011). Eutrophication: causes, consequences and control. eBook. Springer Publishing. ISBN 978-90-481-9625-8. url: <http://www.springer.com/gp/book/9789048196241>.
- [35] Hautier, Y., Niklaus, P.A. and Hector, A. (2009). Competition for Light Causes Plant Biodiversity Loss After Eutrophication. *Science* 324(5927): 636-638. DOI: 10.1126/science.1169640.
- [36] Briand, J.F., Jacquet, S., Bernard, C. and Humbert, J.F. (2003). Review article Health hazards for terrestrial vertebrates from toxic cyanobacteria in surface water ecosystems. *Veterinary Research* 34, pp. 361–377.
- [37] Banack, S.A., T.A. Caller, and E.W. Stommel (2010). The cyanobacteria derived toxin Beta-N-Methylamino-L-Alanine and Amyotrophic Lateral Sclerosis. *Toxins* 2:2837-2850.
- [38] Brand LE, Pablo J, Compton A, Hammerschlag N, Mash DC. (2010). Cyanobacterial Blooms and the Occurrence of the neurotoxin beta-N-methylamino-L-alanine (BMAA) in South Florida Aquatic Food Webs. *Harmful Algae* 9 (6):620-635.
- [39] Dodds, W.K., Bouska, W.W., Eitzmann, J.L., Pilger, T.J., Pitts, K.L., Riley, A.J., Schloesser, J.T and Thornbrugh, D.J. (2009). Eutrophication of US freshwaters: analysis of potential economic damages. *Environmental Science & Technology* 43:12-19.
- [40] Pretty, J., Mason, C., Nedwell, D.B., Hine, R.E., Leaf, S. and Dils, R. (2003). Policy Analysis Environmental Costs of Freshwater Eutrophication in England and Wales. *Environmental Science & Technology* 37(2), pp. 201–208.
- [41] Pearl, H. and Huisman, J. (2008). Blooms Like it Hot. *Science* 320 (5872):57-8. DOI:10.1126/science.1155398
- [42] Paerl, H.W. and Paul, V.J. (2012). Climate change: Links to global expansion of harmful Cyanobacteria. *Water Research* 46(2012):1349-1363.
- [42] Jacobson, P.C., Hansen, G. J. A., Bethke, B.J. and Cross, T.K. (2017). Disentangling the effects of a century of eutrophication and climate warming on freshwater lake fish assemblages. *PLoS ONE* 12 (8): e0182667. <https://doi.org/10.1371/journal.pone.0182667>.
- [43] Collins, A. L., Naden, P.S., Sear, D.A., Jones, J.I., Foster, I.D.L. and Morrow, K. (2011). Sediment targets for informing river catchment management: international experience and prospects. *Hydrological Processes* 25 (13): 2112-2129. <https://doi.org/10.1002/hyp.7965>
- [44] US National Research Council (1993). Soil and Water Quality: An Agenda for Agriculture (1993). Chapter: 9 Fate and Transport of Sediments. url: <https://www.nap.edu/read/2132/chapter/13>
- [45] Woodward, J. and Foster, I. (1997). Erosion and Suspended Sediment Transfer in River Catchments: Environmental controls, processes and problems. *Geography* 82 (4): 353-376. <https://www.jstor.org/stable/40572952>.
- [46] FAO (1996). Control of water pollution from agriculture - FAO irrigation and drainage paper 55. Chapter 2: Pollution by sediments url: http://www.fao.org/tempref/agl/AGLW/ESPIM/CD-ROM/documents/6A_e.pdf
- [47] Morris, D. P., Zagarese, H., Williamson, C. E., Balseiro, E. G., Hargreaves, B. R., Modenutti, B., Moeller, R. and Queimalinos, C. (1995). The attenuation of solar UV radiation in lakes and the role of dissolved organic carbon. *Limnology and Oceanography* 40(8):1381–1391.

- [48] Sarmah A.K., Meyer M.T. and Boxall A.B. (2006). A global perspective on the use, sales, exposure pathways, occurrence, fate and effects of veterinary antibiotics (VAs) in the environment. *Chemosphere*. 65(5):725-59. doi: 10.1016/j.chemosphere.
- [49] Neher, T.P., Ma L., Moorman T.B., Howe A.C., and Soupier ML (2020) Catchment-scale export of antibiotic resistance genes and bacteria from an agricultural watershed in central Iowa. *PLoS ONE* 15(1): e0227136. <https://doi.org/10.1371/journal.pone.0227136>.
- [50] O'Neill J. (2016). Tackling Drug-Resistant Infections Globally: Final Report and Recommendations. The Review on Antimicrobial Resistance. Retrieved from https://amr-review.org/sites/default/files/160518_Final%20paper_with%20cover.pdf
- [51] UN Interagency Coordination Group (IACG) on Antimicrobial Resistance (2019). No Time to Wait: Securing the future from drug-resistant infections. Report to the Secretary-General of the United Nations. url: <https://www.who.int/antimicrobial-resistance/interagency-coordination-group/final-report/en/>
- [52] European Environmental Agency (1998). A European Inventory of Emissions to Inland Waters. A first Proposal. Technical Report No.8. url: <https://www.eea.europa.eu/publications/TEC08>
- [53] European Commission (2007). Vogt, J., Soille, P., de Jager, A., Rimaviciute, E. Mehl, W., Foisneau, S., Bódis, K., Dusart, J., Paracchini, M.L., Haastrup, P. and Bamps, C. A pan-European River and Catchment Database. JRC Technical Report. url: <https://op.europa.eu/en/publication-detail/-/publication/d275b321-335f-4ce2-b339-c0009de89af3/language-en>
- [54] New South Wales EPA (1999). Review of Techniques to Estimate Catchment Exports (New South Wales EPA, Sydney, NSW, Australia). <http://www.npi.gov.au/system/files/resources/ac997f84-17a2-f724-6def-bd3a47b9e4b4/files/nswreport.pdf>.
- [55] UNITAR (1998). UNITAR Series of PRTR Technical Support Materials - No. 3. Guidance on Estimating Non-point Source Emissions. url: https://cwm.unitar.org/cwmplatformscms/site/assets/files/1264/prtr_tech_support_3_nov2003.pdf
- [56] US EPA (2003). National Management Measures to Control Nonpoint Source Pollution from Agriculture. Chapter 7: Load Estimation Techniques. url: <https://www.epa.gov/nps/national-management-measures-control-nonpoint-source-pollution-agriculture>.
- [57] US EPA (2003). National Management Measures to Control Nonpoint Source Pollution from Agriculture. Chapter 5: Using Management Measures to Prevent and Solve Nonpoint Source Problems in Watersheds. url: https://www.epa.gov/sites/production/files/2015-10/documents/chap5_0.pdf
- [58] Leonard, R.A., Knisel, W.G. and Davis, F.M. (1995). Modelling pesticide fate with GLEAMS. *European Journal of Agronomy* 4 (4): 485-490. [https://doi.org/10.1016/S1161-0301\(14\)80100-7](https://doi.org/10.1016/S1161-0301(14)80100-7).
- [59] Williams, J.R. (1990). The Erosion-Productivity Impact Calculator (EPIC) Model: A Case History *Philosophical Transactions: Biological Sciences* 329 (1255). Quantitative Theory is Soil Productivity and Environmental Pollution (Sep. 29, 1990), pp. 421-428. <https://www.jstor.org/stable/76847>
- [60] Skaggs, R. W., Youssef, M. A. and Chescheir, G. M. (2012). DRAINMOD: model use, calibration, and validation. *American Society of Agricultural and Biological Engineers* 55(4): 1509-1522.
- [61] Lowrance, R., Altier, L. S., Williams, R. G., Inamdar, S. P., Sheridan, J. M., Bosch, D. D., Hubbard, R. K. and Thomas, D. L. (2000). REMM: The Riparian Ecosystem Management Model. *Journal of Soil and Water Conservation* January 55 (1): 27-34.
- [62] Roovaart, J. van den, N. van Duijnhoven, M. Knecht, J. Theloke, P. Coenen, H. ten Broeke (2013). Diffuse water emissions in E-PRTR, Project report. Report 1205118-000-ZWS-0016, Deltares.
- [63] IPCC (2019). 2019 Refinement to the 2006 IPCC Guidelines for National Greenhouse Gas Inventories. Calvo Buendia, E., Tanabe, K., Kranjc, A., Baasansuren, J., Fukuda, M., Ngarize, S., Osako, A., Pyrozhenko, Y., Shermanau, P. and Federici, S. (eds). Volume 1 General Guidance and

- Reporting. Chapter 6: Quality Assurance/Quality Control and Verification. Published: IPCC, Switzerland. url: <https://www.ipcc-nggip.iges.or.jp/public/2019rf/vol1.html>
- [64] Li, H., Zhang, Y. and Zhou, X. (2015). Predicting Surface Runoff from Catchment to Large Region. *Advances in Meteorology*, vol. 2015. Article ID 720967, 13 pages, 2015. <https://doi.org/10.1155/2015/720967>
- [65] Zhang, Y., Collins, A.L., Murdoch, N., Lee, D. and Naden, P.S. (2014). Cross sector contributions to river pollution in England and Wales: Updating waterbody scale information to support policy delivery for the Water Framework Directive. *Environmental Science and Policy* 42: 16-32.
- [66] Kirchner, J.W. (2009). Catchments as simple dynamical systems: Catchment characterization, rainfall-runoff modeling, and doing hydrology backward. *Water Resources Research* 49. url: <https://agupubs.onlinelibrary.wiley.com/doi/epdf/10.1029/2008WR006912>
- [67] Kronvang, B., Behrendt S.A., Arheimer, B. et al. (2009). Ensemble modelling of nutrient loads and nutrient load partitioning in 17 European catchments. *Journal of Environmental Monitoring* 11: 572–583. DOI: 10.1039/b900101h
- [68] Crabtree, B., Kelly, S., Green, H., Squibbs, H. and Mitchell, G. (2009). Water Framework Directive catchment planning: a case study apportioning loads and assessing environmental benefits of programme of measures. *Water Science and Technology* 59(3):407-16. DOI: 10.2166/wst.2009.875.
- [69] Malve, O., Tattari, S., Riihimäki, J., Jaakkola, E., Vob, A., Williams, R. and Bärlund, I. (2012). Estimation of diffuse pollution loads in Europe for continental scale modelling of loads and in-stream river water quality. *Hydrological Processes* 26: 2385–2394. DOI: 10.1002/hyp.9344
- [70] Richards, R.P. (1998). Estimation of Pollutant Loads in Rivers and Streams: A Guidance Document for Nonpoint Source Pollution (NPS) Programs. url: <http://abca.iwebsmart.net/downloads/Richards-1998.pdf>
- [71] Williams, R., Keller, V., Voss, A., Barlund, I., Malve, O., Riihimaki, J., Tattari, S. and Alcamo, J. (2012). Assessment of current water pollution loads in Europe: estimation of gridded loads for use in global water quality models. *Hydrological Processes*, 26 (16). 2395-2410. 10.1002/hyp.9427
- [72] Cochran, W.G. (1963). *Sampling Techniques* (2nd edition). Wiley Publications in Statistics. John Wiley and Sons, New York, 413 p.
- [73] Collins, A.L. and Zhang, Y. (2015). Application of a cross sector pollutant source apportionment modelling framework to protected sites. Improvement Programme for England's Natura 2000 Sites (IPENS)– Planning for the Future IPENS008a. url: www.gov.uk/government/publications/improvement-programme-forenglands-natura-2000-sites-ipens.
- [74] FAO (1996). Wischmeier and Smith's Empirical Soil Loss Model (USLE). In: *Land husbandry - Components and strategy*. url: <http://www.fao.org/3/t1765e/t1765e0e.htm>
- [75] Andren, O. and Katterer, T. (1997). ICBM: The introductory carbon balance model for exploration of soil carbon balances. *Ecological Applications*, 7(4): 1226-1236.
- [76] Nadeu, E. (2013). Soil erosion and organic carbon mobilization at the catchment scale: factors, processes and impact on the carbon balance [online]. Faculty of Biology. University of Murcia, <http://hdl.handle.net/10803/120510>
- [77] Van Oost, K., Govers, T. A. Quine, G. Heckrath, J. E. Olesen, S. De Gryze, and R. Merckx (2005), Landscape-scale modeling of carbon cycling under the impact of soil redistribution: The role of tillage erosion. *Global Biogeochemistry Cycles* 19, GB4014. doi:10.1029/2005GB002471.
- [78] Boxall, A.B., Fogg, L.A., Blackwell, P.A., et al. (2004). Veterinary medicines in the environment. *Reviews of Environmental Contamination and Toxicology* 180, 1e91.

Appendix 33

Common methodologies and techniques for the assessment and monitoring of adverse impacts of dumping activities

Objective of the document

1. The objective of this document is to bring together a set of common methodologies and techniques that can be used by the Contracting Parties relating to both **monitoring of dredging operations** from harbours, ports, navigation channels and infrastructure projects such as outfalls, cables and pipelines, as well as **monitoring of the disposal sites** of dredged material at sea. Note that this document is not one that will describe a procedure or process for carrying out monitoring but documents the methodologies and techniques for monitoring of dredging and disposal of dredged material at sea in accordance with Dumping Protocol and relevant best practices.

2. This document also provides for compatible and comparable reporting of data by the Contracting Parties with regard to their monitoring activities pertinent to the Dumping Protocol; thus, further expediting their reporting obligations to the Barcelona Convention in accordance with its Article 12. Additionally, this document elaborates on two main issues of increasing significance and importance: underwater noise and marine litter.

Scope of the document

3. The scope of this document covers all aspects relating to monitoring operations involving both the dredging of material from harbours, ports, navigation channels and infrastructure projects such as outfalls, cables and pipelines, as well as the disposal of dredged material at sea.

Methodology for preparation of this document

4. The information presented in this document is derived primarily from consideration of guidance documents prepared by UNEP/MAP-MEDPOL, namely the updated Guidelines on Management of Dredged Materials⁶⁰⁰ and the Guidelines for the Dumping of Inert Uncontaminated Geological Materials⁶⁰¹; as well as the London Convention/London Protocol (LC/LP); the OSPAR Convention; HELCOM and other related national guidance documents from Canada; the United States; and the United Kingdom (see section 2 below).

1. Introduction

1.1 Monitoring in General

5. A very good explanation of marine monitoring in general is found in a book published by the National Research Council of the United States in 1990. This is still considered one of the best descriptions of marine monitoring and its role in environmental management; even though it was published 30 years ago. It can be freely downloaded from the link to the document in the references list. The book states that there are generally three types of marine-related monitoring:

- i. Surveillance monitoring – to identify and quantify longer-term environmental changes (trends) as possible consequences of human activities e. g., IMAP.
- ii. Compliance monitoring – to ensure that activities are carried out in accordance with regulations and permit requirements;
- iii. Model verification – to check the validity of assumptions and predictions used as a basis for sampling design or permitting i.e., the “**impact hypothesis**”; and

⁶⁰⁰ UNEP(DEPI)/MED IG.23/15

⁶⁰¹ UNEP(DEC)/MED WG.270/11

6. Compliance and model verification monitoring are implicitly tied to specific management actions, whereas surveillance monitoring is for purposes of studying trends (spatial and temporal) in marine environmental quality. Each type of monitoring has different objectives although they often, but not always, use the same techniques/methodologies.

7. Monitoring of dredging and dredged material disposal (or other disposal activities in the marine environment) involves both compliance monitoring and model verification monitoring, whereas IMAP is an example of surveillance monitoring. Thus, the OSPAR Convention's monitoring programme (CEMP) does not cover the monitoring of disposal sites for dredged material, although it does cover the trends in dumping activities and inputs from them and the two different monitoring programmes will often use the same techniques/methodologies. The same also applies to HELCOM.

8. The Updated Guidelines on the Management of Dredged Materials provide the rationale for monitoring in paragraph 142 where it says:

“Monitoring of dredged material dumping operations is generally undertaken for the following reasons:

- (a) to establish whether the dumping permit conditions have been respected - compliance monitoring - and consequently have, as intended, prevented adverse effects on the receiving area as a consequence of dumping;
- (b) to improve the basis on which permit applications are assessed by improving knowledge of the field effects of major discharges which cannot be directly estimated by a laboratory evaluation or from the literature;
- c) to provide the necessary evidence to demonstrate that within the framework of the Protocol the monitoring measures applied are sufficient to ensure that the dispersive and assimilative capacities of the marine environment are not exceeded, and so dumping operations do not cause damage to the environment and deteriorate GES.”

9. This document covers the monitoring of both dredging and disposal operations and such activities can potentially take place at a number of different stages in those operations, namely prior to, during and after both dredging and disposal operations. However, monitoring will not necessarily be needed at all stages or even at all and will be determined by the assessment of potential effects of the proposed dredging and disposal operations as well as any previous monitoring at the sites concerned. The methodologies and techniques used for monitoring those different stages will be the same for any particular environmental component or feature.

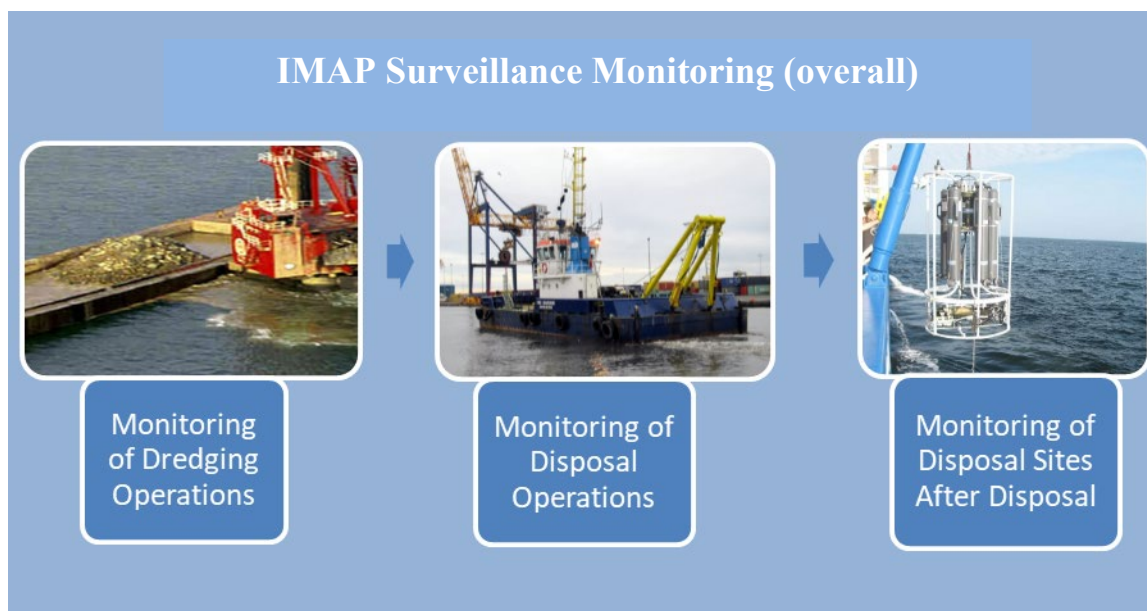

Figure 1: Interrelationship with different kind of monitoring under Dumping Protocol and related best practice. (Pictures from NOAA, EPA and Marine Scotland Assessment)

10. Note that baseline surveys⁶⁰² need to be carried out prior to any dredging or disposal activities take place in order to define the existing environmental conditions so that subsequent monitoring is able to establish any changes resulting from the dredging or disposal activities.

1.2 *The UNEP/MAP Dredged Material Guidelines and the UNEP/MAP Integrated Monitoring and Assessment Programme (IMAP) of the Mediterranean Sea and Coast*

11. Paragraph 144 of the UNEP/MAP Dredged Material Guidelines states:

“Whenever possible, the monitoring programme should be aligned with the current MEDPOL monitoring programmes for the Ecological Objectives 5, 8, 9, and 10, in line with the Integrated Monitoring and Assessment Programme (IMAP) of the Mediterranean Sea and Coast and Related Assessment Criteria set out in Decision IG.22/7 of COP 19.”

12. For monitoring of dredging:

- Ecological Objective 5 on Eutrophication and associated Common Indicators 13 and 14 would appear unlikely to be relevant in most cases.
- Ecological Objectives 8 on Coastal Ecosystems and Landscapes and associated Common Indicators 16 and 25 would also appear unlikely to be relevant in most cases since any potential issue should have been resolved in the permit approval process.
- Ecological Objective 7 on Hydrography and associated Common Indicator 15 would also appear unlikely to be relevant in most cases since any potential issues should have been resolved in the permit approval process.
- Ecological Objective 9 on Contaminants and the associated Common Indicators 17, 18 and 20 would be relevant.

⁶⁰² Note that baseline surveys, while a necessary precursor, are not considered monitoring according to some definitions of monitoring e.g., “as any activity that is routinely (regularly) performed, assesses either a pressure or an impact on the marine ecosystem, is based on sound experimental design and is sustained over a number of years” – Karydis and Kitsou (2013).

- Ecological Objective 11 on Underwater Noise and associated Common Indicators 26 and 27 would be relevant.

13. For monitoring dredged material disposal sites:

- Ecological Objective 5 on Eutrophication and associated Common Indicators 13 and 14 would only appear to be relevant in those circumstances where eutrophication is an issue in, and in the vicinity of, the location of disposal sites.
- Ecological Objective 8 on Coastal Ecosystems and Landscapes and associated Common Indicators 16 and 25 would appear unlikely to be relevant provided disposal sites are selected appropriately.
- Ecological Objectives 9 on Contaminants and the associated Common Indicators 17, 18 and 20 will always be relevant.
- Ecological Objective 10 on Marine Litter and associated Common Indicator 23 will be relevant.
- Ecological Objective 11 on marine noise and associated Common Indicators 26 and 27 were not mentioned in paragraph 144 of the UNEP/MAP Dredged Material Guidelines but is unlikely to be relevant for monitoring of disposal sites – see document UNEP/MED WG 487/4, section 4.1.4.

14. Standard UNEP/MAP Monitoring Guidelines/Protocols for sediment properties and sediment and water chemistry and the assessment of benthos etc., are in place for the IMAP and will be used, where applicable, in the monitoring of dredging and dredged material disposal sites. However, there are number of sediment and water features not covered by these IMAP Monitoring Guidelines/Protocols but are covered in this document – see below in section 5.

15. So, in conclusion, it will usually be necessary to consider Ecological Objectives 9 on Contaminants, EO 10 on Underwater Noise and EO 11 on Marine Litter and occasionally EO 5 on Eutrophication when undertaking monitoring of dredging and dredged material disposal operations.

16. However, since IMAP is a broad scale surveillance programme, its sampling stations are likely to be generally well spaced out so that it would be unlikely to find one in the vicinity of a disposal site requiring monitoring. Indeed, it would generally be the case that broad scale surveillance monitoring programmes avoid placing their sampling stations close to disposal sites to avoid biasing the results of their broad scale monitoring. Thus, the results of IMAP monitoring can only be used to give a general picture of regional environmental characteristics and could not be relied upon for baseline data for dredging and disposal activities that require more local and closely spaced sampling stations.

2. General

2.1 Guidance from Conventions for Monitoring of Disposal Sites

17. The London Convention/London Protocol (LC/LP), the OSPAR Convention, HELCOM and UNEP/MAP do not have a specific detailed guidance documents covering the common methodologies and techniques for assessing adverse effects of dredged material disposal sites at sea. They do each have some limited guidance within their dredged material guidelines.

18. The LC/LP has published detailed guidance for the sampling and analysis of dredged material intended for disposal at sea (IMO, 2005). OSPAR and HELCOM have a number of guidance documents on particular aspects of monitoring, not all of which will necessarily be relevant for the monitoring of dredged material disposal sites see Annex 1.

2.2 National Guidance

19. A number of countries around the world have prepared specific guidance documents for all or some aspects of the monitoring of dredged material disposal sites including Australia (Australian Government, 2009, 2012), Canada (Environment Canada, 1998a, 1998b), United Kingdom (MEMG (2003, Scottish Office, 1996) and USA (USEPA/USACE, 2004). In the answers to the questionnaire⁶⁰³, only one country, Cyprus, referred to a national guidance document but it is likely that other Mediterranean countries do have such documents.

3. Deriving the Impact Hypothesis

20. Paragraphs 148-160 of the UNEP/MAP Dredged Material Guidelines provide general guidance on establishing and using an Impact Hypothesis for monitoring. The LC/LP Specific Guidelines for Assessment of Dredged Material (IMO, 2014) and the OSPAR Guidelines for the Management of Dredged Material at Sea (OSPAR, 2014)) have some additional information on the Impact Hypothesis that is useful to refer to. This OSPAR Guidelines cover additional detailed guidance on how to derive an Impact Hypothesis and specific testable hypotheses that field monitoring can confirm or deny.

21. During the preparation of an impact hypothesis, Contracting Parties to the Barcelona Convention should bear in mind that there are usually two types of disposal sites, i.e., retentive (accumulative) and dispersive⁶⁰⁴ and these will require a different impact hypothesis.

22. In the case of a retentive site, where the material deposited will remain within the vicinity of the site, the assessment should delineate the area that will be substantially altered by the presence of the deposited material and should examine the severity of these alterations. The assessment should specify the likelihood and scale of residual impacts outside the primary zone where the bulk of the deposited material remains.

23. In the case of a dispersive site, the assessment should include a definition of the area likely to be altered in the shorter term by the proposed deposit operation (i.e., the near-field) and the severity of associated changes in that immediate receiving environment. It should also specify the likely extent of long-term transport of material from this area and what this flux represents in relation to existing transport fluxes in the area; thereby permitting a statement regarding the likely scale and severity of effects in the long-term and far-field.

24. The Impact Hypothesis is derived from the predicted effects on the physical, chemical and biological characteristics of the areas in and around both the dredging site and the disposal site (paragraphs 148-149 of the UNEP/MAP Dredged Material Guidelines). While numerous potential effects can be envisaged, see Figures 2.1 and 2.2 of MEMG (2003), it is only those of potential significance (however defined) that require monitoring. It is then necessary to derive testable hypotheses for each of those potentially significant effects and to determine what measurements are required to test them. The primary consideration for impact hypotheses should be tailored to specific information such as site characteristics, site-specific species, local spatial and temporal scales of variable parameters and the permit terms and conditions. The measurements required for monitoring can be divided into (i) those within the zone of predicted impact and (ii) those outside, and should determine:

- a) if the actual zone differs from that projected; and
- b) if the extent of change projected outside the zone of impact is within the scale predicted.

⁶⁰³ As of 25 January 2021.

⁶⁰⁴ However, there will be some disposal sites in between the two types e.g., weakly dispersive.

Impact hypotheses can be of three different types:

Type	Examples of Different Types of Hypotheses
Operational	Does the extent of dispersion from the disposal site exceed that predicted?
	Can the disposal site receive the required amount?
Environmental	Do suspended solids levels exceed critical levels for fish?
	Do the changes degrade the overall health/quality of the environment?
Effects on users/uses	Does the depth of accumulation of material at the disposal site cause concern for navigation?

25. Examples of specific impact hypotheses from Environment Canada (1998a) and MEMG (2003) are presented below:

Examples of Impact Hypotheses for Dredging

- Resuspension of fine material will be ephemeral, hence no observed impacts on adjacent sensitive sites i.e., no deposition of fine-grained material will be observed at adjacent sensitive sites.
- Restriction of dredging to outside of the salmon migration season will avoid impact with the salmon run i.e., dredging will not affect the numbers of salmon migrating up the river.

Examples of Impact Hypotheses for Disposal

26. Disposal of dredged material will not result in:

- a) transport of contaminated material from the disposal site,
 - b) subsequent increases in contaminant concentration in the sediments of the area reached by the transported material, and
 - c) consequent contaminant uptake by biota and ensuing effects on the biota.
- The deposited dredged material will not reach any protected habitat, through resuspension, erosion and sediment transport, in amounts sufficient to be of concern in relation to habitat destruction (taking into account the compatibility of the transported material with the sediments of the receiving environment). Resuspension, erosion and sediment transport of the deposited material will not affect any fishery.
 - Disposal of dredged material will not result in contaminant uptake by harvested species and ensuing potential effects on human health.
 - The deposited dredged material will not reach any sensitive areas, through resuspension, erosion and sediment transport, in amounts sufficient to be harmful to valued components of the sensitive area (taking into account the compatibility of the transported material with the sediments of the receiving environment).
 - Containment of the majority of the deposited material within the disposal site would result in a measurable but acceptable decrease in water depths which would pose no hazard to shipping.
 - The small size of the dredging operation limits seabed degradation to transient local effects.
 - There will be no detectable deposition of mud film on amenity beaches.

4. Common Methodologies and Techniques for Assessing Adverse Effects of Dredging

27. The necessity for field monitoring of dredging operations will depend on the outcome of the assessment of potential environmental effects of dredging and any impact hypotheses that might result from that assessment. Many dredging operations take place without any monitoring being required. Laboyrie *et al.* (2018) provide an excellent description of monitoring related of dredging operations. The main marine environmental concerns that may require monitoring are most commonly:

- a) Turbidity due to sediment put into suspension in the water column;
- b) Contaminants associated with the sediment put into suspension in the water column that may affect water quality and impact biota. This could include marine litter, particularly macro- and micro-plastics;
- c) Dissolved oxygen that may be depressed by reaction with organic material in the suspended sediment and might impact on biota; and

d) Underwater noise.

4.1 Turbidity

28. Turbidity is a well-known issue for dredging and is very case specific in relation to the dredging technique and the local circumstances, as indicated in Compendium of Best Practices document (UNEP/MED WG 487/4). Techniques for testing of turbidity may include:

- Use of water displacement samplers at several depths, to give depth profile, then filtering water through filters to give weight of suspended solids;
- Optical instruments can measure turbidity by monitoring optical backscatter (OBS) or transmission. OBS instruments are more sensitive to fine sediments (14-170 µm) in suspension than acoustic instruments. They need calibration to give values of suspended sediment concentration. Continuous monitoring equipment for this is available and can be deployed from vessels or installed on buoys or fixed structures to ensure appropriate coverage around the dredging operation.
- Acoustic monitoring of turbidity may be achieved using instruments based upon acoustic backscatter. An increased concentration of suspended sediments leads to an increase in the backscattered acoustic energy. Acoustic instruments are more sensitive to coarse (75-250 µm) sediments in suspension. They also need calibration to give values of suspended sediment concentration. As for optical instruments, continuous monitoring equipment for this is available and can be deployed from vessels or installed on buoys or fixed structures to ensure appropriate coverage around the dredging operation.

29. As explained in the “Compendium of Best Practices” document (UNEP/MED WG 487/4), there do not appear to be any explicit BEPs for monitoring turbidity from dredging, but there are a number of publications that could be collectively considered to represent BEP. These are mainly published by the US Army Corps of Engineers that has produced many reports on monitoring and assessment of turbidity due to dredging operations including Borrowman (2006), Clarke and Wilber (2000), Francingues and Palermo (2005), Germano and Cary (2005), Johnson and Parchure (2000), Reine *et al.* (2002), Thackston and Palermo (2000), Tubman and Corson (2000), Wilber *et al.* (2005). Central Dredging Association (CEDA) has also produced a number of useful papers on turbidity related to dredging (CEDA, 2011a, 2020). Laboyrie *et al.* (2018) also provides useful guidance on the monitoring of turbidity due to dredging in section 8.3.3.

4.1.2 Contaminants

30. Where the level of chemical contaminants in sediments to be dredged raises concerns for potential adverse effects on water quality and biota, monitoring of those contaminants around the area being dredged may be required during dredging. The best practices for such monitoring are well established in relevant UNEP/MAP Monitoring Guidelines/Protocols. The dredging of contaminated sediments needs particular care and the publications by Bridges *et al.* (2008) and Palermo *et al.* (2008) provide the best information on this subject. In those circumstances, risk assessment of the dredging operations is critical and the publications by Moore *et al.* (1998), PIANC (2006b) and PIANC (2019) provide useful guidance.

31. Contamination arising from marine litter, including macro- and micro-plastics, could require monitoring if pre-dredge surveys indicate that dredging may put significant amounts of such material into suspension. UNEP/MAP has a monitoring protocol for floating micro-plastics (UNEP/MED

WG.482/19) that would be appropriate for this purpose among other techniques – see section 5.4.4 below.

4.1.3 Dissolved oxygen

32. Where there are concerns about potential depression of dissolved oxygen levels due to dredging operations, monitoring may be necessary. Continuous monitoring equipment for this is available and can be deployed from vessels or installed on buoys or fixed structures to ensure appropriate coverage around the dredging operation. It can also be measured on discrete water samples using the technique in the ‘Monitoring Guidelines/Protocols for Determination of Hydrographic Chemical Parameters’, document UNEP/MED WG.482/7.

4.1.4 Underwater Noise

33. This is a relatively recent issue of concern which has gained more prominence recently. While there does not appear to be any existing BEP or guidance document for measuring underwater noise from dredging operations, there is a good practice guide for measuring underwater noise in general (Robinson *et al.*, 2014). Underwater noise is detected using hydrophones and these can be mounted on vessels, fixed structures or buoys as appropriate for each individual dredging operation (Robinson *et al.*, 2014).

34. In this regard, it is noted that PIANC EnviCom Working Group 226 is working on ‘A Guide for Assessing and Managing Effects of Underwater Sounds from Navigation Infrastructure Activities’ that should be useful to guide monitoring when it becomes available (<https://www.pianc.org/uploads/files/EnviCom/ToR-new/ToR-EnviCom-WG-226-A-Guide-for-Assessing-and-Managing-Effects-of-Underwater-Sounds-from-Navigation-Infrastructure-Activities.pdf>).

35. Moreover, the Convention on Biological Diversity (CBD) has a draft Technical Series report on ‘Anthropogenic underwater noise: impacts on marine and coastal biodiversity and habitats, and mitigation and management measures’ in preparation (<https://www.cbd.int/doc/notifications/2020/cbd-ts-underwater-noise-peer-review-en.pdf>). It is expected that this publication should provide some useful information in this domain.

36. In addition, there are a number of guidance documents on measuring underwater noise from dredging. The US Army Corps of Engineers has produced a number of publications on underwater noise generated by each of the main types of dredging equipment (Dickerson *et al.* 2001; McQueen *et al.*, 2019; Reine *et al.* 2012a, 2012b; 2014; Suedal *et al.*, 2019). CEDA and the World Organization of Dredging Associations (WODA) have produced general guidance about underwater noise from dredging (CEDA, 2011b; Thomsen *et al.*, 2013). Note that the underwater noise produced by dredging varies considerably between the different dredging techniques in both intensity and duration.

37. Finally, it should be mentioned that UNEP/MAP has developed two Common Indicators CI-25 and CI-27 under Ecological Objective 11 for underwater noise (UNEP/MED WG.467/5). However, neither of the factsheets for these two CIs mention underwater noise caused by dredging operations. Nevertheless, Common Indicators CI-25 and CI-27 will be useful for assessing underwater noise from dredging.

5. Common Methodologies and Techniques for Assessing Adverse Effects on Disposal Sites

5.1 Introduction

38. Monitoring in relation to the Barcelona Convention Dumping Protocol is focused on the potential impacts on the marine environment in and around the dredged material disposal site. Impacts on the seabed and associated biota are usually the most important impacts due to the bulk nature of the material. However, water column impacts may be relevant in some cases. Best practices for such monitoring are referred to in section 5 of the Compendium of Best Practices for Implementation of Dumping Protocol (UNEP/MED WG 487/4).

39. The necessity for field monitoring of dredging operations will depend on the outcome of the assessment of potential effects of disposal and any impact hypotheses that might result from that assessment. The potential effects of dredged material disposal can be regarded as a set of bottom-up causes and primary effects, in which the physical system (both in the water column and on the bed) is altered and which in turn affect the health of the biological system. The eventual effects on the biological system and its anthropogenic uses can be regarded as a set of top-down responses, e.g., the effects on the higher levels of the ecological system (such as fishes, seabirds and marine mammals) as well as on fisheries and conservation objectives. Our knowledge of these effects and the linkages between the different responses can be regarded as a conceptual model which, by the nature of the system and the potential changes to dredging and marine disposal, is naturally very complex – see Figure 2.1 and Figure 2.2 in MEMG (2003).

40. The disposal of dredged material will have the potential to affect the water column, the bed conditions and their biota. Reductions in water clarity through an increased turbidity may in turn affect the primary production by the phytoplankton. The release of any materials contained within the dredged material, either as the water-soluble fraction or the release of particulate materials may result in a changed chemical environment, i.e., anoxic fine sediments liberated into the oxygenated water column may cause the release of pollutants previously sequestered due to the anoxic chemical conditions. Similarly, any organic matter in the sediment will create a water column oxygen demand. The deposited sediment will change the nature of the bed sediment if it is of a different particle size and it can have a smothering effect on the bed community as well as bringing new organisms to an area. Both of these features will affect the structure of the bed community and in turn the demersal and benthic fishes feeding on that bed community.

41. Where it is considered that effects will be largely physical, one component of monitoring may be based upon remote methods such as side-scan sonar to identify changes in the character of the seabed and bathymetric techniques such as multibeam bathymetry to identify areas of dredged material accumulation. Both techniques may require some sediment sampling to establish "ground truth".

42. Where either physical or chemical effects at the seabed are expected, it will usually be necessary to assess the benthic community structure in areas around the disposal site where the dredged material may be transported. In the case of chemical effects, it may also be necessary to examine the chemical quality of the sediment and biota including fish and other seafood species.

43. In order to assess the impact, it will be necessary to compare the physical, chemical and biological quality of the affected areas with reference sites located away from dispersal pathways. Such areas can be identified during the early stages of the impact assessment.

44. The spatial extent of sampling will need to take into account the size of the area designated for dumping, the mobility of deposited material and water movements which will determine the direction

and extent of sediment transport. Where dredging for pipelines, outfalls or cables are concerned, such operations will usually deposit dredged material in a narrow band parallel to the length of the structure. When trenches are excavated for pipelines, outfalls and cables, it is usual to use a significant part of the temporarily deposited material to refill the trench after the installation of the pipeline or outfall in order to protect them e.g., from fishing gear or anchors. Dredging for the installation of cables does not always involve excavating a trench as it is common to leave the cables on the seabed surface where they are not at risk of damage. In such cases, the dredging is done to provide a relatively flat surface for the cable by dredging to remove sand waves, mega-ripples and other unevenness of the seabed along the route of the cable.

45. The frequency of surveys will depend on a number of factors. Where a disposal operation has been going on for several years, it may be possible to establish the effect at a steady state of input and repeated surveys would only be necessary occasionally to check that effects are within those predicted or if changes are made to the operation such as the quantities or type of material, the method of deposit etc.

46. The range of common components and features that may be necessary⁶⁰⁵ to be monitored at and in the vicinity of a dredged material disposal site can be organised into the categories as shown in Table 1 below (MEMG, 2003). As explained in the Compendium of Best Practices for implementation of the Dumping Protocol (UNEP/MED WG 487/4), it is recommended that the tiered approach to monitoring is adopted as best practice to address the impact hypotheses in a cost-effective and consistent fashion. An example of tiered monitoring is described in Figure 2 below from Environment Canada (1998a):

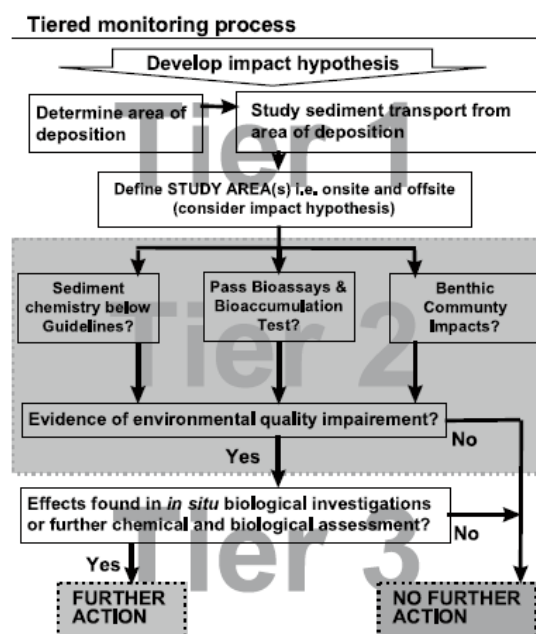

Figure 2 – Tiered Monitoring Process (Environment Canada, 1998a)

⁶⁰⁵ Note that what needs to be measured in each case will depend on the impact hypothesis.

47. The tiered monitoring process is described by Environment Canada (1998a) as: “Physical monitoring (Tier 1) which defines the site boundaries. This is followed by concurrent chemical and biological assessments (Tier 2). The results of both Tiers 1 and 2 are used in making decisions on the need for further monitoring (Tier 3) and broadly address most impact hypotheses. At some sites, site-specific concerns will require different parameters or a different emphasis in monitoring resources allocation between tiers. However, it is expected that both Tier 1 and Tier 2, as well as the core parameters⁶⁰⁶ will be used at most sites, while Tier 3⁶⁰⁷ will generally not be required.”

Box 1 Low-Cost, Low Technology Field Monitoring

The London Convention/London Protocol has developed guidance for low cost, low technology field monitoring for the assessment of the effects of disposal in marine waters of dredged material or inert, inorganic, geological material (IMO, 2016) that may be useful for some Parties. The objective of the guidance document is to provide practical information about using low technology and low-cost tools that are useful for monitoring of possible environmental impacts associated with marine disposal of either dredged material or inert, inorganic geological materials. The primary audiences for this guidance are countries that are in the early stages of developing waste assessment and monitoring actions in concert with permit programs for disposal of wastes and other matter into marine waters which are consistent with the Dumping Protocol of Barcelona Convention. These guidelines could be considered BEP for such countries and are recommended for the interested Parties which may wish to follow.

The guidance covers these issues:

1. Development of Monitoring Plans
2. Key Elements of Monitoring: Impact Hypotheses and Sampling Design
3. Evaluation, Interpretation, and Management Actions
4. Case studies of Sampling Design using Null Hypotheses with Management Actions
5. Field Sampling Techniques for Physical Characteristics
6. Field Sampling and Analysis for Chemical Contamination and/or Toxicity
7. Field Sampling Techniques and Evaluation Techniques for Biological Health of Sediments at the Dumpsite

⁶⁰⁶ Includes physical surveys, bathymetry, grain size, sediment chemistry, laboratory biological tests and benthic community surveys.

⁶⁰⁷ Includes further chemical and biological assessment, onsite biological measurement and long-term stability assessment

Table 1 - The main environmental components and features relevant to monitoring dredged material disposal operations (MEMG, 2003)

Component	Feature
Hydrography:	Tidal excursion
	Wind-driven circulation
	Bed currents
	Short-term circulation
	Long-term circulation
	Sediment movement
Water Column:	Light penetration
	Turbidity/Suspended solids
	Contaminants in water/suspended solids
	Particulate organic carbon
Seabed – Physical:	Bathymetry
	Bed forms
	Sediment physical characteristics
	Marine litter including macro- and micro-plastics
Seabed – Chemistry:	Sediment chemistry – contaminants
	Sediment chemistry – organic carbon
	Sediment properties – pH, redox
Seabed – Biology:	Biotope
	Epibenthos
	Benthic infauna
Top Predators:	Fish
	Seabirds
	Mammals

48. The text below in sections 5.2 to 5.8 provide examples of the methodologies and techniques that can be used to monitor the main features relevant to disposal operations shown in Table 1. Where UNEP/MAP monitoring protocols exist, they are referenced under the relevant issue below. Further details about the methodologies and techniques can be found in the publications by Eleftheriou (2013), Environment Canada (1998a,1998b), IMO (2005), Laboyrie et al. (2018), MEMG (2003), Scottish Office (1996) and Ware and Kenny (2011). Specific references have only been provided for those novel or new techniques as most of the techniques described are well-known oceanographic techniques and/or are covered in the references above. As sediment sampling is relevant for several features under ‘Seabed – Physical’, ‘Seabed – Chemistry’ and ‘Seabed – Biology’ below, this will be dealt with under section 6 below.

5.2 Hydrography

49. In the context of this report, hydrography is the science that measures and describes the physical features of bodies of water and this includes collecting information on tides, currents and sediment movement. This information should already be available for existing dredged material disposal sites as it would have been collected during the site selection process. However, in the case of

selecting a new dredged material disposal site, the following aspects and techniques can be used to provide information on hydrography.

5.2.1 Tidal excursion

50. The tidal excursion be measured with subsurface drogues, followed by boat with radar and DGPS position fixing and should be monitored per tide with spring and neap coverage. Also, navigational charts usually provide information about tidal speed and direction at a number of points (i.e., 'Tidal Diamonds' on Admiralty charts).

5.2.2 Wind-driven circulation

51. Surface drogues followed by boat with DGPS position fixing under several wind conditions. Also, Ocean Current Surface Radar (OSCR) and Acoustic-Doppler Current Profile (ADCP) Imaging can be used.

5.2.3 Bed currents

52. Bottom landers with recording current meters. Also, seabed drifters - deployment of plastic drifters, each tagged and with reward for recovery.

5.2.4 Short-term circulation

53. Direct-reading current meters (DRCM) or recording current meter (RCM), deployed over tidal cycles and under differing spring-neap conditions. They can be deployed in conjunction with other water parameter measurement devices (e.g., depth, temperature, salinity/conductivity, oxygen, turbidity) to define water masses. In addition, ADCPs can be used.

5.2.5 Long-term circulation

54. Recording current meter (RCM) deployed over a lunar cycle.

5.2.6 Sediment movement

55. Bottom landers deploying a range of optical sensors and water sampling equipment. Also, a variety of sediment tracers are in use e.g., fluorescent tracers.

5.3 Water Column

5.3.1 Light penetration

56. The simplest device is the Secchi disk that measures water transparency. UNEP/MAP has a relevant monitoring guidelines/protocols in UNEP/MED WG.482/6: Monitoring Guidelines/Protocols for Determination of Hydrographic Physical Parameters. Also, one can deploy underwater light meters to measure photosynthetically active radiation (PAR) penetration with depth.

5.3.2 Turbidity/Suspended solids

57. Techniques for this are the same as given in section 4.1 above for dredging

5.3.3 Contaminants in water/suspended solids

58. Water samples are collected using standard oceanographic samplers and filters to give suspended load and dissolved phase for analysis of inorganic or organic contaminants. UNEP/MAP has two relevant monitoring guidelines/protocols:

- WG. 482/15: Monitoring Guidelines/Protocols for Sampling and Sample Preservation of Seawater for IMAP Common Indicator 17: Heavy and Trace Elements and Organic Contaminants.
- WG. 482/16: Monitoring Guidelines/Protocols for Sample Preparation and Analysis of Seawater for IMAP Common Indicator 17: Heavy and Trace Elements and Organic Contaminants.

5.3.4 Particulate organic carbon

59. Water samples are filtered to collect particulate matter. Techniques that can be used include either percentage Loss-on-Ignition, CHN analyser or use wet oxidation technique followed by spectrophotometry or titration.

5.3.5 Underwater noise

60. As indicated above in section 1.2 above and in section 4.1.4 of the Compendium of Best Practices (document UNEP/MED WG 487/4), Ecological Objective 11 on underwater noise and Common Indicators 26 and 27 (UNEP/MED WG.467/5) are unlikely to be relevant for monitoring of disposal sites as underwater noise from general shipping is much more likely to be a significant source of underwater noise than disposal activities.

5.4 Seabed – Determination of physical characteristics

5.4.1 Bathymetry (i.e., the measurement of the depth of water in an area of the sea in order to produce a map of the seabed topography)

61. Techniques for bathymetry can include:

- Echo sounder and multibeam bathymetry to provide accurate recording of depth variations across disposal sites.

5.4.2 Bed forms (i.e., the shape of the seabed including sand waves, mega ripples, rock outcrops etc.)

62. Techniques for this can include:

- Photography to give presence of different ripple types, rock surfaces, crevices, sediment pockets in hard substratum.
- Side-scan sonar for sweep of area giving 2-dimensional interpretation.
- Bed-profiling, e.g., Sub-bottom profilers and RoxAnn (http://www.sonavision.co.uk/products.asp?cat_id=1), giving bed features (substratum types, bed forms, major changes of bed).

5.4.3 Sediment physical characteristics (i.e., sediment particle size, density, water content, permeability etc)

63. Techniques for this can include:

- A subjective assessment following grab or core sampling - skilled visual assessment into mud, muddy-sand, mud, etc.
- Detailed particle size analysis of samples taken by grab or core; granulometric analysis using sieving for the coarse fraction and laser granulometry (e.g., Malvern, Frisch), Coulter Counter, or pipette analysis for the finer fraction if <5% by weight.

- Geotechnical analyses for e.g., bulk density, liquid/plastic limits, consolidation, permeability and shear strength (Fitzpatrick and Long, 2007).
- Sediment Profile Imaging – This allows rapid data acquisition during field sampling and a wide variety of physical and biological parameters can be measured from each image, including:
 - Grain-size major mode and range (gravel, sand, silt, clay).
 - Depth of the apparent Redox Potential Discontinuity (RPD).
 - Calculation of the Organism-Sediment Index, allowing rapid identification and mapping of disturbance gradients in surveyed areas.
 - Infaunal Successional Stage.
 - Evidence of excess organic loading and high sediment oxygen demand.
 - More details can be seen at:
 - <https://www.inspireenvironmental.com/2015/12/04/sediment-profile-imaging/#:~:text=Sediment%20Profile%20Imaging%20allows%20rapid%20data%20acquisition%20during,%28gravel%2C%20sand%2C%20silt%2C%20clay%29.%20Small-scale%20surface%20boundary%20roughness>

5.4.4 Marine Litter Including Macro- and Micro-Plastics

64. There are a range of papers/reports on techniques for sampling, analysis and measurement for marine litter. The best developed techniques are for monitoring macro litter on beaches, as such guidelines have been developed over a long period of time., e.g., the OSPAR Guidelines for Monitoring Marine Litter on the Beaches in the OSPAR Maritime Area (<https://www.ospar.org/documents?v=7260>). UNEP/MAP has Ecological Objective 10 related to marine litter and Common Indicator 23 ‘Trends in the amount of litter in the water column including microplastics and on the seafloor. Associated with that Common Indicator is a checklist for collecting data on seafloor marine litter (IMAP CI23).

65. Recently, Madricardo *et al.* (2020) have given an overview of the current state-of-the-art methods to address the issue of seafloor macro-litter pollution. The overview includes the following topics: the monitoring of macro-litter on the seafloor, the identification of possible litter accumulation hot spots on the seafloor through numerical models, and seafloor litter management approaches (from removal protocols to recycling processes). However, there do not appear to be any accepted best practice documents or widely accepted methodologies for monitoring marine litter on the seabed at present.

66. Regarding microplastics, the best guidance currently available is that proposed in GESAMP (2019) that has proposed guidelines including:

- Designing monitoring and assessment programmes
- Monitoring methods for shorelines
- Monitoring methods for the sea surface and water column
- Monitoring methods for seafloor
- Monitoring methods for marine biota
- Sampling processing for microplastics

- Methods for physical, chemical and biological characterisation of plastic litter

67. Note that OSPAR is in the process of developing an indicator for microplastics in sediment. There are many papers/reports about the techniques for sampling, analysis and measurement for marine microplastics in the literature but with the wide variety of techniques employed giving results that cannot be compared, it is inappropriate to refer to them here.

5.5 Seabed – Chemical Characteristics

5.5.1 Sediment chemistry – contaminants

68. Sampling by grab or core (non-contaminating material) then analysis by digestion and Atomic Absorption or Plasma-emission spectroscopy for metals; GCMS or HPLC for organic contaminants; petroleum hydrocarbons by extraction and gravimetry or GCMS. UNEP/MAP has two relevant monitoring guidelines/protocols:

- WG.482/11: Monitoring Guidelines/Protocols for Sampling and Sample Preservation of Sediment for IMAP Common Indicator 17: Heavy and Trace Elements and Organic Contaminant.
- WG.482/12: Monitoring Guidelines/Protocols for Sample Preparation and Analysis of Sediment for IMAP Common Indicator 17: Heavy and Trace Elements and Organic Contaminants.
- Sediment Profile Imaging can be used with Diffusive Gradient in Thin films (DGT) gels to give information on the profiles on contaminants in the top 20 cm of sediment (Birchenough et al. (2010). Also, there is the possibility of using passive sampler to assess the bioavailability of chemical contaminants in sediment e.g., Gilmore et al. (2020) and paper LC/SG 41/INF.7 ‘Laboratory, field, and analytical procedures for using passive sampling in the evaluation of contaminated sediments: user's manual’ available through IMO Web Accounts.

5.5.2 Sediment chemistry – organic content

69. Sampling by core or grab to give undisturbed surface sediment then assess Loss-on-ignition (using muffle-furnace), direct measurement of carbon and nitrogen by CHN analyser or wet oxidation technique for carbon. Also, micro-Kjeldahl technique for nitrogen.

5.5.3 Sediment properties – Redox (Eh)

70. Platinum electrode measurements at depth in sediment in a grab or on a core sample to give Eh profile and depth of redox profile discontinuity level.

5.6 Seabed – Biological Characteristics

5.6.1 Biotope

71. A biotope is an area of uniform environmental conditions providing a living place for a specific assemblage of plants and animals.⁶⁰⁸

72. Techniques for this can include:

⁶⁰⁸ Biotope is almost synonymous with the term habitat as defined in MSFD, Annex III, Table 1: “Broad habitat types of the water column (pelagic) and seabed (benthic), or other habitat types, including their associated biological communities throughout the marine region or subregion”

- Still and video photography using epibenthic sledge towed behind vessel or drop camera; calibrate area observed; record megabenthic organisms and any surface features (pockmarks, burrow entrances).
- Use of remote operated vehicle (ROV) from vessel to obtain precise nature of biological features; if necessary, ground-truth using core and grab sampling.
- Biotope mapping using combinations of multibeam bathymetry, sidescan sonar, sub-bottom profiling and RoxAnn with ground truthing by core and grab analysis.

5.6.2 Epibenthos

73. Techniques for this can include:

- Still and video photography (as for biotope).
- Use of remote operated vehicle (ROV) (as for biotope).
- Towed epibenthic sledge, naturalists dredge or scallop dredge from vessel, with onboard analysis.
- Seabed towed gear, e.g., Agassiz or beam trawl with onboard analysis of large and common forms but laboratory analysis for more precise identification.

5.6.3 Benthic infauna

74. UNEP/MAP has a relevant monitoring guidelines/protocol for this issue in UNEP/MED WG.461/21: Update of Monitoring Protocols on Benthic Habitats: Guidelines for monitoring marine benthic habitats in Mediterranean.

75. Techniques for this can include:

- Use of grab or core samplers to provide fully quantitative samples; sieving on board and laboratory sorting and identification to give abundance, biomass and species richness per sample.
- Sediment profile imaging (SPI) to give photographs, and possible image analysis) of sediment type in relation to presence of organisms – see above.

5.6.4 Contaminants in biota

76. UNEP MAP has several monitoring protocols for this issue:

- UNEP/MED WG.482/13 Monitoring Guidelines/Protocols for Sampling and Sample Preservation of Marine Biota for IMAP Common Indicator 17: Heavy and Trace Elements and Organic Contaminants.
- UNEP/MED WG.482/14 Monitoring Guidelines/Protocols for Sample Preparation and Analysis of Marine Biota for IMAP Common Indicator 17: Heavy and Trace Elements and Organic Contaminants.
- UNEP/MED WG.482/17 Monitoring Guidelines/Protocols for Sampling and Sample Preservation of Sea Food for IMAP Common Indicator 20: Heavy and Trace Elements and Organic Contaminants.

- UNEP/MED WG.482/18 Monitoring Guidelines/Protocols for Sample Preparation and Analysis of Sea Food for IMAP Common Indicator 20: Heavy and Trace Elements and Organic Contaminants.

5.7 Top Predators

77. UNEP/MED WG.458/4: 'Guidance on monitoring concerning the biodiversity and non-indigenous species' covers cetaceans. Monk seals, sea birds and turtles.

5.7.1 Fish

78. Pelagic trawling of water column at risk; otter, beam or Agassiz trawling for demersal and benthic fishes; on-board analysis to give species, abundances, biomass and sizes of dominant species.

5.7.2 Seabirds

79. Aerial and shore photography, visual recording.

5.7.3 Mammals

80. Photography, visual recording

5.7.4 Reptiles (Turtles)

81. Photography, visual recording.

5.8. Novel techniques for Monitoring

82. A number of novel techniques for marine monitoring have and are becoming available due to new technologies being developed. In particular, the use of autonomous vehicles (drones) either underwater, on the sea surface or in the air are bringing new possibilities for marine monitoring. Powered Autonomous Underwater Vehicles (AUVs) have been in use for some time now that can carry out e.g., surveys of sidescan sonar, multibeam bathymetry and sub-bottom profiling. In addition, the use of underwater gliders and autonomous surface vehicles is becoming more common. Canada submitted a useful review of novel drones for marine monitoring to the LC/LP Scientific Groups meeting in 2019 (LC/SG 42/INF.11 available from IMO Wen Accounts). Also, see chapters 11-16 on in NOC (2020) for details of a variety of such devices.

6. Sampling of Seabed Sediments

83. Sampling of seabed sediments is necessary to enable both the analysis of sediment physical and chemical features and for the assessment of benthos. There are various aspects involved with sampling seabed sediments, including:

- Designing a sampling plan.
- The selection of the physical, chemical and biological parameters to be measured - derived from the impact hypotheses.
- Designing an analytical plan with appropriate Quality Assurance/Quality Control to ensure that the analysis and data meet the requirements for the assessment required.
- Field sampling of sediments with various devices. This is usually carried out using either grabs or cores and these are well covered in Mackie *et al.* (2007) (Grabs only) and Eleftheriou (2013).
- Having appropriate sample containers and procedures for sample handling, transport and

storage.

84. UNEP/MAP's Monitoring Guidelines/Protocols in documents UNEP/MED WG.482/11 and UNEP/MED WG.482/13 cover sampling and sample preservation for sediments and marine biota respectively. In addition, there are several useful publications that cover all or some of the aspects above including those by Eleftheriou (2013), Environment Canada (1994), IMO (2005), MEMG (2003), Scottish Office (1996) and USEPA (2001). Where coarse-grained sediments are to be sampled (i.e., sands and gravels), the guidelines for benthic studies at marine aggregate extraction sites by Ware and Kenny (2011) are appropriate to use. In addition, a review of the tools used for marine monitoring in the UK by Bean et al. (2017) includes some useful information about monitoring equipment and technology, data collection, and monitoring programmes including those for contaminants, eutrophication, non-indigenous species, hydrography, biodiversity, marine litter and marine noise.

7. Examples of Monitoring

85. Examples of national monitoring programmes are given in section 5 of MEMG (2003), Bolam et al. (2018), Environment Canada (2007) and USEPA (2017) and an individual port monitoring programme in Dublin Port Company (2020).

Annex I

Additional Available Information for Monitoring

OSPAR has a number of guidance documents on particular aspects of monitoring, not all of which will necessarily be relevant for the monitoring of dredged material disposal sites are presented below:

- CEMP Guidelines for the assessment of dumping and placement of waste or other matter at sea <https://www.ospar.org/documents?d=37513>
- CEMP Guidelines on Litter on the Seafloor <https://www.ospar.org/documents?d=37515>
- CEMP Guidelines for Monitoring and Assessment of loud, low and mid-frequency impulsive sound sources in the OSPAR Maritime Region <https://www.ospar.org/documents?d=37516>
- CEMP Guidelines for Monitoring Contaminants in Sediments (Agreement 2002-16). Revision 2018 <http://www.ospar.org/documents?d=32743>
- JAMP Guidelines for General Biological Effects Monitoring. Revised technical annexes 2007 (Agreement 2007-07) <https://www.ospar.org/documents?d=32676>
- JAMP Guidelines for Contaminant-Specific Biological Effects (Agreement 2008-09) <https://www.ospar.org/documents?d=32799>
- CEMP Guidelines for Monitoring Contaminants in Biota (Agreement 1999-02). Revision 2018 <https://www.ospar.org/documents?d=32414>
- CEMP Guidelines for coordinated monitoring for hazardous substances (Agreement 2016-04). Revised in 2018/19 <https://www.ospar.org/convention/agreements?q=2016-04&t=&a=&s=>

HELCOM has a number of detailed guidance documents that cover e.g.:

- measuring various contaminants in sediment, measuring turbidity in the water column and the biological material sampling and sample handling for the analysis of persistent organic pollutants (<https://helcom.fi/action-areas/monitoring-and-assessment/monitoring-guidelines/>);
- guidelines for monitoring seabed habitats, litter and underwater noise (<https://helcom.fi/action-areas/monitoring-and-assessment/monitoring-manual/>).

References

- Australian Government (2009) National Assessment Guidelines for Dredging, Commonwealth of Australia, Canberra, 92 pp. <https://www.environment.gov.au/system/files/resources/8776675b-4d5b-4ce7-b81e-1959649203a6/files/guidelines09.pdf>
- Australian Government (2012) Checklist for completing long term monitoring and management plans for dredging, Department of Sustainability, Environment, Water, Population and Communities, 6 pp. <https://www.environment.gov.au/system/files/resources/c307da1c-237b-43a8-a178-583a60e388d1/files/ltmmp-checklist.pdf>
- Bean, T.P., *et al.* (2017) A review of the tools used for marine monitoring in the UK: combining historic and contemporary methods with modeling and socioeconomics to fulfill legislative needs and scientific ambitions, *Frontiers in Marine Science*. 4:263. <https://doi.org/10.3389/fmars.2017.00263>
- Birchenough, S.N.R., Parker, R.E., Ware, S., Kroeger, S., Mason, C. Bolam, T. (2010) Development of Sediment Profile Imagery (SPI) capability as a routine tool for monitoring marine environments. Project ME1401 Final report to Defra. 64 pp. http://randd.defra.gov.uk/Document.aspx?Document=me1401_9374_FRP.pdf
- Bolam, S.G., Mason, C., Curtis, M., Griffith, A., Clare, D., Pettafor, A., Hawes, J., Fernand, L., Beraud, C. (2018) Dredged Material Disposal Site Monitoring Round the Coast of England: Results of Sampling (2017-18), 109 pp. https://assets.publishing.service.gov.uk/government/uploads/system/uploads/attachment_data/file/736276/C6794_Dredge_Disposal_Monitoring_Annual_Report_V2.1.pdf
- Borrowman, T. D. (2006) Summary of measurement protocols for sediment resuspended from dredging operations, U.S. Army Engineer Research and Development Center, Vicksburg, MS, USA, DOER Technical Notes ERDC DOER-D8, 9 pp. <https://erdc-library.erdcren.dren.mil/jspui/bitstream/11681/8728/1/ERDC-TN-DOER-D8.pdf>
- Bridges, T.S., Ells, S., Hayes, D., Mount, D., Nadeau, S.C., Palermo, M.R., Patmont, C. and Schroeder, P. (2008) The Four Rs of Environmental Dredging: Resuspension, Release, Residual, and Risk, U.S. Army Engineer Research and Development Center, Vicksburg, MS, USA, Technical Report ERDC/EL TR-08-04, 63 pp. <https://erdc-library.erdcren.dren.mil/jspui/bitstream/11681/6855/1/EL-TR-08-4.pdf>
- CEDA (2011a) Environmental control on dredging projects: Lessons learned from 15 years of turbidity monitoring. A CEDA Information paper, 3 pp. https://dredging.org/media/ceda/org/documents/Resources/CEDAonline/2011-ceda_information_paper_environmental_control_ondredging_projects.pdf
- CEDA (2011b) Underwater Sound in Relation To Dredging, A CEDA Information paper, 6 pp. https://dredging.org/media/ceda/org/documents/Resources/CEDAonline/2011-11_ceda_positionpaper_underwatersound_v2.pdf
- CEDA (2020) Assessing and evaluating environmental turbidity limits for dredging, A CEDA Information paper, 21 pp. <https://dredging.org/media/ceda/org/documents/Resources/CEDAonline/2020-05-aetl.pdf>
- Clarke, D. G. and Wilber, D. H. (2000) Assessment of Potential Impacts of Dredging Operations Due to Sediment Resuspension, U.S. Army Engineer Research and Development Center,

- Vicksburg, MS, USA, DOER Technical Notes ERDC DOER-E9, 14 pp. <https://erdc-library.erdcdren.mil/jspui/bitstream/11681/8743/1/TN-DOER-E9.pdf>
- Dickerson, C., Reine, K.J., and Clarke, D. G. (2001) Characterization of Underwater Sounds Produced by Bucket Dredging Operations, U.S. Army Engineer Research and Development Center, Vicksburg, MS, USA, DOER Technical Notes ERDC DOER-E14, 17 pp. <https://erdc-library.erdcdren.mil/jspui/bitstream/11681/8747/1/TN-DOER-E14.pdf>
- Dublin Port Company (2020) Dumping at Sea Permit S0024-01 – Annual Environmental Report 2019, 119 pp. http://www.epa.ie/licences/lic_eDMS/090151b280764315.pdf
- Eleftheriou, A. (Editor) (2013) Methods for the Study of Marine Benthos, 4th Edition, Wiley Blackwell Publishing, 496 pp. ISBN: 978-0-470-67086-6 <https://www.wiley.com/en-gb/Methods+for+the+Study+of+Marine+Benthos%2C+4th+Edition-p-9780470670866>.
- Environment Canada (1994) Guidance document on collection and preparation of sediments for physicochemical characterization and biological testing, Report EPS 1/RM/29, 170 pp. http://publications.gc.ca/collections/collection_2014/ec/En49-24-1-29-eng.pdf
- Environment Canada (1998a) National guidelines for monitoring dredged and excavated material at ocean disposal sites - <http://www.publications.gc.ca/site/eng/471408/publication.html>
- Environment Canada (1998b) Technical guidance for physical monitoring at ocean disposal sites, 170 pp. http://publications.gc.ca/collections/collection_2014/ec/En14-186-1998-eng.pdf
- Environment Canada (2007) Compendium of Monitoring Activities at Disposal at Sea Sites in 2005-2006, 38 pp. http://publications.gc.ca/collections/collection_2014/ec/En81-19-2006-eng.pdf
- Fitzpatrick, F. and Long, D. (2007) Chapter 16, Geotechnical Measurements, In ‘Review of Standards and Protocols for Seabed Habitat Mapping’, Coggan *et al.* (Eds) (2007), MESH Action 2.1, INTERREG IIIB-NW European Program, 139-151. https://www.emodnet-seabedhabitats.eu/media/1663/mesh_standards_protocols_2nd-edition_26-2-07.pdf
- Francingues, N.R. and Palermo, M.R. (2005) Silt Curtains as a Dredging Project Management Practice , U.S. Army Engineer Research and Development Center, Vicksburg, MS, USA, DOER Technical Notes ERDC DOER-E21, 18 pp. <https://erdc-library.erdcdren.mil/jspui/bitstream/11681/8750/1/TN-DOER-E21.pdf>
- Germano, J. D., and Cary, D. (2005) Rates and Effects of Sedimentation in the Context of Dredging and Dredged Material Placement, DOER-E19, U.S. Army Engineer Research and Development Center, Vicksburg, MS., DOER Technical Notes ERDC DOER-E19, 12 pp. <https://erdc-library.erdcdren.mil/jspui/bitstream/11681/8704/1/ERDC-TN-DOER-E19.pdf>
- GESAMP (2019). Guidelines on the monitoring and assessment of plastic litter in the ocean (Kershaw P.J., Turra A. and Galgani F. editors), (IMO/FAO/UNESCO-IOC/UNIDO/WMO/IAEA/UN/UNEP/UNDP/ISA Joint Group of Experts on the Scientific Aspects of Marine Environmental Protection). Rep. Stud. GESAMP No. 99, 130pp. <http://www.gesamp.org/site/assets/files/2002/rs99e.pdf>
- Gillmore, M.L., et al. (2020) The diffusive gradients in thin films (DGT) technique predicts sediment nickel toxicity to the amphipod, *Melita plumulosa*. Environmental Toxicology and Chemistry <https://doi.org/10.1002/etc.4971>
- IMO (2005) Guidelines for the sampling and analysis of dredged material intended for disposal at sea’, International Maritime Organization, London, ISBN 92-801-4192-9, 72 pp.

- IMO (2014) Waste assessment guidelines under the London Convention and London Protocol, Available through IMO Publications, ISBN 978-92-801-16137.
- IMO (2016) Low cost, low technology field monitoring: assessment of the effects of disposal in marine waters of dredged material or inert, inorganic, geological material, IMO Publications, 110 pp. ISBN 978-92-801-16564.
- Johnson, B. H., and Parchure, T.M. (2000) Estimating Dredging Sediment Resuspension Sources, U.S. Army Engineer Research and Development Center, Vicksburg, MS, USA, DOER Technical Notes ERDC DOER-E6, 9 pp. <https://erdc-library.erdc.dren.mil/jspui/bitstream/11681/8739/1/TN-DOER-E6.pdf>
- Karydis, M. and Kitsou, D. (2013) Marine water quality monitoring: A review. *Marine Pollution Bulletin* 77, 23-36. <https://www.sciencedirect.com/science/article/abs/pii/S0025326X13005481>
- Laboyrie, H.P., Van Koningsveld, M., Aarinnkhoff, S.G.J., Van Parys, M., Jensen, A, Csiti, A, and Kolman, R. (2018) Dredging for Sustainable Infrastructure. CEDA/IADC, The Hague, The Netherlands. <https://www.sustainable-dredging-book.com/>
- Mackie, A.S.Y., Coggan, R. and van-Heteren, S. (2007) Chapter 17, Grab Sampling, In 'Review of Standards and Protocols for Seabed Habitat Mapping', Coggan *et al.* (Eds) (2007), MESH Action 2.1, INTERREG IIIB-NW European Program, 152-170. https://www.emodnet-seabedhabitats.eu/media/1663/mesh_standards_protocols_2nd-edition_26-2-07.pdf
- McQueen, A.D., Suedel, B.C. and Wilkens, J.L. (2019) Review of the Adverse Biological Effects of Dredging-Induced Underwater Sounds. *Journal of Dredging* 17(1), 1-22. <https://www.western-dredging.org/phocadownload/WEDA%20Journal%20Vol%2017%20No%201.pdf>
- MEMG (2003) Final Report of the Dredging and Dredged Material Disposal Task Team, Marine Environmental Management Group, The Group Coordinating Sea Disposal Monitoring, Cefas, Lowestoft, Aquatic Environmental Monitoring Report No. 55, 53 pp. <https://www.cefas.co.uk/publications/aquatic/aemr55.pdf>
- Moore, D. W., Bridges, T. S., Ruiz, C., Cura, J., Driscoll, S. K., Vorhees, D., Peddicord, D. (1998). Environmental Risk Assessment and Dredged Material Management: Issues and Application, Proceedings - Workshop 18-20 February 1998, San Diego Mission Valley Hilton, San Diego, California, U.S. Army Engineer Research and Development Center, Vicksburg, MS., ERDC Technical Report DOER-2, 53 pp. <https://erdc-library.erdc.dren.mil/jspui/bitstream/11681/4630/1/6649.pdf>
- National Research Council (1990) Managing Troubled Waters. The Role of Marine environmental Monitoring, National Academy Press, Washington D.C., 136 pp. <https://www.nap.edu/catalog/1439/managing-troubled-waters-the-role-of-marine-environmental-monitoring>
- NOC (2020) National Marine Facilities Technology Roadmap 2020/21, National Oceanography Centre, Southampton, UK, 55 pp. <https://www.noc.ac.uk/files/documents/about/ispo/COMMS1155%20NMF%20TECHNOLOGY%20ROADMAP%202021%20V4.pdf>
- OSPAR (2014) OSPAR Guidelines for the Management of Dredged Material at Sea. Agreement 2014-06, 39 pp. <https://www.ospar.org/documents?d=34060>

- Palermo, M.R., Schroeder, P.R., Estes, T.J. and Francingues, N.R. (2008) Technical Guidelines for Environmental Dredging of Contaminated Sediments, U.S. Army Engineer Research and Development Center, Vicksburg, MS, USA, Technical Report ERDC/EL TR-08-29, 302 pp. <https://erdc-library.erdcdren.mil/jspui/bitstream/11681/6894/1/ERDC-EL%20TR-08-29.pdf>
- PIANC (2006) Environmental Risk Assessment of Dredging and Disposal Operations, The World Association for Waterborne Transport Infrastructure, Report of WG 10, 48 pp. <https://www.pianc.org/publications/envicom/environmental-risk-assessment-of-dredging-and-disposal-operations>
- PIANC (2019) A Practical Guide to Environmental Risk Management (ERM) for Navigation Infrastructure Projects, EnviCom WG 175, pp. <https://www.pianc.org/publications/envicom/wg175>
- Reine, K. J., Clarke, D. G. and Dickerson, C. (2002) Acoustic Characterization of Suspended Sediment Plumes Resulting from Barge Overflow, U.S. Army Engineer Research and Development Center, Vicksburg, MS, USA, DOER Technical Notes ERDC DOER-E15, 15 pp. <https://erdc-library.erdcdren.mil/jspui/bitstream/11681/8746/1/TN-DOER-E15.pdf>
- Reine, K. J., Clarke, D. G. and Dickerson, C. (2012a) Characterization of underwater sounds produced by a hydraulic cutterhead dredge fracturing limestone rock, U.S. Army Engineer Research and Development Center, Vicksburg, MS, USA, DOER Technical Notes ERDC TN-DOER-E34, 19 pp. <https://erdc-library.erdcdren.mil/jspui/bitstream/11681/8684/1/ERDC-TN-DOER-E34.pdf>
- Reine, K. J., Clarke, D. G. and Dickerson, C. (2012b). Characterization of underwater sounds produced by backhoe dredge excavating rock and gravel. U.S. Army Engineer Research and Development Center, Vicksburg, MS, USA, DOER Technical Notes ERDC TN-DOER-E36, 29 pp. <https://erdc-library.erdcdren.mil/jspui/bitstream/11681/8748/1/ERDC-TN-DOER-E36.pdf>
- Reine, K.J., Clarke, D., Dickerson, C. and Wikel, G. (2014) Characterization of Underwater Sounds Produced by Trailing Suction Hopper Dredges During Sand Mining and Pump-out Operations, U.S. Army Engineer Research and Development Center, Vicksburg, MS, USA, Technical Report ERDC/EL TR-14-3, 109 pp. <https://erdc-library.erdcdren.mil/jspui/bitstream/11681/7123/1/ERDC-EL%20TR-14-3.pdf>
- Robinson, S.P., Lepper, P. A. and Hazelwood, R.A. (2014) Good Practice Guide for Underwater Noise Measurement, National Measurement Office, Marine Scotland, The Crown Estate, NPL Good Practice Guide No. 133, 97 pp. ISSN: 1368-6550. <https://www.npl.co.uk/special-pages/guides/gpg133underwater>
- Scottish Office (1996) Monitoring and Assessment of the Marine Benthos at UK Dredged Material Disposal Sites, Scottish Fisheries Information Pamphlet. No. 21, 35 pp. https://www.researchgate.net/publication/272418958_Monitoring_and_Assessment_of_the_Marine_Benthos_at_UK_Dredged_Material_Disposal_Sites
- Suedel, B.C., McQueen, A.D. and Wilkens, J.L. (2019) Evaluating Effects of Dredging-Induced Underwater Sound on Aquatic Species: A Literature Review, DOER Technical Report, ERDC EL TR-19-18, 138 pp. https://pdfs.semanticscholar.org/823d/4e9bd02af1d1b61f5dae44e70425478ef61d.pdf?_ga=2.26708285.1826089919.1607621069-1483881565.1607621069

- Thackston, E. L. and Palermo, M. R. (2000) Improved Methods for Correlating Turbidity and Suspended Solids for Monitoring, U.S. Army Engineer Research and Development Center, Vicksburg, MS, USA, DOER Technical Notes ERDC DOER-E8, 12 pp. <https://erdc-library.erdcdren.mil/jspui/bitstream/11681/8737/1/TN-DOER-E8.pdf>
- Thomsen, F., Borsani, F., De Wit, P., Clarke, D., De Jong, C., Goethals, F., Holtkampe, M., Van Raalte, G., Reine, K., San Martin, E., Spadaro, P.; and Jensen, A. (2013) Technical Guidance on: Underwater Sound in Relation to Dredging, World Organization of Dredging Associations, 8 pp. https://dredging.org/media/ceda/org/documents/Resources/CEDAonline/2013-06-woda-technicalguidance-underwatersound_lr.pdf
- Tubman, M. W., and Corson, W. D. (2000) Acoustic Monitoring of Dredging-Related Suspended-Sediment Plumes, U.S. Army Engineer Research and Development Center, Vicksburg, MS, USA, DOER Technical Notes ERDC DOER-E7, 13 pp. <https://erdc-library.erdcdren.mil/jspui/bitstream/11681/8736/1/TN-DOER-E7.pdf>
- USEPA (2001) Methods for Collection, Storage and Manipulation of Sediments for Chemical and Toxicological Analyses: Technical Manual. United States Environmental Protection Agency, Report EPA-842-B-92-008, 95 pp. <https://www.epa.gov/sites/production/files/2015-09/documents/collectionmanual.pdf>
- USEPA (2017) 2014 National Ocean Dumping Site Monitoring Assessment Report, 27 pp. https://www.epa.gov/sites/production/files/2017-04/documents/2014_national_ocean_dumping_site_monitoring_assessment_report.pdf
- USEPA/USACE (1991) Evaluation of Dredged Material Proposed for Ocean Disposal. Testing Manual. US Environmental Protection Agency/US Corps of Engineers. https://www.epa.gov/sites/production/files/2015-10/documents/green_book.pdf
<https://dots.el.erdcdren.mil/guidance/ocean-disposal-gbook.pdf>
- USEPA/USACE (2004) Regional Implementation Manual for the Evaluation of Dredged Material Proposed for Disposal in New England Waters - <https://www.nae.usace.army.mil/Portals/74/docs/regulatory/DredgedMaterialProgram/RegionalImplementationManual.pdf>
- Ware, S. and Kenny, A. (2011) Guidelines for the Conduct of Benthic Studies at Marine Aggregate Extraction Sites, 2nd Edition, Marine Aggregate Levy Sustainability Fund (MALSF), Project Code: MEPF 08/P75, 80 pp. <https://www.yumpu.com/en/document/view/15696156/guidelines-for-the-conduct-of-benthic-studies-at-marine-aggregate>
- Wilber, D. H., Brostoff, W., Clarke, D. G., and Ray, G. L. (2005) Sedimentation: Potential biological effects from dredging operations in estuarine and marine environments, U.S. Army Engineer Research and Development Center, Vicksburg, MS., DOER Technical Notes Collection ERDC TNDOER-E20, 14 pp. <https://erdc-library.erdcdren.mil/jspui/bitstream/11681/8751/1/TN-DOER-E20.pdf>